

Quarterly Business Meeting
February 19-21, 2020



**NORTH CAROLINA
MARINE FISHERIES
COMMISSION**

New Bern Riverfront Convention Center
New Bern, NC

TABLE OF CONTENTS

AGENDA	1
DRAFT 2019 NOV. MFC BUSINESS MEETING MINUTES.....	4
CHAIRMAN’S REPORT	16
LETTERS	17
<i>Blue Crab</i>	18
<i>Delineation of Fishing Waters</i>	29
<i>Flounder</i>	38
<i>MAFMC</i>	41
<i>NCWF</i>	45
<i>Rule Readoption</i>	49
<i>Shrimp</i>	61
<i>MFC AC</i>	63
<i>Miscellaneous</i>	81
ETHICS TRAINING AND STATEMENT OF ECONOMIC INTEREST REMINDER	85
2020 MFC MEETING SCHEDULE	89
COMMISSION COMMITTEE ASSIGNMENTS	90
COMMITTEE REPORTS.....	92
DRAFT MINUTES -HABITAT AND WATER QUALITY ADVISORY COMMITTEE MEETING.....	93
DRAFT MINUTES – JOINT MEETING OF THE MFC COMMERCIAL RESOURCES FUND COMMITTEE AND THE FUNDING COMMITTEE FOR THE N. C. COMMERCIAL FISHING RESOURCE FUND	97
FISHERY MANAGEMENT PLANS	103
FISHERY MANAGEMENT PLAN MEMORANDUM.....	104
BLUE CRAB.....	107
<i>Memorandum</i>	107
<i>Blue Crab FMP Amendment 3</i>	111
SOUTHERN FLOUNDER	365
<i>Memorandum</i>	365
<i>Southern Flounder Scoping Document</i>	367
<i>Southern Flounder FMP Amendment 2</i>	380

SHRIMP.....	422
<i>Memorandum</i>	422
<i>Shrimp Scoping Document</i>	444
<i>MFC 2018 & 2019 Shrimp Motions</i>	457
<i>Shrimp FMP Amendment 1 2018 Revision</i>	458
<i>Shrimp FMP Amendment 1 2015</i>	522
RULEMAKING	1042
RULEMAKING MEMORANDUM.....	1042
MFC 2019-2020 ANNUAL RULEMAKING CYCLE	1045
NORTH CAROLINA REGISTER MFC EXCERPT	1046
WRITTEN PUBLIC COMMENTS FROM 2019 PUBLIC COMMENT PERIOD....	1054
SUMMARY OF PUBLIC HEARING FOR PROPOSED RULES	1115
RECLASSIFICATION OF SSNA TO PERMANENT SNA ISSUE PAPER	1117
OYSTER SANCTUARY RULE CHANGE ISSUE PAPER	1143
DIRECTOR’S REPORT.....	1159
RECREATIONAL HOOK AND LINE MODIFICATIONS MEMORANDUM	1160
INFORMATION PAPER – REC. HOOK AND LINE MODIFICATIONS	1161
ATLANTIC STATES MARINE FISHERIES COMMISSION INFORMATION.....	1173
MID-ATLANTIC FISHERY MANAGEMENT COUNCIL INFORMATION.....	1192
SOUTH ATLANTIC FISHERY MANAGEMENT COUNCIL INFORMATION	1199
HIGHLY MIGRATORY SPECIES MEMORANDUM	1207
PROTECTED RESOURCES	1208
RULES SUSPENSION UPDATE	1229
LANDINGS UPDATE	1231
<i>Red Drum</i>	1231
<i>Southern Flounder</i>	1232
SHELLFISH AQUACULTURE UPDATE.....	1234
USER CONFLICT STUDY (2019).....	1235
RELAY PROGRAM MEMORANDUMS.....	1258
<i>Relay Program Memorandum</i>	1258
<i>Background – Relay Program Evaluation Memorandum</i>	1260

Marine Fisheries Commission Business Meeting

AGENDA

New Bern Convention Center, New Bern, North Carolina

February 19-21, 2020

N.C.G.S. 138A-15(e) mandates at the beginning of any meeting of a board, the chair shall remind all members of their duty to avoid conflicts of interest under Chapter 138. The chair also shall inquire as to whether there is any known conflict of interest with respect to any matters coming before the board at that time.

N.C.G.S. 143B-289.54.(g)(2) states a member of the Marine Fisheries Commission shall not vote on any issue before the Commission that would have a "significant and predictable effect" on the member's financial interest. For purposes of this subdivision, "significant and predictable effect" means there is or may be a close causal link between the decision of the Commission and an expected disproportionate financial benefit to the member that is shared only by a minority of persons within the same industry sector or gear group. A member of the Commission shall also abstain from voting on any petition submitted by an advocacy group of which the member is an officer or sits as a member of the advocacy group's board of directors. A member of the Commission shall not use the member's official position as a member of the Commission to secure any special privilege or exemption of substantial value for any person. No member of the Commission shall, by the member's conduct, create an appearance that any person could improperly influence the member in the performance of the member's official duties.

Commissioners having questions about a conflict of interest or appearance of conflict should consult with counsel to the Marine Fisheries Commission or the secretary's ethics liaison. Upon discovering a conflict, the commissioner should inform the chair of the commission in accordance with N.C.G.S. 138A-15(e).

Wednesday, February 19

6:00 p.m. Public Comment Period

Thursday, February 20

8:30 a.m. Call to Order*
Moment of Silence and Pledge of Allegiance
Swearing in of New Commissioner
Conflict of Interest Reminder
Roll Call
Approval of Agenda **
Approval of Meeting Minutes**

8:45 a.m. Public Comment Period

9:30 a.m. Chairman's Report
Overview of Briefing Materials
Letters
Ethics Training and Statement of Economic Interest Reminder
2020 Meeting Schedule
Commission Committee Assignments
Shellfish Lease Aquaculture Review Committee Update
Presentation of Service Plaques for Past MFC Commissioners

10:30 a.m. Committee Reports

- Habitat and Water Quality Advisory Committee
- Joint Meeting of the MFC Commercial Resources Fund Committee and the Funding Committee for the N. C. Commercial Fishing Resource Fund

Thursday, February 20 continued...

10:40 a.m. Rulemaking Presentation - Shawn Maier

11:00 a.m. **Potential Action to Begin Rulemaking for Small-Mesh Gill Nets – Steve Murphey****

12:00 p.m. Lunch Break

1 00 p.m. Fishery Management Plans

- Status of Ongoing Plans – Catherine Blum
- Blue Crab Fishery Management Plan Amendment 3 – Jason Rock, Corrin Flora
 - Overview of Departmental and Legislative Review
 - Plan for Implementation
 - **Vote on final adoption of Blue Crab FMP Amendment 3****
- Southern Flounder Fishery Management Plan Amendment 3 – Mike Loeffler, Anne Markwith
 - Summary of public comment received during scoping period
 - Overview of potential management strategies and plan timeline
 - Presentation of draft FMP goals and objectives
 - **Vote on FMP goal and objectives****
- Shrimp Fishery Management Plan Amendment 2 – Chris Stewart, Kim Harding, Jason Rock
 - Summary of public comment received during scoping period
 - Overview of potential management strategies and plan timeline
 - Presentation of draft FMP goals and objectives
 - **Vote on FMP goal and objectives****

3:45 p.m. Rulemaking Update – Catherine Blum

- 15A NCAC 03 - Marine Fisheries
 - 2019/2020 rulemaking cycle
 - Overview of public comments received
 - **Vote to approve 15A NCAC 03M .0509 (Tarpon) and 03O .0108 (License and Commercial Fishing Vessel Registration Transfers) ****
- Rulemaking Update Continued
 - 2020/2021 rulemaking cycle
 - **Vote on preferred management option for Shrimp Fishery Management Plan Amendment 1 Special Secondary Nursery Area Issue Paper**** – Chris Stewart
 - Oyster Sanctuary Rule Change Issue Paper update
- 15A NCAC 18A - Sanitation
 - Readoption schedule update

** Times indicated are merely for guidance. The commission will proceed through the agenda until completed.*

***Probable Action Items*

Marine Fisheries Commission Business Meeting Agenda

Thursday, February 20 continued...

- 4:15 p.m. Director's Report – Director Steve Murphey
Reports and updates on recent Division of Marine Fisheries activities
- Information Paper Regarding Recreational Hook and Line Modifications – Steve Poland
 - **Potential Action to Begin Rulemaking for Recreational Hook and Line Modifications****
- 5:30 p.m. Recess

Friday, February 21

- 9:00 a.m. Director's Report Continued – Director Steve Murphey
- Division of Marine Fisheries Quarterly Update
 - Atlantic States Marine Fisheries Commission – Chris Batsavage
 - Mid-Atlantic Fishery Management Council Update – Chris Batsavage
 - South Atlantic Fishery Management Council Update – Steve Poland
 - Highly Migratory Species
 - Bluefin Tuna Update
 - Protected Resources Update
 - Observer Program
 - Incidental Take Permit Updates
 - Rules Suspension Update – Kathy Rawls
 - **Vote to approve suspension of 15A NCAC 03M.0511****
 - Landings Update
 - Red Drum
 - Southern Flounder
- 11:00 a.m. Shellfish Aquaculture Update
- Shellfish Lease Program Overview
 - User Conflict Study Update – Jacob Boyd, Mike Graven
 - **Vote to approve proposed language for rulemaking to address user conflict as required by Shellfish Aquaculture Bill (Senate Bill 648, S.L. 2019-37) ****
 - Relay Program Update
- 11:30 a.m. Issues from Commissioners
- 11:45 a.m. Meeting Assignments and Preview of Agenda Items for May Meeting – Lara Klibansky
- 12:00 p.m. Adjourn**

** Times indicated are merely for guidance. The commission will proceed through the agenda until completed.*

***Probable Action Items*

Marine Fisheries Commission Business Meeting Minutes
Beaufort Hotel
Beaufort, North Carolina
Nov. 13-15, 2019

The commission held a business meeting Nov. 13-15 at the Beaufort Hotel in Beaufort, North Carolina.

The briefing book, presentations and audio from this meeting can be found at <http://portal.ncdenr.org/web/mf/11-2019-briefing-book>.

Actions and motions from the meeting are listed in **bolded** type.

BUSINESS MEETING - MOTIONS AND ACTIONS

On November 13, a public comment session was held beginning at 6 p.m. Chairman Rob Bizzell called the meeting to order. The following individuals spoke:

Glenn Skinner, commercial fisherman and Executive Director of the North Carolina Fisheries Association, stated that in 2016 the commission adopted management measures for the blue crab fishery. That same year, the commission asked the division to review the plan again; because of that, the stock assessment does not include any of those past three years with the management measures. Update the stock assessment first. To instill confidence in the stockholders, the commission needs to stop constantly changing management measures before they've been allowed to work. Crabbers saw the most crabs they've seen in twenty years this year. If you do have to take action, look at the public comment as there are some measurement measures that the fishermen say they just can't live with. Do something that will work for the crabs and the fishermen.

Mark Ragozzino, NC resident, supports improving the NC economy, maximizing the research value of the NC national estuarine reserve and supports amendment 3 appendix 4.5 attachment 1. The North Carolina Blue Crab Fisheries Management Plan designates Masonboro and Zeke Islands as a Diamondback Terrapin Management Area; it allows for high-quality bycatch reduction technique research to ensure future sustainability of the NC crab industry. Seafoodwatch.org does not support purchasing NC crab due to decimation of Diamondback Terrapin population by crab pot fishing without bycatch reduction techniques. Large seafood purchasers follow Seafoodwatch.org recommendations. High-quality research within the NC national estuarine reserve will enable lifting the adverse recommendations of Seafood Watch; enabling an increase of demand for NC crab and an increased income for NC crabbers.

Chris Elkins, on behalf of Coastal Conservation Association of North Carolina, provided the commission with a handout and commented on habitat and water quality and on the specific issue of oysters. On the topic of oyster dredging and oyster relay, he stated that oysters are very important in water quality and habitat; fishermen are often commenting on the declining water quality. Oysters are at an all-time low because of poor water quality as well as some other factors. Over 90 species have been shown to require oyster reefs in their life cycle. Last year, there were no oyster dredging landings, however, there was no issue in getting oysters; dredging is unnecessary. We are expanding our mariculture industry, but we should probably cap our oyster

relay program to where it is now and not continuing to destroy inshore habitat. It's also a problem for Marine Patrol.

David Sneed, Executive Director of CCANC, recreational fisherman and lifelong NC resident, he stated he grew up hunting and fishing in the coastal counties of NC has love and appreciation for our wildlife resources. CCA advocates conservation of coastal fisheries, fund and build oyster reefs, restore degraded habitat, fund scholarships for students, host kids fishing tournaments, etc. Yet despite all of CCA's efforts to promote coastal conservation in the recreational fisheries, they always get pushed to the side in favor of continued maximum exploitation of finite fish stocks. We have only asked that the commission take a little pressure off the fish stocks so that they can grow and provide more abundance for all fishermen. Mother Nature helped us take some pressure off with the cold stun event in 2017 that closed the speckled trout fishing and again in 2018 with back-to-back hurricanes; let them spawn. Proactive measures by this commission to remove anchored large mesh gill nets in the Tar, Pamlico and Neuse rivers has also helped take some pressure off of our fisheries. Now we are seeing some of the best recreational fishing in eastern NC in decades. We ask that you be proactive with management to keep recreational fishermen coming back to our coast. Thank you for taking the time to hear CCA's concerns about speckled trout three weeks ago.

Stuart Creighton, has serious concerns for the new process of streamlining FMPs as we move forward with Amendment 3 on the Southern Flounder Fishery Management Plan. He states that this new process will only disenfranchise an already frustrated and distrustful recreational angling community. Limiting public comment to a two-week scoping period is unwise and holding AC style workshops over a period of several days will only serve to prevent the public from attending. The division needs more transparency and recommends opening the FMP planning team meetings to the public. Regarding the pending flounder amendment; you will not achieve the needed harvest reductions without gear removal; the division seems to be leaning towards a quota. If so, it must be strictly monitored and include paybacks for overages; gear must be kept out of the water until the designated season opens and a slot length should be included. Gill nets need to be removed. Circle hooks should be required for anyone using live or cut bait regardless of the inshore species being targeted. Additional enforcement officers with full policing powers will need to be added to ensure the reductions are being properly followed. Remove the gill nets and replace them with a commercial hook-and-line fishery as well as an appropriate slot length for speckled trout; 14-22" would work well. At the August meeting he asked the commission to start modeling their management after other states; give the commercial fishermen something successful, profitable and sustainable, but the gill nets have to come out of the water and trawlers out of the sounds.

The meeting recessed at 6:20 p.m.

Nov. 14

Chairman Rob Bizzell convened the Marine Fisheries Commission business meeting at 9 a.m. on Nov. 14 and reminded commissioners of their conflict of interest and ethics requirements.

The following commission members were in attendance: Rob Bizzell-Chairman, Mike Blanton, Cameron Boltes, Doug Cross, Tom Hendrickson, James Kornegay, Robert McNeill, Dr. Martin Posey and Sam Romano.

Motion by Doug Cross to approve agenda with leeway to adjust non-action items for time efficiency. Second by Tom Hendrickson.

Motion carries with no opposition.

Motion by Martin Posey to approve minutes from the August 2019. Second by Doug Cross. Motion carries with no opposition.

Public Comment Period

Renee Cahoon, of Nags Head and chair of the Coastal Resources Commission, stated that there is great concern to the CRC as well as coastal CAMA management regarding the proposed delineation of inland waters rule change. It would greatly impact buffer rules that are currently in place as it would take the buffer from 75' to 30' allowing a great amount of water runoff to occur in our rivers and tributaries. Water quality is already a concern, but if you change the buffer rules, it would greatly impact the water quality which would in turn impact all of our resources. Some of our mandates in coastal management are set up in state statute and cannot just be changed easily. This rule change needs more work and more cooperation from other boards and commissions; bring all the commissions and staff together to discuss this proposed rule change before we have unintended consequences. Perhaps the Coastal Habitat Protection Plan is the proper venue for taking on this issue.

Jerry Schill, of the North Carolina Fisheries Association, stated that the NCFA endorses the slate of candidates for the obligatory seat on the Mid-Atlantic Council; with Dewey Hemilright as the preferred candidate as he is the incumbent. The NCFA formally asks the commission to oppose any further action by the Wildlife Resources Commission to revise the rules on the delineation of fishing waters as well as advise the Governor. While the WRC has recommendations for changing lines, they have provided no scientific rationale for doing so. He also stated he wanted to echo what Chairman Cahoon had stated about the effect on water quality on the coast.

Chris McCaffity, as a recreational license holder he asks that the flounder fishery start being responsibly managed in a way that would avoid complete closures and reduces regulatory discards; use license fees to help fund regional stocking of larval stage flounder and other fish to create hatchery supported quotas that support more harvest. As a commercial fishing license holder, he asks that some of the license fees help regionally stock larval stage seafood and create hatchery supported quotas that support more harvest. He asked the commission to consider how this solution could help offset some of the impacts that habitat degradation has on spawning. Stocking natural seafood could help us sustainably feed a growing population while keeping fish and fishermen wild and free. As a seafood consumer and concerned citizen he asks that the managers focus more on enhancing fisheries and food supply rather than restricting the public's freedom to access it. Wise use of proven management tools that focus on enhancement will create more seafood, recreational opportunity and eco-friendly revenue while preserving our freedom to fish and access public resources. Please reopen North Carolina's historic river herring fishery, support a moratorium on farming fish in public waters and please consider options for purchasing catch-shares to create state-controlled quotas in fisheries that have been privatized to prevent foreign ownership of our public resources. Ask the South Atlantic Management Council not to create dozens of new special management zones off of our coast as they will be an enforcement nightmare with no biological benefit. Ask the Bureau of Ocean Energy Management not to allow more rounds of secret seismic testing and require any offshore energy structures to be designed as permanent artificial reefs.

Bert Owens, of Beaufort stated that water quality is an important issue; having grown up in Kinston, he saw that hog farmers would dump their 100% untreated waste directly into the river, as did every other town on the Neuse River. You can see the abandoned pipes from Cherry Point where the military bases used to dump everything directly into the river. We've come a long way, but there is still more work to do. He asked the commission regarding oyster column leases to consider not blocking off historic duck blind areas. In the scoping document for flounder there was a question as to whether or not recreational anglers could identify various species of flounder; it would be a good idea next July or August to open the ocean to angling for flounder for a month and let Marine Patrol determine whether anglers can differentiate between species of flounder; it would give good data to move forward with.

Jess Hawkins, former Division of Marine Fisheries staff member, scientist and avid recreational angler representing himself, stated he had comments regarding WRC's delineation issue. Deputy Secretary John Nicholson laid out some very precise points for the commission as well as policy considerations to help guide your decisions. He stated that he had worked with four governors and nine directors; experience in seeing how fishery policy is developed for the state of NC. During his tenure they had meetings with WRC to discuss boundaries and see if the boundaries needed to be modified. The boundaries are a result of an agreement between the two commissions. Statutes also allow that if an agreement cannot be made between the two commissions, the Governor will be the source of the conflict resolution. During his time, they were unable to consider proposals to modify the boundaries. Since that time, the General Assembly passed a regulatory reform statute that stimulates jobs and eliminates unnecessary regulations. As your three commissioners serve on the subcommittee; you've created two disparate movements of regulatory action and creates more confusion. Regarding the science; the standards that the WRC picked are subject to review by scientist. There are scientists on this commission or there are experts within this state that could present to you as whether a 2.7 parts per thousand salinity standard is accurate to determine what are coastal waters. It is his opinion that if there is any salinity you should consider them coastal waters and in turn, they should be under the jurisdiction of this commission. The history of developing these boundaries involved the two agencies sitting down and looking at delineation based on the distribution of fish. Pass a motion to go on record opposing this action and if the WRC still continues to peruse the issue, ask for a meeting with the Governor to try to resolve this conflict as part of that motion.

Chuck Laughridge, stated that he missed the Raleigh meeting due to an appointment issue, but would like to thank every member of the senior staff, member of DMF, the law enforcement officers, Director Murphey, etc. It has been a privilege to work with those folks. He urged the public to listen to what Chairman Bizzell says before every public comment period about behavior and being asked to leave the meeting. Regarding delineation, he stated we are hammering around the edges; you are charged with managing what is now a \$4.5 billion fishery, you can not meet and manage a corporation or a business, church or CRFL grant with 36 hours a year. That's the amount of time you spend conducting business at the four quarterly business meetings every year. Beg the Governor, ask the legislators to give you additional time, and allow the public to participate if you want to work at it. Not only in scoping meetings, but allow the public to speak to you on a one-to-one basis. Time of death 21 minutes after 9 o'clock.

Chairman's Report

Chairman Bizzell reviewed correspondence that had been sent and received by the commission since the last business meeting and the commission was reminded of their ethics education requirements and the April 15 deadline to file their Statement of Economic Interest.

Shawn Maier, the Commission's legal counsel gave a verbal update on litigation and comments on conflict of interest. The legal case of North Carolina Fisheries Association vs. Marine Fisheries Commission regarding alleged open meeting violation from a 2017 meeting. Since the August commission meeting, the NCFA has filed a voluntary dismissal in that lawsuit. The second lawsuit Fishers of Men vs. Marine Fisheries Commission and Wildlife Resources Commission is an action seeking a declaratory judgement based on both commissions' zero possession limit of striped bass in the CSMA. Shawn stated they are trying to work with opposing counsel to get our motion as well as WRC's motion to dismiss on the calendar as well as a trial date for 2020 scheduled.

Shawn, at the request of Chairman Bizzell, went over what conflicts of interest look like; various provisions of this commission's statutes say, and what the State Government Ethics Act say about what a conflict of interest is. He reminded the commissioners that if they should have individual questions, he is happy to take them or speak one-on-one.

The 2019/2020 committee assignments for commissioners was included in the briefing materials and commissioners were asked to review and let the chairman know if they had any questions or concerns.

Chairman Bizzell presented former MFC liaison, Nancy Fish, with a vase and roses in appreciation for her years of service.

Update on WRC/MFC Jointly Adopted Rules on Delineation of Fishing Waters.

Chairman Bizzell gave a verbal update on WRC/MFC to jointly adopt rules on delineation of fishing waters. He stated that they are still have discussions with Gordon Myers and several members of the WRC; trying to hash things out and have a better understanding. It was initially thought that a consensus or non-consensus about where the lines were acceptable to us was needed from us in November. However, that is not necessarily the case. In the briefing book there are several letters and a draft timeline from WRC. Not much more to report, but to let the process run its course and then report at the end.

Commissioner Cross stated that he believed the MFC needed to go back on the record and reiterate their position; we are standing behind the division with our same guidelines because he believes it is the best science they have been presented with. The WRC's model is based off of Chesapeake Bay and it doesn't make any sense for the argument they are presenting. He suggested making a motion reiterating their position.

Commissioner Posey expressed his concerns with the WRC's suggestion; both ecological and management concerns. The letter from DEQ in their briefing materials covers some of his concerns. He stated that key species utilize low salinity areas below the level indicated by the WRC; blue crab, flounder, mullet, sea trout, etc. It creates problems when you put a boundary there; having to look at resources from two different organizations. He doesn't believe the Chesapeake Bay model is applicable in this instance for various reasons including ecosystem breaks because of their fundamental influence on our fisheries and coastal resources. He also mentioned expected saltwater intrusion; the locations will probably get saltier over time; creates an issue if we aren't going to review it every year. From a management standpoint, the WRC's suggested dividing line creates concerns related to uniform management of fisheries. Significant jurisdictional changes for several agencies; CAMA, CRC, which will in turn have impacts on setbacks and other regulatory aspects that affect water and habitat quality and storm water regulations. There will be a lot of unintended impacts and direct and obvious impacts and we should go on record as having a concern with their somewhat unilateral movement they have taken.

Commissioner Blanton added some points based on management of species used by the commercial industry in significant portions of the waterways especially in the northern part of the state. He stated that the Albemarle sound and its tributaries is probably the most used by the commercial crabber in the state; jimmy crabs come from these tributaries. We are dealing with an invasive species (blue catfish) that has expanded significantly in the last five years. These fish will be detrimental to stocks managed in an interstate plan, ASMFC, such as shad, river herring, striped bass, etc. This will become a bigger problem to the commercial sector if the boundary lines are moved up and the commercial sector not be able to harvest blue catfish.

Motion by Doug Cross that the Marine Fisheries Commission reject the N.C. Wildlife Resources Commission recommendation of a 2.6 parts per thousand delineation line as it pertains to a boundary for inland and coastal waters and that we recommend staying at status quo on our current guidelines that we are at that our rules are already in place for. Motion ruled out of order by chairman.

Motion by Martin Posey that the Marine Fisheries Commission support continuation of the joint discussion process as represented by the Wildlife Resources Commission/Marine Fisheries Commission Joint Committee on Delineation of Fishing Waters. Motion seconded by Pete Kornegay.

Motion by Martin Posey to amend the previous motion so that it reads: that the Marine Fisheries Commission supports continuation of the joint discussion process as represented by the Wildlife Resources Commission/Marine Fisheries Commission Joint Committee on Delineation of Fishing Waters. These commissions should seek input from other impacted units including the Coastal Resources Commission, the Environmental Management Commission, as well as support from staff. Motion to amend seconded by Pete Kornegay. Motion carries with two abstentions.

Committee Reports

CHPP Steering Committee

Commissioner Posey gave a verbal update of the Coastal Habitat Protection Plan Steering Committee meeting that took place on October 16. He pointed the Commissioners to the meeting summary in their briefing books written by CHPP chair Jimmy Johnson. He stated the meeting's focus was on the 2021 revision of the plan. Commissioner Posey stated that the meeting started with an update on the 2016 CHPP priorities which included; oyster restoration, metric development, living shorelines and sedimentation. Also notable; the NC Living Shoreline Steering Committee has now been formed to further advance this method of shoreline stabilization. Commissioner Posey also touched upon the 2021 revision process and timeline using the SMART (specific, measurable, attainable relevant, and timely) approach. He also spoke about priority habitat issues which include; SAV protection and restoration with focus on water quality improvements, wetland shoreline protection and enhancement using nature-based methods and habitat condition monitoring and environmental rule compliance. He also mentioned the EO80 and its relation to the CHPP as well as the NC Climate Science Report.

Commissioner Blanton spoke of the algal blooms in the Albemarle Sound and stated he is encouraged by the work that is being done to figure out what is going on with the degrading condition of the Sound.

Nominating Committee

Division staff reported that the commission's Nominating Committee voted to forward the names of Dewey Hemilright, Brent Fulcher, and Robert Ruhle to the commission for consideration as nominees to North Carolina's obligatory seat on the Mid-Atlantic Fishery Management Council. The commission is required to submit to the governor a minimum of three candidates for consideration for each seat. Bios were reviewed for each of the potential nominees.

The commission voted to forward the names recommended by the Nominating Committee to the Governor's Office for consideration as nominees for North Carolina's Mid-Atlantic Fishery Management Council obligatory seat.

Motion by Mike Blanton to send the following names to the governor for consideration as nominees for the Mid-Atlantic Fishery Management Council obligatory seat:

- **Dewey Hemilright, a commercial fisherman from Kitty Hawk and the current N.C. obligatory member on the Mid-Atlantic Fishery Management Council**
- **Brent Fulcher, a dealer and vessel owner from New Bern**
- **Robert Ruhle, a commercial fisherman from Wanchese**

Motion seconded by Doug Cross.

Motion carries with no dissention.

Coastal Recreational Fishing License Advisory Committee

Commissioner Kornegay gave an update on the Coastal Recreational Fishing License Advisory Committee meeting that took place on October 1 to review 17 CRFL project applications. He stated that the committee advised the director to in favor of funding four fisheries applications, three habitat applications and one outreach application. The committee advised the director not to fund three fisheries applications, three habitat applications and one outreach application. Two other fisheries applications were tabled pending further information. He pointed the commission to their briefing books for details of each application.

Director's Report

Division of Marine Fisheries Director Steve Murphey introduced the Division's new Executive Assistant to Commissions and Councils, Lara Klibansky, and gave a summary of her bio and then updated the commission on division activities occurring since the August 2019 business meeting, including:

- The leaking of confidential information regarding the Hurricane Florence Commercial Fishing Assistance online by another agency; stating that the division takes confidential information very seriously. The DMF did not disclose any of this confidential information nor did anyone at DMF or DEQ have knowledge that this information was being released to anyone outside of the state agency.
- The major concern voiced by FMP committee members, MFC advisors, NCFCA and other stakeholders, about the Blue Crab Fishery Management Plan Amendment 3 was that the current stock assessment does not account for regulation changes put into effect after the May 2016 revision. We are seeing some improvement in spawning stock recruitment and adult abundance indices used in the traffic light analysis during 2018. Director Murphey gave some background information on the Blue Crab FMP and stated that the DMF will be recommending a minimum of 2.2% reduction in harvest. The division supports acting now to ensure the long-term sustainability of the most valuable fishery of NC.

- Director Murphey gave an overview of the Coastal Habitat Protection Plan and thanked Commissioner Posey for his summary of the meeting. He also gave an update on shellfish aquaculture and user conflicts, artificial reefs, oyster season, summer flounder, oyster sanctuary program, trout cold stun protocol, diamondback terrapin, NC Seafood Festival, Hurricane Dorian, DEQ awards, and CRFL projects.

Presentation – Shellfish Sanitation: Naturally Occuring Pathogens

Shellfish Sanitation Section Chief, Shannon Jenkins

This presentation can be found at:

http://portal.ncdenr.org/c/document_library/get_file?p_l_id=1169848&folderId=33374115&name=DLFE-141905.pdf

Commissioner Hendrickson requested outreach in the form of a clear set of best practices for consumers.

N.C. Wildlife Federation Officer of the Year Presentation:

Tim Gestwicki and Manley Fuller of the North Carolina Wildlife Federation honored Officer of the Year, Malcom Bryan Eure who was unable to attend the NCWF awards ceremony on September 9; the day after Hurricane Dorian.

Steve Poland, the division’s representative on the South Atlantic Fisheries Management Council, gave an update on the development of the issue paper regarding recreational hook-and-line modifications.

Division staff provided an overview of recent actions from the Atlantic States Marine Fisheries Commission and the Mid- and South Atlantic Fishery Management Councils, Highly Migratory Species, along with updates on the division’s Protected Resources Program.

Col. Carter Witten gave an update on the civil penalties process.

Update on act to provide further support to the shellfish aquaculture industry in North Carolina (Session Law 2019-37)

Jacob Boyd, Section Chief of the Habitat and Enhancement Section provided the commission with an.

This presentation can be found here:

http://portal.ncdenr.org/c/document_library/get_file?p_l_id=1169848&folderId=33374115&name=DLFE-141904.pdf

Commissioner Hendrickson expressed a concern with the lack of maps showing the proposed setbacks. Jacob Boyd addressed his concerns by describing the plan to solicit public and stakeholder input, which will be occurring later in 2019. Described the possible options the commission has to move forward with mitigating user conflicts.

Motion by Martin Posey to accept the report regarding a study on reducing user conflicts related to shellfish cultivation leases as a guideline for moving forward. Motion seconded by Mike Blanton.

Motion carries 7-1 with one abstention.

Rob passed gavel to vice chair, Doug Cross.

Rules Suspension Annual Update

Kathy Rawls, Section Chief of Fisheries Management, provided an update on the seven rules that have been temporarily suspended by proclamation.

Commissioner Boltes asked questions about the director's report; getting federal funds to the recreational industry and mechanical harvest of oysters.

The meeting recessed for the day at 5:15 p.m.

Nov. 15

The meeting reconvened at 9 a.m.

Chairman Bizzell asked for a motion to move the FMP update to the top of the day's agenda because of impending weather.

Motion by Mike Blanton to move the Friday, 10 a.m. agenda item to 9 a.m. Motion seconded by Sam Romano. Motion carries with no objection.

Fishery Management Plan Update

Catherine Blum, the division's Fishery Management Plan Coordinator, gave the commission an update on the status of North Carolina's ongoing fishery management plans.

Blue Crab

Blue Crab Fishery Management Plan Amendment 3 – Jason Rock and Corrin Flora

http://portal.ncdenr.org/c/document_library/get_file?p_l_id=1169848&folderId=33374115&name=DLFE-141907.pdf

Motion by Sam Romano to table the vote on the draft Blue Crab Fishery Management Plan until there is an updated stock assessment through 2019 data. Motion seconded by Mike Blanton. Motion fails 2-4 with three abstentions.

Motion by Martin Posey to support the Division of Marine Fisheries recommendation for a minimum harvest reduction of 2.2% to achieve a sustainable harvest within ten years and end over fishing within two years in the blue crab fishery. Motion seconded by Tom Hendrickson. Motion carries 8-1.

Motion by Sam Romano to accept the Blue Crab Advisory Committee recommendation for achieving sustainable harvest and ending overfishing. Motion seconded by Cameron Boltes. Motion carries 7-1 with one abstention.

Motion by Mike Blanton to accept the Blue Crab Advisory Committee recommendation with the current cull ring set up and add Option 4C. Motion seconded by Doug Cross. Motion withdrawn.

Motion by Martin Posey to leave in the existing rules established in 2016 and add Option 4C. Motion seconded by Mike Blanton. Motion carries with no dissent.

Motion by Martin Posey to accept the Division of Marine Fisheries water quality recommendations. Motion seconded by Mike Blanton. Motion carries with no dissent.

Motion by Mike Blanton to accept the Blue Crab Advisory Committee recommendation for spawning sanctuaries, with the addition of using the Division of Marine Fisheries recommendation for the Cape Fear River Inlet crab spawning sanctuary. Motion seconded by Doug Cross. Motion carries 5-3 with one abstention.

Motion by Doug Cross to use science on locally specific pot funnel design to reduce terrapin interactions and identify individual areas with terrapin hotspots that would be closed to potting unless an excluder is used. Motion seconded by Sam Romano. Motion carries 7-1 with one abstention.

Motion by Sam Romano to adopt the Blue Crab Advisory Committee recommendation regarding dredging. Motion seconded by Doug Cross. Motion fails 2-5 with two abstentions.

Motion by Martin Posey to accept the Division of Marine Fisheries recommendation regarding crab dredging (Option 1A). Motion seconded by Pete Kornegay. Motion carries 6-1 with two abstentions.

Doug Cross left the meeting at 12:28.

Motion by Martin Posey to accept Option 1D regarding oyster dredging. Motion seconded by Pete Kornegay. Motion carries 6-1 with one abstention.

Motion by Robert McNeil to accept Option 2A regarding crab trawls in areas where shrimp trawls are already prohibited in the Pamlico, Pungo, and Neuse Rivers. Motion seconded by Cameron Boltes. Motion carries 5-2 with one abstention.

Motion by Mike Blanton to send the draft Blue Crab Fishery Management Plan Amendment 3 to the Department of Environmental Quality secretary for review and comment. Motion seconded by Tom Hendrickson. Motion carries with one dissent.

Southern Flounder

Mike Loeffler and Anne Markwith gave an update on the Southern Flounder Fishery Management Plan Amendment 3.

Shrimp

Chris Stewart, Jason Rock and Kim Harding gave an update on the Shrimp Fishery Management Plan Amendment 2.

CHPP& Executive Order 80

Anne Deaton, Jimmy Johnson and Jacob Boyd gave an update and presentations on the Coastal Habitat Protection Plan Update and Executive Order 80.

Coastal Habitat Protection Plan update presentation:

http://portal.ncdenr.org/c/document_library/get_file?p_l_id=1169848&folderId=33374115&name=DLF E-141902.pdf

Executive Order 80 update presentation:

http://portal.ncdenr.org/c/document_library/get_file?p_l_id=1169848&folderId=33374115&name=DLF E-141903.pdf

Rulemaking

Catherine Blum, the division's rulemaking coordinator gave an update on:

- Update on S.L. 2019-198 – Legislative Review of Regulatory Crimes
- Periodic Review and Expiration of Existing Rules per G.S. 150B-21.3A
- 15A NCAC 03 rule readoption update
- 15A NCAC 18A Rule Readoption Schedule

Motion by Mike Blanton to Approve a four-year schedule to readopt the Marine Fisheries Commission's rules in 15A NCAC 18A by June 30, 2024, as recommended by staff.

Motion seconded by Pete Kornegay.

Motion carries with no dissent.

Issues from Commissioners

Cameron Boltes – asked how it is determined that the hurricane relief funds are confidential versus public information. Director Murphey answered that it is written in statute that all the license, landing, etc. is treated as confidential.

Sam Romano – Suggested a discussion topic for next meeting, time permitting: the decrease in effort that comes along with the rules; optimal yield.

Chairman Bizzell -

- May eliminate Wednesday night public comment.
- E-books issues that need addressing
- Looking into the possibility of holding the August 2020 meeting in Asheville.

Mike Blanton asked that the commission look into holding the quarterly business meetings in the locations of the commission members.

Lara Klibansky gave meeting assignments and preview of agenda items for the February MFC business meeting which will be held in New Bern.

Agenda Items for February Meeting:

- Recreational Hook and Line Modifications Information Paper
- Oyster Sanctuary Rule Change
- Special Secondary Nursery Areas – Shrimp FMP Amendment 1, Habitat and Water Quality AC will meet in December to provide their input on the issue.
- Vote on permanent approval of the tarpon (15A NCAC 03M .0509) and SCFL transfer (15A NCAC 03O .0108) rules
- Vote on final adoption of the Blue Crab FMP Amendment 3

- Presentation of the Southern Flounder FMP Amendment 3 timeline overview and the draft goal and objectives, which you'll be voting on. Provide input on the management strategies to be examined in Amendment 3.
- Presentation of the Shrimp FMP Amendment 2 timeline overview and the draft goal and objectives, which you'll be voting on. Provide input on the management strategies to be examined in Amendment 2.

The meeting adjourned around 1:50 p.m.

DRAFT

CHAIRMAN'S REPORT

LETTERS

**ETHICS
EDUCATION**

**2020 MEETING
SCHEDULE**

**COMMITTEE
ASSIGNMENTS**

LETTERS

**BLUE
CRAB**

**DELINEATION
OF FISHING
WATERS**

FLOUNDER

MAFMC

NCWF

**RULE
READOPTION**

SHRIMP

MFC AC

MISC.

BLUE CRAB

Nov. 25, 2019

Michael S. Regan, Secretary
North Carolina Department of Environmental Quality
1601 Mail Service Center
Raleigh, NC 27699-1601

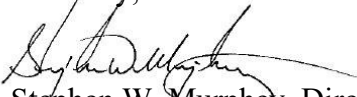
Dear Secretary Regan,

On Nov. 15, 2019, the North Carolina Marine Fisheries Commission approved the draft North Carolina Blue Crab Fishery Management Plan Amendment 3 for your review. The amendment is located at <http://portal.ncdenr.org/web/mf/blue-crab-topic> and the executive summary of the plan is enclosed for your convenience. Please submit any comments or recommendations regarding the plan to my office within 30 days.

The Fisheries Reform Act of 1997 [G.S. 113-182.1 (c1) and (e)] requires that you transmit this fishery management plan to the Joint Legislative Commission on Governmental Operations and the Joint Legislative Oversight Committee on Agriculture and Natural and Economic Resources for review. The commission and committee also have 30 days from the date of receipt of the plan to submit comments. Cover letters for your signature are being prepared for that purpose and will be sent under separate cover.

Thank you for your assistance in this matter and please contact me at 252-808-8013 if you have any questions.

Sincerely,



Stephen W. Murphey, Director
North Carolina Division of Marine Fisheries

Enclosure

cc: North Carolina Marine Fisheries Commission
Joy Hicks, Department of Environmental Quality Legislative Affairs Director

SWM/cb

N.C. Blue Crab Fishery Management Plan Amendment 3

Executive Summary

North Carolina's blue crab resource has been harvested since the 1800s and supports the state's largest and most valuable commercial fishery. The blue crab fishery in North Carolina is the fourth largest blue crab fishery in the United States. Blue crab is also targeted by recreational fishermen and is an important species in the coastal ecosystem serving as prey for many recreationally and commercially important species.

The 2018 stock assessment determined the North Carolina blue crab stock is overfished and overfishing is occurring. State law requires management action to be taken to end overfishing within 2 years and to recover the stock from an overfished condition within 10 years with a 50% probability of success from the date of adoption of the plan. A minimum harvest reduction of 2.2% in numbers of crabs from 2016 commercial hard crab landings is necessary to meet these statutory requirements.

The goal of the North Carolina Blue Crab Fishery Management Plan (FMP) is to manage the blue crab fishery to achieve a self-sustaining population that provides sustainable harvest using science-based decision-making processes. Objectives for the FMP are: implement management strategies that maintain/restore the blue crab spawning stock with multiple cohorts and adequate abundance to prevent recruitment overfishing; restore, enhance, and protect habitat and environmental quality necessary to maintain or increase growth, survival, and reproduction of the blue crab population; use biological, environmental, habitat, fishery, social, and economic data needed to effectively monitor and manage the blue crab fishery and its ecosystem impacts; promote stewardship of the resource through increased public awareness regarding the status and management of the blue crab fishery, including practices that minimize bycatch and discard mortality.

To meet statutory requirements to achieve a self-sustaining population, sustainable harvest was addressed in the FMP. Other issues addressed in the plan encompassed the following general categories: non-quantifiable management measures, water quality, crab spawning sanctuaries, use criteria for terrapin excluder devices, and bottom disturbing gear. Specific recommendations for each issue are as follows:

- 1) Achieving sustainable harvest: To recover the North Carolina blue crab stock the selected management strategy is: a January closed season and a 6 ¾-inch maximum size limit for mature female blue crabs north of the Highway 58 Bridge; a March 1 to 15 closed season south of the Highway 58 Bridge; and to retain the prohibition on immature female hard crab harvest and the 5% cull tolerance established in the 2016 Revision to Amendment 2. These measures are estimated to result in a 3.1% harvest reduction from 2016 landings. Other measures selected were to: have the season closures replace the annual pot closure period; adopt the adaptive management framework based on the peer-reviewed and approved stock assessment; and to update the stock assessment once 2019 data is available.

- 2) Non-quantifiable management measures: While not having quantifiable harvest reductions, several additional management measures were identified that could help improve the condition of the blue crab stock. The selected management strategy includes the following: retain a minimum number of 3 cull rings per pot with one in the modified corner position and to prohibit the harvest of dark sponge crabs from April 1-30 measures established in the 2016 Revision to Amendment 2; and removing the cull ring exemptions for the Newport River and eastern Pamlico Sound.
- 3) Water quality: Negative impacts to blue crab from poor water quality have been widely documented and strategies were developed for the N.C. Marine Fisheries Commission (MFC) to pursue to improve water quality. Strategies selected were: highlight problem areas and advise other regulatory agencies; push to create an interagency work group; support the Clean Water Act; task the CHPP steering committee to prioritize blue crab water quality impacts; send letters to other state agencies sharing concerns about water quality and Best Management Practices; invite other agencies to future MFC meetings to present their efforts to address water quality; and initiate public outreach on how to report crab and fish kills.
- 4) Crab spawning sanctuaries: Research has shown the existing crab spawning sanctuaries are largely ineffective due to their small size and that expanding the sanctuary system as well as establishing migration corridors will increase the number of mature females reaching the spawning grounds. The selected management strategy includes: maintain the current sanctuary boundaries for Oregon, Hatteras, and Ocracoke inlets; move the Drum Inlet sanctuary boundary to encompass Ophelia Inlet; expand the Barden Inlet sanctuary boundary; and designate new crab spawning sanctuaries around Beaufort, Bogue, Bear, Browns, New River, Topsail, Rich, Mason, Masonboro, Carolina Beach, Cape Fear River, Shallotte, Lockwood Folly, and Tubbs inlets. The new crab spawning sanctuaries will be closed from March 1 to October 31 with the same restrictions as previously existing sanctuaries.
- 5) Terrapin excluder devices: The bycatch of diamondback terrapins has been discussed in every blue crab FMP since 1998 with little action. To address this issue the selected management strategy is to study locally specific pot funnel designs to reduce terrapin bycatch in crab pots and to identify individual areas with diamondback terrapin hot spots that will be closed to pots unless a terrapin excluder device is used.
- 6) Bottom disturbing gear: To reduce the habitat impacts from the blue crab fishery, the use of bottom disturbing gear, specifically dredges and trawls, was examined. The selected management strategy includes: retain the prohibition on targeted crab dredging established in the 2016 Revision to Amendment 2; reduce the crab bycatch limit from oyster dredges to 10% of the combined crab and oyster catch or 100 pounds, whichever is less; and to prohibit the use of crab trawls in areas where shrimp trawls are prohibited in the Pamlico, Pungo, and Neuse rivers.



NORTH CAROLINA
Environmental Quality

ROY COOPER
Governor

MICHAEL S. REGAN
Secretary

December 6, 2019

Senator Phil Berger and Representative Tim Moore, Co-Chairs
Joint Legislative Commission on Governmental Operations
North Carolina General Assembly
Legislative Building
16 West Jones Street
Raleigh, NC 27601

RE: Draft Blue Crab Fishery Management Plan Amendment 3

Dear Senator Berger and Representative Moore:

The draft North Carolina Blue Crab Fishery Management Plan Amendment 3 was submitted to me by the North Carolina Marine Fisheries Commission for review. North Carolina General Statute 113-182.1(e) requires that once I review any proposed fishery management plan, I report that plan to the Joint Legislative Oversight Committee on Agriculture and Natural and Economic Resources. The committee then has 30 days to submit comments or recommendations to me on the proposed plan. Additionally, G.S. 113-182.1(c1) requires the department to review any comment or recommendation regarding a plan that a regional advisory committee submits to the department before submission of a plan to the Joint Legislative Commission on Governmental Operations.

The amendment is located at <http://portal.ncdenr.org/web/mf/blue-crab-topic> and the executive summary of the plan is enclosed for your convenience. While not formally provided for in the statute, if you commission has comments or recommendations on the proposed plan, please send them to me within 30 days of the date of this letter. Thank you for your assistance in this matter. Please contact Department of Environmental Quality Legislative Affairs Director Joy Hicks at 919-707-8618 if you have any questions.

Sincerely, 1

A handwritten signature in black ink that reads "Michael S. Regan".

Michael S. Regan
Secretary

Enclosure

cc: North Carolina Marine Fisheries Commission
Joy Hicks, Department of Environmental Quality Legislative Affairs Director
Steve Murphey, Division of Marine Fisheries Director





NORTH CAROLINA
Environmental Quality

ROY COOPER
Governor

MICHAEL S. REGAN
Secretary

December 6, 2019

Senator Brent Jackson and Representatives Jimmy Dixon and Pat McElraft, Co-Chairs
Joint Legislative Oversight Committee on Agriculture and Natural and Economic Resources
North Carolina General Assembly
Legislative Building
16 West Jones Street
Raleigh, NC 27601

RE: Draft Blue Crab Fishery Management Plan Amendment 3

Dear Senator Jackson and Representatives Dixon and McElraft:

The draft North Carolina Blue Crab Fishery Management Plan Amendment 3 was submitted to me by the North Carolina Marine Fisheries Commission for review. North Carolina General Statute 113-182.1(e) requires that once I review any proposed fishery management plan, I report that plan to the Joint Legislative Oversight Committee on Agriculture and Natural and Economic Resources. Per the statute, if your committee has comments or recommendations on the proposed plan, please send them to me within 30 days of the date of this letter.

The amendment is located at <http://portal.ncdenr.org/web/mf/blue-crab-topic> and the executive summary of the plan is enclosed for your convenience. Thank you for your assistance in this matter. Please contact Department of Environmental Quality Legislative Affairs Director Joy Hicks at 919-707-8618 if you have any questions.

Sincerely,

A handwritten signature in black ink that reads "Michael S. Regan".

Michael S. Regan
Secretary

Enclosure

cc: North Carolina Marine Fisheries Commission
Joy Hicks, Department of Environmental Quality Legislative Affairs Director
Steve Murphey, Division of Marine Fisheries Director



N.C. Blue Crab Fishery Management Plan Amendment 3

Executive Summary

North Carolina's blue crab resource has been harvested since the 1800s and supports the state's largest and most valuable commercial fishery. The blue crab fishery in North Carolina is the fourth largest blue crab fishery in the United States. Blue crab is also targeted by recreational fishermen and is an important species in the coastal ecosystem serving as prey for many recreationally and commercially important species.

The 2018 stock assessment determined the North Carolina blue crab stock is overfished and overfishing is occurring. State law requires management action to be taken to end overfishing within 2 years and to recover the stock from an overfished condition within 10 years with a 50% probability of success from the date of adoption of the plan. A minimum harvest reduction of 2.2% in numbers of crabs from 2016 commercial hard crab landings is necessary to meet these statutory requirements.

The goal of the North Carolina Blue Crab Fishery Management Plan (FMP) is to manage the blue crab fishery to achieve a self-sustaining population that provides sustainable harvest using science-based decision-making processes. Objectives for the FMP are: implement management strategies that maintain/restore the blue crab spawning stock with multiple cohorts and adequate abundance to prevent recruitment overfishing; restore, enhance, and protect habitat and environmental quality necessary to maintain or increase growth, survival, and reproduction of the blue crab population; use biological, environmental, habitat, fishery, social, and economic data needed to effectively monitor and manage the blue crab fishery and its ecosystem impacts; promote stewardship of the resource through increased public awareness regarding the status and management of the blue crab fishery, including practices that minimize bycatch and discard mortality.

To meet statutory requirements to achieve a self-sustaining population, sustainable harvest was addressed in the FMP. Other issues addressed in the plan encompassed the following general categories: non-quantifiable management measures, water quality, crab spawning sanctuaries, use criteria for terrapin excluder devices, and bottom disturbing gear. Specific recommendations for each issue are as follows:

- 1) Achieving sustainable harvest: To recover the North Carolina blue crab stock the selected management strategy is: a January closed season and a 6 ¾-inch maximum size limit for mature female blue crabs north of the Highway 58 Bridge; a March 1 to 15 closed season south of the Highway 58 Bridge; and to retain the prohibition on immature female hard crab harvest and the 5% cull tolerance established in the 2016 Revision to Amendment 2. These measures are estimated to result in a 3.1% harvest reduction from 2016 landings. Other measures selected were to: have the season closures replace the annual pot closure period; adopt the adaptive management framework based on the peer-reviewed and approved stock assessment; and to update the stock assessment once 2019 data is available.

- 2) Non-quantifiable management measures: While not having quantifiable harvest reductions, several additional management measures were identified that could help improve the condition of the blue crab stock. The selected management strategy includes the following: retain a minimum number of 3 cull rings per pot with one in the modified corner position and to prohibit the harvest of dark sponge crabs from April 1-30 measures established in the 2016 Revision to Amendment 2; and removing the cull ring exemptions for the Newport River and eastern Pamlico Sound.
- 3) Water quality: Negative impacts to blue crab from poor water quality have been widely documented and strategies were developed for the N.C. Marine Fisheries Commission (MFC) to pursue to improve water quality. Strategies selected were: highlight problem areas and advise other regulatory agencies; push to create an interagency work group; support the Clean Water Act; task the CHPP steering committee to prioritize blue crab water quality impacts; send letters to other state agencies sharing concerns about water quality and Best Management Practices; invite other agencies to future MFC meetings to present their efforts to address water quality; and initiate public outreach on how to report crab and fish kills.
- 4) Crab spawning sanctuaries: Research has shown the existing crab spawning sanctuaries are largely ineffective due to their small size and that expanding the sanctuary system as well as establishing migration corridors will increase the number of mature females reaching the spawning grounds. The selected management strategy includes: maintain the current sanctuary boundaries for Oregon, Hatteras, and Ocracoke inlets; move the Drum Inlet sanctuary boundary to encompass Ophelia Inlet; expand the Barden Inlet sanctuary boundary; and designate new crab spawning sanctuaries around Beaufort, Bogue, Bear, Browns, New River, Topsail, Rich, Mason, Masonboro, Carolina Beach, Cape Fear River, Shallotte, Lockwood Folly, and Tubbs inlets. The new crab spawning sanctuaries will be closed from March 1 to October 31 with the same restrictions as previously existing sanctuaries.
- 5) Terrapin excluder devices: The bycatch of diamondback terrapins has been discussed in every blue crab FMP since 1998 with little action. To address this issue the selected management strategy is to study locally specific pot funnel designs to reduce terrapin bycatch in crab pots and to identify individual areas with diamondback terrapin hot spots that will be closed to pots unless a terrapin excluder device is used.
- 6) Bottom disturbing gear: To reduce the habitat impacts from the blue crab fishery, the use of bottom disturbing gear, specifically dredges and trawls, was examined. The selected management strategy includes: retain the prohibition on targeted crab dredging established in the 2016 Revision to Amendment 2; reduce the crab bycatch limit from oyster dredges to 10% of the combined crab and oyster catch or 100 pounds, whichever is less; and to prohibit the use of crab trawls in areas where shrimp trawls are prohibited in the Pamlico, Pungo, and Neuse rivers.

From: [Klibansky, Lara](#)
To: [Bizzell, Rob](#); [Blanton, Mike](#); [Cross, Doug](#); [Kornegay, K](#); [Posey, Martin H](#); [Hendrickson, Tom](#); [McNeill, Robert](#); [Romano, Sam](#)
Cc: [Maier, Shawn](#); [Gillikin, Dana](#); [Murphey, Steve](#)
Subject: Comments on Blue Crab FMP
Date: Tuesday, December 31, 2019 10:08:24 AM

Good morning, Chairman Bizzell and commissioners,

Director Murphey asked me to share with you the following comments he received from Ken Seigler regarding the Blue Crab Fishery Management Plan (FMP) Amendment 3. Just as a reminder, you'll be taking a vote on final action for this FMP at your February business meeting in New Bern. Please let me know if you have any questions.

-----Begin Comments-----

"NC Division Marine Fisheries
Steve Murphy, Director

Re: NC Blue Crab Fishery Management Plan (two issues)

Issue One;

Fishery Management Plan (FMP) proposed rules place southern areas of the state at significant economic disadvantage vs. northern areas. Proposed northern area closure for crabs would occur January 1 thru January 30. Proposed southern area closure for crabs would occur March 1 thru March 15. The crab pot cleanup period (15A NCAC 03J .0301) January 15 thru February 7 would be eliminated from the rules.

Southern area closure would occur just as markets begin to open and become active as the spring crab season normally begins. Northern areas will be harvesting for 6 weeks prior to southern areas reopening March 16. Very few markets would remain accessible to southern crab fishermen as northern crab fishermen flood markets with product.

Eliminating the crab pot cleanup period would result in fewer harmful ghost pots removed from the waters.

Splitting enforcement duties (north/south) could result in higher enforcement cost, and potential conflicts/confusion with product crossing from open areas into closed areas.

By current rule 15A NCAC 03J .0301, all crab pots must be removed from the waters statewide January 15, beginning pot cleanup period. Normal routine enforcement would do a fly-over to check for derelict pots and none compliance, very expensive undertaking. With areas reported as being clear of pots, the fisheries director may then reopen the crab pot fishery January 19. Four days is very little time allotted for groups like Coastal Federation and the ghost pot removal program.

If we must have closure to achieve reductions required for the FMP, it would be more practical to close all state waters at one time, giving all fishers the same market opportunities, conservation groups ample opportunity to carry out their work, and save a load of money on the very expensive legislative rule making process and potential budgetary windfall for DMF in the process.

To resolve this issues, NC Marine Fisheries Commission should use it's authority to suspend portions of rule 15A NCAC 03J .0301 (a) 1) "The Fisheries Director may, by proclamation, reopen various waters to the use of pots after January 19 if it is determined that such waters are free of pots."

Result would be a three week closure in which all crab pots would be removed from state waters January 15 thru February 7.

- FMP harvest reductions achieved
- conservation groups have ample time to complete ghost pot removal
- all fishers have far and equal market access
- statewide closure, less potential for compliance conflicts across boundaries
- no air plane compliance flyovers needed, DMF budgetary windfall
- no exhaustively expensive rule making process required

Issue Two;

Currently, mature female crabs less than five inches (hickory sooks) are sold as cull crabs to processors as there is no live or fresh market value. These crabs are routinely discarded during processing due to minimal meat yield, ultimately resulting in lower returns to fishermen for processed crabs.

Additionally, reports of processors mixing local product with imported product should raise significant concerns for both fishermen and consumers.

With the ability to compete on an international trade stage at risk, resolution must be met head on by industry, selling small crabs having minimal yield to be processed is no longer an option.

A minimum harvest size of five inches for male and female crabs with exception for peeler crabs should be instituted.

Thank you for your time, your consideration is greatly appreciated.

Kenneth M. Seigler"

-----End Comments-----

Wishing you all a happy new year.

Best,
Lara

Lara K. J. Klibansky
Executive Assistant for Councils and Commissions
Marine Fisheries Commission Liaison
NC Division of Marine Fisheries
Department of Environmental Quality



252 808 8021 office (direct)

252 726 7021 main

Lara.Klibansky@ncdenr.gov

P.O. Box 769
3441 Arendell Street
Morehead City, NC 28557

*Email correspondence to and from this address is subject to the
North Carolina Public Records Law and may be disclosed to third parties*

*DELINEATION
OF FISHING
WATERS*



TOWN OF KILL DEVIL HILLS

Post Office Box 1719, 102 Town Hall Drive
Kill Devil Hills, North Carolina 27948
252-449-5300
www.kdhnc.com

January 28, 2020

North Carolina Wildlife Resources Commission
c/o Betsy Haywood
Mail Service Center 1701
Raleigh, NC 27699-1701

**Mayor
BENJAMIN A. SPROUL**

**Mayor Pro Tem
IVY RAY INGRAM**

**Commissioners
TERRY L. GRAY
BERNARD B. MCAVOY, JR.
JOHN L. WINDLEY**

**Town Manager
DEBORA P. DIAZ**

**Assistant Town Manager
SHAWN R. MURPHY**

**Town Clerk
MARY E. QUIDLEY**

**Town Attorney
CASEY C. VARNELL**

North Carolina Marine Fisheries Commission
c/o Nancy Fish
N.C. Division of Marine Fisheries
3441 Arendell Street
Morehead City, NC 28557

Dear Commission Members,

At its January 13, 2020, meeting, the Kill Devil Hills Board of Commissioners adopted the following resolution:

Resolution Opposing Reclassification of Jurisdictional Waters

A copy is included for reference. Thank you for your continued service to the citizens of Kill Devil Hills and North Carolina.

Sincerely,


Ben Sproul,
Mayor

Encl.

- c: Honorable Roy Cooper, Governor
- Honorable Bob Steinburg, N.C. Senate
- Honorable Bobby Hanig, N.C. House of Representatives
- Dare County Board of Commissioners
- Duck Town Council
- Southern Shores Town Council
- Kitty Hawk Town Council
- Nags Head Board of Commissioners
- Manteo Board of Commissioners
- Kill Devil Hills Board of Commissioners
- file



TOWN OF KILL DEVIL HILLS

Land Where Flight Began

RESOLUTION OPPOSING RECLASSIFICATION OF JURISDICTIONAL WATERS

WHEREAS, in January of 2019, the N.C. Marine Fisheries Commission (MFC) and the N.C. Wildlife Resources Commission (WRC) formed a joint committee for the purpose of determining boundaries defining inland and coastal waters; and

WHEREAS, the joint committee had its last meeting in May of 2019, after having disagreements between the agencies of the “salinity value” to determine boundaries; and

WHEREAS, in August of 2019, the WRC business meeting was held with little direct notice to the MFC or to the N.C. Department of Environmental Quality (NCDEQ). At this meeting the WRC decided to move forward with the proposed boundaries based on the arbitrary 2.6 ppt. salinity value;” and

WHEREAS, in 2017 the MFC conducted a review of rules pertaining to delineation (15A NCAC 03Q.0200 et seq.) and determined there was no basis to adjust jurisdictional boundaries; and

WHEREAS, the proposed Reclassification of Jurisdictional Waters would be a loss of approximately 144,984 square acres or 226.5 square miles of coastal and commercial fishing waters. Thus, creating even more confusion and regulations to the already over-regulated N.C. commercial fishing industry; and

WHEREAS, the MFC would be required by law to perform a comprehensive financial analysis to modify jurisdictional boundaries, which would include a review of all existing rules and a detailed mapping effort expected to take over a year to complete with added costs to the taxpayers of North Carolina; and

WHEREAS, the financial impact as proposed would exceed \$1,000,000.00 for sustainable economic impact as prescribed in the N.C. Administrative Procedure Act; and

WHEREAS, fisheries management plans of important commercial and recreational species under MFC authority follow a criterion initially to establish coastal and joint waters but not inland waters, thus a complete review of all MFC rules would have to be completed at N.C. Taxpayer expense.


THEREFORE, BE IT RESOLVED, that the Town of Kill Devil Hills Board of Commissioners strongly opposes the Reclassification of Jurisdictional Waters as prescribed by the N.C. Wildlife Resources Commission. Under such research we have not found where a Salinity Value is a determination of boundary lines between coastal and inland waterways.

Adopted this 13th day of January 2020

SEAL




James Michael O'Dell, Deputy Town Clerk


Ben Sproul, Mayor



Resolution
Opposing Reclassification of Jurisdictional Waters

WHEREAS, in January of 2019, the NC Marine Fisheries Commission (MFC) and the NC Wildlife Resources Commission (WRC) formed a joint committee for the purpose of determining boundaries defining inland and coastal waters; and

WHEREAS, the joint committee had its last meeting in May of 2019, after having disagreements between the agencies on the “salinity value” to determine boundaries; and

WHEREAS, in August of 2019, the WRC business meeting was held with little direct notice to the MFC or to the NC Department of Environmental Quality (NCDEQ). At this meeting the WRC decided to move forward with the proposed boundaries based on the arbitrary “2.6 ppt salinity value”; and

WHEREAS, in 2017 the MFC conducted a review of rules pertaining to delineation (15A NCAC 03Q .0200 et seq) and determined there was no basis to adjust jurisdictional boundaries; and

WHEREAS, the proposed Reclassification of Jurisdictional Waters would be a loss of approximately 144,984 square acres or 226.5 sq. miles of coastal and commercial fishing waters. Thus, creating even more confusion and regulations to the already over regulated NC commercial fishing industry; and

WHEREAS, the MFC would be required by law, to perform a comprehensive financial analysis to modify jurisdictional boundaries, which would include a review of all existing rules and a detailed mapping effort expected to take over a year to complete with added costs to the taxpayers of North Carolina; and

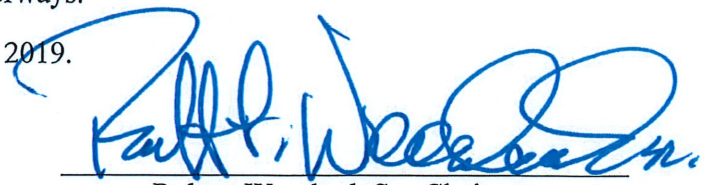
WHEREAS, the financial impact as proposed would exceed \$1,000,000.00 for sustainable economic impact as prescribed in the NC Administrative Procedure Act; and

WHEREAS, fisheries management plans of important commercial and recreational species under MFC authority follow a criterion initially to establish coastal and joint waters but not inland waters. Thus, a complete review of all MFC rules would have to be completed at NC taxpayer expense.

THEREFORE, BE IT RESOLVED, that the Dare County Board of Commissioners strongly opposes the Reclassification of Jurisdictional Waters as prescribed by the NC Wildlife Resources Commission. Under such research we have not found where a Salinity Value is a determination of boundary lines between coastal and inland waterways.

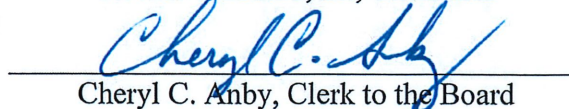
Adopted this the 18th day of November, 2019.





Robert Woodard, Sr., Chairman

Attest:



Cheryl C. Anby, Clerk to the Board

Board of Commissioners
William Smith, Chair
Robin Comer, Vice-Chair
Bob Cavanaugh
Jimmy Farrington
Mark Mansfield
Jonathan Robinson
Ed Wheatly



County Manager
Tommy R. Burns

Clerk to the Board
Rachel B. Hammer

RECEIVED
Office of the Secretary

JAN - 6 2020

December 17, 2019

Department of Environmental Quality

The Honorable Governor Roy Cooper
Office of the Governor
20301 Mail Service Center
Raleigh, NC 27699-0301

Dear Governor Cooper:

The Honorable Carteret County Board of Commissioners, while sitting in regular session on Monday, December 16, 2019, adopted the enclosed Resolution opposing the reclassification of jurisdictional waters.

The Carteret County Board of Commissioners reaffirms its unwavering commitment to North Carolina's commercial fishing industry and opposes any action that would create additional confusion and regulations of the industry.

On behalf of the Board of Commissioners, we would greatly appreciate your support.

Sincerely,

Rachel B. Hammer
Clerk to the Board

/rbh
Enclosure

copy: Senator Norman W. Sanderson
Representative Pat McElraft
Secretary Michael Regan, NCDEQ

Board of Commissioners
Mark Mansfield, Chair
Robin Comer, Vice-Chair
Bob Cavanaugh
Jimmy Farrington
Jonathan Robinson
Bill Smith
Ed Wheatly



County Manager
Tommy R. Burns

Clerk to the Board
Rachel B. Hammer

RESOLUTION OPPOSING RECLASSIFICATION OF JURISDICTIONAL WATERS

WHEREAS, in January of 2019, the North Carolina Marine Fisheries Commission (“MFC”) and the North Carolina Wildlife Resources Commission (“WRC”) formed a joint committee for the purpose of determining boundaries defining inland and coastal waters; and

WHEREAS, the joint committee had its last meeting in May of 2019, after having disagreements between the agencies on the “salinity value” to determine boundaries; and

WHEREAS, in August of 2019, the WRC business meeting was held with little direct notice to the MFC or to the North Carolina Department of Environmental Quality (“NCDEQ”). At this meeting, the WRC decided to move forward with the proposed boundaries based on the arbitrary “2.6 ppt salinity value;” and

WHEREAS, in 2017 the MFC conducted a review of rules pertaining to delineation (15A NCAC 03Q .0200 et seq) and determined there was no basis to adjust jurisdictional boundaries; and

WHEREAS, the proposed Reclassification of Jurisdictional Waters would be a loss of approximately 144,984 square acres or 226.5 square miles of coastal and commercial fishing waters. Thus, creating even more confusion and regulations to the already over-regulated North Carolina commercial fishing industry; and

WHEREAS, the MFC would be required by law, to perform a comprehensive financial analysis to modify jurisdictional boundaries, which would include a review of all existing rules and a detailed mapping effort expected to take over a year to complete with added costs to the taxpayers of North Carolina; and

WHEREAS, the financial impact as proposed would exceed \$1,000,000.00 for sustainable economic impact as prescribed in the North Carolina Administrative Procedure Act; and

WHEREAS, fisheries management plans of important commercial and recreational species under MFC authority follow a criterion initially to establish coastal and joint waters, but no inland waters. Thus, a complete review of all MFC rules would have to be completed at North Carolina taxpayer expense.

THEREFORE, BE IT RESOLVED that the Carteret County Board of Commissioners strongly opposes the Reclassification of Jurisdictional Waters as prescribed by the North Carolina Wildlife Resources Commission. Under such research we have not found where a salinity value is a determination of boundary lines between coastal and inland waters.

ADOPTED, this the 16th day of December 2019.

Mark Mansfield

Mark Mansfield
Chairman

ATTEST

Rachel Hammer

Rachel Hammer
Clerk to Commissioners





**RESOLUTION
OPPOSING RECLASSIFICATION OF JURISDICTIONAL WATERS**

WHEREAS, in January of 2019 the NC Marine Fisheries Commission (MFC) and the NC Wildlife Resources Commission (WRC) formed a joint committee for the purpose of determining boundaries defining inland and coastal waters; and

WHEREAS, the joint committee had its last meeting in May of 2019, after having disagreements between the agencies on the "salinity value" to determine boundaries; and

WHEREAS, in August of 2019, the WRC business meeting was held with little direct notice to the MFC or to the NC Department of Environmental Quality (NCDEQ). At this meeting the WRC decided to move forward with the proposed boundaries based on the arbitrary "2.6 ppt salinity value"; and

WHEREAS, in 2017 the MFC conducted a review of rules pertaining to delineation (15A NCAC 03Q.0200 et seq) and determined there was no basis to adjust jurisdictional boundaries; and

WHEREAS, the proposed Reclassification of Jurisdictional Waters would be a loss of approximately 144,984 square acres of 226.5 square miles of coastal and commercial fishing waters. Thus, creating even more confusion and regulations to the already over-regulated NC commercial fishing industry; and

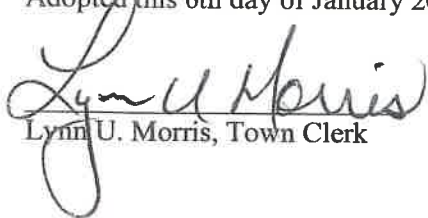
WHEREAS, the MFC would be required by law to perform a comprehensive financial analysis to modify jurisdictional boundaries, which would include a review of all existing rules and a detailed mapping effort expected to take over a year to complete with added costs to the taxpayers of North Carolina; and

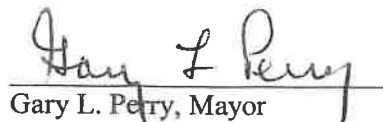
WHEREAS, the financial impact as proposed would exceed \$1,000,000.00 for sustainable economic impact as prescribed in the NC Administrative Procedure Act; and

WHEREAS, fisheries management plans of important commercial and recreational species under MFC authority follow a criterion initially to establish coastal and joint waters but not inland waters, thus a complete review of all MFC rules would have to be completed at NC taxpayer expense.

THEREFORE, BE IT RESOLVED, that the Kitty Hawk Town Council strongly opposes the reclassification of Jurisdictional Waters as prescribed by the NC Wildlife Resources Commission. Under such research we have not found where a salinity value is a determination of boundary lines between coastal and inland waterways.

Adopted this 6th day of January 2020.


Lynn U. Morris, Town Clerk


Gary L. Petty, Mayor

FLOUNDER

From: [Klibansky, Lara](#)
To: [Gillikin, Dana](#)
Subject: FW: [External] Flounder
Date: Monday, November 18, 2019 4:38:04 PM

From: Bizzell, Rob <r.bizzell.mfc@ncdenr.gov>
Sent: Monday, November 18, 2019 4:26 PM
To: Klibansky, Lara <Lara.Klibansky@ncdenr.gov>
Subject: Fwd: [External] Flounder

Next book
Get [Outlook for iOS](#)

From: Bryan Shoffner
Sent: Monday, November 18, 2019 4:11 PM
To: Bizzell, Rob
Subject: [External] Flounder

CAUTION: External email. Do not click links or open attachments unless you verify. Send all suspicious email as an attachment to report.spam@nc.gov

Dear Mr. Bizzell,

Went fishing at Nags Head back in October. Sad to learn no Flounder could be kept. Yet commercial fishing boats can with no restriction? I'll admit, I am not well informed but this just doesnt seem at all fair. How did the committee reach this decision? And do the two "at large" members have any affiliation with the commercial fishing industry?

Thanks, Bryan

From: [Klibansky, Lara](#)
To: [Blanton, Mike](#); [McNeill, Robert](#); [Posey, Martin H](#); [Cross, Doug](#); [Hendrickson, Tom](#)
Cc: [Bizzell, Rob](#); [Kornegay, K](#); [Maier, Shawn](#); [Gillikin, Dana](#)
Subject: FW: [External] Flounder and Public Involvement
Date: Thursday, December 19, 2019 10:44:24 AM

Good morning, Commissioners,

Per his request, I am forwarding you an email from Dave Timpy which you'll see below..

Wishing you a happy holiday season!

Lara

From: Dave Timpy [REDACTED]
Sent: Thursday, December 19, 2019 8:38:31 AM
To: Bizzell, Rob <r.bizzell.mfc@ncdenr.gov>; Boltres, C <c.boltres.mfc@ncdenr.gov>; Kornegay, K <j.kornegay.mfc@ncdenr.gov>
Subject: [External] Flounder and Public Involvement

CAUTION: External email. Do not click links or open attachments unless you verify. Send all suspicious email as an attachment to report_spam@nc.gov

Just wanted to shout out to ya's about the outstanding work by Mike Loeffler. I recently submitted online comments on southern flounder but had many questions prior to submitting. Mike was very helpful and answered all my questions plus provided some interesting papers referenced in the scoping documents. Give him a big raise! I have all the confidence that this MFC and it's staff will arrive at a fair and reasonable decision on this very complicated issued.

Also, I really like the online comment method being used. I tried to get folks to comment, it only takes 10 minutes, but you know how that goes.

Please feel free to share with the other commission members and staff.

Happy Holidays!

Dave Timpy
[REDACTED]

MAFMC



**NORTH CAROLINA MARINE FISHERIES COMMISSION
DEPARTMENT OF ENVIRONMENTAL QUALITY**

COMMISSIONERS

ROY COOPER
Governor

MICHAEL S. REGAN
Secretary

ROB BIZZELL
Chairman

MIKE BLANTON
Elizabeth City
DOUG CROSS
Grantsboro
TOM HENDRICKSON
Zebulon

PETE KORNEGAY
Camden
DR. MARTIN POSEY
Wilmington
ROBERT McNEILL
Wilmington
SAM ROMANO
Wilmington

Jan. 3, 2020

Mr. Francis (Dewey) Hemilright

Dear Mr. Hemilright,

The U.S. Secretary of Commerce will request that Governor Cooper submit the names of qualified candidates to be considered for an obligatory appointment to the Mid-Atlantic Fishery Management Council (Council) in August 2020. The N.C. Marine Fisheries Commission is responsible for compiling a list of nominees for the governor’s consideration. At its Nov. 13-15, 2019 business meeting, the commission reviewed information from candidates interested in an appointment to the council. Your name was among those selected by the commission for submission to Governor Cooper as a nominee for an appointment to the council.

Each council nominee is required to complete nomination materials provided by the National Marine Fisheries Service. Your nomination materials are attached and are also available in fillable, .pdf format at: <https://www.fisheries.noaa.gov/national/partners/council-nomination-process-guidance> . All forms must be completed in detail in order for you to be considered for an appointment. Please complete the forms and return no later than Feb. 7, 2020 to: Chris Batsavage, N.C. Division of Marine Fisheries, P.O. Box 769, Morehead City, NC 28557. The division will review your forms for completeness and forward them to the governor’s office for submission to the National Marine Fisheries Service by March 15, 2020.

I wish to congratulate you on your selection by the commission as a nominee for an obligatory appointment to the Mid-Atlantic Fishery Management Council. Please feel free to contact Mr. Batsavage by phone at 252-808-8009 or by email at chris.batsavage@ncdenr.gov if you need additional information concerning the nomination process.

Sincerely,

W. Robert Bizzell, Chairman
N.C Marine Fisheries Commission

WRB:cb:lk

Cc: John Nicholson Steve Murphey John Lucey
Lara Klibansky Chris Batsavage



**NORTH CAROLINA MARINE FISHERIES COMMISSION
DEPARTMENT OF ENVIRONMENTAL QUALITY**

COMMISSIONERS

ROY COOPER
Governor

MICHAEL S. REGAN
Secretary

ROB BIZZELL
Chairman

MIKE BLANTON
Elizabeth City
DOUG CROSS
Grantsboro
TOM HENDRICKSON
Zebulon

PETE KORNEGAY
Camden
DR. MARTIN POSEY
Wilmington
ROBERT McNEILL
Wilmington
SAM ROMANO
Wilmington

Jan. 3, 2020

Mr. Brent Fulcher

Dear Mr. Fulcher,

The U.S. Secretary of Commerce will request that Governor Cooper submit the names of qualified candidates to be considered for an obligatory appointment to the Mid-Atlantic Fishery Management Council (Council) in August 2020. The N.C. Marine Fisheries Commission is responsible for compiling a list of nominees for the governor’s consideration. At its Nov. 13-15, 2019 business meeting, the commission reviewed information from candidates interested in an appointment to the council. Your name was among those selected by the commission for submission to Governor Cooper as a nominee for an appointment to the council.

Each council nominee is required to complete nomination materials provided by the National Marine Fisheries Service. Your nomination materials are attached and are also available in fillable, .pdf format at: <https://www.fisheries.noaa.gov/national/partners/council-nomination-process-guidance> . All forms must be completed in detail in order for you to be considered for an appointment. Please complete the forms and return no later than Feb. 7, 2020 to: Chris Batsavage, N.C. Division of Marine Fisheries, P.O. Box 769, Morehead City, NC 28557. The division will review your forms for completeness and forward them to the governor’s office for submission to the National Marine Fisheries Service by March 15, 2020.

I wish to congratulate you on your selection by the commission as a nominee for an obligatory appointment to the Mid-Atlantic Fishery Management Council. Please feel free to contact Mr. Batsavage by phone at 252-808-8009 or by email at chris.batsavage@ncdenr.gov if you need additional information concerning the nomination process.

Sincerely,

W. Robert Bizzell, Chairman
N.C Marine Fisheries Commission

WRB:cb:lk

Cc: John Nicholson Steve Murphey John Lucey
Lara Klibansky Chris Batsavage



**NORTH CAROLINA MARINE FISHERIES COMMISSION
DEPARTMENT OF ENVIRONMENTAL QUALITY**

COMMISSIONERS

ROY COOPER
Governor

MICHAEL S. REGAN
Secretary

ROB BIZZELL
Chairman

MIKE BLANTON
Elizabeth City
DOUG CROSS
Grantsboro
TOM HENDRICKSON
Zebulon

PETE KORNEGAY
Camden
DR. MARTIN POSEY
Wilmington
ROBERT McNEILL
Wilmington
SAM ROMANO
Wilmington

Jan. 3, 2020

Robert L. Ruhle

Dear Mr. Ruhle,

The U.S. Secretary of Commerce will request that Governor Cooper submit the names of qualified candidates to be considered for an obligatory appointment to the Mid-Atlantic Fishery Management Council (Council) in August 2020. The N.C. Marine Fisheries Commission is responsible for compiling a list of nominees for the governor’s consideration. At its Nov. 13-15, 2019 business meeting, the commission reviewed information from candidates interested in an appointment to the council. Your name was among those selected by the commission for submission to Governor Cooper as a nominee for an appointment to the council.

Each council nominee is required to complete nomination materials provided by the National Marine Fisheries Service. Your nomination materials are attached and are also available in fillable, .pdf format at: <https://www.fisheries.noaa.gov/national/partners/council-nomination-process-guidance> . All forms must be completed in detail in order for you to be considered for an appointment. Please complete the forms and return no later than Feb. 7, 2020 to: Chris Batsavage, N.C. Division of Marine Fisheries, P.O. Box 769, Morehead City, NC 28557. The division will review your forms for completeness and forward them to the governor’s office for submission to the National Marine Fisheries Service by March 15, 2020.

I wish to congratulate you on your selection by the commission as a nominee for an obligatory appointment to the Mid-Atlantic Fishery Management Council. Please feel free to contact Mr. Batsavage by phone at 252-808-8009 or by email at chris.batsavage@ncdenr.gov if you need additional information concerning the nomination process.

Sincerely,

W. Robert Bizzell, Chairman
N.C Marine Fisheries Commission

WRB:cb:lk

Cc: John Nicholson Steve Murphey John Lucey
Lara Klibansky Chris Batsavage

*NORTH CAROLINA
WILDLIFE
FEDERATION*



North Carolina Wildlife Federation

Affiliated with the National Wildlife Federation

1346 St. Julien St
Charlotte, NC 28205
(704) 332-5696

1024 Washington St.
Raleigh, NC 27605
(919) 833-1923

RESOLUTION

Consolidation of the North Carolina Division of Marine Fisheries into the North Carolina Wildlife Resources Commission to Eliminate Redundancy and Improve Natural Resource Management Efficacy

WHEREAS, North Carolina is blessed with abundant, diverse, and valuable fish and wildlife resources that serve to enhance the quality and standard of life for all citizens, including the state’s heritage, culture, human and ecosystem health, and economic well-being; and,

WHEREAS, existence of these resources places a solemn duty and responsibility on government to properly manage and protect public trust resources in the most effective and efficient way possible for the interest of the resource and on behalf of all the citizens of the state; and,

WHEREAS, efficiency and efficacy are critical aspects of any professional natural resource management program; and,

WHEREAS, the North Carolina Wildlife Federation was formed in 1945 on the premise that fish and wildlife conservation programs must be conducted and managed in a manner that prioritizes the resource and is representative of citizens who value, utilize, and enjoy these resources through outdoor recreational activities; and,

WHEREAS, the North Carolina Wildlife Federation was instrumental in the establishment of the North Carolina Wildlife Resources Commission (“WRC”) in 1947, whose purpose by Statute Article #143-239 is to “manage, restore, develop, cultivate, conserve, protect, and regulate the wildlife resources of the State of North Carolina”; and,

WHEREAS, historically, in a time of exceptional abundance of marine fishery stocks, the management of marine fishes was set aside to a separate agency, originally called the Office of Commercial Fisheries, to allocate harvests at maximum levels for commercial purposes with little regard for protecting breeding stocks to replenish future fisheries; and,

WHEREAS, over the past 25 years, the levels of marine fish stocks have diminished dramatically due to overharvest allowed by permissive regulations of the North Carolina Marine Fisheries Commission (“MFC”) that have been inadequate to protect the stocks from overharvest; and,

WHEREAS, since the North Carolina Division of Marine Fisheries (“DMF”) has never had adequate budgetary or policy support from its parent agency (currently the NC Department of Environmental Quality), the administration, or the General Assembly, the programs and plans offered to manage marine fisheries stocks have always been too little, too late, leading to the significant decline in marine fisheries experienced in North Carolina today; and,

WHEREAS, the missions of the WRC and DMF to protect and enhance the public trust natural resources and habitats of North Carolina are closely aligned but create areas of duplication, redundancy, uncertainty, and inefficiency as indicated by the partial list presented here:

- Artificial, arbitrary and burdensome designation of coastal, joint, and inland waters on every coastal tributary with different jurisdictions, rules, and enforcement on each body of water without any obvious beneficial purpose, occupying significant personnel resources for the adoption of Joint Rules by each agency, the publication of hundreds of Rules in the NC Administrative Code.
- Separate law enforcement divisions to enforce the rules for each type of fishing waters, which in effect mandate that the same fishes swimming back and forth have different protection depending upon where they may be at any given time and often the officers of each agency may be patrolling the same waters monitoring different activities such as commercial and recreational fishing that often result in multiple checks of the same individual.
- Separate aerial units for WRC and DMF, each employing its own pilots and aircraft and separate communication systems and centers, and operators in different locations, often with duplicate radio repeaters on the same tower paying two rental fees, and duplicate recruitment and training programs for law enforcement officers.
- Separate administrative functions for each agency including: purchasing, printing, personnel management, license sales and record keeping, legal representation and Rule making, warehousing, and storage of uniforms and other assigned gear for enforcement and fishery management purposes, virtual technologies for public awareness and access.
- Separate governance by extensive boards of commissioners (WRC has 19 members and MFC has 9 members), which represents a large commitment of resources with no identifiable benefit other than political patronage, especially with regards to the MFC and the archaic, gubernatorial criteria of member appointments based on the economic segment of the industry they represent.

WHEREAS, a decision to consolidate the MFC and DMF with the WRC would increase effectiveness of the natural resource programs in North Carolina, while saving significant funds, reducing bureaucracy and enforcement issues, and eliminating public confusion.

NOW, THEREFORE, BE IT RESOLVED, by the North Carolina Wildlife Federation in official session this sixteenth day of November 2019, that for the reasons given herein that the consolidation of the MFC and DMF into the WRC would result in a more effective agency to manage and administer the fish, wildlife, and marine fisheries resources of North Carolina, and the provision of equitable access to public trust resources, enhancing livelihoods and recreation for participants by promoting the ability of fish and wildlife to reproduce and be maintained in a healthy state for the future.

BE IT FURTHER RESOLVED, that the North Carolina Wildlife Federation strongly recommends the consolidation of the MFC and DMF into the WRC to create one fish and wildlife agency as an efficiency measure to reduce wasteful, excessive duplication of responsibilities, programs, personnel, and services; to realize economies and efficiencies from consolidation; and to improve administrative, regulatory, and management efforts directed toward the public trust fish and wildlife resources of North Carolina.

RULE READOPTION



STATE OF NORTH CAROLINA
OFFICE OF ADMINISTRATIVE HEARINGS

Mailing address:
6714 Mail Service Center
Raleigh, NC 27699-6714

Street address:
1711 New Hope Church Rd
Raleigh, NC 27609-6285

January 16, 2020

Jennifer Everett, Rulemaking Coordinator
Marines Fisheries Commission
Commission for Public Health
1601 Mail Service Center
Raleigh, North Carolina 27699-1601

Re: Readoption pursuant to G.S. 150B-21.3A(c)(2)g of **15A NCAC 18A (.0100, .0300-.0900, .3400)**

Dear Ms. Everett:

Attached to this letter are the rules subject to readoption pursuant to the periodic review and expiration of existing rules as set forth in G.S. 150B-21.3A(c)(2)g. After consultation with your agency, this set of rules was discussed at the January 16, 2020 Rules Review Commission meeting regarding the scheduling of these rules for readoption. Pursuant to G.S. 150B-21.3A(d)(2), the rules identified on the attached document shall be readopted by the agency no later than June 30, 2024.

If you have any questions regarding the Commission's action, please let me know.

Sincerely,

Amber May
Commission Counsel

Administration
919/431-3000
fax: 919/431-3100

Rules Division
919/431-3000
fax: 919/431-3104

Judges and
Assistants
919/431-3000
fax: 919/431-3100

Clerk's Office
919/431-3000
fax: 919/431-3100

Rules Review
Commission
919/431-3000
fax: 919/431-3104

Civil Rights
Division
919/431-3036
fax: 919/431-3103

An Equal Employment Opportunity Employer

**RRC DETERMINATION
PERIODIC RULE REVIEW
January 17, 2019
APO Review: March 24, 2019
Marine Fisheries Commission
Total: 164**

RRC Determination: Necessary with substantive public interest

Rule	Determination
<u>15A NCAC 18A .0134</u>	Necessary with substantive public interest
<u>15A NCAC 18A .0135</u>	Necessary with substantive public interest
<u>15A NCAC 18A .0136</u>	Necessary with substantive public interest
<u>15A NCAC 18A .0137</u>	Necessary with substantive public interest
<u>15A NCAC 18A .0138</u>	Necessary with substantive public interest
<u>15A NCAC 18A .0139</u>	Necessary with substantive public interest
<u>15A NCAC 18A .0140</u>	Necessary with substantive public interest
<u>15A NCAC 18A .0141</u>	Necessary with substantive public interest
<u>15A NCAC 18A .0142</u>	Necessary with substantive public interest
<u>15A NCAC 18A .0143</u>	Necessary with substantive public interest
<u>15A NCAC 18A .0144</u>	Necessary with substantive public interest
<u>15A NCAC 18A .0145</u>	Necessary with substantive public interest
<u>15A NCAC 18A .0146</u>	Necessary with substantive public interest
<u>15A NCAC 18A .0147</u>	Necessary with substantive public interest
<u>15A NCAC 18A .0148</u>	Necessary with substantive public interest
<u>15A NCAC 18A .0149</u>	Necessary with substantive public interest
<u>15A NCAC 18A .0150</u>	Necessary with substantive public interest
<u>15A NCAC 18A .0151</u>	Necessary with substantive public interest
<u>15A NCAC 18A .0152</u>	Necessary with substantive public interest
<u>15A NCAC 18A .0153</u>	Necessary with substantive public interest
<u>15A NCAC 18A .0154</u>	Necessary with substantive public interest
<u>15A NCAC 18A .0155</u>	Necessary with substantive public interest
<u>15A NCAC 18A .0156</u>	Necessary with substantive public interest
<u>15A NCAC 18A .0157</u>	Necessary with substantive public interest
<u>15A NCAC 18A .0158</u>	Necessary with substantive public interest
<u>15A NCAC 18A .0159</u>	Necessary with substantive public interest
<u>15A NCAC 18A .0160</u>	Necessary with substantive public interest
<u>15A NCAC 18A .0161</u>	Necessary with substantive public interest
<u>15A NCAC 18A .0162</u>	Necessary with substantive public interest
<u>15A NCAC 18A .0163</u>	Necessary with substantive public interest
<u>15A NCAC 18A .0164</u>	Necessary with substantive public interest
<u>15A NCAC 18A .0165</u>	Necessary with substantive public interest
<u>15A NCAC 18A .0166</u>	Necessary with substantive public interest



**NORTH CAROLINA MARINE FISHERIES COMMISSION
DEPARTMENT OF ENVIRONMENTAL QUALITY**

COMMISSIONERS

ROY COOPER
Governor

MICHAEL S. REGAN
Secretary

ROB BIZZELL
Chairman

MIKE BLANTON
Elizabeth City

DOUG CROSS
Grantsboro

TOM HENDRICKSON
Zebulon

PETE KORNEGAY
Camden

ROBERT McNEILL
Wilmington

DR. MARTIN POSEY
Wilmington

SAM ROMANO
Wilmington

Jan. 7, 2020

Jeffery T. Hyde, Chair
N.C. Rules Review Commission
N.C. Office of Administrative Hearings – Rules Division
1711 New Hope Church Rd.
Raleigh, NC 27609

Dear Chairman Hyde:

North Carolina General Statute 150B-21.3A(c) requires each agency to conduct a review of all its rules at least once every 10 years in accordance with a prescribed process of reporting and readoption. Once the final determination report becomes effective, N.C.G.S. 150B-21.3A(d)(2) requires the Rules Review Commission (RRC) to establish a date by which an agency must readopt its rules after consultation with the agency and consideration of the agency's rulemaking priorities in establishing the readoption date.

An evaluation of the rules under the authority of the Marine Fisheries Commission (MFC) was undertaken in two lots (see Figure 1.) The MFC has 211 rules in 15A NCAC 03, of which 172 are subject to readoption, and 164 rules in 15A NCAC 18A, Sections .0100, .0300-.0900, and .3400 that regulate shellfish sanitation and recreational water quality processes that are also subject to readoption. At its June 14, 2018 meeting, the RRC approved the schedule for readoption of the rules in Chapter 03 to be completed by June 30, 2022; readoption of these rules is underway within the four-year schedule.

Rules	2017	2018	2019	2020	2021	2022	2023	2024
Chapter 03 (172 rules)	Report	41 Rules Readopted	Rule Readoption (131)			6/30/22 deadline		
Subchapter 18A (164 rules)			Report	Rule Readoption (164)				6/30/24 deadline

Figure 1. Marine Fisheries Commission rule readoption schedule to comply with G.S. 150B-21.3A, Periodic Review and Expiration of Existing Rules.

This letter is in regard to the 164 rules in 15A NCAC 18A for which the MFC needs to schedule readoption per G.S. 150B-21.3A(d)(2). All rules were determined to be necessary with substantive public interest. The corresponding RRC determinations are attached.

At its Nov. 15, 2019 business meeting, the MFC approved a recommended schedule for re-adoption of the 164 rules in 15A NCAC 18A to be completed by June 30, 2024. In approving the re-adoption schedule, the MFC considered its rulemaking priorities:

- The MFC has 164 rules subject to re-adoption in 15A NCAC 18A, a relatively large number.
- The MFC strives to undertake a single package of rules each year to assist stakeholders with anticipating changes and making informed decisions about continued participation in various fisheries based on those rule changes. The MFC generally meets quarterly, providing only four opportunities per year to take action on rules.
- The MFC is currently in the process of re-adopting another 172 rules in 15A NCAC 03 and there is interplay between the two groups of rules, adding complexity to the re-adoption process.
- The MFC has a diverse group of stakeholders affected by the wide variety of issues regulated by these rules. By nature of managing a limited natural resource, the rules are generally controversial.

A deadline of June 30, 2024 would provide a concurrent four-year schedule within which the MFC would undertake re-adoption of an average of 41 rules per year. The schedule also accommodates the requirement to develop fiscal analyses of proposed rules that have substantive changes for approval by the Office of State Budget and Management.

For these reasons, the MFC requests a schedule for re-adoption of its 164 rules in 15A NCAC 18A to be completed by June 30, 2024. Pending approval of this request, the process of rule re-adoption is scheduled to begin at the MFC's May 2020 business meeting.

Sincerely,



W. Robert Bizzell, Chairman
N.C Marine Fisheries Commission

Attachment

cc: Stephen W. Murphey, N.C. Division of Marine Fisheries Director

WRB/cb

**RRC DETERMINATION
PERIODIC RULE REVIEW
January 17, 2019
APO Review: March 24, 2019
Marine Fisheries Commission
Total: 164**

RRC Determination: Necessary with substantive public interest

Rule	Determination
<u>15A NCAC 18A .0134</u>	Necessary with substantive public interest
<u>15A NCAC 18A .0135</u>	Necessary with substantive public interest
<u>15A NCAC 18A .0136</u>	Necessary with substantive public interest
<u>15A NCAC 18A .0137</u>	Necessary with substantive public interest
<u>15A NCAC 18A .0138</u>	Necessary with substantive public interest
<u>15A NCAC 18A .0139</u>	Necessary with substantive public interest
<u>15A NCAC 18A .0140</u>	Necessary with substantive public interest
<u>15A NCAC 18A .0141</u>	Necessary with substantive public interest
<u>15A NCAC 18A .0142</u>	Necessary with substantive public interest
<u>15A NCAC 18A .0143</u>	Necessary with substantive public interest
<u>15A NCAC 18A .0144</u>	Necessary with substantive public interest
<u>15A NCAC 18A .0145</u>	Necessary with substantive public interest
<u>15A NCAC 18A .0146</u>	Necessary with substantive public interest
<u>15A NCAC 18A .0147</u>	Necessary with substantive public interest
<u>15A NCAC 18A .0148</u>	Necessary with substantive public interest
<u>15A NCAC 18A .0149</u>	Necessary with substantive public interest
<u>15A NCAC 18A .0150</u>	Necessary with substantive public interest
<u>15A NCAC 18A .0151</u>	Necessary with substantive public interest
<u>15A NCAC 18A .0152</u>	Necessary with substantive public interest
<u>15A NCAC 18A .0153</u>	Necessary with substantive public interest
<u>15A NCAC 18A .0154</u>	Necessary with substantive public interest
<u>15A NCAC 18A .0155</u>	Necessary with substantive public interest
<u>15A NCAC 18A .0156</u>	Necessary with substantive public interest
<u>15A NCAC 18A .0157</u>	Necessary with substantive public interest
<u>15A NCAC 18A .0158</u>	Necessary with substantive public interest
<u>15A NCAC 18A .0159</u>	Necessary with substantive public interest
<u>15A NCAC 18A .0160</u>	Necessary with substantive public interest
<u>15A NCAC 18A .0161</u>	Necessary with substantive public interest
<u>15A NCAC 18A .0162</u>	Necessary with substantive public interest
<u>15A NCAC 18A .0163</u>	Necessary with substantive public interest
<u>15A NCAC 18A .0164</u>	Necessary with substantive public interest
<u>15A NCAC 18A .0165</u>	Necessary with substantive public interest
<u>15A NCAC 18A .0166</u>	Necessary with substantive public interest

SHRIMP

From: [Klibansky, Lara](#)
To: [Gillikin, Dana](#)
Subject: FW: Shrimp Bycatch Solution
Date: Wednesday, January 15, 2020 9:23:12 AM

From: Bizzell, Rob
Sent: Wednesday, January 15, 2020 9:22 AM
To: Klibansky, Lara <Lara.Klibansky@ncdenr.gov>
Subject: Fwd: Shrimp Bycatch Solution

For the books

Get [Outlook for iOS](#)

From: Hamilton, Cindi B <Cindi.Hamilton@ncdenr.gov>
Sent: Wednesday, January 15, 2020 8:14 AM
To: Murphey, Steve; Bizzell, Rob; Rawls, Kathy; Klibansky, Lara; Lupton, Dee; Stewart, Chris
Cc: West, Katy; Moore, Tina; Blum, Catherine; Rock, Jason; Harding, Kimberlee k
Subject: FW: Shrimp Bycatch Solution

I received Walt Mercer's note this morning and am sending to you. Thank you.
CINDI

From: Walt Mercer
Sent: Wednesday, January 15, 2020 6:07 AM
To: Hamilton, Cindi B <Cindi.Hamilton@ncdenr.gov>
Subject: [External] Shrimp Bycatch Solution

CAUTION: External email. Do not click links or open attachments unless you verify. Send all suspicious email as an attachment to report.spam@nc.gov

Very simple. Ban shrimp trawlers from our sounds. They can trawl outside the inlets.

Every other state on the seaboard does this and it has increased their shrimp harvest a created a recreational fishery that attracts tourist dollars.

But of course NC is politically corrupt and the NCDMF and politicians paid for by the seafood industry will never let this happen.

Shame on you all.

MFC ADVISORY COMMITTEES



**NORTH CAROLINA MARINE FISHERIES COMMISSION
DEPARTMENT OF ENVIRONMENTAL QUALITY**

COMMISSIONERS

ROY COOPER
Governor

MICHAEL S. REGAN
Secretary

ROB BIZZELL
Chairman

MIKE BLANTON
Elizabeth City
DOUG CROSS
Grantsboro
TOM HENDRICKSON
Zebulon

PETE KORNEGAY
Camden
DR. MARTIN POSEY
Wilmington
ROBERT McNEILL
Wilmington
SAM ROMANO
Wilmington

February 3, 2020

Ken Seigler



Dear Mr. Seigler:

I have reappointed you to the Finfish Advisory Committee. Please remember that you are required to attend 75 percent of the meetings of your committee. I would like to thank you for continuing to sacrifice your time and provide your input to help us effectively manage the marine resources of our state.

Sincerely,

A handwritten signature in cursive script that reads "W. Robert Bizzell".

W. Robert Bizzell, Chairman
N.C. Marine Fisheries Commission

WB/lk

cc: Lara Klibansky, Marine Fisheries Commission Liaison



**NORTH CAROLINA MARINE FISHERIES COMMISSION
DEPARTMENT OF ENVIRONMENTAL QUALITY**

COMMISSIONERS

ROY COOPER
Governor

MICHAEL S. REGAN
Secretary

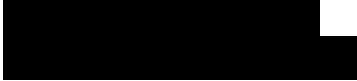
ROB BIZZELL
Chairman

MIKE BLANTON
Elizabeth City
DOUG CROSS
Grantsboro
TOM HENDRICKSON
Zebulon

PETE KORNEGAY
Camden
DR. MARTIN POSEY
Wilmington
ROBERT McNEILL
Wilmington
SAM ROMANO
Wilmington

February 3, 2020

Brian Boutin



Dear Mr. Boutin:

I have reappointed you to the Habitat and Water Quality Advisory Committee. Please remember that you are required to attend 75 percent of the meetings of your committee. I would like to thank you for continuing to sacrifice your time and provide your input to help us effectively manage the marine resources of our state.

Sincerely,

A handwritten signature in black ink that reads "W. Robert Bizzell".

W. Robert Bizzell, Chairman
N.C. Marine Fisheries Commission

WB/lk

cc: Lara Klibansky, Marine Fisheries Commission Liaison



**NORTH CAROLINA MARINE FISHERIES COMMISSION
DEPARTMENT OF ENVIRONMENTAL QUALITY**

COMMISSIONERS

ROY COOPER
Governor

MICHAEL S. REGAN
Secretary

ROB BIZZELL
Chairman

MIKE BLANTON
Elizabeth City
DOUG CROSS
Grantsboro
TOM HENDRICKSON
Zebulon

PETE KORNEGAY
Camden
DR. MARTIN POSEY
Wilmington
ROBERT McNEILL
Wilmington
SAM ROMANO
Wilmington

February 3, 2020

Mike Street
[REDACTED]

Dear Mr. Street:

I have reappointed you to the Habitat and Water Quality Advisory Committee. Please remember that you are required to attend 75 percent of the meetings of your committee. I would like to thank you for continuing to sacrifice your time and provide your input to help us effectively manage the marine resources of our state.

Sincerely,

A handwritten signature in black ink that reads "W. Robert Bizzell".

W. Robert Bizzell, Chairman
N.C. Marine Fisheries Commission

WB/lk

cc: Lara Klibansky, Marine Fisheries Commission Liaison



**NORTH CAROLINA MARINE FISHERIES COMMISSION
DEPARTMENT OF ENVIRONMENTAL QUALITY**

COMMISSIONERS

ROY COOPER
Governor

MICHAEL S. REGAN
Secretary

ROB BIZZELL
Chairman

MIKE BLANTON
Elizabeth City
DOUG CROSS
Grantsboro
TOM HENDRICKSON
Zebulon

PETE KORNEGAY
Camden
DR. MARTIN POSEY
Wilmington
ROBERT McNEILL
Wilmington
SAM ROMANO
Wilmington

February 3, 2020

Robert Christian



Dear Mr. Christian:

I have reappointed you to the Habitat and Water Quality Advisory Committee. Please remember that you are required to attend 75 percent of the meetings of your committee. I would like to thank you for continuing to sacrifice your time and provide your input to help us effectively manage the marine resources of our state.

Sincerely,

A handwritten signature in black ink that reads "W. Robert Bizzell".

W. Robert Bizzell, Chairman
N.C. Marine Fisheries Commission

WB/lk

cc: Lara Klibansky, Marine Fisheries Commission Liaison



**NORTH CAROLINA MARINE FISHERIES COMMISSION
DEPARTMENT OF ENVIRONMENTAL QUALITY**

COMMISSIONERS

ROY COOPER
Governor

MICHAEL S. REGAN
Secretary

ROB BIZZELL
Chairman

MIKE BLANTON
Elizabeth City
DOUG CROSS
Grantsboro
TOM HENDRICKSON
Zebulon

PETE KORNEGAY
Camden
DR. MARTIN POSEY
Wilmington
ROBERT McNEILL
Wilmington
SAM ROMANO
Wilmington

February 3, 2020

Jim Rice



Dear Mr. Rice:

I have reappointed you to the Northern Regional Advisory Committee. Please remember that you are required to attend 75 percent of the meetings of your committee. I would like to thank you for continuing to sacrifice your time and provide your input to help us effectively manage the marine resources of our state.

Sincerely,

A handwritten signature in cursive script that reads "W. Robert Bizzell".

W. Robert Bizzell, Chairman
N.C. Marine Fisheries Commission

WB/lk

cc: Lara Klibansky, Marine Fisheries Commission Liaison



**NORTH CAROLINA MARINE FISHERIES COMMISSION
DEPARTMENT OF ENVIRONMENTAL QUALITY**

COMMISSIONERS

ROY COOPER
Governor

MICHAEL S. REGAN
Secretary

ROB BIZZELL
Chairman

MIKE BLANTON
Elizabeth City
DOUG CROSS
Grantsboro
TOM HENDRICKSON
Zebulon

PETE KORNEGAY
Camden
DR. MARTIN POSEY
Wilmington
ROBERT McNEILL
Wilmington
SAM ROMANO
Wilmington

February 3, 2020

Floyd Layden


Dear Mr. Layden:

I would like to take this opportunity to thank you for serving on the Marine Fisheries Commission's Northern Advisory Committee. As you know, the Bylaws of the N.C. Marine Fisheries Commission require that all advisors attend at least 75 percent of all meetings annually. Records indicate you have not attended any of the committee meetings held in 2019. Unfortunately, as a result, you are being removed from the Northern Regional Advisory Committee.

Again, thank you for your service. If you have any questions regarding the commission's advisory committee process, please contact Lara Klibansky at 252-808-8021.

Sincerely,

A handwritten signature in black ink that reads "W. Robert Bizzell".

W. Robert Bizzell, Chairman
N.C. Marine Fisheries Commission

WB/lk

cc: Lara Klibansky, Marine Fisheries Commission Liaison



**NORTH CAROLINA MARINE FISHERIES COMMISSION
DEPARTMENT OF ENVIRONMENTAL QUALITY**

COMMISSIONERS

ROY COOPER
Governor

MICHAEL S. REGAN
Secretary

ROB BIZZELL
Chairman

MIKE BLANTON
Elizabeth City
DOUG CROSS
Grantsboro
TOM HENDRICKSON
Zebulon

PETE KORNEGAY
Camden
DR. MARTIN POSEY
Wilmington
ROBERT McNEILL
Wilmington
SAM ROMANO
Wilmington

February 3, 2020

Joseph Kavanagh


Dear Mr. Kavanagh:

I would like to take this opportunity to thank you for serving on the Marine Fisheries Commission's Northern Advisory Committee. As you know, the Bylaws of the N.C. Marine Fisheries Commission require that all advisors attend at least 75 percent of all meetings annually. Records indicate you have not attended any of the committee meetings held in 2019. Unfortunately, as a result, you are being removed from the Northern Regional Advisory Committee.

Again, thank you for your service. If you have any questions regarding the commission's advisory committee process, please contact Lara Klibansky at 252-808-8021.

Sincerely,



W. Robert Bizzell, Chairman
N.C. Marine Fisheries Commission

WB/lk

cc: Lara Klibansky, Marine Fisheries Commission Liaison



**NORTH CAROLINA MARINE FISHERIES COMMISSION
DEPARTMENT OF ENVIRONMENTAL QUALITY**

COMMISSIONERS

ROY COOPER
Governor

MICHAEL S. REGAN
Secretary

ROB BIZZELL
Chairman

MIKE BLANTON
Elizabeth City
DOUG CROSS
Grantsboro
TOM HENDRICKSON
Zebulon

PETE KORNEGAY
Camden
DR. MARTIN POSEY
Wilmington
ROBERT McNEILL
Wilmington
SAM ROMANO
Wilmington

February 3, 2020

Sam Liverman, Jr.



Dear Mr. Liverman:

I would like to take this opportunity to thank you for serving on the Marine Fisheries Commission's Northern Advisory Committee. As you know, the Bylaws of the N.C. Marine Fisheries Commission require that all advisors attend at least 75 percent of all meetings annually. Records indicate you have not attended any of the committee meetings held in 2019. Unfortunately, as a result, you are being removed from the Northern Regional Advisory Committee.

Again, thank you for your service. If you have any questions regarding the commission's advisory committee process, please contact Lara Klibansky at 252-808-8021.

Sincerely,

A handwritten signature in cursive script that reads "W. Robert Bizzell".

W. Robert Bizzell, Chairman
N.C. Marine Fisheries Commission

WB/lk

cc: Lara Klibansky, Marine Fisheries Commission Liaison



**NORTH CAROLINA MARINE FISHERIES COMMISSION
DEPARTMENT OF ENVIRONMENTAL QUALITY**

COMMISSIONERS

ROY COOPER
Governor

MICHAEL S. REGAN
Secretary

ROB BIZZELL
Chairman

MIKE BLANTON
Elizabeth City
DOUG CROSS
Grantsboro
TOM HENDRICKSON
Zebulon

PETE KORNEGAY
Camden
DR. MARTIN POSEY
Wilmington
ROBERT McNEILL
Wilmington
SAM ROMANO
Wilmington

February 3, 2020

Keith Bruno
[REDACTED]

Dear Mr. Bruno:

I have reappointed you to the Northern Regional Advisory Committee. Please remember that you are required to attend 75 percent of the meetings of your committee. I would like to thank you for continuing to sacrifice your time and provide your input to help us effectively manage the marine resources of our state.

Sincerely,

A handwritten signature in black ink, appearing to read "W. Robert Bizzell".

W. Robert Bizzell, Chairman
N.C. Marine Fisheries Commission

WB/lk

cc: Lara Klibansky, Marine Fisheries Commission Liaison



**NORTH CAROLINA MARINE FISHERIES COMMISSION
DEPARTMENT OF ENVIRONMENTAL QUALITY**

COMMISSIONERS

ROY COOPER
Governor


MICHAEL S. REGAN
Secretary

ROB BIZZELL
Chairman

MIKE BLANTON
Elizabeth City
DOUG CROSS
Grantsboro
TOM HENDRICKSON
Zebulon

PETE KORNEGAY
Camden
DR. MARTIN POSEY
Wilmington
ROBERT McNEILL
Wilmington
SAM ROMANO
Wilmington

February 3, 2020

Raymond Pugh


Dear Mr. Pugh:

I have reappointed you to the Northern Regional Advisory Committee. Please remember that you are required to attend 75 percent of the meetings of your committee. I would like to thank you for continuing to sacrifice your time and provide your input to help us effectively manage the marine resources of our state.

Sincerely,



W. Robert Bizzell, Chairman
N.C. Marine Fisheries Commission

WB/lk

cc: Lara Klibansky, Marine Fisheries Commission Liaison



**NORTH CAROLINA MARINE FISHERIES COMMISSION
DEPARTMENT OF ENVIRONMENTAL QUALITY**

COMMISSIONERS

ROY COOPER
Governor

MICHAEL S. REGAN
Secretary

ROB BIZZELL
Chairman

MIKE BLANTON
Elizabeth City
DOUG CROSS
Grantsboro
TOM HENDRICKSON
Zebulon

PETE KORNEGAY
Camden
DR. MARTIN POSEY
Wilmington
ROBERT McNEILL
Wilmington
SAM ROMANO
Wilmington

February 3, 2020

Sara Winslow
[REDACTED]

Dear Ms. Winslow:

I have reappointed you to the Northern Regional Advisory Committee. Please remember that you are required to attend 75 percent of the meetings of your committee. I would like to thank you for continuing to sacrifice your time and provide your input to help us effectively manage the marine resources of our state.

Sincerely,

A handwritten signature in black ink, appearing to read "W. Robert Bizzell".

W. Robert Bizzell, Chairman
N.C. Marine Fisheries Commission

WB/lk

cc: Lara Klibansky, Marine Fisheries Commission Liaison



**NORTH CAROLINA MARINE FISHERIES COMMISSION
DEPARTMENT OF ENVIRONMENTAL QUALITY**

COMMISSIONERS

ROY COOPER
Governor

MICHAEL S. REGAN
Secretary

ROB BIZZELL
Chairman

MIKE BLANTON
Elizabeth City
DOUG CROSS
Grantsboro
TOM HENDRICKSON
Zebulon

PETE KORNEGAY
Camden
DR. MARTIN POSEY
Wilmington
ROBERT McNEILL
Wilmington
SAM ROMANO
Wilmington

February 3, 2020

Brian Shepard
[REDACTED]

Dear Mr. Shepard:

I have reappointed you to the Shellfish/Crustacean Advisory Committee. Please remember that you are required to attend 75 percent of the meetings of your committee. I would like to thank you for continuing to sacrifice your time and provide your input to help us effectively manage the marine resources of our state.

Sincerely,

A handwritten signature in black ink, appearing to read "W. Robert Bizzell".

W. Robert Bizzell, Chairman
N.C. Marine Fisheries Commission

WB/lk

cc: Lara Klibansky, Marine Fisheries Commission Liaison



**NORTH CAROLINA MARINE FISHERIES COMMISSION
DEPARTMENT OF ENVIRONMENTAL QUALITY**

COMMISSIONERS

ROY COOPER
Governor

MICHAEL S. REGAN
Secretary

ROB BIZZELL
Chairman

MIKE BLANTON
Elizabeth City
DOUG CROSS
Grantsboro
TOM HENDRICKSON
Zebulon

PETE KORNEGAY
Camden
DR. MARTIN POSEY
Wilmington
ROBERT McNEILL
Wilmington
SAM ROMANO
Wilmington

February 3, 2020

Bruce Morris



Dear Mr. Morris:

I have reappointed you to the Shellfish/Crustacean Advisory Committee. Please remember that you are required to attend 75 percent of the meetings of your committee. I would like to thank you for continuing to sacrifice your time and provide your input to help us effectively manage the marine resources of our state.

Sincerely,

A handwritten signature in black ink that reads "W. Robert Bizzell".

W. Robert Bizzell, Chairman
N.C. Marine Fisheries Commission

WB/lk

cc: Lara Klibansky, Marine Fisheries Commission Liaison



**NORTH CAROLINA MARINE FISHERIES COMMISSION
DEPARTMENT OF ENVIRONMENTAL QUALITY**

COMMISSIONERS

ROY COOPER
Governor

MICHAEL S. REGAN
Secretary

ROB BIZZELL
Chairman

MIKE BLANTON
Elizabeth City
DOUG CROSS
Grantsboro
TOM HENDRICKSON
Zebulon

PETE KORNEGAY
Camden
DR. MARTIN POSEY
Wilmington
ROBERT McNEILL
Wilmington
SAM ROMANO
Wilmington

February 3, 2020

Adam Tyler



Dear Mr. Tyler:

I have reappointed you to the Southern Regional Advisory Committee. Please remember that you are required to attend 75 percent of the meetings of your committee. I would like to thank you for continuing to sacrifice your time and provide your input to help us effectively manage the marine resources of our state.

Sincerely,

A handwritten signature in black ink that reads "W. Robert Bizzell".

W. Robert Bizzell, Chairman
N.C. Marine Fisheries Commission

WB/lk

cc: Lara Klibansky, Marine Fisheries Commission Liaison



**NORTH CAROLINA MARINE FISHERIES COMMISSION
DEPARTMENT OF ENVIRONMENTAL QUALITY**

COMMISSIONERS

ROY COOPER
Governor

MICHAEL S. REGAN
Secretary

ROB BIZZELL
Chairman

MIKE BLANTON
Elizabeth City
DOUG CROSS
Grantsboro
TOM HENDRICKSON
Zebulon

PETE KORNEGAY
Camden
DR. MARTIN POSEY
Wilmington
ROBERT McNEILL
Wilmington
SAM ROMANO
Wilmington

February 3, 2020

Tom Smith



Dear Mr. Smith:

I have reappointed you to the Southern Regional Advisory Committee. Please remember that you are required to attend 75 percent of the meetings of your committee. I would like to thank you for continuing to sacrifice your time and provide your input to help us effectively manage the marine resources of our state.

Sincerely,

A handwritten signature in cursive script that reads "W. Robert Bizzell".

W. Robert Bizzell, Chairman
N.C. Marine Fisheries Commission

WB/lk

cc: Lara Klibansky, Marine Fisheries Commission Liaison



**NORTH CAROLINA MARINE FISHERIES COMMISSION
DEPARTMENT OF ENVIRONMENTAL QUALITY**

COMMISSIONERS

ROY COOPER
Governor

MICHAEL S. REGAN
Secretary

ROB BIZZELL
Chairman

MIKE BLANTON
Elizabeth City
DOUG CROSS
Grantsboro
TOM HENDRICKSON
Zebulon

PETE KORNEGAY
Camden
DR. MARTIN POSEY
Wilmington
ROBERT McNEILL
Wilmington
SAM ROMANO
Wilmington

February 3, 2020

Charles Griffin


Dear Mr. Griffin:

I would like to take this opportunity to thank you for serving on the Marine Fisheries Commission's Southern Regional Advisory Committee. As you know, the Bylaws of the N.C. Marine Fisheries Commission require that all advisors attend at least 75 percent of all meetings annually. Records indicate you have not attended any of the committee meetings held in 2019. Unfortunately, as a result, you are being removed from the Southern Regional Advisory Committee.

Again, thank you for your service. If you have any questions regarding the commission's advisory committee process, please contact Lara Klibansky at 252-808-8021.

Sincerely,



W. Robert Bizzell, Chairman
N.C. Marine Fisheries Commission

WB/lk

cc: Lara Klibansky, Marine Fisheries Commission Liaison



**NORTH CAROLINA MARINE FISHERIES COMMISSION
DEPARTMENT OF ENVIRONMENTAL QUALITY**

COMMISSIONERS

ROY COOPER
Governor

MICHAEL S. REGAN
Secretary

ROB BIZZELL
Chairman

MIKE BLANTON
Elizabeth City
DOUG CROSS
Grantsboro
TOM HENDRICKSON
Zebulon

PETE KORNEGAY
Camden
DR. MARTIN POSEY
Wilmington
ROBERT McNEILL
Wilmington
SAM ROMANO
Wilmington

February 3, 2020

Christopher Hunt
[REDACTED]

Dear Mr. Hunt:

I would like to take this opportunity to thank you for serving on the Marine Fisheries Commission's Southern Regional Advisory Committee. As you know, the Bylaws of the N.C. Marine Fisheries Commission require that all advisors attend at least 75 percent of all meetings annually. Records indicate you have not attended any of the committee meetings held in 2019. Unfortunately, as a result, you are being removed from the Southern Regional Advisory Committee.

Again, thank you for your service. If you have any questions regarding the commission's advisory committee process, please contact Lara Klibansky at 252-808-8021.

Sincerely,

A handwritten signature in cursive script that reads "W. Robert Bizzell".

W. Robert Bizzell, Chairman
N.C. Marine Fisheries Commission

WB/lk

cc: Lara Klibansky, Marine Fisheries Commission Liaison

MISCELLANEOUS

From: [Bizzell, Rob](#)
To: [Gillikin, Dana](#)
Subject: Fwd: [External] Management
Date: Tuesday, November 12, 2019 5:10:45 PM

Next meeting
Get [Outlook for iOS](#)

From: james hall [REDACTED]
Sent: Tuesday, November 12, 2019 4:41 PM
To: Bizzell, Rob
Subject: [External] Management

CAUTION: External email. Do not click links or open attachments unless you verify. Send all suspicious email as an attachment to report.spam@nc.gov<<mailto:report.spam@nc.gov>>

Good Afternoon

I am writing this out of concern for our fisheries. Yesterday being Veterans Day I was off of work, so being an outdoors man I took to the water. When I arrived at my destination I was disgusted. There was trash all over the oyster beds drink bottles, toilet paper from individuals using the bathroom, plastic bags, wrappers from food. I am aware that oyster season is in and people will be harvesting. The majority of people whom I observed oystering where in some capacity commercial. My question or concerns are why is marine fisheries catering to the commercial fishermen if they have no more respect for the resources than what I have observed. You (marine fisheries) are appearing to cut the recreational fishermen out of the resource while allowing the commercial aspect to take full advantage. If my livelihood was made on the water I would be your number one conservationist. But instead I am no longer allowed to harvest flounder, and they are still fishing and reportedly going to get more seasons opening. I do not understand the logic going into the management practices the marine fisheries are proposing and in-acting. I have also yet to mention that we are the only state that still allows netting in our coastal waters. I am also fully aware that this is people's livelihoods but if they cannot take care of instead of destroying out coastal estuaries then something needs to change.

Thank you
James Hall

From: [Klibansky, Lara](#)
To: [Gillikin, Dana](#)
Subject: FW: [External] Surf Fishing
Date: Friday, November 08, 2019 11:40:44 AM

Hi Dana,

Please add the below to the February letters. Thank you!

Lara

From: Bizzell, Rob <r.bizzell.mfc@ncdenr.gov>
Sent: Thursday, November 7, 2019 7:54 PM
To: Klibansky, Lara <Lara.Klibansky@ncdenr.gov>
Subject: Fwd: [External] Surf Fishing

Please put this in the February meeting book, past the cut off for this meeting. Thanks, Rob
Get [Outlook for iOS](#)

From: [REDACTED]
Sent: Thursday, November 7, 2019 4:45 PM
To: Bizzell, Rob
Cc: Boltes, C; Hendrickson, Tom; Posey, Martin H; Kornegay, K; McNeill, Robert; Blanton, Mike; Cross, Doug;
Subject: [External] Surf Fishing

CAUTION: External email. Do not click links or open attachments unless you verify. Send all suspicious email as an attachment to report.spam@nc.gov

I am not sure who to send this note to, so I'm sending it to the staff of North Carolina division of marine fisheries.

I don't know if any of the staff spends time surf fishing or how much accurate information you receive so I would like to give you some feedback from a recent surf fishing trip in North Carolina.

I'm part of a group of 8 to 10, mostly family members, that spend a week every October surf fishing on the beaches in North Carolina. We have been doing this every year since 1980. We are pretty serious fisherman, spending 10 to 12 hours fishing daily during the week that we are there.

The drum fishing has improved greatly since 1980 and this year was great, most of them fell in the slot limit. We caught bigger blues than prior years but not as many as in the past.. Caught some great Speckled Trout. Last year was the best year we have had catching Flounder. And this year was better than last year, with the exception that we had to release them. We do not fish for flounder specifically, we use a single hook and mullet minnows. This year we caught 25 to 30 flounder. More than we have caught in the past. But the size of them were much

bigger, a lot of them were 17 to 20 inches. All but 4 were under the 15 limit.

For the whole week there was only one other person fishing for as far as we could see up or down the beach.

I guess my question to the Staff is how can the rod and reel fisherman be impacting the size and quantity of the flounder? For the whole week we as a group would have kept maybe 20 flounder. In that same time frame how many flounder would be taken by a commercial fisherman? Is there a chance you are penalizing the wrong group of fisherman..

South Carolina doesn't seem to have a problem with the rod and reel fishermen, not sure yet about Virginia. I would hate to move our group to another state to surf fish. I love the North Carolina beaches and the surf fishing but you have targeted the wrong group (rod and reel) to help improve the size and quantity of flounder.

To help improve the size and quantity of flounder, and I am not sure there is a need there, look at some of the netting practices and the new attraction of Charter Flounder Giggling. I have been on flounder boats in years past and giggered 50 to 60 in a night. The flounder boats are deadly to flounder.

We are ok with raising the size limits but complete season closure is not fair to the rod and reel fisherman. And it will not help increase the size and quantity. From what we seen this year fishing, it could be that the Staff may have received some false information.

The ten of us would be glad to give you the honest facts at least what we experienced from our week of fishing.

Thank you for your time and feel free to contact me.

Ron Shaffer





NORTH CAROLINA

State Board of Elections & Ethics Enforcement

Mailing Address:
P.O. Box 27255
Raleigh, NC 27611-7255

Phone: (919) 814-0700
Fax: (919) 715-0135

Ethics & Lobbying Education

The following information applies to public servants, legislators, legislative employees, and ethics liaisons. For information on lobbying education and awareness presentations for lobbyists and lobbyist principals.

Mandatory Education. The N.C. State Board of Elections and Ethics Enforcement provides mandatory ethics and lobbying education for *public servants, legislators, legislative employees* and *ethics liaisons*. Topics covered include:

- Filing a Statement of Economic Interest (“SEI”)
- Monitoring and avoiding conflicts of interest
- The gift ban and its exceptions
- Prohibition on use of public position for private gain
- Lobbying and how it affects individuals covered by the State Government Ethics Act

Ethics education is the primary way individuals subject to the State Government Ethics Act are made aware of their public duties and responsibilities as well as the consequences for violating the ethics laws.

Who Must Participate

- **Public Servants & Ethics Liaisons.** All public servants and ethics liaisons are required to attend a Commission-approved basic ethics and lobbying education presentation within six (6) months of the person's election appointment, or employment and attend a refresher presentation at least every two (2) years thereafter.
- **Legislators & Legislative Employees.** The Commission, jointly with the Legislative Ethics Committee, makes mandatory ethics education and lobbying presentations to all legislators within two (2) months of the legislator assuming his or her office. Legislative employees must also participate in ethics education within three (3) months of employment and attend a refresher at least every two (2) years.
- **Education Presentations & Schedule.** Ethics and lobbying education presentations for public servants and ethics liaisons are offered [online](#) and [live at Raleigh-only and distance education sites](#). Completing an online presentation or attending a live session meets either the basic or refresher mandatory education requirements. Visit <https://www.ncsbe.gov/Ethics/Education> to access online and live training options.

Ethics education for **legislators** is conducted in live sessions. Legislative employees may participate in ethics education online through the General Assembly.

- **Consequences for Failure to Attend.** Failure to attend an ethics and lobbying education presentation is a violation of the State Government Ethics Act and may result in the individual being recommended for removal from his or her public position or disciplined in his or her State job.

Contact Information

For education related questions, contact:
NC State Board of Elections and Ethics Enforcement
Phone: (919) 814-3600
E-mail: Education.Ethics@doa.nc.gov

2019 STATEMENT OF ECONOMIC INTEREST REMINDERS:

Completed SEIs must be filed on or before April 15, 2019. If you have already filed a 2019 SEI, do not refile. The forms and instructions can be found at <https://ethics.ncsbe.gov/sei/blankForm.aspx>.

If you filed a 2018 SEI ***and*** you have had ***no changes*** since your 2018 filing, you may file a 2019 SEI No Change Form, located on the website.

You must file a 2019 Long Form if any of the following apply to you:

- a. You filed a 2018 SEI ***but*** you have had changes since your 2018 filing;
- b. You did not file a 2018 SEI; or
- c. You are a first-time filer or have been appointed to a new or additional position/board.

This year, the State Board of Elections and Ethics Enforcement will roll out a new electronic process for filing SEIs. That electronic filing option will be available in **early February**.

You are encouraged to file your SEI electronically. However, if you want to file your SEIs before the updated electronic version is available, hard copies are available for filing now at the link above.

New commissioners will need to file a 2019 SEI; however, if you have not had any changes since you last filed, you can use the No Change Form, which is fairly easy to complete.

Please file by April 15th to avoid fines and other penalties.

SEI HELPFUL TIPS

1. PUBLIC RECORDS. The State Board of Elections and Ethics Enforcement (State Board) is required to collect and maintain disclosures from certain persons covered by the State Elections and Ethics Enforcement Act Government Ethics Act (Elections and Ethics Act). By law, the information requested is public record and available to the public upon request. As public records, Statements of Economic Interest (SEI) are available on the Commission's website. Personal contact information, however, is not.

2. CONTACT INFORMATION PAGE. The Contact Information page, which includes your personal contact information, will not be available on the Commission's website, but is a public record.

3. CHILDREN'S INITIALS. Only list minor children's INITIALS on the SEI. List each child's full legal name on the Confidential Unemancipated Children's Form. If you are filing electronically, the form will be generated at the end of the SEI from the information that you provided on your electronic SEI. The Confidential Form is not a public record, and the State Board will not make it available to the public.

4. READ EACH QUESTION CAREFULLY. Read each question carefully and pay close attention to the time periods in each question as they do vary.

5. ANSWER EACH QUESTION. It is important to answer each question, including all applicable subparts. Even if your answer is "no" or "not applicable," make certain you answer each question. Many of the questions have "yes" and "no" boxes to check for your convenience. Incomplete SEIs may cause delays and negatively impact your public service on a covered board or as an employee.

6. WHY ARE YOU FILING. You must list the complete name of the state board or state agency employer for which you are filing the SEI. Without this information, your SEI may be delayed and negatively impact your public service on a covered board or as an employee.

7. HOW TO FILE. The State Board strongly recommends electronic on-line filing as it is secure, allows easy information updates, and gives you access to your electronic SEIs previously filed. Filing your SEI on-line is easy, quick, convenient, and reduces the chance of reporting errors. Getting started is easy. Follow the simple steps to create your own account and get access today: <https://EFILE.ncsbe.gov/> To file a paper version of the SEI, you must provide the State Board with a signed, original SEI form. Each SEI includes an "affirmation" and is a legally binding document. Faxed or emailed copies of your SEI CANNOT be accepted.

SEI Helpful Tips, continued

8. INCOME. List each source of income as requested on the SEI. The actual dollar amount is not required. Be sure to list your employer as a source of income in Question # 6 of the SEI.

9. READ CAREFULLY. Read each question carefully, as the Elections and Ethics Act requires that you disclose your financial holdings and obligations, personal property, and real property and may also include your knowledge of the holdings of both your immediate family and your extended family. "Immediate family" and "extended family" are defined terms in the Elections and Ethics Act, and those definitions are included with this document.

10. REFLECT. Think carefully about WHY you are filing, and whether it has any relationship to your position. Does your board or commission license or regulate you? For many of the boards, a subject matter expert like a licensee is needed. Answering "yes" does not prohibit your service on the board, and your perspective is valued.

11. MAKE A COPY. Make a copy of the SEI for your own records, and make a note in your calendar when you submit it, whether on-line or by mail or hand delivery. When you successfully submit your SEI electronically on-line, the final screen will provide a confirmation number and will be proof that you have satisfied your filing obligation. Please print the **confirmation screen for your records.**

12. ETHICS LIAISON. Contact your Ethics Liaison to assist you in your obligations under the Elections and Ethics Act. Your Ethics Liaison is good source of information about how to fill out your SEI.

13. ON-LINE HELP. The State Board has on-line resources to answer questions you may have about your SEI. For more information, please visit the State Board website which has education offerings.

14. DEFINITIONS. As noted above, certain terms are defined in the Elections and Ethics Act (“immediate family”). These definitions may be helpful to you in completing your SEI. A complete list of all definitions used in the Elections and Ethics Act is available on the State Board’s website, under “Ethics”. Some of the more common ones are attached to this document.

15. YOUR INTERNET BROWSER. Consider using Internet Explorer or Chrome to submit your SEI. Some users have had trouble using other browsers. **16. WE ARE HERE TO HELP YOU.** In addition to on-line resources and written materials, the State Board has expert staff ready to answer any questions you might have and assist you in completing and filing your SEI. Do not hesitate to contact us at sei@ncsbee.gov (919) 814-3600.

2020 Meeting Planning Calendar

January						
Su	Mo	Tu	We	Th	Fr	Sa
			1	2	3	4
5	6	7	8	9	10	11
12	13	14	15	16	17	18
19	20	21	22	23	24	25
26	27	28	29	30	31	

February						
Su	Mo	Tu	We	Th	Fr	Sa
						1
2	3	4	5	6	7	8
9	10	11	12	13	14	15
16	17	18	19	20	21	22
23	24	25	26	27	28	29

March						
Su	Mo	Tu	We	Th	Fr	Sa
1	2	3	4	5	6	7
8	9	10	11	12	13	14
15	16	17	18	19	20	21
22	23	24	25	26	27	28
29	30	31				

April						
Su	Mo	Tu	We	Th	Fr	Sa
			1	2	3	4
5	6	7	8	9	10	11
12	13	14	15	16	17	18
19	20	21	22	23	24	25
26	27	28	29	30		

May						
Su	Mo	Tu	We	Th	Fr	Sa
					1	2
3	4	5	6	7	8	9
10	11	12	13	14	15	16
17	18	19	20	21	22	23
24	25	26	27	28	29	30
31						

June						
Su	Mo	Tu	We	Th	Fr	Sa
	1	2	3	4	5	6
7	8	9	10	11	12	13
14	15	16	17	18	19	20
21	22	23	24	25	26	27
28	29	30				

July						
Su	Mo	Tu	We	Th	Fr	Sa
			1	2	3	4
5	6	7	8	9	10	11
12	13	14	15	16	17	18
19	20	21	22	23	24	25
26	27	28	29	30	31	

August						
Su	Mo	Tu	We	Th	Fr	Sa
						1
2	3	4	5	6	7	8
9	10	11	12	13	14	15
16	17	18	19	20	21	22
23	24	25	26	27	28	29
30	31					

September						
Su	Mo	Tu	We	Th	Fr	Sa
		1	2	3	4	5
6	7	8	9	10	11	12
13	14	15	16	17	18	19
20	21	22	23	24	25	26
27	28	29	30			

October						
Su	Mo	Tu	We	Th	Fr	Sa
				1	2	3
4	5	6	7	8	9	10
11	12	13	14	15	16	17
18	19	20	21	22	23	24
25	26	27	28	29	30	31

November						
Su	Mo	Tu	We	Th	Fr	Sa
1	2	3	4	5	6	7
8	9	10	11	12	13	14
15	16	17	18	19	20	21
22	23	24	25	26	27	28
29	30					

December						
Su	Mo	Tu	We	Th	Fr	Sa
		1	2	3	4	5
6	7	8	9	10	11	12
13	14	15	16	17	18	19
20	21	22	23	24	25	26
27	28	29	30			

- MFC
- ASMFC
- SAFMC
- MAFMC
- State Holiday

- Southern Regional AC
- Northern Regional AC
- Finfish AC
- Habitat and Water Quality AC
- Shellfish/Crustacean AC

2020 Committee Assignments for Marine Fisheries Commissioners

01/16/2020

FINFISH ADVISORY COMMITTEE

Statutorily required standing committee comprised of commissioners and advisers that considers matters related to finfish.

Commissioners: Vacant – chair, Sam Romano – vice chair

DMF Staff Lead: Lee Paramore - lee.paramore@ncdenr.gov

Meeting Frequency: Can meet quarterly, depending on assignments from MFC

HABITAT AND WATER QUALITY ADVISORY COMMITTEE & COASTAL HABITAT PROTECTION PLAN STEERING COMMITTEE

Statutorily required standing committee comprised of commissioners and advisers that considers matters concerning habitat and water quality that may affect coastal fisheries resources.

Commissioners: Pete Kornegay – chair, Dr. Martin Posey – vice chair

DMF Staff Lead: Anne Deaton - anne.deaton@ncdenr.gov

Meeting Frequency: Committee can meet quarterly, depending on assignments from MFC. CHPP Steering Committee can meet a couple of times a year.

SHELLFISH/CRUSTACEAN ADVISORY COMMITTEE

Statutorily required standing committee comprised of commissioners and advisers that considers matters concerning oysters, clams, scallops and other molluscan shellfish, shrimp and crabs.

Commissioners: Sam Romano – chair, Pete Kornegay – co-vice chair, Dr. Martin Posey – co-vice chair

DMF Staff Lead: Tina Moore - tina.moore@ncdenr.gov

Meeting Frequency: Can meet quarterly, depending on assignments from MFC

CONSERVATION FUND COMMITTEE

Committee comprised of commissioners that makes recommendations to the MFC for administering funds to be used for marine and estuarine resources management, including education about the importance of conservation.

Commissioners: Sam Romano - chair, Tom Hendrickson and Robert McNeill

DMF Staff Lead: Randy Gregory - randy.gregory@ncdenr.gov

Meeting Frequency: Meets as needed

LAW ENFORCEMENT AND CIVIL PENALTY COMMITTEE

Statutorily required committee comprised of commissioners that makes final agency decisions on civil penalty remission requests.

Commissioners: Rob Bizzell - chair, Doug Cross and Tom Hendrickson

DMF Staff Lead: Col. Carter Witten – carter.witten@ncdenr.gov

Meeting Frequency: Meets as needed

COASTAL RECREATIONAL FISHING LICENSE ADVISORY COMMITTEE

Committee consisting of the three recreational seats and the science seat to provide the DMF advice on the projects and grants issued using Coastal Recreational Fishing License trust funds. **Commissioners:**

Pete Kornegay – chair, Rob Bizzell, Robert McNeill and vacant

DMF Staff Lead: Jamie Botinovch - jamie.botinovch@ncdenr.gov

Meeting Frequency: Meets as needed

NOMINATING COMMITTEE

Committee comprised of commissioners that makes recommendations to the MFC on at-large and obligatory nominees for the Mid- and South Atlantic Fishery Management Councils.

Commissioners: Robert McNeill – chair, Pete Kornegay, Mike Blanton, vacant

DMF Staff Lead: Chris Batsavage - chris.batsavage@ncdenr.gov

Meeting Frequency: Typically meets once a year

STANDARD COMMERCIAL FISHING LICENSE ELIGIBILITY BOARD

Statutorily required three-person board consisting of DEQ, DMF and MFC designees who apply eligibility criteria to determine whether an applicant is eligible for a SCFL.

Commission Designee: Mike Blanton

DMF Staff Lead: Marine Patrol Capt. Garland Yopp – garland.yopp@ncdenr.gov

Meeting Frequency: Meets two to three times a year, could need to meet more often depending on volume of applications

N.C. COMMERCIAL FISHING RESOURCE FUND COMMITTEE

Committee comprised of commissioners that the commission has given authority to make funding decisions on projects to develop and support sustainable commercial fishing in the state.

Commissioners: Doug Cross – chair, Mike Blanton and Sam Romano

DMF Staff Lead: William Brantley – william.brantley@ncdenr.gov

Meeting Frequency: Meets two to three times a year

WRC/MFC JOINT COMMITTEE ON DELINEATION OF FISHING WATERS

Committee formed to help integrate the work of the two commissions as they fulfill their statutory responsibilities to jointly determine the boundaries that define North Carolina's Inland, Coastal and Joint Fishing Waters as the agencies go through a statutorily defined periodic review of existing rules.

MFC Commissioners: Rob Bizzell, Dr. Martin Posey and Pete Kornegay

DMF Staff Lead: Anne Deaton - anne.deaton@ncdenr.gov

Meeting Frequency: Meets as needed

COMMITTEE REPORTS

**HABITAT AND
WATER QUALITY AC**

**COMMERCIAL
FISHING RESOURCE
FUNDING**



ROY COOPER
Governor

MICHAEL S. REGAN
Secretary

STEPHEN W. MURPHEY
Director

Dec 20, 2019

MEMORANDUM

TO: N.C. Marine Fisheries Commission

FROM: Anne Deaton, Habitat Program Manager
Katy West, Northern District Manager

SUBJECT: Habitat and Water Quality Advisory Committee Meeting December 11, 2019

The Habitat and Water Quality Advisory Committee Meeting met at 1 p.m. Wednesday December 11, 2019 at the Department of Environmental Quality Regional Office, 948 Washington Square Mall, Washington, NC. The following attended:

Advisors: Pete Kornegay, Martin Posey, Brian Boutin, Joel Fodrie, Chris Moore, Mike Street, Samuel Boyce

Absent: Bob Christian, David Glenn, Nathan Hall

Staff: Anne Deaton, Chris Stewart, Katy West, Kathy Rawls, Jason Rock, Dan Zapf, Kim Harding, Tina Moore, Jimmy Johnson (APNEP), David May (DWR)

Public: Katy Warnell, Chris Baillie, Stacy Trackenberg, David Sneed

Chairman Martin Posey called the meeting to order at 1:00 p.m.

MODIFICATIONS TO THE AGENDA

The agenda was passed by consensus with no changes.

APPROVAL OF MINUTES

Anne Deaton pointed out a change to the October 15, 2019 minutes requested by Nathan Hall regarding eutrophication in Albemarle Sound. Joel Fodrie and Mike Street pointed out two other changes needed in the Blue Crab discussion. The minutes were unanimously approved with the suggested changes.

RECLASSIFICATION OF SPECIAL SECONDARY NURSERY AREAS (SSNA) TO PERMANENT SECONDARY NURSERY AREAS (SNA)

Chris Stewart gave a presentation on potential reclassification of some waters designated SSNA to SNA. This issue originated in the 2015 Shrimp Fishery Management Plan Amendment 1. The focus of Amendment 1 was to address bycatch in the commercial and recreational shrimp fishery. In addition to some closures that already went into effect, the MFC also recommended the Habitat and Water Quality Advisory Committee provide input to the MFC about potentially changing the designation of certain SSNAs that have not been opened to trawling since 1991 to SNAs.

After the adoption of Amendment 1, staff prepared an issue paper; however, a petition for rulemaking was submitted to the MFC in November 2016 that potentially overlapped with the issue paper and a second petition was submitted in May 2019. The paper was put on hold until both petitions for rulemaking were resolved. Final resolution of the latter petition occurred in August 2019. This issue paper was drafted and begins the process for rule consideration as part of the 2020-2021 rule cycle.

Stewart explained that in SNAs, it is unlawful to use trawl nets for any purpose. However, in SSNAs the Fisheries Director, may, by proclamation, open any or all of the SSNAs, or any portion thereof to shrimp or crab trawling from August 16 through May 14. The intent of these rules and proclamations is to protect this nursery habitat for young finfish and crustaceans as well as developing sub-adults. By allowing limited trawling in SSNAs later in the season, fishermen are allowed to catch shrimp that have not migrated out into the larger estuaries. The opening and closing of SSNAs is based on the count size (number per pound) and the amount of the shrimp and finfish presence. There are currently no additional habitat or water quality protections associated with SNAs and SSNAs.

Nine SSNA waterbodies noted from Amendment 1, totaling 8,700 acres, are being considered for reclassification to SNAs since they have not been opened by proclamation for trawling since 1990. These include Pungo Creek, Scranton Creek, Slade Creek, South Creek, Bond Creek/Muddy Creek, Newport River, Cape Fear River, Lockwood Folly River, and Saucepan Creek. They have not been opened due to either the high abundance of juvenile non-target species, or low abundance of shrimp, or small size of shrimp.

Stewart reviewed the proposed boundary changes at each creek or river. He explained that in Pamlico and Pungo rivers, the change would be consistent to the proposed change in the draft the Blue Crab FMP Amendment 3 to eliminate crab trawling in the same area. In the Newport River, the classification change would correct an inconsistency where the SSNA is located immediately upstream of a shrimp trawl prohibited area. The other SSNAs have not been opened since the 1980s. Because these areas have not opened in many years, the change would not adversely impact shrimp fishermen.

The reclassification would affect small mesh gill net attendance requirements in eight of the SSNAs, because gill net attendance is required by rule in all permanent SNAs (see Table 2 in issue paper). In Pungo, Slade, South, Bond and Muddy creeks, attendance will still be required year-round within 200 yards from shore, but additional attendance in all waters would be required from May 1 – Nov 30. Scranton Creek would not change, since attendance is already required in all waters year-round. In the remaining SSNAs, attendance would change from being

required within 50 yards of shore May 1-Sep 30, to being required in all waters from May 1-Nov 30.

Stewart discussed other ways the areas could be reclassified without changing the gill net attendance requirements. This included changing the SSNAs to SNAs but exempting them from additional gill net attendance or changing the classification from SSNA to Trawl Net Prohibited Areas (TNPA). This would result in the same outcome, prohibiting trawling, but the areas would lose their nursery designation. The Shrimp FMP Plan Development Team (PDT) recommended Option 2, changing the designation of the nine SSNAs to permanent SNAs, with the associated gill net requirements of SNAs.

Mike Street asked if this would cause an inconsistency with clam kicking rules; staff explained that it would not. There was discussion regarding the differences between Primary and Secondary Nursery Areas, and clarification whether the proposed change is about habitat characteristics. Staff explained it was more of a classification correction, since these waterbodies are not opening due to the characteristics of the shrimp and other non-target species present in the summer and are therefore being managed like SNAs.

PUBLIC COMMENT

There was no public comment.

VOTE ON RECOMMENDATIONS TO THE MARINE FISHERIES COMMISSION TO RECLASSIFY NINE SPECIAL SECONDARY NURSERY AREAS (SSNA) TO PERMANENT SECONDARY NURSERY AREAS (SNA)

Street made a motion to recommend Option 2 in the issue paper – to change the designation of special secondary nursery areas that have not been opened to trawling in many years to permanent secondary nursery areas, which would make them subject to gill net attendance under 03R .0112(b)(1). Sam Boyce seconded the motion. Motion passed 6-0-1.

DUKE CLIMATE RESILIENCY AND HABITAT PROTECTION MAPPING TOOL

Katy Warnell, with Duke University, Nicholas Institute for Environmental Policy Solutions, gave a presentation on work she has been doing as part of the NC Executive Order (EO) 80 efforts to develop a NC Climate Change Plan and explain how this tool could assist with coastal habitat protection and restoration actions and the Coastal Habitat Protection Plan. The spatial analysis was developed for the Natural and Working Lands Committee, within Section 9 of the EO 80 efforts. The tool includes coastal habitat distributions and the coastal exposure index. Using the InVEST coastal vulnerability and coastal blue carbon models, the tool can map where existing coastal habitats reduce coastal hazards (wave energy), identify what assets they protect, and identify what areas might be prioritized targets for habitat restoration. An estimate of the extent of carbon storage and sequestration that can be provided by existing habitats was calculated, along with the extent of that under various sea level rise scenarios. Salt marsh and seagrass habitats are used for carbon storage estimates. By better understanding the value of these habitats for mitigating effects of sea level rise and climate change, actions can be better focused on preserving the habitats in the most strategic locations to best preserve the ecosystem services they provide, including shore protection and fish production.

The advisory committee discussed the key assets used in the analysis and noted that they only included populated areas, historic sites, and existing state and federal conservation areas (e.g., wildlife refuges and parks). Changing the key assets could be done to customize the output to focus more on protecting strategic habitat areas and high quality fisheries habitat, rather than protecting upland development. This analysis was primarily done for the purposes of climate resiliency. Posey noted that the acreage of seagrass and salt marsh could greatly change as low lying areas of the Outer Banks become submerged and offer less wave energy protection in the estuary. Marshes will drown unless they can migrate; the model estimated 56% loss with 1.5 foot increase in sea level, and 97% loss at 3 foot increase. It was also noted that different species of SAV may not be as effective at storing carbon.

INFLOW AND INFILTRATION ISSUES IN COASTAL NORTH CAROLINA

David May, DWR Regional Supervisor at the Washington regional office, gave a presentation on water quality concerns related to problems associated with sanitary sewer collection systems. This issue has been identified as a priority habitat issue to address in the 2021 CHPP revision. Inflow is when stormwater is directly conveyed into a wastewater system. Inflow can occur intentionally when homeowners remove wastewater cleanout caps to drain flooded yards or connect gutter drains to the wastewater line. Infiltration is when water from rainfall, runoff, or groundwater seeps into the wastewater pipes due to breaks, cracks in pipes. Because sewer systems are designed for known type and amount of inputs, increases from inflow and infiltration reduce the level of treatment, and can lead to overflowing raw sewage from pipes, lift stations, or at the plant. The average spill in small coastal areas is 55,000-75,000 gallons, introducing high concentrations of bacteria and nutrients. High groundwater table, aging infrastructure, and the sewer lines located along the right of way where other infrastructure is put (digging breaking pipes) exasperates infiltration issues. May said that inflow is likely a larger problem than infiltration due to the large volume. This is a prevalent problem that leads to degraded water quality.

PLAN AGENDA ITEMS FOR THE NEXT MEETING

Posey asked if there were agenda items committee members would like to hear about at future meetings. Topics included update on effectiveness and compliance with coastal stormwater rules, presentations on habitat related CRFL projects, and an interest in providing input on research needs for future CRFL project criteria. The meeting adjourned at 3:30.



ROY COOPER
Governor

MICHAEL S. REGAN
Secretary

STEPHEN W. MURPHEY
Director

MEMORANDUM

TO: N.C. Marine Fisheries Commission Commercial Resource Fund Committee and the Funding Committee for the N.C. Commercial Fishing Resource Fund

FROM: William Brantley, Grants Program Manager
Division of Marine Fisheries, NCDEQ

DATE: January 16, 2020

SUBJECT: MFC Commercial Resource Fund Committee and Funding Committee for the N.C. Commercial Fishing Resource Fund Meeting Minutes

The MFC Commercial Resource Fund Committee and the Funding Committee for the N.C. Commercial Fishing Resource Fund met at 1:30 p.m. on Tuesday, January 14, 2020 at the N.C. Department of Environmental Quality's Washington Regional Office. The following attended:

MFC Commercial Resource Fund Committee: Chairman Doug Cross, Sam Romano, Mike Blanton

Funding Committee for the N.C. Commercial Fishing Resource Fund Members: Chairman Ernest Doshier, Glenn Skinner, Steve Weeks, Gilbert Baccus, and Doug Todd

Absent: Andrew Berry

Public Comment: Larry Baldwin, Chris McCaffity via email

APPROVAL OF AGENDA AND MINUTES

Chairman Doug Cross called the meeting to order for the MFC Commercial Resource Fund Committee. Chairman Ernest Doshier then called the meeting to order for the Funding Committee for the N.C. Commercial Fishing Resource Fund.

Chairmen Doshier inquired about and noted no conflicts of interest, Chairman Cross followed and noted no conflicts of interest. William Brantley conducted a roll call.

The meeting agenda was reviewed.

Mike Blanton made a motion to approve the agenda with a second by Sam Romano. Motion passed.

Glenn Skinner made a motion to approve the agenda. Doug Todd seconded the motion. Motion passed.

Minutes from the June 20, 2019 MFC Commercial Resource Fund (CRF) Committee meeting and the Funding Committee for the N.C. Commercial Fishing Resource Fund were reviewed.

Romano made a motion to approve the minutes, with a second from Blanton. Motion passed.

Skinner noted that in the June 20th minutes “Sam Romano” had seconded a motion to adjourn, not “Sam Weeks” as typed. Weeks noted under the “Public Relations Campaign” that the third sentence should read, “Steve Weeks,” not “Sam Weeks.”

Skinner made a motion to approve the minutes with these changes. Weeks seconded the motion. Motion passed.

Chairman Cross asked for a vote to approve the minutes with these changes, motion passed.

PUBLIC COMMENT

Brantley read into the record an emailed public comment from Chris McCaffity that asked for an online forum to be set up to discuss how funds will be used and subsequently voted on. McCaffity noted that votes should be binding to a 2/3 majority, a supermajority should be achieved or hold funds, and that the forum would offer a form of self-governance.

Larry Baldwin, Crystal Coast Waterkeeper of the Coastal Carolina Riverwatch spoke regarding fisheries and water quality. Baldwin noted that his organization had submitted a fisheries project for funding consideration and briefly described his organization’s proposal.

COMMITTEE BRIEF

Brantley briefed the committees on recent updates. Reappointments to the Committee for Ernie Doshier and Gilbert Baccus has been made by their organizations since the last meeting. Reappointments from the Carteret County Fishermen’s Association and the North Carolina Watermen United were needed for this year.

Brantley asked for time during the meeting to discuss a Memorandum for Record located in the meeting packet where the DMF suggested that the Committees adopt an annual funding schedule to keep their grant awarding practices in accordance with North Carolina Department of Administration’s guidelines as well as to assist with meeting efficiency. Brantley provided an example of an annual schedule. Deputy Director Lupton stated that a funding schedule would provide a structured plan to annotate their funding process, as well as offer other procurement advantages associated with publishing an RFP.

Skinner made a motion to adopt the Division’s suggested annual funding schedule, which would have projects begin with the state’s fiscal year. Weeks seconded. Motion passed.

Romano made a motion to accept the schedule. Blanton seconded. Motion passed.

Brantley updated the Committees with a status of their budget with obligations. The FY2019 transfer was \$699,074 to the Commercial Fishing Resource Fund. Current obligations committed from the Fund are \$1,447,204, leaving an available balance of \$1,410,017.56.

COMMERCIAL FISHERY STATISTICS

Alan Bianchi, Environmental Program Supervisor with the DMF License and Statistics section provided an update on the statistics program funded through the Fund. The Conservation Biologist funded from the Commercial Fishing Resource Fund (Fund) was the primary point of contact during the Hurricane Florence Aid program and assisted with \$11.4 million to eligible commercial fishermen. She also helped review the Trip Ticket Program, Annual Dealer Report, Semi-Annual Dealer Report, and License and Statistics Annual Report. The Environmental Technician I supported by the Fund serves as the Trip Ticket liaison to 80 seafood dealers in the Elizabeth City region. He reviewed 13,898 trip tickets and completed 1,508 edits. The Year 2 Funding Request for this project was \$125,000.

Weeks inquired about additional funds left over after the Year 1 timeline ended. Administrative and Maintenance Services Section Chief Beth Govoni stated that any unused funds remaining after the project period ends would remain in the Fund. Skinner issued concerns that were relayed to him that the Fund was not to be formed to fund positions for this program, and fishing restrictions could be the reason for declining license sales which once supported this program.

Skinner made a motion to approve Year 2 funding written as-is. Gilbert Baccus seconded the motion. Motion passed.

Romano made a motion to approve. Blanton seconded. Motion passed.

COMMERCIAL GEAR DEVELOPMENT PROJECT

Kevin Brown, Conservation Biologist II with the DMF Fisheries Management section provided an update on the gear development program funded through the Fund. Chairman Cross congratulated Brown on his recent publication, "Simple gear modifications for achieving greater than 40% bycatch reduction in an estuarine shrimp trawl fishery." Brown stated that he was not seeking another year of funding, just a no cost extension to contract one boat utilizing leftover funds from Year 1. Brown explained that the no cost extension would just extend the remaining Year 1 funds for an additional year.

Skinner relayed concerns from smaller vessel owners regarding tail bag size, and if different gears could be reviewed with consideration to those smaller vessel operators. Skinner then inquired about a proposal specifically targeted with assisting smaller boats.

Skinner made a motion to approve the no cost extension request for an additional year. Doug Todd seconded the motion. Motion approved.

Blanton made a motion to approve the extension for one year. Romano seconded. Motion passed.

COMMERCIAL FISHERY DISEASE AND PATHOLOGY: RESEARCH AND MONITORING

Brantley provided an update on the retainer fund. This designation was for \$25,000 for potential pathologic work within commercial fisheries. No funds were spent in Year 1.

Blanton made a motion to approve an additional year of funding. Romano seconded. Motion passed.

Skinner made a motion to approve an additional year of funding. Weeks seconded. Motion passed.

WATER QUALITY DISCUSSION

Brantley stated that the DMF had been asked to submit a proposal regarding water quality and commercial fisheries to the Committees. After discussion within the DMF, additional parameters were requested, as it is a broad subject area with many variables. Staff from the DMF's Shellfish Sanitation section, as well as Fisheries Management section were available in the audience to assist with the conversation. External funding opportunities could be explored to include other agencies, or municipalities. Skinner suggested the Committees coming up with various areas of concern and implementing them into an RFP.

Blanton mentioned the Albemarle Sound algal blooms, and if a consolidated effort between the Water Quality Committee, CHPP, and Nutrient Scientific Advisory Board may offer a synergistic effort between the various committees to address the robust problem of water quality. Deputy Director Lupton said the DMF would communicate to these groups to see if there were complementary efforts that could be included into an RFP.

DMF SOUTHERN FLOUNDER TAGGING GRANT UPDATE

Shelby White and Mike Loeffler, Biologists with the DMF Fisheries Management section, provided an update on the southern flounder tagging project funded through the Fund. White described some issues they had experienced while running trials to test tag retention to include fish mortality issues in the Edenton holding tank trials, however, they were experiencing much better results since moving the fish to holding tanks at the UNC-Wilmington facility. Loeffler stated that he expected to employ 100 tags this fall.

COMMERCIAL FISHING PUBLIC RELATIONS UPDATE

Adam Tesh, President and Co-Founder of Blue Red Marketing, accompanied by colleagues, provided an update on the research they had been working on, followed by branding. Tesh provided metrics on the public's perception of commercial fishing throughout the state. Education and awareness would be important for the campaign. Video production from the project's scope had been recently completed. They filmed for 5 days, visited 7 towns, had 7 people on staff, 8 interviews were conducted, 2000 miles were traveled, 2200 photos collected, 24 hours of footage was collected, and they utilized 5 cameras and 1 drone from Wanchese to

Southport. Personalized branding and methodology to develop branding was discussed by Chuck Norman, Owner/Principal of S&A Communications.

Skinner made a motion to adopt Option 4a as the brand and logo. Baccus seconded. Motion passed.

Blanton made a motion to adopt Option 4a as the brand and logo. Romano seconded. Motion passed.

COMMERICAL FISHING ECONOMIC IMPACT UPDATE

Dr. Jane Harrison, principal investigator conducting the NC Commercial Fishing Economic Impact study, along with colleagues, gave an update to the project. Harrison spoke on the progress of the study, along with the surveys they are using to examine the industry. Dr. Chris Dumas provided information on the survey and asked for input from Committee members. Input was provided, and concerns were addressed.

UNC-W TERRAPIN GEAR MODIFICATION PROJECT

Dr. Amanda Willard, Professor from the Department of Biology and Marine Biology at UNC-Wilmington was asked to describe her proposal to the Committees. The proposal would use work groups for design of crab pot bycatch reduction devices targeted at terrapin, then evaluate the gears against controls and publish the data. Romano stated that this was Willard's project, and since he had assisted in guiding the project that he could answer questions, but he wanted to go on record to avoid any conflicts of interest. Budget line items were discussed by Committee members. Todd asked about the total for the project, which was \$130,867 over two years.

Skinner made a motion to approve \$130,867.13 over two years for the proposal as-is, with corrections to the Year One budget column. Todd seconded. Motion passed.

Cross made a motion to match the motion from the Funding Committee for the NC Commercial Fishing Resource Fund. Motion failed.

Skinner asked if the MFC Committee's motion was tabled due to consultation with their attorney, considering the Funding Committee for the NC Commercial Fishing Resource Fund's motion had passed, would it go to the Secretary for a decision? Deputy Director Lupton stated she would have to seek council on that but would express concerns that an RFP had not been issued for this proposal.

Cross made a motion to table this proposal to the next meeting and request a directed RFP to address terrapin interactions. Blanton seconded. Motion passed.

NC COASTAL FEDERATION CRAB POT COLLECTION PROJECT

Chairman Doshier needed to leave the meeting, and he asked Skinner to take over the Chairman role in lieu of his absence. Chairman Cross asked if this project was in the state budget for consideration for funding from appropriations. Contracting concerns were discussed since the crab closure would be occurring the following day. Brantley stated that contract approval could

take up to 90 days. Sara Bodin, Coastal Specialist with the NC Coastal Federation, was asked by the Committees how the timing would influence their proposal. Bodin stated that if approved, they would use the funding for the next crab pot collection.

Chairman Cross made a motion to table the proposal. Romano seconded. Motion passed.

Todd made a motion to table the proposal. Skinner seconded. Motion passed.

COASTAL CAROLINA RIVERWATCH WATER QUALITY IMPROVEMENT FOR FISHERIES ASSESSMENT AND PLAN PROJECT

Chairman Cross stated that water quality had been discussed throughout the meeting, and the DMF was working to bring project concepts back to the Committees.

Chairman Cross made a motion to table the proposal until the DMF came back with project options discussed earlier in the meeting. Blanton seconded. Motion passed.

Skinner stated that he was named in the proposal, and he and the NC Fisheries Association would be acting in an advisory role and not benefit monetarily.

Baccus made a motion to table the proposal. Todd seconded. Motion passed

ISSUES FROM COMMITTEE MEMBERS

Blanton brought up blue catfish and receiving a proposal to address the issue. Blanton asked that an RFP be issued to address the issue, gear development and sustainable harvest of the species.

Blanton made a motion for an RFP to address the invasive blue catfish issue. Cross seconded. Motion passed.

Chairman Cross made a motion to adjourn. Romano seconded. Motion passed.

Todd made a motion to adjourn. Weeks seconded. Motion passed.

Meeting adjourned at 5:30 p.m.

WB

FISHERY MANAGEMENT PLANS

**STATUS OF
ONGOING PLANS**

**BLUE CRAB FMP
AMENDMENT 3**

**SOUTHERN
FLOUNDER FMP
AMENDMENT 3**

**SHRIMP FMP
AMENDMENT 2**



ROY COOPER
Governor

MICHAEL S. REGAN
Secretary

STEPHEN W. MURPHEY
Director

February 4, 2020

MEMORANDUM

TO: N.C. Marine Fisheries Commission

FROM: Catherine Blum, Fishery Management Plan and Rulemaking Coordinator
Fisheries Management Section

SUBJECT: Fishery Management Plan Update

Issue

Update the Marine Fisheries Commission (MFC) on the status of ongoing North Carolina fishery management plans (FMPs).

Action Needed

For informational purposes only; **no action is needed at this time.**

Overview

This memo provides an overview on the status of the North Carolina FMPs for the February 2020 MFC business meeting.

At the MFC 's August 2019 business meeting, staff provided an update on changes being implemented designed to achieve efficiencies in the FMP process. Changes include the timing of the steps in initial development of draft FMPs, how the division works with the FMP advisory committee and how the committee operates, and what the FMP documents look like. Before the initial development of a draft FMP, a scoping period will be held to notice the public that the review of the FMP is underway, inform the public of the stock status (if applicable), solicit input from the public on the list of potential management strategies to be developed, and recruit advisers to serve on the FMP advisory committee. These changes are being incorporated beginning with Amendment 3 to the Southern Flounder FMP and Amendment 2 to the Shrimp FMP.

Blue Crab FMP

The review of the Blue Crab FMP is nearly complete. A stock assessment was completed in 2018 and determined the North Carolina blue crab stock is overfished and overfishing is occurring. Reductions in commercial harvest of blue crab are required by state law to achieve a sustainable harvest, end overfishing within two years, and recover the stock from an overfished condition within 10 years. An advisory committee was formed and assisted the division with development of Amendment 3 to the FMP that contains management measures to meet these requirements. At its November 2019 business meeting, the MFC reviewed recommendations from the public, advisory committees, and the division; selected its preferred management options; and voted to send the draft FMP to the Department of Environmental Quality Secretary for review. Final approval of the FMP by the MFC is scheduled for February 2020. Adaptive management measures adopted in 2016 will remain in place until Amendment 3 is adopted. For more information, please refer to the [Blue Crab FMP](#) section of the briefing materials.

Southern Flounder FMP

The MFC adopted Amendment 2 to the Southern Flounder FMP at its August 2019 business meeting. Amendment 2 moved quickly through the process of development and adoption to address the overfished and overfishing status of the southern flounder stock as determined by the 2019 coast-wide stock assessment. The season closures implemented under the authority of Amendment 2 were deemed critical to the successful rebuilding of the southern flounder stock, while other, more comprehensive, long-term management strategies are examined and developed in Amendment 3. Please refer to the [Southern Flounder FMP](#) section of the briefing materials for more information about how the new changes to the process are being incorporated and the progress of draft Amendment 3, including the scoping period held in December 2019.

Shrimp FMP

The 2019 N.C. FMP Review Schedule shows the review of the Shrimp FMP is underway. To begin the development of the Shrimp FMP Amendment 2, the division is examining management strategies to further reduce bycatch of non-target species in the shrimp trawl fishery and potential changes to existing shrimp management strategies adopted in the 2006 FMP, 2015 Amendment 1, and 2018 Revision to Amendment 1. The division is also taking into consideration input received from the MFC through motions passed at its August 2018 and February 2019 meetings regarding general areas of focus and possible goals and objectives for Amendment 2. Please refer to the [Shrimp FMP](#) section of the briefing materials for more information about how the new changes to the process are being incorporated and the progress of draft Amendment 2, including the scoping period held in January 2020.

Estuarine Striped Bass FMP

For the review of the Estuarine Striped Bass FMP, the assessment of the Central Southern Management Area (CSMA) stocks (Tar-Pamlico, Neuse, and Cape Fear rivers) and the Albemarle Sound-Roanoke River (A-R) stock that began in 2017 is continuing. The Peer Review Workshop for the A-R stock assessment was held Dec. 2-5, 2019 in New Bern. The peer reviewers felt there was too much uncertainty in stock status determination to recommend the current version of the stock assessment in its existing form for management use at this time. They provided areas of focus to improve the stability of the model. While staff was working on the recommended follow-up tasks, an error in the data was discovered that is also being addressed and evaluated for its overall effect on the model.

After reviewing available data, life history information, and stock assessment techniques, the Estuarine Striped Bass FMP Plan Development Team determined traditional stock assessment methods would not be appropriate for CSMA stocks because of the high hatchery contribution and lack of natural recruitment in these systems. The plan development team is nearing completion of the evaluation of the CSMA stocks, including a matrix model for the Tar-Pamlico and Neuse rivers and a tagging model for the Cape Fear River. The assessment of all the estuarine stocks will inform the review of the FMP and development of Amendment 2. This is a joint FMP with the Wildlife Resources Commission, so all updates and reviews are joint efforts by both agencies.

Spotted Seatrout FMP

A benchmark stock assessment for spotted seatrout is underway coinciding with the scheduled Spotted Seatrout FMP review. The prior stock assessment from 2014 indicated that the stock is not overfished and is not experiencing overfishing. The Spotted Seatrout FMP Plan Development Team met in June 2019 for the stock assessment Planning Workshop and in September 2019 for the Data Workshop. The plan development team is completing the working papers from the spotted seatrout Data Workshop and preparing to incorporate data through 2019 to be more reflective of recent fishing activity, as soon as the data are verified and available. A second Data Workshop will be held following this effort.

NORTH CAROLINA FISHERY MANAGEMENT PLANS

February 2020





ROY COOPER
Governor

MICHAEL S. REGAN
Secretary

STEPHEN W. MURPHEY
Director

February 11, 2020

MEMORANDUM

TO: N.C. Marine Fisheries Commission

FROM: Jason E. Rock and Corrin L. Flora, Blue Crab Fishery Management Plan Co-Leads

SUBJECT: Draft N.C. Blue Crab Fishery Management Plan Amendment 3

Issue

The most recent stock assessment determined the blue crab stock is overfished and overfishing is occurring. Reductions in commercial harvest are necessary to end overfishing within two years and recover the stock from an overfished status within a 10-year period. At their November 2019 meeting the N.C. Marine Fisheries Commission (MFC) selected their preferred management measures for [draft N.C. Blue Crab Fishery Management Plan \(FMP\) Amendment 3](#). The management measures selected by the MFC meet the harvest reduction requirements. Draft Amendment 3 was sent for review by the Secretary of the Department of Environmental Quality (DEQ) and legislative committees as required by statute. No additional comments or recommendations were received from these groups. The draft FMP is now ready for final adoption by the MFC.

Action Needed

At their February 2020 business meeting the MFC will vote to finalize the management measures for Amendment 3 and will vote on final adoption of Amendment 3.

Findings

DEQ and Legislative Review

Draft Amendment 3 was forwarded to the Secretary of DEQ on November 25, 2019 for a 30-day review and comment period. On December 6, 2019, the Secretary of DEQ forwarded draft Amendment 3 to the Joint Legislative Oversight Committee on Agricultural and Natural and Economic Resources, the Joint Legislative Commission on Governmental Operations, and the Fiscal Research Division of the Legislature. Both legislative committees had 30 days to provide the Secretary of DEQ with comments or recommendations on the plan. No comments or recommendations were provided for draft Amendment 3 by the Secretary of DEQ or the legislative committees.

MFC Preferred Management Measures

At the November 15, 2019 MFC meeting, the commission selected its preferred management measures for Amendment 3. The MFC's preferred management measures for each issue are as follows:

Achieving Sustainable Harvest in the North Carolina Blue Crab Fishery

***Motion:** Support the Division of Marine Fisheries recommendation for a minimum harvest reduction of 2.2% to achieve a sustainable harvest within ten years and end overfishing within two years in the blue crab fishery.*

***Motion:** Accept the Blue Crab Advisory Committee recommendation for achieving sustainable harvest and ending overfishing.*

Specific management measures selected were:

- North of the Highway 58 Bridge:
 - January 1 through January 31 closed season
 - 6.75-inch maximum size limit for mature females
 - Prohibit the harvest of immature females
- South of the Highway 58 Bridge
 - March 1 through March 15 closed season
 - Prohibit the harvest of immature females
- Season closures will replace the current pot closure period and remain closed for the entire closure period
- Maintain 5% cull tolerance established in 2016 Revision to Amendment 2
- Revised adaptive management framework
- Update stock assessment once 2019 data is available

Management Measures Beyond Quantifiable Harvest Reductions

***Motion:** Leave in the existing rules established in 2016 and add option 4C.*

Specific management measures selected were:

- Increase number of cull rings in pots to 3 (established in 2016 Revision)
- Require one cull ring to be placed within one full mesh of the corner and the apron in the upper chamber of the pot (established in 2016 Revision)
- Prohibit harvest of dark sponge crabs from April 1 through April 30 (established in 2016 Revision)
- Remove cull ring exemptions in the Newport River and eastern Pamlico Sound

Addressing Water Quality Concerns Impacting the North Carolina Blue Crab Stock

Motion: Accept the Division of Marine Fisheries water quality recommendations.

Specific management measures selected were:

- Highlight problem areas and advise other regulatory agencies
- Push to create an interagency workgroup
- Support the Clean Water Act
- Task the CHPP Steering Committee to prioritize blue crab water quality impacts
- Send letters to other state agencies sharing concerns about water quality and Best Management Practices
- Invite other agencies to future MFC meetings to present their efforts to address water quality
- Initiate public outreach on how to report crab and fish kills
- Have division staff regularly provide progress reports to the Habitat and Water Quality and Shellfish/Crustacean advisory committees

Expand Crab Spawning Sanctuaries to Improve Spawning Stock Biomass

Motion: Accept the Blue Crab Advisory Committee recommendation for spawning sanctuaries, with the addition of using the Division of Marine Fisheries recommendation for the Cape Fear River Inlet crab spawning sanctuary.

Specific management measures selected were:

- Modify the boundaries of the existing Drum Inlet and Barden Inlet sanctuaries
- Add spawning sanctuaries from Beaufort Inlet through Tubbs Inlet using Blue Crab AC recommended boundaries, except use the DMF recommended boundary for the Cape Fear River spawning sanctuary
- New sanctuaries will be closed from March 1 through October 31 with the same restrictions as existing sanctuaries

Establish A Framework to Implement the Use of Terrapin Excluder Devices in Crab Pots

Motion: Use science on locally specific pot funnel design to reduce terrapin interactions and identify individual areas with terrapin hotspots that would be closed to potting unless an excluder is used.

Specific management measures selected were:

- Research the effectiveness of pot funnel design modifications in reducing diamondback terrapin bycatch
- Identify areas where pots should be fished with a terrapin excluder device

NOTE: Proclamation authority for requiring terrapin excluder devices in crab pots is contingent upon development of criteria to guide that process and consultation with the Shellfish/Crustacean AC, which occurred on October 1, 2019. Proclamation authority cannot be used until the MFC approves these criteria.

Bottom Disturbing Gear in the Blue Crab Fishery

***Motion:** Accept the Division of Marine Fisheries recommendation regarding crab dredging (option 1A).*

***Motion:** Accept option 1D regarding oyster dredging.*

***Motion:** Accept option 2A regarding crab trawls in areas where shrimp trawls are already prohibited in the Pamlico, Pungo, and Neuse rivers.*

Specific management measures selected were:

- Prohibit the taking of crabs with crab dredges
- Reduce the trip limit of crabs from oyster dredges to 10% of the total weight of the combined oyster and crab catch or 100 pounds, whichever is less
- Prohibit the use of crab trawls in areas where shrimp trawls are prohibited in the Pamlico, Pungo, and Neuse rivers

North Carolina
Blue Crab (*Callinectes sapidus*)
Fishery Management Plan

Amendment 3

By

North Carolina Division of Marine Fisheries



North Carolina Department of Environmental Quality
North Carolina Division of Marine Fisheries
3441 Arendell Street
P. O. Box 769
Morehead City, NC 28557

ACKNOWLEDGMENTS

Amendment 3 to the North Carolina (NC) Blue Crab Fishery Management Plan (FMP) was developed by the NC Department of Environmental Quality (NCDEQ), Division of Marine Fisheries (NCDMF) under the direction of the NC Marine Fisheries Commission (NCMFC) with the advice of the Blue Crab Advisory Committee (AC). Deserving special recognition are the members of the Blue Crab AC and the NCDMF Plan Development Team (PDT) who contributed their time and knowledge to this effort.

Blue Crab Advisory Committee

Perry Beasley
Robert Bruggeworth
Sammy Corbett
Mike Marshall, Vice-Chair
Thomas Roller
Joseph Romano, Chair
Kenneth Seigler

Blue Crab Plan Development Team

Alan Bianchi
Anne Deaton
Jeffrey Dobbs
Joe Facendola
Corrin Flora, Co-lead
Daniel Ipock
Yan Li
Tina Moore
Jason Rock, Co-lead
Adam Stemle
Katy West
Odell Williams

TABLE OF CONTENTS

ACKNOWLEDGMENTS	i
TABLE OF CONTENTS.....	ii
LIST OF TABLES	v
LIST OF FIGURES.....	vii
LIST OF ACRONYMS.....	viii
EXECUTIVE SUMMARY	Error! Bookmark not defined.
INTRODUCTION	1
DEFINITION OF MANAGEMENT UNIT.....	1
MANAGEMENT AUTHORITY.....	1
GOAL AND OBJECTIVES	2
FISHERY MANAGEMENT PROGRAM IMPLEMENTED UNDER AMENDMENT 2 (2013)	3
MANAGEMENT MEASURES IN PLACE UNDER AMENDMENT 2 (2013)	3
COMPLIANCE AND ENFORCEMENT.....	4
DESCRIPTION OF THE STOCK.....	4
BIOLOGICAL PROFILE	4
Physical Description	4
Distribution.....	5
Habitat	6
Reproduction	6
Age and Growth.....	6
Predator-Prey Relationships	8
STOCK STATUS.....	8
Stock Unit Definition.....	8
Assessment Methodology.....	8
DESCRIPTION OF THE FISHERIES.....	8
COMMERCIAL FISHERY	9
Commercial Fishery Data Collection	12
Annual Landings and Value	12
Landings by Crab Type	13
Landings by Season.....	15
Landings by Gear Type and Vessel Length.....	16
Landings by Area.....	17
Demographic Characteristics.....	19
Commercial Crabbers	21
Fishery Effort.....	22

Seafood Dealers and Shedders	24
Crab Processors	25
Swimming Crab Imports	26
Summary of Economic Impact of Commercial Fishing.....	26
RECREATIONAL FISHERY.....	30
Recreational Harvest Estimates	30
Summary of Economic Impact of Recreational Fishing	30
FISHERY IMPACT ON THE ECOSYSTEM	31
HABITAT	31
GEAR IMPACTS TO HABITAT.....	31
BYCATCH AND DISCARDS	34
Undersized and Other Non-Legal Blue Crabs.....	34
Other Species.....	34
Protected Species.....	36
Marine Mammals.....	36
Sea Turtles	37
Diamondback Terrapins	37
Derelict Gear.....	38
ECOSYSTEM IMPACTS ON THE FISHERY	39
WATER QUALITY DEGRADATION.....	39
Hypoxia	40
Toxins	40
HABITAT DEGRADATION AND LOSS.....	42
Submerged aquatic vegetation.....	44
Wetlands	45
Shell Bottom.....	45
Inlets and Ocean Bottom	46
HABITAT AND WATER QUALITY PROTECTION.....	46
Coastal Habitat Protection Plan.....	46
Authority of Other Agencies	49
SIGNIFICANT WEATHER EVENTS.....	50
DISEASE AND PARASITES	51
INVASIVE SPECIES	52
BYCATCH IN OTHER FISHERIES	53
PROPOSED MANAGEMENT STRATEGIES UNDER BLUE CRAB AMENDMENT 3	55

RESEARCH RECOMMENDATIONS	56
LITERATURE CITED	58
APPENDIX 1. GLOSSARY OF BIOLOGICAL TERMS	69
APPENDIX 2. TABLE OF AMENDMENTS TO STATE PLAN.....	83
APPENDIX 3. EXISTING PLANS, STATUTES, AND RULES.....	84
APPENDIX 4. ISSUE PAPERS	90
APPENDIX 4.1: ACHIEVING SUSTAINABLE HARVEST IN THE NORTH CAROLINA BLUE CRAB FISHERY	90
APPENDIX 4.2: MANAGEMENT OPTIONS BEYOND QUANTIFIABLE HARVEST REDUCTIONS.....	111
APPENDIX 4.3: ADDRESSING WATER QUALITY CONCERNS IMPACTING THE NORTH CAROLINA BLUE CRAB STOCK	131
APPENDIX 4.4: EXPAND CRAB SPAWNING SANCTUARIES TO IMPROVE SPAWNING STOCK BIOMASS	147
APPENDIX 4.5: ESTABLISH A FRAMEWORK TO IMPLEMENT THE USE OF TERRAPIN EXCLUDER DEVICES IN CRAB POTS.....	177
APPENDIX 4.6: BOTTOM DISTURBING GEAR IN THE BLUE CRAB FISHERY	223
APPENDIX 4.7: SUMMARY OF ADVISORY COMMITTEE AND NCDMF RECOMMENDATIONS FOR ISSUE PAPERS IN AMENDMENT 3.....	238

LIST OF TABLES

Table 1	Blue crab commercial landings (millions of pounds) and value (millions of dollars) for hard, soft, and peeler crabs combined from major blue crab producing states, 2007-2016. Source: (40)	10
Table 2	North Carolina commercial blue crab landings and value, 2007-2016.	13
Table 3	Landings and real ex-vessel price per pound of North Carolina blue crabs by type, 2007-2016.	14
Table 4	Average monthly blue crab landings (pounds), ex-vessel value, and ex-vessel price per pound, 2007-2016.	16
Table 5	Annual blue crab landings (pounds) by gear type, 2007-2016.	17
Table 6	Blue crab landings (millions of pounds) and average ex-vessel price per pound by area, 2007-2016.....	18
Table 7	Average age of commercial fishermen who harvested blue crab from 2007 – 2016.	20
Table 8	Number of commercial fishermen by gender who harvested blue crab from 2007 – 2016.....	20
Table 9	Number of commercial fishermen by race who harvested blue crab from 2007 – 2016.	20
Table 10	Number of commercial fishermen who indicated they make less or more than 50 percent of their income from commercial fishing as indicated from the economic survey conducted during license sales and renewals from license years 2007 to 2016.	21
Table 11	Total number of SCFL/RSCFLs issued and participants landing blue crab.	22
Table 12	Annual trips, catch per trip, real value per trip, total number of pots, pots fished per trip, and catch per pot in the blue crab fishery.....	23
Table 13	Annual number of vessels landing blue crab by poundage range, 2007-2016.	24
Table 14	Annual number of seafood dealers reporting landings of blue crab, 2007-2016.....	24
Table 15	Annual number of permitted blue crab shedding operations, 2007-2016. Fiscal year runs from July 1 through June 30.	25
Table 16	Annual (April 1-March 31) number of permits issued for crustacea processing facilities, 2007-2018. Data from the NCDMF Shellfish Sanitation section.	26
Table 17	Economic impacts associated with the commercial blue crab fishery for all product categories, 2007-2016.	28

Table 18	Economic impacts associated with the commercial blue crab fishery for hard blue crabs only, 2007-2016.....	28
Table 19	Economic impacts associated with the commercial blue crab fishery for peeler blue crabs only, 2007-2016.....	29
Table 20	Economic impacts associated with the commercial blue crab fishery for soft blue crabs only, 2007-2016.....	29
Table 21	Economic impacts associated with recreational blue crab fishing, 2010-2016.	31
Table 22	Number of derelict crab pots removed each year during the crab pot cleanup period between January 15 and February 7. The northern area is approximately from the Virginia state line to Ocracoke, the central area is from the Pungo River to Emerald Isle, and the southern area is from Cape Carteret to the South Carolina State line.	39
Table 23	Water quality parameters required by and habitats associated with different life stages of blue crab. No documented data where blank (75; 79; 76; 80).....	40
Table 24	Number of observed blue crabs kept and discarded from the estuarine gill net observer program, 2013-2017.....	55

LIST OF FIGURES

Figure 1 Apron shape differences between male and female blue crabs and immature and mature female blue crabs. A. “Jimmy” – male blue crab. B. “She-crab” – immature female blue crab. C. “Sook” – mature female blue crab. D. “Sponge crab” – Egg bearing mature female blue crab. 5

Figure 2 Lifecycle of the blue crab (*Callinectes sapidus*). (6). 7

Figure 3 Average contribution to U.S. Atlantic coast blue crab landings by state, 1950-2016. Source: (40). 11

Figure 4 North Carolina annual blue crab commercial landings, 1950-2016. Source: (40) 11

Figure 5 North Carolina blue crab commercial landings percent by type, 2007-2016. 15

Figure 6 Percent of annual blue crab commercial landings by gear type, 2007-2016. 17

Figure 7 The percentage each of the top seven species (or species groups) contributes to all incidental catch landed from hard crab and peeler pots between 2007 and 2016. 35

Figure 8 Location of mapped shell bottom, submerged aquatic vegetation, and wetlands – northern coast. 43

Figure 9 Location of mapped shell bottom, submerged aquatic vegetation, and wetlands – southern coast. 44

Figure 10 Estuarine areas where bottom disturbing gear is prohibited year-round or seasonally – northern coast. 48

Figure 11 Estuarine areas where bottom disturbing gear is prohibited year-round or seasonally – southern coast. 49

Figure 12 Annual rainfall from the New Bern station and juvenile abundance index (CPUE, all crab sizes) in New Bern, NC, 1980-2016. Source – National Weather Service and NCDMF data. Black vertical lines are years with major hurricane landfall events in NC. 51

Figure 13 Pounds of blue crabs harvested as bycatch from all fisheries, 2007-2016. 54

LIST OF ACRONYMS

ASMFC – Atlantic State Marine Fisheries Commission
CFVR – Commercial Fishing Vessel Registration
CHPP – Coastal Habitat Protection Plan
CRC – Coastal Resources Commission
CRFL – Coastal Recreational Fishing License
CW – Carapace Width
DAPD – Department of Agriculture, Pesticide Division
DCM – Division of Coastal Management
DO – Dissolved oxygen
EDC – Endocrine disrupting chemical
EEZ – Exclusive Economic Zone
EFH-HAPC – Essential Fish Habitat – Habitat Areas of Particular Concern
EMC – Environmental Management Commission
ESA – Endangered Species Act
FMP – Fishery Management Plan
FRA – Fisheries Reform Act
ITP – Incidental Take Permits
MMPA – Marine Mammal Protection Act
NCDEQ – North Carolina Department of Environmental Quality
NCDMF – North Carolina Division of Marine Fisheries
NCMFC – North Carolina Marine Fisheries Commission
NCWRC – North Carolina Wildlife Resources Commission
NOAA – National Oceanographic and Atmospheric Administration
RSCFL – Retired Standard Commercial Fishing License
RCGL – Recreational Commercial Gear License
SAFMC – South Atlantic Fishery Management Council
SAV – Submerged aquatic vegetation
SCFL – Standard Commercial Fishing License
SEAMAP – Southeast Area Monitoring and Assessment Program
SHA – Strategic Habitat Area
USACE – United States Army Corps of Engineers

EXECUTIVE SUMMARY

North Carolina's blue crab resource has been harvested since the 1800s and supports the state's largest and most valuable commercial fishery. The blue crab fishery in North Carolina is the fourth largest blue crab fishery in the United States. Blue crab is also targeted by recreational fishermen and is an important species in the coastal ecosystem serving as prey for many recreationally and commercially important species.

The 2018 stock assessment determined the North Carolina blue crab stock is overfished and overfishing is occurring. State law requires management action to be taken to end overfishing within 2 years and to recover the stock from an overfished condition within 10 years with a 50% probability of success from the date of adoption of the plan. A minimum harvest reduction of 2.2% in numbers of crabs from 2016 commercial hard crab landings is necessary to meet these statutory requirements.

The goal of the North Carolina Blue Crab Fishery Management Plan (FMP) is to manage the blue crab fishery to achieve a self-sustaining population that provides sustainable harvest using science-based decision-making processes. Objectives for the FMP are: implement management strategies that maintain/restore the blue crab spawning stock with multiple cohorts and adequate abundance to prevent recruitment overfishing; restore, enhance, and protect habitat and environmental quality necessary to maintain or increase growth, survival, and reproduction of the blue crab population; use biological, environmental, habitat, fishery, social, and economic data needed to effectively monitor and manage the blue crab fishery and its ecosystem impacts; promote stewardship of the resource through increased public awareness regarding the status and management of the blue crab fishery, including practices that minimize bycatch and discard mortality.

To meet statutory requirements to achieve a self-sustaining population, sustainable harvest was addressed in the FMP. Other issues addressed in the plan encompassed the following general categories: non-quantifiable management measures, water quality, crab spawning sanctuaries, use criteria for terrapin excluder devices, and bottom disturbing gear. Specific recommendations for each issue are as follows:

- 1) Achieving sustainable harvest: To recover the North Carolina blue crab stock the selected management strategy is: a January closed season and a 6 ¾-inch maximum size limit for mature female blue crabs north of the Highway 58 Bridge; a March 1 to 15 closed season south of the Highway 58 Bridge; and to retain the prohibition on immature female hard crab harvest and the 5% cull tolerance established in the 2016 Revision to Amendment 2. These measures are estimated to result in a 3.1% harvest reduction from 2016 landings. Other measures selected were to: have the season closures replace the annual pot closure period; adopt the adaptive management framework based on the peer-reviewed and approved stock assessment; and to update the stock assessment once 2019 data is available.
- 2) Non-quantifiable management measures: While not having quantifiable harvest reductions, several additional management measures were identified that could help

improve the condition of the blue crab stock. The selected management strategy includes the following: retain a minimum number of 3 cull rings per pot with one in the modified corner position and to prohibit the harvest of dark sponge crabs from April 1-30 measures established in the 2016 Revision to Amendment 2; and removing the cull ring exemptions for the Newport River and eastern Pamlico Sound.

- 3) Water quality: Negative impacts to blue crab from poor water quality have been widely documented and strategies were developed for the N.C. Marine Fisheries Commission (MFC) to pursue to improve water quality. Strategies selected were: highlight problem areas and advise other regulatory agencies; push to create an interagency work group; support the Clean Water Act; task the CHPP steering committee to prioritize blue crab water quality impacts; send letters to other state agencies sharing concerns about water quality and Best Management Practices; invite other agencies to future MFC meetings to present their efforts to address water quality; and initiate public outreach on how to report crab and fish kills.
- 4) Crab spawning sanctuaries: Research has shown the existing crab spawning sanctuaries are largely ineffective due to their small size and that expanding the sanctuary system as well as establishing migration corridors will increase the number of mature females reaching the spawning grounds. The selected management strategy includes: maintain the current sanctuary boundaries for Oregon, Hatteras, and Ocracoke inlets; move the Drum Inlet sanctuary boundary to encompass Ophelia Inlet; expand the Barden Inlet sanctuary boundary; and designate new crab spawning sanctuaries around Beaufort, Bogue, Bear, Browns, New River, Topsail, Rich, Mason, Masonboro, Carolina Beach, Cape Fear River, Shallotte, Lockwood Folly, and Tubbs inlets. The new crab spawning sanctuaries will be closed from March 1 to October 31 with the same restrictions as previously existing sanctuaries.
- 5) Terrapin excluder devices: The bycatch of diamondback terrapins has been discussed in every blue crab FMP since 1998 with little action. To address this issue the selected management strategy is to study locally specific pot funnel designs to reduce terrapin bycatch in crab pots and to identify individual areas with diamondback terrapin hot spots that will be closed to pots unless a terrapin excluder device is used.
- 6) Bottom disturbing gear: To reduce the habitat impacts from the blue crab fishery, the use of bottom disturbing gear, specifically dredges and trawls, was examined. The selected management strategy includes: retain the prohibition on targeted crab dredging established in the 2016 Revision to Amendment 2; reduce the crab bycatch limit from oyster dredges to 10% of the combined crab and oyster catch or 100 pounds, whichever is less; and to prohibit the use of crab trawls in areas where shrimp trawls are prohibited in the Pamlico, Pungo, and Neuse rivers.

INTRODUCTION

This is Amendment 3 to the N.C. Blue Crab Fishery Management Plan (FMP). The last review of the plan concluded in November 2013 and resulted in Amendment 2 to the plan. There was a revision to Amendment 2 in May 2016 to implement management changes resulting from the adaptive management strategy in Amendment 2. That strategy relied on the Traffic Light Stock Assessment to provide information on the relative condition of the stock. In August 2016, the N.C. Marine Fisheries Commission (NCMFC) directed the next review of the plan to begin immediately instead of in 2018, despite the five-year span statutorily allowed. In Amendment 3, this management strategy is replaced by an adaptive management framework based on a comprehensive stock assessment for blue crab that is updated at least once in between scheduled plan reviews.

DEFINITION OF MANAGEMENT UNIT

The management unit includes the blue crab (*Callinectes sapidus*) and its fisheries in North Carolina coastal waters.

MANAGEMENT AUTHORITY

The Fisheries Reform Act of 1997 (FRA) and its subsequent amendments established the requirement to create FMPs for all of North Carolina's commercially and recreationally significant species or fisheries. The FRA "recognizes the need to protect our coastal fishery resources and to balance the commercial and recreational interests through better management of these resources" and requires the NCMFC "to provide fair regulation of commercial and recreational fishing groups in the interest of the public." Fishery management plans normally take about two years to complete and are required to be reviewed at least once every five years. Upon review, amendment of a plan is required when changes to management strategies are necessary. Through this process, the commission also has authority to implement federal fishery regulations (as minimum North Carolina standards) through the N.C. Fishery Management Plan for Interjurisdictional Fisheries, which selectively adopts management measures contained in approved federal Council or Atlantic States Marine Fisheries Commission (ASMFC) FMPs by reference. The goal of FMPs is to provide direction for the management of a fishery and to ensure long-term viability of North Carolina fisheries. It is a science-based management approach designed to include balanced stakeholder input from all sides, to look at the available data, to recognize the gaps, and to agree to the best possible path to manage the fisheries while acknowledging and minimizing impacts to various groups.

Under § 113-182.1, each FMP shall contain necessary information pertaining to the fishery or fisheries, as well as include conservation and management measures that will provide the greatest overall benefit to the State, particularly with respect to food production, recreational opportunities, the protection of marine ecosystems, and that will produce a sustainable harvest. For these purposes, data are gathered, analyzed, interpreted, and management measures implemented. The division is empowered to collect scientific and statistical information as may be needed to determine conservation (§ 113-131; § 143B-286). FMPs are the ultimate product that bring all the information and considerations into one document for a species.

North Carolina's coastal fishery resources (the "fish") exist within a system of interdependent habitats that provide the basis for long-term fish production available for use by people (the "fisheries"). The FRA law also recognized the importance of having sufficient quantity of quality habitat to support fish species throughout their life history. Because of this relationship between habitat and fish populations, the law contains the directive to protect and enhance habitats supporting coastal fisheries through the creation of Coastal Habitat Protection Plans (CHPP, G.S. 143B-279.8). While much of the concern over declining fish stocks has been directed at overfishing, habitat loss and degradation may make a stock more susceptible to decline. The effect of habitat loss and degradation can be indicated by the lack of recovery of certain stocks after fishing pressure is reduced. The CHPP law specifically requires identification of "existing and potential threats to the habitats" and "actions to protect and restore the habitats" (G.S. 143B-279.8). Under the law the NCMFC shall ensure, to the maximum extent practicable, their actions are consistent with the Coastal Habitat Protection Plan and shall adopt rules to implement Coastal Habitat Protection Plans in accordance with Chapter 150B of the General Statutes. Either the FMP or CHPP statutes may provide the management authority for requiring habitat measures, but generally the FMP authority has only been employed when there is a specific detrimental habitat threat from a fishery.

The [N.C. General Assembly](#) enacts fisheries statutes, or laws, and provides the NCMFC authority to adopt rules to implement those statutes. These rules are found in Chapters 03 and 18A of Title 15A of the [N.C. Administrative Code](#). The N.C. Department of Environmental Quality (NCDEQ) is the parent agency of the commission and the N.C. Division of Marine Fisheries (NCDMF). The commission is responsible for managing, protecting, preserving and enhancing the marine and estuarine resources under its jurisdiction. In support of these responsibilities, the division conducts management, enforcement, research, monitoring, statistics and licensing programs to provide information on which to base decisions on rule making. The division presents information to the commission and department in the form of fishery management and coastal habitat protection plans and proposed rules. The division also administers and enforces the commission's adopted rules. Another tool the state uses to manage fisheries is the proclamation. The commission has the authority to delegate to the fisheries director the ability to issue public notices, called proclamations, suspending or implementing particular commission rules that may be affected by variable conditions. The proclamation authority granted to the fisheries director includes the ability to open and close seasons and fishing areas, set harvest and gear limits, and establish conditions governing various fishing activities. Proclamation authority and proclamation measures are codified in rules.

GOAL AND OBJECTIVES

Goal: Manage the blue crab fishery to achieve a self-sustaining population that provides sustainable harvest using science-based decision-making processes. The following objectives will be used to achieve this goal.

Objectives:

1. Implement management strategies that maintain/restore the blue crab spawning stock with multiple cohorts and adequate abundance to prevent recruitment overfishing.
2. Restore, enhance, and protect habitat and environmental quality necessary to maintain or increase growth, survival, and reproduction of the blue crab population.

3. Use biological, environmental, habitat, fishery, social, and economic data needed to effectively monitor and manage the blue crab fishery and its ecosystem impacts.
4. Promote stewardship of the resource through increased public awareness regarding the status and management of the blue crab fishery, including practices that minimize bycatch and discard mortality.

FISHERY MANAGEMENT PROGRAM IMPLEMENTED UNDER AMENDMENT 2 (2013)

MANAGEMENT MEASURES IN PLACE UNDER AMENDMENT 2 (2013)

All management authority for the North Carolina blue crab fishery is vested in the State of North Carolina. The NCMFC adopts rules and policies and implements management measures for the blue crab fishery. See Appendix 4 for a list of statutes, rules, and regulations under Amendment 2 to the N.C. Blue Crab FMP. This summary does not maintain exact language and should not be relied upon for legal purposes. See North Carolina General Statutes, North Carolina Administrative Code and Proclamations for exact language. There are no federal or interstate FMPs that apply specifically to the blue crab fishery in North Carolina.

Amendment 2 to the N.C. Blue Crab FMP was adopted in November 2013 (for a timeline of plans, amendments, and related documents see Appendix 2). This amendment replaced the spawner index trigger with an adaptive management framework based on an annual Traffic Light Stock Assessment update, provided management recommendations, explored issues affecting the fishery, and listed research recommendations to fill data needs. Rules established in Amendment 2 went into effect April 2014. Management changes included: opening the Pungo River to pots, closing Lower Broad Creek to pots, modifying crab dredging rules to conform with current harvest management, incorporating the Pamlico Sound four-inch crab trawl line into rule, redefining criteria exempting escape rings to unbaited pots and pots baited with a male crab, repealing proclamation authority allowing escape ring requirement, exemption to harvest peeler crabs, adopting no trawl line boundaries in the Pamlico Sound and Newport River for areas where escape ring closures are allowed, modification of trawl nets rule to identify Pamlico, Back, and Core sounds as areas that can open under proclamation for peeler crab trawling, modification to clearly state in rule the intent of the exceptions, culling tolerance, separation requirements for various crab categories, and established proclamation authority to require terrapin excluders (once a framework of criteria and excluder specifications were approved by the NCMFC).

In November 2016, adaptive management measures were implemented under the authority of Amendment 2. These included: reducing the cull tolerance from 10% to 5%, requiring an additional escape ring mounted in the upper chamber within one full mesh of the corner and divider of the pot, eliminating harvest of immature female hard crabs, prohibiting the harvest of dark sponge crabs (brown and black) from April 1 through April 30, and prohibiting harvest of crabs with dredges except incidental to lawful oyster dredging. All adaptive management measures became effective June 6, 2016 except for the additional cull ring which was delayed until January 15, 2017. This delay coincided with the annual pot closure period to allow fishermen time to modify pots.

COMPLIANCE AND ENFORCEMENT

There are two main sources of data necessary for fisheries management and evaluated for each FMP: fishery dependent and fishery independent data. Fishery dependent data are derived from the fishing process itself and are collected through such avenues as self-reporting, fish house surveys, onboard observers, telephone surveys or vessel-monitoring systems. Fishery dependent sampling allows managers to account for sources of removals and the size and age structure of those removals. Fishery-independent data comes from research and monitoring surveys conducted by the state agencies. Scientists take samples throughout the potential range of the target fish(s) based on statistically valid sample designs that are not influenced by changes in fishing activity. Fishery independent sampling allows managers to monitor trends in the relative abundance of a species. Fishery dependent and independent sampling complement one another to provide a more complete picture of the condition of a fish stock. Dependent sampling intended to monitor trends in relative abundance can be biased by changes in: gear specifications, fishing effort, areas fished, level of expertise of fishermen, technology, etc.

The division's License and Statistics Program is another source of fishery dependent information. The number of licenses issued to various types of fishermen such as the Standard Commercial Fishing License (SCFL), Retired Standard Commercial Fishing License (RSCFL), Commercial Fishing Vessel Registration (CFVR), Recreational Commercial Gear License (RCGL), and Coastal Recreational Fishing License (CRFL) may be used to determine the number of fishermen and vessels involved in various fisheries. These licenses are authorized in Chapter 113 of the North Carolina General Statutes.

The North Carolina Marine Patrol has officers working in three distinct law enforcement districts along the coast. In addition to checking commercial and recreational fishermen, officers patrol waterways, piers, and beaches in coastal areas. They also inspect seafood houses, vehicles transporting seafood, and restaurants across the state to ensure compliance with fisheries rules. In addition to the inspections listed above, the Marine Patrol have mandatory patrol responsibilities. The U.S. Food and Drug Administration requires North Carolina to patrol a certain number of hours in polluted waters each year. This is a primary function for the North Carolina Marine Patrol to ensure the health and welfare of consumers of North Carolina shellfish. The Marine Patrol also assists the observer program with gill net observations to ensure the division meets the required observer coverage as required by its federal Incidental Take Permits (ITPs). Failure to follow the requirements of the ITPs through lack of sufficient observer coverage could cause the estuarine gill net fishery to close completely.

DESCRIPTION OF THE STOCK

BIOLOGICAL PROFILE

Physical Description

Blue crabs are one of the most recognizable species of North Carolina. A swimming crustacean sought after for tender, sweet meat. Blue crabs have a carapace (shell) which has nine marginal teeth, the final one forming a distinct point. The carapace varies from blue to dark olive green.

Blue crabs have five pairs of legs: bright blue claws often having red tips, three pairs of walking legs, and specially adapted paddle-shaped rear swimming legs. Male and female blue crabs are easily identified by the shape of the apron on their abdomen (underside). A male crab is easily recognized by the T-shaped apron (Figure 1 A). The immature female apron is triangular-shaped and held tightly against the abdomen (Figure 1 B). The mature female's apron becomes rounded and can be easily pulled away from the body after the final molt (Figure 1 C). When mature females develop an egg mass (sponge) it is visible beneath the apron ranging from bright orange to black (Figure 1 D).

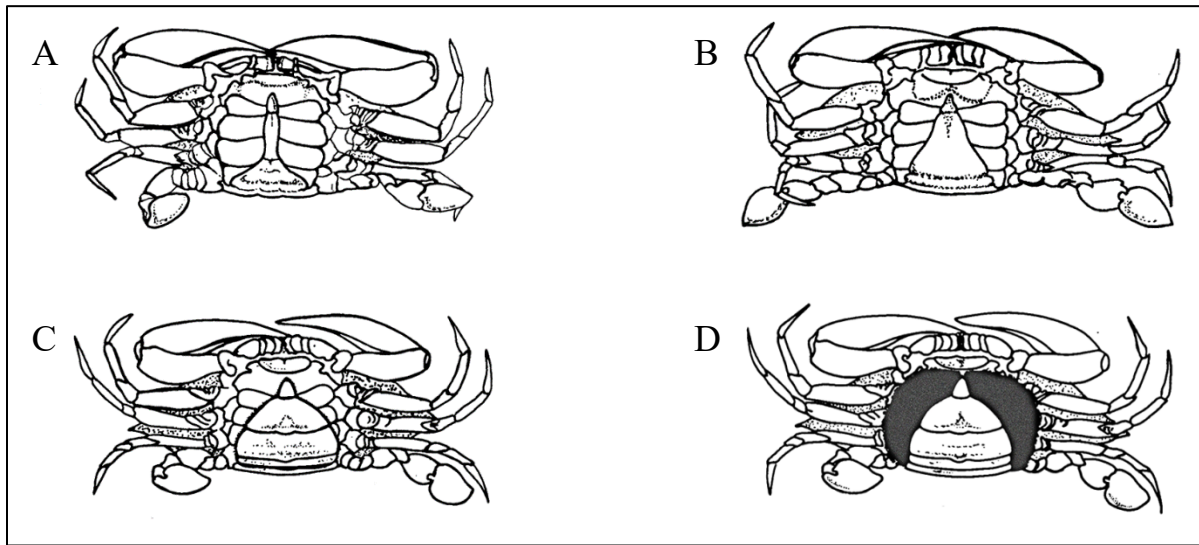


Figure 1 Apron shape differences between male and female blue crabs and immature and mature female blue crabs. A. “Jimmy” – male blue crab. B. “She-crab” – immature female blue crab. C. “Sook” – mature female blue crab. D. “Sponge crab” – Egg bearing mature female blue crab.

Distribution

The first larval stage (zoea) of blue crabs occurs offshore for several weeks where it undergoes several developmental stages before metamorphosing (transforming) into the next stage, called megalopae (1; 2). Because of the lack of inlets in Albemarle Sound, megalopae are transported primarily into Pamlico Sound, North Carolina via onshore wind events and nighttime incoming spring tides (3), which may be overshadowed by tropical storms, depending on frequency and wind direction (4). Megalopae then settle in seagrass beds in the seaward portion of the sounds before exhibiting density-dependent secondary dispersal resulting in juveniles being widely distributed throughout the estuaries of North Carolina (5). This means that as more crabs enter grass beds and crabs grow they will begin to migrate to areas with less crabs. Decreases in salinity and the presence of bottom structure encourage settlement after this secondary migration. Therefore, crabs begin to prefer the fresher waters of the rivers and western portions of the sounds. After growth and maturation, females migrate to spawn in the high-salinity waters near the inlets (6). Other studies have also shown that the migratory behavior of mature female blue crabs continues between clutches (batch of eggs), and spawning females are continually moving seaward through the spawning season (7; 8; 9). Males do not migrate regularly as adults (10).

Habitat

Blue crabs require both inshore brackish waters and high salinity ocean waters during their life cycle (6). The preferred habitat of blue crabs is tidal marsh estuaries characterized by soft mud bottom and waters of moderate salinity (11). Juvenile blue crabs use seagrass beds and areas of high detritus to grow and avoid predators (12). Adult blue crabs have different habitat preferences by sex and salinity. Mature female blue crabs are more commonly found in higher salinity waters (>10 ppt) near inlets and the eastern side of the sounds. While males prefer lower salinities (3 to 15 ppt) predominantly in the rivers and on the western side of the sounds.

Reproduction

Blue crabs mature between one and two years of age in North Carolina (13). Estimates of length at 50% maturity range from 3.9 in (98.8 mm) in 1999 to 4.9 in (125.7 mm) in 2015. Mating occurs during the spring or summer in brackish estuarine waters as females molt into maturity (14; 6). Spawning typically occurs within two months after mating if mating occurs early in the growing season; however, females can retain sperm through winter for spawning the following spring (15; 14). Spawning is initiated after migration to high-salinity areas near oceanic inlets. In the Chesapeake Bay, Prager et al. (16) found that fecundity (fertility) was significantly related to carapace width and estimated that average fecundity was 3,200,000 eggs per clutch. Females may spawn once or several times a season. In North Carolina, spawning has two peak pulses, April–June and August–September (9).

Age and Growth

Blue Crabs undergo seven to eight developmental stages [Figure 2; (17; 18; 2)]. Molting is a process of growth in blue crabs that requires shedding the hard exoskeleton. Fischler (19) reported an average life span of three years for blue crabs in North Carolina and a maximum size of around 8.5 in (217 mm). Estimates of maximum age have ranged between five and eight years for blue crabs in the Chesapeake Bay (20). Traditional growth models used for finfish are impractical to apply to crustaceans in general because the models assume growth is continuous (21; 22). For blue crabs and other crustaceans, the shell grows in discrete stages via shedding of the exoskeleton (molt). Carapace-width-to-length relationships have been estimated for blue crabs sampled from many estuaries throughout their range in the eastern United States (23; 24).

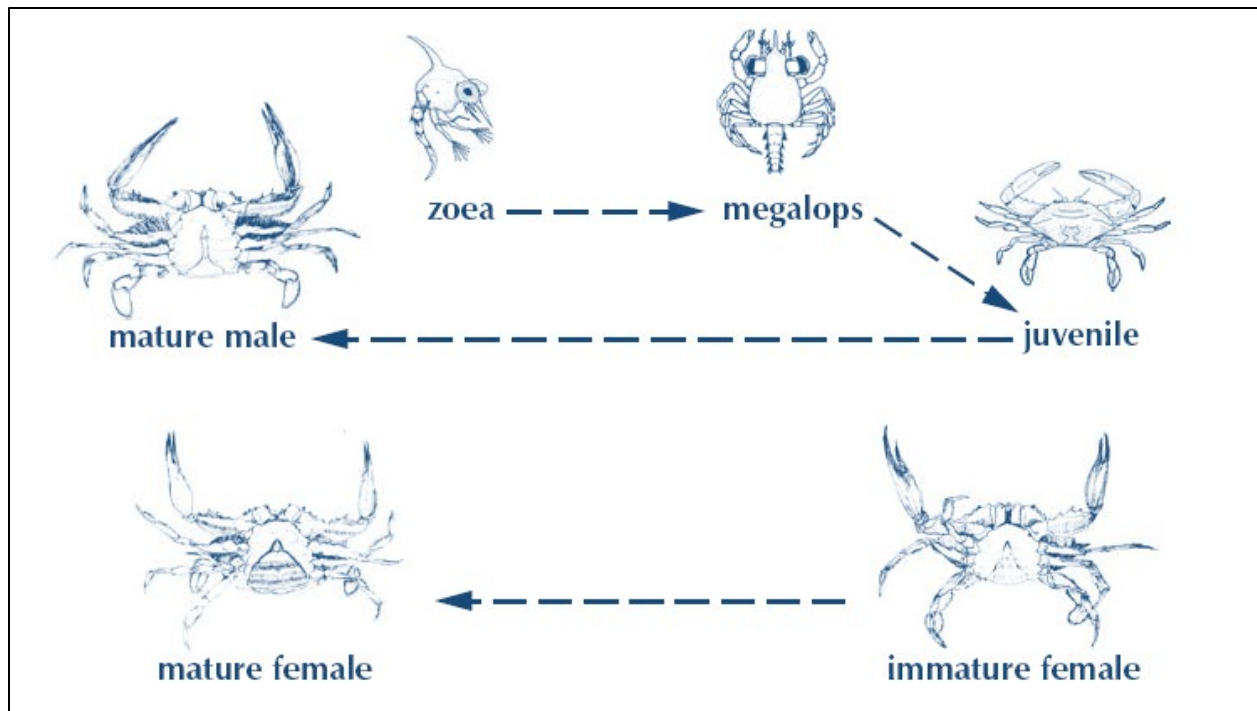


Figure 2 Lifecycle of the blue crab (*Callinectes sapidus*). (6).

Growth in blue crabs is rapid the first summer and is dependent on temperature, molt frequency, food quality and availability, and life stage. Optimum growth of blue crabs occurs at temperatures between 59°F (15°C) to 86°F (30°C), and growth stops when the temperature goes below 50°F (10°C) (25). In temperate regions, where winter temperatures regularly fall below this threshold, blue crabs bury into the sediment. During this dormant period, no growth occurs, thereby extending the time to reach maturity (26). Laboratory observations indicate that growth of blue crabs is 12% to 35% per molt (25). Most blue crabs go through 18 to 20 post-larval molts before becoming sexually mature (1).

Ageing crustaceans is notoriously difficult. Crustaceans do not have persistent hard parts usually used to track and count rapid- and slow-growing periods to determine age. Recent advances in quantifying and calibrating oxidation products (lipofuscins) in nerve tissue have been promising as an alternative to the traditional carapace width estimators used to calibrate carapace width with age estimates. Lipofuscin extraction, however, is a new and costly technique that has not been widely used in ageing laboratories (27). A study in Florida, using two known age cohorts, found that lipofuscin indices were negatively correlated to age (28). These results suggest that more research is needed before this method can be used to age blue crabs.

Recently, another method that has been used to determine age in crustaceans is analyzing growth bands found around the calcified region of the eyestalk or gastric mill in shrimp, crabs, and lobsters (29). While this method has been successful to estimate age in longer-lived, cold water crustaceans like the American lobster (*Homarus americanus*), this method has not been tested in blue crabs.

Predator-Prey Relationships

Blue crabs consume a wide variety of food, fulfilling roles as predators and detritivores (animals that feed on dead organic material). They are large consumers of annelid worms (bristle worms, leeches, and other segmented worms), crustaceans, live or dead fish, vegetation, detritus, and feed heavily on oyster spat and juvenile clams (30). Bivalve mollusks (clams, oysters, mussels, and scallops) are a major portion of blue crab diets (31; 32; 33). They are also cannibalistic, and larger crabs are capable of exhibiting a check on population growth by consuming large amounts of small crabs and juveniles. Blue crabs are a part of the diets many recreationally important species, including striped bass, black drum, red drum, bluefish, southern flounder, and Atlantic croaker (34).

STOCK STATUS

Stock Unit Definition

The unit stock includes all blue crabs in North Carolina coastal fishing waters.

Assessment Methodology

A comprehensive stock assessment approach, the sex-specific two-stage model, was applied to available data to assess the status of North Carolina's blue crab stock during 1995–2016. Data were available from commercial fishery monitoring programs and several fishery-independent surveys. The two-stage model was developed based on the catch-survey analysis designed for species lacking information on the age structure of the population. The model synthesized information from multiple sources, tracked population dynamics of male and female recruits and fully recruited animals, estimated critical demographic and fishery parameters such as natural and fishing mortality, and thus, provided a comprehensive assessment of blue crab status in North Carolina. The hierarchical Bayesian approach was used to estimate model parameters, which can incorporate uncertainty associated with the data and model assumptions (35). The stock status of North Carolina blue crab in the current assessment (36) was determined based on maximum sustainable yield (MSY).

Current Stock Status

Based on the results of the assessment, the North Carolina blue crab stock in 2016 is overfished with a probability of 0.98, given the average spawner abundance in 2016 being estimated at 50 million mature female blue crabs (below the threshold estimate of 64 million). Overfishing is also occurring in 2016 with a probability of 0.52, given the average fishing mortality in 2016 being estimated at 1.48 (above the fishing mortality threshold estimate of 1.46; (35).

DESCRIPTION OF THE FISHERIES

A more in depth analysis and discussion of North Carolina's commercial and recreational blue crab fisheries can be found in earlier versions of the Blue Crab FMP (37; 11; 38); all documents are available on the NCDMF website at: <http://portal.ncdenr.org/web/mf/fmps-under->

[development](#)) or the License and Statistics Annual Report (39) produced by the division which can be found at: <http://portal.ncdenr.org/web/mf/marine-fisheries-catch-statistics>.

The socio-economic information presented is about the current fishery and is not intended to be used to predict potential impacts from management changes. However, this and other information pertaining to fishery management plans is included to help inform decision-makers regarding the long-term viability of the state's commercially and recreationally significant species or fisheries. For a detailed explanation of the methodology used to estimate the economic impacts please refer to the NCDMF License and Statistics Section Annual Report (39).

COMMERCIAL FISHERY

Blue crab supports the largest and most valuable commercial fishery in North Carolina, accounting for landings of 27.8 million pounds with an ex-vessel value of \$26.9 million in 2016 (Table 1). North Carolina has historically accounted for approximately 22% of annual Atlantic coast blue crab landings since 1950 (Figure 3). Landings of blue crab in North Carolina have fluctuated through time but peaked in the late 1990s (Figure 4).

Table 1 Blue crab commercial landings (millions of pounds) and value (millions of dollars) for hard, soft, and peeler crabs combined from major blue crab producing states, 2007-2016. Source: (40)

State \ Year	2007	2008	2009	2010	2011	2012
Alabama	2.6 / \$1.7	1.8 / \$1.5	1.5 / \$1.0	0.9 / \$0.7	1.6 / \$1.1	1.3 / \$1.0
Delaware	3.8 / \$5.3	3.5 / \$4.6	3.4 / \$5.4	4.1 / \$6.0	3.5 / \$4.8	4.6 / \$6.7
Florida East Coast	4.1 / \$4.9	3.3 / \$4.3	1.6 / \$2.4	2.6 / \$3.4	3.2 / \$4.2	3.4 / \$4.7
Florida West Coast	6.1 / \$5.8	2.7 / \$3.3	3.4 / \$4.2	5.8 / \$6.7	6.8 / \$7.7	4.2 / \$5.1
Georgia	4.4 / \$3.8	4.2 / \$3.9	3.6 / \$3.8	2.3 / \$2.6	3.4 / \$3.3	4.3 / \$4.3
Louisiana	45.1 / \$35	41.7 / \$32.2	53.1 / \$37.3	30.8 / \$30.3	43.9 / \$36.8	46.3 / \$43.9
Maryland	30.8 / \$41.7	34.9 / \$50.1	38.8 / \$52	66.3 / \$79.1	51.2 / \$60.3	43.7 / \$60.5
Mississippi	0.7 / \$0.7	0.5 / \$0.4	0.5 / \$0.6	0.4 / \$0.4	0.4 / \$0.3	0.8 / \$0.7
New Jersey	4.6 / \$5.5	5.8 / \$7.3	0.3 / \$0.2	9.5 / \$12	9.6 / \$9.4	7.4 / \$10.0
New York	0.7 / \$1.2	0.5 / \$0.9	0.9 / \$1.2	1.0 / \$1.6	0.5 / \$0.8	0.1 / \$0.2
North Carolina	21.4 / \$21.4	32.9 / \$27.6	29.7 / \$27.4	30.7 / \$26.4	30.0 / \$21.3	26.8 / \$22.8
South Carolina	4.1 / \$3.5	4.5 / \$4.2	4.0 / \$4.1	3.3 / \$3.6	5.4 / \$5.1	5.9 / \$5.8
Texas	3.5 / \$2.8	2.6 / \$2.3	2.8 / \$2.5	3.4 / \$3.1	2.9 / \$2.8	2.9 / \$2.9
Virginia	25.1 / \$15.8	23.2 / \$18	32.8 / \$21.2	38.5 / \$29.1	39.7 / \$26.3	33.1 / \$24.6

State \ Year	2013	2014	2015	2016	Average	Percent of Total Landings
Alabama	1.0 / \$1.0	1.2 / \$1.3	1.3 / \$1.2	1.9 / \$1.8	1.5 / \$1.2	0.9%
Delaware	2.5 / \$4.6	2.0 / \$4.4	2.1 / \$4.5	3.9 / \$7.9	3.3 / \$5.4	2.0%
Florida East Coast	2.2 / \$3.8	1.5 / \$3.1	1.6 / \$3.4	1.6 / \$3.2	2.5 / \$3.7	1.5%
Florida West Coast	4.5 / \$6.5	4.5 / \$7.4	4.9 / \$8.5	3.5 / \$6.1	4.6 / \$6.1	2.8%
Georgia	3.2 / \$4.0	2.7 / \$3.8	2.9 / \$4.2	3.1 / \$3.7	3.4 / \$3.7	2.0%
Louisiana	39.2 / \$51.6	43.2 / \$66.7	41.3 / \$58.1	40.1 / \$49.4	42.5 / \$44.1	25.3%
Maryland	24.2 / \$50.0	24.7 / \$52.8	28.7 / \$52	34.9 / \$60.7	37.8 / \$55.9	22.5%
Mississippi	0.4 / \$0.4	0.6 / \$1.0	0.8 / \$1.2	0.8 / \$0.9	0.6 / \$0.7	0.3%
New Jersey	4.4 / \$8.1	3.2 / \$4.1	7.2 / \$8.7	6.9 / \$7.7	5.9 / \$7.3	3.5%
New York	0.1 / \$0.2	0.3 / \$0.6	0.2 / \$0.4	0.2 / \$0.4	0.5 / \$0.8	0.3%
North Carolina	22.2 / \$30.0	26.2 / \$34.0	32.1 / \$34.0	25.5 / \$24.1	27.8 / \$26.9	16.5%
South Carolina	5.1 / \$6.4	3.8 / \$5.8	3.7 / \$4.8	4.4 / \$5.5	4.4 / \$4.9	2.6%
Texas	1.9 / \$2.3	2.2 / \$3.1	4.3 / \$5.5	5.0 / \$6.4	3.2 / \$3.4	1.9%
Virginia	24.3 / \$24.0	24.2 / \$27.0	29.7 / \$33.1	28.1 / \$40.9	29.9 / \$26	17.8%

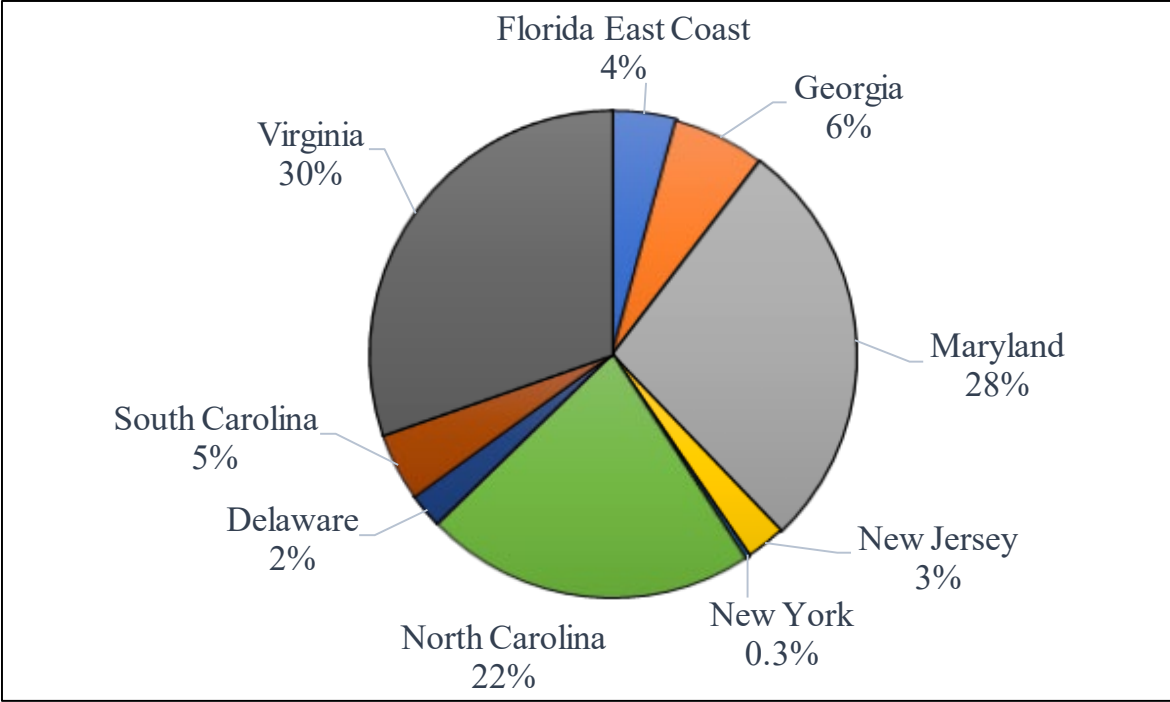


Figure 3 Average contribution to U.S. Atlantic coast blue crab landings by state, 1950-2016. Source: (40)

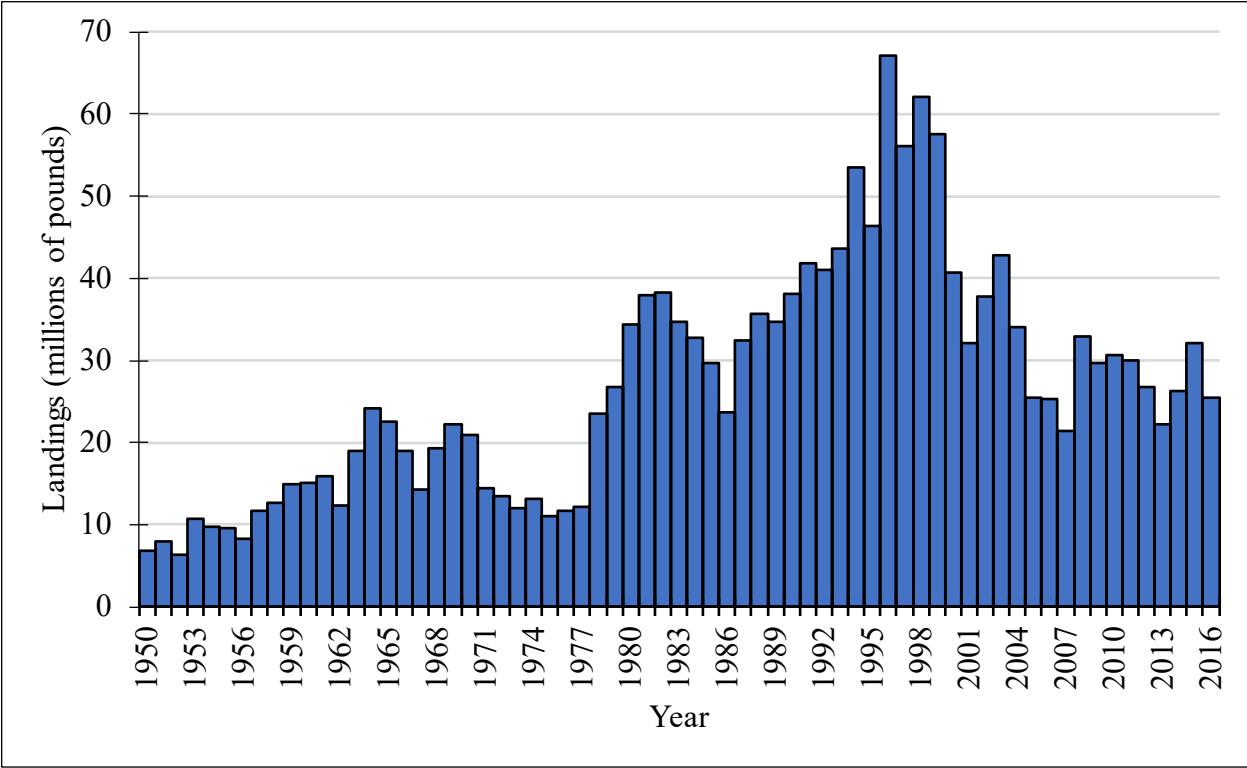


Figure 4 North Carolina annual blue crab commercial landings, 1950-2016. Source: (40)

Commercial Fishery Data Collection

In North Carolina, fishermen have been harvesting blue crabs commercially since the 1800s, with the earliest documented landings reported in 1889 (41). However, landings statistics are patchy prior to 1950. In 1994, the NCDMF implemented a mandatory trip ticket program to monitor commercial landings and fishing effort. Through this program, the NCDMF collects commercial landings data on a trip basis from licensed seafood dealers. The NCDMF requires dealers purchasing blue crabs from commercial fishermen to submit trip tickets that capture information about their catch, such as what was harvested, where it was caught, how it was caught, and how much was harvested. Commercial fishermen who sell their catch directly to consumers are required to possess a dealer's license and submit trip tickets.

The NCDMF's License and Statistics section conducts economic research pertaining to North Carolina and Atlantic coastal fisheries using information from the trip ticket program and surveys. This section publishes results annually in the [License and Statistics Annual Report](http://portal.ncdenr.org/web/mf/marine-fisheries-catch-statistics) (39; <http://portal.ncdenr.org/web/mf/marine-fisheries-catch-statistics>) and also provides information to NCDMF and other agencies to support scientific research and resource management.

Unless otherwise noted, all data presented in the following sections are from the NCDMF trip ticket program. Data are presented from 2007 to 2016. Trends are shown for the ex-vessel value and harvest volume is presented in pounds.

Annual Landings and Value

Average blue crab landings in North Carolina between 2007 and 2016 were 27.8 million pounds (Table 2). The lowest landings during this period was 21.4 million pounds in 2007 and the highest was 32.9 million pounds in 2008.

Annual ex-vessel value of commercial blue crab landings averaged \$26.9 million from 2007 to 2016 (Table 2). Annual ex-vessel value reached a low of \$21.3 million in 2011 and a high of \$33.7 million in 2015.

Ex-vessel price per pound of blue crabs (ex-vessel value divided by annual commercial landings) average \$0.97 per pound from 2007 to 2016 (Table 2). Ex-vessel price per pound reached a low of \$0.71 per pound in 2011 and a high of \$1.35 per pound in 2013.

Table 2 North Carolina commercial blue crab landings and value, 2007-2016.

Year	Harvest	Reported Ex-vessel Value	Reported Ex-vessel Price Per Pound	Inflation Adjusted Ex-vessel Value	Inflation Adjusted Price Per Pound
2007	21,424,960	\$21,431,955	\$1.00	\$26,480,167	\$1.24
2008	32,916,691	\$27,555,386	\$0.84	\$30,679,127	\$0.93
2009	29,707,232	\$27,428,995	\$0.92	\$30,805,897	\$1.04
2010	30,683,011	\$26,543,791	\$0.87	\$28,401,979	\$0.93
2011	30,035,392	\$21,282,264	\$0.71	\$21,190,451	\$0.71
2012	26,785,669	\$22,806,938	\$0.85	\$22,806,938	\$0.85
2013	22,202,623	\$30,006,447	\$1.35	\$30,308,482	\$1.37
2014	26,230,965	\$34,027,403	\$1.30	\$32,887,456	\$1.25
2015	32,134,501	\$33,724,424	\$1.05	\$33,616,270	\$1.05
2016	25,459,475	\$24,112,715	\$0.95	\$24,116,347	\$0.95
Average	27,758,052	\$26,892,032	\$0.97	\$28,129,312	\$1.01

Landings by Crab Type

In North Carolina, fishermen harvest hard-shell, soft-shell, and peeler blue crabs (Figure 5). Peeler blue crabs still have a hard shell but are in the pre-molt stage (i.e., a white line is present on the swimming leg). Hard-shell blue crabs are typically sold to: 1) wholesale/retail seafood dealers that grade, pack, and ship blue crabs to live markets or crab processors, 2) retail seafood dealers, and 3) consumers directly.

Hard-shell blue crabs sold to live markets are typically graded by size. Grading occurs either onboard the vessel or at the dock. Graded sizes vary based on crab abundance and market demands but generally include:

- Number 1 males: greater than 5.75 inches carapace width (CW)
- Number 2 males: 5.25 to 6 inches CW
- Number 3 females: greater than 5.5 inches CW
- Straights and Culls: smaller crabs destined for processing

Blue crab fishermen also cull and shed peeler blue crabs either in their own facility or sell them to other shedding operations.

Hard-shell blue crab landings accounted for 97.0% of the cumulative landings and 88.2% of the cumulative ex-vessel value of blue crabs harvested in North Carolina from 2007 to 2016. Average hard shell blue crab landings during this period were 26.9 million pounds (Table 3). Landings fluctuated from a low of 20.6 million pounds in 2007 to a high of 32.3 million pounds in 2008. During this period, the ex-vessel price per pound ranged from a low of \$0.62 in 2011 to a high of \$1.23 in 2013.

The harvest of soft-shell and peeler blue crabs is minor compared to hard-shell blue crabs but they are an economically important sector of the blue crab fishery as they tend to command a

higher market price. Soft-shell crabs primarily come from crab shedding operations. In these operations, peeler blue crabs are placed into open or closed recirculating tank systems and sorted according to molt stage. Once a crab sheds it is immediately removed because it is very vulnerable to predation from other crabs and to prevent the shell from hardening to a point the crab becomes unmarketable.

Soft-shell blue crabs comprised 1.2% of the total landings and 6.8% of the total ex-vessel value of blue crab landings from 2007 to 2016. Average soft-shell blue crab landings during this period were 323,080 pounds (Table 3). Landings fluctuated from a low of 198,876 pounds in 2009 to a high of 446,405 pounds in 2011. The ex-vessel price per pound averaged \$5.72 from 2007 to 2016, almost six and half times the average ex-vessel price per pound for hard-shell blue crabs during the same period.

Peeler blue crabs accounted for 1.8% of the total landings and 5.0% of the total ex-vessel value of blue crab from 2007 to 2016. During this period, average peeler blue crab landings ranged from a low of 351,995 pounds in 2008 to a high of 706,671 pounds in 2015 (Table 3). From 2007 to 2016, the real ex-vessel price per pound for peeler blue crabs averaged \$2.66, roughly three times the average ex-vessel price per pound for hard-shell blue crabs during this period.

Table 3 Landings and real ex-vessel price per pound of North Carolina blue crabs by type, 2007-2016.

Year	Hard-shell	Peeler	Soft-shell
2007	20,562,166 / \$0.88	498,917 / \$2.38	363,918 / \$5.87
2008	32,338,899 / \$0.79	351,995 / \$2.51	225,822 / \$5.51
2009	29,140,483 / \$0.86	367,904 / \$3.01	198,876 / \$6.45
2010	29,794,332 / \$0.80	568,228 / \$2.11	320,480 / \$4.82
2011	28,964,480 / \$0.62	624,376 / \$1.90	446,405 / \$4.66
2012	25,991,391 / \$0.78	468,867 / \$2.37	325,426 / \$4.60
2013	21,438,089 / \$1.23	447,135 / \$3.24	317,425 / \$6.59
2014	25,242,662 / \$1.19	621,046 / \$3.12	367,284 / \$5.82
2015	31,040,019 / \$0.95	706,671 / \$2.99	380,379 / \$5.67
2016	24,732,129 / \$0.84	445,843 / \$2.95	284,786 / \$7.24
Average	26,924,465 / \$0.89	510,098 / \$2.66	323,080 / \$5.72

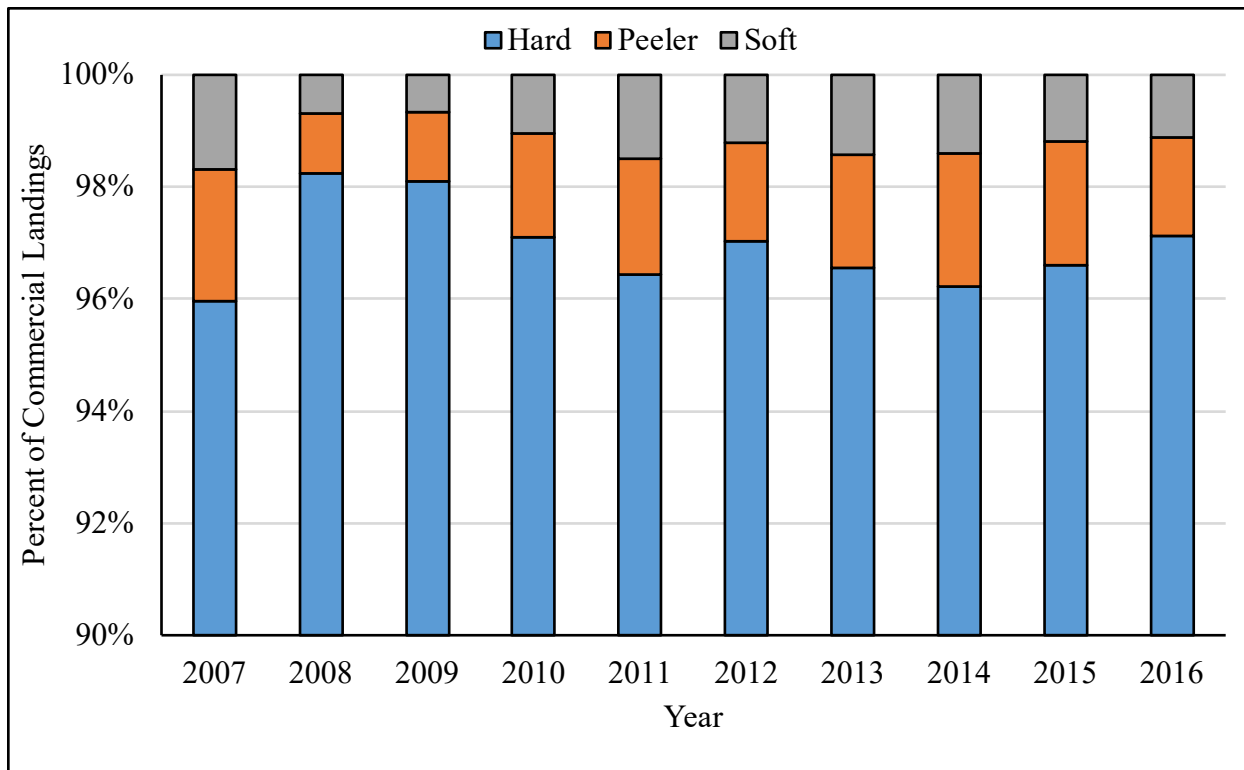


Figure 5 North Carolina blue crab commercial landings percent by type, 2007-2016.

Landings by Season

Commercial blue crab landings in North Carolina vary by season. Landings are lowest in January and February, averaging approximately 89,230 pounds and \$78,159 monthly (from 2007 to 2016; Table 4). Average monthly landings are highest in the summer months: 4.2 million pounds and \$4.1 million in June, 4.0 million pounds and \$3.8 million in July, and 4.3 million pounds and \$3.9 million in August.

Average ex-vessel price per pound also fluctuates seasonally (Table 4). From 2007 to 2016, average ex-vessel price per pound ranged from \$0.70 per pound in November to \$2.31 per pound May.

Table 4 Average monthly blue crab landings (pounds), ex-vessel value, and ex-vessel price per pound, 2007-2016.

Month	Average Landings	Average Ex-vessel Value	Average Ex-vessel Price per Pound
January	84,046	\$70,603	\$1.16
February	94,413	\$85,716	\$1.40
March	645,065	\$634,210	\$1.59
April	967,654	\$1,178,043	\$2.16
May	3,189,032	\$4,596,248	\$2.31
June	4,232,447	\$4,117,839	\$1.58
July	3,989,698	\$3,806,953	\$1.36
August	4,273,003	\$3,916,515	\$1.43
September	4,138,995	\$3,567,066	\$1.26
October	3,705,524	\$2,984,561	\$0.87
November	1,845,994	\$1,462,970	\$0.70
December	592,208	\$471,308	\$0.90

Landings by Gear Type and Vessel Length

Early blue crab fishermen used baited trotlines to harvest hard-shell blue crabs in North Carolina (41). In the mid-1960s crab pots became the most popular gear used in the blue crab fishery due to their efficiency. While several gear types are used to harvest blue crabs, most fishermen use crab pots, generally baited with Atlantic menhaden or other finfish. From 2007 to 2016, approximately 97% of the total blue crab landings have been harvested with crab pots (Table 5; Figure 6). Landings from other blue crab specific gears account for approximately 3% of the total landings and all other commercial gears account for less than 1% of the total landings. Overall, the majority of commercial blue crab landings in North Carolina are from vessels between 15 and 30 feet long. Vessels less than 15 feet long account for less than 1% of the landings on average from 2007 to 2016. Vessels 31 feet long and greater accounted for approximately 12% of the landings on average during this same period.

Table 5 Annual blue crab landings (pounds) by gear type, 2007-2016.

Year	Crab Pot	Peeler Pot	Crab Trawl	Peeler Trawl	Crab Dredge	Other	Total
2007	20,909,150	413,827	28,789	-	2,656	70,538	21,424,960
2008	30,967,910	293,679	1,557,934	-	-	97,169	32,916,691
2009	28,431,358	266,464	913,928	-	7,981	87,501	29,707,232
2010	29,789,952	489,097	286,653	2,746	52,769	61,794	30,683,011
2011	29,095,531	668,414	199,217	2,724	6,843	62,664	30,035,392
2012	26,247,049	457,413	7,608	2,466	2,335	68,798	26,785,669
2013	21,697,292	379,412	54,658	1,813	-	69,448	22,202,623
2014	25,471,904	637,572	38,059	1,843	10	81,577	26,230,965
2015	31,054,531	835,009	185,527	1,580	1,382	56,472	32,134,501
2016	24,754,952	503,728	163,250	1,323	2,958	33,264	25,459,475
Average	26,841,963	494,461	343,562	2,071	9,617	68,922	27,758,052

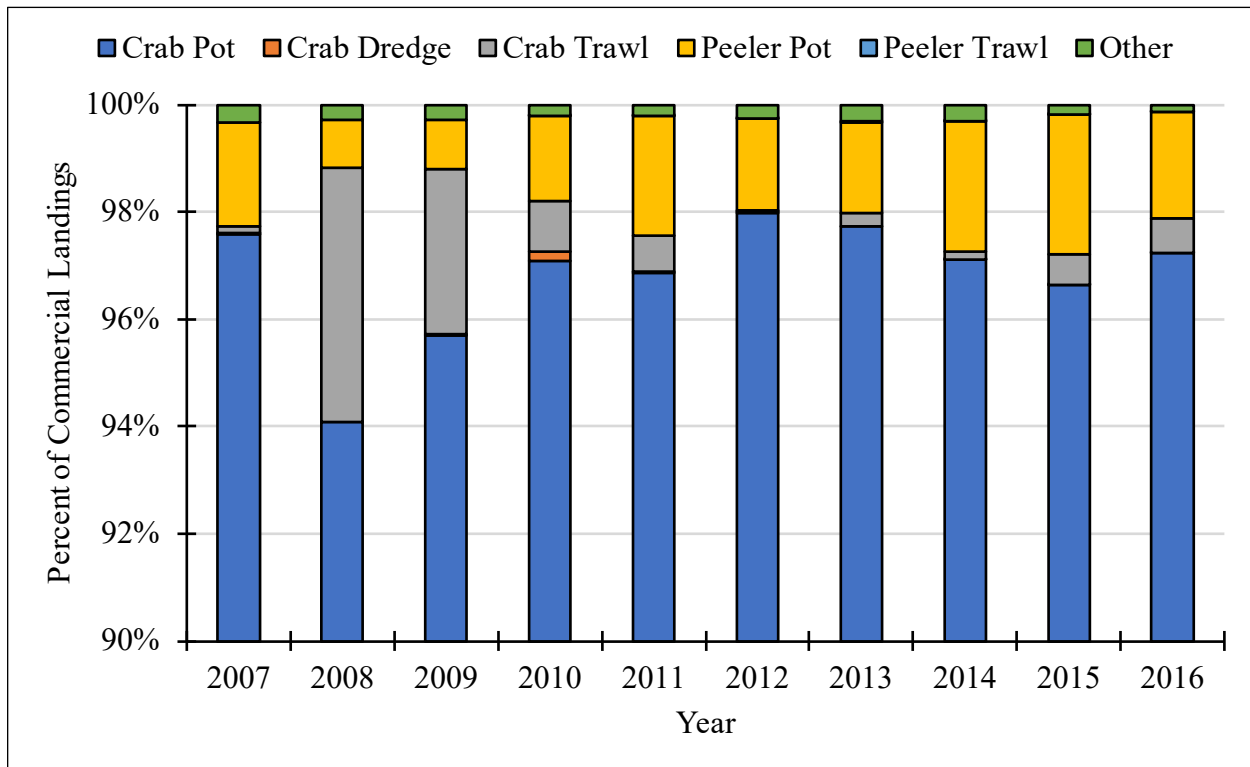


Figure 6 Percent of annual blue crab commercial landings by gear type, 2007-2016.

Landings by Area

Commercial fishermen in North Carolina are asked to identify the area in which they caught the majority of their catch during each trip. The Albemarle Sound (Albemarle Sound, Albemarle Sound Rivers, and Currituck, Roanoke, and Croatan sounds) and Pamlico Sound (Pamlico Sound and Pamlico Sound Rivers) estuary systems accounted for, on average, 93% of the total annual

blue crab harvest from 2007 to 2016 (Table 6). During this time period, the average ex-vessel value was highest in the Currituck, Roanoke, and Croatan sounds, followed by Core-Bogue sounds, Albemarle Sound, White Oak River and South, Pamlico Sound Rivers, Pamlico Sound, and Albemarle Sound Rivers.

Table 6 Blue crab landings (millions of pounds) and average ex-vessel price per pound by area, 2007-2016.

Year	Albemarle Sound Rivers	Albemarle Sound	Currituck, Roanoke, and Croatan Sounds	Pamlico Sound	Pamlico Sound Rivers	Core-Bogue Sounds	White Oak River and South	Statewide*
2007	0.8 / \$0.70	10.9 / \$1.02	3.1 / \$1.24	1.7 / \$0.96	3.2 / \$0.90	0.5 / \$0.77	1.3 / \$0.87	21.4 / \$1.00
2008	1.2 / \$0.72	17.9 / \$0.86	4.9 / \$0.92	4.2 / \$0.72	2.9 / \$0.84	0.4 / \$0.81	1.4 / \$0.75	32.9 / \$0.84
2009	1.7 / \$0.66	15.1 / \$0.96	5.6 / \$1.03	3.3 / \$0.77	2.2 / \$0.91	0.4 / \$0.88	1.4 / \$0.83	29.7 / \$0.92
2010	1.2 / \$0.71	13.6 / \$0.84	4.5 / \$0.97	4.6 / \$0.86	4.9 / \$0.85	0.5 / \$0.91	1.3 / \$1.99	30.7 / \$0.87
2011	1.6 / \$0.47	12.3 / \$0.71	4.2 / \$0.84	5.0 / \$0.68	5.0 / \$0.70	0.5 / \$0.64	1.4 / \$0.77	30.0 / \$0.71
2012	2.0 / \$0.63	12.6 / \$0.89	3.5 / \$0.96	3.6 / \$0.80	2.8 / \$0.80	0.8 / \$0.71	1.6 / \$0.87	26.8 / \$0.85
2013	2.5 / \$1.16	11.3 / \$1.40	2.7 / \$1.39	2.5 / \$1.25	1.3 / \$1.54	0.6 / \$1.27	1.3 / \$1.26	22.2 / \$1.35
2014	3.5 / \$1.10	13.1 / \$1.26	3.7 / \$1.42	2.1 / \$1.41	2.1 / \$1.44	0.6 / \$1.57	1.2 / \$1.32	26.2 / \$1.30
2015	4.1 / \$0.72	13.6 / \$1.06	4.5 / \$1.20	3.5 / \$1.03	4.6 / \$1.07	0.7 / \$1.32	1.2 / \$1.30	32.1 / \$1.05
2016	2.8 / \$0.57	9.0 / \$1.06	3.8 / \$1.06	4.2 / \$0.83	3.5 / \$0.88	0.8 / \$1.13	1.3 / \$1.08	25.5 / \$0.95
Average	2.1 / \$0.74	12.9 / \$1.00	4.0 / \$1.10	3.5 / \$0.93	3.3 / \$0.99	0.6 / \$1.00	1.3 / \$1.00	27.8 / \$0.98

*Ocean data are not presented, landings in the ocean averaged less than 8,000 pounds per year during this period.

Albemarle Sound

From 2007 to 2016, Albemarle Sound led all areas in blue crab landings, averaging just under 13 million pounds annually. Albemarle Sound is defined as Albemarle Sound proper as defined in the NCDMF Trip Ticket program. Landings peaked at 17.9 million pounds in 2008 and were lowest in 2016 (9.0 million pounds). Seasonal landings follow similar trends as most areas with highest average landings levels from June through October.

Currituck, Roanoke, and Croatan Sounds

Blue crab landings from the Currituck, Roanoke, and Croatan sounds ranked second among all areas, averaging 4 million pounds annually. This area comprises only Currituck, Roanoke, and Croatan sounds. Landings peaked at 5.6 million pounds in 2009 and were lowest in 2013 (2.7 million pounds).

Pamlico Sound

Blue crab landings from Pamlico Sound ranked third during this period averaging 3.5 million pounds annually. Pamlico Sound is defined a Pamlico Sound and its associated bays as defined

in the NCDMF Trip Ticket program. Landings peaked at 5.0 million pounds in 2011 and were lowest in 2007 (1.7 million pounds).

Pamlico Sound Rivers

Blue crab landings from Pamlico Sound rivers ranked fourth among all areas, averaging 3.3 million pounds annually. Pamlico Sound rivers include the Pamlico, Pungo, Bay, and Neuse rivers. Landings peaked at 5.0 million pounds in 2011 and were lowest in 2013 (1.3 million pounds).

Albemarle Sound Rivers

Blue crab landings from Albemarle Sound rivers ranked fifth during this period averaging 2.1 million pounds annually. Albemarle Sound rivers include the Alligator, Chowan, Pasquotank, Perquimans, and Roanoke rivers. Landings peaked at 4.1 million pounds in 2015 and were lowest in 2007 (0.8 million pounds).

White Oak River and South

Blue crab landings from the White Oak River and south ranked sixth among all areas, averaging 1.3 million pounds annually. This area includes the White Oak River and all waters south to the South Carolina state line. Landings peaked at 1.6 million pounds in 2012 and were lowest in 2014 and 2015 at 1.2 million pounds.

Core Sound and Bogue Sound

Blue crab landings from Core and Bogue sounds ranked last during this period, averaging 0.6 million pounds annually. The Core Sound and Bogue Sound area includes Core, Back, and Bogue sounds and the North and Newport rivers. Landings peaked at 0.8 million pounds in 2012 and 2016 and were lowest in 2008 and 2009 at 0.4 million pounds.

Demographic Characteristics

The average age of commercial fishermen involved in the blue crab fishery ranged from 45 years old in 2016 to 49 in 2012, 2013, and 2015 (Table 7). Most commercial fishermen are also male and Caucasian (Tables 8 and 9).

Table 7 Average age of commercial fishermen who harvested blue crab from 2007 – 2016.

Year	Average Age
2007	48
2008	48
2009	47
2010	47
2011	48
2012	49
2013	49
2014	48
2015	49
2016	45

Table 8 Number of commercial fishermen by gender who harvested blue crab from 2007 – 2016.

Year	Male	Female	Unknown
2007	888	60	5
2008	850	60	5
2009	926	60	6
2010	912	68	7
2011	861	60	5
2012	830	61	8
2013	801	57	8
2014	856	64	6
2015	847	66	13
2016	813	66	9

Table 9 Number of commercial fishermen by race who harvested blue crab from 2007 – 2016.

Year	African American	American Indian	Asian/Pacific Islands	Caucasian	Hispanic	Unknown
2007	23	1	61	853	4	10
2008	24	2	52	824	5	8
2009	20	3	57	901	2	9
2010	21	4	63	887	2	10
2011	21	4	59	835	1	6
2012	21	3	53	810	1	11
2013	23	3	46	781	1	12
2014	23	2	51	838	1	11
2015	21	2	53	832	1	17
2016	21	1	51	801	1	12

During the sale and renewal of commercial licenses, an economic survey is conducted that asks commercial fishermen if they obtain more than 50 percent of their income from commercial fishing. Most blue crab fishermen indicated they do generate more than 50 percent of their income from commercial fishing, however the difference between the number of those fishermen indicating less than 50 percent of their income from commercial fishing and those indicating making more than 50 percent has been getting smaller in recent years (Table 10)

Table 10 Number of commercial fishermen who indicated they make less or more than 50 percent of their income from commercial fishing as indicated from the economic survey conducted during license sales and renewals from license years 2007 to 2016.

Year	Less than 50%	More than 50%	Unknown
2007	136	702	6
2008	187	774	5
2009	184	813	18
2010	181	846	14
2011	157	841	6
2012	149	771	15
2013	130	750	18
2014	163	748	38
2015	210	755	24
2016	255	697	17

Commercial Crabbers

A fisherman needs to hold a Standard Commercial Fishing License (SCFL) or a Retired Standard Commercial Fishing License (RSCFL) to land blue crabs commercially in North Carolina. Commercial licenses are sold on a fiscal year calendar, which runs from July 1 to June 30. The total number of SCFLs and RSCFLs issued over fiscal year 2007 to fiscal year 2016 ranged from 6,425 in 2016 to 6,906 in 2007 (Table 11). The number of participants with reported landings ranged from 863 in 2013 to 990 in 2009. Most of participants who operate in the blue crab commercial fishery landed hard-shell blue crabs with the number of participants ranging from 815 in 2013 to 944 in 2010. The number of participants reporting landings from peeler and soft-shell crabs is much less. The number of participants reporting peeler crabs ranged from 476 in 2016 to 561 in 2009. For soft-shell crabs, the number of participants ranged from 209 in 2011 to 270 in 2009.

Table 11 Total number of SCFL/RSCFLs issued and participants landing blue crab.

Year	SCFL/RSCFLs Issued ¹	Participants w/Blue Crab Landings	Participants w/ Hard-Shell Crab Landings	Participants w/ Peeler Crab Landings	Participants w/ Soft-Shell Crab Landings
2007	6,906	952	890	548	270
2008	6,861	914	857	526	245
2009	6,827	990	943	561	245
2010	6,815	984	944	551	238
2011	6,819	925	883	511	209
2012	6,794	895	837	506	229
2013	6,699	863	815	502	253
2014	6,685	923	887	534	259
2015	6,635	923	883	534	241
2016	6,465	884	862	476	237
Average	6,751	925	880	525	423

¹ SCFL/RSCFLs are issued on a fiscal year (July 1 to June 30).

Most participants who land blue crabs live in the coastal counties of North Carolina. Over 73% of the participants who landed blue crabs in 2016 were from Dare (20%), Beaufort (14%), Carteret (11%), Hyde (7%), Currituck (6%), Pamlico (5%), Perquimans (5%), and Tyrrell (5%) counties.

Fishery Effort

The number of trips reporting landings of blue crabs averaged over 54,000 over the 2007 to 2016 period. The number of trips ranged from 51,707 in 2016 to 59,313 in 2009 (Table 12). The average landings per trip ranged from 398 pounds per trip in 2007 to 625 pounds per trip in 2008. The real value per trip ranged from \$404 in 2011 to \$585 in 2014.

Looking more specifically at the crab and peeler pot fishery, the average number of pots reported on trip tickets as being fished from 2007 to 2016 was over 13.6 million per year. The number of pots fished ranged from 12.2 million in 2013 to 16.4 million in 2015. The average number of pots fished per trip ranged from 241 pots per trip in 2007 to 293 pots per trip in 2015. The average blue crab catch per pot ranged from 1.70 pounds per pot in 2007 and 2014 to 2.50 pounds in 2008.

Table 12 Annual trips, catch per trip, real value per trip, total number of pots, pots fished per trip, and catch per pot in the blue crab fishery.

Year	Trips ¹	Catch Per Trip ¹	Real Value Per Trip ¹	Total Pots Reported Fished ²	Pots Per Trip ³	Catch Per Pot
2007	53,833	398	\$492	12,585,097	241	1.70
2008	52,654	625	\$583	12,525,056	249	2.50
2009	59,313	501	\$519	14,069,873	247	2.04
2010	54,977	558	\$517	13,336,039	249	2.27
2011	52,406	573	\$404	12,814,114	253	2.32
2012	52,697	508	\$433	12,547,175	245	2.13
2013	52,631	422	\$576	12,199,083	239	1.81
2014	56,217	467	\$585	15,322,181	283	1.70
2015	57,603	558	\$579	16,433,869	293	1.94
2016	51,707	492	\$466	14,712,005	291	1.72
Average	54,404	510	\$515	13,654,449	259	2.01

¹ The number of trips, catch per trip, and real value per trip is from all trips that recorded blue crabs across all gear types including pots, trawls, dredges, and other.

² The total number of pots reported fished is the sum of what was reported on trip tickets and duplicates the number of pots fished by an individual each time they fill out a trip ticket. For example, if a fisherman fishes 50 pots each trip and has 100 trips for the year it will be calculated as 5,000 pots fished.

³ The number of pots per trip is the average number of pots reported fished on trip tickets. This is not the same as the number of pots a fisherman may have in the water. For example, a fisherman may have 500 pots in the water but only fish 250 pots on a particular day, so the number of pots fished for the trip would be 250 pots.

The total number of vessels landing blue crabs ranged from 1,077 in 2016 to 1,192 in 2009 (Table 13). Most vessels land 5,000 pounds or less of blue crabs. The number of vessels landing less than 1,000 pounds has remained stable since 2010, except for 2014 when the numbers peaked at 343. The number of vessels landing 1,000 to 5,000 pounds has fluctuated over the years declined from 214 in 2015 to 201 in 2016. The number of vessels landing 5,001 to 10,000 pounds declined overall from 2007 to 2013 and then increased in 2014 and has remained stable since. Fluctuations in the number of vessels landing more than 20,000 pounds occurred over the time period. Looking specifically at the number of vessels landing more than 100,000 pounds, the number of vessels were lowest in 2007 at 33 and then increased to 94 in the following year. Since then, the number of vessels landing more than 100,000 pounds declined and remained in the 70s to 80s until 2013 at which point then declined. In 2015, the number of vessels with landings more than 100,000 pounds peaked at 102 and has declined since then.

Table 13 Annual number of vessels landing blue crab by poundage range, 2007-2016.

Year	< 1,000 Pounds	1,000 - 5,000 Pounds	5,001 - 10,000 Pounds	10,001 - 20,000 Pounds	20,001	50,001 - 100,000 Pounds	>100,000 Pounds	Total
					- 50,000 Pounds			
2007	317	216	131	124	181	107	33	1,109
2008	325	182	97	108	160	132	94	1,098
2009	337	213	122	122	198	128	72	1,192
2010	299	222	120	134	199	124	79	1,177
2011	306	179	108	136	194	109	82	1,114
2012	300	203	97	137	172	91	77	1,077
2013	309	204	108	136	152	89	57	1,055
2014	343	185	129	122	171	106	68	1,124
2015	307	214	125	142	167	98	102	1,155
2016	295	201	120	119	188	83	71	1,077
Average	314	202	116	128	178	107	74	1,118

Seafood Dealers and Shedders

The number of seafood dealers reporting landings of blue crabs has ranged from 241 in 2008 to 280 in 2010 (Table 14). Most dealers operate in the hard-shell crab fishery with the number of dealers reporting hard-shell crabs ranging from 211 in 2007 to 245 in 2010. The number of dealers reporting landings of peeler crabs ranged from 111 in 2016 to 124 in 2007. Looking at soft-shell crabs, the number of dealers reporting landings has ranged from 77 in 2015 to 102 in 2007.

Table 14 Annual number of seafood dealers reporting landings of blue crab, 2007-2016.

Year	Number of Dealers w/ Blue Crab Landings	Number of Dealers w/ Hard-Shell Crab Landings	Number of Dealers w/ Peeler Crab Landings	Number of Dealers w/ Soft-Shell Crab Landing
2007	247	211	124	102
2008	241	217	118	94
2009	274	243	123	94
2010	280	245	118	98
2011	266	230	120	88
2012	259	227	116	82
2013	243	213	113	86
2014	269	241	119	96
2015	252	223	116	77
2016	268	226	111	84
Average	260	228	118	90

The number of blue crab shedding permits issued by fiscal year ranged from 267 in 2013 to 314 in 2007 (Table 15). Shedding operations used mostly two types of tanks: closed recirculating or flow through tanks. Two other types of tanks may also be used but they are much less common (floating tank and other types). The number of flow through tanks have generally declined from 2007 and ranged from 4,067 in 2013 to 4,067 in 2007. The number of close recirculation tanks have followed the same overall pattern through 2012 but showed an increase in 2013 to 2015 before declining again. The number of closed recirculating tanks ranged from 955 in 2012 to 1,665 in 2007.

Table 15 Annual number of permitted blue crab shedding operations, 2007-2016. Fiscal year runs from July 1 through June 30.

Fiscal Year	Shedding Permits Issued	Closed Recirculating Tanks	Flow Through Tanks	Floating Tanks	Other Tanks
2007	314	1,665	6,642	63	32
2008	304	1,564	6,462	339	31
2009	300	1,166	5,152	543	55
2010	301	1,046	5,941	238	71
2011	292	1,145	5,192	16	1
2012	287	955	5,534	74	13
2013	267	1,261	4,067	40	0
2014	279	1,378	4,224	144	31
2015	268	1,418	4,104	87	82
2016	268	1,312	4,265	146	74
Average	288	1,291	5,158	169	39

Crab Processors

Crab processing is an important component of the blue crab commercial industry. In North Carolina, crab processing facilities may have two types of permits. The first type is for the initial cooking, picking, and packing of crab meat and the second type is for repacking crab meat that has previously been cooked and packaged. An individual facility may have one or both types of permits which must be renewed annually and expire on March 31 each year. The number of permitted processing facilities has remained fairly stable since 2007 (Table 16). However, the number of permitted facilities is roughly half of what it was in the late 1990s (38). Several factors have contributed to the decline in the number of processing facilities including a shift from processed crabs to a live basket market, increased competition from imports, and more stringent federal Hazard Analysis and Critical Control Point (HACCP) requirements.

Table 16 Annual (April 1-March 31) number of permits issued for crustacea processing facilities, 2007-2018. Data from the NCDMF Shellfish Sanitation section.

Year	Total Number of Permitted Facilities	Total Number of Picking Permits	Total Number of Repacking Permits	Total Number of Facilities Permitted for Picking and Repacking
2007-2008	10	7	2	1
2008-2009	9	6	2	1
2009-2010	13	7	2	4
2010-2011	11	5	2	3
2011-2012	14	8	3	3
2012-2013	13	8	2	3
2013-2014	11	7	1	3
2014-2015	11	7	1	3
2015-2016	17	8	2	7
2016-2017	17	6	2	9
2017-2018	14	4	2	8
2018-2019	15	4	2	9

Swimming Crab Imports

The United States imports two types of “swimming crabs” related to blue crab: *Portunidae* (the family that includes blue crabs) and *Callinectes* (the blue crab genus). According to NOAA Fisheries U.S. Foreign Trade database, total U.S. imports of swimming crab have averaged 46.8 million pounds and \$384 million per year between 2007 and 2016. Imports bearing the broader Portunidae label averaged 39.8 percent of the total volume and 36.6 percent of the total real value of swimming crab imports during the period. Imports under the Callinectes label averaged 60.2 percent of total volume and 63.4 percent of the total real value of swimming crab imports from 2007 to 2016. The United States imports swimming crab in two forms, frozen and in air tight containers. Imports of frozen crab averaged 4.1 million pounds and \$23.6 million per year from 2007 to 2016; imports of crab in air tight containers averaged 42.7 million pounds and \$360 million per year during the same period.

Between 2007 and 2016, the United States imported swimming crab products from as few as 14 to as many as 21 different countries. The majority of swimming crab products come from a relatively small number of countries with five countries making up an average of 80% of imports from 2007 to 2016. Indonesia has been the number one source of swimming crab product imports in every year from 2007 to 2016. The total volume of swimming crab product imports from Indonesia comprised almost one-third of the total volume of all swimming crab product imports on average from 2007 to 2016 (42).

Summary of Economic Impact of Commercial Fishing

The economic impact estimates presented represent those of commercial blue crab harvesters, dealers, and processors and are calculated via the NCDMF commercial fishing economic impact model. These estimates are given for four categories: all commercial blue crab harvest, hard blue

crab harvest, peeler blue crab harvest, and soft blue crab harvest

Blue crab boasts the highest ex-vessel values in the state and in 2016 resulted in over \$150 million in economic impact (Table 17), with hard blue crabs dominating this cash flow. Peeler and soft blue crabs also contribute to this industry, each generally producing greater than \$1 million in ex-vessel revenues per year. On top of this, the peeler and soft blue crab fisheries tend to exhibit similar landings values, with soft blue crab values slightly higher overall. Additionally, annual changes in ex-vessel value across segments are generally consistent, in that years with lower hard blue crab revenues tend to exhibit lower soft and peeler blue crab revenues as well (Tables 18, 19, and 20).

Given gear and catch changes are proposed under this amendment, the commercial fishery will likely see a reduction in ex-vessel value due to an expected reduction in landings. However, effort, and therefore supply, are not being controlled for, and because of this, expected changes to marginal prices of crab are unknown. Additionally, as management changes that reduce landings are being implemented across all aspects of the blue crab fishery, economic losses due to these regulations can be expected across the hard, soft, and peeler fisheries. Lastly, these output measures were calculated using annual ex-vessel values and participant counts. While ex-vessel values per blue crab segment are fully independent, some participants may be fishing across multiple segments, possibly even during the same trip. Because of this, output measures on a per-segment scale (Tables 18, 19, and 20) are not additive and may be over-estimating total contributions, but still capture the socioeconomic importance of each blue crab fishery to the state economy.

Table 17 Economic impacts associated with the commercial blue crab fishery for all product categories, 2007-2016.

Year	Participants ¹	Pounds ¹	Ex-Vessel Value (\$) ¹	Jobs ^{2,3}	Income Impacts (\$) ³	Value Added Impacts (\$) ³	Output Impacts (\$) ^{3,4}
2007	884	25,459,475	24,112,715	2,313	56,569,819	85,443,052	123,871,511
2008	923	32,134,501	33,724,424	2,782	68,330,127	103,098,756	155,900,595
2009	923	26,230,965	34,027,403	2,807	69,978,824	105,642,579	155,668,594
2010	863	22,202,623	30,006,447	2,656	65,839,269	99,304,559	149,381,907
2011	895	26,785,669	22,806,938	2,069	51,868,420	78,192,850	119,032,842
2012	925	30,035,392	21,282,264	2,217	56,147,717	84,607,194	128,240,957
2013	984	30,683,011	26,543,791	2,882	72,762,337	109,704,172	167,489,172
2014	990	29,707,232	27,428,995	3,255	83,092,013	125,316,017	190,518,399
2015	914	32,916,691	27,555,386	3,329	84,243,536	127,096,494	190,345,529
2016	952	21,424,960	21,431,955	2,302	61,024,899	91,970,507	151,757,244

¹ As reported by the North Carolina Trip Ticket Program

² Represents both full-time and part-time jobs

³ Economic impacts calculated using the NCDMF commercial fishing economic impact model and IMPLAN economic impact modeling software. Economic impact estimates are for the state economy of North Carolina.

⁴ Represents sales impacts

Table 18 Economic impacts associated with the commercial blue crab fishery for hard blue crabs only, 2007-2016.

Year	Participants ¹	Pounds ¹	Ex-Vessel Value (\$) ¹	Jobs ^{2,3}	Income Impacts (\$) ³	Value Added Impacts (\$) ³	Output Impacts (\$) ^{3,4}
2007	862	24,728,862	20,734,833	2,142	54,520,426	82,794,003	119,109,877
2008	883	31,047,438	29,457,925	2,674	67,018,157	101,401,623	152,852,403
2009	887	25,242,648	29,954,605	2,689	68,542,255	103,783,999	152,327,477
2010	815	21,438,077	26,465,523	2,520	64,179,463	97,157,235	145,519,395
2011	837	25,991,387	20,198,891	1,908	49,882,882	75,624,156	114,416,771
2012	883	28,964,633	18,016,736	2,087	54,544,208	82,532,792	124,514,063
2013	944	29,794,329	23,801,594	2,704	70,621,095	106,934,054	162,511,562
2014	943	29,140,473	25,039,379	3,051	80,629,140	122,129,805	184,793,115
2015	857	32,338,889	25,429,231	3,115	81,663,530	123,758,747	184,347,951
2016	890	20,562,159	18,109,497	2,142	58,906,380	89,230,343	144,809,891

¹ As reported by the North Carolina Trip Ticket Program

² Represents both full-time and part-time jobs

³ Economic impacts calculated using the NCDMF commercial fishing economic impact model and IMPLAN economic impact modeling software. Economic impact estimates are for the state economy of North Carolina.

⁴ Represents sales impacts

Table 19 Economic impacts associated with the commercial blue crab fishery for peeler blue crabs only, 2007-2016.

Year	Participants ¹	Pounds ¹	Ex-Vessel Value (\$) ¹	Jobs ^{2,3}	Income Impacts (\$) ³	Value Added Impacts (\$) ³	Output Impacts (\$) ^{3,4}
2007	476	445,844	1,314,879	1,272	44,081,515	69,300,649	94,855,735
2008	534	706,688	2,111,103	1,430	51,871,181	81,807,854	117,660,362
2009	534	621,040	1,935,462	1,512	54,154,728	85,169,934	118,865,501
2010	502	447,120	1,449,542	1,392	50,497,796	79,456,993	113,680,978
2011	506	468,855	1,112,025	1,075	39,649,466	62,385,167	90,625,651
2012	511	624,362	1,186,286	1,139	42,808,999	67,351,373	97,238,954
2013	551	568,210	1,197,855	1,449	55,493,614	87,363,675	127,345,662
2014	561	367,881	1,106,883	1,646	63,685,607	100,210,007	145,405,556
2015	526	351,986	882,319	1,743	65,126,559	102,364,916	145,905,501
2016	548	498,904	1,186,031	1,224	46,726,694	73,476,730	104,868,510

¹ As reported by the North Carolina Trip Ticket Program

² Represents both full-time and part-time jobs

³ Economic impacts calculated using the NCDMF commercial fishing economic impact model and IMPLAN economic impact modeling software. Economic impact estimates are for the state economy of North Carolina.

⁴ Represents sales impacts

Table 20 Economic impacts associated with the commercial blue crab fishery for soft blue crabs only, 2007-2016.

Year	Participants ¹	Pounds ¹	Ex-Vessel Value (\$) ¹	Jobs ^{2,3}	Income Impacts (\$) ³	Value Added Impacts (\$) ³	Output Impacts (\$) ^{3,4}
2007	237	284,769	2,063,004	1,321	44,667,748	70,058,414	96,217,809
2008	241	380,375	2,155,396	1,449	52,094,259	82,096,423	118,178,657
2009	259	367,277	2,137,335	1,521	54,260,444	85,306,706	119,111,372
2010	253	317,426	2,091,382	1,410	50,707,520	79,728,316	114,169,022
2011	229	325,426	1,496,021	1,119	40,192,410	63,087,575	91,887,913
2012	209	446,397	2,079,242	1,158	43,045,092	67,656,799	97,787,685
2013	238	320,472	1,544,342	1,482	55,881,742	87,865,796	128,247,920
2014	245	198,878	1,282,733	1,656	63,807,683	100,367,936	145,689,337
2015	245	225,816	1,243,836	1,745	65,153,344	102,399,567	145,967,765
2016	270	363,896	2,136,426	1,259	47,195,899	74,083,615	106,407,193

¹ As reported by the North Carolina Trip Ticket Program

² Represents both full-time and part-time jobs

³ Economic impacts calculated using the NCDMF commercial fishing economic impact model and IMPLAN economic impact modeling software. Economic impact estimates are for the state economy of North Carolina.

⁴ Represents sales impacts

RECREATIONAL FISHERY

Recreational Harvest Estimates

Recreational fishermen harvest blue crab for personal consumption and for use as bait. Harvest occurs using a variety of gears including crab pots (rigid and collapsible), gill nets, shrimp trawls, trot-lines, hand-lines, and dip nets. Prior to July 1999, no license was required to harvest blue crab recreationally unless a vessel was used. Since July 1, 1999, a RCGL has been required to recreationally harvest blue crab using commercial gear. Gears exempt from this license include collapsible crab pots, cast nets, dip nets, hand-lines, and seines (less than 30 feet). Additionally, one pot per person may be fished from shore along privately-owned land or a privately-owned pier without a RCGL. The recreational harvest limit for blue crab is 50 per person per day, not to exceed 100 per vessel. A Coastal Recreational Fishing License (CRFL) is not required to recreationally harvest blue crabs.

Long-term comprehensive estimates of recreational harvest data are lacking in North Carolina. However, there have been several short-term or targeted surveys meant to estimate recreational blue crab harvest. In 2002, Vogelsong et. al (43) surveyed coastal waterfront landowners to estimate recreational harvest. They found that approximately 30% harvested blue crab from their property and 7% harvest blue crab away from their property. It was estimated that 279,434 pounds of blue crabs were harvested in 2002 by coastal waterfront landowners. From 2002 to 2008, the NCDMF surveyed RCGL holders estimated an average of 587,172 pounds were harvested annually. In the fall of 2010 the NCDMF began surveying CRFL holders that indicated they harvested crabs. From 2011 to 2016, an estimated average of 97,774 blue crabs (approximately 32,591 pounds) was harvested annually.

Summary of Economic Impact of Recreational Fishing

The economic impact estimates presented for blue crab recreational fishing represent the economic activity generated from trip expenditures. It should be noted that not included in these estimates, but often presented in NCDMF overall recreational impacts models, are the durable good impacts from economic activity associated with the consumption of durable goods (e.g., rods and reels, other fishing related equipment, boats, vehicles, and second homes).

Overall, the economic impact of blue crab harvesting is significantly smaller than the commercial impact, with an estimated economic impact of \$2.7 million in 2016 (Table 21). Which is reflective of the lack of a sport fishery, as well as its importance to the commercial seafood trade. The majority of recreational blue crab trips occur onshore (not requiring a vessel), and therefore often provide fewer market-level benefits, with the only inputs being gear and bait purchases, travel to site, and permitting. Of those trips that occur in a vessel, these occur near or inshore, and require less gear, fuel, and other related expenditures.

With the proposed management changes, there will be little effect felt on the recreational fishery from an economic standpoint. Moving forward, there may be economic gains in the recreational sector, as the proposed changes may improve abundance over time, leading to better access and interest for recreational blue crab harvest.

Table 21 Economic impacts associated with recreational blue crab fishing, 2010-2016.

Year	Trips ¹	Estimated Expenditures (thousands of dollars) ²	Jobs ^{3,4}	Income Impacts (thousands of dollars) ⁴	Value-Added Impacts (thousands of dollars) ⁴	Output Impacts (thousands of dollars) ⁴
2010	5173	719,703	7	204,531	318,772	564,174
2011	24818	3,595,514	33	1,007,600	1,566,718	2,769,964
2012	26863	3,969,593	36	1,109,089	1,724,489	3,052,227
2013	30732	4,698,622	41	1,275,287	1,973,401	3,497,781
2014	23381	3,583,168	31	992,335	1,538,414	2,732,729
2015	27963	4,289,639	37	1,176,955	1,822,986	3,255,294
2016	23325	3,629,892	31	1,001,615	1,550,695	2,748,555

¹ Trip estimates from Coastal Recreational Fishing License (CRFL) surveys

² Estimated expenditures include only trip expenditures.

³ Includes full time and part time jobs

⁴ Economic impacts calculated using the NCDMF coastal recreational fishing economic impact model and IMPLAN economic impact modeling software. Economic impact estimates are for the state economy of North Carolina.

FISHERY IMPACT ON THE ECOSYSTEM

HABITAT

Bottom disturbing fishing gear can impact ecosystem function through habitat degradation, bycatch, and derelict gear. The primary gear used in the blue crab fishery is crab pots, although crab trawls and crab dredges are also used making up a small portion of the fishery. Other gears used include trot-lines, hand-lines, and dip nets but ecosystem impacts are considered minimal due to the construction of the gear and fishing methods.

GEAR IMPACTS TO HABITAT

While crab pots are the most abundant gear used in the fishery, their impact on habitat (on an individual pot basis) is relatively low due to their small footprint, light weight, open structure, and location placed. Physical impacts increase if pots are placed directly on structured habitat for prolonged periods. A study conducted in North Carolina found that prolonged deployment or movement of crab pots on marsh vegetation, which can occur when gear is lost or abandoned, significantly reduced stem height and density after being present eight weeks (44). The cumulative loss of wetlands could degrade the ecosystem services they provide, such as nursery habitat, pollutant removal, and shoreline stabilization (45). Fortunately, Uhrin and Schellinger (44) found that when pots were removed the vegetation recovered after approximately four months. In contrast, damage to submerged aquatic vegetation (SAV) from derelict pots is potentially greater and more permanent due to sedimentation in the pot, scour around the edges, and additional uprooting of grass along a path if dragged across the bottom during storms (46; 47; 48). Submerged aquatic vegetation is an important fish habitat consisting of underwater rooted vascular plants and is defined in rule [NCMFC Rule 15A NCAC 03I .0101 (4)(i)]. The extent that pots are interacting with and damaging SAV beds in NC is not known. Where

resources are limited, derelict gear cleanup should prioritize removal of pots on or near SAV (44). Zinc plates used to minimize rusting on crab pots is a habitat concern since these may contribute to heavy metal pollution in estuarine systems (49). Research is needed to validate this potential impact.

With an estimate of over one million crab pots deployed annually in North Carolina (38), crab pots are potentially impeding ecological function of soft bottom habitat as a migratory corridor. Inlets, a type of soft bottom, are a critical bottleneck for mature females as they move through the lower estuary to spawning areas. The five most northerly inlets in North Carolina are designated as [Crab Spawning Sanctuaries](#), with seasonal gear restrictions to aid migration and spawning. The remaining 16 inlets do not have similar protection. The protective effectiveness of the existing sanctuaries and associated rules continues to be a research need. Eggleston et al. (50) found female blue crab abundance to be no different inside the crab spawning sanctuaries than 1 km to 2 km outside the boundaries. Modification of Crab Spawning Sanctuary boundaries or rules could potentially improve their effectiveness.

Crab trawls and crab dredges are mobile bottom-disturbing fishing gear. Reviews of fishing gear impacts have categorized crab dredging and crab/shrimp trawling as having severe and moderate impacts to SAV, respectively (49; 51; 46; 45). Crab dredging is particularly damaging due to the long teeth that are designed to dig deep into the sediment, uprooting and destroying above and below-ground plant structure. Crab trawls can also cause extensive damage to SAV from trawl doors that dig into the sediment and uproot plants. Dragged chain can cut or damage above-ground leaves, but this does not always result in complete mortality (46). Both dredges and trawls can elevate turbidity, reducing water clarity needed for SAV growth and survival. Loss and damage to SAV is detrimental to the estuarine system due to the large diversity of fish and invertebrates that are dependent on it as a nursery and foraging area (45). Over 34 economically important fish species, and 150 other fish and invertebrates have been documented in SAV in North Carolina. Additionally, SAV improves water clarity, cycles nutrients, and sequesters carbon. More information on the ecological value, distribution, and condition of SAV in North Carolina can be found in the [Coastal Habitat Protection Plan](#) (45).

Crab trawling and crab dredging can cause structural damage to oyster reefs (52). Dredging reduces the height of subtidal reefs, scatters and removes shell substrate needed for oyster recruitment, and destabilizes the reef structure (53; 54). Subsequently, available substrate for oyster recruitment and structural habitat complexity for refuge and foraging are reduced. The lower profile of the disturbed shell bottom is more susceptible to sedimentation, disease, and hypoxia. Structurally complex oyster reefs are critical habitat for blue crab, as well as over 40 economically important species, and numerous prey species. Oyster reefs improve water quality, stabilize bottom sediment, and reduce shoreline erosion (45). It is estimated that over 90% of subtidal oyster reefs have been lost since the late 1800s. Historical and more recent losses of oyster reefs in the Pamlico Sound region are summarized in NCDMF (52) and NCDEQ (45). Historical losses are attributed primarily to overharvesting from oyster dredging and have not recovered due to disease, water quality issues, and lack of hard substrate for recruitment. Significant resources are being invested in oyster restoration, so any fishery activity that impacts shell bottom would be counterproductive to those efforts.

Because of the documented impacts to SAV and shell bottom, dredging and trawling are primarily restricted to soft bottom habitat. While soft bottom habitat is more dynamic and adapted to disturbance, productivity can still be impacted. Dragging gear over the bottom reduces small scale habitat complexity of soft bottom structure by removing or damaging scattered epifauna such as sponges, removing benthic invertebrates that produce burrows and pits such as tube worms, and smoothing of features such as sediment ridges and ripples (55; 51) . Reduced structural complexity and increased turbidity from frequent trawling can reduce feeding success of filter feeding invertebrates due to gill clogging or can increase predation by exposing organisms previously buried and reducing cover (55). In a review of gear impacts by Johnson (13), toothed dredging activities in soft bottom habitat appear to have a significant physical impact on the benthic organisms and topography in the dredge path, but there were few long-term impacts. Most studies reported recovery of taxa and topography in three to six months. Impacts from crab trawling are similar or somewhat more severe to those reported for shrimp trawling since crab trawls use heavier chain and doors that can dig deeper into the sediment.

Studies that have examined the effects of crab and shrimp trawling on turbidity and productivity of shallow estuarine soft bottom habitat have shown little sustained negative or positive impacts on primary or secondary productivity. Suspended sediment significantly increased in the water column up to three times greater than pre-trawling conditions but redeposited at varying rates, depending on the substrate and currents (56; 57; 58). Sedimentation in North Carolina studies varied between 15 minutes and 24 hours, occurring faster in areas with sandy sediment, low currents and calm winds. Studies on the effects of trawling on primary production found mixed results, with benthic microalgae reduced in one study but not others (59; 57; 60). One explanation for low impacts from gear disturbance is the bottom in North Carolina's shallow estuarine system is frequently disturbed by wind in and consequently the benthic community is adapted to bottom disturbance.

Habitat impacts from crab dredging and trawling are limited by the relatively low amount of fishing effort with these gears. From 2014 to 2016, the number of crab trawl trips ranged from 180-470 per year, and the number of crab dredge trips ranged from 3-14 per year. In contrast there were 4,598-7,468 shrimp trawl trips during this same period. Crab dredge use is limited to an area of primarily soft bottom habitat in northern Pamlico Sound (approximately 86,900 acres) and is opened by rule from January 1 to March 1 [NCMFC Rule 15A NCAC 3L .0203]. Some SAV and subtidal shell bottom may also occur in or near this area. Although the low fishing effort results in a small area of impact due to crab dredging, the destruction potential of the gear to all habitats, combined with spatial preference for harvesting mature female blue crabs, results in a net adverse impact to blue crabs from the use of this gear. Crab trawl use occurs in areas open to trawling predominantly in Pamlico Sound and adjacent estuarine rivers. There is potential for crab trawling to occur over SAV in the western portions of the Pamlico system, although most SAV occurs in water less than 1 m, where it is too shallow for trawl operation. There is also potential for crab trawling to occur over or near low profile oyster bottom, potentially damaging the integrity of the habitat and increasing turbidity.

BYCATCH AND DISCARDS

Undersized and Other Non-Legal Blue Crabs

As of June 2016 through the revision to Amendment 2, hard crabs must measure five inches from point to point on the carapace for males or be in the mature stage for females to be considered legal for harvest. Additionally, mature females possessing a dark sponge (brown and black stages) may not be kept between April 1st and April 30th each year. A culling tolerance allows no more than five percent by number of any combination of undersize males, and immature or dark sponge bearing females to be possessed. Any hard blue crab not considered legal for harvest must be immediately returned to the water from where they were taken. Crab pots may attract and capture blue crabs which are not legal for harvest and their chance of becoming injured and dying increases the longer they are trapped (61).

Cull (escape) rings can be mounted to crab pots to help undersize crabs escape, while retaining legal sized catch. Both the location and size of the cull rings can affect the odds of undersized crabs escaping (62; 63). As of January 2017, implemented by the revision to Amendment 2, both commercial and recreational hard crab pots in North Carolina are required to have three escape rings with an inside diameter no smaller than two and five-sixteenths inches. Two of these escape rings must be mounted on opposite outside panels, and one must be mounted in a corner close to the bottom of the pot, or upper chamber if present. These requirements apply statewide, except NCMFC rule 15A NCAC 03J .0301(g) allows for specific areas in Pamlico Sound and the Newport River as exceptions in NCMFC rule (15A NCAC 03R .0118) and are intended to reduce the capture and mortality of undersized hard crabs.

Other Species

Crab pots are the predominant gear in the blue crab fishery, with crab trawls and crab dredges making up a very small percentage of the total gear used. Both finfish and shellfish species may be caught as bycatch in crab pots. This bycatch may be retained and landed as incidental catch or discarded as a result of economic, legal, or personal considerations.

Statewide annual landings of the marketable portion of the incidental bycatch from hard crab and peeler pots, as recorded by the NCDMF Trip Ticket Program single gear trips, has averaged 57,343 pounds since 2007 and represents .02% of the total landings from this gear. Seven species or species groups comprise over 90% of all incidental catch landed from hard crab and peeler pots: catfish 36% (Ictaluridae), oyster toadfish 19% (*Opsanus tau*), whelks 18% (*Busycon spp.*, *Busycotypus spp.*), Florida stone crabs 10% (*Menippe mercenaria*), southern flounder 5% (*Paralichthys lethostigma*), northern puffer 2% (*Spherooides maculatus*), and spotted seatrout 2% (*Cynoscion nebulosus*) (Figure 7).

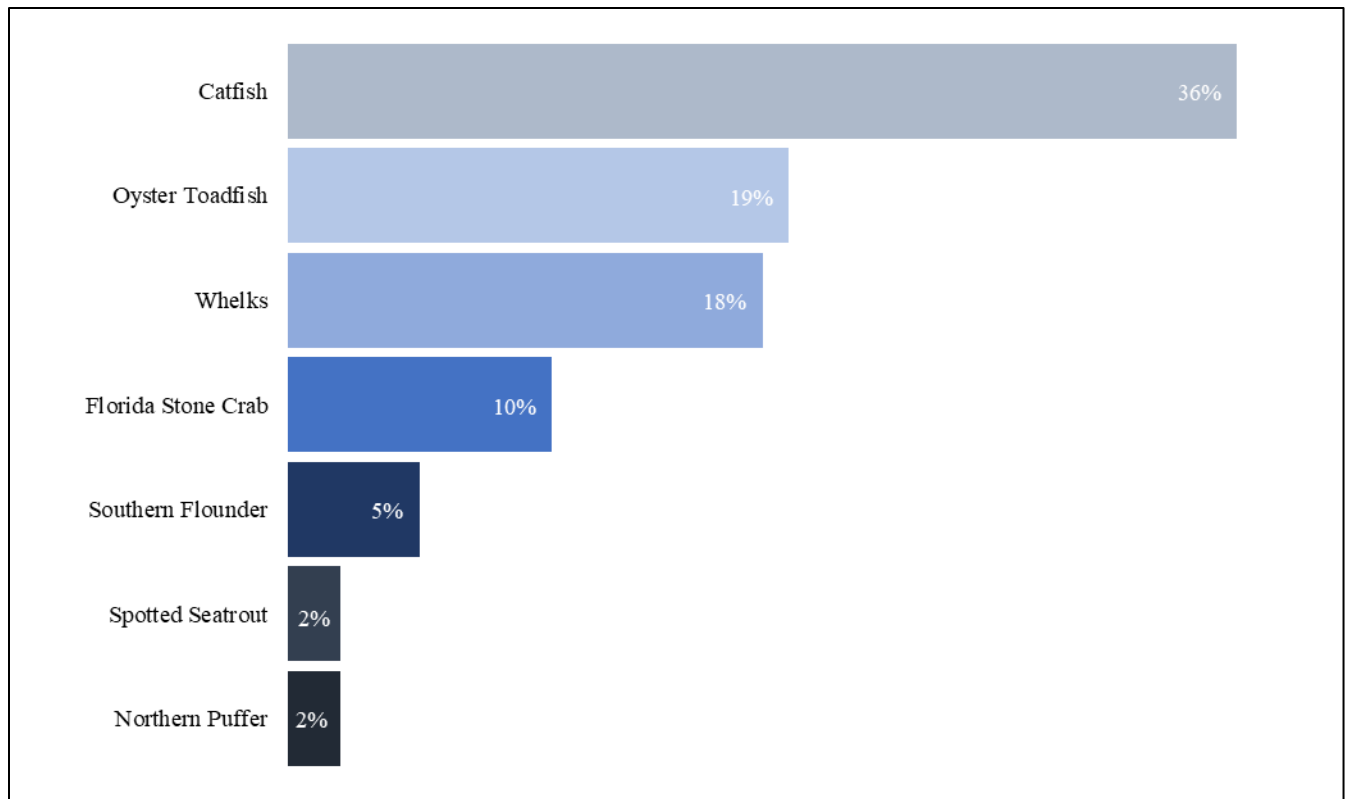


Figure 7 The percentage each of the top seven species (or species groups) contributes to all incidental catch landed from hard crab and peeler pots between 2007 and 2016.

Bycatch and discards have been examined in the North Carolina blue crab pot fishery. Doxey (64) examined bycatch in both hard crab and peeler pots in the Neuse River. Flounder (*Paralichthys* spp.) accounted for 34% of the total hard crab pot bycatch, and other important species reported captured in this study include spot (*Leiostomus xanthurus*), spotted seatrout, gray trout (*Cynoscion regalis*), red drum (*Sciaenops ocellatus*), and diamondback terrapin (*Malaclemys terrapin*). The catch-per-unit-effort of all bycatch species averaged 0.007 organisms per hard crab pot, and of the captured bycatch in hard crab pots, 70% were released alive, 22% were either dead or injured, and 8% was used for bait. Thorpe et al. (65), investigated bycatch in hard crab pots in locations in Brunswick and Carteret Counties. Sub legal southern flounder were the most commercially and recreationally important fish species caught as bycatch in this study, with other finfish bycatch including, spadefish (*Chaetodipterus faber*), oyster toadfish, and pinfish (*Lagodon rhomboides*). Other species captured included diamondback terrapins, as well as channeled whelk (*Busycotypus canaliculatus*) and Florida stone crabs, which are two important shellfish species caught as bycatch and landed as incidental catch during this research.

NCDMF (10) evaluated the ability of multiple finfish species to escape both control crab pots (without escapement “cull” openings) and crab pots with escapement openings, over a 24-hour period. White catfish (*Ameiurus catus*), black drum (*Pogonias cromis*), and white perch (*Morone Americana*) had the highest escapement rates, and southern flounder had the lowest rate. Overall escapement from the control pots was very good and increasing the size of the escapement

openings appeared to enhance escapement efficiency for finfish species.

Protected Species

Protected species is a broad term that encompasses a range of organisms that are identified by federal or state protective statutes, such as the Endangered Species Act (ESA), Marine Mammal Protection Act (MMPA), and Migratory Bird Treaty Act. Of the many federal and state protected species, whales, bottlenose dolphins, sea turtles, and diamondback terrapins are considered to have the greatest potential to interact with the North Carolina blue crab fishery. Baited crab pots may attract protected species which can possibly get entangled in the buoy lines or entrapped. Although crab trawls are an active gear that focus on the estuarine bottom and are restricted to areas without submerged aquatic vegetation, interactions with protected species are possible. Crab dredges are an active bottom gear restricted to a small, specific area of Pamlico Sound and therefore are less likely to interact with protected species than the other two gears mentioned.

Since the 1970s, the NCDMF has been proactive in developing ways to minimize impacts to threatened and endangered marine species. The NCDMF works closely with the National Oceanic and Atmospheric Administration (NOAA) Fisheries and other state and federal agencies to develop regulations that minimize impacts to protected species and still allow for economically important fisheries.

Marine Mammals

North Carolina has two species of baleen whales that traverse the state during their annual migration. These are the North Atlantic right whale (*Eubalaena glacialis*) and the humpback whale (*Megaptera novaeangliae*), both of which are protected under the MMPA and have been designated endangered under the ESA. Ship strikes pose a threat to many baleen whales, particularly the critically endangered North Atlantic right whale. Entanglement in various types of fishing gear is an additional threat to many species of whales. The humpback is one of the most abundant whale species off the North Carolina coast and one of the most often affected in entanglements in this state (38).

Bottlenose dolphin (*Tursiops truncatus*) are occasionally captured or entangled in various kinds of fishing gear. Bottlenose dolphin carcasses that displayed evidence of possible interaction with a trap/pot fishery (i.e., rope and/or pots attached, or rope marks) have been recovered by the Marine Mammal Stranding Network between North Carolina and the Atlantic coast of Florida (38).

The North Carolina blue crab fishery has been categorized as a level II commercial fishery by the federal government in regard to the MMPA, or as only having occasional interactions with marine mammals (66). Most of the crab pot effort in the North Carolina blue crab fishery is located within the sounds, rivers, and estuaries of the state, with a very small portion occurring in the nearshore coastal ocean. As a protection for marine mammals in North Carolina ocean waters, fishermen setting any type of pots in nearshore waters (inside the 100-foot contour) are required to use sinking lines and break-away devices known as “weak links”. Weak links in this nearshore area off North Carolina must have a breaking strength of no greater than 600 lbs.,

while beyond the 100-foot contour to the eastern edge of the Exclusive Economic Zone (EEZ), a breaking strength of no greater than 1,500 lbs. is required (67). In state inshore waters, NCMFC Rule 15A NCAC 03J .0301 (k) makes it unlawful to use pots to take crabs unless the line connecting the pot to the buoy is non-floating to reduce interactions with boaters, which also reduces the potential for marine mammal entanglements in this gear.

Sea Turtles

Five species of sea turtles occur in North Carolina, Kemp's ridley sea turtle (*Lepidochelys kempii*), hawksbill sea turtle (*Eretmochelys imbricate*), leatherback sea turtle (*Dermochelys coriacea*), green sea turtle (*Chelonia mydas*), and the loggerhead sea turtle (*Caretta caretta*). Loggerhead and green sea turtles are federally listed as threatened, while the others are listed as endangered.

Sea turtles may be attracted to baited crab pots as a source of food. Sea turtle entrapment in a pot or trap is not likely, but entanglement in the buoy lines of pots has been documented (68). There have been documented cases of loggerhead sea turtles entangled in crab pot gear in North Carolina, which lead to the death of the turtle (38). As sea turtles attempt to obtain either bait or crabs from crab pots, significant damage to the gear can occur. Sea turtles reportedly overturn the pot and bite the bottoms and sides, resulting in torn mesh and crushed pots. This damage also results in higher operating costs and decreased catches for crab fisherman. Plastic bait well covers have been shown to significantly reduce pot damage from loggerhead turtles and result in higher average blue crab catch when used on typical crab pots (69).

Diamondback Terrapins

Diamondback terrapins are a relatively small turtle species found throughout North Carolina's estuarine coastal waters. This species is listed by the North Carolina Wildlife Resources Commission (NCWRC) as a North Carolina species of "Special Concern" statewide, and as a Federal "Species of Concern" in Dare, Pamlico and Carteret counties in NC. However, these designations do not specifically provide any special state or federal protection.

Populations of diamondback terrapins have declined throughout their range and their incidental capture in crab pots may account for more adult diamondback terrapin mortalities than any other single factor (70). Diamondback terrapins are long-lived, late to mature, and display relatively low fecundity (71). Delayed sexual maturity and low reproductive rates, coupled with long life spans and strong site fidelity, are characteristics that make this species especially susceptible to substantial population declines or even local extinction from incidental bycatch and death of a relatively low number of individuals from the population annually (72; 73).

Several factors have been identified in determining the likelihood of diamondback terrapin bycatch in crab pots where crab fishing activities and diamondback terrapin occurrence overlap, and taking these factors into consideration, diamondback terrapin mortality from incidental bycatch in crab pots can be mitigated in North Carolina. Each of these limiting factors and its relationship to diamondback terrapin catchability in crab pots, as well as establishing a framework to employ terrapin excluder devices in the blue crab fishery is discussed in the issue

paper: Appendix 4.5: Establish a Framework to Implement the Use of Terrapin Excluder Devices in Crab Pots.

Derelict Gear

Derelict gear or “ghost pots” are crab pots that either through abandonment or loss (buoy lines cut by boats, storm events, etc.) continue to catch crabs and finfish. The long life of vinyl coated crab pots, and their ability to continue to capture blue crabs and finfish, raises concern about their impact to the ecosystem if they are lost or abandoned.

The number of crab pots used in the North Carolina commercial blue crab fishery is considered to be over one million, with an annual hard crab pot loss estimate of 17% (38). A ghost pot study conducted by NCDMF estimated the average yearly catch of legal blue crabs in a single ghost pot to be 40.4 individuals, with an average mortality rate of 45% (10). Voss et al. (74) conducted a study examining derelict crab pots in North Carolina and found that 41% of retrieved pots contained bycatch, 37% were capable of trapping organisms, and the pots retrieved were estimated to have been in the water for an average of approximately 2 years. In that study, a total of 18 species were identified as unable to leave the pot, and likely to suffer mortality. The most abundant of these species which are also of management interest to NCDMF included: blue crab, Florida stone crab, sheepshead (*Archosargus probatocephalus*), black sea bass (*Centropristis striata*), and diamondback terrapin.

Since 2003, the NCDMF Marine Patrol has been actively removing derelict crab pots from state waters during the winter clean up period. Between January 15 and February 7 each year, all pots are required to be removed from the water. Any crab pots found during this time are considered lost or abandoned and removed from our waterways. The NC Coastal Federation began a pilot study in 2013 to employ commercial fisherman to collect derelict crab pots in the northern region of the state. In 2017 this cooperative cleanup effort was expanded statewide, resulting in over 35,000 ghost pots being removed from North Carolina waters by the NCDMF Marine Patrol and commercial waterman over the last fourteen years (Table 22).

Table 22 Number of derelict crab pots removed each year during the crab pot cleanup period between January 15 and February 7. The northern area is approximately from the Virginia state line to Ocracoke, the central area is from the Pungo River to Emerald Isle, and the southern area is from Cape Carteret to the South Carolina State line.

Year	Northern Area	Central Area	Southern Area	Total
2003	4,047	900	127	5,074
2004	7,708	527	108	8,343
2005	2,168	N/A	N/A	2,168
2006	1,117	391	24	1,532
2007	896	135	24	1,055
2008	757	190	110	1,057
2009	589	257	60	906
2010	570	154	24	748
2011	656	183	141	980
2012	684	160	295	1,139
2013	451	445	545	1,441
2014	364	64	226	654
2015	1,004	149	155	1,308
2016	753	80	70	903
2017	2,836	1,219	249	4,304
2018	2,245	1,004	247	3,496

ECOSYSTEM IMPACTS ON THE FISHERY

As previously described in the biological profile section, blue crabs migrate throughout the estuary and nearshore ocean, utilizing a variety of habitats along the way. Submerged aquatic vegetation (SAV), wetlands, and shell bottom are particularly important for refuge and foraging. Inlets are a critical area of soft bottom for life cycle completion since planktonic megalopae must pass through the inlets to settle into estuarine nursery habitat, and conversely, sponge crabs must move to the inlet system and nearshore ocean to spawn. Since blue crabs depend on multiple habitats throughout the coastal system, degradation of any single habitat, as well as disruption of migratory connectivity, could negatively affect growth and survival of blue crabs. However, the high mobility of blue crabs within the system provides overall resilience to degradation in any one localized area.

WATER QUALITY DEGRADATION

Growth and survival of blue crabs is maximized when water quality parameters, such as temperature, salinity, and oxygen, are within optimal ranges. These parameters have been identified by life stage in the biological profile and other documents [Table 23; (75; 76; 45)]. When conditions are outside the suitable range for extended periods, blue crabs can be adversely impacted. Rapid change in environmental parameters typically associated with large freshwater

influx from rain events or hurricanes, triggers blue crab movement and can temporarily alter the spatial distribution of blue crabs on a large scale (77; 78).

Table 23 Water quality parameters required by and habitats associated with different life stages of blue crab. No documented data where blank (75; 79; 76; 80).

Life Stage	Salinity (ppt)	Temperature (C)	DO (mg/L)	Associated Habitats
Adult	0-30	5-39	>3	Entire estuary
Spawning Female	23-28	19-29		Inlet and Ocean
Larvae	>20	16-30		Inlet and Ocean
Juveniles	2-21	16-30		Wetlands, SAV, Shell Bottom, Soft Bottom

Hypoxia

Low dissolved oxygen (hypoxia) can cause sublethal stress or mortality in blue crabs. Sublethal stress may alter feeding and growth rates, behavior, and vulnerability to predators (76). Where blue crabs could not escape hypoxic waters, mortality occurred when oxygen levels were below 3.0 mg/L for one to three days; mortality occurred within three hours when less than 0.5 mg/L (75). While adults require 3-5 mg/L DO, juvenile blue crabs may be less tolerant of hypoxia than adults (81) and may require more than 5 mg/L. Blue crab tolerance to hypoxia decreases with increasing temperature (82). A study showed blue crabs collected from the Neuse River Estuary, where frequent hypoxia occurs, had a hypoxia-tolerant structure and survived longer exposures to hypoxia than those collected from waters without this issue (Bogue and Back Sounds; (83).

Hypoxic events have resulted in locally elevated mortality among crabs constrained by capture in pots in the Chowan, Neuse, and Pamlico river systems ((84); T. Pratt, personal communications). Neuse River crab fishermen indicated they would move pots and alter fishing frequency during low oxygen events to avoid blue crabs dying in pots. Adjustments in fishing activity were based on changing environmental observations and catch rates (85). Low oxygen events occur naturally when the water column becomes stratified for a long period, particularly during summer in deeper areas. High nutrient levels and low flushing increase a waterbody's susceptibility to hypoxia and subsequent fish kills (45). Most nutrient pollution in the Albemarle-Pamlico system has been linked to agriculture (86; 87; 88). Other sources of nutrients are stormwater runoff from developed land and point source discharges of treated wastewater. Runoff transports nutrients, sediment, toxins, and pathogens into surface waters, and can lead to rapid changes in salinity and temperature (89; 45).

Toxins

Chemical contaminants in the water and soft bottom can adversely impact blue crabs directly by causing mortality, or indirectly by altering endocrine related growth and reproductive processes. Acute toxicity of a variety of pesticides to blue crab were determined by the US Environmental Protection Agency and summarized in Funderburk et al. (75) and Osterberg et al. (90). These

studies stated the presence of any pesticide had a detrimental effect and increased mortality rates on larval and juvenile blue crabs, particularly after molting. Many factors affect a chemical's toxicity to marine organisms. Eggs and larvae are generally more sensitive to toxins than adult and juvenile life stages as they have more permeable membranes and less developed detoxifying systems (75; 91; 92).

Endocrine disrupting chemicals (EDCs) are hormonally active chemicals that alter growth, development, reproductive, or metabolic processes adversely affecting the organism, its progeny, and/or stock viability (93; 92; 94). Endocrine disrupting chemicals include some industrial chemicals, pesticides, metals, flame retardants, plasticizers, disinfectants, prescription medications, pharmaceuticals, and personal care products. These contaminants have been found in North Carolina waters (95; 96). Endocrine disrupting chemicals can cause mortality or sub-lethal stress on shellfish and crustaceans, depending on the concentration and extent of exposure. Flame retardants (polybrominated diphenyl ethers), which have widespread occurrence in surface waters, have been linked to inhibiting molting in blue crabs (97).

Many insecticides function by being endocrine disrupters, targeting disruption of larval development to adult (e.g. flea medication, fire ant treatment). Successful metamorphosis of larval mud crab, *Rhithropanopeus harrisi*, was shown to be negatively impacted by this type of insecticide (98). The study suggested species with more complex metamorphic processes, such as crabs, are more sensitive to compounds acting as endocrine disruptors. In coastal NC, insecticides are often used in agriculture operations. Osterberg et al. (90) conducted research on the toxicity of four commonly used insecticides to blue crab at different life stages. Results found that while all were toxic to megalopae and juveniles, lambda-cyhalothrin and Karate (the commercial product name) were the most acutely toxic compounds. They calculated that pesticide overspray into shallow ditches and creeks approximately 0.2-0.4 m deep or less would have concentrations sufficient to kill more than 50% of juvenile blue crabs within the affected waters. Acephate and Orthene, other common insecticides, had significantly lower toxicity, suggesting the use of certain insecticides could potentially be less detrimental to blue crabs.

Mass mortality of peeler blue crabs has been reported in the Pamlico estuary. The Department of Agriculture, Pesticide Division (DAPD) investigated a 2012 event reported to the Division of Water Resources and Marine Fisheries. The cause of the kill was found to be the pesticide bifenthrin which is commonly used with cotton and considered highly toxic to invertebrates. Rain following the spraying of adjacent cotton fields, carried runoff from the fields to the canal where the raceway intake occurred. The DAPD rules prohibit aerial application of pesticides under conditions likely to result in drift to non-target areas. However, drift of chemicals into surface waters does occur at times. Deposition of pesticides labeled toxic or harmful to aquatic life is not permitted in or near waterbodies. However, chemicals applied on land can be carried by stormwater runoff across land and ditches into surface waters. In the 2012 incident, the pesticide application did not violate label application directions, but there were some best management practices that could have been followed to minimize impacts. After the kill, the NCMFC's Crustacean Advisory Committee requested the division look into this. The topic was discussed by the NCMFC's Habitat and Water Quality Advisory Committee and DAPD staff spoke about the process and the specific incident. As a result of the meeting, the DAPD staff offered to increase outreach and technical assistance to farmers and additional training to

pesticide applicators. Information was included on the NCDMF website and in dealer newsletters regarding what to do if a blue crab kill occurs.

Microplastics in the water column are a growing concern for aquatic organisms, including crustaceans (99). Of the numerous species documented to have ingested microplastics (pieces < 5 mm in size), bivalves and crabs are especially vulnerable (100). Microplastics enter crabs through the gills or gut, negatively impacting oxygen consumption and ion exchange. The properties of the plastics allow for adsorption of organic pollutants, toxins, and heavy metals. Analysis of microplastics in Atlantic mud crab (*Panopeus herbstii*) and eastern oyster (*Crassostrea virginica*) in Florida found crabs had two orders of magnitude more pieces of microplastics per individual, primarily fibers than oysters (101). On average, the crabs had 4.2 pieces per individual and a mean of 20 additional pieces per individual temporarily entangled on exterior surfaces. In addition to blue crabs directly ingesting microplastics, they may accumulate them by forage on Atlantic mud crab or other species that previously ingested these plastics.

HABITAT DEGRADATION AND LOSS

As blue crabs migrate through the coastal ecosystem over their life cycle, they utilize many different habitats, including SAV, wetlands, shell bottom, and soft bottom. These habitats are described in detail in the [NC Coastal Habitat Protection Plan](#) (45) and shown in Figures 8 and 9. Portions of these habitats have been degraded or lost over time by a variety of anthropogenic sources (45), potentially impacting blue crab populations.

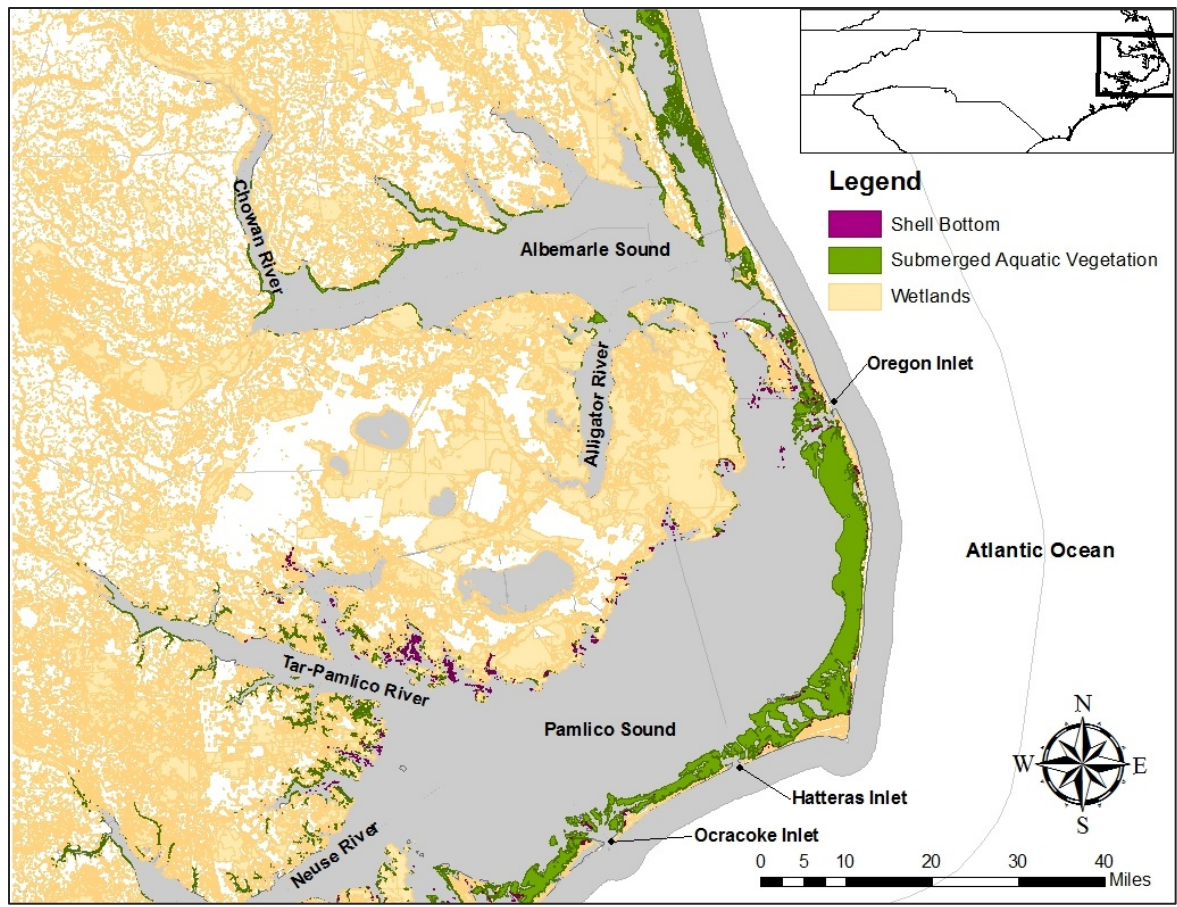


Figure 8 Location of mapped shell bottom, submerged aquatic vegetation, and wetlands – northern coast.

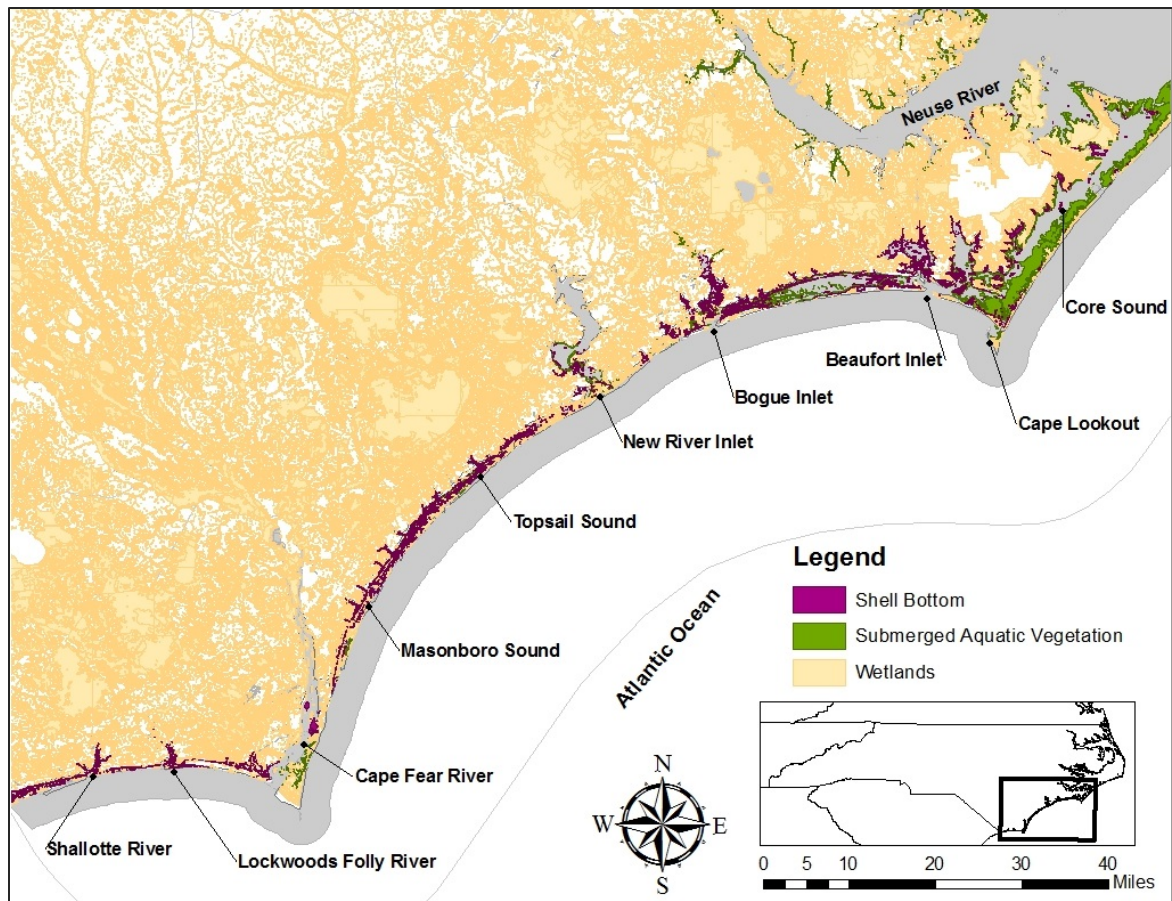


Figure 9 Location of mapped shell bottom, submerged aquatic vegetation, and wetlands – southern coast.

Submerged aquatic vegetation

The structural complexity of submerged aquatic vegetation (SAV) is critical habitat not only for blue crabs but over 150 species of fauna, including prey for blue crabs. Post-larval and early juvenile blue crabs (< 12 mm carapace width) use SAV for initial settlement and protection while they forage and grow. Adult blue crabs also use SAV for protection while molting and overwintering. In the Albemarle-Pamlico estuarine system, most initial recruitment of juvenile blue crabs occurs in SAV beds around inlets behind the Outer Banks. However, in years with large storm events, blue crabs disperse into lower salinity habitats where they recruit into marsh habitat (5). When SAV is lacking blue crabs are forced to recruit into other habitat structure, such as marsh (5), shell bottom (102; 103), detrital matter and woody debris (104).

Blue crabs have been shown to be more abundant in SAV than in shallow unvegetated estuarine bottoms in North Carolina and elsewhere (105; 106). Within SAV, juvenile crab density was documented to be greater where beds are large, continuous, and vegetated with dense, tall grass shoots (106; 107; 105; 108; 109; 5; 110). Using a habitat-specific demographic model to quantify the effects of habitat on population fitness, Ralph and Lipcius (111) found increased survival of age-0 blue crabs when vegetated habitats were present, which resulted in increased population

growth rates.

As a primary producer, SAV takes up carbon dioxide and releases oxygen into surface waters. The plants stabilize sediment, and improve water clarity, which in turn enhances conditions for other habitats and organisms. Due to the important ecological functions provided by SAV to the ecosystem and multiple life stages of blue crab, reduced abundance or change in the distribution of SAV could negatively impact blue crab population. The 2016 CHPP summarizes known distribution, temporal change, and threats (e.g. reduced water clarity from stormwater runoff, wastewater discharges, dredging, bottom disturbing gear, etc.) for navigation and fishing) to SAV. In 2016, there were estimated to be at least 150,000 acres of SAV in NC. Historical change in extent has not been quantified but qualitatively known to have declined in some areas.

Wetlands

Like SAV, postlarvae and juvenile blue crabs use wetlands for foraging, refuge, and migration through the estuary (45). This includes detrital matter and woody debris from adjacent wetland vegetation, particularly in the Albemarle and Pamlico systems. Blue crabs utilize marsh edge and woody debris more than unvegetated bottom and occur more regularly in marshes with longer inundation periods (112; 113). They also use wetlands to a greater extent when SAV and oyster reefs are not present, such as in the lower salinity regions of river-dominated estuaries (12). Blue crabs in these lower salinity areas also have higher growth rates and lower predation than in the more saline waters (12). The NCDMF estuarine trawl survey data show blue crab is one of the dominant juvenile species in marshes and shallow tidal creeks (34, 114).

North Carolina's extensive estuary is rich in wetlands, with an estimated 3,759,700 acres within the coastal region (45). However, this is approximately half of what existed pre-1800s (115). While federal and state laws have greatly reduced dredge and fill impacts to wetlands, losses still occur on a smaller scale due development, navigational dredging, and erosion associated with wave energy and rising sea level (45).

Wetland loss lowers the habitat's capacity to support blue crabs, to trap and filter upland pollutants, and buffer storm events. Wetland losses associated with development and shoreline hardening reduce nursery habitat and food resources available for blue crab. Looking at the effect of land use change on fish abundance, Meyer (116) found a negative correlation between abundance of juvenile blue crabs and conversion of wetlands/undeveloped forest to agriculture/development (where the development change was greater than or equal to 12%). When assessing the effect of bulkheads and living shorelines on fish and invertebrates, Scyphers et al. (117) found living shorelines supported a greater abundance and diversity of aquatic life, with blue crabs being the most clearly enhanced (300% more abundant). Predation related mortality was significantly less at vegetated shorelines than at bulkheads or riprap (118).

Shell Bottom

Oyster reefs are used as nursery habitat for early juveniles and foraging grounds for adults (12; 109). In Pamlico Sound after initial settlement, juveniles undergo a secondary migration to shallow, less-saline waters in the upper estuaries and rivers of western Pamlico Sound (5)

inhabiting oyster and wetland habitat. Blue crabs forage heavily on invertebrates and oyster spat in shell bottom (119; 120; 121). Shell bottom enhances conditions for other habitats used by blue crabs. Filter feeding shellfish improve water clarity conditions, benefiting SAV, and buffer wave energy along the shoreline reducing erosion of wetlands (122; 123; 45). For subtidal oyster reefs, the vertical height of the reef elevates oysters off the bottom, avoiding anoxic water and sedimentation and provides refuge for blue crabs during hypoxic events (121; 54; 124).

In North Carolina, shell bottom occurs on intertidal and subtidal bottom and both are used by blue crabs (122). Based on NCDMF's Bottom Mapping Program, there are approximately 21,220 acres of shell bottom habitat in coastal waters, excluding subtidal oysters in waters greater than 15' water depth (45). It is estimated that over 90% of the subtidal oyster habitat, primarily in the Pamlico Sound system has been lost (36). Loss was initially due to mechanical harvest of oysters in the early 1900s, followed by lack of recovery due to disease, continued harvest, and sedimentation. Current factors threatening subtidal oyster habitat are sedimentation and low DO (54; 125). Abundance of both intertidal and subtidal shell bottom habitat is limited by harvest and lack of hard substrate.

Inlets and Ocean Bottom

Adult female blue crabs migrate from brackish areas to high-salinity waters near ocean inlets to spawn from late spring to early fall (6). Connectivity between shell bottom, wetlands, and SAV throughout the estuary enhances the ability of blue crabs to forage and move through the system, particularly adult females migrating to their spawning grounds near inlets (126; 112).

Females rely on high-salinity cues to ensure eggs are released for development on the continental shelf. Ogburn and Habegger (127) used Southeast Area Monitoring and Assessment Program (SEAMAP) data from 1990 to 2011 to assess spawning habitat in the South Atlantic Bight. Using reproductive condition of mature females as an indicator of spawning, they found blue crabs spawned throughout the South Atlantic Bight and as far as 13 km offshore. In North Carolina, mature females were most abundant in the ocean in the summer, where approximately 84% had spawned and had only remnant eggs. Results of Ramach et al. (128) suggest inlets serve as migration corridors to the ocean where eggs are released and dispersed. Fishing effort on sponge crabs while migrating to and through inlet corridors for spawning could negatively impact the blue crab population.

HABITAT AND WATER QUALITY PROTECTION

Coastal Habitat Protection Plan

As noted earlier in the Introduction, the FRA statutes mandates the Department to prepare and periodically update the CHPP (G.S. 143B 279.8). The legislative goal for the CHPP is long-term enhancement of the coastal fisheries associated with coastal habitats. The plan provides a framework for management actions to protect and restore habitats critical to North Carolina's coastal fishery resources. There are three commissions that have regulatory jurisdiction over the coastal resources, water, and marine fishery resources including: Marine Fisheries Commission (NCMFC), Coastal Resources Commission (CRC), and the Environmental Management Commission (EMC). Habitat recommendations related to fishery management can be addressed

directly by the NCMFC. Other habitat recommendations not under NCMFC authority (e.g. water quality management) can be addressed through the CHPP implementation process. The CHPP helps to ensure consistent actions among these three commissions as well as their supporting DEQ agencies.

The CHPP describes and documents the use of habitats by species supporting coastal fisheries, status of these habitats, and the impacts of human activities and natural events on those habitats. Fish habitat is defined as freshwater, estuarine, and marine areas that support juvenile and adult populations of economically important fish, shellfish, and crustacean species (commercial and recreational), as well as forage species important in the food chain (45).

The CHPP recommends that some areas of fish habitat be designated as “Strategic Habitat Areas” (SHAs). SHAs are defined as specific locations of individual fish habitat or systems of habitat that have been identified to provide critical habitat functions or that are particularly at risk due to imminent threats, vulnerability, or rarity. Additionally, the CHPP focuses on the fish habitat and threats to the habitat. The process of identifying and designating SHAs was completed in 2018 with the approval of nominated SHAs by the NCMFC and field verification is underway. The NCMFC also has several rules in place that provide protection for blue crab habitat. Some rules prohibit bottom disturbing gear in specific areas, others designate sensitive fish habitat such as nursery areas and SAV beds, and with applicable gear restrictions (see Appendix 4.6). Descriptive boundaries are included under the 15A NCAC 03R rules. Figures 10 and 11 provide a visual representation of several rule categories of these habitat gear related rules.

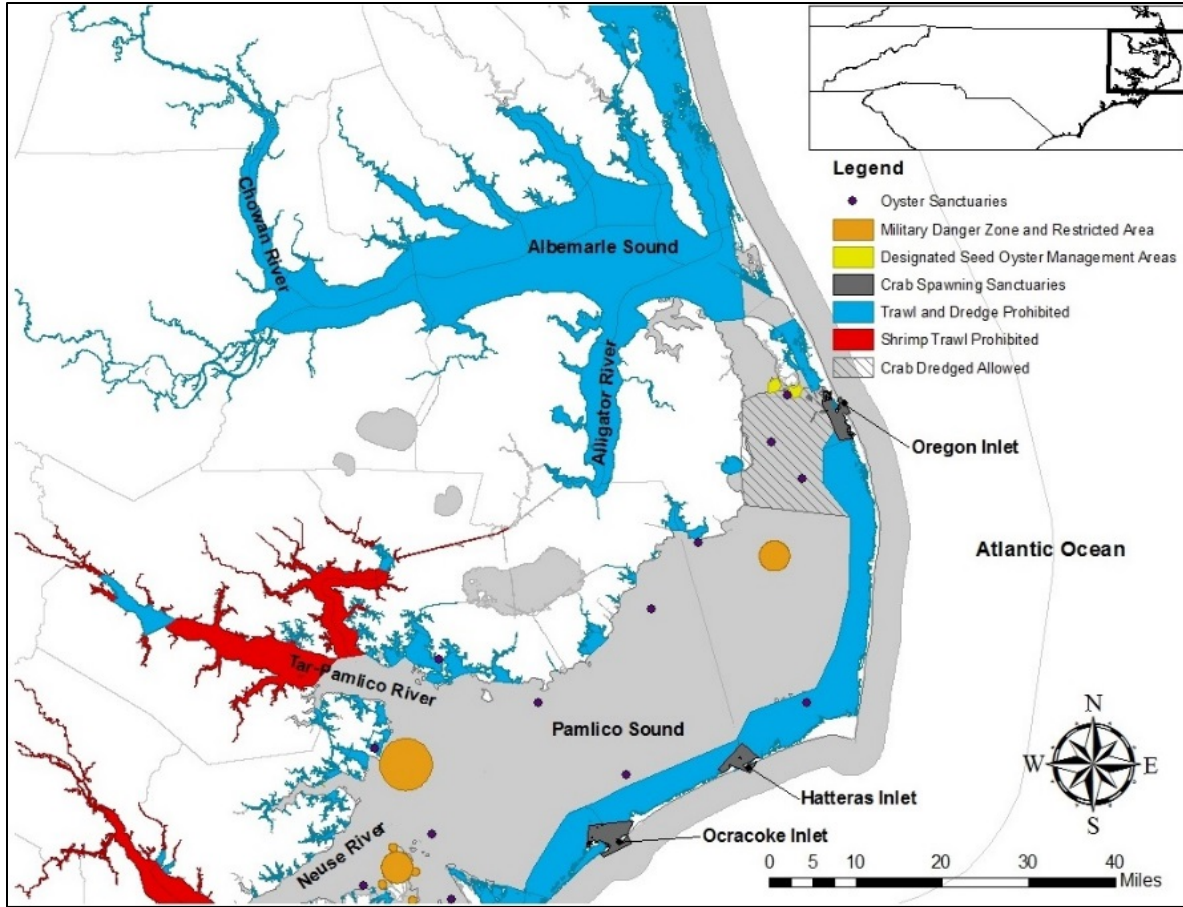


Figure 10 Estuarine areas where bottom disturbing gear is prohibited year-round or seasonally – northern coast.

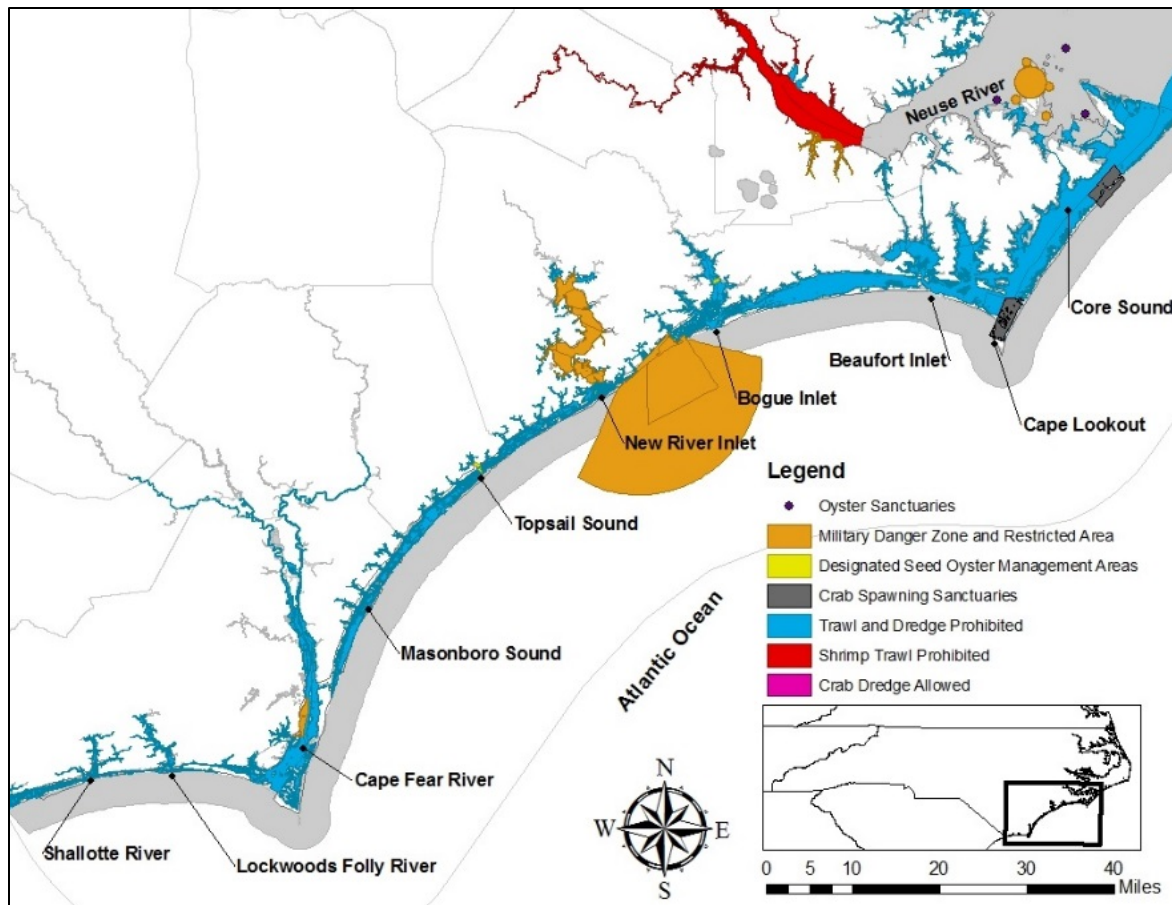


Figure 11 Estuarine areas where bottom disturbing gear is prohibited year-round or seasonally – southern coast.

Authority of Other Agencies

The North Carolina Department of Environmental Quality (NCDEQ) has several divisions responsible for rulemaking, permitting, certification, technical and financial assistance, planning, and monitoring activities which impact the coastal water quality or habitat. The North Carolina Division of Coastal Management (NCDQM) is responsible for development permits along the estuarine shoreline in 20 coastal counties. Wetland development activity throughout North Carolina is primarily permitted through the US Army Corps of Engineers (USACE) and Division of Water Resources (DWR 401 certification program). The DWR has established a water quality classification and standards program for “best usage” to promote protection of unique and special pristine waters with outstanding resource values. Water quality standards and required management strategies for point and nonpoint sources differ by water quality classification such as High Quality Waters, Outstanding Resource Waters, Nutrient Sensitive Waters, and Water Supply. Various federal and state environmental and resource agencies evaluate projects proposed for permitting and provide comments and recommendations to the DCM, DWQ, and USACE on potential habitat and resource impacts. The South Atlantic Fishery Management Council (SAFMC) has designated Essential Fish Habitat – Habitat Areas of Particular Concern (EFH-HAPC), for federally managed species, which can provide additional protection from

development projects. Several habitat areas used by blue crab are designated as EFH-HAPC, including SAV and inlets. Habitat protection relies on enforcement, the efforts of commenting agencies to evaluate impacts, and the incorporation of recommendations into permitting decisions. Habitats are also protected through the acquisition and management of natural areas as parks, refuges, reserves, or protected lands by public agencies and/or private groups.

SIGNIFICANT WEATHER EVENTS

Significant weather events such as droughts and hurricanes can alter physio-chemical parameters and consequently influence the occurrence and distribution of fish and habitat in coastal North Carolina waters. Predominant winds, currents, and rainfall at a certain time of year highly affect annual recruitment success of larvae into nursery habitat. Although indirect, blue crabs are affected by natural disturbances of their environment. In particular, hurricanes can affect blue crab harvest in the short term by concentrating blue crabs in areas where they are vulnerable to fishing gear (129). Significantly lower statewide blue crab landings in 2000 compared to landings in the late 1990's were attributed to prolonged water quality degradation in the Pamlico estuarine system following the 1999 hurricanes (130). In 1989, 2000, and 2003, lower catch per unity effort of blue crabs from NCDMF's estuarine trawl survey coincides with hurricanes and the three highest years of rainfall from 1980 to 2016 (Figure 12).

If storms are too extreme, above normal freshwater input can lower salinity to the point that megalopae and juvenile blue crab mortality occurs, negating the benefits of increased settlement. However, not all the effects of hurricanes are detrimental. For example, peaks in post-larval blue crab settlement coincided with hurricane tracks coming from a southwesterly direction (4). A large ingress of post-larval blue crabs could make a significant contribution to the blue crab population.

Hurricanes can cause flooding, flush pollutants from the upper estuarine bottom, cause sedimentation over oyster reefs, and erode wetland shorelines. While these extreme weather events have always occurred, there is evidence that the frequency and severity of minor (non-storm event) nuisance flooding and hurricanes on the east and Gulf coasts are increasing (131; 132; 133).

Major droughts occurred in North Carolina during 2000-2002 and 2007-2008 (45). The drought of 2007-2008 was the worst in North Carolina since recordkeeping began on the subject in 1895. The cycle of flood and drought years has a significant impact on the water quality and SAV by reducing freshwater input and could be a factor in blue crab recruitment success (Figure 12).

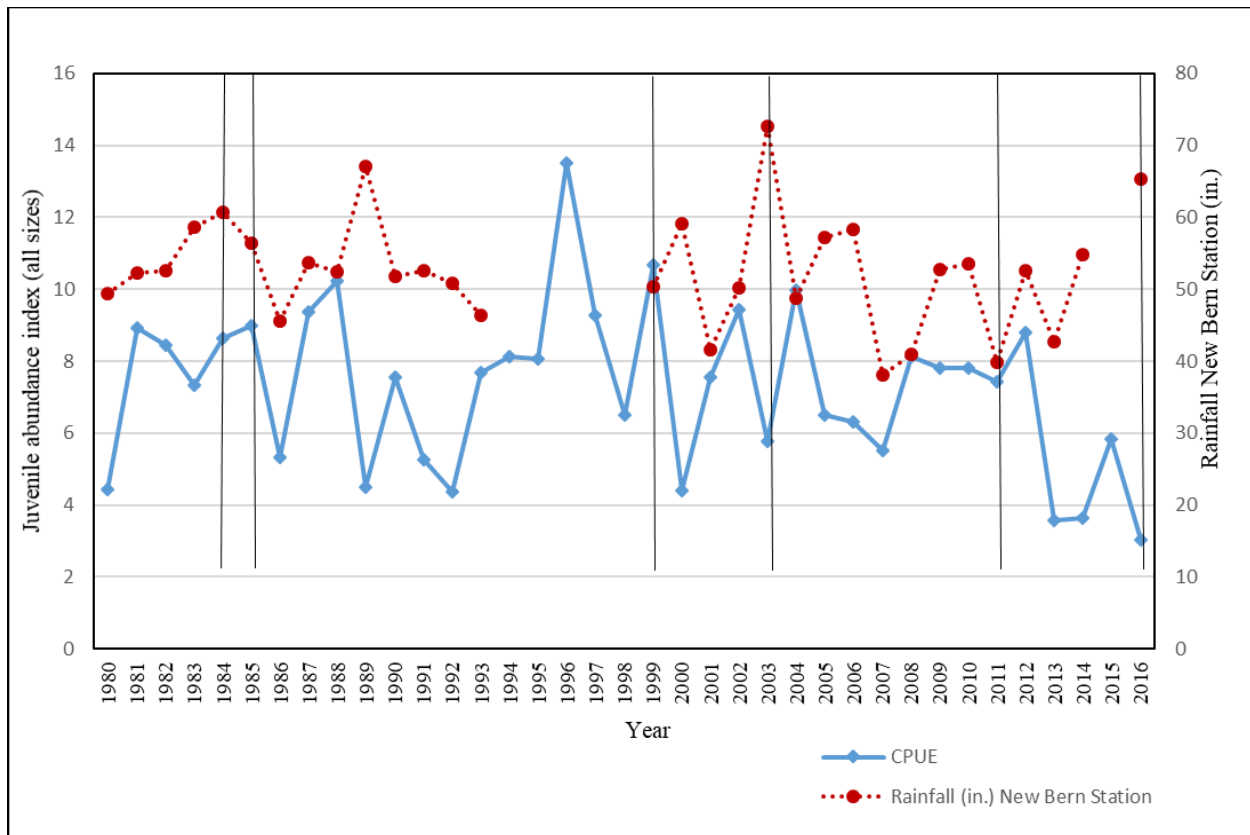


Figure 12 Annual rainfall from the New Bern station and juvenile abundance index (CPUE, all crab sizes) in New Bern, NC, 1980-2016. Source – National Weather Service and NCDMF data. Black vertical lines are years with major hurricane landfall events in NC.

A warming trend in air temperature is the primary driver of climate change that can alter the distribution and health of fish and their habitat. The 2014 National Climate Assessment summarizes observed and expected climate change and impacts regionally and overall in the U.S. (132). Of the potential changing oceanographic conditions under warming temperatures and rising sea level has large implications to North Carolina’s estuarine system, including accelerated wetland loss, degraded water quality, loss of SAV, degradation of oyster reefs, and a more open estuary due to barrier island breaching (45). Crustaceans and mollusks are at risk due to increasing acidification of waters associated with increasing carbon dioxide levels. In Puget Sound, Washington, oyster hatcheries have observed high mortality of larvae and spat due to the inability to form their calcareous shells (134). Crustaceans with good osmoregulation tend to be less vulnerable and calcification of carapaces may not change but could be more energetically costly.

DISEASE AND PARASITES

Diseases and parasites observed in blue crabs from North Carolina include bacterial infections (shell disease), a dinoflagellate parasite *Hematodinium* sp., an amoeba parasite *Paramoeba pernicioso* (gray crab disease), and a microsporidian parasite *Ameson michaelis* (cotton crab

disease). Infection rates of the parasitic dinoflagellate *Hematodinium perezii* in blue crabs along the Atlantic and Gulf coasts can exceed 50% and is usually lethal (135). A Gulf coast study found shell disease present in blue crabs at a rate of 55%, and *Vibrio* spp. present in the hemolymph of 22% of blue crabs (136). The prevalence of these in North Carolina is unknown. In 1987, an extreme outbreak of shell disease was observed in the Pamlico River (137). The chronic presence of shell disease was suggested as a possible factor contributing to a significant, progressive decline in blue crab landings in the Pamlico River during 1985 to 1989 (138). Weinstein et al. (139) found elevated levels of arsenic, aluminum, manganese, and other metals from blue crabs in contaminated waters of Pamlico River, compared to those in a relatively uncontaminated area of Albemarle Sound. Gray crab disease has not been a major problem, though there have been periodic outbreaks causing localized mortalities (140). Cotton crab disease was identified as the suspected cause of excessive mortality and weakened peelers and soft crabs in northern Outer Banks, NC shedding operations during 1999. Prevalence and lethality of diseases and parasites in blue crabs can increase under stressful conditions such as poor water quality (141). A listing of potential parasites, diseases, symbionts, and other associated organisms reported from blue crabs is presented in Guillory et al. (61).

INVASIVE SPECIES

Invasive species are plants, animals, and other organisms not native to an ecosystem and may cause economic or environmental harm by affecting the health of organisms, displacing native species, or altering natural habitat conditions. Non-native species introductions are a growing and imminent threat to living aquatic resources throughout the United States. Pathways of entry to North Carolina waters include release from aquaria and mariculture facilities, boat movement, discharge of ballast water, attachment to fishing gear, and through association with other non-native species (142; 143). Often fish species are introduced deliberately for sport-fishing purposes.

Blue catfish (*Ictalurus furcatus*) was introduced as a sport fish into Virginia waterways and has entered into the waters of North Carolina. Blue catfish have been found to regularly consume blue crabs in the Chesapeake Bay, VA during the fall and winter months with blue crab occurrence estimated at 30% of blue catfish diet during this time (144). Another non-native species known to consume blue crabs is the Asian tiger shrimp (*Penaeus monodon*). Tiger shrimp were first reported to the NCDMF in 2008. The population is believed to be small in North Carolina waters. However, in a mesocosm experiment, blue crabs less than 25mm carapace width were often located, attacked, and successfully consumed by Asian tiger shrimp (145). Preying on blue crabs, Asian tiger shrimp and blue catfish have the potential to negatively impact the blue crab population.

The invasive Rhizocephalan parasitic barnacle (*Loxothylacus panopaei*) has been reported in Xanthid crabs (*Eurypanopeus depressus*) in the Masonboro and Rachel Carson National Estuarine Research Reserves (146). The parasite impacts the host by impeding reproduction, halting growth, and reducing feeding. These barnacles, which originated from the Gulf of Mexico, are known to also infect blue crabs (147), although their presence in blue crabs in North Carolina has not been investigated. Infected blue crabs in Texas were found to rarely burrow below the sediment (148), which would increase vulnerability to predation and environmental conditions.

Juvenile blue crabs use submerged aquatic vegetation beds as a source of refuge. Non-native aquatic plants can cause severe environmental impacts, outcompeting and displacing native plants. Large expanses of coastal rivers and streams in North Carolina were previously blocked by mats of alligatorweed (*Alternanthera philoxeroides*) and Eurasian watermilfoil (*Myriophyllum spicatum*; 149). These plants were successfully cleared through chemical treatment and waterways remain open with limited maintenance control. However, studies in the Chesapeake Bay found as non-native plant density increased so did native plant density (150) and function as nursery areas for juvenile blue crabs (151). Similarly, NCDMF sampling data has found juvenile blue crabs and other species in Eurasian watermilfoil in low salinity waters such as Kitty Hawk Bay and Currituck Sound. When non-native spread is assessed on a local scale, habitats may be altered to promote native plant spread by reduced water velocity, increased sedimentation, sediment stabilization, and increased water clarity. Control, research, and education are the three key elements of a successful aquatic weed control program. For more information on invasive species see the [North Carolina Coastal Habitat Protection Plan 2016](#) (45) and the [North Carolina Aquatic Nuisance Species Management Plan \(152\)](#).

BYCATCH IN OTHER FISHERIES

Due to the broad environmental and habitat tolerances of blue crabs, they are found in the same areas as many of North Carolina's commercially important finfish and shellfish species. This habitat sharing, in part, causes blue crabs to be caught incidentally as bycatch in fisheries targeting other species.

Crab pots are the primary gear used to harvest blue crabs. These, along with other gears that target blue crab, make up over 99% of blue crab harvest; however, they are caught as bycatch with other types of gear (38). Blue crabs harvested as bycatch make up less than 0.5% of the total landings, ranging from 32,567 (2016) to 79,993 pounds (2014) in the past ten years (Figure 13).

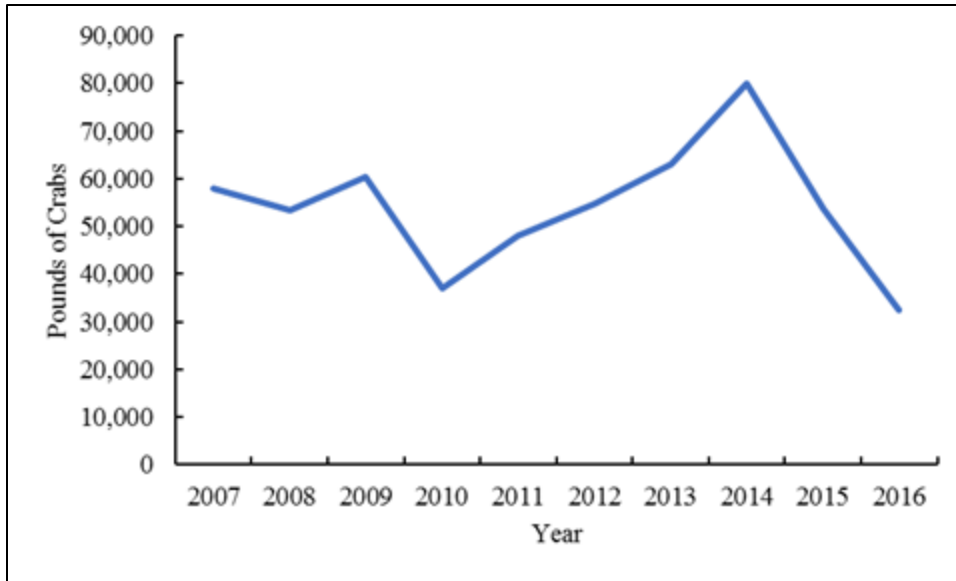


Figure 13 Pounds of blue crabs harvested as bycatch from all fisheries, 2007-2016.

Studies have found blue crabs make up between 6% and 30% of total catch by number in the estuarine gill net fishery, typically accounting for the majority of non-fish catch (153; 154; 155; 156; 157; 158). Hassel (157) found blue crab bycatch increased as gill net mesh size decreased. Shrimp trawls are also a significant source of blue crab bycatch. Blue crabs make up 0.14% of catch by weight in otter trawls (159), and 2.03% by weight in skimmer trawls (160).

Blue crabs are also discarded as bycatch in many fisheries. They can be discarded for a variety of reasons, such as; limited quantity, sublegal size, or difficult to remove from gear causing crabs to be unmarketable after removal (e.g. gill nets). Gill nets are the only gear with reliable discard estimates of blue crab from commercial catches in North Carolina. This discard data is collected as part of the estuarine gill net observer program in which observers sample the catch of fishermen when they fish their gear. Over the past five years, 80% of the nearly 24 thousand observed crabs caught in gill nets were discarded (Table 24). There is high mortality associated with removal from this gear because when crabs become entangled in the webbing it is very difficult and time consuming to remove them without harming the crab. Due to current data limitations it is not feasible to estimate the total discard mortality of blue crabs in all fisheries in North Carolina. However, from the estimates available, these discards may represent a significant source of fishing mortality.

Table 24 Number of observed blue crabs kept and discarded from the estuarine gill net observer program, 2013-2017.

Year	Kept Crabs	Discarded Crabs	Total	Discard Percentage	Observed Trips with Number of Crabs Recorded	Total Observed Trips (Onboard)	Total Estuarine Gill Net Trips
2013	741	4,751	5,492	87%	451	661	29,128
2014	1,883	5,613	7,496	75%	540	827	21,048
2015	1,076	2,997	4,073	74%	413	784	17,385
2016	681	2,706	3,387	80%	353	656	16,859
2017	284	2,940	3,224	91%	315	740	20,459
Total	4,665	19,007	23,672	80%	2,072	3,668	104,879

PROPOSED MANAGEMENT STRATEGIES UNDER BLUE CRAB AMENDMENT 3

- 1) Achieving sustainable harvest: To recover the North Carolina blue crab stock the selected management strategy is: a January closed season and a 6 ¾-inch maximum size limit for mature female blue crabs north of the Highway 58 Bridge; a March 1-15 closed season south of the Highway 58 Bridge; and to retain the prohibition on immature female hard crab harvest and the 5% cull tolerance established in the 2016 Revision to Amendment 2. These measures are estimated to result in a 3.1% harvest reduction from 2016 landings. Other measures selected were to: have the season closures replace the annual pot closure period; adopt the adaptive management framework based on the peer-reviewed and approved stock assessment; and to update the stock assessment once 2019 data is available.
- 2) Non-quantifiable management measures: While not having quantifiable harvest reductions, several additional management measures were identified that could help improve the condition of the blue crab stock. The selected management strategy includes the following: retain a minimum number of 3 cull rings per pot with one in the modified corner position and to prohibit the harvest of dark sponge crabs from April 1-30 measures established in the 2016 Revision to Amendment 2; and removing the cull ring exemptions for the Newport River and eastern Pamlico Sound.
- 3) Water quality: Negative impacts to blue crab from poor water quality have been widely documented and strategies were developed for the N.C. Marine Fisheries Commission (MFC) to pursue to improve water quality. Strategies selected were: highlight problem areas and advise other regulatory agencies; push to create an interagency work group; support the Clean Water Act; task the CHPP steering committee to prioritize blue crab water quality impacts; send letters to other state agencies sharing concerns about water quality and Best Management Practices; invite other agencies to future MFC meetings to present their efforts to address water quality; and initiate public outreach on how to report crab and fish kills.

- 4) Crab spawning sanctuaries: Research has shown the existing crab spawning sanctuaries are largely ineffective due to their small size and that expanding the sanctuary system as well as establishing migration corridors will increase the number of mature females reaching the spawning grounds. The selected management strategy includes: maintain the current sanctuary boundaries for Oregon, Hatteras, and Ocracoke inlets; move the Drum Inlet sanctuary boundary to encompass Ophelia Inlet; expand the Barden Inlet sanctuary boundary; and designate new crab spawning sanctuaries around Beaufort, Bogue, Bear, Browns, New River, Topsail, Rich, Mason, Masonboro, Carolina Beach, Cape Fear River, Shallotte, Lockwood Folly, and Tubbs inlets. The new crab spawning sanctuaries will be closed from March 1 – October 31 with the same restrictions as previously existing sanctuaries.
- 5) Terrapin excluder devices: The bycatch of diamondback terrapins has been discussed every blue crab FMP since 1998 with little action. To address this issue, the selected management strategy is to study locally specific pot funnel designs to reduce terrapin bycatch in crab pots and to identify individual areas with diamondback terrapin hot spots that will be closed to pots unless a terrapin excluder device is used.
- 6) Bottom disturbing gear: To reduce the habitat impacts from the blue crab fishery, the use of bottom disturbing gear, specifically dredges and trawls, was examined. The selected management strategy includes: retain the prohibition on targeted crab dredging established in the 2016 Revision to Amendment 2; reduce the crab bycatch limit from oyster dredges to 10% of the combined crab and oyster catch or 100 pounds, whichever is less; and to prohibit the use of crab trawls in areas where shrimp trawls are prohibited in the Pamlico, Pungo, and Neuse rivers.

RESEARCH RECOMMENDATIONS

BIOLOGICAL PROFILE

High

Research mature female migration routes and seasonal habitat use (e.g., inlets, staging areas).

Medium

Research the impact of increased predator abundance on the blue crab stock.

COMMERCIAL FISHERY

Low

Research and identify key market forces and their effects on the blue crab industry.

BYCATCH AND DISCARDS

High

Research gear modifications to minimize interactions with non-target species (e.g., diamondback terrapin) in the blue crab fishery.

Research interaction rates of non-target species in the blue crab fishery and identify factors that may lead to interactions (e.g., migration patterns, habitat utilization).

Medium

Characterize the harvest and discard of blue crabs from crab shedding operations.

WATER QUALITY DEGRADATION

High

Research the impact of endocrine disrupting chemicals on the various life stages of blue crabs and ways to reduce their introduction into estuarine waters, including discharge from wastewater treatment plants.

Research the impacts of land use activities and shoreline clearing on water quality and the blue crab stock.

Medium

Research the extent, causes, and impacts of hypoxia and anoxia on blue crab behavior and population abundance in estuarine waters.

HABITAT DEGRADATION AND LOSS

High

Identify biological characteristics of submerged aquatic vegetation beds of ecological value to blue crab and implement restoration and conservation measures.

Medium

Assess the impact of inlet dredging activities on mature female blue crabs.

Identify, map, and protect habitat of ecological value to blue crab (in particular juvenile habitat) and implement restoration and conservation measures.

INVASIVE SPECIES

Medium

Research the impact of invasive species (e.g., blue catfish) on the blue crab stock.

BYCATCH IN OTHER FISHERIES

High

Implement long-term monitoring of blue crab discards in other fisheries (e.g., gill net, trawl).

2018 BLUE CRAB STOCK ASSESSMENT

High

Develop statewide fishery-independent survey(s) to monitor the abundance of all blue crab life stages.

Expand time and area coverage of existing fishery-independent surveys.

Better characterize the magnitude of recreational harvest.

Develop better estimates of life-history parameters, especially growth and natural mortality.

Explore alternative biological reference points.

Medium

Identify key environmental factors that significantly impact North Carolina's blue crab stock and investigate assessment methods that can account for these environmental factors.

Implement monitoring of hazardous events (e.g., hurricane, extreme hot or cold weather) affecting blue crab population dynamics and harvest.

Explore alternative model types.

Low

Investigate and support research on promising methods to age blue crabs.

Evaluate the genetic stock structure of blue crabs within North Carolina and the magnitude of mixing between populations.

Identify programs outside the NCDMF that collect data of potential use to the stock assessment of North Carolina's blue crabs.

LITERATURE CITED

1. W. A. Van Engel, "The blue crab and its fishery in Chesapeake Bay. Part 1. Reproduction, early development, growth, and migration.," *Commercial Fisheries Review*, vol. 20, no. 6, pp. 6-17, 1958.
2. C. E. Epifanio, "Transport of blue crab (*Callinectes sapidus*) larvae in the waters off Mid-Atlantic states.," *Bulletin of Marine Sciences*, vol. 57, no. 3, pp. 713-725, 1995.
3. R. B. J. Forward, J. H. Cohen, R. D. Irvine, J. L. Lax, R. Mitchell, A. M. Schick, M. M.

- Smith, J. M. Thompson and J. I. Venezia, "Settlement of blue crab *Callinectes sapidus* megalopae in a North Carolina estuary," *Marine Ecology Progress Series*, vol. 269, pp. 237-247, 2004.
4. D. B. Eggleston, N. B. Reynolds, L. L. Etherington, G. R. Plaia and L. Xie, "Tropical storm and environmental forcing on regional blue crab (*Callinectes sapidus*) settlement.," *Fisheries Oceanography*, vol. 19, no. 2, pp. 89-106, 2010.
 5. L. L. Etherington and D. B. Eggleston, "Large-scale blue crab recruitment: linking postlarval transport, post-settlement planktonic dispersal, and multiple nursery habitats.," *Marine Ecology Progress Series*, vol. 204, pp. 179-198, 2000.
 6. D. J. Whitaker, "Sea Science. Blue Crabs," Department of Natural Resources, Columbia, South Carolina, 2006.
 7. J. L. Hench, R. B. Forward, S. D. Carr, D. Rittschof and R. A. Luetlich, "Testing a selective tidal-stream transport model: observations of female blue crab (*Callinectes sapidus*) vertical migration during the spawning season," *Limnological Oceanography*, vol. 49, no. 5, pp. 1857-1870, 2004.
 8. R. B. Forward, J. H. Cohen, M. Z. Darnell and A. Saal, "The circatidal rhythm in vertical swimming of female blue crabs, *Callinectes sapidus*, during their spawning migration: a reconsideration," *Journal of Shellfish Research*, vol. 24, pp. 587-590, 2005.
 9. M. Z. Darnell, D. Rittschof, K. M. Darnell and R. E. McDowell, "Lifetime reproductive potential of female blue crabs, *Callinectes sapidus*, in North Carolina, USA.," *Marine Ecology Progress Series*, vol. 394, pp. 153-163, 2009.
 10. NCDMF, "Assess the effects of hurricanes on North Carolina's blue crab resource.," North Carolina Division of Marine Fisheries, Morehead City, NC, 2008.
 11. NCDMF, "North Carolina Fishery Management Plan Blue Crab," North Carolina Division of Marine Fisheries, Morehead City, NC, 2004.
 12. M. H. Posey, T. D. Alphin, H. Harwell and B. Allen, "Importance of low salinity areas for juvenile blue crabs, *Callinectes sapidus* Rathbun, in river-dominated estuaries in southeastern United States," *Journal of Experimental Marine Biology and Ecology*, vol. 319, pp. 81-100, 2005.
 13. K. A. Johnson, "A review of national and international literature on the effects of fishing on benthic habitats.," NOAA Technical Memorandum, 2002.
 14. R. Forward, R. Tankersley and P. Pochelon, "Circatidal activity rhythms in ovigerous blue crabs, *Callinectes sapidus*: Implications for egg-tide transport during the spawning migration.," *Marine Biology*, vol. 142, no. 1, pp. 67-76, 2003.
 15. J. Hill, D. L. Fowler and M. J. Van Den Avyle, "Species profile: life histories and environmental requirements of coastal fishes and invertebrates (Mid-Atlantic) - blue crab.," U.S. Army Corp of Engineers, 1989.
 16. M. Prager, J. McConaughy, C. Jones and P. Geer, "Fecundity of the blue crab, *Callinectes sapidus*, in Chesapeake Bay.," *Bulletin of Marine Science*, vol. 46, pp. 170-179, 1990.
 17. J. D. J. Costlow, G. H. Rees and C. G. Bookhout, "Preliminary note on the complete larval development of *Callinectes sapidus* Rathbun under laboratory conditions.," *Limnological Oceanography*, vol. 4, pp. 222-223, 1959.
 18. J. D. Costlow and C. G. Bookhout, "The larval development of *Callinectes sapidus* Rathbun reared in the laboratory.," *Biological Bulletin*, vol. 116, no. 3, pp. 373-396, 1959.
 19. K. J. Fischler, "The use of catch-effort, catch sampling, and tagging data to estimate a

- population of blue crabs.," Transactions of the American Fisheries Society, vol. 94, no. 4, pp. 287-310, 1965.
20. L. Rugolo, K. Knotts, A. Lange, V. Crecco, M. Terceiro, C. Bonzek, C. Stagg, R. O'Reilly and D. Vaughan, "Stock assessment of the Chesapeake Bay blue crab (*Callinectes sapidus*)," 1997.
 21. L. von Bertalanffy, "A quantitative theory of organic growth.," Human Biology, vol. 10, pp. 181-213, 1938.
 22. J. T. Schnute, "A versatile growth model with statistically stable parameters.," Canadian Journal of Fisheries and Aquatic Sciences, vol. 28, no. 9, pp. 1128-1140, 1981.
 23. M. D. Murphy, A. L. McMillen-Jackson and B. Mahmoudi, "A stock assessment for blue crab, *Callinectes sapidus*, in Florida waters. Report to the Florida Fish and Wildlife Commission Division of Marine Fisheries Management.," Florida Fish and Wildlife Conservation Commission - Fish and Wildlife Research Institute, St.Petersburg, FL, 2007.
 24. B. J. Rothchild and J. S. Ault, "Assessment of the Chesapeake Bay Blue Crab Stock. Ref No. UMCEES[CBL]92-082," 1992.
 25. L. R. Cadman and M. P. Weinstein, "Effects of temperature and salinity on the growth of laboratory-reared juvenile blue crabs *Callinectes sapidus* Rathbun," Journal of Experimental Marine Biology and Ecology, vol. 121, pp. 193-207, 1988.
 26. L. J. Bauer and T. J. Miller, "Temperature, salinity, and size-dependent winter mortality of juvenile blue crabs (*Callinectes sapidus*).," Estuaries and Coasts, vol. 33, pp. 668-677, 2010.
 27. B. J. Puckett, D. H. Secor and S. J. Ju, "Validation and application of lipofuscin-based age determination for Chesapeake Bay blue crabs *Callinectes sapidus*.," Transactions of the American Fisheries Society, vol. 137, pp. 1637-1649, 2008.
 28. C. Crowley, "Aging of Florida blue crabs, *Callinectes sapidus*, through the biochemical extraction of lipofuscin," University of South Florida, United States, Florida, 2012.
 29. R. Kilada, B. Sante-Marie, R. Rochette, N. Davis, C. Vanier and S. Campana, "Direct determination of age in shrimps, crabs, and lobsters.," Journal of Fisheries and Aquatic Sciences, vol. 69, pp. 1728-1733, 2012.
 30. B. Williams, Shrimp, lobsters, and crabs of the Atlantic coast of the eastern United States Maine to Florida., Washington, DC: Smithsonian Institution Press, 1984, p. 550.
 31. H. Hines, A. M. Haddon and L. A. Wiechert, "Guild structure and foraging impact of blue crabs and epibenthic fish in a subestuary of the Chesapeake Bay.," Marine Ecology Progress Series, vol. 67, pp. 105-126, 1990.
 32. R. A. Laughlin, "Feeding habits of blue crab, *Callinectes sapidus* Rathbun, in the Apalachicola Estuary.," Florida Bulletin of Marine Science, vol. 32, pp. 807-822, 1982.
 33. H. Cordero and R. D. Seitz, "Structured habitat provides a refuge from blue crab, *Callinectes sapidus*, predation for the bay scallop, *Argopecten irradians concentricus* (Say 1822).," Journal of Experimental Marine Biology and Ecology, vol. 460, pp. 100-108, 2014.
 34. NCDMF, Morehead City, NC: North Carolina Division of Marine Fisheries, unpublished data.
 35. NCDMF, "Stock assessment of the North Carolina blue crab (*Callinectes sapidus*), 1995-2016.," Morehead City, NC, 2018.
 36. NCDMF, "May 2016 Revision to Amendment 2 to the North Carolina blue crab fishery

- management plan.," Division of Marine Fisheries, Morehead City, NC, 2016.
37. NCDMF, "North Carolina blue crab fishery management plan," Morehead City, NC, 1998.
 38. NCDMF, "North Carolina blue crab fishery management plan Amendment 2," North Carolina Division of Marine Fisheries, Morehead City, NC, 2013.
 39. NCDMF, "North Carolina Division of Marine Fisheries License and Statistics Section Annual Report, North Carolina Department of Environmental Quality, Division of Marine Fisheries, Morehead City, NC, 2018.
 40. NOAA, "NOAA Fisheries Annual Commercial Landings Statistics," NOAA Office of Science and Technology, 2018. [Online]. Available: <https://www.st.nmfs.noaa.gov/commercial-fisheries/commercial-landings/annual-landings/index>. [Accessed 2019].
 41. F. Chestnut and H. S. Davis, "Synopsis of marine fisheries of North Carolina: Part I: Statistical information, 180-1973.," 1975.
 42. NOAA Fisheries, "Annual trade data by product, country/association.," Fisheries Statistics and Economics Division, 2018.
 43. H. Vogelsong, J. Johnson and J. Nobles, "Survey of catch/effort data of blue crabs from the NC coastal and estuarine landowners.," 02-ECON-01, Raleigh, NC, 2003.
 44. V. Uhrin and J. Schellinger, "Marine debris impacts to a tidal fringing marsh in North Carolina," *Marine Pollution Bulletin*, vol. 62, pp. 2605-2610, 2011.
 45. NCDEQ, "North Carolina Coastal Habitat Protection Plan Source Document.," NC Division of Marine Fisheries, Morehead City, NC, 2016.
 46. ASMFC, "Evaluating fishing gear impacts to submerged aquatic vegetation and determining mitigation strategies.," ASMFC Habitat Management Series #5, Washington D.C., 2000.
 47. V. Uhrin, M. S. Fonseca and G. P. DiDomenico, "Effects of Caribbean spiny lobster traps on seagrass beds of the Florida Keys National Marine Sanctuary: damage assessment and evaluation of recovery," in *American Fisheries Society Symposium*, 2005.
 48. NOAA, "NOAA Marine Debris Program: Report on marine debris impacts on coastal and benthic habitats.," Silver Spring, MD, 2016.
 49. MSC (Moratorium Steering Committee), "Final report of the Moratorium Steering Committee to the Joint Legislative Commission of Seafood and Aquaculture of the North Carolina General Assembly.," Raleigh, NC, 1996.
 50. D. B. Eggleston, G. W. Bell and S. P. Searcy, "Do blue crab spawning sanctuaries in North Carolina protect the spawning stock.," *Transactions of the American Fisheries Society*, vol. 138, no. 3, pp. 581-592, 2009.
 51. NCDMF, "Shrimp and crab trawling in North Carolina's estuarine waters.," Report to NC Marine Fisheries Commission, Morehead City, NC, 1999.
 52. NCDMF, "North Carolina fisheries management plan: oysters.," North Carolina Division of Marine Fisheries, Morehead City, NC, 2001.
 53. H. S. Lenihan, F. Micheli, S. W. Shelton and C. H. Peterson, "The influence of multiple environmental stressors on susceptibility to parasites: an experimental determination with oysters.," *Limnology and Oceanography*, vol. 44, pp. 910-924, 1999.
 54. H. S. Lenihan and C. H. Peterson, "How habitat degradation through fishery disturbance enhances impacts of hypoxia on oyster reefs.," *Ecological Applications*, vol. 8, no. 1, pp. 128-140, 1998.

55. P. J. Auster and R. W. Langton, "The effects of fishing on fish habitat," in American Fisheries Society Symposium, 1999.
56. D. H. Schoellhamer, "Anthropogenic sediment resuspension mechanisms in a shallow microtidal estuary.," *Estuarine Coastal and Shelf Science*, vol. 43, no. 5, pp. 533-548, 1996.
57. D. R. Corbett, T. West, L. Clough and H. Daniels, "Potential impacts of bottom trawling on water column productivity and sediment transport processes.," Raleigh, NC, 2004.
58. T. M. Delapenna, M. A. Allison, G. A. Gill, R. D. Lehman and K. W. Warnken, "The impact of shrimp trawling and associated sediment resuspension in mud dominated, shallow estuaries.," *Estuarine Coastal and Shelf Science*, vol. 69, no. 3-4, pp. 519-530, 2006.
59. L. B. Cahoon, M. H. Posey, T. D. Alphin, D. Wells, S. Kissling, W. H. Daniels and J. Hales, "Shrimp and crab trawling impacts on estuarine soft-bottom organisms.," Wilmington, NC, 2002.
60. R. A. Deehr, "Measuring the ecosystem impacts of commercial shrimp trawling and other fishing gear in Core Sound, NC using ecological network analysis.," 2012.
61. V. Guillory, "A review of incidental fishing mortalities of blue crabs," in Proceedings of the blue crab mortality symposium, Ocean Springs, MS, 2001.
62. K. J. Havens, D. M. Bilkovic, D. Stanhope and K. Angstat, "Location, Location, Location: The importance of cull ring placement in blue crab traps.," *Transactions of the American Fisheries Society*, vol. 138, no. 4, pp. 720-724, 2009.
63. P. J. Rudershausen and J. E. Hightower, "Retention probability varies with cull ring size in traps fished for blue crab," *North American Journal of Fisheries Management*, vol. 36, no. 1, pp. 122-130, 2016.
64. R. Doxey, "Bycatch in the crab pot fishery. Final report to the Marine Fisheries Commission.," 99-FEG-45, 2000.
65. T. Thorpe, M. Hooper and T. Likos, "Bycatch potential, discard mortality and condition of fish and turtles associated with the spring commercial blue crab (*Callinectes sapidus*) pot fishery.," 04-POP-03, 2005.
66. Steve, J. Gearhart, D. Borggard, L. Sabo and A. Hohn, "Characterization of North Carolina commercial fisheries with occasional interactions with marine mammals.," NOAA Technical Memorandum NFSC-SEFSC-458, 2001.
67. NOAA, "Guide to the Atlantic large whale take reduction plan," 2010.
68. S. Epperly, L. Avens, L. Garrison, T. Henwood and W. Hoggard, "Analysis of sea turtle bycatch in the commercial shrimp Fisheries of Southeast U.S. Waters and the Gulf of Mexico," NOAA Technical Memorandum NMFS SEFSC, no. 490, 2002.
69. N. Avissar, E. Hasen, N. Young and L. Crowder, "Will it float? Testing a new technique for reducing loggerhead sea turtle damage to crab pots.," *North American Journal of Fisheries Management*, vol. 29, no. 1, pp. 170-175, 2011.
70. J. M. Bishop, "Incidental capture of diamondback terrapin by crab pots.," *Estuaries*, vol. 6, pp. 426-430, 1983.
71. S. F. Hildebrand, "Growth of diamondback terrapin size attained, sex ratio and longevity.," *Zoological*, vol. 9, pp. 551-563, 1932.
72. R. A. Seigel and J. W. Gibbons, "Workshop on the ecology, status, and management of the diamondback terrapin (*Malaclemys terrapin*), Savannah River Ecology Laboratory, 2 August 1994: Final results and recommendations.," *Chelonian Conservation and Biology*,

- vol. 1, pp. 240-243, 1995.
73. M. E. Dorcas, J. D. Wilson and W. Gibbons, "Crab trapping causes population decline and demographic change in diamondback terrapins over two decades.," *Biological Conservation*, vol. 137, pp. 334-340, 2007.
 74. M. Voss, J. A. Browder, A. Wood and A. Michaelis, "Factors driving the density of derelict crab pots and their associated bycatch in North Carolina waters.," *Fisheries Bulletin*, vol. 113, pp. 378-390, 2015.
 75. S. L. Funderburk, S. J. Jordan, J. A. Mihursky and D. Riley, "Habitat requirements for Chesapeake Bay living resources. Second Edition.," Annapolis, MD, 1991.
 76. M. Wannamaker and J. A. Rice, "Effects of hypoxia on movements and behavior of selected estuarine organisms from the southeastern United States.," *Journal of Experimental Marine Biology and Ecology*, vol. 249, no. 2, pp. 145-163, 2000.
 77. G. W. Bell, D. B. Eggleston and T. G. Wolcott, "Behavioral responses of free-ranging blue crabs to episodic hypoxia. II. Feeding," *Marine Ecology Progress Series*, vol. 259, pp. 277-235, 2003.
 78. H. W. Paerl, L. M. Valdes, M. F. Piehler and C. A. Stow, "Assessing the effects of nutrient management in an estuary experiencing climate change: the Neuse River Estuary, North Carolina.," *Environmental Management*, vol. 37, no. 3, pp. 422-436, 2006.
 79. M. E. Pattilo, T. E. Czapla, D. M. Nelson and M. E. Monaco, "Distribution and abundance of fishes and invertebrates in Gulf of Mexico estuaries. Volume II: Species life history summaries.," Silver Springs, MD, 1997.
 80. NOAA, ELMR distribution and abundance and life history tables for estuarine fish and invertebrate species, Silver Springs, MD: NOAA/NOS Biogeography Program, 2001.
 81. W. Stickle, M. Kapper, L. Liu, E. Gnaiger and S. Wang, "Metabolic adaptation of several species of crustaceans and molluscs to hypoxia; tolerance and microcalorimetric studies.," *Biological Bulletin*, vol. 177, pp. 303-312, 1989.
 82. P. L. Defur, C. P. Mangum and J. E. Reese, "Respiratory responses of the blue crab, *Callinectes sapidus*, to long-term hypoxia.," *Biological Bulletin*, vol. 178, pp. 46-54, 1990.
 83. G. W. Bell, D. B. Eggleston and E. J. Noga, "Molecular keys unlock the mysteries of variable survival responses of blue crabs to hypoxia.," *Oecologia*, vol. 163, pp. 57-68, 2010.
 84. T. Sullivan and D. Gaskill, "Effects of anoxia on the value of bottom habitat for fisheries production in the Neuse River estuary.," North Carolina Division of Marine Fisheries, Morehead City, NC, 1999.
 85. C. D. Selberg, L. A. Eby and L. B. Crowder, "Hypoxia in the Neuse River Estuary: responses of blue crabs and crabbers.," *North American Journal of Fisheries Management*, vol. 21, pp. 358-366, 2001.
 86. H. W. Paerl and D. R. Whitall, "Anthropogenically derived atmospheric nitrogen deposition, marine eutrophication and harmful algal bloom expansion: Is there a link?" *Ambio*, vol. 28, no. 4, pp. 307-311, 1999.
 87. M. A. Mallin, "Impacts of industrial animal production on rivers and estuaries.," *American Scientist*, vol. 88, no. 1, pp. 26-37, 2000.
 88. M. Rothenberger, J. M. Burkholder and C. Brownie, "Long-term effects of changing land use practices on surface water quality in a major lagoonal estuary.," *Environmental*

- Management, vol. 44, pp. 505-523, 2009.
89. P. P. Pate and R. Jones, "Effects of upland drainage on estuarine nursery areas of Pamlico Sound, North Carolina.," UNC Sea Grant, Raleigh, NC, 1981.
 90. J. S. Osterberg, K. M. Darnell, T. M. Blickley, J. A. Romano and D. Rittschof, "Acute toxicity and sublethal effects of common pesticides in post-larval juvenile blue crabs, *Callinectes sapidus*.,," *Journal of Experimental Marine Biology and Ecology*, Vols. 424-425, pp. 5-14, 2012.
 91. Gould, P. E. Clark and F. P. Thurberg, "Pollutant effects on demersal fishes," in *Selected living resources, habitat conditions, and human perturbations of the Gulf of Maine*, Vols. NMFS-NE-106, R. W. Langton and J. A. Gibson, Eds., Woods Hole, MA, National Oceanographic and Atmospheric Administration, 1994, pp. 30-40.
 92. J. S. Weis and P. Weis, "Effects of environmental pollutants on early fish development," *Aquatic Sciences*, vol. 1, no. 1, pp. 45-55, 1989.
 93. P. L. DeFur and L. Foersom, "Toxic chemicals: can what we don't know harm us?" *Environmental Research*, vol. Section A, pp. 113-133, 2000.
 94. R. Wilbur and M. W. Pentony, "Human-induced nonfishing threats to essential fish habitat in the New England region," in *Fish Habitat: Essential Fish Habitat and Rehabilitation*, Silver Springs, MD, 1999.
 95. M. J. Giorgino, R. B. Rasmussen and C. A. Pfeifle, "Occurrence of organic wastewater compounds in selected surface-water supplies, triangle area of North Carolina, 2002-2005.," *Scientific Investigations Report 2007-5054*, Raleigh, NC, 2007.
 96. D. W. Kolpin, E. T. Furlong, M. T. Meyer, E. M. Thurman, S. D. Zaugg, L. B. Barber and H. T. Buxton, "Pharmaceuticals, hormones, and other organic wastewater contaminants in US streams, 1999-2000: a national reconnaissance.," *Environmental Science and Technology*, vol. 36, pp. 1202-1211, 2002.
 97. Booth and E. Zou, "Impact of molt-disrupting BDE-47 on epidermal ecdysteroid signaling in the blue crab, *Callinectes sapidus*, in vitro.," *Aquatic Toxicology*, vol. 177, pp. 373-379, 2016.
 98. L. J. McKenney, "The influence of insect juvenile hormone agonists on metamorphosis and reproduction in estuarine crustaceans.," *Integrative and Comparative Biology*, vol. 45, no. 1, pp. 97-105, 2005.
 99. J. Li, D. Yang, L. Li, K. Jabeen and H. Shi, "Microplastics in commercial bivalves from China.," *Environmental Pollution*, vol. 207, pp. 190-195, 2015.
 100. D. S. Green, "Effects of microplastics on European flat oysters, *Ostrea edulis*, and their associated benthic communities.," *Environmental Pollution*, vol. 216, pp. 95-103, 2016.
 101. R. Waite, M. J. Donnelly and L. J. Walters, "Quantity and types of microplastics in the organic tissues of the eastern oyster *Crassostrea virginica* and Atlantic mud crab *Panopeus herbstii* from a Florida estuary.," *Marine Pollution Bulletin*, vol. 129, pp. 179-185, 2018.
 102. S. Lenihan and J. H. Grabowski, "Recruitment to and utilization of oyster reef habitat by fishes, shrimps, and blue crabs: An experiment with economic analysis.," Beaufort, NC, 1998.
 103. M. H. Posey, T. D. Alphin, C. W. Powell and E. Townsend, "Use of oyster reefs as habitat for epibenthic fish and decapods.," in *Oyster Reef Habitat Restoration: A Synopsis and Synthesis of Approaches.*, M. W. Luckenbach, R. Mann and J. A. Wesson, Eds., Williamsburg, VA, Virginia Institute of Marine Science Press, 1999, pp. 229-237.

104. R. A. Everett and G. M. Ruiz, "Coarse woody debris as a refuge from predation in aquatic communities: An experimental test.," *Oecologia*, vol. 93, pp. 475-486, 1993.
105. P. Murphy and M. Fonseca, "Role of high and low energy seagrass beds as nursery areas for *Penaeus duorarum* in North Carolina.," *Marine Ecology Progress Series*, vol. 121, no. 1-3, pp. 91-98, 1995.
106. H. Williams, L. D. Coen and M. S. Stoelting, "Seasonal abundance, distribution, and habitat selection of juvenile *Callinectes sapidus* (Rathbun) in the northern Gulf of Mexico.," *Journal of Experimental Marine Biology and Ecology*, vol. 137, pp. 165-183, 1990.
107. R. J. Ortho, "A perspective on plant-animal interactions in seagrasses: physical and biological determinants influencing plant and animal abundance.," in *Plant-Animal Interactions in the Marine Benthos*, vol. Systematic Special Volume No. 46, D. M. John, S. J. Hawkins and J. H. Price, Eds., Clarendon Press, Oxford, 1992, pp. 147-164.
108. E. A. Irlandi and M. K. Crawford, "Habitat linkages: the effect of intertidal saltmarshes and adjacent subtidal habitats on abundance, movement, and growth of an estuarine fish.," *Oecologia*, vol. 110, no. 2, pp. 222-230, 1997.
109. D. Eggleston, D. Armstrong, W. Elis and W. Patton, "Estuarine fronts as conduits for larval transport: hydrodynamics and spatial distribution of megalopae.," *Marine Ecology Progress Series*, vol. 164, pp. 73-82, 1998.
110. K. A. Hovel, "Habitat fragmentation in marine landscapes: relative effects of habitat cover and configuration on juvenile crab survival in California and North Carolina seagrass beds.," *Biological Conservation*, vol. 110, pp. 401-412, 2003.
111. G. M. Ralph and R. N. Lipcius, "Critical habitats and stock assessment: age specific bias in the Chesapeake Bay Blue Crab Population Survey.," *Transactions of the American Fisheries Society*, vol. 143, pp. 889-989, 2014.
112. F. M. Micheli and C. H. Peterson, "Estuarine vegetated habitats as corridors for predator movement.," *Conservation Biology*, vol. 13, no. 4, pp. 869-881, 1999.
113. T. J. Minello, L. P. Rozas and R. Baker, "Geographic variability in salt marsh flooding patterns may affect nursery value for fishery species.," *Estuaries and Coasts*, vol. 35, pp. 501-514, 2011.
114. S. P. Epperly and S. W. Ross, "Characterization of the North Carolina Pamlico-Albemarle Estuarine Complex. NMFS-SEFC-175," National Marine Fisheries Service, Southeast Fisheries Center, Beaufort, NC, 1986.
115. T. E. Dahl, "Wetlands losses in the United States, 1780's to 1980's. Report to the Congress.," PB-91-169284/XAB, Washington, DC, 1990.
116. G. F. Meyer, "Effects of land use change on juvenile fishes, blue crab, and brown shrimp abundance in the estuarine nursery habitats in North Carolina," East Carolina University, Greenville, NC, 2011.
117. S. B. Scyphers, J. S. Picou and S. P. Powers, "Participatory conservation of coastal habitats: the importance of understanding homeowners decision making to mitigate cascading shoreline degradation.," *Conservation Letters*, vol. 8, no. 1, pp. 41-49, 2015.
118. W. C. Long, J. N. Grow, J. E. Majoris and A. H. Hines, "Effects of anthropogenic shoreline hardening and invasion by *Phragmites australis* on habitat quality for juvenile blue crabs (*Callinectes sapidus*).," *Journal of Experimental Marine Biology and Ecology*, vol. 46, no. 1, pp. 215-222, 2011.
119. D. B. Eggleston, "Foraging behavior of the blue crab, *Callinectes sapidus*, on juvenile

- oysters, *Crassostrea virginica*: effects of prey density and size.," *Bulletin of Marine Science*, vol. 46, no. 1, pp. 62-82, 1990.
120. R. Mann and J. Harding, "Trophic studies on constructed "restored" oyster reefs.," Virginia Institute of Marine Science, Gloucester Point, VA, 1997.
 121. L. E. Coen, M. W. Luckenbach and D. L. Breitburg, "The rold of oyster reefs as essential fish habitat: a review of current knowledge and some new perspectives.," in *Fish habitat: Essential fish habitat and rehabilitation*, L. R. Benaka, Ed., Bethesda MD, American Fisheries Society, 1999, pp. 438-454.
 122. ASMFC, "The importance of habitat created by molluscan shellfish to manage species along the Atlantic coast of the United States.," ASMFC, Washington, DC, 2007.
 123. Lowery and K. T. Paynter, "The importance of molluscan shell substrate," National Marine Fisheries Service, Silver Spring, MD, Unpublished report.
 124. Colden, K. A. Fall, G. M. Massey and C. Friedrichs, "Sediment suspension and deposition across restored oyster reefs of varying orientation to flow: implications for restoration," *Estuaries and Coasts*, vol. 39, no. 5, pp. 1435-1448, 2016.
 125. H. H. Seliger, J. A. Boggs and W. H. Biggley, "Catastrophic anoxia in the Chesapeake Bay in 1984.," *Science*, vol. 228, pp. 70-73, 1985.
 126. H. Grabowski, D. Pettipas, M. Dolan, A. Hughes and D. Kimbro, "The economic and biological value of restored oyster reef habitat to the nursery function of the estuary.," NC Sea Grant, Raleigh, NC, 2000.
 127. M. B. Ogburn and L. C. Habegger, "Reproductive status of *Callinectes sapidus* as an indicator of spawning habitat in the South Atlantic Bight, USA.," *Estuaries and Coasts*, vol. 38, pp. 2059-2069, 2015.
 128. S. Ramach, M. Z. Darnell, N. Avissar and D. Rittschof, "Habitat use and population dynamics of blue crabs, *Callinectes sapidus* in a high-salinity embayment.," *Journal of Shellfish Research*, vol. 28, no. 3, pp. 635-640, 2009.
 129. D. B. Eggleston, E. G. Johnson and J. E. Hightower, "Population dynamics and stock assessment of the blue crab in North Carolina.," NC Sea Grant, Raleigh, NC, 2004.
 130. C. C. Burgess, A. J. Bianchi, J. Murauskas and S. Crosson, "Impacts of hurricanes on North Carolina fisheries," Division of Marine Fisheries, Morehead City, NC, 2007.
 131. IPCC, "Climate Change 2014: Synthesis report," IPCC, Geneva, Switzerland, 2014.
 132. M. Melillo, T. C. Richmond and G. W. Yohe, "Climate change impacts in the United States: The third national climate assessment," Washington, DC, 2014.
 133. W. J. Sweet, J. Park, J. Marra, C. Zervas and S. Gill, "Sea level rise and nuisance flood frequency changes around the United States.," NOAA, Silver Springs, MD, 2014.
 134. R. A. Feely, J. A. Klinger, J. A. Newton and M. Chadsey, "Scientific summary of ocean acidification in Washington State marine waters.," 2012.
 135. J. I. Butler, J. M. Tiggelaar, J. D. Shields and M. J. V. Butler, "Effects of the parasitic dinoflagellate *Hematodinium perezii* on blue crab (*Callinectes sapidus*) behavior and predation.," *Journal of Experimental Marine Biology and Ecology*, vol. 461, pp. 381-388, 2014.
 136. H. A. Rogers, S. S. Taylor, J. P. Hawke and J. A. Anderson Lively, "Variations in prevalence of viral, bacterial, and rhizocephalan diseases and parasites of the blue crab (*Callinectes sapidus*).," *Journal of Invertebrate Pathology*, vol. 127, pp. 54-62, 2015.
 137. S. McKenna, M. Jansen and M. G. Pulley, "Shell disease of blue crabs, *Callinectes sapidus*, in the Pamlico River, North Carolina.," Division of Marine Fisheries, Spec Sci

- Rep Number 51, 1990.
138. E. J. Noga, D. W. Engel and T. W. Arroll, "Shell disease in blue crabs, *Callinectes sapidus*, from the Albemarle-Pamlico Estuary," APES Rep. 90-22, 1990.
 139. J. E. Weinstein, T. L. West and J. T. Bray, "Shell disease and metal content of blue crabs, *Callinectes sapidus*, from the Albemarle-Pamlico estuarine system, North Carolina.," Archives of Environmental Contamination and Toxicology, vol. 23, pp. 355-362, 1992.
 140. R. Mahood, M. McKenzie, D. Middaugh, S. Bollan, J. Davis and D. Spitsbergen, "A report on the cooperative blue crab study - South Atlantic states.," Coastal Fisheries Contribution Series Number 19, Brunswick, GA, 1970.
 141. C. J. Sindermann, "The shell disease syndrome in marine crustaceans," U.S. Department of Commerce (eds), NOAA, Woods Hole, MA, 1989.
 142. J. T. Carlton, "Introduced species in U.S. coastal waters: Environmental impacts and management priorities.," Pew Oceans Commission, Arlington, VA, 2001.
 143. Sea Grant, "Aquatic Nuisance Species Report: An update on Sea Grant research and outreach projects 2000," The Ohio State University, Columbus, OH, 2000.
 144. D. J. Orth, Y. Jiao, J. D. Schmitt, C. D. Hilling, J. A. Emmel and M. C. Fabrizio, "Dynamics and role of non-native blue catfish *Ictalurus furcatus* in Virginia's tidal rivers final report.," Virginia Department of Game and Inland Fisheries, 2017.
 145. J. Hill, O. N. Caretti and K. L. Heck Jr., "Recently established Asian tiger shrimp *Penaeus monodon* Fabricius, 1798 consume juvenile blue crabs *Callinectes sapidus* Rathbun, 1896 and polychaetes in a laboratory diet-choice experiment.," BioInvasions Records, vol. 6, no. 3, pp. 233-238, 2017.
 146. K. A. O'Shaughnessy, D. W. Freshwater and E. J. Burge, "Prevalence of the invasive Rhizocephalan parasite *Loxothylacus panopaei* in *Eurypanopeus depressus* in South Carolina and genetic relationships of the parasite in North and South Carolina.," Journal of Parasitology, vol. 100, no. 4, pp. 447-454, 2014.
 147. S. M. Bower, S. E. McGladdery and I. M. Price, "Synopsis of infectious diseases and parasites of commercially exploited shellfish," Annual Review of Fish Diseases, vol. 4, pp. 1-199, 1994.
 148. W. J. Wardle and A. J. Tirpak, "Occurrence and distribution of an outbreak of infection of *Loxothylacus texanus* (Rhizocephala) in blue crabs in Galveston Bay, Texas, with special reference to size and coloration of the parasite's external reproductive structures.," Journal of Crustacean Biology, vol. 11, pp. 533-560, 1991.
 149. NCDWR, "Economic & environmental impacts on N.C. aquatic weed infestations.," April 1996, 1996.
 150. B. Rybicki and J. M. Landwehr, "Long-term changes in abundance and diversity of macrophyte and waterfowl populations in an estuary with exotic macrophytes and improving water quality.," Limnology Oceanography, vol. 52, no. 3, pp. 1195-1207, 2007.
 151. Wood, "Juvenile blue crab (*Callinectes sapidus*) response to altered nursery habitat.," Gloucester Point, VA, 2017.
 152. NCDEQ, Aquatic Nuisance Species Management Plan, Raleigh, NC, 2015.
 153. T. Thorpe, D. Beresoff and K. Cannady, "Gillnet bycatch potential, discard mortality, and condition of red drum (*Sciaenops ocellatus*) in Southeastern North Carolina.," North Carolina Sea Grant, Raleigh, NC, 2001.
 154. G. Montgomery, "Catch Composition of three gill net designs in the N.C. flounder gill

- net fishery.," North Carolina Sea Grant, Raleigh, NC, 2002.
155. T. Thorpe and D. Beresoff, "Effects of gillnet tie-downs on fish and bycatch rates associated with American shad (*Alosa sapidissima*) and flounder (*Paralichthys* spp.) fisheries in southeastern North Carolina.," North Carolina Sea Grant, Raleigh, NC, 2005.
 156. J. Kimel, S. Corbett and T. Thorpe, "Selectivity of large mesh gillnets in the southern flounder (*Paralichthys lethostigma*) fishery.," North Carolina Sea Grant, Raleigh, NC, 2008.
 157. J. Hassell, "Effects of various mesh sizes on flounder gill net bycatch in the Pamlico River," North Carolina Sea Grant, Raleigh, NC, 2009.
 158. J. Ruderhausen and D. A. Doughtie, "Bycatch-reducing rectangular gillnet webbing tested in the Neuse River, North Carolina southern flounder fishery.," North Carolina Sea Grant, Raleigh, NC, 2010.
 159. K. Brown, "Characterization of the commercial shrimp fishery in the estuarine and ocean (0-3 miles) waters of North Carolina," Atlantic Coastal Fisheries Cooperative Management Act, NA13NMF4740243, 2017.
 160. K. Brown, "Pilot study: characterization of bycatch and discards, including protected species interactions, in the commercial skimmer trawl fishery in North Carolina.," Atlantic Coastal Cooperative Statistics Program grant, NA14NMF47400363 and NA13NMF4740243, 2016.

APPENDICES

APPENDIX 1. GLOSSARY OF BIOLOGICAL TERMS

Abundance Index

A relative measure of the weight or number of fish in a stock, a segment of the stock (e.g. the spawners), or an area. Often available in time series, the information is collected through scientific surveys or inferred from fishery data.

Age

The number of years of life completed, here indicated by an Arabic numeral, followed by a plus sign if there is any possibility of ambiguity (age 1, age 1+).

Assessment

A judgment made by a scientist or scientific body on the state of a resource, such as a fish stock (e.g. size of the stock, potential yield, on whether it is over- or underexploited), usually for the purpose of passing advice to a management authority.

Barrier Island

A sedimentary island, generally elongate and low, that is built by longshore transport or wave action parallel to the coast.

Benthic

1. Defining a habitat or organism found on the sea bottom¹⁰;
2. Of or pertaining to the seafloor (or bottom) of a water body.

Bloom

A sudden increase in the abundance of alga or phytoplankton resulting in a contiguous mass of highly concentrated phytoplankton in the water column.

Buffer Zone

The area that separates the core from areas in which human activities that threaten it occur.

Bycatch

Fish other than the primary target species that are caught incidental to the harvest of the primary species. Bycatch may be retained or discarded. Discards may occur for regulatory or economic reasons.

Bycatch Reduction Device (Excluder)

A device inserted in a fishing gear (usually trawl nets, close to the codend) to allow escapement, alive, of unwanted (non-target and prohibited) species (e.g. jellyfish), smaller fish (juveniles), and threatened or endangered species (e.g. sea turtles, marine mammals).

Catchability

In general, the extent to which a stock is susceptible to fishing.

Carapace

The hard upper shell of a turtle, crustacean, or arachnid.

Catch Per Unit (of) Effort (CPUE)

The quantity of fish caught (in number or in weight) with one standard unit of fishing effort; e.g. number of fish taken per 1,000 hooks per day or weight of fish, in tons, taken per hour of trawling. CPUE is often considered an index of fish biomass (or abundance). Sometimes referred to as catch rate. CPUE may be used as a measure of economic efficiency of fishing as well as an index of fish abundance. Also called: catch per effort, fishing success, availability.

Cohort

1. In a stock, a group of fish generated during the same spawning season and born during the same time period;
2. In cold and temperate areas, where fish are long-lived, a cohort corresponds usually to fish born during the same year (a year class). For instance, the 1987 cohort would refer to fish that are age 0 in 1987, age 1 in 1988, and so on. In the tropics, where fish tend to be short lived, cohorts may refer to shorter time intervals (e.g. spring cohort, autumn cohort, monthly cohorts).

Commercial Fishery

A term related to the whole process of catching and marketing fish and shellfish for sale. It refers to and includes fisheries resources, fishermen, and related businesses.

Crustaceans

A group of freshwater and saltwater invertebrates with jointed legs and a hard shell of chitin. Includes shrimps, crabs, lobsters, and crayfish.

Current

A horizontal movement of water.

Decline

A decline is a reduction in the number of individuals, or a decrease of the area of distribution, the causes of which are either not known or not adequately controlled. It need not necessarily still be continuing. Natural fluctuations will not normally count as part of a decline, but an observed decline should not be considered part of a natural fluctuation unless there is evidence for this. A decline that is the result of harvesting that reduces the population to a planned level, not detrimental to the survival of the species, is not covered by the term.

Density-Dependence

The dependence of a factor influencing population dynamics (such as survival rate or reproductive success) on population density. The effect is usually in the direction that contributes to the regulative capacity of a stock.

Detritus

Dead organic matter and the decomposers that live on it; when broken up by decomposers, detritus provides energy to many coastal ecosystems.

Discard

To release or return fish to the sea, dead or alive, whether or not such fish are brought fully on board a fishing vessel.

Ecosystem

A geographically specified system of organisms, the environment, and the processes that control its dynamics. Humans are an integral part of an ecosystem.

Effort

The amount of time and fishing power used to harvest fish; includes gear size, boat size, and horsepower.

Epifauna

Benthic fauna living on the substrate but not burrowing into it (as on a hard seafloor) or living on other organisms.

Escapement

The number or proportion of fish surviving (escaping from) a given fishery at the end of the fishing season and reaching the spawning grounds. The term is generally used for salmon management.

Essential Fish Habitat (EFH)

Congress defined EFH as “those waters and substrate necessary to fish for spawning, breeding, feeding, or growth to maturity” (16 U.S.C. 1802(10)). The EFH guidelines under 50 CFR 600.10 further interpret the EFH definition as follows: Waters include aquatic areas and their associated physical, chemical, and biological properties that are used by fish and may include aquatic areas historically used by fish where appropriate; substrate includes sediment, hard bottom, structures underlying the waters, and associated biological communities; necessary means the habitat required to support a sustainable fishery and the managed species’ contribution to a healthy ecosystem; and “spawning, breeding, feeding, or growth to maturity” covers a species’ full life cycle.

Estimated Discard Mortality

Estimates of discards can be made in a variety of ways, including samples from observers and logbook records.

Estuarine

1. Relating to or formed in an estuary (e.g. estuarine currents; estuarine animals);
2. Belonging to an estuary (river mouth), an area in which sea water is appreciably diluted by fresh water from rivers.

Estuary

A coastal ecological ecosystem that is partially enclosed, receives freshwater input from land, and has a horizontal fresh-salt salinity gradient; the average salinity of estuarine waters is defined as being 30 practical salinity units (PSU) for at least 1 month per year.

Exclusive Economic Zone (EEZ)

The EEZ is the area that extends from the seaward boundaries of the coastal states (3 nautical miles (n.mi.) in most cases, the exceptions are Texas, Puerto Rico and the Gulf coast of Florida at 9 n.mi.) to 200 n.mi. off the U.S. coast. Within this area the United States claims and exercises sovereign rights and exclusive fishery management authority over all fish and all continental shelf fishery resources.

Exoskeleton

A rigid external covering for the body in some invertebrate animals, especially arthropods, providing both support and protection.

Ex-Vessel

Refers to activities that occur when a commercial fishing boat lands or unloads a catch. For example, the price received by a captain (at the point of landing) for the catch is an ex-vessel price.

Fecundity

The potential reproductive capacity of an organism or population expressed in the number of eggs (or offspring) produced during each reproductive cycle. Fecundity usually increases with age and size. The information is used to compute spawning potential.

Finfish

Vertebrate and cartilaginous fishery species, not including crustaceans, cephalopods, or other mollusks.

Fish

Used as a collective term, includes mollusks, crustaceans and any aquatic animal which is harvested.

Fish Stock

The living resources in the community or population from which catches are taken in a fishery. Use of the term fish stock usually implies that the particular population is more or less isolated from other stocks of the same species and hence self-sustaining. In a particular fishery, the fish stock may be one or several species of fish but here is also intended to include commercial invertebrates and plants.

Fisheries Management

The integrated process of information gathering, analysis, planning, decision making, allocation of resources, and formulation and enforcement of fishery regulations by which the fisheries management authority controls the present and future behaviors of the interested parties in the fishery in order to ensure the continued productivity of the living resources.

Fishery

1. Generally, a fishery is an activity leading to harvesting of fish. It may involve capture of wild fish or raising of fish through aquaculture;

2. A unit determined by an authority or other entity that is engaged in raising or harvesting fish. Typically, the unit is defined in terms of some or all of the following: people involved, species or type of fish, area of water or seabed, method of fishing, class of boats, and purpose of the activities;
3. The combination of fish and fishers in a region, the latter fishing for similar or the same species with similar or the same gear types.

Fishery-Dependent

Data collected directly on a fish or fishery from commercial or sport fishermen and seafood dealers. Common methods include logbooks, trip tickets, port sampling, fishery observers, and phone surveys.

Fishery-Independent

Characteristic of information (e.g. stock abundance index) or an activity (e.g. research vessel survey) obtained or undertaken independently of the activity of the fishing sector. Intended to avoid the biases inherent to fishery-related data.

Fishery Management Plan (FMP)

1. A document prepared under supervision of the appropriate fishery management council for management of stocks of fish judged to be in need of management. The plan must generally be formally approved. An FMP includes data, analyses, and management measures;
2. A plan containing conservation and management measures for fishery resources, and other provisions required by the Magnuson-Stevens Act, developed by fishery management councils or the Secretary of Commerce.

Fishery Management Unit

A fishery or a portion of a fishery identified in a fishery management plan (FMP) relevant to the FMP's management objectives. The choice of stocks or species in an FMU depends upon the focus of FMP objectives, and may be organized around biological, geographic, economic, technical, social, or ecological perspectives.

Fishery Models

Simplified representations of the fisheries complex reality. May or may not be a mathematical representation.

Fishing

Any activity, other than scientific research conducted by a scientific research vessel, that involves the catching, taking, or harvesting of fish; or any attempt to do so; or any activity that can reasonably be expected to result in the catching, taking, or harvesting of fish and any operations at sea in support of it.

Fishing Effort

The amount of fishing gear of a specific type used on the fishing grounds over a given unit of time (e.g. hours trawled per day, number of hooks set per day, or number of hauls of a beach seine per day). When two or more kinds of gear are used, the respective efforts must be adjusted to some standard type before being added. Sometimes referred to as effective fishing effort.

Fishing Gear

The equipment used for fishing (e.g. gill net, hand line, harpoon, haul seine, long line, bottom and midwater trawls, purse seine, rod-and-reel, pots and traps). Each of these gears can have multiple configurations.

Fishing Mortality (F)

1. F stands for the fishing mortality rate in a particular stock. It is roughly the proportion of the fishable stock that is caught in a year;
2. A measurement of the rate of removal from a population by fishing. Fishing mortality can be reported as either annual or instantaneous. Annual mortality is the percentage of fish dying in one year. Instantaneous mortality is that percentage of fish dying at any one time.

Food Chain

The transfer of energy from the source in plants through a series of organisms with repeated eating and being eaten. At each transfer, a large proportion of the potential energy is lost as heat. The shorter the food chain (or the nearest the organism is from the beginning of the food chain), the greater the available energy which can be converted in biomass.

Forage Species

Species used as prey by a larger predator for its food. Includes small schooling fishes such as anchovies, sardines, herrings, capelin, smelts, and menhaden, and invertebrates such as squid.

Gear

A fishing gear is a tool used to catch fish, such as hook-and-line, trawl net, gill net, pot, trap, spear, etc.

Gear Restriction

1. A type of input control used as a management tool whereby the amount and/or type of fishing gear used by fishers in a particular fishery is restricted by law;
2. Limits placed on the type, amount, number, or techniques allowed for a given type of fishing gear.

Growth

Usually an individual fish's increase in length or weight with time. Also may refer to the increase in numbers of fish in a population with time.

Habitat

1. The environment in which the fish live, including everything that surrounds and affects its life, e.g. water quality, bottom, vegetation, associated species (including food supplies);
2. The locality, site and particular type of local environment occupied by an organism.

Harvest

The total number or weight of fish caught and kept from an area over a period of time. Note that landings, catch, and harvest are different.

Health

The condition of the marine environment from the perspective of adverse effects caused by anthropogenic (human) activities, in particular habitat destruction, changed sedimentation rates and the mobilization of contaminants. Such condition refers to the contemporary state of the ocean, prevailing trends, and the prognosis for improvement or deterioration of its quality.

Incidental Take

The “take” of protected species (such as listed salmon, marine mammals, sea turtles, or sea birds) during fishing. “Take” is defined as to harass, harm, pursue, hunt, shoot, wound, kill, trap, capture or collect, or to attempt to engage in any such conduct.

Indicators

1. A variable, pointer, or index. Its fluctuation reveals the variations in key elements of a system. The position and trend of the indicator in relation to reference points or values indicate the present state and dynamics of the system. Indicators provide a bridge between objectives and action;
2. Signals of processes, inputs, outputs, effects, results, outcomes, impacts, etc., that enable such phenomena to be judged or measured. Both qualitative and quantitative indicators are needed for management learning, policy review, monitoring, and evaluation;
3. In biology, an organism, species, or community whose characteristics show the presence of specific environmental conditions, good or bad.

Invasive species

An introduced species that out-competes native species for space and resources.

Invertebrate

Animals without a backbone. In fishery management terms, refers to shellfish, including lobsters, clams, shrimps, oysters, crabs, and sea urchins.

Juvenile

A young fish or animal that has not reached sexual Maturity.

Landings

1. The number or poundage of fish unloaded by commercial fishermen or brought to shore by recreational fishermen for personal use. Landings are reported at the locations at which fish are brought to shore²;
2. The part of the catch that is selected and kept during the sorting procedures on board vessels and successively discharged at dockside.

Landings Data

Information on the amount of fish caught and landed per Year.

Life Cycle

Successive series of changes through which an organism passes in the course of its development.

Lipofuscin

Brown-yellow pigmented granules that accumulate with age in certain tissues.

Management Authority

The legal entity that has been assigned by a state or states with a mandate to perform certain specified management functions in relation to a fishery, or an area (e.g. a coastal zone). Generally used to refer to a state authority, the term may also refer to an international management organization.

Management Strategy

The strategy adopted by the management authority to reach established management goals. In addition to the objectives, it includes choices regarding all or some of the following: access rights and allocation of resources to stakeholders, controls on inputs (e.g. fishing capacity, gear regulations), outputs (e.g. quotas, minimum size at landing), and fishing operations (e.g. calendar, closed areas, and seasons).

Marine

Waters that receive no freshwater input from the land and are substantially of full oceanic salinity (>30 practical salinity units (PSU) throughout the year).

Mature Individuals

The number of individuals known, estimated, or inferred to be capable of reproduction.

Maturity

Refers to the ability, on average, of fish of a given age or size to reproduce. Maturity information, in the form of percent mature by age or size, is often used to compute spawning potential.

Megalopae

The final larval stage found in decapod crustaceans.

Mesh Size

The size of holes in a fishing net. Minimum mesh sizes are often prescribed by regulations in order to avoid the capture of the young of valuable species before they have reached their optimal size for capture.

Migration

1. Systematic (as opposed to random) movement of individuals of a stock from one place to another, often related to season. A knowledge of the migration patterns helps in targeting high concentrations of fish and managing shared stocks;
2. The movements of fish from feeding ground to spawning ground and back again, from nursery ground to feeding ground, and from spawning ground to nursery ground.

Model

In fisheries science, a description of something that cannot be observed. Often a set of equations and data used to make estimates.

Monitoring

1. To observe and record changes;
2. The collection of information for the purpose of assessment of the progress and success of a plan. Monitoring is used for the purpose of assessing performance of a management plan or compliance scheme and revising them, or to gather experience for future plans.

Mortality

Measures the rate of death of fish. Mortality occurs at all life stages of the population and tends to decrease with age. Death can be due to several factors such as pollution, starvation, and disease but the main source of death is predation (in unexploited stocks) and fishing (in exploited ones).

Mortality Rate

The rate at which the numbers in a population decrease with time due to various causes. Mortality rates are critical parameters in determining the effects of harvesting strategies on stocks, yields, revenues, etc. The proportion of the total stock (in numbers) dying each year is called the “annual mortality rate.”

Native Species

A local species that has not been introduced.

Nearshore

Shallow waters at a small distance from the shore.

Non-Point Sources

Sources of sediment, nutrients, or contaminants that originate from many locations.

Nursery

That part of a fish's or animal's habitat where the young develop and grow.

Objective

Expresses the object of an action or what is intended to be achieved. Any objective will include explicit statements against which progress can be measured, and identify which things are truly important and the way they interrelate; quantified objectives are referred to as targets.

Overfished

1. An overfished stock or stock complex “whose size is sufficiently small that a change in management practices is required to achieve an appropriate level and rate of rebuilding.” A stock or stock complex is considered overfished when its population size falls below the minimum stock size threshold (MSST). A rebuilding plan is required for stocks that are deemed overfished
2. A stock is considered “overfished” when exploited beyond an explicit limit beyond which its abundance is considered ‘too low’ to ensure safe reproduction. In many fisheries for the term is used when biomass has been estimated to be below a limit biological reference point that is used as the signpost defining an “overfished condition.” This signpost is often taken as being FMSY, but the usage of the term may not always be consistent

Overfishing

1. According to the National Standard Guidelines, “overfishing occurs whenever a stock or stock complex is subjected to a rate or level of fishing mortality that jeopardizes the capacity of a stock or stock complex to produce maximum sustainable yield (MSY) on a continuing basis.”

Overfishing is occurring if the maximum fishing mortality threshold (MFMT) is exceeded for 1 year or more;

2. In general, the action of exerting fishing pressure (fishing intensity) beyond the agreed optimum level. A reduction of fishing pressure would, in the medium term, lead to an increase in the total catch.

Parameter

A “constant” or numerical description of some property of a population (which may be real or imaginary).

Peeler

A hard shell crab in pre-molt stages.

Plankton

Floating organisms whose movements are more or less dependent on currents. While some zooplankton exhibit active swimming movements that aid in maintaining vertical position, plankton as a whole are unable to move against appreciable currents.

Pollution

1. The introduction by man, directly or indirectly, of substances or energy into the marine environment, including estuaries, which results or is likely to result in such deleterious effects as harm to living resources and marine life; hazards to human health; hindrance to marine activities, including fishing and other legitimate uses of the sea; impairment of quality of sea water; and reduction of amenities;

2. Presence of substances and heat in environmental media (air, water, land) whose nature, location, or quantity produces undesirable environmental effects;

3. Activity that generates pollutants.

Population

The number of individuals of a particular species that live within a defined area.

Pots

Traps, designed to catch fish or crustaceans, in the form of cages or baskets of various materials (wood, wicker, metal rods, wire netting, etc.) and having one or more openings or entrances. Usually set on the bottom, with or without bait, singly or in rows, connected by ropes (buoy-lines) to buoys on the surface showing their position.

Predation

Relationship between two species of animals in which one (the predator) actively hunts and lives off the meat and other body parts of the other (the prey).

Primary Production

Assimilation (gross) or accumulation (net) of energy and nutrients by green plants and by organisms that use inorganic compounds as food.

Processing

The preparation or packaging of fish to render it suitable for human consumption, retail sale, industrial uses, or long-term storage, including but not limited to cooking, canning, smoking, salting, drying, filleting, freezing, or rendering into meal or oil, but not heading and gutting unless additional preparation is done.

Production

1. The total output especially of a commodity or an industry;
2. The total living matter (biomass) produced by a stock through growth and recruitment in a given unit of time (e.g. daily, annual production). The “net production” is the net amount of living matter added to the stock during the time period, after deduction of biomass losses through mortality;
3. The total elaboration of new body substance in a stock in a unit of time, irrespective of whether or not it survives to the end of that time.

Recruit

1. A young fish entering the exploitable stage of its life cycle;
2. A member of “the youngest age group which is considered to belong to the exploitable stock.”

Recruitment (R)

1. The amount of fish added to the exploitable stock each year due to growth and/or migration into the fishing area. For example, the number of fish that grow to become vulnerable to the fishing gear in one year would be the recruitment to the fishable population that year;
2. This term is also used in referring to the number of fish from a year class reaching a certain age. For example, all fish reaching their second year would be age 2 recruits.

Relative Abundance

Relative abundance is an estimate of actual or absolute abundance; usually stated as some kind of index; for example, as bottom trawl survey stratified mean catch per tow.

Removals

All of the fish “removed” from a stock by fishing, including the catch and any fish killed but not caught.

Resources

1. A natural source of wealth and revenue. Biological resources include genetic resources, organisms or parts thereof, populations, or any other biotic component of ecosystems with actual or potential use of value for humanity. Fishery resources are those resources of value to fisheries;
2. Anything that has value; living and nonliving components of nature such as fish, oil, water, and air.

Rulemaking

The process of developing Federal regulations which occurs in several steps, including publishing proposed rules in the Federal Register, accepting comments on the proposed rule, and publishing the final rule. An “advanced notice of proposed rulemaking” is published when dealing with especially important or controversial rules.

Salinity

The total mass of salts dissolved in seawater per unit mass of water; generally expressed in parts per thousands (ppt).

Sample

A proportion or a segment of a fish stock that is removed for study, and is assumed to be representative of the whole. The greater the effort, in terms of both numbers and magnitude of the samples, the greater the confidence that the information obtained is a true reflection of the status of a stock (level of abundance in terms of numbers or weight, age composition, etc.).

Seagrass

Rooted, grass-like flowering plants, such as eelgrass, that are adapted to live at sea, submersed, and can tolerate a saline environment.

Secondary Dispersal

A mechanism driving movement following initial settlement to benthic habitats often triggered by environmental or biological factors.

Shellfish

Shellfish include both mollusks, such as clams, and crustaceans, such as lobsters.

Spawning

Release of ova, fertilized or to be fertilized.

Spawning Stock

1. Mature part of a stock responsible for reproduction;
2. Strictly speaking, the part of an overall stock having reached sexual maturity and able to spawn. Often conventionally defined as the number or biomass of all individuals beyond “age at first maturity” or “size at first maturity”; that is, beyond the age or size class in which 50 percent of the individuals are mature.

Species

Group of animals or plants having common characteristics, able to breed together to produce fertile (capable of reproducing) offspring, and maintaining their “separateness” from other groups.

Stakeholder

1. A large group of individuals and groups of individuals (including governmental and non-governmental institutions, traditional communities, universities, research institutions, development agencies and banks, donors, etc.) with an interest or claim (whether stated or implied) that has the potential of being impacted by or having an impact on a given project and its objectives. Stakeholder groups that have a direct or indirect “stake” can be at the household, community, local, regional, national, or international level;
2. An actor having a stake or interest in a physical resource, ecosystem service, institution, or social system, or someone who is or may be affected by a public policy.

Stock

A part of a fish population usually with a particular migration pattern, specific spawning grounds, and subject to a distinct fishery. A fish stock may be treated as a total or a spawning stock. Total stock refers to both juveniles and adults, either in numbers or by weight, while spawning stock refers to the numbers or weight of individuals that are old enough to reproduce.

Stock Assessment

The process of collecting and analyzing biological and statistical information to determine the changes in the abundance of fishery stocks in response to fishing, and, to the extent possible, to predict future trends of stock abundance. Stock assessments are based on resource surveys; knowledge of the habitat requirements, life history, and behavior of the species; the use of environmental indices to determine impacts on stocks; and catch statistics. Stock assessments are used as a basis to assess and specify the present and probable future condition of a fishery.

Subtidal

Permanently below the level of low tide, an underwater environment.

Sustainability

1. Ability to persist in the long-term. Often used as “short hand” for sustainable development;
2. Characteristic of resources that are managed so that the natural capital stock is non-declining through time, while production opportunities are maintained for the future.

Thresholds

1. Levels of environmental indicators beyond which a system undergoes significant changes; points at which stimuli provoke significant response;
2. A point or level at which new properties emerge in an ecological, economic, or other system, invalidating predictions based on mathematical relationships that apply at lower levels. For example, species diversity of a landscape may decline steadily with increasing habitat degradation to a certain point, and then fall sharply after a critical threshold of degradation is reached. Human behavior, especially at group levels, sometimes exhibits threshold effects. Thresholds at which irreversible changes occur are especially of concern to decision-makers.

Tidal Marsh

Low, flat marshland traversed by channels and tidal hollows and subject to tidal inundation. Normally, the only vegetation present are salt-tolerant bushes and grasses.

Total Catch

Total catch (optimum yield, OY). The landed catch plus discard mortality.

Trawl Net

Towed net consisting of a cone-shaped body closed by a bag or codend and extended at the opening by wings. It can be towed by one or two boats and, according to the type, used on the bottom or in midwater (pelagic). In certain cases, as in trawling for shrimp or flatfish, the trawler can be specially rigged with outriggers to tow up to four trawls at the same time (double rigging)

Trawling

Fishing technique in which a net is dragged behind the vessel and retrieved when full of fish. This technique is used extensively in the harvest of pollock, cod, and other flatfish in North Pacific and New England fisheries. It includes bottom and midwater fishing activities.

Trotline

A heavy fishing line with baited hooks attached at intervals by means of branch lines.

Turbidity

The condition resulting from the presence of suspended particles in the water column which attenuate or reduce light penetration.

Undersized

Fish (caught) at a size smaller than the minimum size limit established by regulation.

Value

1. Market and nonmarket values, gross and net values, and net benefits to consumers or goods and services;
2. The contribution of an action or object to user-specified goals, objectives, or conditions.

Water Column

The vertical column of seawater that extends from the surface to the bottom.

Water Quality

The chemical, physical, and biological characteristics of water in respect to its suitability for a particular purpose.

Water Resources

Water usable as inputs for economic production and livelihoods. A distinction is made between renewable and nonrenewable water resources. Nonrenewable water resources are not replenished at all or for a very long time by nature. This includes the so-called fossil waters. Renewable water resources are rechargeable due to the hydrological cycle unless they are overexploited, comprising groundwater aquifers and surface water like rivers and lakes.

APPENDIX 2. TABLE OF AMENDMENTS TO STATE PLAN

Amendments, revisions, information updates, and supplements to the Blue Crab FMP

Original FMP Adoption:	December 1998
Amendments:	Amendment 1 – December 2004 Amendment 2 – November 2013
Revisions:	May 2016
Supplements:	None
Information Updates:	None

APPENDIX 3. EXISTING PLANS, STATUTES, AND RULES

Existing Plans, Statutes, and Rules. This summary does not maintain exact language and should not be relied upon for legal purposes. See [North Carolina General Statutes](#), [North Carolina Administrative Code](#) and [Proclamations](#) for exact language. The commission has the authority to delegate to the fisheries director the ability to issue public notices, called proclamations, suspending or implementing particular commission rules that may be affected by variable conditions. The proclamation authority granted to the fisheries director includes the ability to open and close seasons and fishing areas, set harvest and gear limits, and establish conditions governing various fishing activities. Proclamations are not included in this document because they change frequently.

Major General Statutes that apply to the blue crab fishery include but are not limited to:

- G.S.113-129. Definitions relating to resources.
 - Definitions in statute include fishing access areas, coastal fisheries, coastal fishing waters, crustaceans, fisheries resources, joint fishing waters, overfished, and overfishing.
- G.S.113-130. Definitions relating to activities of public.
 - Definitions in statute include resident, to buy, to fish, to sell, to take, and vessel.
- G.S.113-132. Jurisdiction of fisheries agencies.
 - Marine Fisheries Commission has jurisdiction over the conservation of marine and estuarine resources.
- G.S. 113-268 Injuring, destroying, stealing, or stealing from nets, seines, buoys, pots, etc.
 - It is unlawful without authority of the owner to take fish from fishing gear; willfully, wantonly, and unnecessarily destroy gear; and willfully steal, destroy, or injure fishing gear.

Major rules that apply to the blue crab fishery include but are not limited to:

- 15A NCAC 03I .0101 DEFINITIONS
 - Definitions in rule of what constitutes a blue crab shedding process and operation, peeler crab, and commercial fishing equipment or gear.
- 15A NCAC 03I .0105 LEAVING DEVICES UNATTENDED
 - It is unlawful to leave pots in coastal fishing waters for more than five consecutive days.
- 15A NCAC 03J .0104 TRAWL NETS
 - Proclamation authority is granted to the Fisheries Director to open areas described in 15A NCAC 03R .0106 to peeler crab trawling, defines mesh sizes for crab trawls, defines when it is permissible to take and possess blue crabs incidental to shrimp trawling, and sets forth limitations of incidental blue crab catch while shrimp trawling.
- 15A NCAC 03J .0301 POTS
 - The statewide pot cleanup period, closure periods, and the time and waterways restricted to pot usage are set in rule. Additionally, this rule sets forth gear identification criteria. The Fisheries Director is granted proclamation authority over escape ring requirements including time, area, means and methods, season, and quantity.

- 15A NCAC 03J .0302 RECREATIONAL USE OF POTS
 - Recreational pots must be marked with a hot pink buoy and identifying information. Licensing requirements for recreational pots are included in this rule.
- 15A NCAC 03J .0303 DREDGES AND MECHANICAL METHODS PROHIBITED
 - The maximum weight of dredges, number of dredges, and time of day dredging and mechanical methods are allowed is set in rule.15A NCAC 03L .0201 CRAB HARVEST RESTRICTIONS
 - Cull tolerances, hard crab size limits, and peeler stage allowance are set under rule. The Fisheries Director is given proclamation authority to establish further restrictions upon the harvest of blue crabs.
- 15A NCAC 03L .0202 CRAB TRAWLING
 - By Fisheries Director proclamation areas and times may be specified to take or possess crabs by trawl. Mesh size of trawl gear is set in rule.
- 15A NCAC 03L .0203 CRAB DREDGING
 - The time and areas allowed for crab dredging are set in rule. The Fisheries Director, by proclamation authority, may further restrict the use of dredges to take blue crabs.
- 15A NCAC 03L .0204 CRAB POTS
 - The Fisheries Director, by proclamation authority, may require the use of terrapin excluder devices in crab pots while additionally imposing restrictions which specify areas, time periods, and means and methods.
- 15A NCAC 03L .0201 CRAB SPAWNING SANCTUARIES
 - The time period in which certain gears may not be set or used in crab spawning sanctuaries is set. The Fisheries Director may, by proclamation authority, designate additional areas and impose restrictions based on area, time, means and methods, and harvest limits.
- 15A NCAC 03R .0106 TRAWL NETS PROHIBITED
 - Trawl net prohibited areas referenced in 15A NCAC 03J .0104 are delineated.
- 15A NCAC 03R .0107 DESIGNATED POT AREAS
 - Pot areas referenced in 15A NCAC 03J .0301 are delineated.
- 15A NCAC 03R .0109 TAKING CRABS WITH DREDGES
 - The area referenced in 15A NCAC 03L .0203 is delineated.
- 15A NCAC 03R .0110 CRAB SPAWNING SANCTUARIES
 - The crab spawning sanctuaries within which the taking of crabs may be restricted or prohibited are described.

Major General Statute that apply to habitat protection include but are not limited to:

- G.S. 143B-279.8 Coastal Habitat Protection Plans
 - Lays out the process and purpose of creating the Coastal Habitat Protection Plans.

Major rules that apply to habitat protection include but are not limited to:

- 15A NCAC 03K .0204 Mechanical Methods Prohibited Areas
 - Prohibits the use of mechanical methods in mechanical methods prohibited areas to take oysters

- 15A NCAC 03K .0103 Shellfish Management Areas
 - The Fisheries Director may designate areas which the use of trawl nets, long haul seines, or swipe nets are prohibited.
- 15A NCAC 03N .0101 Fish Habitat Areas Scope and Purpose
 - Fish habitat areas are to establish and protect fragile estuarine and marine areas which support economically important populations.
- 15A NCAC 03N .0104 Prohibited Gear, Primary Nursery Areas
 - Prohibits use of trawl net, long haul seine, swipe net, dredge, or mechanical methods for clam or oysters in primary nursery areas
- 15A NCAC 03N .0105 Prohibited Gear, Secondary Nursery Areas
 - Prohibits use of trawl nets in permanent secondary nursery areas except select areas open by proclamation for shrimp or crab trawling.
- 15A NCAC 03R .0103 Primary Nursery Areas
 - Delineates boundaries of primary nursery areas.
- 15A NCAC 03R .0104 Permanent Secondary Nursery Areas
 - Delineates boundaries of permanent secondary Nursery Areas
- 15A NCAC 03K .0108 Dredges and Mechanical Methods Prohibited
 - Prohibits gears in areas of SAV, salt marsh, shellfish leases, Primary Nursery Areas, and designated Mechanical Methods Prohibited Areas

Table 4.3.1. East coast and Gulf of Mexico blue crab effort regulations by state as of May 2019.

State	Harvest restrictions			
	Season	Catch Limit	Time	Days
New Jersey	Delaware Bay Apr. 6 – Dec 4 Other Waters Mar. 15 – Nov. 30	None	Delaware Bay 4am-9pm Other Waters 24-hrs	None
Delaware	Mar. 1-Nov 30	None	1 hr. before sunrise- sunset	Sunday
Maryland	Males Apr. 1-Nov 16 Mature Female Apr. 1-Nov 10	Mature female	½ hr. before sunrise – 7 ½ hrs. after sunrise	Prohibited either Sun. or Mon.
Virginia	Mar. 17-Nov 30 Mature females prohibited Nov. 21- 30	47 bushels Mar.17-Apr. 30 27 bushels May-Aug.	6am-2pm Mar.17-Apr. 30 5am-1pm May-Aug.	Mon.-Sat. except peeler pots
North Carolina	No pots Jan. 15-Feb. 7 May open areas cleared of pots	None	1 hr. before sunrise- 1hr. after sunset	None
South Carolina	None	None	5am-9pm Apr. 1-Sept 15 6am-7pm Sept 15-Mar.31	None
Georgia	None	None	None	None
Florida	10 day closure for derelict trap removal	None	1 hr. before sunrise- 1hr. after sunset	None
Alabama	Periodic derelict trap removal with no set closure period	None	1 hr. before sunrise- sunset	None
Mississippi	Possible 10-30 day closure for abandoned trap removal	None	½ hr. before sunrise – ½ hr. after sunset	None
Louisiana	Possible 14 day closure for abandoned trap removal	None	½ hr. before sunrise – ½ hr. after sunset	None
Texas	No pots 10-30 days in Feb.-Mar.	None	½ hr. before sunrise – ½ hr. after sunset	None

Table 4.3.2. East coast and Gulf of Mexico blue crab pot gear regulations by state as of May 2019.

State	Pots (max)	Gear restrictions			
		Escape Rings	Degradable Panels	Terrapin Excluders	Buoys
New Jersey	Delaware Bay 600 Other Waters 400	None	Yes	Some areas	Reflective I.D. Sink line
Delaware	200/vessel 500/vessel	None	None	None	I.D. Color coded
Maryland	50 up to 900/vessel w/ 2 crew	1 (2-3/16") 1 (2-5/16") May close for peelers	None	None But limited pot area	I.D.
Virginia	Chesapeake Bay 425 Tributaries and Potomac Tribs. in VA 255 Peeler 210	Seaside Eastern Shore 1 (2-3/16") 1 (2-5/16") Bay & Tribs. 2 (2-3/8")	None	None	I.D.
North Carolina	None Newport River only 150	3 (2-5/16")* May be closed in some areas	None	None	I.D. Sink line
South Carolina	None	2 (2-3/8")	None	None	I.D. With colors
Georgia	200 including peeler pots	2 (2-3/8")*	None	None	I.D. No green
Florida	Inshore 600 Offshore 400 Non-transfer 100 Peeler 400	3 (2-3/8")	Yes	None	I.D. Sink line
Alabama	None	2 (2-5/16") May be closed for peelers	None	None	I.D. ½ white Sink line
Mississippi	None	2 (2-3/8") Can be closed Apr.-Jun. Sept.-Oct.	None	None	I.D. or Color code
Louisiana	None	2 (2-5/16")* Can be closed Apr.-Jun. Sept.-Oct.	None	None	I.D. on metal trap tag/plastic bait cover Sink line
Texas	None	2 (2-3/8")	Yes	None	I.D. White gear tag

*Special placement required

Table 4.3.3. East coast and Gulf of Mexico blue crab life stage regulations by state as of May 2019.

State	Size limits (inches)				Sponge Crab Protection
	Hard	Soft	Peeler	Culling Tolerance	
New Jersey	4.75" 4.5" mature female	3.5"	3"	Zero	Prohibited
Delaware	5"	3.5"	3"	5% by number	Prohibited
Maryland	5" Apr. 1- July 14 5.25" July 15- Dec 15	3.5"	3.25" Apr. 1- July 14 3.5" July 15- Dec 15 Separated from catch	5 hard crabs/ bushel or 13/barrel 10 peelers	Prohibited to take but may sell from another state
Virginia	5"	3.5"	3.25" Mar. 17-Jul. 15 3.5" Jul. 16-Nov. 30	10 hard crabs/ bushel or 35/barrel 10 peelers/bushel or 5% in other containers	Prohibit brown/black sponge Bay wide Sanctuary at 35 ft. contour May 1-Sept. 15
North Carolina	5" Prohibit immature female	None	None Separated. White-lines no sale	5% by number/container	Prohibit brown/black sponge Spawning sanctuaries
South Carolina	5" Includes mature female	5" Includes mature female	None with peeler permit	Zero	Prohibited to take but may sell from another state
Georgia	5"	5"	3"	Zero	Prohibited to take but may sell from another state
Florida	5" Includes mature female	5"	None Separated from catch	5% by number/ container except bait	Prohibited
Alabama	5" Includes mature female Bait Dealer exempt	None Separate from catch	None Separated from catch	Zero except bait and work box	Prohibited May 26-Jan 14
Mississippi	5" Includes mature female	None	None	Zero	Prohibited Crab sanctuaries
Louisiana	5" Includes mature female Prohibit immature female	None	None Separated from catch	2% by number in 50 crab random sample	Prohibited Crab sanctuaries
Texas	5" Includes mature female	5"	5"	5% by number in separate container for bait only	Prohibited to take but may sell from another state

APPENDIX 4. ISSUE PAPERS

APPENDIX 4.1: ACHIEVING SUSTAINABLE HARVEST IN THE NORTH CAROLINA BLUE CRAB FISHERY

I. ISSUE

Implement management measures to achieve sustainable harvest in the North Carolina blue crab fishery.

II. ORIGINATION

North Carolina Division of Marine Fisheries (NCDMF).

III. BACKGROUND

In North Carolina, fishermen have been harvesting blue crabs commercially since the 1800s, with the earliest documented landings reported in 1889 (1). Blue crab (*Callinectes sapidus*) is the most economically important species for commercial fisheries in North Carolina accounting for landings of 27.8 million pounds with an ex-vessel value of \$26.9 million in 2016. North Carolina typically ranks within the top three blue crab producing states on the east coast both in pounds harvested and in value. North Carolina has historically accounted for approximately 22% of annual Atlantic coast blue crab landings since 1950.

The management strategy established in Amendment 1 to the Blue Crab FMP, adopted in 2004, used a single point estimate management trigger for stock status based on September data for mature female blue crabs from the Pamlico Sound Survey (P195; (2)). If the trigger was reached, then a seasonal 6.75-inch maximum size limit for mature females and a 5.25-inch minimum size limit for peeler crabs was enacted annually. Compliance and enforcement of the seasonal mature female maximum size limit and minimum size limit for peeler crabs was limited, hence they were largely ineffective at protecting large mature females. Even when crabbers complied with the management measure by releasing large females or undersize peelers, they may have been captured multiple times and injured, or ultimately harvested by another crabber during their migration to the lower estuaries and into the sounds.

Amendment 2 to the Blue Crab FMP adopted by the Marine Fisheries Commission in November 2013 incorporated the use of the traffic light stock assessment method and adaptive management measures for management of the blue crab stock (3). The Traffic Light method provided a more robust indicator of the overall blue crab stock condition because the data inputs were from multiple surveys encompassing all aspects of the blue crab's life history and distribution rather than a single point index. The 2016 revision to Amendment 2 implemented additional management measures due to exceeding a management threshold established in Amendment 2 (4). Those measures were:

- prohibit harvest of immature female hard crabs;
- prohibit harvest of dark sponge crabs from April 1 to April 30;

- prohibit targeted crab dredging;
- reduce the cull tolerance from 10% to 5%;
- require three cull rings in each crab pot; and
- require one cull ring to be placed within one full mesh of the corner and one full mesh of the bottom of the divider in the upper chamber of the pot.

As part of Amendment 3 a new stock assessment was conducted. A comprehensive stock assessment approach, the sex-specific two-stage model, was applied to available data to assess the status of North Carolina's blue crab stock during 1995–2016 (5). Data were available from commercial fishery monitoring programs and several fishery-independent surveys. The two-stage model was developed based on the catch-survey analysis designed for species lacking information on the age structure of the population. The model synthesized information from multiple sources, tracked population dynamics of male and female recruits and fully recruited animals, estimated critical demographic and fishery parameters such as natural and fishing mortality, and thus, provided a comprehensive assessment of blue crab status in North Carolina. The model estimated an overall declining trend in catch, relative abundance indices, population size of both male and female recruits and fully recruited crabs, with a rebound starting in 2007. The estimated fishing mortality remained high before 2007, and decreased by approximately 50% afterwards. The stock assessment only included hard blue crab harvest from the commercial fishery. Recreational harvest data was not included due to data limitations and commercial peeler and soft blue crab harvest data was not included due to them accounting for a small portion of the overall commercial landings and modelling limitations.

The stock status of North Carolina blue crab in the current stock assessment was determined based on maximum sustainable yield (MSY). Based on the results of this stock assessment, the North Carolina blue crab resource in 2016 was overfished with a 98% probability, given the average spawner abundance in 2016 was estimated at 50 million crabs (below the threshold estimate of 64 million crabs). Overfishing was also occurring in 2016 with a 52% probability, given the average fishing mortality in 2016 was estimated at 1.48 (above the fishing mortality threshold estimate of 1.46).

North Carolina General Statute 113-182.1 mandates that fishery management plans shall: 1) specify a time period not to exceed two years from the date of adoption of the plan to end overfishing, 2) specify a time period not to exceed 10 years from the date of adoption of the plan for achieving a sustainable harvest and 3) must also include a standard of at least 50% probability of achieving sustainable harvest for the fishery. Sustainable harvest is defined in North Carolina General Statute 113-129 as *“the amount of fish that can be taken from a fishery on a continuing basis without reducing the stock biomass of the fishery or causing the fishery to become overfished”*.

In order to recover the blue crab stock, management options were developed to reduce fishing mortality (F) to end overfishing and rebuild the spawning stock and achieve sustainable harvest in the blue crab fishery (Table 4.1.1). A harvest reduction of 0.4% (in numbers of crabs) is projected to end overfishing within two years and a harvest reduction of 2.2% is projected to achieve sustainable harvest and rebuild the blue crab spawning stock within 10 years of the date

of adoption of the plan with a 50% probability of success. This level of reduction is projected to bring spawning stock abundance to the threshold value of 64 million mature females.

Table 4.1.1. Catch reduction projections for varying levels of fishing mortality (F), based on 2016 data from the stock assessment, and the probability of achieving sustainable harvest within the 10-year rebuilding period defined in statute. The bolded row indicates the minimum requirement defined in statute.

F (yr -1)	Catch reduction (%)	Probability of achieving sustainable harvest within 10 years (%)	Comments
1.48	0	31	2016 average F from stock assessment
1.46	0.4	45	Catch reduction to meet F threshold and end overfishing
1.40	1.7	46	Catch reduction to meet spawner abundance threshold and end overfished status
1.38	2.2	50	Catch reduction to meet minimum statutory requirement for achieving sustainable harvest
1.30	3.8	67	
1.22	5.9	90	Catch reduction to meet F target
1.10	9.3	96	
1.00	12.3	100	
0.90	15.7	100	
0.80	19.8	100	Catch reduction to meet spawner abundance target
0.70	24.3	100	

There is also a need to update the adaptive management framework in the Blue Crab FMP. Amendment 2 established an adaptive management framework for blue crab management based on the annual update of the blue crab traffic light analysis (3). This framework requires annual updates of the blue crab traffic light analysis to be presented to the Marine Fisheries Commission as part of the annual Stock Overview report. If either the adult abundance or production characteristics of the traffic light are above 50% red for three consecutive years, then moderate management action (as defined in the framework; Table 4.1.2) is required. Additionally, if either the adult abundance or production characteristics is above 75% red for two years in a three-year period then elevated management action is required. The three-year period was chosen to prevent taking management action due to annual variability and to instead base any management response on a short but continued declining trend in the population. This framework was adopted in part due to the lack of a quantitative assessment of the blue crab stock. Now that a quantitative assessment has been completed and approved for management use (5) the adaptive management framework should be adjusted accordingly.

Table 4.1.2. Management measures under the adaptive management framework for the blue crab Traffic Light in the North Carolina Blue Crab Fishery Management Plan Amendment 2.

Characteristic	Moderate management level	Elevated management level
Adult abundance	A1. Increase in minimum size limit for male and immature female crabs	A4. Closure of the fishery (season and/or gear)
	A2. Reduction in tolerance of sublegal size blue crabs (to a minimum of 5%) and/or implement gear modifications to reduce sublegal catch	A5. Reduction in tolerance of sublegal size blue crabs (to a minimum of 1%) and/or implement gear modifications to reduce sublegal catch
	A3. Eliminate harvest of v-apron immature hard crab females	A6. Time restrictions
Recruit abundance	R1. Establish a seasonal size limit on peeler crabs	R4. Prohibit harvest of sponge crabs (all) and/or require sponge crab excluders in pots in specific areas
	R2. Restrict trip level harvest of sponge crabs (tolerance, quantity, sponge color)	R5. Expand existing and/or designate new crab spawning sanctuaries
	R3. Close the crab spawning sanctuaries from September 1 to February 28 and may impose further restrictions	R6. Closure of the fishery (season and/or gear) R7. Gear modifications in the crab trawl fishery
Production	P1. Restrict trip level harvest of sponge crabs (tolerance, quantity, sponge color)	P4. Prohibit harvest of sponge crabs (all) and/or require sponge crab excluders in pots for specific areas
	P2. Minimum and/or maximum size limit for mature female crabs	P5. Reduce peeler harvest (no white line peelers and/or peeler size limit)
	P3. Close the crab spawning sanctuaries from September 1 to February 28 and may impose further restrictions	P6. Expand existing and/or designate new crab spawning sanctuaries P7. Closure of the fishery (season and/or gear)

IV. AUTHORITY

North Carolina General Statutes

G.S. 113-134 RULES

G.S. 113-182 REGULATION OF FISHING AND FISHERIES

G.S. 113-182.1 FISHERY MANAGEMENT PLANS

G.S. 143B-289.52 MARINE FISHERIES COMMISSION – POWERS AND DUTIES

North Carolina Marine Fisheries Commission Rules

15A NCAC 03L .0201 CRAB HARVEST RESTRICTIONS

V. DISCUSSION

Management measures specific to recreational harvest and commercial peeler and soft blue crab harvest were not included here because the harvest reductions needed relate specifically to the

stock assessment and the commercial hard blue crab fishery. However, any approved management changes will affect all applicable sectors of the blue crab fishery. The discussion below includes specific management measures that were both quantifiable and projected to meet the harvest reduction for hard blue crabs, based on the terminal year of the stock assessment (2016), needed to end overfishing within two years and achieve sustainable harvest within 10 years with at least a 50% probability of success as outlined in North Carolina General Statute 113-182.1. Several management tools were explored to achieve sustainable harvest in the hard blue crab fishery. These include size limits, season and life stage closures, and reducing the cull tolerance of prohibited blue crabs, or some combination of these measures. Where possible, management impacts are presented by region (Figure 4.1.1). Data from the ocean were not included in this analysis as landings are minimal and often confidential.

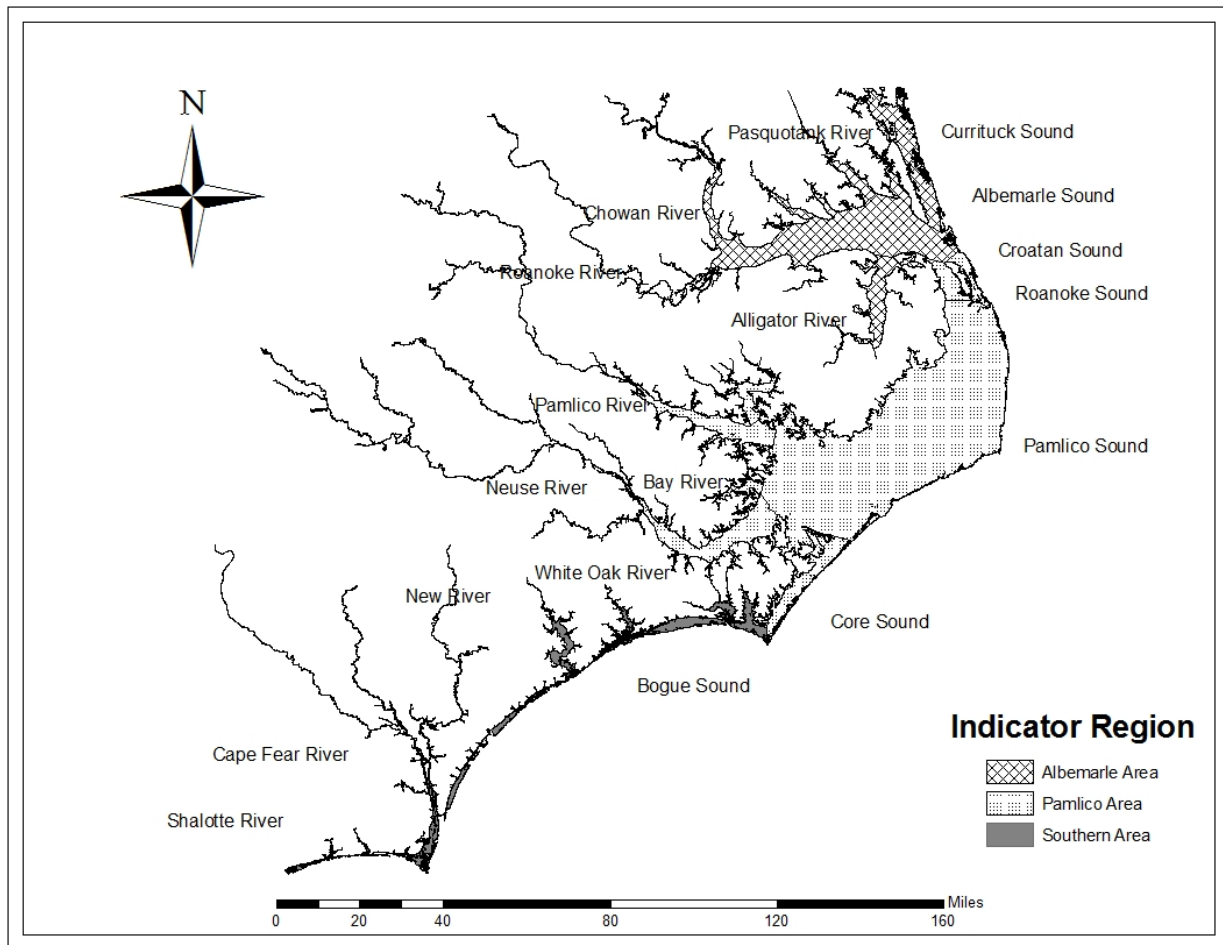


Figure 4.1.1. Map defining the spatial regions used in evaluating potential management impacts.

North Carolina General Statute 113-182.1 states the North Carolina Marine Fisheries Commission (NCMFC) can only recommend the General Assembly limit participation in a fishery if the commission determines sustainable harvest in the fishery cannot otherwise be achieved. Sustainable harvest can be achieved without the use of limited entry therefore limited entry is not considered an option at this time. The management options presented in this paper

are a starting point for discussion on achieving sustainable harvest. Public input could provide additional options.

Trip limits, gear closures, and effort controls were not considered viable options for achieving sustainable harvest because they all allow for the possibility of recoupment by the fishery which prevents the accurate calculation of potential harvest reductions. While a trip limit could reduce the daily harvest of blue crabs it would be unlikely to reduce overall harvest unless trip limits were sufficiently low to make recoupment unlikely. Gear closures present the same issue of recoupment by the fishery where harvest from a closed gear may just be transferred to an open gear thereby providing little to no real harvest reduction. Effort controls, such as pot limits and fishing time restrictions, were not considered as recoupment is a concern with both approaches. A pot limit may not provide a real harvest reduction as blue crabs may potentially be caught in remaining pots in higher numbers, unless the limit was low enough to make gear saturation an issue which may be offset by simply fishing pots more frequently. Fishing time restrictions typically aim to limit the amount of gear that can reasonably be fished in a particular day but may be offset by increasing the number of crew aboard a vessel or fishing fewer pots more frequently. Some of these management options are explored in other issue papers such as the “Management Measures Beyond Quantifiable Harvest Reductions” issue paper, as they may provide some additional protections but their impact cannot be reasonably quantified.

Mature Female Size Limit

Size limits are a common management tool used to rebuild or protect the spawning stock of several species (e.g., striped bass, southern flounder, spotted seatrout). Mature females, peeler, and soft crabs are exempt from the 5-inch minimum size limit for hard crabs (NCMFC Rule 15A NCAC 03L .0201). The short-term effects of establishing a size limit for mature females would be reducing the pool of mature females available for harvest, which in turn would decrease the overall harvest. Decreasing the harvest of mature females should have an immediate effect on reducing the fishing mortality on mature female blue crabs. The benefit to the fishery of establishing a size limit for mature females would not be realized until the recruits produced survive to contribute to the population and the fishery. One of the major benefits to establishing a size limit for mature females is it would protect a portion of the spawning stock from harvest allowing them to remain in the population and the opportunity to release more clutches of eggs. Establishing a size limit for mature females could have a negative impact on the market by reducing the number of blue crabs available for purchase.

Establish a Maximum Size Limit for Mature Female Blue Crabs

Assuming no cull tolerance for mature female blue crabs, maximum size limit options were explored that fell within the range needed to attain sustainable harvest. From the analysis, most mature female blue crabs harvested are less than 6 inches’ carapace width (CW). There were two maximum size limit options falling within the range needed for sustainable harvest, a 6.75-inch and 6.5-inch maximum size limit. The 6.75-inch CW maximum size limit would have an estimated 1.5% overall harvest reduction on average for 2016 which represents approximately 1.4% of the hard crab value (Table 4.1.3). The 6.5-inch CW maximum size limit would have an estimated 4.3% overall harvest reduction on average for 2016 which represents approximately

3.8% of the hard crab value (Table 4.1.4). Recoupment from either maximum size limit should not occur since once mature females reach either size they would be permanently protected from legal harvest.

Table 4.1.3. Harvest percentage (by number) and value of mature female blue crabs 6.75 inches CW and greater by area and overall, 2011-2017.

Year	Mature Female Harvest Percent >6.75" Carapace Width				Value (\$)	Percent of Total Value
	Albemarle	Pamlico	Southern	Overall		
2011	0.6	0.9	0.1	1.6	244,793	1.4
2012	0.6	1.7	0.1	2.5	375,392	1.9
2013	2.1	0.5	<0.1	2.7	558,381	2.1
2014	1.8	1.3	0.1	3.2	901,165	3.0
2015	0.8	1.5	<0.1	2.4	587,445	2.0
2016	0.2	1.2	0.1	1.5	296,399	1.4
2017*	0.8	1.0	0.1	1.9	272,161	1.5
2011-2016 Average	1.0	1.2	0.1	2.3	493,929	2.0

*2017 shown for informational purposes only, not used in stock assessment.

Table 4.1.4. Harvest percentage (by number) and value of mature female blue crabs 6.5 inches CW and greater by area and overall, 2011-2017.

Year	Mature Female Harvest Percent >6.5" Carapace Width				Value (\$)	Percent of Total Value
	Albemarle	Pamlico	Southern	Overall		
2011	1.6	2.3	0.3	4.2	627,286	3.5
2012	1.9	3.8	0.3	6.0	950,835	4.7
2013	4.7	1.5	0.2	6.4	1,355,304	5.1
2014	4.2	2.3	0.2	6.7	1,885,193	6.3
2015	1.9	3.3	0.1	5.4	1,334,084	4.5
2016	1.1	3.0	0.2	4.3	788,728	3.8
2017*	1.5	2.2	0.2	3.8	554,013	3.1
2011-2016 Average	2.5	2.7	0.2	5.4	1,156,905	4.8

*2017 shown for informational purposes only, not used in stock assessment.

Establish a Minimum Size Limit for Mature Female Blue Crabs

Assuming no cull tolerance for mature female blue crabs, minimum size limit options were explored that fell within the range needed to attain sustainable harvest. From the analysis, most mature female blue crabs harvested are less than 6 inches' CW. There were two minimum size limit options falling within the range needed for sustainable harvest, a 5-inch and 5.25-inch minimum size limit. The 5-inch CW minimum size limit would have an estimated 0.9% overall harvest reduction for 2016 which represents approximately 0.8% of the hard crab value (Table 4.1.5). The 5.25-inch CW minimum size limit would have an estimated 4.1% overall harvest reduction for 2016 which represents approximately 3.5% of the hard crab value over this same period (Table 4.1.6). Recoupment from either minimum size limit should not occur since once

mature, females do not get any larger thus they would be permanently protected from legal harvest.

Table 4.1.5. Harvest percentage (by number) and value of mature female blue crabs less than 5 inches CW by area and overall, 2011-2017.

Year	Mature Female Harvest Percent <5" Carapace Width				Value (\$)	Percent of Total Value
	Albemarle	Pamlico	Southern	Overall		
2011	0.0	1.2	0.0	1.2	155,675	0.9
2012	0.2	0.6	0.1	0.9	135,483	0.7
2013	0.2	0.9	0.3	1.4	328,168	1.2
2014	0.2	0.2	0.3	0.7	169,988	0.6
2015	0.1	0.1	0.1	0.3	72,376	0.2
2016	0.3	0.5	0.1	0.9	165,365	0.8
2017*	0.8	0.4	0.4	1.6	254,034	1.4
2011-2016 Average	0.2	0.6	0.1	0.9	171,176	0.7

*2017 shown for informational purposes only, not used in stock assessment.

Table 4.1.6. Harvest percentage (by number) and value of mature female blue crabs less than 5.25 inches CW by area and overall, 2011-2017.

Year	Mature Female Harvest Percent <5.25" Carapace Width				Value (\$)	Percent of Total Value
	Albemarle	Pamlico	Southern	Overall		
2011	0.8	3.0	0.2	3.9	558,223	3.1
2012	0.9	1.7	0.3	2.9	451,630	2.2
2013	0.9	2.2	0.7	3.8	782,678	3.0
2014	0.5	0.6	0.8	1.8	468,715	1.6
2015	1.0	0.5	0.2	1.6	453,072	1.5
2016	1.4	2.2	0.4	4.1	726,198	3.5
2017*	1.9	1.4	0.9	4.2	639,781	3.6
2011-2016 Average	0.9	1.7	0.4	3.0	573,419	2.4

*2017 shown for informational purposes only, not used in stock assessment.

Life Stage and Season Closures

Closures to the blue crab fishery could include season, area, gear, or life stage. The premise behind this management tool is to restrict harvest, whether by time, location, fishery, or life stage to provide protection to blue crabs that are vulnerable to harvest in a particular place and time.

Prohibit Harvest of Immature Female Hard Crabs

Prohibiting the harvest of immature female hard crabs is an example of a life stage closure. In June 2016 the harvest of immature (v-apron) female blue crabs was prohibited under the

conditions of the adaptive management framework in Amendment 2 (4; 5). The intent of this measure was to allow immature females the opportunity to mature before being subject to harvest. Data from 2016 was not used in calculating the average value because the prohibition occurred mid-way through the fishing year and would deflate the average reduction if it were included with years when the prohibition was not in effect. Data from 2017 (post-regulation change) was compared to 2011 through 2015 (pre-regulation change) to gauge the impact this regulation change had on commercial hard blue crab harvest after it was implemented. Some low level of harvest was expected in 2017 as immature females are included in the 5% cull tolerance for prohibited crabs in the blue crab catch. The calculations below assume the cull tolerance remains in place.

From 2011 to 2015, immature female crabs made up 1.2% of the total commercial hard blue crab harvest, this fell to 0.5% in 2016, and in 2017 immature female crabs accounted for 0.1% of the total commercial hard blue crab harvest (Table 4.1.7). Even with immature female hard crabs included in the 5% cull tolerance, prohibiting the harvest of immature female hard crabs appears to have increased the opportunity for more females to become spawning adults prior to being eligible for harvest when comparing 2017 harvest to previous years.

Table 4.1.7. Harvest percentage (percent by number) of immature female hard blue crabs by area and overall and annual value of the harvest, 2011 – 2017.

Year	Immature Female Harvest Percent				Value (\$)	Percent of Total Value
	Albemarle	Pamlico	Southern	Overall		
2011	0.7	0.5	0.0	1.2	132,871	0.7
2012	1.0	0.2	0.0	1.2	173,246	0.9
2013	1.2	0.1	0.0	1.3	245,834	0.9
2014	1.5	0.2	0.0	1.7	375,154	1.3
2015	0.6	0.3	0.0	0.9	203,234	0.7
2011-2015 Average	1.0	0.3	0.0	1.2	226,068	0.9
2016*	0.4	0.1	0.0	0.5	62,658	0.3
2017**	0.1	0.1	0.0	0.1	11,650	0.1

*2016 not used in average because prohibition on immature female harvest began in June 2016

**2017 shown for informational purposes only, not used in stock assessment

Season Closure

A season closure can be used to restrict harvest during certain times of the year to reduce removals from the stock. Since effort can be increased during the open periods of the fishery to offset losses during the closed season, it is best to have seasonal closures that are a minimum of two weeks, but preferably longer. The timing of harvest from the different blue crab fisheries should also be considered with any season closure.

Late season closures tend to be more effective in achieving harvest reductions because there is less opportunity for recoupment by the fisheries. However, a possible result of season closures would be an increase in discards, particularly in fisheries that land, but do not target blue crabs. Table 4.1.8 shows the monthly harvest percent by month, looking at this table shows, for

example, a December closure has the potential to reduce commercial hard blue crab harvest by 2.9% for 2016 which represents approximately 2.8% of the hard blue crab value and a March closure has the potential to reduce commercial hard blue crab harvest by 5.0% and 6.6% of the annual value (Table 4.1.8).

At the request of the Blue Crab FMP AC, additional season closure options were explored for management options 12 and 18 in Table 4.1.13. These include various options for early season closures (portions or all of January, February, or March) as well as different early season closures based on area. If an early season closure is adopted, it would replace the annual pot closure period (Jan. 15 – Feb. 7 which may reopen after Jan. 19) and would remain closed for the entire closure period in order for the estimated harvest reduction to be achieved. Table 4.1.9 shows the estimated 2016 harvest reductions and value for the different early season closure periods explored. For example, one of the options explored is a March 1 through March 24 closure (examined because it is the same number of days as the current pot closure period) which would result in a 4.1% harvest reduction and accounts for 5.5% of the value of the 2016 hard blue crab harvest.

Table 4.1.8. Hard blue crab commercial harvest (percent weight) by region and month and December value by region, 2011 – 2017.

Year	Region	Monthly Harvest Percent											
		Jan.	Feb.	March	April	May	June	July	Aug.	Sep.	Oct.	Nov.	Dec.
2011	Albemarle	0.0	0.0	2.1	1.4	12.5	18.1	13.8	13.3	18.1	13.5	6.5	0.7
	Pamlico	0.2	0.7	6.7	8.9	13.4	15.4	15.3	10.9	12.9	8.7	5.1	1.8
	Southern	0.2	4.1	10.2	3.4	10.6	10.2	9.6	10.5	11.3	6.8	11.8	11.4
	Overall	0.1	0.6	4.5	4.7	12.8	16.5	14.2	12.1	15.6	11.1	6.2	1.7
2012	Albemarle	0.0	0.2	1.6	0.9	14.7	21.0	18.9	16.2	11.6	10.0	4.4	0.6
	Pamlico	0.3	1.1	5.4	9.7	19.7	19.4	16.0	11.6	6.5	5.9	3.3	1.3
	Southern	2.4	4.9	5.4	8.7	13.5	10.0	10.0	11.3	8.4	7.1	9.4	8.8
	Overall	0.3	0.8	3.0	4.1	16.1	19.7	17.4	14.4	9.9	8.5	4.5	1.4
2013	Albemarle	0.0	0.0	0.3	1.2	5.3	15.0	15.8	19.3	20.5	18.3	4.1	0.3
	Pamlico	0.1	0.1	1.5	8.6	14.5	17.0	14.6	12.6	10.2	11.4	7.7	1.7
	Southern	1.5	3.5	4.3	3.9	13.6	14.0	14.3	12.0	8.4	9.0	8.8	6.7
	Overall	0.2	0.3	0.9	3.1	8.0	15.4	15.4	17.2	17.3	16.0	5.3	1.1
2014	Albemarle	0.0	0.0	0.2	1.3	8.8	15.0	12.7	19.6	22.7	16.3	3.2	0.2
	Pamlico	0.2	0.4	0.9	7.0	11.0	13.3	15.8	16.3	15.4	13.2	5.1	1.4
	Southern	1.1	1.8	2.8	2.9	13.4	14.1	14.5	11.9	10.2	9.3	11.3	6.7
	Overall	0.1	0.2	0.5	2.6	9.6	14.6	13.5	18.4	20.4	15.2	4.0	0.9
2015	Albemarle	0.0	0.0	0.2	1.6	8.1	12.4	10.3	18.4	18.9	19.4	9.0	1.7
	Pamlico	0.2	0.1	1.2	4.2	7.2	13.1	16.8	15.3	12.9	11.7	11.4	5.9
	Southern	1.2	0.8	7.9	4.7	15.3	14.8	9.7	9.5	8.3	8.7	9.6	9.6
	Overall	0.1	0.1	0.9	2.6	8.2	12.7	12.4	17.0	16.4	16.4	9.8	3.4
2016	Albemarle	0.4	0.1	3.3	0.9	8.5	19.7	14.8	13.0	14.2	15.5	8.2	1.4
	Pamlico	1.5	0.4	6.8	3.7	9.0	11.2	13.7	13.3	11.7	13.2	11.0	4.4
	Southern	2.1	2.8	6.2	7.1	16.7	12.4	11.4	9.5	9.0	7.6	8.8	6.5
	Overall	1.0	0.4	5.0	2.4	9.2	15.8	14.1	12.9	12.9	14.0	9.4	2.9
2017*	Albemarle	0.2	0.6	0.9	0.8	16.6	22.5	11.7	13.6	13.3	14.8	4.9	0.2
	Pamlico	1.2	4.0	3.4	6.3	15.9	19.3	14.9	14.0	9.6	7.2	3.7	0.5
	Southern	3.0	7.3	3.6	5.2	13.7	11.3	10.2	10.4	8.6	9.2	10.1	7.2
	Overall	0.8	2.3	2.0	3.1	16.1	20.4	12.7	13.5	11.6	11.7	4.9	0.9
2011-2016 Average	Albemarle	0.1	0.1	1.2	1.2	9.6	16.6	14.2	16.9	17.9	15.6	5.9	0.8
	Pamlico	0.5	0.5	4.3	6.8	12.1	14.6	15.4	13.1	11.7	10.5	7.5	3.0
	Southern	1.4	3.1	6.2	5.3	13.8	12.4	11.5	10.8	9.2	8.0	9.9	8.3
	Overall	0.3	0.4	2.5	3.3	10.7	15.7	14.4	15.3	15.4	13.5	6.7	2.0

*2017 shown for informational purposes only, not used in stock assessment

Table 4.1.9. Additional season closure options explored at the request of the Blue Crab FMP AC.

Closure Period	2016 Harvest Reduction (%)	2016 Value (%)
January 15 - February 7 Closure	0.1	0.2
January 1 - January 31 Closure	1.0	1.0
January 1 - February 28/29 Closure	1.3	1.6
March 1 - March 15 Closure	2.6	3.6
March 16 - March 31 Closure	2.4	3.1
March 1 - March 24 Closure	4.1	5.5
March 8 - March 31 Closure	4.3	5.7
March 1 - March 31 Closure	5.0	6.6
January 1 - January 31 Harvest Closure North of 58 Bridge	0.9	0.2
March 1 - March 15 Closure South of 58 Bridge	0.1	0.1
February 20 - March 15 Closure South of 58 Bridge	0.2	0.2

Adjust the Cull Tolerance of Prohibited Hard Blue Crabs

The current cull tolerance of 5% was implemented in June 2016 under the adaptive management plan in Amendment 2 through the May 2016 Revision (4), prior to this action the cull tolerance was 10%. If Amendment 3 is adopted without either maintaining the cull tolerance at 5% or adopting a different tolerance, then the cull tolerance will revert back to 10%. The harvest reductions for 2011-2015 are in relation to the 10% cull tolerance in place prior to 2016. The 2011-2015 period is included here for reference because if the adopted management strategy does not maintain the current 5% cull tolerance or set another cull tolerance value it will revert back to the 10% cull tolerance in place prior to the adoption of the 2016 Revision. Due to data limitations, low sample size, and fishermen behavior harvest reductions could only be calculated for lowering the cull tolerance to zero.

In order to avoid double counting crabs for the harvest reduction calculations and to properly calculate the harvest reduction from reducing the cull tolerance to zero, two different sets of calculations were produced. This was necessary because the cull tolerance (made up of immature females and sublegal males) and immature female harvest are intrinsically linked. Immature females less than five inches CW were previously included in the 10% cull tolerance and when immature female harvest was prohibited in 2016 they were included in the reduced 5% cull tolerance. As a result, the first set of calculations assumes the prohibition on immature female harvest is no longer in effect and immature females are once again subject to the 5-inch minimum size limit. The second set of calculations assumes the prohibition on immature female harvest remains in place and that reduction is accounted for with that management option.

Reducing the cull tolerance of prohibited hard blue crabs to zero (i.e., sublegal males and immature females) would allow individual crabs a greater chance to mature and spawn prior to being harvested. Assuming the prohibition on immature female harvest is removed and the 5-inch minimum size limit restored, the total harvest reduction from reducing the cull tolerance to zero would be 3.7% (combined for sublegal males and sublegal immature females) for 2016

which represents approximately 2.2% of the hard crab value (Table 4.1.10). Assuming the prohibition on immature female harvest remains in place, the total harvest reduction from reducing the cull tolerance to zero would be 3.6% for 2016 which represents approximately 2.2% of the hard crab value over this same period (Table 4.1.11). Recoupment would likely occur as males or immature females grow to the legal minimum size or as immature females mature.

Table 4.1.10. Harvest percentage (by number) and value of sublegal male and sublegal immature female hard blue crabs by area and overall, 2011-2017.

Year	Sublegal Male and Sublegal Immature Female Harvest Percent				Value (\$)	Percent of Total Value
	Albemarle	Pamlico	Southern	Overall		
2011	3.7	1.1	0.1	4.9	502,626	2.8
2012	3.8	1.7	0.2	5.7	703,557	3.5
2013	2.1	0.4	0.1	2.7	470,373	1.8
2014	2.3	0.6	0.2	3.1	637,362	2.1
2015	2.7	1.2	0.1	4.0	728,081	2.5
2011-2015 Average	3.0	1.0	0.1	4.1	608,400	2.5
2016*	2.5	0.9	0.2	3.7	464,655	2.2
2017**	3.1	0.5	0.1	3.8	467,038	2.6

*2016 not used in average because prohibition on immature female harvest and reduction in cull tolerance began half way through the year

**2017 shown for informational purposes only, not used in stock assessment

Table 4.1.11. Harvest percentage (by number) and value of sublegal male and immature female (2017 only) hard blue crabs by area and overall, 2011-2017.

Year	Sublegal Male Harvest Percent				Value (\$)	Percent of Total Value
	Albemarle	Pamlico	Southern	Overall		
2011	3.5	0.9	0.1	4.5	465,443	2.6
2012	3.5	1.6	0.2	5.3	639,218	3.2
2013	1.8	0.4	0.1	2.3	401,069	1.5
2014	2.2	0.5	0.2	2.8	564,363	1.9
2015	2.5	1.1	0.1	3.8	686,496	2.3
2016*	2.5	0.9	0.2	3.6	452,896	2.2
2017**	3.1	0.5	0.1	3.7	462,804	2.6
2011-2015 Average	2.8	0.9	0.1	3.8	534,914	2.2
2017 Immature Female Harvest	0.1	0.1	0.0	0.1	11,650	0.1

*2016 not used in average because prohibition on immature female harvest and reduction in cull tolerance began half way through the year

**2017 shown for informational purposes only, not used in stock assessment

Harvest Reduction Scenarios

The individual estimated 2016 harvest reduction for each management measure examined are presented in Table 4.1.12. They range from 0.5% (prohibit immature female harvest) to 5.0% (March 1 through March 31 closure). Cumulative reductions for combinations of management

measures were calculated using the 2016 reduction from each separate measure as inputs into the appropriate formula for the number of options being combined (Table 4.1.13). Potential management scenario combinations are presented in Tables 4.1.14-4.1.15. They range from implementing one to four of the above management measures and cover all possible combinations of measures explored in this paper. The projected 2016 reductions range from 0.5% to 10.9% depending on the combination of management options. The minimum harvest reduction required to satisfy statutory requirements is 2.2% and can be achieved by implementing a 5.0-inch mature female minimum size limit, prohibiting immature female hard crab harvest, and January 1 through January 31 closure (2.3% reduction). Table 4.1.15 expands on possible closure dates for management scenarios 12 and 18 from Table 4.1.14. Due to the low likelihood they would be selected together, management measure combinations with both a minimum and maximum size limit for mature female blue crabs or multiple closure periods are not presented in Table 4.1.13 but can be produced upon request.

Table 4.1.12. Estimated individual 2016 harvest and value reduction for each management measure.

Management Measure	Estimated 2016 Harvest Reduction (%)	Estimated 2016 Value Reduction (%)
6.75" Mature Female Maximum Size	1.5	1.4
6.5" Mature Female Maximum Size	4.3	3.8
5.0" Mature Female Minimum Size	0.9	0.8
5.25" Mature Female Minimum Size	4.1	3.5
Prohibit Immature Female Harvest	0.5	0.3
December 1 - December 31 Closure	2.9	2.8
Reducing Cull Tolerance to Zero	3.7	2.2
January 15 - February 7 Closure	0.1	0.2
January 1 - January 31 Closure	1.0	1.0
January 1 - February 28/29 Closure	1.3	1.6
March 1 - March 15 Closure	2.6	3.6
March 16 - March 31 Closure	2.4	3.1
March 1 - March 24 Closure	4.1	5.5
March 8 - March 31 Closure	4.3	5.7
March 1 - March 31 Closure	5.0	6.6

Table 4.1.13. Cumulative harvest reduction equations for each number of management options considered.

Number of Options	Harvest Reduction Equation	Variable Definition
1	$Z=X$	Z=cumulative harvest reduction
2	$Z=X+((1-X)*Y)$	X=reduction from option 1
3	$Z=X+((1-X)*Y)+(1-(X+((1-X)*Y)))*W$	Y=reduction from option 2
4	$Z=X+((1-X)*Y)+((1-(X+((1-X)*Y)))*W)+((1-(X+((1-X)*Y)+(1-(X+((1-X)*Y)))*W))*U$	W=reduction from option 3 U=reduction from option 4

Table 4.1.14. Estimated harvest reductions for all management scenario combinations. Gray boxes indicate the harvest reduction needed for varying probabilities of achieving sustainable harvest. Options 1 through 5 do not meet statutory requirements for achieving sustainable harvest. Beginning with option 6, all remaining options meet or exceed the minimum statutory requirement for achieving sustainable harvest. *Examples of different season closures for options 12 and 18 can be found in Table 4.1.15.

Management Option	Management Measure	2011-2016 Average Harvest Reduction (%)	2016 Harvest Reduction (%)	Management Option	Management Measure	2011-2016 Average Harvest Reduction (%)	2016 Harvest Reduction (%)	
Options 1-5: Do not meet required 50% probability of ending overfished				13	6.5" Mature Female Maximum Size	5.4	4.3	
1	Prohibit Immature Female Harvest	1.1	0.5	14	6.75" Mature Female Maximum Size	4.3	4.4	
2	5" Mature Female Minimum Size	0.9	0.9		December Closure			
3	5" Mature Female Minimum Size Prohibit Immature Female Harvest	2.0	1.4	15	5" Mature Female Minimum Size Reducing Cull Tolerance to Zero	5.0	4.6	
4	6.75" Mature Female Maximum Size	2.3	1.5	16	5.25" Mature Female Minimum Size Prohibit Immature Female Harvest	4.1	4.6	
5	6.75" Mature Female Maximum Size Prohibit Immature Female Harvest	3.4	2.0	17	6.5" Mature Female Maximum Size Prohibit Immature Female Harvest	6.4	4.8	
Reduction with a 50% probability of ending overfished			2.2	18*	6.75" Mature Female Maximum Size Prohibit Immature Female Harvest December Closure	5.3	4.8	
6	December Closure	2.0	2.9	19	5" Mature Female Minimum Size Prohibit Immature Female Harvest Reducing Cull Tolerance to Zero	5.9	4.9	
7	Prohibit Immature Female Harvest December Closure	3.1	3.4	20	6.75" Mature Female Maximum Size Reducing Cull Tolerance to Zero	6.3	5.1	
8	Reducing Cull Tolerance to Zero	4.1	3.7	21	6.75" Mature Female Maximum Size Prohibit Immature Female Harvest Reducing Cull Tolerance to Zero	7.2	5.5	
Reduction with a 67% probability of ending overfished			3.8	Reduction with a 90% probability of ending overfished				5.9
9	5" Mature Female Minimum Size December Closure	2.9	3.8	22	Reducing Cull Tolerance to Zero December Closure	6.0	6.5	
10	Prohibit Immature Female Harvest Reducing Cull Tolerance to Zero	5.1	4.1					
11	5.25" Mature Female Minimum Size	3.0	4.1					
12*	5" Mature Female Minimum Size Prohibit Immature Female Harvest December Closure	4.0	4.3					

Table 4.1.14. continued...

Management Option	Management Measure	2011-2016 Average Harvest Reduction (%)	2016 Harvest Reduction (%)	Management Option	Management Measure	2011-2016 Average Harvest Reduction (%)	2016 Harvest Reduction (%)
23	Prohibit Immature Female Harvest December Closure Reducing Cull Tolerance to Zero	7.0	6.9	33	5.25" Mature Female Minimum Size Prohibit Immature Female Harvest Reducing Cull Tolerance to Zero	7.9	8.0
24	5.25" Mature Female Minimum Size December Closure	4.9	6.9	34	6.5" Mature Female Maximum Size Prohibit Immature Female Harvest Reducing Cull Tolerance to Zero	10.2	8.2
25	6.5" Mature Female Maximum Size December Closure	7.3	7.1	35	6.75" Mature Female Maximum Size Prohibit Immature Female Harvest Reducing Cull Tolerance to Zero December Closure	9.1	8.3
26	5" Mature Female Minimum Size December Closure Reducing Cull Tolerance to Zero	6.9	7.3				
					Reduction with a 96% probability of ending overfished		9.3
27	5.25" Mature Female Minimum Size Prohibit Immature Female Harvest December Closure	6.0	7.3	36	5.25" Mature Female Minimum Size December Closure Reducing Cull Tolerance to Zero	8.8	10.3
28	6.5" Mature Female Maximum Size Prohibit Immature Female Harvest December Closure	8.3	7.5	37	6.5" Mature Female Maximum Size December Closure Reducing Cull Tolerance to Zero	11.1	10.5
29	5.25" Mature Female Minimum Size Reducing Cull Tolerance to Zero	7.0	7.6	38	5.25" Mature Female Minimum Size Prohibit Immature Female Harvest Reducing Cull Tolerance to Zero December Closure	9.7	10.7
30	5" Mature Female Minimum Size Prohibit Immature Female Harvest Reducing Cull Tolerance to Zero December Closure	7.8	7.7	39	6.5" Mature Female Maximum Size Prohibit Immature Female Harvest Reducing Cull Tolerance to Zero December Closure	12.0	10.9
31	6.5" Mature Female Maximum Size Reducing Cull Tolerance to Zero	9.3	7.8				
32	6.75" Mature Female Maximum Size December Closure Reducing Cull Tolerance to Zero	8.2	7.9				

Table 4.1.15. Estimated harvest reductions for management options 12 and 18 from Table 4.1.14 with various closure periods requested by the Blue Crab FMP AC.

Management Option	Management Measure	2011-2016 Average Harvest Reduction (%)	2016 Harvest Reduction (%)	Management Option	Management Measure	2011-2016 Average Harvest Reduction (%)	2016 Harvest Reduction (%)
Option 12.1: Does not meet required 50% probability of ending overfished				Option 18.1: Does not meet required 50% probability of ending overfished			
12.1	5" Mature Female Minimum Size Prohibit Immature Female Harvest January 15 - February 7 Closure	2.2	1.5	18.1	6.75" Mature Female Maximum Size Prohibit Immature Female Harvest January 15 - February 7 Closure	3.5	2.1
Reduction with a 50% probability of ending overfished				Reduction with a 50% probability of ending overfished			
12.2	5" Mature Female Minimum Size Prohibit Immature Female Harvest January 1 - January 31 Closure	2.4	2.3	18.2	6.75" Mature Female Maximum Size Prohibit Immature Female Harvest January 1 - January 31 Closure	3.7	2.9
12.3	5" Mature Female Minimum Size Prohibit Immature Female Harvest January 1 - February 28/29 Closure	2.9	2.7	18.3 (BCAC)	Prohibit Immature Female Harvest Jan. 1 - Jan. 31 Closure North of Hwy 58 Bridge March 1 - March 15 Closure South of Hwy 58 Bridge 6.75" Mature Female Max. Size North of Hwy 58 Bridge	3.7	3.2
12.4	5" Mature Female Minimum Size Prohibit Immature Female Harvest March 16 - March 31 Closure	3.4	3.7	18.4	Prohibit Immature Female Harvest Jan. 1 - Jan. 31 Closure North of Hwy 58 Bridge Feb. 20 - March 15 Closure South of Hwy 58 Bridge 6.75" Mature Female Max. Size North of Hwy 58 Bridge	3.8	3.2
Reduction with a 67% probability of ending overfished				Reduction with a 67% probability of ending overfished			
12.5	5" Mature Female Minimum Size Prohibit Immature Female Harvest March 1 - March 15 Closure	3.2	4.0	18.5	6.75" Mature Female Maximum Size Prohibit Immature Female Harvest January 1 - February 28/29 Closure	4.2	3.3
12.6	5" Mature Female Minimum Size Prohibit Immature Female Harvest March 1 - March 24 Closure	4.1	5.4	Reduction with a 67% probability of ending overfished			
12.7	5" Mature Female Minimum Size Prohibit Immature Female Harvest March 8 - March 31 Closure	4.2	5.6	18.6	6.75" Mature Female Maximum Size Prohibit Immature Female Harvest March 16 - March 31 Closure	4.7	4.3
Reduction with a 90% probability of ending overfished				Reduction with a 90% probability of ending overfished			
12.8	5" Mature Female Minimum Size Prohibit Immature Female Harvest March 1 - March 31 Closure	4.6	6.3	18.7	6.75" Mature Female Maximum Size Prohibit Immature Female Harvest March 1 - March 15 Closure	4.6	4.5
Reduction with a 90% probability of ending overfished				Reduction with a 90% probability of ending overfished			
				18.8	6.75" Mature Female Maximum Size Prohibit Immature Female Harvest March 1 - March 24 Closure	5.4	6.0
				18.9	6.75" Mature Female Maximum Size Prohibit Immature Female Harvest March 8 - March 31 Closure	5.5	6.2
				18.10	6.75" Mature Female Maximum Size Prohibit Immature Female Harvest March 1 - March 31 Closure	5.9	6.9

Adaptive Management of the North Carolina Blue Crab Stock

Adaptive management is a structured, iterative process of decision-making when uncertainty is present, with the objective of reducing uncertainty through time with monitoring. Adaptive management uses a learning process to improve management outcomes (6). The challenge with using adaptive management is to find a balance between gaining knowledge to improve management and achieving the best outcome based on current knowledge (7). As more is learned about a fishery, adaptive management provides flexibility to incorporate new data and information to accommodate alternative and/or additional actions. In the context of North Carolina FMPs, adaptive management is an optional management framework contained which allows for specific management changes to be taken between FMP reviews under specified circumstances to accomplish the goals and objectives of the plan. Proposed actions are evaluated, adopted, and documented through a revision document. The revision document and process is comparable to the federal “addendum” process.

Amendment 2 established an adaptive management framework for blue crab management based on the annual update of the blue crab traffic light analysis (3). Amendment 3 will replace this framework with one based on the peer-reviewed and approved stock assessment model developed by division staff for the North Carolina blue crab stock. The stock assessment was able to establish biological reference points necessary for managing and ensuring the sustainable harvest of the blue crab stock. A harvest reduction of 0.4% (in numbers of crabs) is projected to end overfishing within two years and a harvest reduction of 2.2% (in numbers of crabs) is projected to achieve sustainable harvest and rebuild the blue crab spawning stock within 10 years of the date of adoption of the plan with a 50% probability of success. This level of reduction is projected to bring spawning stock abundance to the threshold value of 64 million mature females.

The adaptive management framework upon approval of Amendment 3 shall consist of the following:

1. Update the stock assessment at least once in between full reviews of the FMP, timing at the discretion of the division
 - a. If the stock is overfished and/or overfishing is occurring or it is not projected to meet the sustainability requirements, then management measures shall be adjusted using the director’s proclamation authority
 - b. If the stock is not overfished and overfishing is not occurring, then management measures may be relaxed provided it will not jeopardize the sustainability of the blue crab stock
2. Any quantifiable management measure, including those not explored in this paper, with the ability to achieve sustainable harvest (as defined in the stock assessment), either on its own or in combination, may be considered
3. Use of the director’s proclamation authority for adaptive management is contingent on:
 - a. consultation with the Northern, Southern, and Shellfish/Crustacean advisory committees
 - b. approval by the Marine Fisheries Commission

Upon evaluation by the division, if a management measure adopted to achieve sustainable harvest (either through Amendment 3 or a subsequent Revision) is not working as intended, then it may be revisited and either: 1) revised or 2) removed and replaced as needed provided it conforms to steps 2 and 3 above.

VI. MANAGEMENT OPTIONS

(+ Potential positive impact of action)

(- Potential negative impact of action)

Below are overarching positive and negative impacts for all options, specific impacts from an option may be found below that option.

- + May increase abundance of mature females helping to rebuild the spawning stock
 - + Will affect both commercial and recreational blue crab fisheries
 - + No rule changes required
 - Decreased harvest with economic loss to the fishery
1. Implement a size limit for the harvest of mature female blue crabs
 - + May increase juvenile recruitment
 - Some regions may be impacted more than others
 - Increased catch processing time for fishermen
 - a. 6.75-inch maximum size limit for mature female blue crabs
 - b. 6.5-inch maximum size limit for mature female blue crabs
 - c. 5.0-inch minimum size limit for mature female blue crabs
 - d. 5.25-inch minimum size limit for mature female blue crabs
 2. Limit the harvest of immature female hard blue crabs
 - Some regions may be impacted more than others
 - Predicted reduction may be less than expected due to recoument once immature female crabs mature or they may be legally harvested as peeler or soft crabs
 - Increased catch processing time for fishermen
 - a. Maintain current prohibition on immature female hard blue crab harvest (in effect through 2016 Revision to Amendment 2)
 - b. Allow harvest of immature female hard blue crabs with a 5-inch minimum size limit
 3. Seasonal closure of the blue crab fishery
 - +/- Depending on the timing, the predicted reduction may be less than expected due to recoument once the fishery reopens
 4. Adjust the cull tolerance for prohibited blue crabs
 - + Increases escapement of prohibited crabs
 - Predicted reduction may be less than expected due to recoument once crabs reach legal size or stage

- Increased catch processing time for fishermen
 - a. Maintain the current cull tolerance of 5% (in effect through 2016 Revision to Amendment 2)
 - b. Reduce the cull tolerance to zero

- 5. Adopt the adaptive management framework based on the peer-reviewed and approved stock assessment model
 - + Management is based on biological reference points
 - + Provides for the protection and future sustainability of the blue crab stock
 - Potential uncertainty in regulations for public

VII. RECOMMENDATIONS

NCMFC Selected Management Strategy

- Option 18.3: 1) North of the Highway 58 Bridge: January 1 through January 31 closed season, 6.75” mature female hard crab maximum size limit, and prohibit immature female hard crab harvest and 2) South of the Highway 58 Bridge: March 1 through March 15 closed season and prohibit immature female hard crab harvest (3.1% harvest reduction; 50% - 67% probability of success)

- Recommended season closures for Option 18.3 will replace the current pot closure period and will remain closed for the entire time period

- Maintain 5% cull tolerance established in 2016 Revision

- Adopt proposed adaptive management framework and allow measures to be relaxed if the assessment update says stock is not overfished and overfishing is not occurring

- Recommend updating the stock assessment once 2019 data is available

VIII. LITERATURE CITED

1. Chestnut, A. F. and H. S. Davis. 1975. Synopsis of marine fisheries of North Carolina: Part I: Statistical Information, 1880-1973. University of North Carolina Sea Grant Program Publication UNC-SG-75-12. 425 p.
2. NCDMF (North Carolina Division of Marine Fisheries). 2004. North Carolina Fishery Management Plan Blue Crab. North Carolina Department of Environment and Natural Resources. North Carolina Division of Marine Fisheries. Morehead City, NC. 411 p.
3. NCDMF. 2013. North Carolina Blue Crab Fishery Management Plan Amendment 2. North Carolina Department of Environment and Natural Resources, Division of Marine Fisheries. Morehead City, NC. 528 p.
4. NCDMF. 2016. May 2016 Revision to Amendment 2 to the North Carolina Blue Crab Fishery Management Plan. North Carolina Department of Environmental Quality, Division of Marine Fisheries. Morehead City, NC. 53 p.

5. NCDMF. 2018. Stock assessment of the North Carolina blue crab (*Callinectes sapidus*), 1995–2016. North Carolina Division of Marine Fisheries, NCDMF SAP-SAR-2018-02, Morehead City, North Carolina. 144 p.
6. Holling, C. S. (editor). 1978. *Adaptive Environmental Assessment and Management*. John Wiley and Sons. London, England.
7. Allan, C. and G. H. Stankey. 2009. *Adaptive Environmental Management: A Practitioner's Guide*. Dordrecht, Netherlands.

APPENDIX 4.2: MANAGEMENT OPTIONS BEYOND QUANTIFIABLE HARVEST REDUCTIONS

I. ISSUE

Results of qualitative management on the North Carolina blue crab stock cannot be quantified. However, implementing these management measures may serve to improve the overall blue crab stock and reduce bycatch.

II. ORIGINATION

North Carolina Division of Marine Fisheries (NCDMF).

III. BACKGROUND

As part of Amendment 3, a comprehensive stock assessment was completed. A sex-specific two-stage model was applied to available data to assess the status of North Carolina's blue crab stock during 1995–2016 (1). Data were available from commercial fishery monitoring programs and several fishery-independent surveys. The two-stage model was developed based on the catch-survey analysis designed for species lacking information on the age structure of the population. The model synthesized information from multiple sources, tracked population dynamics of male and female recruits and fully recruited animals, estimated critical demographic and fishery parameters such as natural and fishing mortality, providing a comprehensive assessment of blue crab status in North Carolina. The model estimated an overall declining trend in catch, relative abundance, population size of both male and female recruits and fully recruited crabs, with a rebound starting in 2007. The estimated fishing mortality remained high before 2007 and decreased by approximately 50% afterwards.

The stock status of North Carolina blue crab in the current stock assessment was determined based on maximum sustainable yield (MSY). Results of this stock assessment indicate the North Carolina blue crab resource in 2016 was overfished with a probability of 0.98, with the average spawner abundance in 2016 estimated at 50 million crabs (below the threshold estimate of 64 million crabs). Overfishing was also occurring in 2016 with a probability of 0.52. The average fishing mortality in 2016 was estimated at 1.48, above the fishing mortality threshold estimate of 1.46.

To increase blue crab spawners and recruitment, qualitative management options were developed. Impact of these measures on recruitment and overfishing cannot always be directly measured from the results of the stock assessment. These qualitative management measures may impact these metrics, however, the magnitude of these management measures as well as the possible response of the stock is unknown.

As previously noted, the 2016 stock assessment set quantifiable values for blue crab fishing mortality (overfishing) and spawning stock biomass (overfished). Projections were performed to demonstrate how changes in fishing mortality would impact spawning stock biomass. The earlier traffic light was not a modeling approach that produces these important biological reference

points and therefore all management measures considered at that time were not required to be quantitatively assessed in the same manner as required now via the 2016 stock assessment. Currently there are two categories of management measures: quantifiable and beyond quantifiable. “Quantifiable” are those used as direct data inputs for the stock assessment model and produce weighable impact on blue crab recruitment or mortality. “Beyond Quantifiable” are those that aren’t directly part of the stock assessment model and there is no way to measure the impact to the modelled fishing mortality. This does not mean that beyond quantifiable measures are not important to consider in management, they merely are not able to be included in the percent reduction needed to end overfishing/overfished status as statutorily required. If beyond quantifiable measures are implemented, future stock assessments will indirectly reflect their effect on the fishery status. Various beyond quantifiable management options under consideration include gear modifications, life stage closures, and means to control effort in the fishery. Since specific impacts on recruitment and overfishing cannot be calculated, relevant empirical data for the various option are presented herein.

IV. AUTHORITY

North Carolina General Statutes

113-134 RULES

113-182 REGULATION OF FISHING AND FISHERIES

113-182.1 FISHERY MANAGEMENT PLANS

143B-289.52 MARINE FISHERIES COMMISSION – POWERS AND DUTIES

North Carolina Marine Fisheries Rules

15A NCAC 03J .0301 POTS

15A NCAC 03J .0302 RECREATIONAL USE OF POTS

15A NCAC 03L .0201 CRAB HARVEST RESTRICTIONS

15A NCAC 03L .0202 CRAB TRAWLING

15A NCAC 03L .0204 CRAB POTS

15A NCAC 03R .0118 EXEMPTED CRAB POT ESCAPE RING AREAS

V. DISCUSSION

Gear Modifications

Modification to harvest gear can be used to reduce catch and mortality of sublegal bycatch of target and non-target species. Several studies have examined the effects of the number, placement, and size of cull rings in crab pots. Sampling is also conducted year-round and statewide at commercial crab houses by NCDMF to characterize the gears and harvest of the commercial trip. This sampling is opportunistic and may not characterize the variations in the gear used in the fishery precisely, and sampling intensity can vary by area and year.

Cull ring size

Cull (escape) rings are a device used in crab pots to reduce bycatch, reduce sublegal harvest, and reduce cull time for fishermen. Current rules require three cull rings per pot of 2 5/16-inches

minimum inside diameter, one of which must be placed within one full mesh of the corner and one full mesh of the bottom of the divider in the upper chamber of the pot. Size of cull rings required vary among other states (Appendix 3).

Rudershausen and Turano (2) tested three different size cull rings: 2 5/16-inches, 2 3/8-inches, and 2 7/16-inches. The study indicated catch rates of sublegal males were reduced by increasing cull ring size and not by the number of rings (Table 4.2.1). They also found the catch rates of legal males and mature females were generally maintained with larger cull rings and estimated the body length of minimally legal male crabs was not less than the current minimum cull ring diameter. Rudershausen and Hightower (3) tested three different size cull rings: 2 5/16-inches, 2 3/8-inches, and 2 7/16-inches from May through September 2010 in the Pamlico River.

Parameters estimated included the carapace width at which half the individuals are retained pots and the carapace width at initial retention. They found the mean number of legal male crabs was not significantly different among cull ring sizes, but the mean number of sublegal male crabs was significantly less in pots using the two largest cull ring sizes (Table 4.2.2). The credible limits in Table 2 indicate the range of values within which an unobserved parameter of a predictive distribution falls. For instance, a 2 5/16-inch cull ring initial retention would fall in the carapace width range of 4.59 inches to 4.73 inches with a median carapace width of 4.67 inches.

Table 4.2.1. Effects of cull ring size, number of cull rings, and their interactions on the CPUE of blue crabs. An asterisk next to the *F*-value indicates data transformation (2).

Estuary	Effect	df	Legal male		Sublegal male		Mature female		Sponge	
			<i>F</i>	<i>P</i>	<i>F</i>	<i>P</i>	<i>F</i>	<i>P</i>	<i>F</i>	<i>P</i>
Currituck Sound	Ring Size	2	10.62	<0.001	523*	<0.001	3.52*	0.030		
	Ring number	2	8.25	<0.001	11.1*	<0.001	1.28*	0.277		
	Interaction	4	0.87	0.482	0.39*	0.816	0.66*	0.623		
Core Sound	Ring Size	2	1.08	0.340	195*	<0.001	10.2*	<0.001		
	Ring number	2	1.39	0.250	2.41*	0.090	0.42*	0.657		
	Interaction	4	0.30	0.878	0.22*	0.928	0.93*	0.449		
Albemarle Sound	Ring Size	1	0.03*	0.864	83.8*	<0.001	0.82*	0.365		
	Ring number	2	0.34*	0.712	3.27*	0.038	0.004*	0.996		
	Interaction	2	0.27*	0.762	0.41*	0.661	0.07*	0.929		
Bogue Sound	Ring Size	1	0.46	0.498	272*	<0.001	2.47*	0.116		
	Ring number	2	1.14	0.319	1.79*	0.168	0.90*	0.406		
	Interaction	2	0.02	0.983	0.01*	0.990	1.17*	0.310		
Eastern Pamlico Sound	Ring Size	1	1.11	0.292	0.61*	0.433	3.16*	0.076	0.04*	0.849
	Ring number	2	0.76	0.469	1.59*	0.204	1.08*	0.341	0.08*	0.920
	Interaction	2	0.46	0.630	0.16*	0.851	0.03*	0.972	0.12*	0.884
Cape Fear River	Ring Size	1	0.02	0.894	15.7*	<0.001	0.002*	0.962		
	Ring number	2	0.19	0.826	2.91*	0.055	0.005*	0.995		
	Interaction	2	2.82	0.060	0.56*	0.572	0.523*	0.593		
Pamlico River	Ring Size	1	2.99	0.084	29.0*	<0.001	3.44*	0.064		
	Ring number	2	0.95	0.388	1.47*	0.230	0.74*	0.479		
	Interaction	2	0.25	0.782	1.62*	0.197	0.37*	0.688		

Table 4.2.2. Median and credible limits (CLs) of logistic retention model parameter estimates of the carapace width (inches) retention size (at which half the individuals are retained pots) and initial retention size (3).

Cull ring size (mm)	Parameter or variable	2.5 CL	Median	97.5 CL
58.7 (2 5/16-inch)	retention size	4.83	4.91	5.00
	initial retention size	4.59	4.67	4.73
60.3 (2 3/8-inch)	retention size	4.97	5.07	5.17
	initial retention size	4.53	4.65	4.73
61.9 (2 7/16-inch)	retention size	5.05	5.13	5.22
	initial retention size	4.70	4.79	4.87

The percent composition of sampled commercial trips cull ring size usage is presented to characterize the size of cull rings used in the fishery and illustrate the degree of impact if cull ring size requirements were to change (Table 4.2.3). For example, if the minimum cull ring size was increased to 2 3/8-inches, approximately 18% of commercial trips from 2011-2016 sampled were at or above this limit and 15% of commercial trips sampled in 2017. The cost and effort to change the cull ring must also be considered; cull rings can be purchased for around \$0.25 each.

Table 4.2.3. Percent of sampled (2011-2017) commercial crab pot trips with various cull ring sizes.

Cull Ring Size	Percent of Sampled Trips by Cull Ring Size	
	2011-2016	2017
2 5/16-inch (minimum legal size)	82%	85%
2 3/8-inch	8%	12%
2 7/16-inch	8%	3%
2 1/2-inch	1%	
>2 1/2-inch	1%	

Number of Cull Rings

Research regarding the number of cull rings in crab pots and the associated reduction in retained sublegal crabs by Rudershausen and Turano (2) determined that increasing the number of cull rings did not significantly reduce catch of sublegal males (Table 4.2.1). Two cull rings have been mandatory in hard crab pots in North Carolina since February 1, 1989, except in exempt areas. In January 2017, the number of cull rings required in hard crab pots was increased to three cull rings as part of the revision to Amendment 2, when the traffic light threshold was met to initiate management restrictions. The number of cull rings required to a pot vary among other states (Appendix 3).

The percent composition of sampled commercial trips is shown to characterize the number of cull rings used in the fishery and illustrate the degree of impact on the fishery if the minimum number of cull rings per pot were to change (Table 4.2.4). For example, if the number of required cull rings was increased to four, approximately 9% of commercial trips sampled were at or above this limit. The cost and effort to change the number of cull rings must also be considered. A new cull ring can be purchased for around \$0.25 and effort is required to cut an opening in pot mesh and mount the cull ring. In 2017 the minimum number of cull rings was increased from two to three. Yet 5% of commercial trips sampled in 2017 had less than the minimum three cull rings.

Table 4.2.4. Percent of sampled (2011-2017) commercial crab pot trips with varying sizes of cull rings.

Number of Cull Rings	Percent of Sampled Trips	
	2011-2016	2017
2	87%	5%
3	8%	86%
4	3%	7%
5	1%	1%
>5	1%	1%

Placement of Cull Rings

Research has been done regarding the placement of cull rings in crab pots related to reductions in sublegal crabs. Havens et al. (4) tested pots with modified cull ring placement (Figure 4.2.1). Modified pots had cull rings placed in the corner of the pots and flush with the floor of the upper chamber. Approximately 60% of sublegal crabs escaped modified pots within one hour compared to 4% in unmodified pots. The odds of escapement of sublegal crabs in modified pots in a 24-hour period was eighteen times greater than in unmodified pots. Specific crab reductions from modifying the placement of cull rings in crab pots cannot be calculated and the impact on the fishery is unknown.

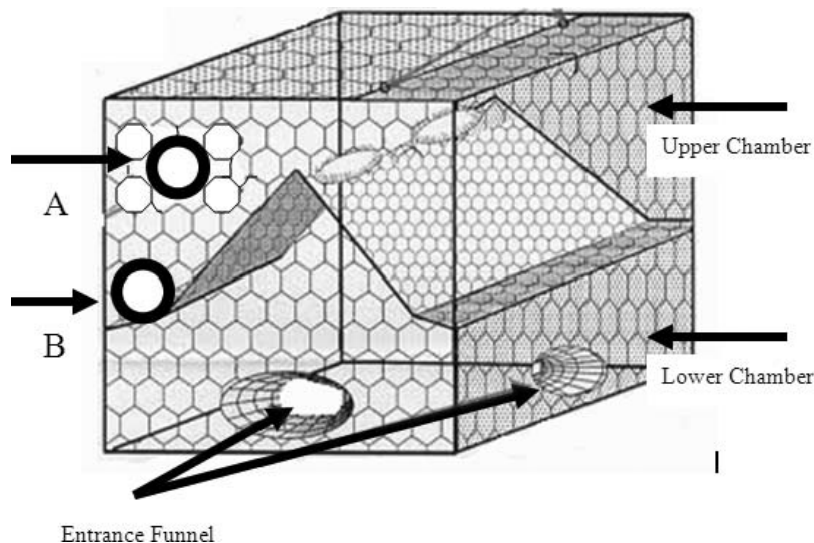


Figure 4.2.1. Placement of cull rings in crab pots: (A) unmodified pots had the cull ring placed on the outer wall of the upper chamber, 15cm above the chamber floor; and (B) modified pots had the cull ring placed in the corner and flush with the upper chamber floor. Source: (4).

In 2016, crabbers indicated adding a third cull ring in the modified position was preferable, as they would not have to close holes created by moving a cull ring. This modified position requirement has been in effect in North Carolina since January 2017. Industry feedback has been

positive regarding cull ring placement. Two states besides North Carolina have placement requirements of cull rings (Appendix 3).

Removing Cull Ring Exemptions

Mature female crabs are exempt from the five-inch minimum size limit (NCMFC Rule 15A NCAC 03L .0201 (a)). Some females mature prior to reaching five inches in size and would be unavailable for harvest because once mature they will not grow any larger. Particularly in high salinity areas, such as those with the current escape ring exemption, a portion of the available mature females may be of such a small size they may leave the pot through the 2 5/16-inch escape rings (minimum legal size). Therefore, during the development of Amendment 2, the long-standing proclamation allowing pots to be set without escape rings or with closed escape rings to prevent the loss of small mature female blue crabs in Pamlico Sound and the Newport River were put into rule (Figure 4.2.2). However, the exemption area in Pamlico Sound was reduced by moving the boundary line from six miles from shore to the existing no trawl line behind the Outer Banks.

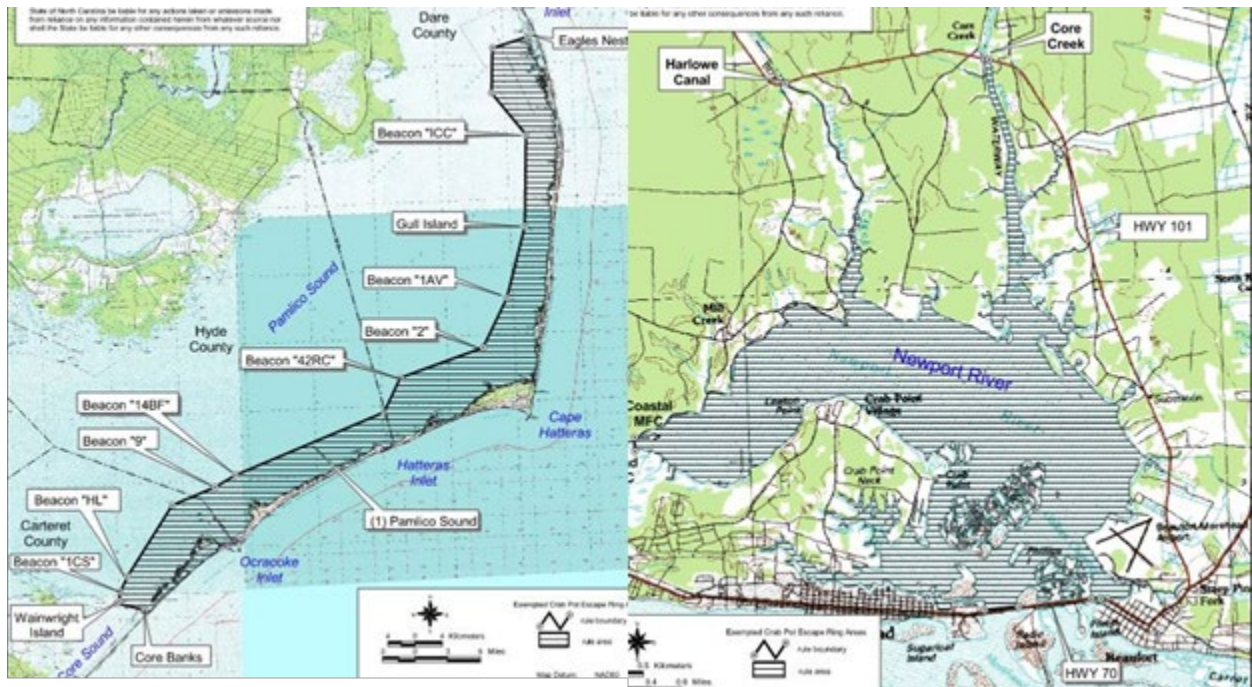


Figure 4.2.2. Escape ring exempted areas in Pamlico Sound, NC (left) and Newport River, NC (right).

Based on NCDMF crab fishery sampling, the escape ring exemption is used in 15% of sampled trips in the allowed areas from 2011-2016 (Table 4.2.5). However, zero trips sampled in 2017 utilized the exemption. Of trips utilizing the exemption, none were from the Newport River. Perhaps in the past when the southern Outer Banks fishery was robust with more crabs and crabbers, the practice of closing the escape rings was more prevalent. Another possibility is there is no market to make it worthwhile for crabbers to retain small mature females.

Table 4.2.5. Percent of sampled (2011-2017) commercial crab pot trips with varying sizes of cull rings in escape ring exempted areas. 2011-2016 n=64, 17 from the Newport River. 2017 n=9, 2 from the Newport River.

Number of Cull Rings	Percent of Sampled Trips	
	2011-2016 (n = 64)	2017 (n = 9)
0	15%	
1	0%	
2	76%	
3	7%	100%
4	2%	

Assuming no cull tolerance for sublegal crabs and a 5-inch minimum size limit, the harvest reduction for eastern Pamlico Sound is approximately 13%. There was not enough commercial crab sampling data specific to the Newport River to estimate harvest reductions for this area. Some measure of recouplement would be likely for both male and immature females. Recouplement for male crabs would likely occur as they grow to the legal minimum size. Recouplement for immature females would likely occur after they undergo their terminal molt and become mature females, which are exempt from the minimum size limit. The recouplement of small mature female crabs would likely be low as some would be able to escape through the existing cull rings.

During development of Amendment 2, NCDMF staff contacted and discussed the Outer Banks escape ring exemption and potential options to modify the boundary with area crabbers. Overall opinions were mixed; but several crabbers indicated they would like to maintain the flexibility to set pots with closed escape rings. If the exemption for these two areas is not removed completely, one alternative would be to reestablish proclamation authority in rule but with specific criteria for the use of that authority. The criteria and resulting rule change could be developed after the adoption of Amendment 3 in conjunction with the Shellfish/Crustacean Advisory Committee. The NCMFC will have the opportunity to weigh in during the rule development process as all rule changes are approved by the commission.

Degradable Panels

An estimated 17% crab pots are lost annually in North Carolina waters (Table 16; 5). Degradable panels disarm gear once lost. This allows organisms which enter derelict pots the ability to leave the trap. Many escape mechanisms rely on hinges or degradable attachments which may fail due to biofouling of the points which hold the panel in place.

During 2002-2005, three different tests were conducted by NCDMF simultaneously in four areas of coastal North Carolina with varying salinities to determine the static degradation of several natural twines and non-coated steel wire (6). Overall, there was a significant amount of variability in the time it took the different materials to degrade within, and between areas and tests. Although, none of the degradable materials had average break times within the critical four-week period when one-third of the annual ghost pot mortality occurred, based on static evaluations, several potentially promising degradable materials were identified for continued testing by commercial crabbers. Additional testing was suggested due to failure rates during deployment and retrieval activities. Table 4.2.6 is an overview of the five test crab pot arrays

with varying minimum, maximum, and average break times for each degradable material. Throughout the study, panels functioned better than lid straps. Other states require degradable panels (Appendix 3), which were instituted in part based on the NCDMF 2008 study. This was a complex study with both fishery-independent and fishery-dependent components to the testing, occurring in a variety of environments and salinity regimes.

Table 4.2.6. Minimum, maximum, and average days to break for each degradable material/escapement device, material/device repair time, and percentage of lost catch for functional escapement devices for the commercial crab pot field evaluation in North Carolina, 2005 (6).

Degradable material/escapement device	Total Pots	Material – days to break				Repair Time (minutes)	Percent loss of catch (when device functioned properly)			
		Number of Pots with Breaks*	Avg.	Min.	Max.		Number of Pots with Breaks*	Avg.	Min.	Max.
Lid straps										
Sisal (light)-Lehigh #390/Lid strap	15	11	28	4	58	1.25-10	2	80	80	80
Sisal (heavy) 5/64-inch Cordemex/Lid strap	20	4	76	10	130	1-3	2	67	33	100
Jute (light)-Lehigh #530/Lid Strap	20	11	30	9	72	1-5	5	50	0	100
Jute (heavy) 9/64-inch Winne/Lid strap	15	5	41	25	73	2.25-10	0			
Cotton .062-inch/Lid strap	105	23	37	2	87	1-10	4	79	50	100
Escape panels										
Sisal (light)-Lehigh #390/Panel	30	13	41	5	106	1.25-10	2	100	100	100
Sisal (heavy) 5/64-inch Cordemex/Panel	40	12	50	2	117	1-5	11	97	67	100
Jute (light)-Lehigh #530/Panel	40	21	35	9	165	2-4	15	83	0	100
Jute (heavy) 9/64-inch Winne/Panel	30	14	46	22	107	2.25-10	7	100	100	100
Cotton .062-inch/Panel	35	2	73	72	73	No data	1	100	100	100
Hog Ring 14ga./Panel	35	None								

*Material – days to break, number of pots with breaks is the number of total pots where the material broke. Percent loss of catch, number of pots with breaks is the number of material – days to break, number of pots with breaks where the escape device performed properly (e.g., of 15 pots where light sisal was use, 11 pots had the sisal break and 2 of those 11 pots had the escape device open).

A newer technology has been tested recently in the Chesapeake Bay. Researchers from the Center for Coastal Resources Management, Virginia Institute of Marine Science, College of William & Mary tested polyhydroxyalkanoate (PHA) as a material of choice for biodegradable escape panels. Polyhydroxyalkanoates, unlike plastics or metals, are completely biodegradable

by microbes as they are naturally occurring biopolyesters produced by bacteria and used to store energy (7). The PHA break down completely to biomass, water, carbon dioxide, and natural monomers. Panels constructed with PHA have a high certainty of degrading, thus providing an opening the size of the funnel mouth for escapement. To reduce cost, the panel is fabricated to include a cull ring opening as part of the panel (Figure 4.2.3). A blue crab biopanel costs \$1.50 each, replacing the \$0.25 cull ring. With regular fishing, PHA panel life is extended as UV light inhibits or delays microbe growth, reaching 20 percent loss threshold at about 330 days (8). Although, PHA panels do not degrade within the critical four-week period when one-third of the annual ghost pot mortality occurred, a single panel will degrade 20% within 90 days and reach 40% degraded material (point at which failure is considered) in 180 days (8).



Figure 4.2.3. Polyhydroxyalkanoate biodegradable panel with cull ring and attachment points.

Crab Trawl Tailbag Mesh Size

Existing NCMFC rule requires a minimum stretched mesh of 3-inches for crab trawls for taking hard crabs, except that the Director may, by proclamation, increase the minimum mesh length to no more than 4-inches [15A NCAC 03L .0202 (b)]. Increasing the minimum mesh length of crab trawls in areas not currently under proclamation authority would further reduce catch and mortality of sublegal crab bycatch. In 1992, the NCDMF conducted a study to examine the culling ability of larger tail bag sizes in crab trawls, the number of sublegal blue crabs was reduced by 13% in the 4-inch tail bag and the number of legal crabs was reduced by 7%, as compared to catches in a 3-inch tail bag (Table 4.2.7; 9). Overall survival rates were documented for trawl-caught crabs at 64%, while 93% of the crab pot caught crabs survived (Figure 4.2.4; 10). During a trip in June, a large number of paper shell and soft crabs were killed in the trawling process. Given the high percentage of sublegal blue crabs being captured by the crab trawl fishery, it was recommended that an increase in the minimum tail bag mesh size should be implemented to reduce fishing mortality on this species (9). A reduction of fishing mortality on sublegal crabs should allow more individuals to be available to spawn at a future date. Figure 4.2.5 shows the current boundary for 3-inch and 4-inch crab trawls. Selecting this option would extend the 4-inch minimum mesh size for crab trawls statewide. Increasing the mesh size stateside, based on NCDMF commercial fish house sampling, would impact 84% of fishermen landing crabs from trawl gear.

Table 4.2.7. Total and mean catch weights (kg) of blue crabs for control (3-inch) and experimental (4-inch) tailbags tested in the rivers of western Pamlico Sound, North Carolina, 1991-1992. Table from 9.

Common name	Total		Percent Difference	Mean		t value
	3-inch	4-inch		3-inch	4-inch	
Total	305.71	268.36	-12.22	9.86	8.66	1.12
Male	74.00	76	2.70	2.39	2.45	0.51
Immature female	45.00	38.55	-14.33	1.45	1.24	0.57
Female	92.00	86.75	-5.71	2.97	2.80	0.27

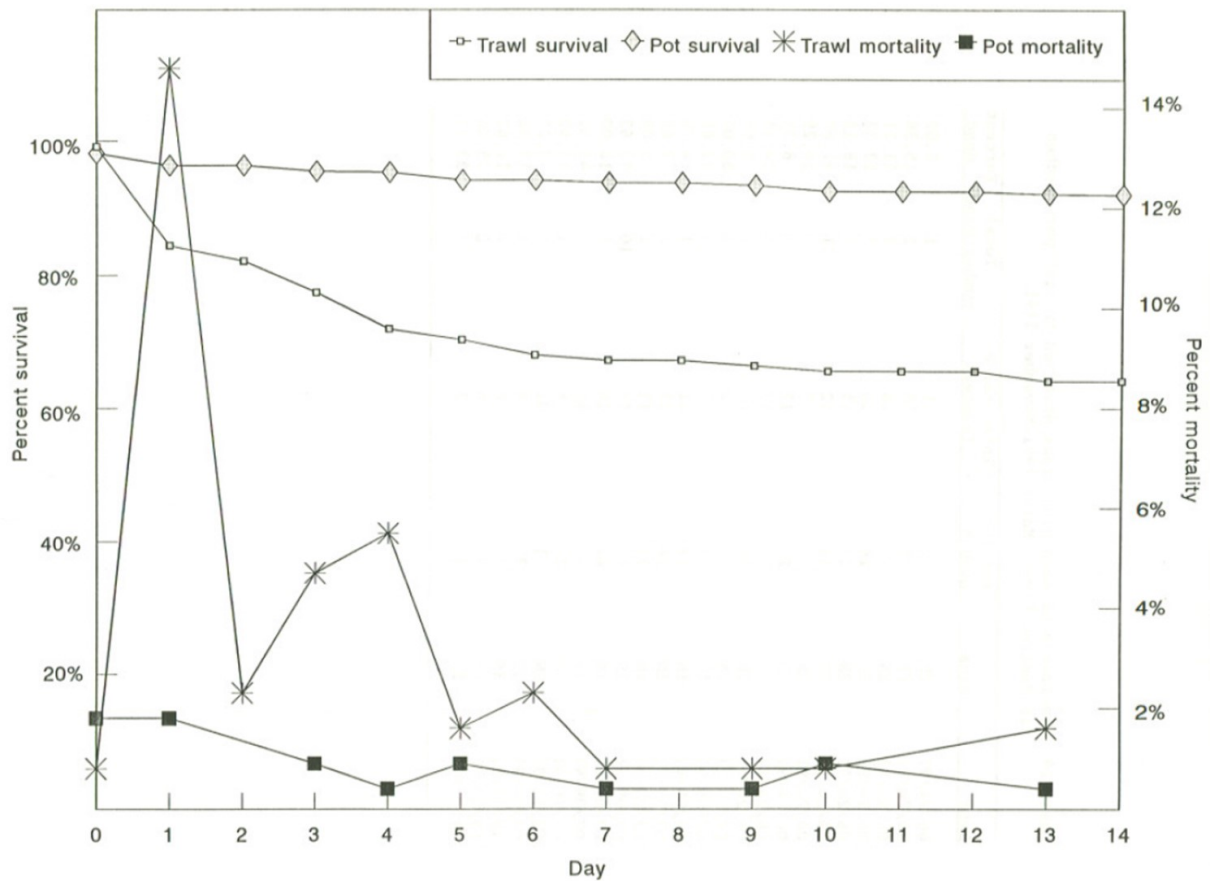


Figure 4.2.4. Cumulative survival rates and daily mortality rates for pot and trawl caught crabs from the Pamlico and Pungo rivers, November 1990-November 1991. High trawl mortality in day 1 is believed to be due to a fish kill in the area a few days before the study began.

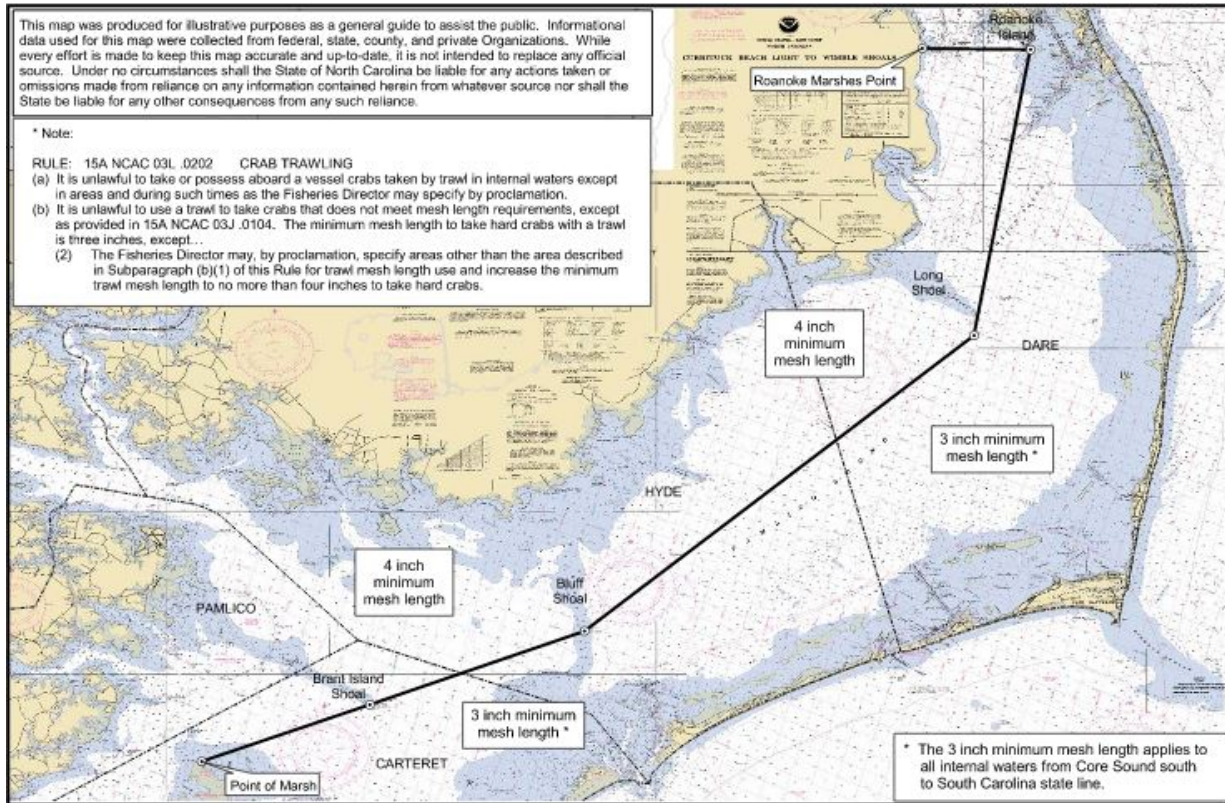


Figure 4.2.5. Current 3-inch and 4-inch crab trawl minimum mesh size boundary in Pamlico Sound.

Limit the Harvest of Sponge Crabs

Sponge crabs are present year-round, however, they begin to appear in significant numbers in March, peaking in May, and persist in lower levels through the summer (Figure 4.2.6). In 2014, the May peak in sponge crabs sampled was greatly evident with 60% of annual sampling occurring in that month. Based on NCDMF fish house sampling, 82% of sponge crabs sampled were from Pamlico Sound 2011-2016 (Table 4.2.8). Often these sponge crab sampling peaks can occur earlier or later in the year than the average May peak. The peak sampling in 2017 was earlier in the season, occurring in March. While in 2011, sampling was evenly distributed wholly between April and July. Prohibition of sponge crab harvest would give mature females the opportunity to spawn and possibly spawn more than once prior to being harvested.

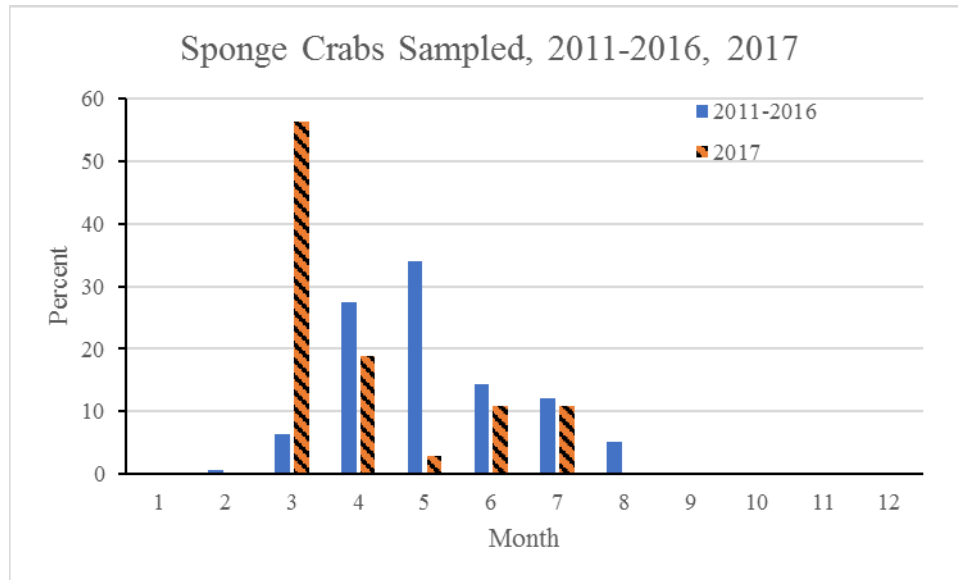


Figure 4.2.6. Average monthly sponge crab frequency in commercial crab sampling, 2011 – 2016, 2017 (2011-2016 n=2,963, 2017 n=571).

A sponge crab closure may be used to restrict harvest during certain times of the year and to reduce removals from the stock and possibly increase recruitment. Since effort can be increased during the open periods of the fishery to offset losses during the closed season, it is best to have seasonal closures that are a minimum of two weeks, but preferably longer. Timing of harvest from the different crab fisheries should also be considered. Since June 6, 2016, dark sponge crabs (brown and black) were prohibited from harvest April 1-April 30. This prohibition has had minimal effect due to the limited duration and specification of sponge color. Additionally, limiting to only dark sponge crabs leads to enforcement complications.

Table 4.2.8. Percent of sampled (2011-2017) sponge crabs by area from NCDMF commercial fish house sampling.

Area	Year	
	2011-2016	2017
Albemarle	< 0.5%	0%
Pamlico	82.0%	62%
Southern	17.5%	38%

Fishing gear interactions may negatively affect blue crab spawning potential. Dickinson et al. (11) reported the majority of sponge crabs caught in pots in the Newport and North rivers of North Carolina had damage to 30-50% of the egg mass. A significantly greater proportion of egg mass damage has been observed of sponge crabs in areas where pots were set as opposed to hand fishing regions of North Carolina (12). Damage may have been from the gear, capture stress, or interactions with other crabs while in pots. Survival of sponge crabs after pot interactions was not affected by sponge damage, however, the likelihood of crabs producing a second clutch was significantly related to previous sponge damage levels (12). Fewer high-damage crabs survived to produce a second clutch (6% reduction). Therefore, an early season closure of the fishery may

increase spawning potential of mature females by reducing stress on mature females and reducing damage to egg masses. Removing pots from the water would not only ensure spawning but may also increase future spawning potential of mature females likely to produce multiple clutches.

Size Limit for Peeler and Soft Crabs

Increased effort and harvest in the peeler/soft blue crab fishery and reduced adult harvest has prompted concern about the impacts of peeler/soft crab harvest on the overall health of the fishery. Mature females, peeler, and soft crabs are exempt from the 5-inch minimum size limit for hard crabs [NCMFC Rule 15A NCAC 03L .0201]. Establishing a minimum size limit for peeler and soft crabs would reduce fishing mortality on the smallest crabs allowed for harvest. Short-term effects of establishing a size limit would be reducing the blue crabs available for harvest, which in turn would decrease the overall harvest. Decreasing harvest should have an effect on reducing fishing mortality. In addition, current peeler fishing practice is to employ live male crabs as an attractant or bait to target immature female peelers. Therefore, the majority of peelers harvested are immature females approaching their terminal molt. Reducing fishing mortality on this segment of the population would contribute to efforts to protect the female spawning stock. Establishing a size limit could have a negative impact on the market by reducing the number of blue crabs available for purchase. However, this may be temporary protection as recouplement may occur in the fishery as crabs grow.

Natural mortality of sublegal crabs (less than five inches) is in the range of 26 - 32% per year in the Chesapeake Bay (13). Eggleston (14) estimated an annual mortality rate of 50% for sub-adult and adult blue crabs in North Carolina. Several other states have minimum size limit restrictions for peeler and/or soft crab harvest (Appendix 4.3). A Maryland report noted that raising the peeler size limit would potentially provide an increase in spawning stock biomass by allowing more females to enter the spawning population (15). Raising the size limit should also increase yield to the fishery. Peeler size limits could possibly improve recruit abundance by allowing some immature female crabs to mature and spawn prior to being subject to harvest.

As the time between sheds increases with increasing size, the probability of capture of larger crabs at the peeler stage decreases. The time interval between sheds of 3.0 or 3.5-inch crabs will generally be one to three months (16). The increased yield from a peeler size limit would not be totally lost to natural mortality. The overall value of the peeler/soft crab fishery might be enhanced by a minimum size limit as larger soft crabs generally bring a higher price. A potential adverse impact on the soft crab fishery would be a decrease in market flexibility, particularly during the early spring when product availability is low and small peeler/soft crabs are in demand, bringing very high prices to fishermen. A peeler size limit may increase handling mortality and waste in the fishery. A peeler/soft crab size limit could allow more effective and efficient enforcement of size limits, both in state and out of state as crabs are shipped to states with existing size limits. Therefore, adopting a peeler and soft crab minimum size limit of 3 inches at the point of harvest would address regulatory consistency among the Atlantic Coast states and potentially foster interstate trade.

NCDMF collects size, sex, and maturity (female) information on peeler crabs harvested for commercial shedding operations (Figure 4.2.7). Sample sizes decline considerably when summarized at a waterbody level and thus, only regional and statewide estimates are provided. Assuming no cull tolerance for sublegal peeler crabs, several minimum size limit options were examined in ¼-inch increments of peelers sampled from 2011 to 2017 (Table 4.2.9). For example, if a 3 ¼-inch minimum size limit was imposed on peeler crab harvest, 4.8% of peeler crabs statewide fell into the size classes below this minimum size. The Pamlico region would be the most impacted by the minimum 3 ¼-inch size limit at 7.3% followed by the Albemarle region at 3.2% and the Southern region at 2.1%.

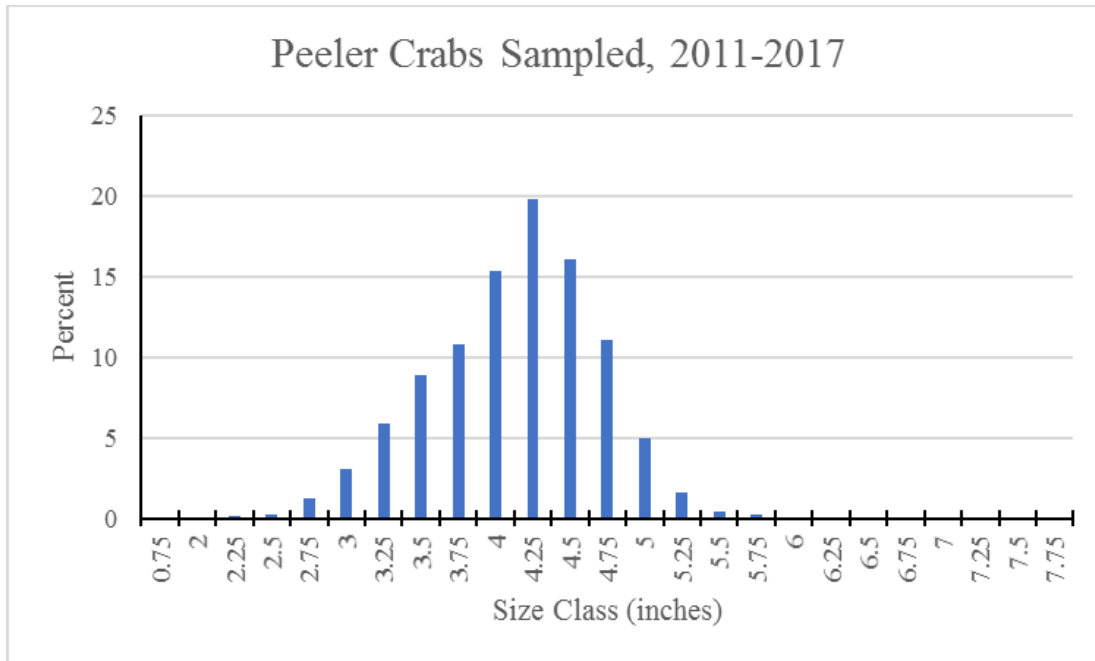


Figure 4.2.7. Average peeler/soft crab size frequency in commercial crab sampling, 2005 – 2017. n=17,708

Table 4.2.9. Estimated harvest reduction percentage (pounds) for various minimum size limits for peeler crabs.

Minimum Size Limit	Peeler Size Limit Reduction Percent			
	Albemarle	Pamlico	Southern	Statewide
3-inch	1.1%	2.8%	0%	1.8%
3 ¼-inch	3.2%	7.3%	2.1%	4.8%
3 ½-inch	6.9%	15.3%	4.1%	10.2%
3 ¾-inch	13.4%	28.2%	10.3%	19.2%

Effort Control

Limiting pots have been discussed since the 1950s. Pot limits are a method of managing effort and improving economic efficiency in the crab pot fishery. The only existing crab pot limit in

North Carolina is a 150 pot per vessel limit in Newport River. This limit was requested by the Newport River crab potters due to gear conflict and has been in existence since 1985. In 1998 after the Blue Crab FMP was adopted, the NCMFC convened a Regional Stakeholder Advisory Committee to draft an open access plan for the crab pot fishery with discussions including pot limits (17). A considerable amount of time and effort was spent in developing a permit, regional pot limit criteria, and a pot tagging system for enforcement. Consensus could not be reached on an appropriate effort management plan for the blue crab fishery. The NCMFC in 2000 did not implement any aspect of the proposed regional effort management strategy for the crab pot fishery.

The Regional Stakeholder Advisory Committee did not expect effort to increase significantly in the future. While participation has been consistent over time, a marked increase in crab pots occurred in the North Carolina hard crab fishery from 2007 – 2016 (Table 12 Description of the Fishery section). Additionally, the CPUE has remained constant over this time.

Instead of imposing pot limits, restricting to a daily pot fishing time period (e.g., 6 a.m. until 2 p.m.) could potentially reduce the overall amount of gear used and harvest. However, time limits would significantly impact or eliminate fishermen who work other jobs and fish pots after work. Also, problems would develop when full-time fishermen work in tidal areas, generally in the southern region of the state. Such problems as the latter could potentially be addressed through regional management. Many fish houses already restrict fishing times of their crabbers to ensure product is ready for transportation.

Summary of Management Options

Several different management measures are presented in Table 4.2.10. Since projected reductions are not possible for these measures, general effects on landings and economic impacts are presented.

Table 4.2.10. Possible effects to hard crab landings and financial effects on crabbers for each type of management measure.

Management Measure	Effects on Landings	Economic Impact
Increase Cull Ring Size	Neutral	Cost to purchase for all pots Less cull time requires less time on the water and fuel usage
Number of Cull Rings	Neutral	Cost to purchase for all pots Less cull time requires less time on the water and fuel usage
Specify Placement of Cull Rings	Neutral	Cost to add or move cull ring
Remove Cull Ring Exemption	Neutral	Cost to add cull rings
Require Degradable Panel	Neutral	Cost to purchase for all pots Annual cost Replaces need for one cull ring
Increase Tailbag Mesh Size	Minimal reduction in landings	Cost to purchase new tailbag
Limit the Harvest of Sponge Crabs	Reduced landings for limited time Recoupment of catch after eggs shed	Loss of profits
Peeler/Soft Crab Minimum Size Limit	Reduced landings for limited time Recoupment of catch	Loss of profits
Impose Crab Pot Limit	Reduced landings for limited time Recoupment of catch	Loss of profits
Impose Fishing Time Restrictions	Reduced landings for limited time Recoupment of catch	Loss of profits Reduced fuel and gear usage Unfairly impacted crabbers with secondary job

VI. MANAGEMENT OPTIONS

(+ Potential positive impact of action)

(- Potential negative impact of action)

1. Increase cull ring size in pots

- a. Increase cull ring size to 2 3/8 inches
- b. Increase cull ring size to 2 7/16 inches

+Increase escapement of juvenile crabs

+May increase juvenile recruitment

-Decrease harvest with economic loss to the fishery

-Some regions may be impacted more than others

-Additional cost to fishermen to make gear modifications

2. Number of cull rings in pots

- a. Increase the number of cull rings in pots to 3 (in effect through 2016 Revision to Amendment 2)
- b. Increase the number of cull rings in pots to 4
- c. Decrease the number of cull rings in pots to 2 (in effect prior to 2016 Revision to Amendment 2)

+Increase escapement of juvenile crabs

+May increase juvenile recruitment

- Decrease harvest with economic loss to the fishery
- Some regions may be impacted more than others
- Additional cost to fishermen to make gear modifications

3. Specify placement of individual cull rings in pots

- a. Require one cull ring to be placed within one full mesh of the corner and the apron in the upper chamber of the pot (in effect through 2016 Revision to Amendment 2)
- b. Require two cull rings to be placed within one full mesh of the corner and the apron of the pot located on opposite outside panels of the upper chamber of the pot

- +Increase escapement of juvenile crabs
- +May increase juvenile recruitment
- Decrease harvest with economic loss to the fishery
- Some regions may be impacted more than others
- Additional cost to fishermen to make gear modifications

4. Remove cull ring exemptions to reduce sublegal crabs retained in pots

- a. Remove the cull ring exemption in the Newport River
- b. Remove the cull ring exemption in eastern Pamlico Sound
- c. Remove the cull ring exemptions in the Newport River and eastern Pamlico Sound
- d. Remove the permanent cull ring exemption in rule and replace with proclamation authority to allow the exemption for the Newport River and eastern Pamlico Sound areas (as defined in rule) based on certain criteria. Specific criteria and resultant rule change will be developed in conjunction with the Shellfish/Crustacean AC after the adoption of Amendment 3.

- +Increase escapement of juvenile crabs
- +May increase juvenile recruitment
- Decrease harvest with economic loss to the fishery
- Some regions may be impacted more than others
- Additional cost to fishermen to make gear modifications

5. Require degradable panels in crab pots to disarm derelict gear

- +Increase escapement of juvenile crabs
- +Increase escapement of bycatch species
- +Disarm abandoned or derelict gear
- +Reduce waste from abandoned or derelict gear
- Additional cost to fishermen to install and replace panels
- Possible loss of legal catch due to premature failure of panels

6. Increase crab trawl tailbag mesh size to 4-inches statewide

- +Increase escapement of juvenile crabs
- +Increase escapement of bycatch species
- Some regions may be impacted more than others
- Additional cost to fishermen to make gear modifications

7. Limit the harvest of sponge crabs

- a. Prohibit harvest of dark sponge crabs from April 1 through April 30 (in effect through 2016 Revision to Amendment 2)
- b. Prohibit harvest of all sponge crabs from January 1 through May 31
- c. Prohibit harvest of all sponge crabs year-round

+Increase spawning potential

+May increase juvenile recruitment

-Some regions may be impacted more than others

-Decrease harvest with economic loss to the fishery

-Increase pressure on other harvest segments (males, immature females, peelers)

-Increase discards where sponge crabs may still be incidentally caught

8. Peeler and soft crab minimum size limit at the point of harvest

- a. Establish 3-inch minimum size limit for peeler and soft crabs at the point of harvest
- b. Establish a 3 1/4-inch minimum size limit for peeler and soft crabs at the point of harvest

harvest

+May increase spawning potential

+May increase juvenile recruitment

-Decrease harvest with economic loss to the fishery

-Some regions may be impacted more than others

-Increase discards in the peeler/soft crab fishery

-May increase discard mortality in the peeler/soft crab fishery

9. Impose a limit on the number of crab pots used

+Reduce gear in the water

+May reduce derelict gear

+Decrease cost to fishermen

+Possible increase in CPUE with economic benefit to the fishery

-Increases marine patrol duties

-Some regions may be impacted more than others

-Possible decreased harvest with economic loss to the fishery

-Difficulty implementing a monitoring system

-Administration would be cumbersome and costly

-Previous efforts to establish pot limits were unsuccessful

10. Impose a fishing time restriction

+May decrease the amount of gear fished

+Aid marine patrol

-Unfairly impact part-time crabbers

-Increase number of unattended pots

-Unfairly impact crabbers in tidal waters

VII. RECOMMENDATIONS

NCMFC Selected Management Strategy

- Option 2a: increase number of cull rings in pots to 3

- Option 3a: one cull ring placed within one full mesh of the corner and the apron in the upper chamber of the pot
- Option 4c: remove cull ring exemptions for Newport River and eastern Pamlico Sound and prohibit designation of exempt areas in future
- Option 7a: prohibit harvest of dark sponge crabs from April 1 through April 30

VIII. LITERATURE CITED

1. NCDMF. 2018. Stock assessment of the North Carolina blue crab (*Callinectes sapidus*), 1995–2016. North Carolina Division of Marine Fisheries, NCDMF SAP-SAR-2018-02, Morehead City, North Carolina. 144 p. NCDEQ (North Carolina Department of Environmental Quality). 2016. North Carolina Coastal Habitat Protection Plan Source Document. Morehead City, NC. Division of Marine Fisheries. 475 p.
2. Rudershausen P.J. and Marc J. Turano. 2009. The Effect of Cull Rings on Catch Rates of Blue Crabs *Callinectes sapidus* in the North Carolina Trap Fishery, *North American Journal of Fisheries Management*, 29(4): 1152-1164.
3. Rudershausen P. J. and Joseph E. Hightower. 2016. Retention Probability Varies with Cull Ring Size in Traps Fished for Blue Crab, *North American Journal of Fisheries Management*, 36(1): 122-130.
4. Havens, K. J., D. M. Bilkovic, D. Stanhope, and K. Angstadt. 2009. Location, location, location: the importance of cull ring placement in blue crab traps. *Transactions of the American Fisheries Society*. 138: 720 – 724.
5. NCDMF. 2013. North Carolina Blue Crab Fishery Management Plan Amendment 2. North Carolina Department of Environment and Natural Resources, Division of Marine Fisheries. Morehead City, NC. 528 p.
6. NCDMF. 2008. Assess the effects of hurricanes on North Carolina’s blue crab resource. North Carolina Department of Environment and Natural Resources. North Carolina Division of Marine Fisheries. Morehead City, NC. 176 p.
7. Bilkovic D.M., K.J. Havens, D.M. Stanhope, and K.T. Angstadt 2012 Use of Fully Biodegradable Panels to Reduce Derelict Pot Threats to Marine Fauna. *Conservation Biology* Volume 26, No. 6, 957–966
8. Havens Kirk J., Donna Marie Bilkovic, David M. Stanhope, and Kory T. Angstadt; Assignee College of William and Mary, Crustacean Trap with Degradable Cull Ring Panel US Patent US 2012/0144722 A, Filed February 28, 2008, and issued June 14, 2012
9. McKenna, S., and A.H. Clark. 1993. An examination of alternative fishing devices for the estuarine shrimp and crab trawl fisheries. Albemarle-Pamlico Estuarine Study Rep. No. 93-11. 34 p.
10. McKenna, S., and J. T. Camp. 1992. An examination of the blue crab fishery in the Pamlico River estuary. Albemarle-Pamlico Estuarine Study Rep. No. 92-08. 101 p.
11. Dickinson, G. H., D. Rittschof, and C. Latanich. 2006. Spawning biology of the blue crab, *Callinectes sapidus*, in North Carolina. *Bulletin of Marine Science* 79:273– 285.
12. Darnell M. Zachary, Kelly M. Darnell, Ruth E. McDowell, and Dan Rittschof 2010 Postcapture Survival and Future Reproductive Potential of Ovigerous Blue Crabs *Callinectes sapidus* Caught in the Central North Carolina Pot Fishery *Transactions of the American Fisheries Society* 139:1677–1687
13. Casey, J.F., B. Daugherty, G. Davis, and J.H. Uphoff. 1992. Stock assessment of the blue

crab in Chesapeake Bay, 1 July 1990 - 30 September 1991. Maryland Department of Natural Resources, Annapolis, Maryland.

14. Eggleston, D.B. 1998. Population dynamics of the blue crab in North Carolina: statistical analyses of fisheries survey data. Final report for Contract M-6053 to the NC Department of Environment, Health and Natural Resources, Division of Marine Fisheries. 66p.
15. Uphoff, J., J.F. Casey, B. Daugherty, and G. Davis. 1993. Maryland's blue crab peeler and soft crab fishery: problems, concerns, and solutions. Tidal Fisheries Technical Report Series, No. 9. Maryland Dept. of Natural Resources, Annapolis, Maryland.
16. Rothschild, B.J., J.S. Ault, E.V. Patrick, S.G. Smith, H. Li, T. Maurer, B. Daugherty, G. Davis, C.H. Zhang, and R.N. McGarvey. 1992. Assessment of the Chesapeake Bay blue crab stock. University of Maryland, Chesapeake Biological Laboratory, CB92-003-036, CEES 07-4-30307, Solomans, Maryland.
17. NCDMF. 2004. North Carolina Fishery Management Plan Blue Crab. North Carolina Department of Environment and Natural Resources. North Carolina Division of Marine Fisheries. Morehead City, NC. 411 p.

APPENDIX 4.3: ADDRESSING WATER QUALITY CONCERNS IMPACTING THE NORTH CAROLINA BLUE CRAB STOCK

I. ISSUE

Water quality plays an important role in blue crab life history. Improving water quality by addressing pollution sources, especially agricultural runoff, may positively impact the North Carolina blue crab stock.

II. ORIGINATION

North Carolina Division of Marine Fisheries (NCDMF).

III. BACKGROUND

Growth and survival of blue crabs is maximized when water quality parameters, such as temperature, salinity, and oxygen, are within optimal ranges. These parameters have been identified by life stage in the biological profile and ecosystem impact on the fishery sections (Ecosystem Impact on the Fishery section). When conditions are outside the suitable range for extended periods or environmental parameters rapidly change, blue crabs can be adversely impacted. North Carolina contains the largest estuarine system of any single Atlantic coast state, with numerous estuarine rivers, creeks, sounds, inlets, and ocean bays creating a diverse system of over 2.3 million acres in size. The Albemarle-Pamlico system is the third largest estuarine complex in North America and the second largest in area in the United States (1). The estuarine water sheds' land area is divided between the Coastal Plain and Piedmont physiographic regions, with the majority of land in the Coastal Plain. Large freshwater influx from rain events or hurricanes and long flushing times of the Albemarle-Pamlico system are related to the major environmental stresses facing benthic communities in these areas (2; 3; 1).

Mortality of blue crabs has been observed from exposure to toxins such as the mosquito abatement chemical piperonyl butoxide (4) and industrial biproduct dioxin (5). Bell et al (6) reported adult blue crab survival declined with increased exposure to hypoxia (low dissolved oxygen). After 30 hours, survival markedly declined with 84.4 percent, 54.8 percent, and 3.1 percent surviving low dissolved oxygen (DO) treatments of 1.5 mg L⁻¹, 1.0 mg L⁻¹, and 0.5 mg L⁻¹, respectively. Additionally, movement and burial diminished, however, crabs in chronically hypoxic waterbodies were able to sustain activity longer than those from other waterbodies. Crabbing productivity is reduced in tributaries with average DO concentration less than 5 mg L⁻¹ (7). One cause of hypoxia is blue-green algae blooms. Garcia et al (8) confirmed microcystins, toxic blue-green algae which may be harmful to humans, may occur in blue crab tissue samples.

As land use changed ≥ 12.8 percent in North Carolina catchments, blue crab catch per trawl declined on average 0.4 crabs per trawl (9). This is opposed to a 0.8 crabs per trawl increase in unaltered catchments. All altered lands can contribute to water quality degradation. Much of the land around the Albemarle-Pamlico Estuarine System, which accounts for the largest amount of blue crab harvest, has been drained to accommodate agriculture and silviculture (Figure 1).

Agricultural lands include cropland, pastureland, animal operations, and land-based aquaculture. Sowing fields, spraying to protect from pests, preparing crops for harvest, and harvesting activities can all impact water quality in ways that may be harmful to blue crabs. This issue paper will focus on water quality impacts from agriculture and potential management measures. Protecting the waters from impacts of agriculture is promoted through natural resource management with assistance from the North Carolina Department of Agriculture and Consumer Services' Division of Soil & Water Conservation (NCDA&CS S&WC). It is estimated that over two million acres have been drained and developed for agriculture and silviculture along the North Carolina coast. Within each square mile of agricultural land in coastal North Carolina, there are estimated to be more than 20 miles of ditches and canals leading to downstream systems (10; 11).

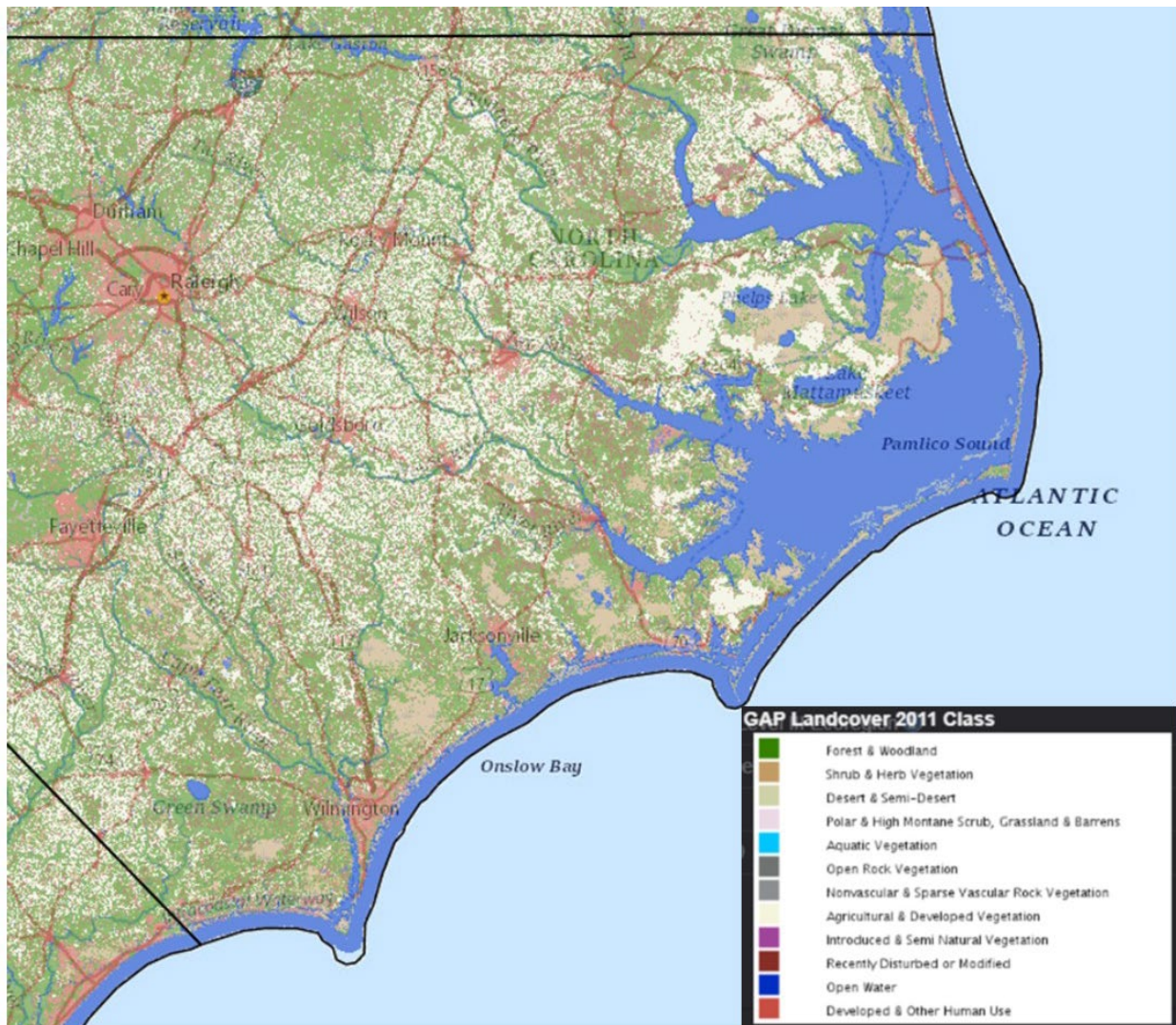


Figure 4.3.1: Land cover types within eastern North Carolina based on USGS GAP land cover data.

Negative environmental impacts due to agriculture include pollution from nutrients, eroded soils, and pesticides. Nationally, northern North Carolina coastal watersheds have ranked in the top 10 percent for nitrogen loading from commercial fertilizer applications and rank near the top as measured by potential threats to human drinking water supplies, fish, and aquatic life due to pesticide leaching and runoff (12; 13). Agricultural land in the Neuse River Basin contributed 55 percent of the total annual nonpoint source nitrogen loading post rain event (14). Toxic chemical contamination is not evaluated by North Carolina Division of Water Resources (NCDWR) in estuarine and nearshore ocean waters. Current standards do not eliminate the risk from toxins since: (1) safe levels are not established for many toxic chemicals; (2) mixtures and breakdown products are not considered; (3) effects of seasonal exposure to high concentrations have not been evaluated; and (4) some potential effects, such as endocrine disruption and unique responses of sensitive species, have not yet been assessed.

Nutrient rich environments, poor flushing, abundant fish communities, and brackish salinities are known to promote toxic algal growth (15;16). Outbreaks of the toxic dinoflagellate *Pfiesteria* occurred in the 1990s in the Neuse, Pamlico, and New River estuaries, which are characterized as shallow, poorly flushed systems (17; 18; 15; 19). Nuisance algal blooms began to occur more often post 1970 and continue to occur regularly in the lower reaches of the Chowan and Neuse rivers (20; 21; 22; 3). Algal blooms are often associated with periods of low DO.

Hypoxia, low DO, is often due to eutrophication (excessive nutrients). Hypoxic events can influence distribution and abundance of blue crabs. In NOAA's 2013 2nd National Habitat Assessment Workshop, it was stated that habitat compression due to low DO may be associated with a 10-50 percent worldwide decline of pelagic predator diversity (23). In North Carolina in 2018, low DO was the cause of 15 of 21 reported fish kills statewide, resulting in mortality of 117,790 individuals (24). Other reported causes include spills and other/unknown causes.

Negative environmental factors affecting blue crab will likely be exacerbated by climate change. Climate change is likely to impact our coastal systems through episodes of extreme weather events which may increase runoff, flooding, and irrigation needs. These impacts can reduce water quality and damage infrastructure in place to transport water on and off the land (25). Warmer temperatures, wetter climates, and increased CO₂ will allow many weeds and pests to thrive, increasing the need for herbicides and pesticides over crops. Bottom temperatures above 25°C are directly correlated to declines on average of 0.6 crabs per trawl catch of blue crabs (9). Heavy episodic rains can increase runoff into receiving surface waters introducing sediment, nutrients, pollutants, animal waste, and other materials making water unusable and in need of water treatment. Conversely, rising sea level and drought can cause coastal waters to become more saline. Higher salinity and water temperature can facilitate the spread of disease through the blue crab stock and alter the life cycle.

On August 14, 1997, Governor James B. Hunt, Jr., signed the Fisheries Reform Act (FRA) into law. The legislation's foremost goal was to ensure healthy fish stocks, the recovery of depleted stocks, and the wise use of fisheries resources. The FRA (G.S. 143B-279.8) requires preparation of Fishery Management Plans (FMPs) by the NCDMF and Coastal Habitat Protection Plans (CHPPs) by Department of Environmental Quality (NCDEQ). The legislative goal of the CHPP is "...the long-term enhancement of coastal fisheries associated with coastal habitats." The law

specifies the CHPP identify threats and recommend management actions to protect and restore habitats (and water quality) critical to North Carolina's coastal fishery resources. The plans must be adopted by the Coastal Resources (NCCRC), the Environmental Management (NCEMC), and the Marine Fisheries (NCMFC) commissions, to ensure consistency among commissions, as well as their supporting NCDEQ agencies (26).

While the NCMFC manages fishing practices in coastal waters through rules implemented by the NCDMF, several agencies manage activities affecting coastal fisheries and fish habitats. The EMC has authority over activities affecting water quality, such as point and nonpoint discharges (i.e., agricultural runoff, wastewater, and stormwater) and alteration of wetlands. The EMC's rules are implemented by different NCDEQ agencies, including the North Carolina Division of Water Resources (NCDWR), the North Carolina Division of Air Quality (NCDAQ), and the North Carolina Division of Energy, Mineral, and Land Resources (NCDEMLR). The NCDEMLR administers rules adopted by multiple regulatory commissions, including the NCEMC, North Carolina Sedimentation Control Commission (NCSCC), and the North Carolina Mining and Energy Commission. The NCCRC enacts rules to manage development within and adjacent to public trust and estuarine waters, coastal marshes, and the ocean hazard area. The North Carolina Division of Coastal Management (NCDCM) implements rules adopted by the CRC. The North Carolina Wildlife Resources Commission (NCWRC), while not a principle participant in the CHPP process, has a direct role in the management of fisheries and habitat through the designation of Primary Nursery Areas (PNAs) and Anadromous Fish Spawning Areas (AFSAs) in Inland Waters, the review of development permits, monitoring and management of habitat, and the regulation of fishing in inland waters. There is a myriad of other state, federal, and interstate programs that directly or indirectly influence coastal fisheries habitat in North Carolina.

Surface waters of North Carolina are assessed regularly by NCDWR. These data are used to develop use support ratings biennially and reported to the U.S. EPA. The Integrated Report (IR) to Congress regarding the quality of our nation's waters is a compilation of reports of Sections 303d, 305b, and 314 of the Clean Water Act for the 50 states, 5 inhabited territories, and the District of Columbia. Impaired waters are reported on the 303(d) list. A map of the 2018 impaired waters is available from the NCDWR website as [2018 impaired waters map](#). DWR monitoring stations within the overall CHPP management unit include approximately 256 ambient stations, 76 fish community sample sites, and 245 benthic macroinvertebrate sample sites. Other water quality monitoring in the CHPP region includes: 22 Albemarle-Pamlico National Estuary Program (APNEP) Citizen's Monitoring Stations, USGS special study investigations, and NCDMF fish sampling programs.

IV. AUTHORITY

North Carolina General Statutes

113-134 RULES

113-182 REGULATION OF FISHING AND FISHERIES

113-182.1 FISHERY MANAGEMENT PLANS

143B-289.52 MARINE FISHERIES COMMISSION – POWERS AND DUTIES

143B-279.8 COASTAL HABITAT PROTECTION PLANS

V. DISCUSSION

Pollutants can enter surface waters from point sources, such as waste-water treatment plants or industrial discharge, and nonpoint sources, including runoff from agricultural and developed land. Most pollutants in surface waters are the result of nonpoint source activities (27). Most nutrient pollution in the Albemarle and Pamlico systems has been linked to agriculture activities (28; 29; 30). Runoff can introduce sediments, nutrients, bacteria, organic wastes, toxins, and metals into surface waters. Due to the difficulty in controlling, measuring, and monitoring nonpoint sources, a combination of practices known as Best Management Practices are required or recommended to limit negative effects to the waterways. Best Management Practices on agricultural lands may include riparian buffers, erosion and sediment control, conservation tillage, nutrient management, and pest management plans.

High nutrient levels and low flushing rates increase a waterbody's susceptibility to hypoxia and subsequent fish kills (26). Several North Carolina estuarine environments are characterized by slow moving, poorly flushed waters with high levels of nutrients, offering ideal conditions for algae, fungi, and bacteria to thrive. Algal blooms produce large amounts of oxygen during photosynthesis and raise the pH by increasing hydroxide levels. When the water column becomes supersaturated with DO and has a high pH, this may mean a bloom is in progress. The DWR records algal blooms by measuring DO and pH, assuming a bloom is in progress when DO > 110 percent saturation or > 9.0 mg/L, and/or pH > 8.0 s.u. There were nine blooms in the Albemarle Sound during 2010-2014, usually comprised of blue-green algae. In that same period, the Neuse River had 32 blooms and Pamlico River had 76 blooms of a mixture of algae. The 33 blooms investigated in Calico Creek were mostly comprised of bottom-dwelling diatoms, while the 88 blooms in the New River were a mixture of algae types. Of the 27 blooms investigated in the Cape Fear River, 19 were the blue-green alga *Microcystis*. *Microcystis* is almost always toxic and can remain on shorelines in high concentrations for several months after blooms.

When algae begin to die and decay, DO levels can drop suddenly. Low DO (hypoxia) can cause sublethal stress or mortality in blue crabs. Sublethal stress may alter feeding and growth rates, behavior, and vulnerability to predators (31). Where blue crabs could not escape hypoxic waters, mortality occurred when oxygen levels were below 3.0 mg/L for one to three days; mortality occurred within three hours when DO was less than 0.5 mg/L (32). Hypoxic events have resulted in locally elevated mortality among crabs constrained by capture in pots in the Chowan, Neuse, and Pamlico river systems (33; T. Pratt, personal communications). Crab fishermen have indicated they move pots and alter fishing frequency during low oxygen events to avoid blue crabs dying in pots. Adjustments in fishing activity were based on changing environmental observations and catch rates (34).

NCDEQ has regulatory authority over waste management of swine and cattle feedlots that use dry systems and applications of a wastewater or liquid manure; these permitted facilities are inspected by NCDWR on an annual basis. Hog and cattle concentrated animal feeding operations discharging waste have NPDES permits, but there are no associated water quality monitoring requirements. The NCDWR Animal Feeding Operations Unit is responsible for permitting and

compliance activities of the ~1,980 permitted animal facilities located in the lower Cape Fear and Neuse River basins. Rothenberger et al. (30), modeling land use in the Neuse River, found that areas with high concentrations of confined swine feed operations were the greatest contributors of nitrogen and phosphorus to the lower Neuse. In 1995, a swine operation lagoon failure led to a spill of raw, concentrated effluent into a second-order segment of the New River, North Carolina. In 1996, Hurricane Fran led to ruptures, excessive overflows, and floodplain inundations of 22 animal-waste lagoons in North Carolina. Elevated chlorophyll-a levels were evident 2-weeks after the 1995 spill with a 100-fold higher blue-green algae community than 1994 densities (17). Chlorophyll-a averaged 110 $\mu\text{g/L}$ by July 5, 1995; substantially higher than the 1996 state acceptable water quality standard of $\leq 40 \mu\text{g chla/L}$. *Synechococcus* and other blue-green algae densities of 10^6 cells/mL and 10^8 cells/mL, respectively, were observed in July 1994 and July 1995. This included a bloom of *Phaeocystis flobosa*, a harmful blue-green species, with colony densities $>10^6$ cells/mL. Increases in algal levels can be a major contributor to low oxygen events.

Along with nutrients, pesticides and herbicides may be present in runoff waters. Toxicity of pesticides to blue crab vary greatly due to many factors including application practices, chemical persistence, dilution level, and developmental stage of the blue crab. Eggs and larvae are generally more sensitive to toxins than adult and juvenile life stages as they have more permeable membranes and less developed detoxifying systems (32; 35; 36). Chemical contaminants in the water and soft bottom can adversely impact blue crabs directly by causing mortality, or indirectly by altering endocrine related growth and reproductive processes. Acute toxicity of a variety of herbicides and pesticides to blue crab were determined by the U.S. EPA. These studies stated the presence of chemicals had a detrimental effect and increased mortality rates on larval and juvenile blue crabs, particularly after molting.

Many insecticides function as endocrine disrupters, affecting larval crab development to adult. Fipronil, introduced in 1996, is a commonly used pesticide to control fire ants, cockroaches, beetles, and termites as well as an active ingredient in pet flea and tick treatments. (37). Successful metamorphosis of larval mud crab, *Rhithropanopeus harrisi*, was shown to be negatively impacted by this type of insecticide (38).

Effects of the pesticide methoprene, a juvenile hormone analog often used for mosquito and flea control, was analyzed in juvenile and adult blue crabs (39). Treatment of megalopae with methoprene delayed successful molting to the first crab stage. After 10 days, 80 percent of treated larvae died as opposed to 25 percent of total larvae in control tanks.

Carbaryl (commercially sold as Sevin) and malathion, are commonly used in agriculture, poultry production, and mosquito abatement. Schroeder-Spain et al. (40) found all treatments of malathion and carbaryl significantly increase righting time (the time it took a crab to flip after being placed upside down) and eyestalk response in both juvenile and adult blue crabs, with malathion additionally decreasing survival time of adult blue crabs. Significant mortality was observed in adult blue crabs; however, reduced righting time and response rate to stimuli make all stages of crabs more susceptible to predation.

Osterberg et al. (41) conducted research on the toxicity of four commonly used insecticides to blue crab at different life stages (Table 1). Researchers calculated that pesticide overspray into shallow ditches and creeks approximately 0.2-0.4 m deep or less would have concentrations sufficient to kill more than 50 percent of juvenile blue crabs within the affected waters.

Table 4.3.1. Pesticide properties and blue crab lethal concentration required to kill 50% listed in order of decreasing toxicity. Commercial products and their active ingredients common use in North Carolina. (data from 41)

Compound	Use	Class	24 h LC ₅₀ (95% confidence interval) (µg/L)	
			Megalopae	Juveniles
Karate®	cotton, peanut, tobacco, soybean, termite abatement	Pyrethroid	0.5260 (0.351–0.789)	3.565 (1.721–7.385)
λ-Cyhalothrin	Karate® active ingredient	Pyrethroid	0.2233 (0.1833–0.2720)	2.701 (2.215–3.294)
Trimax™	fruits & vegetables, tobacco	Chloro-nicotinyl	312.7 (222.4–439.9)	816.7 (692.9–962.6)
Imidacloprid	Trimax™ active ingredient	Chloro-nicotinyl	10.04 (6.381–15.79)	1112 (841.9–1,468)
Aldicarb ^a	potatoes, cotton, peanuts, soybean	N-methyl carbamate	311.6 (281.6–344.8)	291.1 (227.7–372.3)
Orthene®	fruits & vegetables, golf courses	Organophosphate	61,210 (48,500–77,260)	191,300 (141,100–259,000)
Acephate	Orthene® active ingredient	Organophosphate	50,380 (44,300–57,300)	137,300 (132,800–141,900)
Roundup® Pro ^b	weed and brush control	Phosphonoglycine	6,279 (5,937–6,640)	316,000 (167,000–595,200)

The herbicide S,S,S-tri-n-butyl phosphorotrithioate (DEF) is widely used as a cotton defoliant. Rainfall simulations indicated on average 14.5 percent of applied DEF becomes runoff from conventional tillage (42). Habig et al. (43) studied the acute neurotoxic effects of short term exposure to DEF on adult blue crabs. Nerve enzyme activity was reduced more than 90 percent at both concentrations. Recovery of exposed crabs was slow and incomplete, 10 days after transfer to toxin-free water nerves regained less than 40 percent of their normal function. The Department of Agriculture and Consumer Services administers the NC Pesticide Law of 1971 and the North Carolina Pesticide Board adopts regulations, including crop spraying practices. Policies on drift from aerial applications affect the potential for toxin contamination in coastal waters and associated chronic and acute effects on fish populations. Rules prohibit aerial application of pesticides under conditions that will potentially result in drift and adverse effects to non-target areas. Deposition of pesticides labeled toxic or harmful to aquatic life is not permitted in or near waterways.

The NCDA&CS Pesticide Division investigated a 2012 mass mortality event of peeler blue crabs reported to the Division of Water Resources and Division of Marine Fisheries. The cause of the kill was found to be the pesticide bifenthrin which is commonly used with cotton and considered highly toxic to invertebrates. Rain following spraying of adjacent cotton fields, carried runoff from the fields to the canal where the peeler raceway intake was located. NCDA&CS rules prohibit aerial application of pesticides under conditions likely to result in drift to non-target areas. However, drift of chemicals into surface waters does occur at times and chemicals applied on land can be carried by stormwater runoff through ditches into surface waters. In the 2012 incident, the pesticide application did not violate label application directions, but there were some Best Management Practices that could have been followed to minimize impacts. After the kill, the NCMFC Shellfish/Crustacean Advisory Committee requested the division look into the mass mortality event. The topic was discussed by the NCMFC Habitat and Water Quality Advisory Committee and NCDA&CS staff spoke about the process and the specific incident. As

a result of the meeting, the NCDA&CS staff offered to increase outreach and technical assistance to farmers and additional training to pesticide applicators. Information was included on the NCDMF website and in dealer newsletters regarding what to do if a blue crab kill occurs.

North Carolina has several agricultural non-point source programs throughout the state (Table 2). The NCDA&CS is the lead agency for voluntary agricultural non-point source pollution control programs. The Nonpoint Source Section of the Division of Soil and Water Conservation (DSWC) along with NC Cooperative Extension Service (NCCES), NC Agricultural Research Service (NCARS), Basin Oversight Committee (BOC), and the USDA Natural Resources Conservation Service (NRCS) is responsible for managing several programs related to nonpoint source pollution particularly from agricultural lands and providing technical assistance to Soil and Water Conservation Districts (SWCD) and Local Advisory Committees (LACs). The NCDWR is the lead agency for regulatory agricultural Nonpoint Source (NPS) Pollution control programs.

Table 4.3.2. Agricultural NPS Programs in NC (45).

Category/Program	Local	State	Federal
Agricultural Cost-Share Program	SWCD	DSWC	
NC Pesticide Law of 1971		NCDA&CS	
NCDA&CS Pesticide Disposal Assistance Program		NCDA&CS	
Federal Insecticide, Fungicide, and Rodenticide Act			EPA
Animal Waste Management Regulations	SWCD	DWR, DSWC, NCCES	NRCS
NC Coop. Ext. Service and Ag Research Service		NCARS, NCCES	
Laboratory Testing Services		NCDA&CS	
Watershed Protections (PL-566)			NRCS
Farm Bills Programs			NRCS
Ag Nutrient Regulations in Neuse and Tar-Pam River Basins and the Jordan and Falls Lake Watersheds	LACs	DWR, DSWC, NCDA&CS, BOCs	
Soil, Plant Tissue, and Animal Waste Testing Program		NCDA&CS	

North Carolina water management strategies are developed based on individual watersheds (Figure 2). Agricultural contributions to nonpoint source water pollution are addressed primarily through encouragement of voluntary participation. This is supported through financial incentives, technical and educational assistance, research, and regulatory programs. A variety of cost share programs are available through DSWC. The Neuse River Basin is the focus of a large-scale, long-term watershed restoration projects underway in the state. The NCDWR initially established 53 rules, enacted in August 1998, with the goal of reducing the average annual load of nitrogen from point and nonpoint sources by a minimum of 30 percent below the average annual load from 1991 – 1995 and then maintain that level. These rules focused on protection and maintenance of riparian areas, wastewater discharge, urban stormwater management, agricultural nitrogen reduction, nutrient management, nitrogen offset fees, and stormwater. As of June 2017, the 30 percent reduction has not been achieved (45). The fifth edition to the Neuse River basin plan is scheduled to be completed in 2019.



Figure 4.3.2. Watershed River basins of North Carolina

Existing state plans recommend water monitoring activities across the state. The CHPP recommends improving strategies throughout river basins to reduce nonpoint pollution and minimize cumulative losses of fish habitat through voluntary actions, assistance, and incentives. This includes improved methods to reduce pollutants from agriculture, increasing use of reclaimed water, increasing use of riparian buffers, and increased funding for strategic land acquisition and conservation. The NCWRC Action Plan (46) states “Monitoring of aquatic taxa is critical to assessing species and ecosystem health and gauging the resilience of organisms to a changing climate. These monitoring efforts will inform future decisions on how to manage aquatic species. Long-term monitoring is needed to identify population trends and to assess performance of conservation actions. Monitoring plans should be coordinated with other existing monitoring programs where feasible.” The APNEP Comprehensive Plan (47) recommends the use of Best Management Practices on agricultural and silvicultural land, establishing contaminant management strategies for those waters not meeting water quality standards, and development and implementation of coordinated landscape-scale hydrological restoration strategies as well as wetland restoration strategies. Additionally, APNEP Engagement Strategy (48) prioritizes outreach at partner events throughout the Albemarle-Pamlico region. The above plans all encourage citizen science projects to educate and engage the public. These programs create a sense of ownership and accomplishment among participants and connect citizens to natural resources and water quality conservation.

There are many management alternatives that may contribute to success of state plan recommendations. Riparian buffer zones, vegetated ditches, and tailwater recovery systems are Best Management Practices which can reduce containments in nonpoint source runoff. Grass and forest buffers can be effective sediment traps. In North Carolina, Cooper et al. (49) estimated 84 to 90 percent of sediment from agricultural fields was trapped in adjoining deciduous hardwood riparian areas. Silt and clay were deposited into the forest while sand deposited along the edge of the riparian zone. Vegetated ditches may also serve not only to remove suspended solids from runoff but also reduce nutrient loads by reducing flow velocity and adding retention time to allow for precipitation and breakdown before reaching receiving waters (50; 51). Tailwater recovery systems also have the potential to reduce nutrient loading to receiving waters and

minimize fertilizer application through recycling captured nutrients in irrigation water (52; 53). The addition of water control structures can increase residence time allowing for nutrient degradation and precipitation out of the water column.

Water quality standards should be based on the assimilative capacity of, and impact to, systems as a whole. The NCMFC should urge the NCDWR and NCDA&CS to expand regulations and outreach aimed at minimizing agricultural impacts on waterways through Best Management Practices. Amendment 1 to the Blue Crab FMP outlines actions for water quality management strategies and recommends existing and future water quality plans are addressed in a timely manner. Additionally, positions are needed for compliance with NCDEQ stormwater and surface water programs. The NCMFC should partner with other state organizations to strategize and implement water quality improvements across basins and plan for coastal resilience to climate change. Working with these organizations, farmers and other citizens of North Carolina must be engaged to instill ownership in natural resources and doing their part to reduce their pollution footprint and improve water quality. Protections and restoration of water quality are essential to a sustainable blue crab stock.

Juvenile Habitat Addition

At its August 2019 business meeting the NCMFC passed the following motion:

“...that in addition to the recommendations included with the current draft Blue Crab Fishery Management Plan Amendment 3, the Division of Marine Fisheries is encouraged to develop an issue paper with pertinent recommendations and/or research needs related to juvenile blue crab habitat availability, habitat quality, and habitat landscape issues analogous to the issue paper developed on water quality impacts (Appendix 4.3 of the draft Blue Crab Fishery Management Plan Amendment 3).”

The following information was added to this issue paper as well as adding juvenile habitat concerns to the management recommendations to address the motion above:

Post-larval and early juvenile blue crabs (< 12 mm carapace width) use SAV for initial settlement and protection while they forage and grow. In the Albemarle-Pamlico estuarine system, most initial recruitment of juvenile blue crabs occurs in SAV beds around inlets behind the Outer Banks. However, in years with large storm events, blue crabs disperse into lower salinity habitats where they recruit into marsh habitat (54). When SAV is lacking blue crabs are forced to recruit into other habitat structure, such as marsh (54), shell bottom (55; 56), detrital matter and woody debris (57).

Like SAV, post-larvae and juvenile blue crabs use wetlands for foraging, refuge, and migration through the estuary (26). This includes detrital matter and woody debris from adjacent wetland vegetation, particularly in the Albemarle and Pamlico systems. Blue crabs utilize marsh edge and woody debris more than unvegetated bottom and occur more regularly in marshes with longer inundation periods (58; 59). They also use wetlands to a greater extent when SAV and oyster reefs are not present, such as in the lower salinity regions of river-dominated estuaries (60). Blue crabs in these lower salinity areas also have higher growth rates and lower predation than in the

more saline waters (60). The NCDMF estuarine trawl survey data show blue crab is one of the dominant juvenile species in marshes and shallow tidal creeks (61, 1).

Wetland loss lowers the habitat's capacity to support blue crabs, to trap and filter upland pollutants, and buffer storm events. Wetland losses associated with development and shoreline hardening reduce nursery habitat and food resources available for blue crab. Looking at the effect of land use change on fish abundance, Meyer (9) found a negative correlation between abundance of juvenile blue crabs and conversion of wetlands/undeveloped forest to agriculture/development (where the development change was greater than or equal to 12%). When assessing the effect of bulkheads and living shorelines on fish and invertebrates, Scyphers et al. (62) found living shorelines supported a greater abundance and diversity of aquatic life, with blue crabs being the most clearly enhanced (300% more abundant). Predation related mortality was significantly less at vegetated shorelines than at bulkheads or riprap (63).

Generally, significant reductions in juvenile blue crab habitat mentioned above as well as continued threats to these habitats have likely had significant negative effects on juvenile blue crab recruitment and survival.

VI. MANAGEMENT OPTIONS

The NCMFC has no regulatory authority over land use and other practices that impact water quality and juvenile habitat. The NCMFC could:

1. Highlight problem areas and advise other regulatory agencies (Coastal Resources Commission, Environmental Management Commission, DEQ Division of Water Quality, Department of Agriculture and Consumer Services, DEQ Division of Energy, Mineral and Land Resources, US Army Corps of Engineers, and local and state governments) on preferred options and potential solutions.
2. Push to create a joint interagency working group to facilitate cooperation and efforts in monitoring and restoring water quality and juvenile habitat. This should include coastal monitoring which is currently limited; including increased USGS sampling downstream from wastewater treatment plants.
3. Work with state agencies and interest groups to support maintaining the Clean Water Act at a national level and striving to meet or exceed recommendations
4. Task the CHPP steering committee to prioritize blue crab water quality and juvenile habitat impacts. These should include hypoxia and toxins, while researching specific sources of water quality degradation and their effects on blue crabs.
5. Send letters to the NCDA&CS Division of Forest Resources, Division of Environmental Programs, Division of Soil and Water Conservation, and Department of Transportation to share their concerns about water quality and juvenile habitat and the importance of Best Management Practices, especially buffer zones abutting coastal waters.
6. Invite these agencies to future NCMFC meetings in order to present mitigation efforts on water quality and juvenile habitat impacts, monitoring, and rehabilitation. These may include pesticide and herbicide policies, Best Management Practices reviews, and enforcement.
7. Public outreach is recommended to encourage the public to report crab and fish kills. One possible source of outreach may include a handout when licenses and permits are


purchased and/or renewed (recreational and commercial licenses, and shedding permits) which informs and directs the public how and what to report for these events (Figure 4.3.2).

Figure 4.3.2. Report crab kills post card distributed previously to commercial license holders.

REPORT CRAB KILLS


Why? Fishermen are often the first to see dead or dying crabs. Such events may occur due to weather or human-induced causes. Water quality conditions that can contribute to crab kills include low dissolved oxygen, rapid salinity change and elevated levels of pesticides in the water. Distress or mortality of peeler crabs in shedders can be an early sign of water quality problems. Rapid reporting of kills helps state agencies determine the cause and how to prevent them in the future.

What to look for: Blue crabs exposed to pesticides may exhibit unusual behavior, such as difficulty moving (flipping over, legs falling off) prior to dying. Crabs stressed by low oxygen or extreme changes in temperature or salinity are more likely to become inactive.



What to do: Immediately report crab or fish kills when observed at your shedder or on the water. Calls may be anonymous. When abnormal behavior is observed, freeze several crabs and collect water samples. Store the water sample in a clean jar or bag and keep cold.

Who to contact:
Weekdays: N.C. Department of Environmental Quality
Washington Office: 252-946-6481; 800-338-7804
Wilmington Office: 910-796-7215; 800-248-4536
Weekends/evening: **Environmental Emergency hotline: 800-858-0368**



VII. RECOMMENDATIONS

NCMFC Selected Management Strategy

- Support all management options presented
- Recommend Option 4 as the highest priority
- Division habitat staff shall regularly report back to the Habitat and Water Quality and Shellfish/Crustacean ACs with progress on each management option

VIII. LITERATURE CITED

1. Epperly, S.P. and S.W. Ross. 1986. Characterization of the North Carolina Pamlico-Albemarle Estuarine complex. NOAA Technical Memorandum MNFS-SEFC-175.
2. Bell, G.W., D.B. Eggleston, and T.G. Wolcott. 2003. Behavioral responses of free-ranging blue crabs to episodic hypoxia. I. Movement. Marine Ecology Progress Series. 259: 215-225.

3. Paerl, H.W., L.M. Valdes, M.F. Piehler, and C.A. Stow. 2006. Assessing the effects of nutrient management in an estuary experiencing climatic change: the Neuse River Estuary, North Carolina. *Environmental Management* Vol. 37, No. 3: 422-436.
4. Schroeder-Spain K. and D.L. Smee. 2019. Dazed, confused, and then hungry: pesticides alter predator-prey interactions of estuarine organisms. *Oecologia* 189.3: 815-828.
5. Karouna-Renier, N.K., R.A. Snyder, and K.R. Ranga Rao. 2007. Accumulation of organic and inorganic contaminants in shellfish collected in estuarine waters near Pensacola, Florida: contamination profiles and risks to human consumers. *Environmental Pollution* 145(2): 474-488.
6. Bell, G.W., D.B. Eggleston, and E.J. Noga. 2010. Molecular keys unlock the mysteries of variable survival responses of blue crabs to hypoxia. *Oecologia* 163: 57-68.
7. Mistiaen, J.A., I.E. Strand, and D. Lipton. 2003. Effects of environmental stress on blue crab (*Callinectes sapidus*) harvests in Chesapeake Bay Tributaries. *Estuaries* 26.2A:316-322.
8. Garcia, A.C., S. Bargu, P. Dash, N.N. Rabalais, M. Sutor, W. Morrison, and N.D. Walker. 2010. Evaluating the potential risk of microcystins to blue crab (*Callinectes sapidus*) fisheries and human health in a eutrophic estuary. *Harmful Algae* 9.2: 137-143.
9. Meyer, G.F.R. 2011. Effects of land use change on juvenile fishes, blue crabs, and brown shrimp abundance in the estuarine nursery habitats of North Carolina. PhD dissertation East Carolina University.
10. Daniel, C.C., III. 1978. Land use, land cover, and drainage on the Albemarle-Pamlico peninsula, eastern North Carolina, 1974. Water Resources Investigation Report No. 78-134. Washington: United States Geological Survey.
11. Heath, R.C. 1975. Hydrology of the Albemarle-Pamlico region, North Carolina: a preliminary report on the impact of agricultural developments. Water Resources Investigations Report No. 9-75. Raleigh: US Geological Survey.
12. Kellogg, R.L., S. Wallace, K. Alt, and D.W. Goss. 1997. Potential priority watersheds for protection of water quality from nonpoint sources related to agriculture. 52nd Annual Soil and Water Conservation Society Conference, Toronto, ON.
13. Kellogg, R.L., R. Nehring, A. Grube, S. Plotkin, D.W. Goss, and S. Wallace. 1999. Trends in the potential for environmental risk from pesticide loss from farm fields. The state of North America's private land, Chicago, IL.
14. Lunetta R.S., R.G. Green, and J.G. Lyon. 2005 Modeling the Distribution of diffuse nitrogen sources and sinks in the Neuse River Basin of North Carolina, USA. *Journal of the American Water Resources Association* Volume 41, Issue 5: 1129-1147.
15. Burkholder, J.M. and H.B. Glasgow. 1997. *Pfiesteria piscicida* and other *Pfiesteria*-like dinoflagellates: Behavior, impacts, and environmental controls. *Limnology and Oceanography* 42: 1052-1075.
16. Burkholder, J.M., M.A. Mallin, and H.B. Glasgow, L.M. Larsen, M.R. McIver, G.C. Shank, N. Deamer-Melia, D.S. Briley, J. Springer, B.W. Touchette, and E.K. Hannon. 1997. Impacts to a coastal river and estuary from rupture of a large swine waste holding lagoon. *Journal of Environmental Quality* 26: 1451-1466.
17. Burkholder, J.M., H.B. Glasgow, and C.W. Hobbs. 1995. Fish kills linked to a toxic ambush-predator dinoflagellate: Distribution and environmental conditions. *Marine Ecology Progress Series* 124: 42-61.
18. Lewitus, A.J., R.V. Jesien, T.M. Kana, J.M. Burkholder, H.B. Glasgow, Jr., and E. May. 1995. Discovery of the "phantom" dinoflagellate in Chesapeake Bay. *Estuaries* 18: 373-378.

19. Glasgow, H.B., J.M. Burkholder, M.A. Mallin, N.J. Deamermelia, and R.E. Reed. 2001. Field ecology of toxic *Pfiesteria* complex species, and a conservative analysis of their role in estuarine fish kills. *Environmental Health Perspectives* 109: 715-730.
20. Paerl, H.W. 1982. Environmental factors promoting and regulating N₂ fixing blue-green algal blooms in the Chowan River, North Carolina. University of North Carolina, Water Resource Res. Inst., Rep No. 176, 65p.
21. Paerl, H.W. 1983. Factors regulating nuisance blue-green algal bloom potentials in the lower Neuse River, N.C. University of North Carolina, Water Resource Res. Inst., Rep. No. 188, 48p.
22. Rudek, J., H.W. Paerl, M.A. Mallin, and P.W. Bates. 1991. Seasonal and hydrological control of phytoplankton nutrient limitation in the lower Neuse River Estuary, North Carolina. *Marine Ecology Progress Series*. Vol. 75:133-142.
23. Rester, J., M. Paine, and E. Serrano. 2013. Annual report of the Southeast Area Monitoring and Assessment Program, NA11NMF4350028.
24. NCDEQ, Division of Water Resources. 2019. NC Fish Kill Events <https://deq.nc.gov/about/divisions/water-resources/water-resources-data/water-sciences-home-page/nc-fish-kill-activity/fish-kill-events>
25. CCSP. 2008. The Effects of Climate Change on Agriculture, Land Resources, Water Resources, and Biodiversity in the United States. A Report by the U.S. Climate Change Science Program and the Subcommittee on Global Change Research. Backlund, P., A. Janetos, D. Schimel, J. Hatfield, K. Boote, P. Fay, L. Hahn, C. Izaurralde, B.A. Kimball, T. Mader, J. Morgan, D. Ort, W. Polley, A. Thomson, D. Wolfe, M. Ryan, S. Archer, R. Birdsey, C. Dahm, L. Heath, J. Hicke, D. Hollinger, T. Huxman, G. Okin, R. Oren, J. Randerson, W. Schlesinger, D. Lettenmaier, D. Major, L. Poff, S. Running, L. Hansen, D. Inouye, B.P. Kelly, L. Meyerson, B. Peterson, and R. Shaw. U.S. Environmental Protection Agency, Washington, DC, USA.
26. NCDEQ. 2016. North Carolina Coastal Habitat Protection Plan Source Document. Morehead City, NC. Division of Marine Fisheries. 475 p.
27. Klapproth, J.C. and J.E. Johnson. 2009. Understanding the science behind riparian forest buffers: effects on water quality. Virginia Cooperative Extension.
28. Paerl, H.W. and D.R. Whitall. 1999. Anthropogenically-driven atmospheric nitrogen deposition, marine eutrophication and harmful algal bloom expansion. *Ambio* 28: 307-311.
29. Mallin, M.A., J.M. Burkholder, L.B. Cahoon, and M.H. Posey. 2000. North and South Carolina Coasts. *Marine Pollution Bulletin*. Vol 41, Nos. 1-6, 56-75.
30. Rothenberger, M.B., J.M. Burkholder, and C. Brownie. 2009. Long-term effects of changing land use practices on surface water quality in a coastal river and lagoonal estuary. *Journal of Environmental Management*. 44:505-523.
31. Wannamaker, C.M. and J.A. Rice. 2000. Effects of hypoxia on movements and behavior of selected estuarine organisms from the Southeastern United States. *Journal of Experimental Marine Biology and Ecology*. 249(2): 145-163.
32. Funderburk, S.L., S.J. Jordan, J.A. Mihursky and D. Riley (eds.). 1991. Habitat requirements for Chesapeake Bay living resources. Second edition. Chesapeake Bay Estuary Program, U.S. Fish and Wildlife Service, Annapolis, MD.
33. Sullivan, E.T. and D. Gaskill. 1999. Effects of anoxia on the value of bottom habitat for fisheries production in the Neuse River estuary. Final Report for FRG Project 98-EP-04.

- North Carolina Department of Environment and Natural Resources. North Carolina Division of Marine Fisheries. Morehead City, NC. 128p.
34. Selberg, C.D., L.A. Eby, and L.B. Crowder. 2001. Hypoxia in the Neuse River Estuary: responses of blue crabs and crabbers. *North American Journal of Fisheries management* 21(2): 358-366.
 35. Gould, E., P. E. Clark, and F. P. Thurberg. 1994. Pollutant effects on demersal fishes. Pages 30-40 in J. B. P. R.W. Langton, and J.A. Gibson (eds.), editor. *Selected living resources, habitat conditions, and human perturbations of the Gulf of Maine*, volume NMFS-NE-106. National Oceanographic and atmospheric Administration, Woods Hole, Mass.
 36. Weis J.S. and P. Weis. 1989. Effects of environmental pollutants on early fish development. *Aquatic Sciences* 1(1): 45-55.
 37. Goff, A.D., P. Saranjampour, L.M. Ryan, M.L. Hladik, J.A. Covi, K.L. Armbrust, and S.M. Brander. 2017. The effects of fipronil and then photodegradation product fipronil desulfinyl on growth and gene expression in juvenile blue crabs, *Callinectes sapidus*, at different salinities. *Aquatic Toxicology* 186: 96-104.
 38. McKenney, C. L. Jr. 2005. The influence of insect juvenile hormone agonists on metamorphosis and reproduction in estuarine crustaceans. *Integrative and Comparative Biology* 45(1): 97-105.
 39. Horst M.N. and A.N. Walker. 1999. Effects of pesticide methoprene on morphogenesis and shell formation in the blue crab *Callinectes sapidus*. *Journal of Crustacean Biology* 19(4): 699-707.
 40. Schroeder-Spain K., L.L. Fisher, D.L. Smee. 2018. Uncoordinated: effects of sublethal malathion and carbaryl exposures on juvenile and adult blue crabs (*Callinectes sapidus*). *Journal of Experimental Marine Biology and Ecology*. 504: 1-9.
 41. Osterberg, J.S., K.M. Darnell, T.M. Blickley, J.A. Romano, and D. Rittschof. 2012. Acute toxicity and sublethal effects of common pesticides in post-larval juvenile blue crabs, *Callinectes sapidus*. *Journal of Experimental Marine Biology and Ecology*. 424-425: 5-14.
 42. Potter, T.L., C.C. Truman, D.D. Bosch, and C.W. Bednarz. 2003. Cotton defoliant runoff as a function of active ingredient and tillage. *Journal of Environmental Quality*. 32: 2180-2188.
 43. Habig, C., R.T. Digiulio, A.A. Nomeir, and M.B. Abou-Donia. 1986. Comparative toxicity, cholinergic effects, and tissue levels of S,S,S,-tri-n-butyl phosphorotrithioate (DEF) to channel catfish (*Ictalurus punctatus*) and blue crabs (*Callinectes sapidus*). *Aquatic Toxicology* 9: 193-206.
 44. NCDEQ, Division of Water Resources Water Planning Section. 2014. North Carolina Nonpoint Source Pollution Management Program Third Update. Raleigh, NC. June 2014
 45. NCDEQ, Division of Water Resources. 2018. Annual report to the General Assembly Environmental Review Commission basinwide water management planning July 2016 to June 2017. Raleigh, NC.
 46. WRC 2015 – North Carolina Wildlife Action Plan. Raleigh, NC. Raleigh, NC.
 47. APNEP. 2012. Comprehensive conservation and management plan 2012-2022. Albemarle-Pamlico National Estuary Partnership, Raleigh, NC.
 48. APNEP. 2018. Albemarle-Pamlico Nation Estuary Partnership Engagement Strategy 2018-2019. Albemarle-Pamlico National Estuary Partnership, Raleigh, NC.
 49. Cooper, J.R., J.W. Gilliam, R.B. Daniels, and W.P. Robarge. 1987. Riparian areas as filters for agricultural sediment. *Soil Science Society of America Journal*. 51: 416-420.

50. Flora, C. and R. Kröger, 2014a. Use of vegetated drainage ditches and low-grade weirs for aquaculture effluent mitigation: I. Nutrients. *Aquacultural Engineering* 60: 56-62.
51. Flora, C. and R. Kröger, 2014b. Use of vegetated drainage ditches and low-grade weirs for aquaculture effluent mitigation: II. Suspended sediment. *Aquacultural Engineering* 60: 68-72.
52. Carruth, G.W., J. Paz, M.L.M Tagert, S. Guzman, and L. Oldham. 2014. Reusing irrigation water from tailwater recovery systems: Implications on field and stream-level nutrient status. American Society of Agricultural and Biological Engineers. Montreal, Quebec Canada July 13 – July 16.
53. Czarnecki, J.M.P., A.R. Omer, and J.L. Dyer. 2017. Quantifying Capture and Use of Tailwater Recovery Systems. *Journal of Irrigation and Drainage Engineering*. 143(1): 050160101p.
54. Etherington, L.L. and D.B. Eggleston, "Large-scale blue crab recruitment: linking postlarval transport, post-settlement planktonic dispersal, and multiple nursery habitats.," *Marine Ecology Progress Series*, vol. 204, pp. 179-198, 2000.
55. Lenihan, S. and J.H. Grabowski, "Recruitment to and utilization of oyster reef habitat by fishes, shrimps, and blue crabs: An experiment with economic analysis.," Beaufort, NC, 1998.
56. Posey, M.H., T.D. Alphin, C.W. Powell and E. Townsend, "Use of oyster reefs as habitat for epibenthic fish and decapods.," in *Oyster Reef Habitat Restoration: A Synopsis and Synthesis of Approaches.*, M. W. Luckenbach, R. Mann and J. A. Wesson, Eds., Sloucester Point, VA, Virginia Institute of Marine Science Press, 1999, pp. 229-237.
57. Everett, R.A., and G.M. Ruiz, "Coarse woody debris as a refuge from predation in aquatic communities: An experimental test.," *Oecologia*, vol. 93, pp. 475-486, 1993.
58. Micheli, F.M., and C.H. Peterson, "Estuarine vegetated habitats as corridors for predator movement.," *Conservation Biology*, vol. 13, no. 4, pp. 869-881, 1999.
59. Minello, T.J., L.P. Rozas, and R. Baker, "Geographic variability in salt marsh flooding patterns may affect nursery value for fishery species.," *Estuaries and Coasts*, vol. 35, pp. 501-514, 2011.
60. Posey, M.H., T.D. Alphin, H. Harwell, and B. Allen, "Importance of low salinity areas for juvenile blue crabs, *Callinectes sapidus* Rathbun, in river-dominated estuaries in southeastern United States," *Journal of Experimental Marine Biology and Ecology*, vol. 319, pp. 81-100, 2005.
61. NCDMF, Morehead City, NC: North Carolina Division of Marine Fisheries, unpublished data.
62. Scyphers, S.B., J.S. Picou and S.P. Powers, "Participatory conservation of coastal habitats: the importance of understanding homeowners decision making to mitigate cascading shoreline degradation.," *Conservation Letters*, vol. 8, no. 1, pp. 41-49, 2015.
63. Long, W.C., J.N. Grow, J.E. Majoris, and A.H. Hines, "Effects of anthropogenic shoreline hardening and invasion by *Phragmites australis* on habitat quality for juvenile blue crabs (*Callinectes sapidus*).," *Journal of Experimental Marine Biology and Ecology*, vol. 46, no. 1, pp. 215-222, 2011

APPENDIX 4.4: EXPAND CRAB SPAWNING SANCTUARIES TO IMPROVE SPAWNING STOCK BIOMASS¹

I. ISSUE

Consider expansion of existing Crab Spawning Sanctuaries and designation of new Crab Spawning Sanctuaries to protect mature females prior to spawning.

II. ORIGINATION

The 2016 Revision to Amendment 2 to Blue Crab Fishery Management Plan (1) included expansion of existing and/or designation of new Crab Spawning Sanctuaries (CSS) and imposing further fishing restrictions within existing CSS as potential management measures to address low recruitment. Neither the expansion of existing CSS, designation of new CSS, or implementing additional fishing restrictions in the CSS were adopted by the N.C. Marine Fisheries Commission (NCMFC). Expansion of existing and designation of new CSS as well as potential migration corridors are explored in this issue paper.

III. BACKGROUND

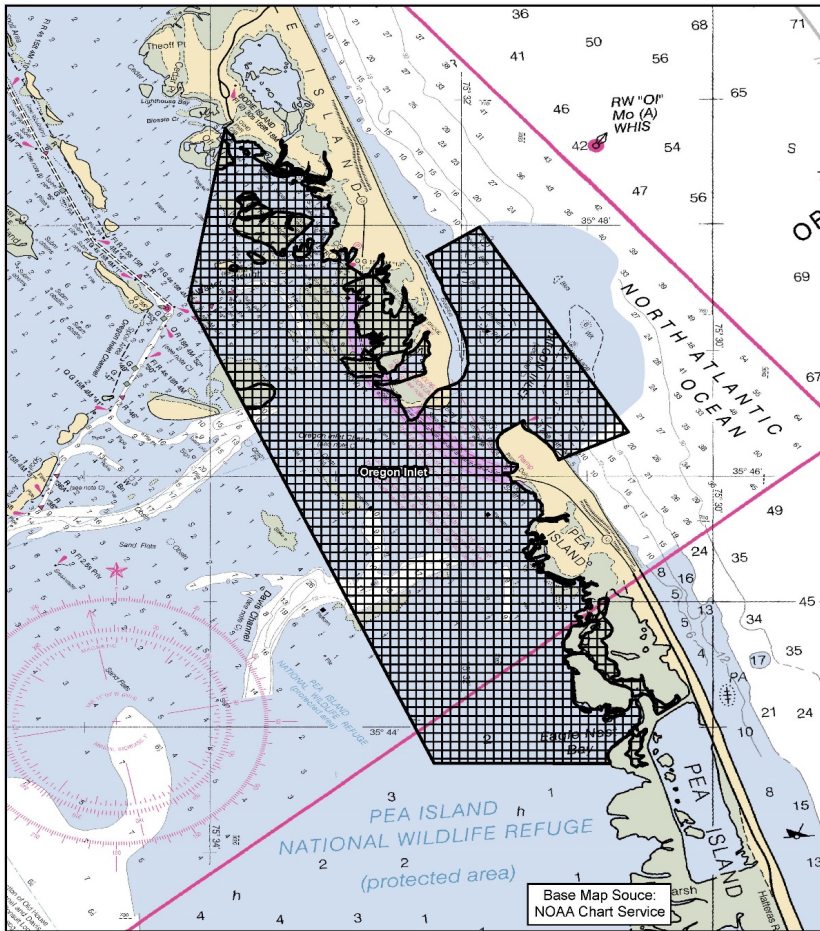
Existing Crab Spawning Sanctuaries

In 1965, the law prohibiting the harvest of sponge crabs was repealed and replaced with the designation of five CSS north of Cape Lookout (Table 4.4.1; Figures 4.4.1, 4.4.2, and 4.4.3). The CSS are closed to the use of trawls, pots, and mechanical methods for oysters or clams and to the taking of crabs with any commercial fishing equipment from March 1 through August 31 (NCMFC Rule 15A NCAC 03L .0205). Existing proclamation authority in NCMFC Rule 03L .0205 allows additional areas to be designated as CSS and allows for further fishing restrictions to be enacted within the CSS. The purpose of these sanctuaries is to protect mature females inhabiting these areas prior to and during the spawning season and to allow them access to ocean waters to release their eggs.

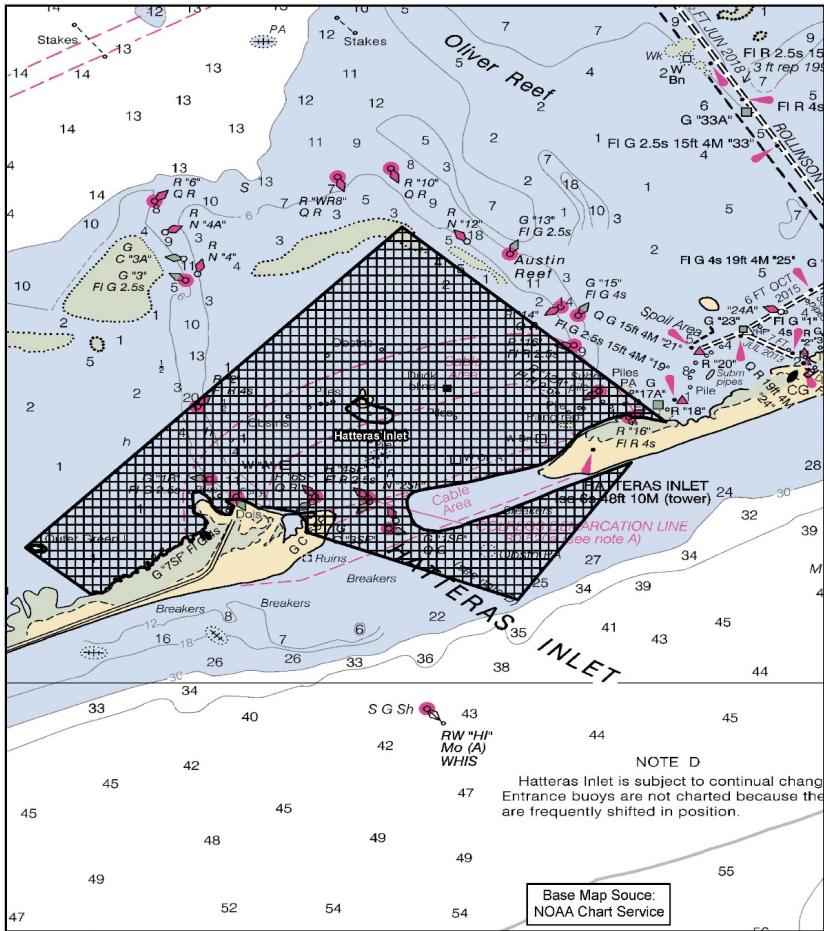
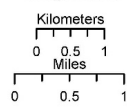
Table 4.4.1. Location and approximate size (in acres) of the five current Crab Spawning Sanctuaries.

Location	Acres
Oregon Inlet	5,788
Hatteras Inlet	4,444
Ocracoke Inlet	8,745
Drum Inlet	5,388
Barden Inlet	4,610

¹ Presented to AC on 4/25/19; Presented to PDT on 3/1/19, 3/26/19, and 5/2/19



Crab Spawning Sanctuaries
(15A NCAC 03R .0110)
Oregon Inlet



Crab Spawning Sanctuaries
(15A NCAC 03R .0110)
Hatteras Inlet

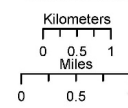
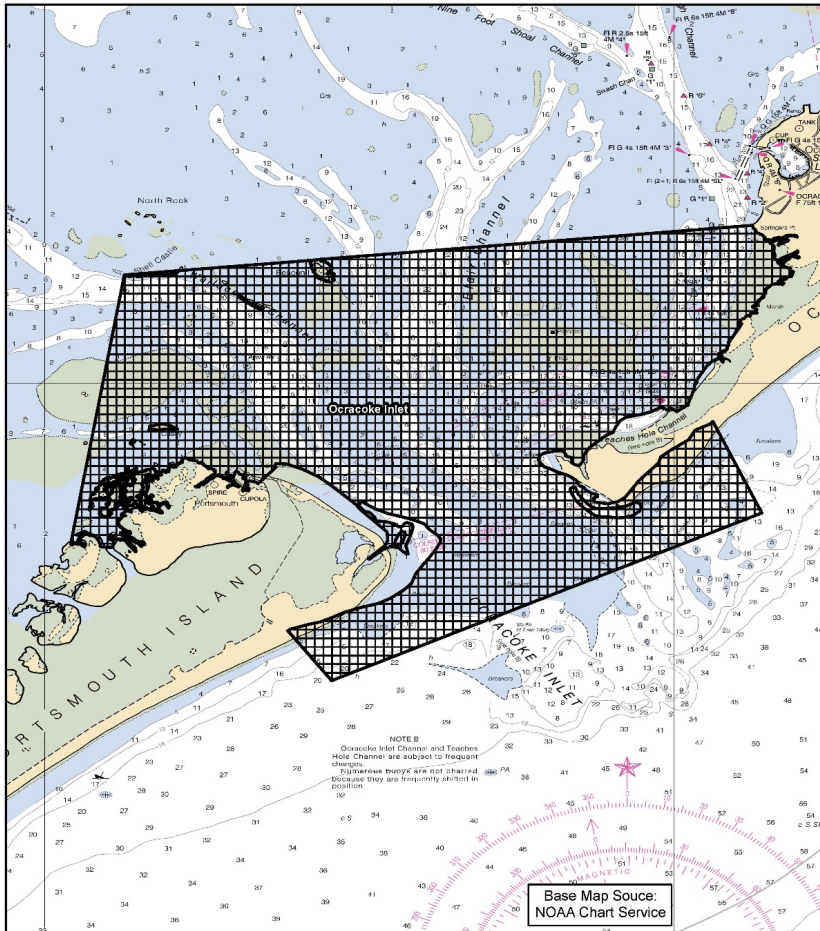
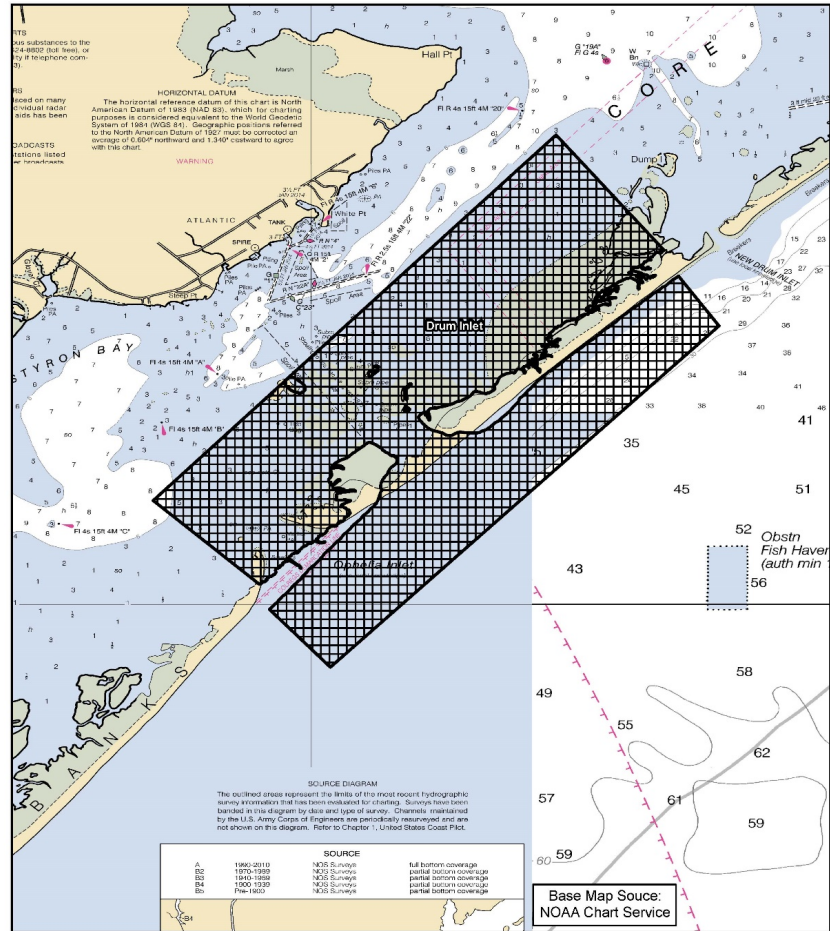
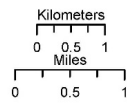
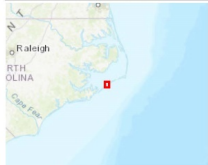


Figure 4.4.1. Current Crab Spawning Sanctuary boundaries for Oregon and Hatteras inlets.



**Crab Spawning Sanctuaries
(15A NCAC 03R .0110)
Ocracoke Inlet**



**Crab Spawning Sanctuaries
(15A NCAC 03R .0110)
Drum Inlet**

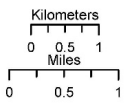
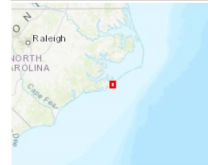
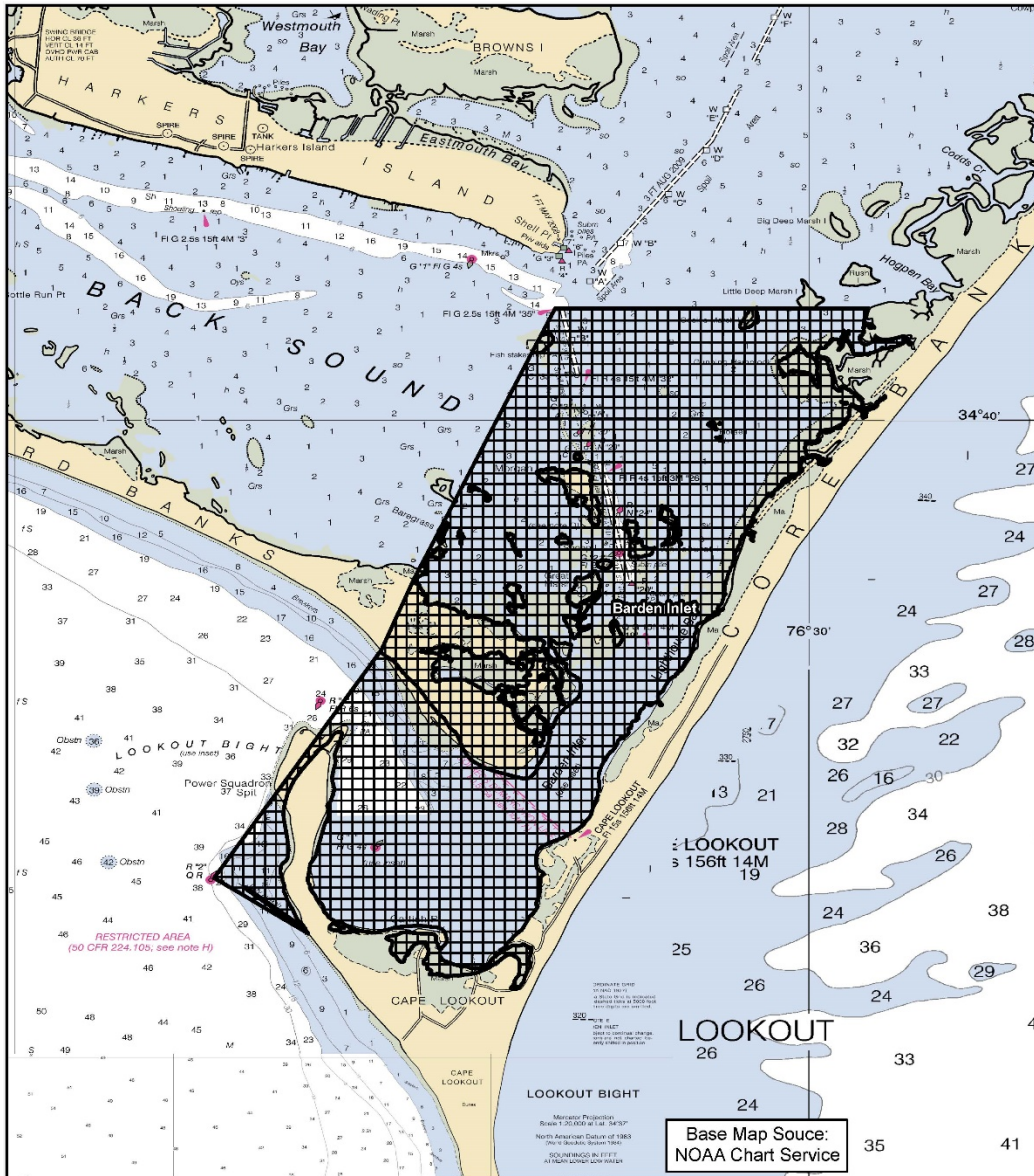


Figure 4.4.2. Current Crab Spawning Sanctuary boundaries for Ocracoke and Drum inlets.



**Crab Spawning Sanctuaries
(15A NCAC 03R .0110)
Barden Inlet**

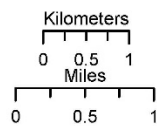


Figure 4.4.3. Current Crab Spawning Sanctuary boundary for Bardens Inlet.

In N.C., blue crab mating peaks in April-June and August-September (2). In the Albemarle-Pamlico system, migration towards the closest inlet starts late September-October for females that mated later in the summer, with spawning the following spring (3). These crabs overwinter in the mud along their migration route or near the inlet system. When mating occurs in early spring, mature female crabs migrate sooner, rather than waiting for fall (2). Commercial crab sampling indicates sponge crabs are most abundant March through May, but are typically present from March through August (see Appendix 4.2, Table 4.2.6).

Several studies have looked at the effectiveness of the five existing CSS in North Carolina. Migration distance, tidal regime, harvest effort along the migration route, and the proportion of post-mating mature female blue crabs protected in the sanctuaries influence the ability of mature female blue crabs to successfully reach the protected spawning grounds and thus the overall success of the sanctuaries.

Researchers (4; 5; 6) sampled blue crabs using crab pots in all five sanctuaries during different years. Mature female crabs were present year-round at all of the CSS, with abundance greatest from June to August at all sanctuaries except Hatteras, where abundance was greatest in April. Most brown sponge crabs were caught in inlet channels. The abundance of mature females was correlated with salinity (5) and temperature (6). Ballance and Ballance (4) concluded that in wet years mature female crabs are more concentrated and abundant within the sanctuaries than in dry years because they are seeking the higher salinity needed for egg development and spawning. In dry years, the salinity is high in a larger portion of Pamlico Sound west of the inlets so many female crabs are located west of the sanctuary boundaries. The difference in salinity could also explain differences in relative abundance among sanctuaries. Tag return data found that females tagged within the sanctuaries in Pamlico Sound were consistently caught within four kilometers of estuarine sanctuary boundaries (4; 7). Crab dredgers have noted that when temperatures drop early in the fall crabs are more abundant in the designated crab dredge area (J. Midgett, personal communication), suggesting they overwinter before reaching the sanctuary boundaries. The Ballance studies concluded the existing CSS are protecting a portion of egg bearing females, varying with environmental conditions, and that designation of migration corridors or expanded sanctuary boundaries could protect more of the spawning stock.

The effectiveness of the spawning sanctuaries was also assessed by trawling in June, August, and September 2002 inside and up to 2 km outside (sound-side and ocean-side) of the CSS boundaries (8). Results found that relative abundance of mature female blue crabs inside the five sanctuaries combined was not significantly higher than outside the sanctuaries (46.8% inside, 41.9% outside sound-side, 11.3% outside ocean-side). The study estimated that total mature female abundance within sanctuary boundaries only accounted for 0.7% of all mature female blue crabs within the Pamlico and Croatan sounds. Comparing the five CSS, Hatteras and Barden inlets had more mature female blue crabs inside sanctuary boundaries (53.9-64.3%) than outside. In contrast, the opposite was true at the other inlets (37.7-40.0%). The relative abundance of female blue crabs at the inlets (inside and outside of sanctuary boundaries) was highest at the northernmost (Oregon) and southernmost (Drum and Barden) inlets and lowest at Ocracoke and Hatteras inlets. This was attributed to blue crabs migrating to the closest inlet, with Oregon Inlet receiving crabs from Albemarle and northern Pamlico sounds, and Drum and Barden inlets receiving crabs from the Neuse and Tar-Pamlico rivers.

New Crab Spawning Sanctuaries

Crab spawning sanctuaries have not been designated south of Bardens Inlet (14 inlets total). In the southern area of the state, inlets tend to be smaller and occur in closer proximity to each other than in the Pamlico Sound system. Since mature females migrate toward the closest inlet, and there are multiple inlets, mature females are likely to be less concentrated at any one inlet (although the Cape Fear River Inlet may be an exception).

While the density of mature females per inlet may be less than at northern inlets, the closer proximity to the inlets and semi-diurnal tides could facilitate a greater proportion of mature female blue crabs reaching the spawning grounds. The mechanism for migrating long distances varies by tidal regime. In waters with semi-diurnal tides, ovigerous female blue crabs (sponge crabs) have a circa-tidal rhythm, swimming in the water column toward the closest inlet on ebb tides (12.4 hr cycles), or circa-lunar rhythm, swimming once daily during the night ebb tide (24.8 hr cycles) (9). There is rapid seaward movement with ebb tide transport (ETT) following oviposition of the first clutch of eggs (10). Peak swimming speed is around one hour after the tide starts falling. In non-tidal systems, such as most of Pamlico Sound, ovigerous females follow circadian rhythm, swimming seaward at night or walking along the bottom (9). Migration slows once reaching waters where salinity is approximately 22 ppt, the salinity necessary for egg development (2).

A crab tagging and modelling study near Beaufort Inlet, where average tidal currents are relatively strong (1 m/s), found most blue crabs were able to migrate approximately 5 km/day using ETT (11). Crab movement was greater during night ebb tides than day ebb tides or flood tides and increased with current speeds. Ramach et al. (12) found that males and mature females in a high salinity embayment near Beaufort Inlet were partitioned with egg bearing females concentrating closer to the opening of the embayment in slightly deeper water than the males. The female crabs use the embayment to forage until egg release is imminent. In this staging area crabs were able to swim to the inlet within one tidal cycle. Migration speed among individual crabs varied, with some being more active than others (13). Down-estuary walking and swimming in the upper estuary and micro-tidal waters, where currents are slower, helps to successfully move the crabs down to areas with stronger currents. In the Beaufort Inlet system, including North and Newport rivers, Back Sound, and Bogue Sound, all crabs were able to migrate to the inlet within four days (13). The migration patterns noted in the Beaufort Inlet system are thought to be comparable to those in other diurnal systems south of Beaufort Inlet. An acoustic tagging study conducted in the White Oak River found that blue crabs began migrating within days of mating (14). The tagged crabs travelled an average of 0.9 km/day, and travelled in the deeper channels (4-5 m water depth), where currents are stronger.

Studies were conducted in the New River in 2006-2007 and in the Cape Fear River in 2005-2006 to assess spatial distribution through the spawning season in these tidal rivers of the southern coast (15; 16). In the Cape Fear River estuary, data indicated that crabs were concentrated in a lower portion of the river from Snow's Cut to the mouth of the river. Ovigerous females had the greatest abundance in the lower river in July. In the New River, female abundance was highest in July, gradually decreasing through November. The decline was attributed to mature female crabs

moving into the shallower creeks and bays. No trend between upper, mid, and lower river sections were detected except the upper zone had significantly less female crabs in September than the lower river. Mature females were found predominantly in the lower river (Stones Bay and south). These findings are consistent with studies from inlets to the north, with mature females being most abundant in the lower system during the summer.

IV. AUTHORITY

North Carolina General Statute 113-134 – Rules
North Carolina General Statute 113-182 – Regulation of fishing and fisheries
North Carolina General Statute 113-221.1 – Proclamations; emergency review
North Carolina General Statute 143B-289.52 – Marine Fisheries Commission – powers and duties
NCMFC Rule 15A NCAC 03H .0103 – Proclamations, General
NCMFC Rule 15A NCAC 03L .0205 Crab Spawning Sanctuaries

V. DISCUSSION

Expand Boundaries of Existing Crab Spawning Sanctuaries

A crab spawning sanctuary system is also used in Virginia as a blue crab management tool. The sanctuary boundaries in the Chesapeake Bay were initially found to be ineffective in improving stock size due to the relatively small proportion (16%) of mature female blue crabs that were protected (17). Subsequently, the spawning sanctuary was expanded in 2002 to include a migration corridor, protecting 70% of the mature females. Because post-mating mature females have a lengthy migration and their precise distribution varies seasonally and annually due to weather conditions, the expansion of the historical spawning sanctuary was found to adequately protect mature females (19; 20). This change resulted in a resurgence of the spawning stock (14). Eggleston et al. (8) estimated that <1% of mature female blue crabs in Pamlico and Croatan sounds were protected from harvest (within the spawning sanctuary). Consequently, the protection provided by the CSS in North Carolina is likely insufficient.

Delineating spawning sanctuary boundaries in North Carolina is somewhat more challenging than in the Chesapeake Bay. Unlike North Carolina, the Chesapeake Bay only has one major exit to the ocean so all female crabs inevitably have to concentrate and pass through the migratory corridor and spawning sanctuary. Also, blue crabs were noted to migrate in the deeper channels of the Chesapeake Bay, where depths were 10-14 ft. deep. In contrast, North Carolina has multiple inlets that blue crabs could migrate toward and the bottom is relatively uniform in depth, lacking discrete channels except near inlets.

In addition to the overall small proportion of mature female crabs within the existing CSS, release of eggs prior to reaching the spawning grounds (19) or being caught (14) are other factors that can reduce the effectiveness of the CSS in protecting the spawning stock. Egg release may be more likely to occur in Pamlico Sound where the distance to travel to the inlets is greater, migration is dependent on daily (light) rather than semi-daily cues, and wind-driven currents are

slower than tidal flows (10). This supports the need to increase the size of the CSS in Pamlico Sound to better protect the spawning stock.

Ballance and Ballance (4) and Eggleston et al. (8) noted high concentrations of mature females within 4 and 2 km of the CSS boundaries, respectively. Of the five sanctuaries, Oregon, Bardens and Drum inlets had the greatest abundance of mature female blue crabs, likely due to closer proximity to mating grounds. Therefore, inward expansion of the five existing sanctuaries, or the three with the relatively higher abundance, could substantially increase the percent of mature females that would be protected by the sanctuaries.

To help guide any proposed expansion of the existing CSS the blue crab plan and development team reviewed available NCDMF mature female blue crab tagging data (7) and included them on maps showing potential expanded boundary areas. The maps also show the location of oyster cultch planting sites, oyster trigger sampling locations, mechanical clam harvest areas, shellfish leases, and diamondback terrapin interactions where appropriate. Additionally, the current CSS boundaries were examined to ensure they adequately account for movement of the inlets. For example, the existing CSS around Drum Inlet is no longer functional. Ophelia Inlet opened through Core Banks just south of Drum Inlet in 2006 and Drum Inlet closed in 2008-2009. The current boundary for the Drum Inlet CSS does not include all of Ophelia Inlet.

The expanded boundary area of the Oregon Inlet CSS does include some cultch planting and oyster sampling sites but also contains a large number of mature female tag returns (Figure 4.4.4). The expansion areas around Hatteras Inlet (Figure 4.4.4) and Ocracoke Inlet (Figure 4.4.5) contain a few cultch planting sites as well as a significant number of mature female tag returns. The boundary for the Drum Inlet CSS was shifted south to completely cover Ophelia Inlet (Figure 4.4.5). The expansion area around Bardens Inlet covers more deep water area as well as shallow foraging habitat (Figure 4.4.6). Table 4.4.2 shows the acreage of the existing CSS boundaries and the expanded boundaries shown in each map.

Table 4.4.2. Acreage of existing Crab Spawning Sanctuaries and NCDMF recommended boundaries in Amendment 3. * indicates also recommended by Blue Crab AC.

Crab Spawning Sanctuary	Current Acreage	NCDMF Recommended Acreage
Oregon Inlet	5,804	23,332
Hatteras Inlet	4,662	12,282
Ocracoke Inlet	7,914	30,759
Drum/Ophelia Inlet	5,165	5,503*
Barden Inlet	4,637	8,606*

Due to the current regulations in the CSS prohibiting the use of trawls and mechanical methods for harvesting oysters or clams, there could be some impacts to the mechanical oyster, clam and shrimp fisheries if the closure period is extended. For example, expanding the current CSS boundary around Oregon Inlet could potentially impact the mechanical oyster fishery in the area as indicated by the number of cultch planting and sampling sites within the expanded boundary (Figure 4.4.4). The mechanical oyster harvest season occurs from November through the end of March, unless closed earlier due to reaching the management trigger for legal size oysters.

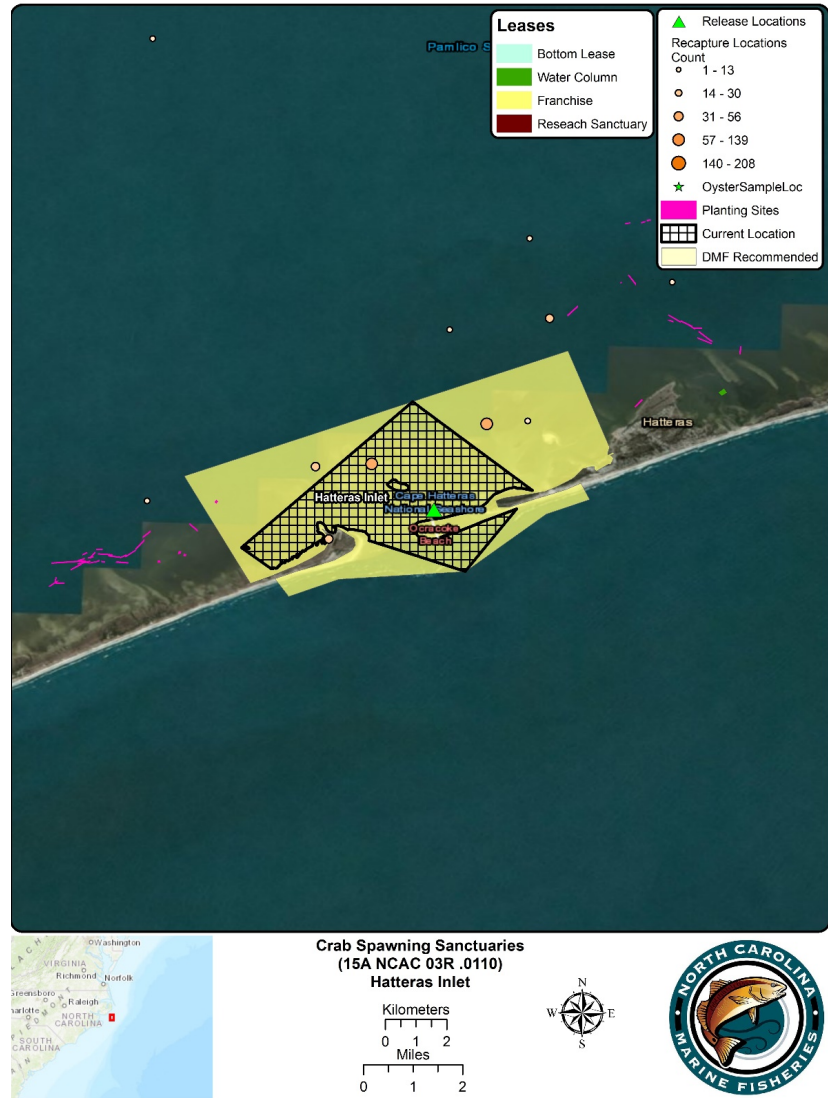
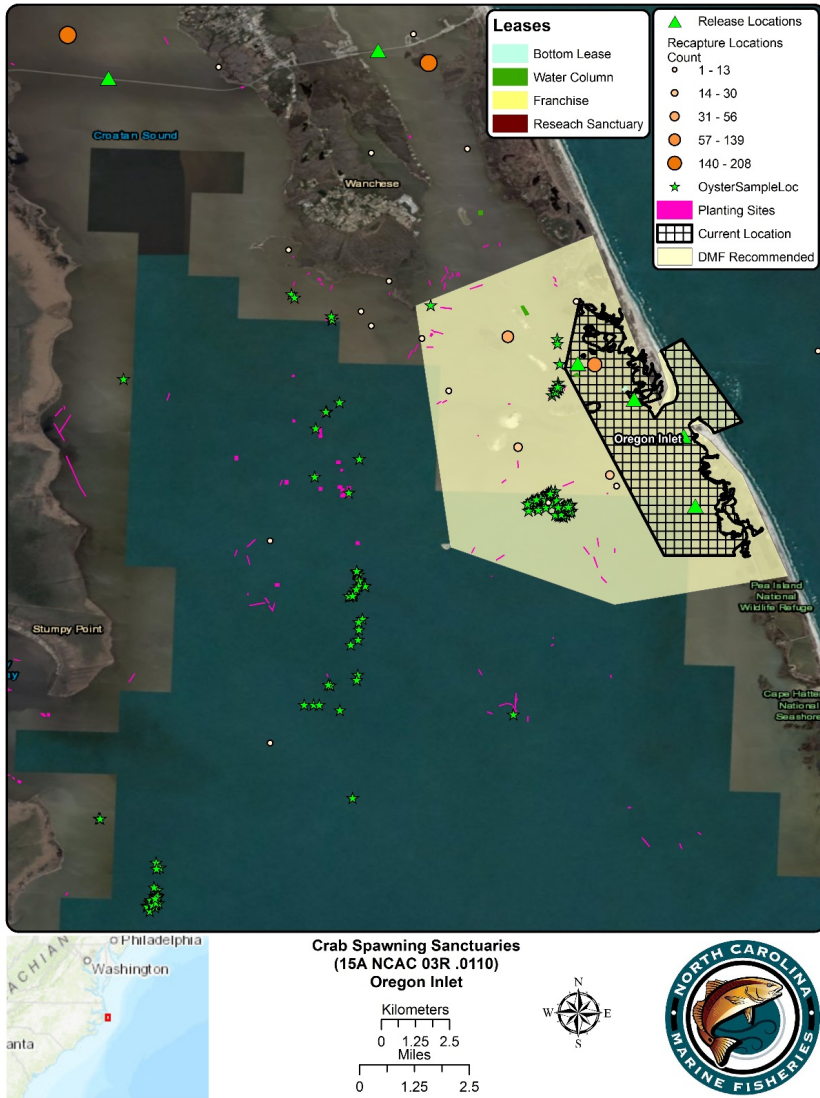


Figure 4.4.4. Proposed locations of new Crab Spawning Sanctuary boundaries for Oregon and Hatteras inlets.

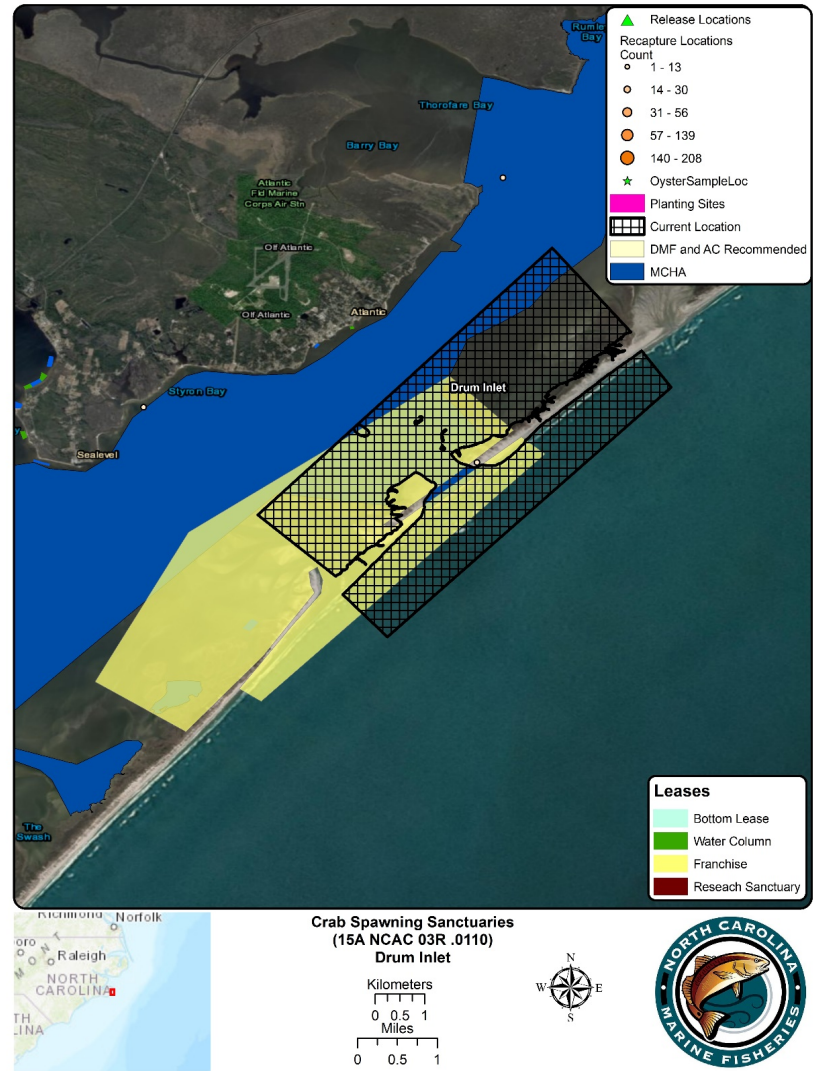
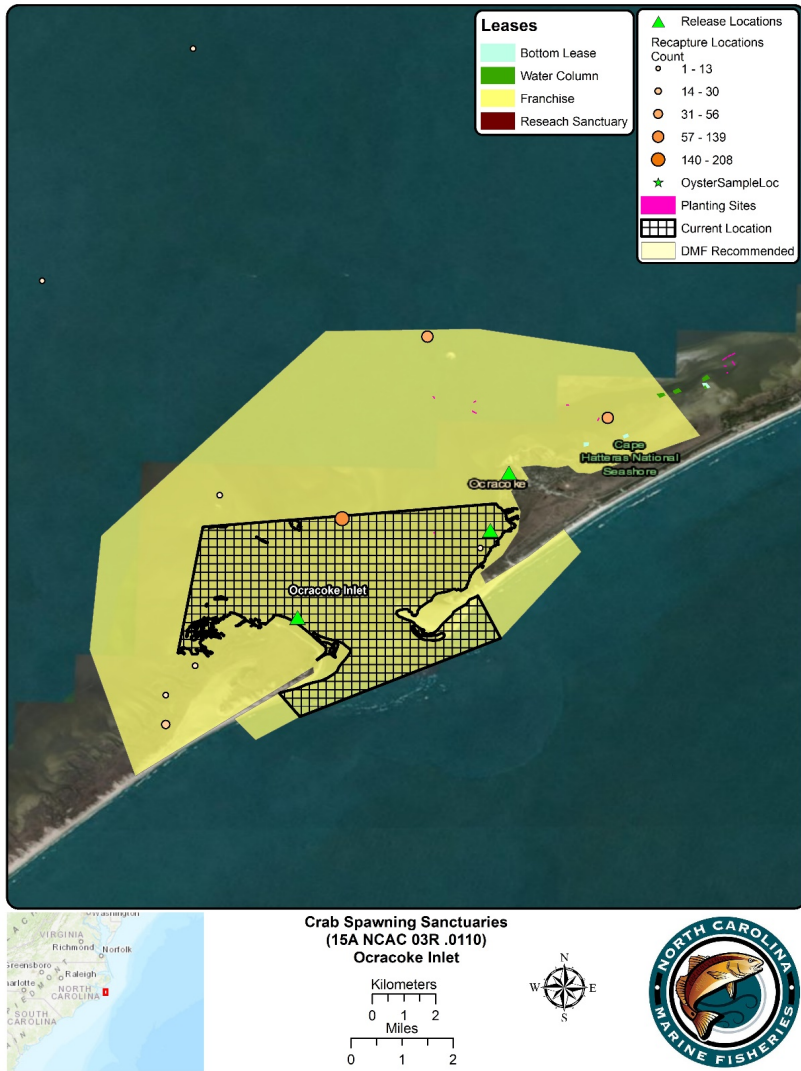


Figure 4.4.5. Proposed locations of new Crab Spawning Sanctuary boundaries for Ocracoke and Drum/Ophelia inlets.

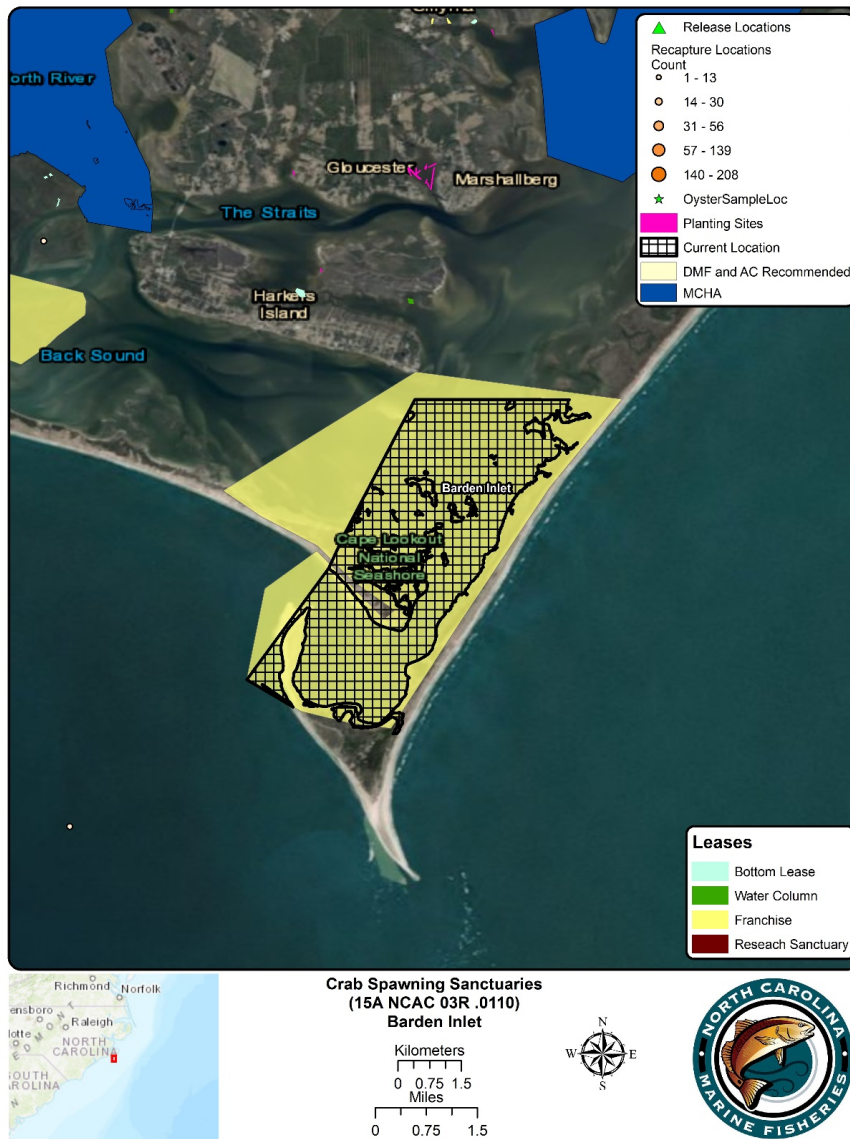


Figure 4.4.6. Proposed location of new Crab Spawning Sanctuary boundary for Bardens Inlet.

Designate New Crab Spawning Sanctuaries

There are 14 inlets that are not designated as crab spawning sanctuaries (Table 4.4.3). These inlets are all south of Barden Inlet. Designating additional crab spawning sanctuaries at some or all of the 14 inlet systems would protect mature females in those areas and enhance local larval recruitment. Average commercial blue crab landings in Core-Bogue sounds and waters south of and including White Oak River account for only 7% of the total average landings from 2007-2016 (Figure 4.4.7). However, crab spawning sanctuaries in these smaller systems could be more effective if a greater percent of mature females are able to reach the protected spawning sanctuaries due to the shorter distance to travel and semi-diurnal tides accelerating migration rates.

Table 4.4.3. Inlets without designated Crab Spawning Sanctuaries south of Barden Inlet, listed north to south.

Inlet Name	
Beaufort	Mason
Bogue	Masonboro
Bear	Carolina Beach
Browns	Cape Fear
New River	Lockwoods Folly
New Topsail	Shalotte
Rich	Tubbs

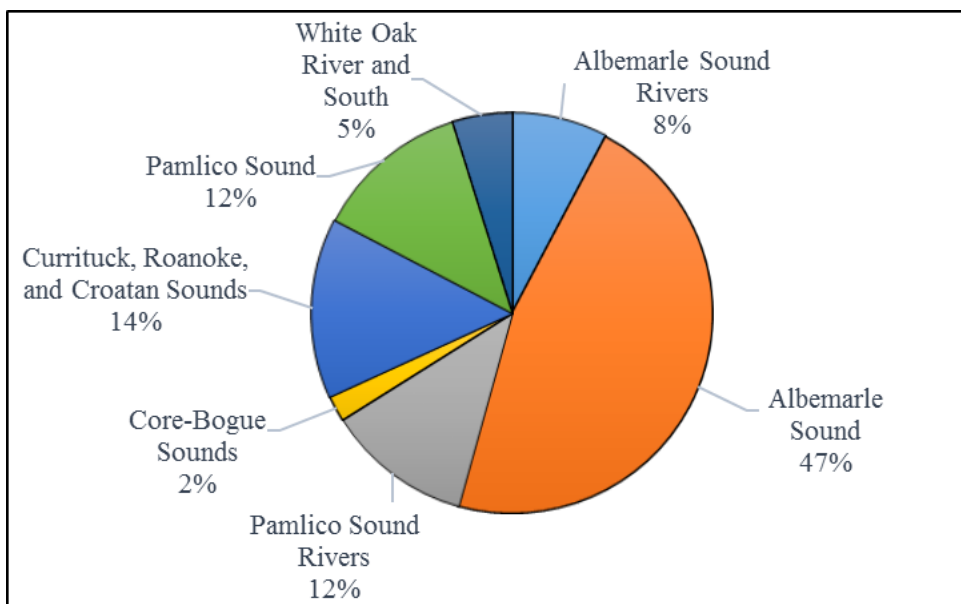


Figure 4.4.7. Percent of commercial crab landings by waterbody, 2007-2016.

Without designated CSS south of Cape Lookout, none of the spawning stock is protected in the southern region of the state. Designating additional CSS would further protect mature females as they migrate to spawning grounds. Designations could be limited to the largest and most stable inlets, or to those that contribute the most in terms of use by spawning females. Of the 14 inlets, the largest are Beaufort, Bogue, and Cape Fear River. Unfortunately, research has not been done to assess abundance of mature female blue crabs at most of the inlets in this region.

Spawning sanctuaries around the southern inlets would prohibit crab pots, trawls, and mechanical methods for harvesting clams and oysters for a portion or all of the year, depending on the management strategy chosen. Creating sanctuaries in the southern inlets could have a short-term impact on blue crab landings but could lead to a long-term increase in the population and future harvest. Local crabbers have suggested the deep fast flowing waters of the lower Cape Fear River ship channel provide a natural barrier to some crab harvesting practices in that area. Thus, this area serves as an unofficial sanctuary for all blue crabs (1).

Inlets are critical corridors that all estuarine dependent migratory species must pass through to complete their life cycle. Ogburn and Habegger (20) suggested the primary spawning habitat of blue crabs may be in coastal ocean waters in the South Atlantic, with inlet systems functioning more as spawning migration corridors. Regardless, mature female blue crabs are concentrated in the vicinity of inlets seasonally and must reach or pass through them to spawn. Other species could also benefit from seasonal restrictions on trawls, including shrimp and associated bycatch species. The extent of trawling effort that occurs within the inlet systems is unknown since the inlet systems are smaller than the commercial trip ticket waterbodies used to track commercial landings. Therefore, the impact of designating CSS in these areas on the shrimp trawl fishery is unquantifiable. Examples of potential sanctuary boundaries are shown in Figures 4.4.8-4.4.14. These figures show the proposed CSS boundaries from the 2016 Revision to Amendment 2 to the N.C. Blue Crab FMP as well as alternative boundaries based on the research discussed above. Table 4.4.4 shows the estimated acreage of the proposed CSS boundaries from the 2016 Revision and the alternative boundaries.

As above, maps for the potential new CSS include NCDMF mature female blue crab tagging data (7) and the location of oyster cultch planting sites, oyster trigger sampling locations, mechanical clam harvest areas, shellfish leases, and diamondback terrapin interactions where appropriate. Sanctuary boundaries in the Atlantic Ocean are approximate and meant to extend roughly 100 yards from shore from the mean high-water mark.

Table 4.4.4. Proposed Crab Spawning Sanctuary acreages by inlet from Beaufort Inlet south.
*Where recommendations differ for NCDMF and AC, value in parentheses is for AC recommendation.

Crab Spawning Sanctuary	NCDMF and AC Recommended Acreage
Beaufort Inlet	4,250
Bogue Inlet	1,427
Bear Inlet	439
Browns Inlet	286
New River Inlet	803
Topsail Inlet	930
Rich Inlet	420
Mason Inlet	334
Masonboro Inlet	519
Carolina Beach Inlet	276
Cape Fear River Inlet*	3,846 (3,695)
Lockwoods Folly Inlet	264
Shalotte Inlet	411
Tubbs Inlet	141

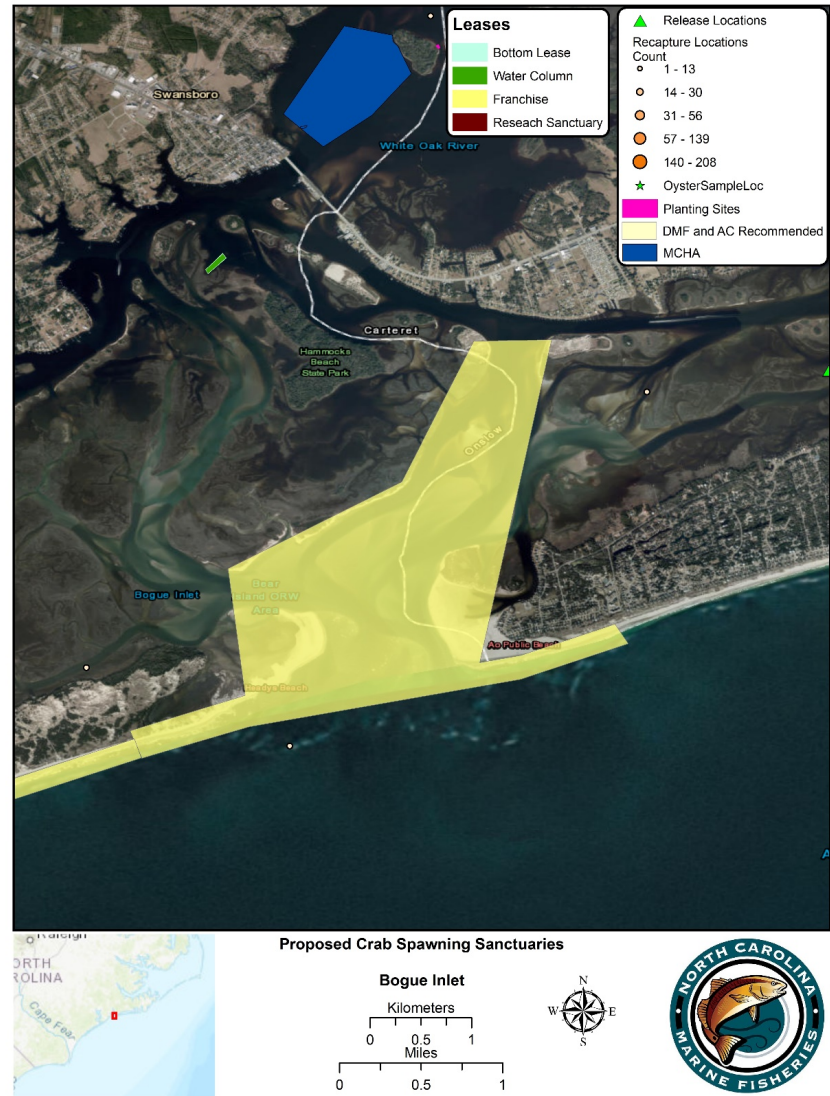
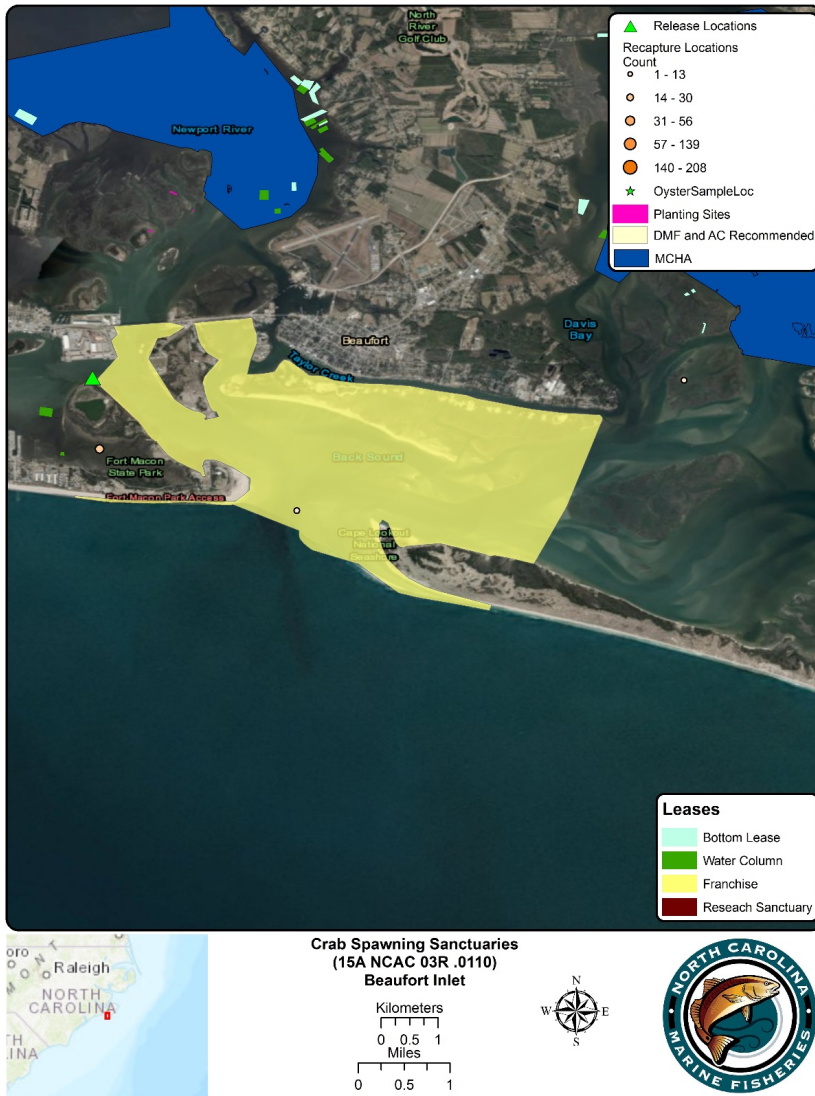
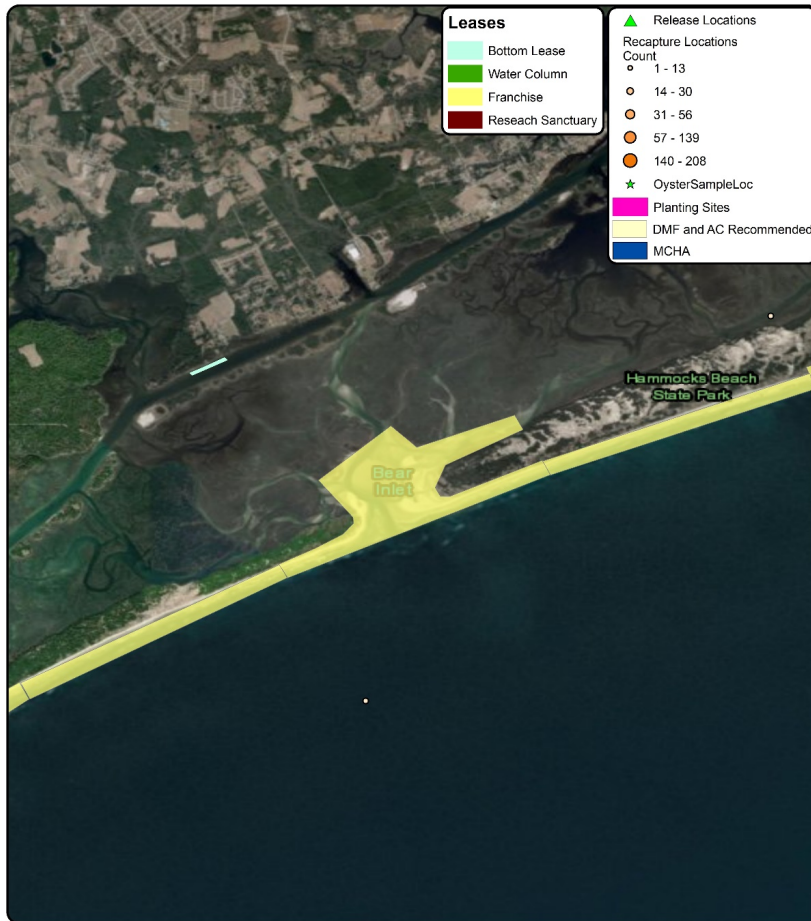
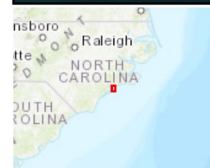
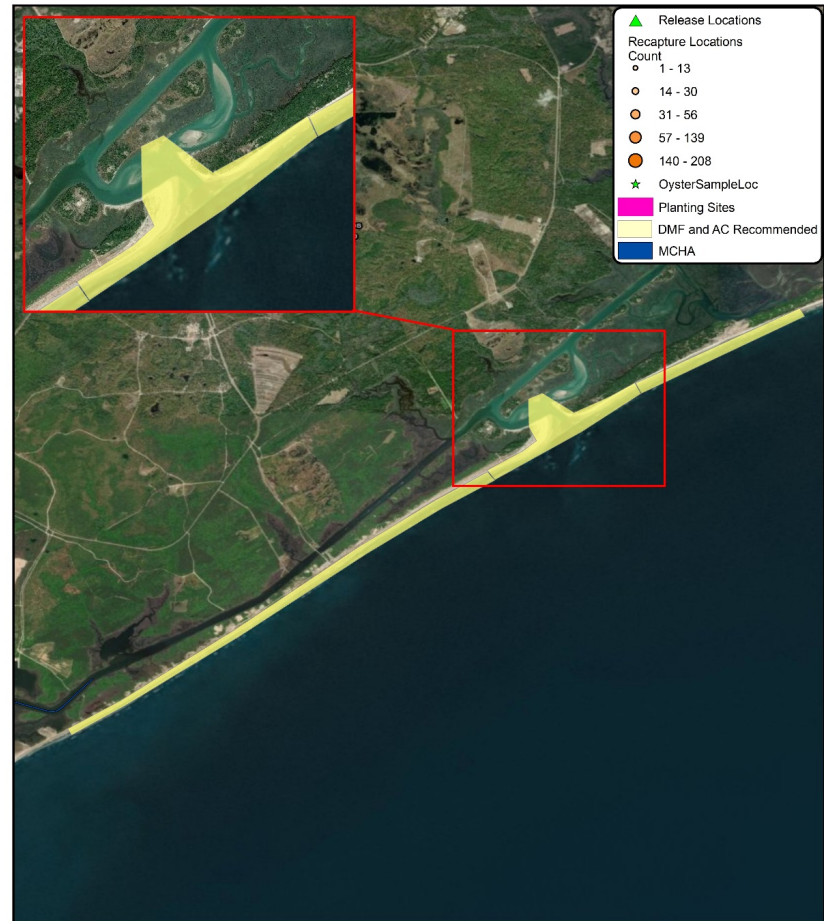
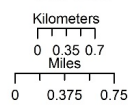


Figure 4.4.8. Proposed locations of new Crab Spawning Sanctuary boundaries for Beaufort and Bogue inlets. MCHA = Mechanical clam harvest area, fishery open from December through the end of March.



**Crab Spawning Sanctuaries
(15A NCAC 03R .0110)**

Bear Inlet



Proposed Crab Spawning Sanctuaries

Browns Inlet

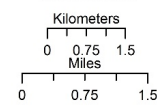
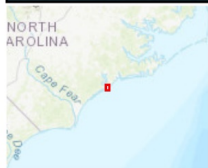
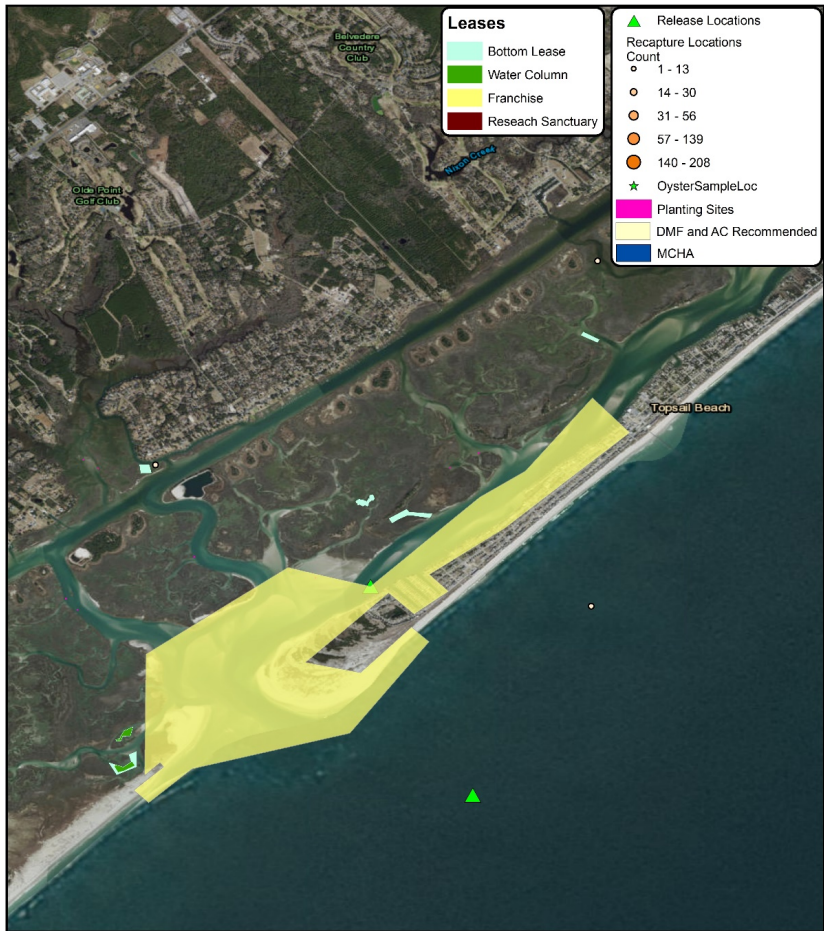
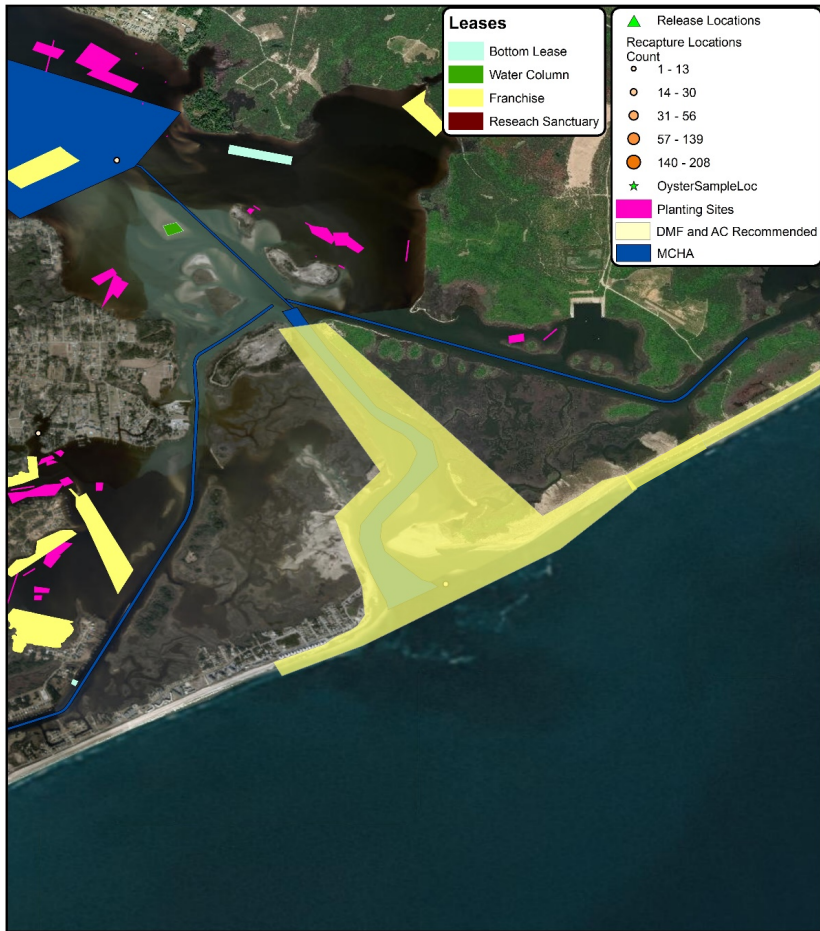
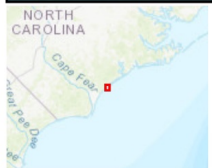
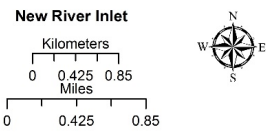


Figure 4.4.9. Proposed locations of new Crab Spawning Sanctuary boundaries for Bear and Browns inlets. MCHA = Mechanical clam harvest area, fishery open from December through the end of March.



Proposed Crab Spawning Sanctuaries



Proposed Crab Spawning Sanctuaries

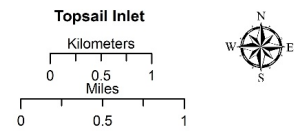


Figure 4.4.10. Proposed locations of new Crab Spawning Sanctuary boundaries for New River and Topsail inlets. MCHA = Mechanical clam harvest area, fishery open from December through the end of March.

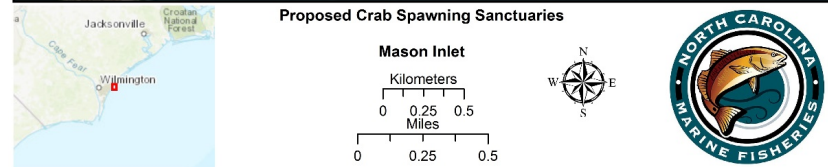
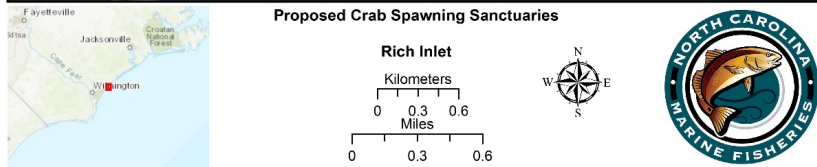
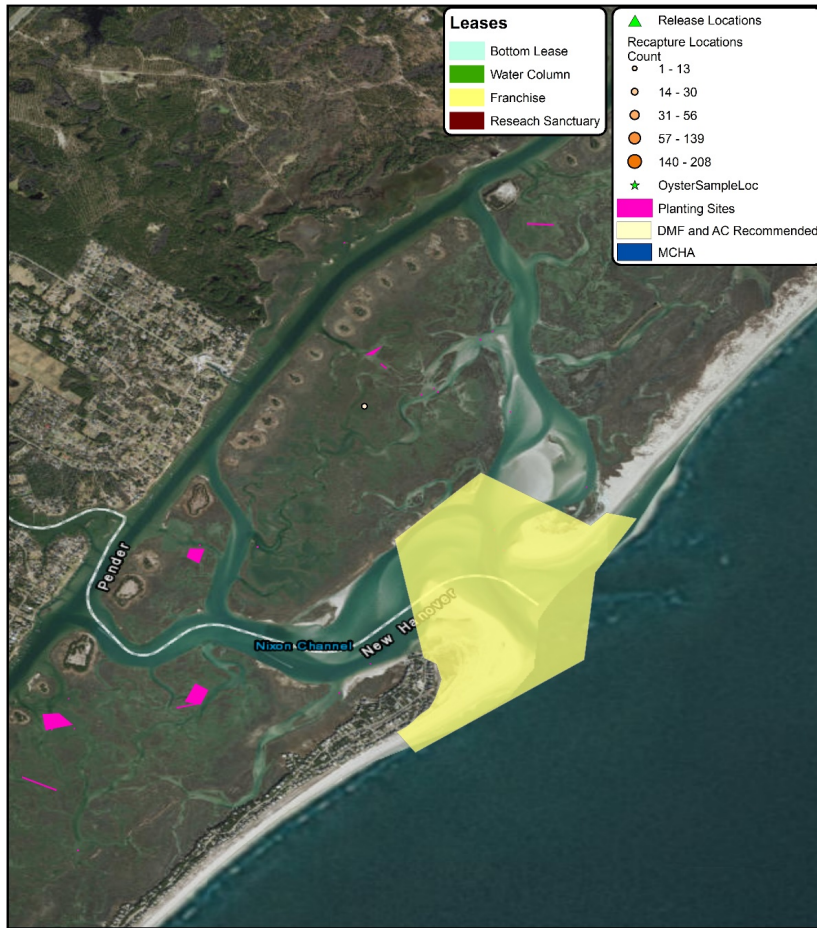


Figure 4.4.11. Proposed locations of new Crab Spawning Sanctuary boundaries for Rich and Mason inlets. MCHA = Mechanical clam harvest area, fishery open from December through the end of March.

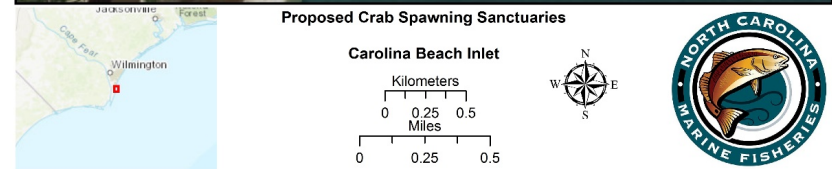
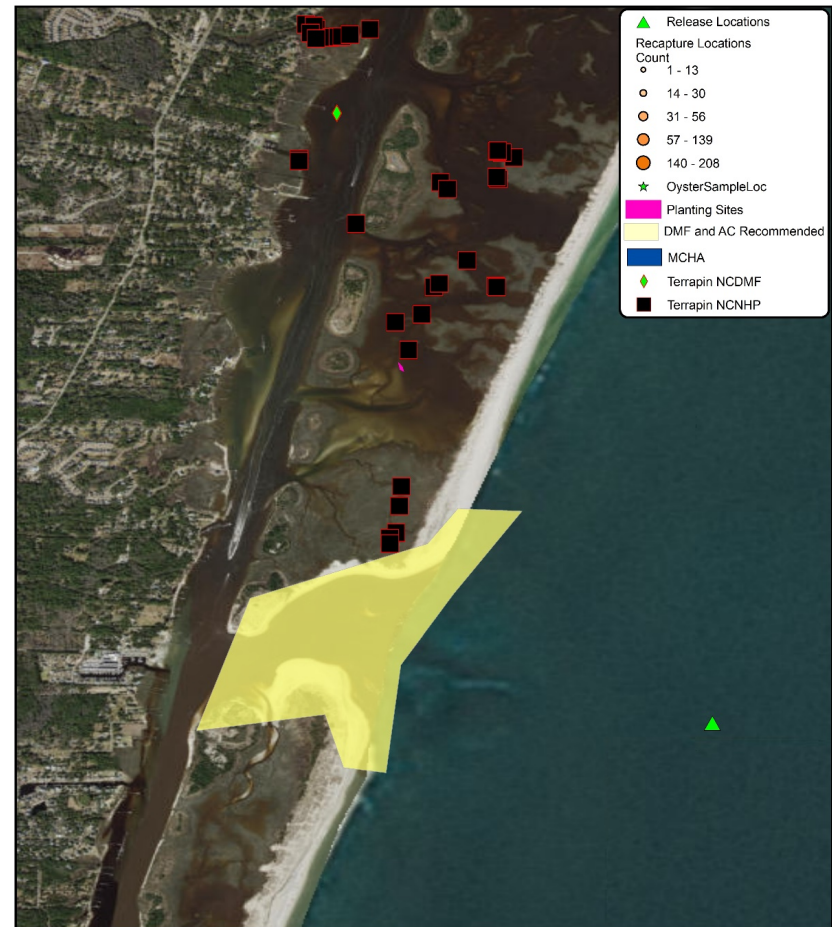
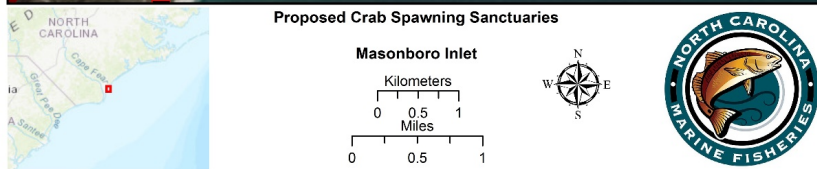
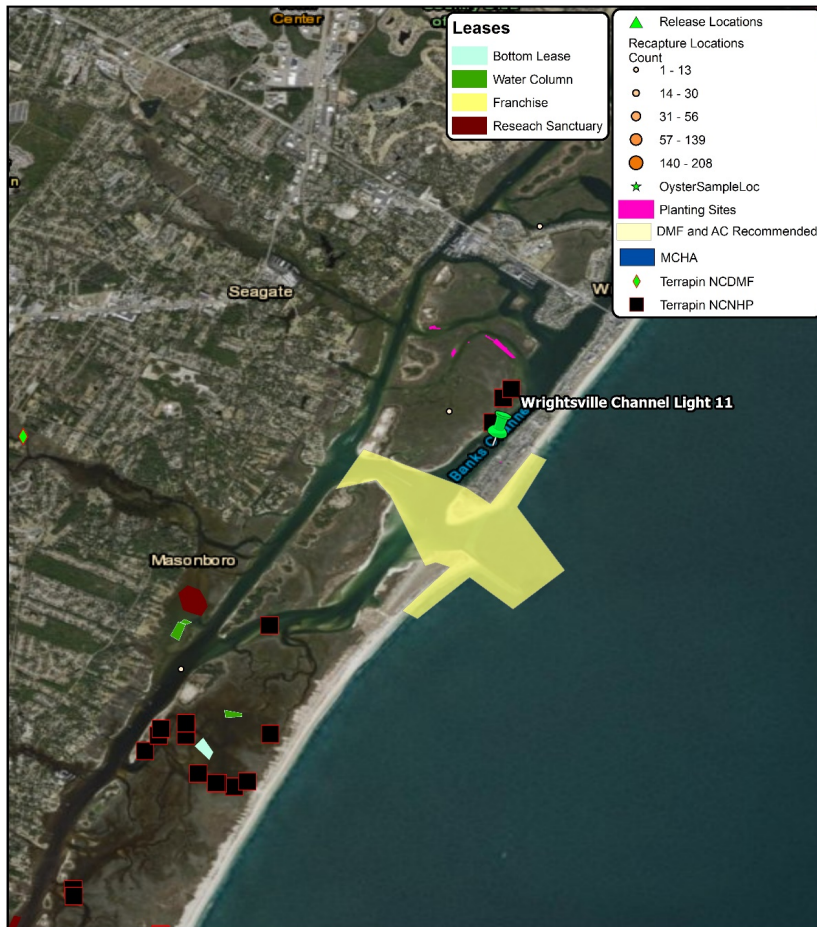
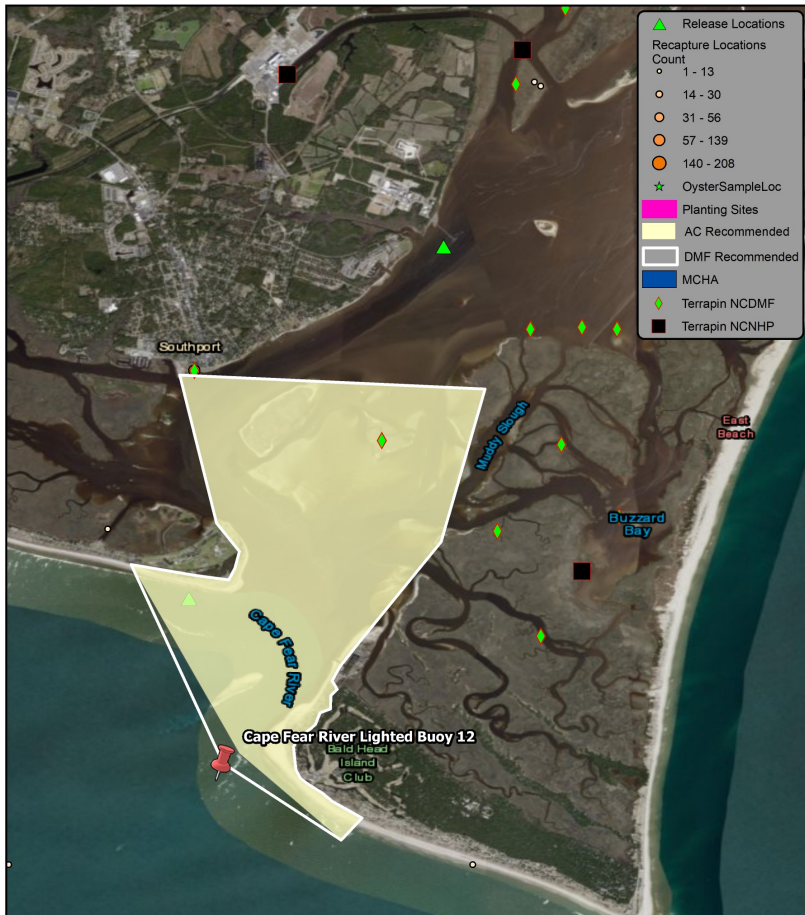


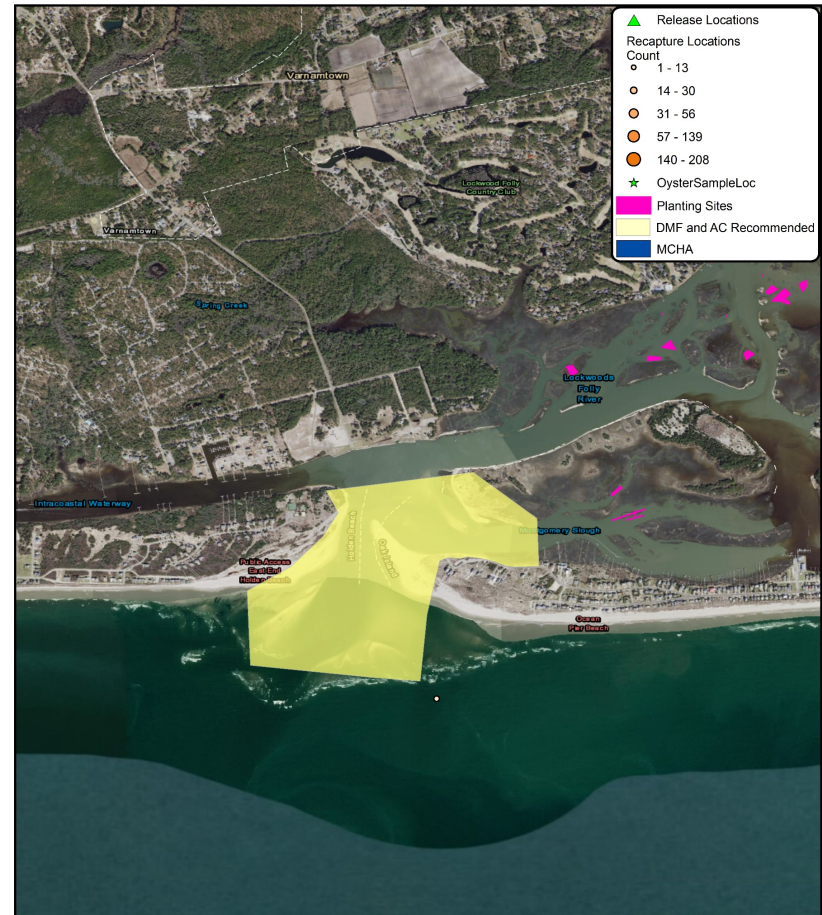
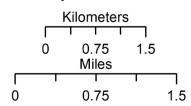
Figure 4.4.12. Proposed locations of new Crab Spawning Sanctuary boundaries for Masonboro and Carolina Beach inlets. MCHA = Mechanical clam harvest area, fishery open from December through the end of March.



Proposed Crab Spawning Sanctuaries



Cape Fear Inlet



Proposed Crab Spawning Sanctuaries



Lockwood Inlet

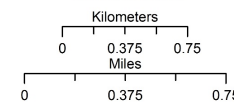


Figure 4.4.13. Proposed locations of new Crab Spawning Sanctuary boundaries for Cape Fear River and Lockwoods Folly inlets. MCHA = Mechanical clam harvest area, fishery open from December through the end of March.

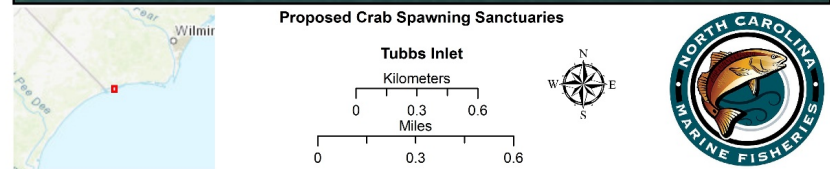
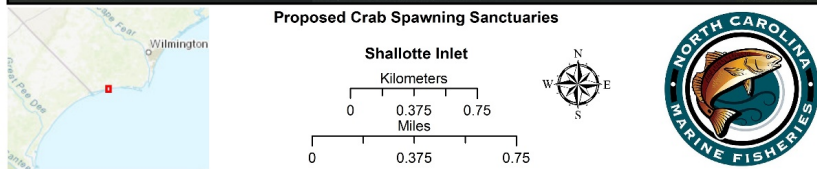
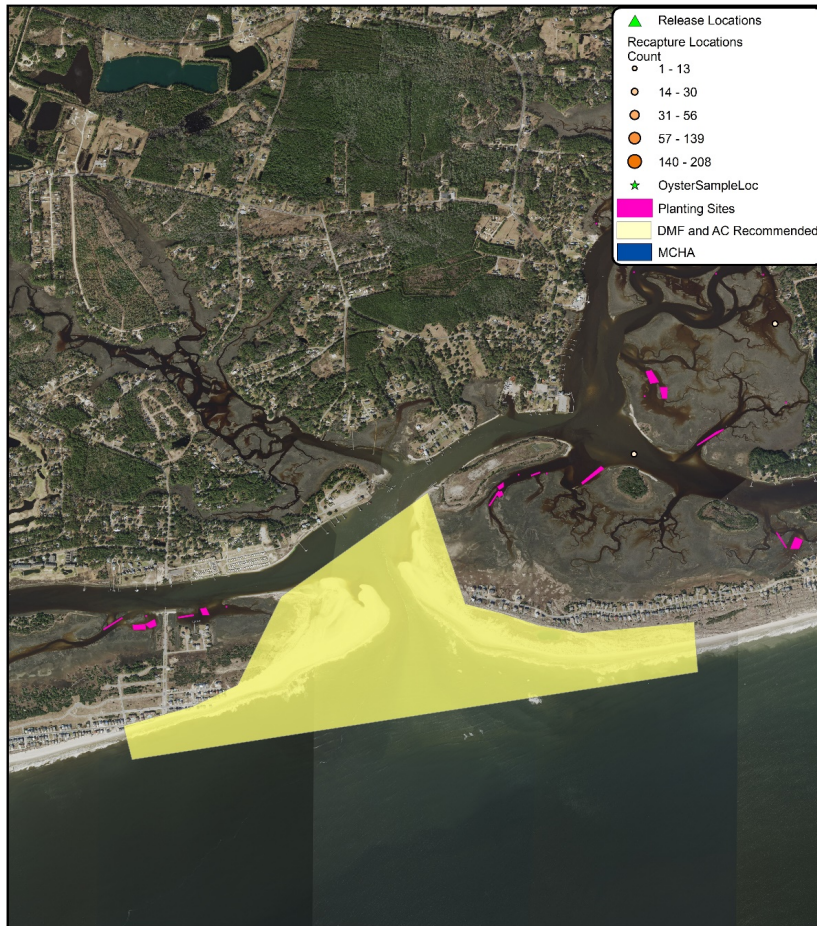


Figure 4.4.14. Proposed locations of new Crab Spawning Sanctuary boundaries for Shallotte and Tubbs inlets. MCHA = Mechanical clam harvest area, fishery open from December through the end of March.

Designation of a Crab Spawning Sanctuary to Serve as a Migration Corridor

Another option to consider is the designation of crab spawning sanctuaries that act as migration corridors leading to inlets but are not themselves associated with an inlet. These would be areas that serve as migration pathways for mature female blue crabs during their migration to coastal inlets. A similar management strategy has been adopted in the Virginia waters of the Chesapeake Bay and was highly effective (Figure 4.4.15).

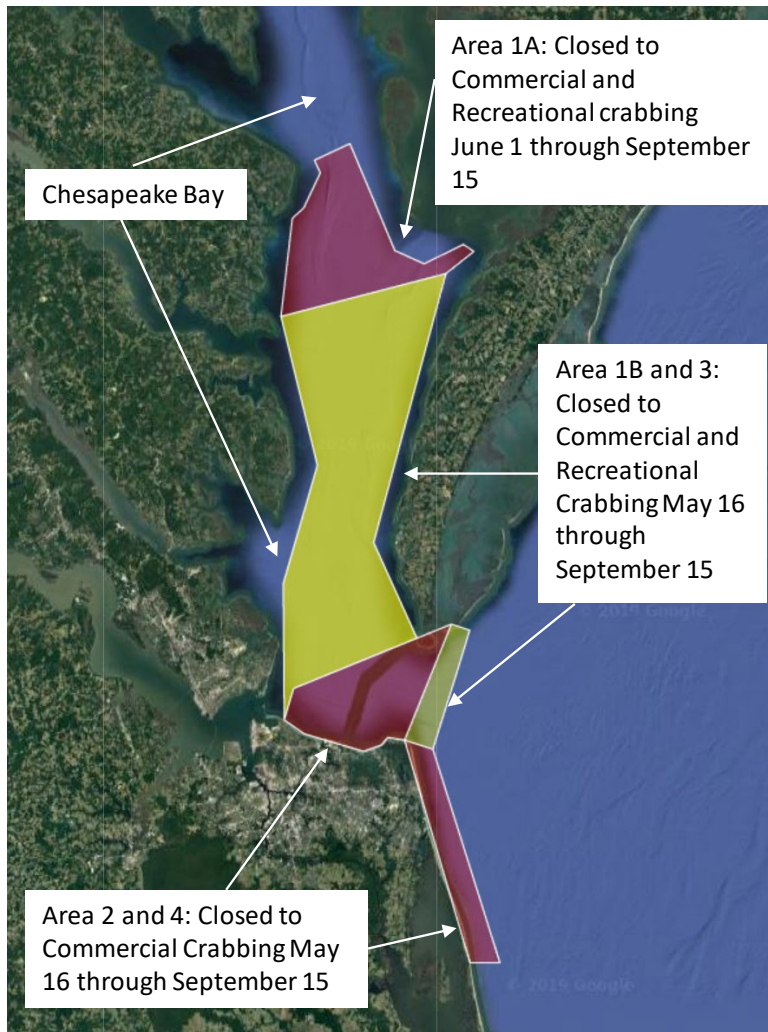


Figure 4.4.15. Virginia's Blue Crab Sanctuaries in the Chesapeake Bay including closure dates (https://webapps.mrc.virginia.gov/public/maps/crab_sanctuaries.php).

Although a distinct migratory corridor from mating sites in the Albemarle-Pamlico system to the spawning grounds was not detected by Eggleston et al. (8), there are several areas where mature female blue crabs are consistently more abundant. In 2002, results from the NCDMF Pamlico Sound Survey, supplemented by additional sampling in August, indicated that mature females were concentrated in northwest Pamlico Sound between Croatan Sound and Pamlico River in June. Mature female blue crabs were more than 50% less abundant in August and September but

there was no clear migratory pattern of movement toward the inlets. The crabs might have moved into shallower areas and grass beds that could not be trawled. Mature female blue crabs are known to commonly occur in the seagrass beds behind the Outer Banks during the summer (G. Allen, NCDMF personal communications) which could account for part of their migratory path.

Looking at the entire time series for the Pamlico Sound Survey (1987- 2017), mature female blue crabs are most concentrated in June north of Wysocking Bay and Buxton, across the entire sound (Figures 4.4.16 and 4.4.17). They are also concentrated to a lesser extent in Pungo and lower Pamlico rivers, and Croatan Sound. Additionally, mature female blue crabs occurred throughout the entire area in low numbers (1-50 crabs/trawl). In June, prevailing southwest winds in northern Pamlico Sound would help to push crabs toward Oregon Inlet. Females in the southern Pamlico Sound are closer to Ocracoke, Drum, and Barden inlets. In September, there was overall lower crab abundance and they were concentrated further north in Pamlico and Croatan sounds. In the southern portion of the sound, mature females were concentrated at the mouth of the Pamlico River.

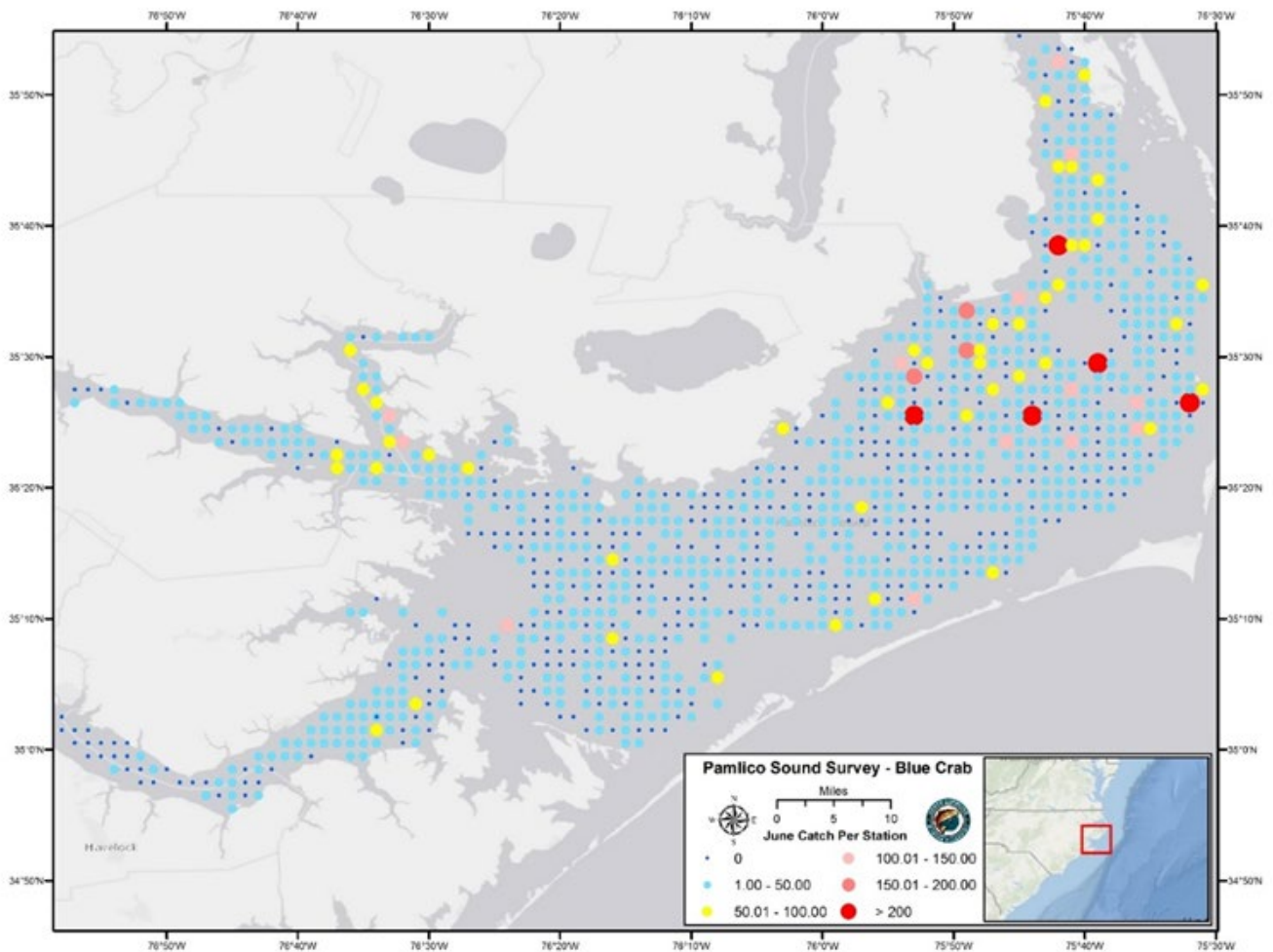


Figure 4.4.16. Total number of mature female blue crabs from Pamlico Sound Survey in June, 1987-2017.

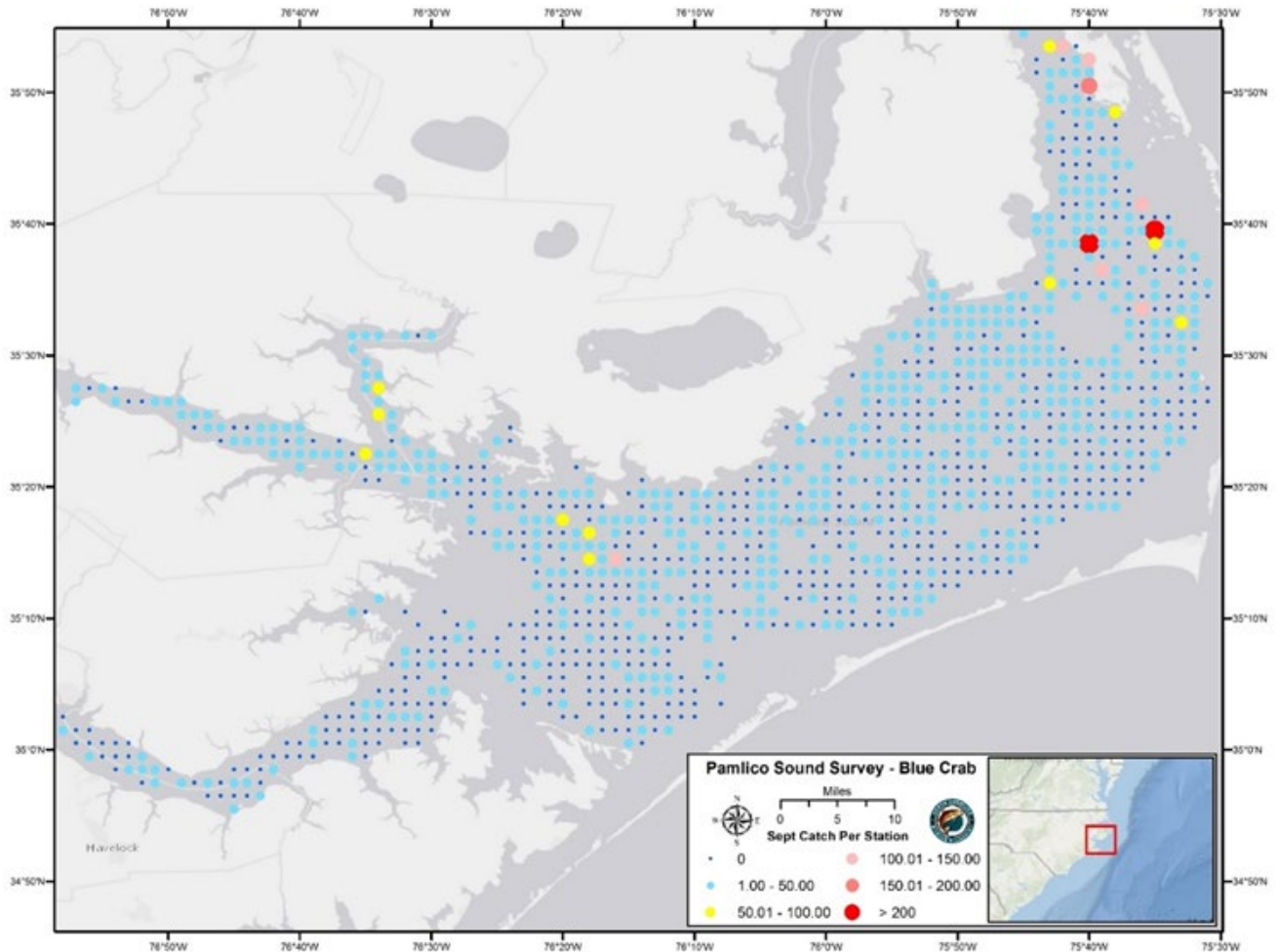


Figure 4.4.17. Total number of mature female blue crabs from Pamlico Sound Survey in September, 1987-2017.

To further evaluate where concentrations of mature females occur seasonally, a GIS tool, Optimal Hot Spot Analysis, was used. This GIS tool identifies statistically significant spatial clusters of high values (hot spots) and low values (cold spots). This tool works by analyzing each feature (sampling grid) within the context of neighboring features. A feature with a high value is interesting but may not be a statistically significant hot spot. To be a statistically significant hot spot, a feature will have a high value and be surrounded by other features with high values as well. The local sum for a feature and its neighbors is compared proportionally to the sum of all features; when the local sum is very different from the expected local sum and when that difference is too large to be the result of random chance a statistically significant score results.

An Optimal Hot Spot Analysis was conducted by T. Udouj, SEAMAP, using mature female blue crab abundance data from the Pamlico Sound Survey. Figures 4.4.18 and 4.4.19 show the resulting maps for mature females in summer and fall months using the same Pamlico Sound Survey dataset as shown in Figures 4.4.16 and 4.4.17 of actual abundance data. Maps are symbolized based on the confidence level.

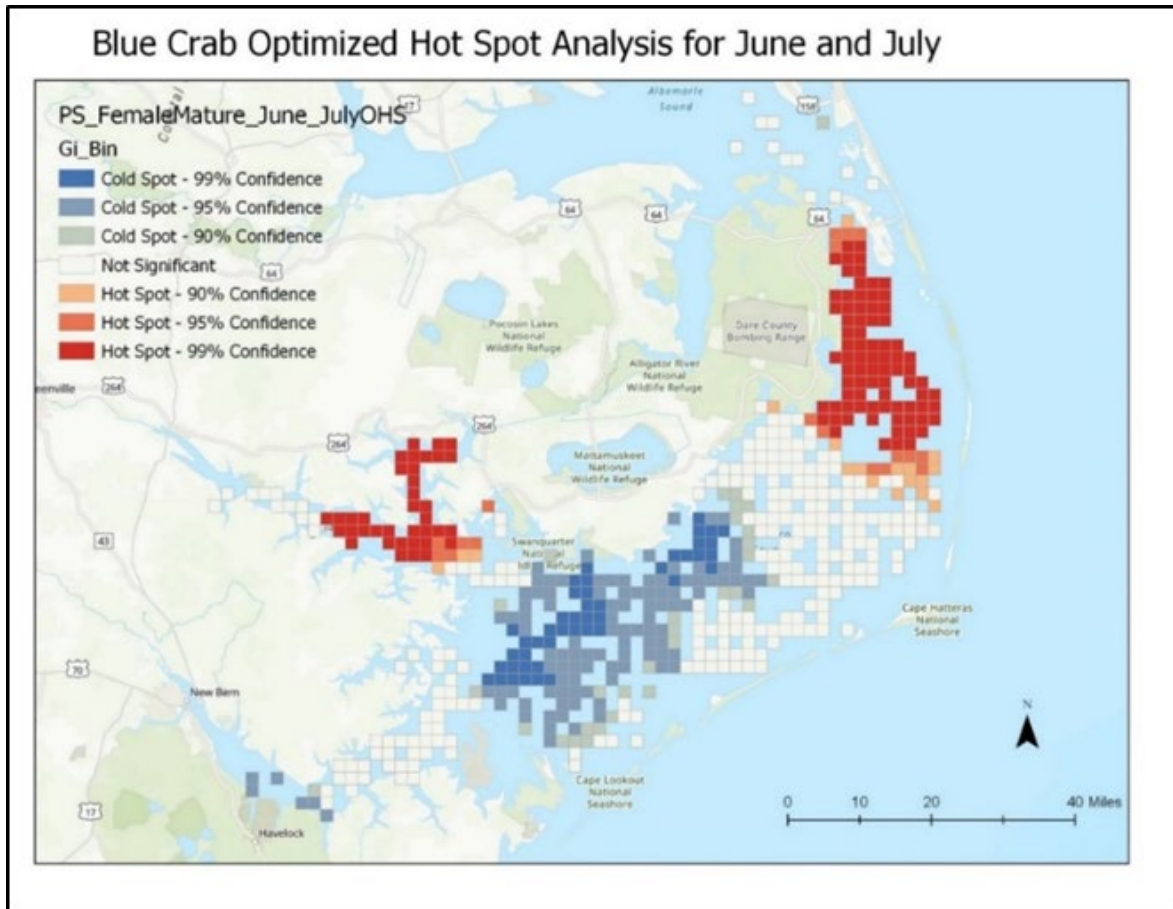


Figure 4.4.18. Areas with high confidence of having exceptionally high (red) or low (blue) numbers of mature female blue crabs from Pamlico Sound Survey in June and July, 1987-2017.

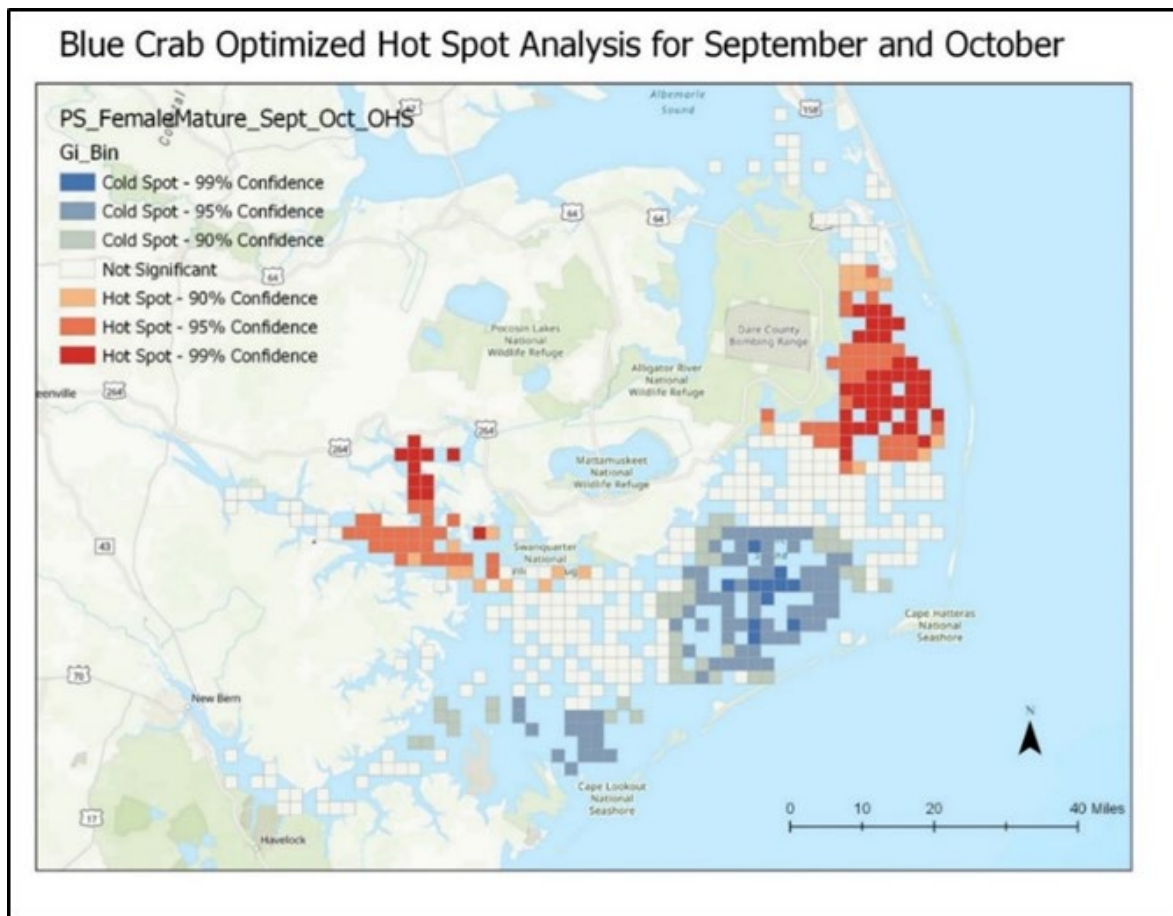


Figure 4.4.19. Areas with high confidence of having exceptionally high (red) or low (blue) numbers of mature female blue crabs from Pamlico Sound Survey in September-October, 1987-2017.

The results for June indicate there is a high probability (95-99%) of high concentrations of mature female blue crabs in Croatan and northern Pamlico sounds and in the Pungo River and lower Pamlico River (red areas; Figure 4.4.18). The results for September are similar, with the confidence values slightly lower (90%; Figure 4.4.19). Creation of a designated migration corridor in Croatan and northern Pamlico sounds, coinciding with the hot spots shown in Figures 4.4.18 and 4.4.19 is a management option to consider that is strongly supported by the data.

Advantages of an expanded sanctuary system and migration corridor include minimizing mortality and increasing protection of mature female blue crabs migrating to the spawning grounds. The economic impact to fishermen can be minimized by limiting the temporal and spatial extent of the protected area. Similarly, a migration corridor could be designated from the Pungo River to the nearest inlet spawning grounds. However, more information on mature female migration routes between the Pungo River, lower Pamlico River, and the inlets is needed to further define those migration corridors.

Data indicates Croatan Sound is a migration corridor for mature female blue crabs as they migrate out of Albemarle and Currituck sounds toward Oregon Inlet to spawn. In the Chesapeake Bay, Virginia opted for a summer closure in the deeper waters of the bay to help mature females

migrate to the spawning grounds. A similar strategy could be adopted for the deeper waters of Croatan Sound to help protect mature females once they have mated and begin to migrate toward the spawning grounds. Figure 4.4.20 shows an area that could be designated as a migration corridor and how this area overlaps with the previously identified hot spots. The size of the example migration corridor is approximately 19,948 acres. The timing of landings peaks of hard, soft, and peeler blue crabs throughout the year may help indicate migration timing and indicate a seasonal closure period that would enhance the protection of mature female blue crabs in the waters of Croatan Sound (Tables 4.4.5 and 4.4.6).

Table 4.4.5. Commercial hard blue crab landings trends by Trip Ticket waterbody, 2012-2016.

Waterbody	Landings Peak	Largest Landings Increase	Landings		Landings Decrease Percent*
			Increase Percent*	Largest Landings Decrease	
Chowan River	August	July-August	29	September-October	35.7
Perquimans River	August	July-August	11.2	September-October	12.1
Pasquotank River	August	May-June	9	October-November	11.3
Alligator River	October	April-May	7.9	October-November	10.8
Albemarle Sound	September	May-June	8	October-November	10.4
Currituck Sound	June	April-May	10.3	October-November	8.3
Croatan Sound	October	September-October	11	November-December	11.6
Roanoke Sound	October	September-October	11.2	November-December	12.0
Pamlico Sound	June	March-April	5.2	November-December	6.6

*The landings difference between months is the month to month difference in the percent of annual landings. For example, if January is 5% of the annual landings and February is 20% then the month to month difference in annual landings percent is 15%.

Table 4.4.6. Commercial soft and peeler blue crab landings trends by Trip Ticket waterbody, 2012-2016.

Waterbody	Landings Peak	Largest Landings Increase	Landings		Landings Decrease Percent*
			Increase Percent*	Largest Landings Decrease	
Chowan River	September	July-August	36.1	September-October	60.3
Perquimans River	May/August	April-May	23.2	May-June	14.0
Pasquotank River	May	April-May	84.9	May-June	83.9
Alligator River	May	April-May	52.3	May-June	45.1
Albemarle Sound	May	May-June	58.6	May-June	55.0
Currituck Sound	May	April-May	64.3	May-June	72.9
Croatan Sound	May	April-May	61.2	May-June	68.9
Roanoke Sound	May	April-May	64.6	May-June	74.4
Pamlico Sound	May	April-May	44.8	May-June	58.9

*The landings difference between months is the month to month difference in the percent of annual landings. For example, if January is 5% of the annual landings and February is 20% then the month to month difference in annual landings is 15%.

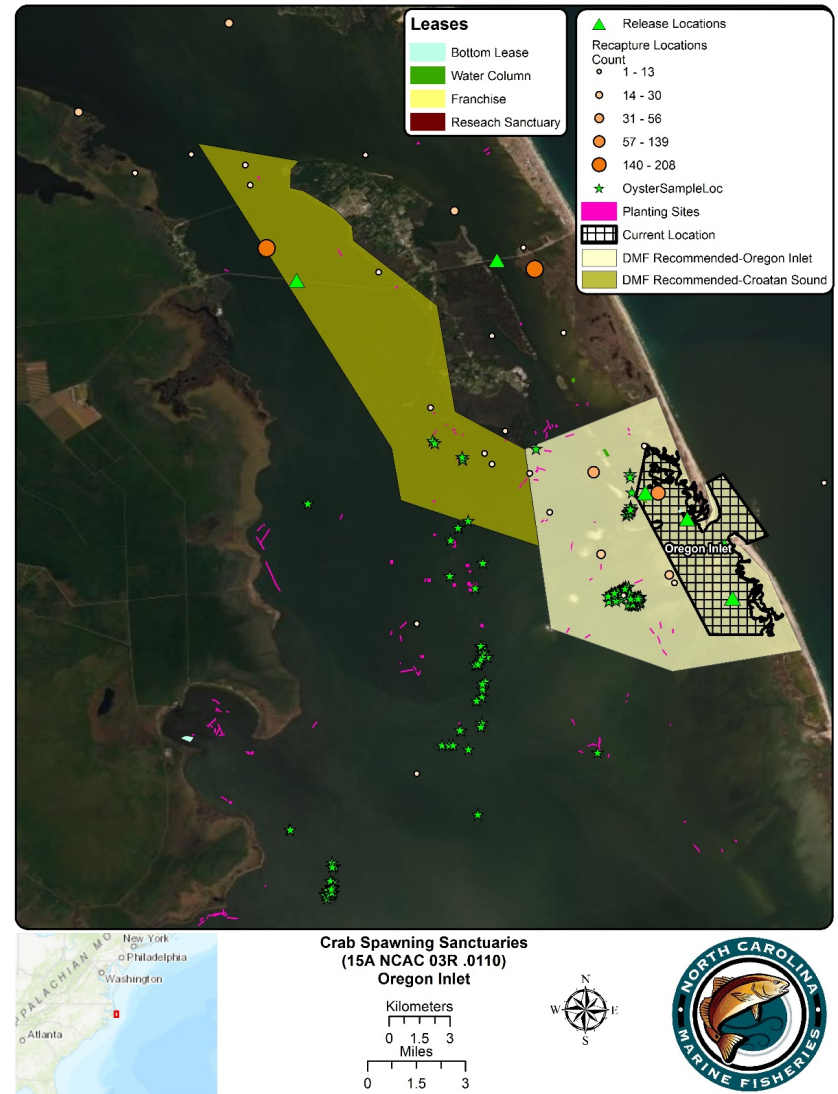
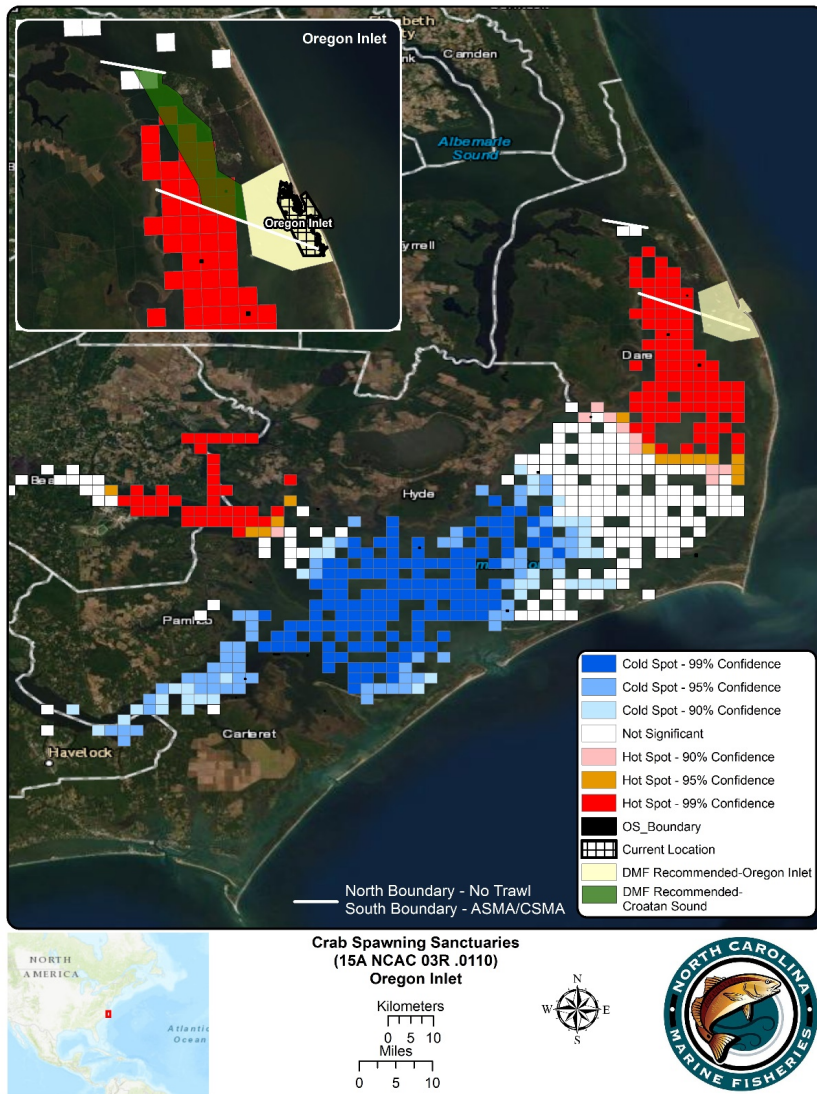


Figure 4.4.20. Location of proposed migration corridor through Croatan Sound in relation to the hot spot analysis results (left) and in relation to the NCDMF recommended Oregon Inlet crab spawning sanctuary expansion (right).

VI. PROPOSED RULES(S)

N/A

VII. MANAGEMENT OPTIONS AND IMPACTS

(+ Potential positive impact of action)

(- Potential negative impact of action)

Below are overarching positive and negative impacts for all options, specific impacts from an option may be found below that option.

- + Will protect additional mature female blue crabs from harvest to allow spawning to occur, potentially leading to increased population size
- + Will reduce some bycatch of finfish where new sanctuaries are established
- + Reduces damage or mortality of sponge crabs from incidental harvest
- Potential for decreased harvest of blue crabs with economic loss to the fishery
- Potential negative impact to the shrimp, oyster, and clam fisheries (depending on management strategy chosen)

1. Expand the boundaries of the five existing crab spawning sanctuaries
2. Establish new crab spawning sanctuaries at all inlets without a crab spawning sanctuary
3. Establish a crab spawning sanctuary to serve as a migration corridor in Croatan Sound
4. Close crab spawning sanctuaries around inlets from March 1 through October 31 to the use of trawls, pots, and mechanical methods for oysters or clams and to the taking of crabs with any commercial fishing equipment
5. Close crab spawning sanctuaries around inlets year-round to the use of trawls, pots, and mechanical methods for oysters or clams and to the taking of crabs with any commercial fishing equipment

VIII. RECOMMENDATION

NCMFC Selected Management Strategy

- Maintain existing boundaries for the Oregon, Hatteras, and Ocracoke inlets crab spawning sanctuaries
- Move the boundary of the Drum Inlet sanctuary to encompass Ophelia Inlet
- Expand the Barden Inlet sanctuary boundary to the proposed boundary lines
- Add spawning sanctuaries from Beaufort through Tubbs inlets using AC recommended boundaries (except for Cape Fear River)
- Use NCDMF recommended boundary for Cape Fear River Inlet sanctuary
- Closure period of March 1 through October 31 for new sanctuaries with the same restrictions as existing sanctuaries

IX. LITERATURE CITED

1. NCDMF. 2016. May 2016 Revision to Amendment 2 to the North Carolina Blue Crab Fishery Management Plan. North Carolina Department of Environmental Quality, Division of Marine Fisheries. Morehead City, NC. 53 p.
2. Darnell MZ, D. Rittschof, K.M. Darnell, and R.E. McDowell. 2009. Lifetime reproductive potential of female blue crabs *Callinectes sapidus* in North Carolina, USA. Marine Ecology Progress Series 394:153–163.
3. Medici D., T. Wolcott, and D. Wolcott. 2006. Scale-dependent movements and protection of female blue crabs (*Callinectes sapidus*). Can. Journal of Fishery Aquatic Science. 63: 858–871. (doi:10.1139/ f05-263).
4. Ballance, E.S. and E.F. Ballance. 2004. Blue crab sampling in the vicinity of the Ocracoke and Hatteras inlet blue crab spawning sanctuaries using crab pots. NC Blue Crab Research Program, Final Report. – BCRP #01-POP-04. NC Sea Grant, Raleigh, NC. 42 p.
5. Ballance, E.S. 2008. Blue crab sampling in the vicinity of the Oregon, Drum, and Barden’s inlet blue crab spawning sanctuaries using crab pots. NC Blue Crab Research Program, Final Report. – BCRP #06-POP-03. NC Sea Grant, Raleigh, NC 36 p.
6. Ballance, E.S. 2009. Blue crab sampling in the vicinity of the Oregon inlet blue crab spawning sanctuary using crab pots. NC Blue Crab Research Program, Final Report. – BCRP #07-POP-03. NC Sea Grant, Raleigh, NC. 29 p.
7. NCDMF (North Carolina Division of Marine Fisheries). 2008. Assess the effects of hurricanes on North Carolina’s blue crab resource. NC Department of Environmental Resources, Division of Marine Fisheries. Morehead City, NC. 176 p.
8. Eggleston, D.B., G.W. Bell and S.P. Searcy. 2009. Do blue crab spawning sanctuaries in North Carolina protect the spawning stock. Transactions of the American Fisheries Society 138(3): 581-592, DOI: 10.1577/T08-070.1
9. Darnell, M.Z., D. Rittschof, and R.B. Forward. 2010. Endogenous swimming rhythms underlying the spawning migration of the blue crab, *Callinectes sapidus*: ontogeny and variation with ambient tidal regime. Marine Biology. 157: 2415. <https://doi.org/10.1007/s00227-010-1506-5>
10. Darnell, M.Z., T.G. Wolcott, and D. Rittschof. 2012. Environmental and endogenous control of selective tidal-stream transport behavior during blue crab *Callinectes sapidus* spawning migrations. Marine Biology. 159: 621. <https://doi.org/10.1007/s00227-011-1841-1>.
11. Carr, S.D., R.A. Tankersley, J.L. Hench, R.B. Forward, R.A. Luetlich. 2004. Movement patterns and trajectories of ovigerous blue crabs *Callinectes sapidus* during the spawning migration. Estuarine Coastal and Shelf Science 60:567–579.
12. Ramach S.M., M.Z. Darnell, N.G. Avissar, D. Rittschof. 2009. Habitat use and population dynamics of blue crabs, *Callinectes sapidus*, in a high-salinity embayment. Journal of Shellfish Research. 28:635–640.
13. Carr, S.D., J.L. Hench, R.A. Luetlich Jr., R.B. Forward Jr., R.A. Tankersley. 2005. Spatial patterns in the ovigerous *Callinectes sapidus* spawning migration: results from a coupled behavioral-physical mode. Marine Ecology Progress Series 294: 213-226.
14. Eggleston, D.B., E. Millstein, and G. Plaia. 2015. Timing and route of migration of mature female blue crabs in a tidal estuary. Biology Letters. 11: 20140936. <http://dx.doi.org/10.1098/rsbl.2014.0936>

15. Alphin, T. and M. Posey. 2007. Assessment of blue crab distribution in the Cape Fear River Estuary. NC Blue Crab Research Program, Final Report. – BCRP #05pop03. NC Sea Grant, Raleigh, NC. 16 p.
16. Alphin, T. and M. Posey. 2010. Assessment of blue crab distribution in the New River Estuary during spawning season. NC Blue Crab Research Program, Final Report. – BCRP #05pop03. NC Sea Grant, Raleigh, NC. 13 p.
17. Lipcius R, W. Stockhausen, W. Seitz, and P. Geer. 2003. Spatial dynamics and value of a marine protected area and corridor for the blue crab spawning stock in Chesapeake Bay. *Bulletin of Marine Science*. 72: 453– 470.
18. Aguilar, R., E.G. Johnson, A.H. Hines, M.A. Kramer, and M.R. Goodison. 2008. Importance of blue crab life history for stock enhancement and spatial management of the fishery in Chesapeake Bay. *Reviews in Fisheries Science*. 16(1-3): 117-124.
19. Rittschof, D. 2003. Migration and reproductive potential of mature female blue crabs. NC Blue Crab Research Program, Final Report (July 2003). BCRP #01-BIOL-05. North Carolina Sea Grant, Raleigh, NC. 29 p.
20. Ogburn, M.B. and L.C. Habegger. 2015. Reproductive status of *Callinectes sapidus* as an indicator of spawning habitat in the South Atlantic Bight, USA. *Estuaries and Coasts* 38:2059–2069.

APPENDIX 4.5: ESTABLISH A FRAMEWORK TO IMPLEMENT THE USE OF TERRAPIN EXCLUDER DEVICES IN CRAB POTS

I. ISSUE

Establish a framework for developing proclamation use criteria and terrapin excluder specifications to reduce interactions of diamondback terrapins (*Malaclemys terrapin*) with crab pots.

II. ORIGINATION

North Carolina Marine Fisheries Commission (NCMFC) selected management strategy in Amendment 2 of the Blue Crab Fishery Management Plan.

III. BACKGROUND

The NCMFC adopted Amendment 2 of the North Carolina Blue Crab Fishery Management Plan (FMP) in November 2013 (1). In this plan, the NCMFC recognized diamondback terrapins as a wildlife resource in need of protection from crab pot fishing activities under its jurisdiction and sought to proactively implement conservation measures to prevent localized diamondback terrapin depletions or extirpations through incidental bycatch from current or future activity in the blue crab fishery. To implement this selected management strategy, the NCMFC granted proclamation authority for the director of the North Carolina Division of Marine Fisheries (NCDMF) to require terrapin excluder devices to be used in crab pots. This proclamation authority was placed in NCMFC Rule 15A NCAC 03L .0204(b), which became effective April 1, 2014. This rule states the Fisheries Director may, by proclamation, require the use of terrapin excluder devices in each funnel entrance in crab pots and impose the following restrictions concerning terrapin excluder devices: specify areas; specify time periods; and specify means and methods.

This issue paper develops proclamation issuance criteria necessary to implement the NCMFC management strategy and proposes a framework by which the NCDMF would determine discrete “diamondback terrapin management areas” (DTMAs) where all crab pots fished within would be required to use NCDMF approved terrapin excluder devices or modified pot designs. Once accepted by the NCMFC, this framework would be used to determine appropriate locations of DTMA’s across coastal North Carolina. The issue of incidental capture of diamondback terrapins and use of excluders to prevent terrapin bycatch in crab pots in the North Carolina blue crab fishery is thoroughly reviewed in the issue paper “Diamondback Terrapin Interactions with the Blue Crab Pot Fishery” in sections 11.12 and 12.1.5.2 of the 2013 Blue Crab FMP Amendment 2

Diamondback terrapins were moved from “Near Threatened” to the greater risk category “Vulnerable” on the Red List of Threatened Species by the International Union for Conservation of Nature (IUCN) after their most recent assessment in 2018. Ongoing range-wide population declines due to accidental mortality as bycatch in commercial Blue Crab fisheries, and coastal habitat impacts due to development were cited as primary justifications for moving this species

into the increased risk category. The North Carolina Wildlife Resources Commission (NCWRC) lists diamondback terrapin as a North Carolina species of “Special Concern” statewide and as a Federal “Species of Concern” in Dare, Pamlico and Carteret counties in NC. The status of “Special Concern” or “Species of Concern” does not specifically provide any special protection under the federal Endangered Species Act, however the federal status may be upgraded to “Threatened” or “Endangered” if natural or human-made factors are affecting its continued existence, or there is an inadequacy of existing regulatory mechanisms in place (e.g. unmitigated mortality from bycatch in crab pots). In February 2011, the NCWRC Nongame Wildlife Advisory Committee received a report from the Scientific Council on Amphibians and Reptiles which recommended the diamondback terrapin be listed as “Threatened” (2). This report, citing a large body of evidence from numerous studies, concluded incidental bycatch in crab pots is the most serious threat to diamondback terrapins in North Carolina (3; 4; 5; 6). Seafood Watch, one of the best-known seafood consumer awareness programs, gives the North Carolina blue crab fishery their lowest rating of “Avoid”, stating that serious concerns about the lack of implementation of any regulations to protect diamondback terrapins from bycatch in crab pots are the primary reason for this poor rating (7).

Diamondback terrapins are found throughout North Carolina’s high salinity coastal marshes however; all coastal areas do not contain suitable terrapin habitat (8). Diamondback terrapins are long-lived, late to mature, and display relatively low fecundity (9). Delayed sexual maturity and low reproductive rates, coupled with long life spans and strong site fidelity, make this species susceptible to substantial population declines or even localized extirpations through the incidental bycatch and removal of a relatively low number of individuals from the population annually ([3; 6).

Genetic analysis (10) of diamondback terrapins sampled from Massachusetts to Texas suggests at least four major regional population groupings across this range, with North Carolina diamondback terrapins belonging to the Coastal Mid-Atlantic grouping. Although diamondback terrapins display high site fidelity, there is enough movement of individuals to maintain long term gene flow within these larger regional scales (10).

Several factors have been identified in determining the likelihood of diamondback terrapin bycatch in crab pots where crab fishing activities and diamondback terrapin occurrence overlap, such as: water depth and distance from shore (11; 12; 13; 14; 15), presence or dimensions of the excluder device (16; 17; 12; 15; 18; 19; 20; 21; 22), and the season which fishing occurs (11; 12; 13; 15; 23). Taking these factors into consideration, diamondback terrapin mortality from incidental bycatch in crab pots can be mitigated, reducing population impacts from localized and regional extinctions within North Carolina, and maintaining genetic connectivity across the Coastal Mid-Atlantic population.

Using the known factors affecting diamondback terrapin bycatch in crab pots, a highly targeted approach to reducing bycatch mortality with the least potential impact to the statewide blue crab fishery can be developed through the establishment of discrete regional DTMA’s. This approach would be employed in lieu of either a statewide requirement for terrapin excluder devices to be used on all crab pots, or the prohibition of crab pots from specific areas. This issue is being addressed as part of Amendment 3 instead of being implemented in between FMP amendments

due to the scheduled review of the blue crab FMP moved to 2016/2017 on the schedule by the NCMFC in August 2016.

The NCDMF used the following framework to develop criteria for using terrapin excluder devices:

Determine NCDMF approved terrapin excluder device types and sizes to be required.
Determine dates when terrapin excluder devices will be required in crab pots.
Identify the zone of potential diamondback terrapin interaction with crab pots.
Validate diamondback terrapin presence and overlap with potential crab pot interaction zone.
Determine appropriate management area boundaries.
Produce an information paper, present to appropriate regional advisory committee, and receive public comment concerning the proposed DTMA.
Draft proclamation for issuance by NCDMF.

IV. AUTHORITY

North Carolina General Statute 113-134 – Rules
North Carolina General Statute 113-182 – Regulation of fishing and fisheries
North Carolina General Statute 113-182.1. Fishery Management Plans
North Carolina General Statute 113-221.1 – Proclamations; emergency review
North Carolina General Statute 143B-289.52 – Marine Fisheries Commission – powers and duties
NCMFC Rule 15A NCAC 03H .0103 – Proclamations, General
NCMFC Rule 15A NCAC 03J .0301 – Pots
NCMFC Rule 15A NCAC 03L .0201 – Crab Harvest Restrictions
NCMFC Rule 15A NCAC 03L .0204 – Crab Pots

V. DISCUSSION

Step 1 Determine NCDMF approved terrapin excluder device types and sizes

Multiple researchers across the range of diamondback terrapins have examined the effectiveness of terrapin excluder devices, also known as a bycatch reduction device, and their impact on the catch of blue crabs in the pot fishery. Table 4.5.1 provides a summary of these field studies by state. Across all studies the largest reduction in diamondback terrapin bycatch or the largest percent of potential diamondback terrapin exclusion typically occurred using terrapin excluder devices with the smallest vertical opening dimensions (Table 4.5.1). Impacts of terrapin excluder devices to crab catch ranged from 25.7% increased catch rates (24), to a 29% reduction in crab catch rates (25), as well as reduction in the average carapace width of crabs captured (20; 21). Numerous studies have also concluded that specific dimensions of terrapin excluder devices result in no significant reduction in size or catch rate of blue crabs when compared to control pots without terrapin excluder devices. However, some studies that did not find statistically significant differences in crab catch or sizes between control pots and pots with terrapin excluders did acknowledge a trend towards a reduced blue crab catch when terrapin excluders are in place (18; 19). Longer blue crab retention times in pots which employed excluder devices

has been shown to mitigate catch rate impacts from lower numbers of crabs entering pots with excluders, resulting in no net loss in overall catch (20). However, from a theoretical modeling approach, which analyzed over 8,000 possible terrapin excluder dimensions (between 3.2 x 5.1 cm and 16 x 16 cm) compared to field collected morphometric dimension of terrapins, the overall excluder opening area followed by the diagonal excluder opening dimension were found to have the greatest predictive relationship with the exclusion of terrapins (22).

Shell height has often been concluded to be the determining dimension in the exclusion of diamondback terrapins from crab pots (16), and across multiple studies rectangular excluders with a vertical opening of 4 cm (1.6 in) or less have been the most effective (Table 4.5.1). In one Virginia study, excluders which prevent terrapins from entering based on shell height were shown to allow the same number of terrapins to be captured in pots when compared to those which prevent entry based on shell width, however based on terrapin measurements simultaneously captured in pots without excluders, the devices which limited by shell width had greater potential exclusion (21). Requiring the use of a terrapin excluder device which restricts entry based on shell height, with a horizontal width less than 16 cm (6.3 in.), the typical width of a crab pot throat, may not result in any additional reduction in diamondback terrapin bycatch if the horizontal opening of the device is no larger than 4 cm (1.6 in.). In North Carolina a 4 x 16 cm (1.6 x 6.3 in.) excluder was shown to offer 100% reduction in potential terrapin capture (15). In South Carolina a relatively square shaped “SC design” excluder with a slightly curved top and bottom 5.1-6.4 x 7.3 cm (2-2.5 x 2.9 in.) which restricts entry based on shell width, would exclude 33% more terrapins than two other commonly tested excluder devices, 5 x 10 cm (2 x 3.9 in.) and 4.5 x 12 cm (1.8 x 4.7 in.), and by increasing the width of this device of 0.4 cm (0.2 in.) 99% of legal-size blue crab would be captured (22). Excluder devices made of 11-gauge wire have been tested and have been recommended as an option in Virginia. However, crab pots with 11-gauge wire excluders do allow in large terrapins and wire excluders must be constructed of a gauge heavy enough to maintain rigidity (20). Pre-made plastic terrapin excluder devices may be purchased for approximately \$0.50 from manufacturers such as Top-Me Products or made even more inexpensively with at least 10-gauge (or thicker) wire and hog rings (Figure 4.5.1).

The effect of excluder orientation has also been examined. In a controlled aquarium setting, McKee et al. (26) tested the effect of a 5 x 15.2 cm (2 x 6 in.) excluder device mounted both horizontally and vertically on diamondback terrapin entry to crab pots. They found that although there was a 17.5% reduction in diamondback terrapin entries into pots with a horizontally mounted excluder when compared to control pots without an excluder, this difference was not statistically significant. However, the vertically mounted excluder did result in significantly lower amount of diamondback terrapin pot entries and significantly longer entry times when compared to both control and pots with horizontally mounted excluders.

Diamondback terrapins display sexual dimorphism in size, with males not growing as large in shell height and length as females. Small diamondback terrapins of either sex are vulnerable to capture. However, females grow to a shell height which prevents them from entering typical crab pots by the time they reach eight years of age, with mature males possibly remaining vulnerable to pot entrapment throughout their life (4). This difference in growth rate and ultimate size difference between the sexes leaves young individuals (both sexes) and males more vulnerable to capture in crab pots when using some terrapin excluder devices. The selective removal of

juveniles and males can lead to localized alterations in both population age structure and sex ratios, which can threaten the survival of the population (6). Due to geographic variation in diamondback terrapin body size, local evaluation of effective terrapin excluder device size may be required (27).

Hart and Crowder (15) in Jarrett Bay, off Core Sound, North Carolina, found using a 4 x 16 cm (1.6 x 6.3 in.) terrapin excluder device would have excluded 100% of all diamondback terrapins encountered during their research, however this would result in a 26.6% reduction in all legal sized male blue crabs captured, a 4.5 x 16 cm (1.8 x 6.3 in.) terrapin excluder device would have potentially excluded 77% of the total diamondback terrapins (100% female, 70% male) while reducing the legal male blue crab catch by 21.2%, and a 5 x 16 cm (2 x 6.3 in.) terrapin excluder device would have potentially excluded 28% of the total diamondback terrapins (50% female, 10% male). Based on pooled shell height data from diamondback terrapins captured by Southwood et al. (28) in Masonboro and Middle Sounds, North Carolina, a terrapin excluder device with a height of 4 cm (1.6 in.) would have excluded 91% of all diamondback terrapins (100% female, 80% male), a terrapin excluder device with a height of 4.5 cm (1.8 in.) would have excluded 51% of all diamondback terrapins (93% female, 0% male), and a terrapin excluder device with a height of 5 cm (2 in.) would have excluded 40% of the all diamondback terrapins (73% female, 0% male). Hart and Crowder (15) recommend the statewide adoption of a 4.5 cm (1.8 in.) height terrapin excluder device, as it offered high diamondback terrapin protection at a lower loss of blue crab catches. This size terrapin excluder device would have prevented the bycatch of 93% of female diamondback terrapins, but 0% of male diamondback terrapins sampled by Southwood et al (28). Chavez and Southwood Williard (19) examined the effects of “large” 5 x 15 cm (2 x 6 in.) and “small” 3.8 x 15 cm (1.5 x 6 in.) terrapin excluder devices on the catch of blue crab and diamondback terrapins at multiple sites around Beaufort, NC. They concluded that neither size resulted in a significant reduction in the number nor carapace width of blue crabs caught when compared to pots without terrapin excluder devices and resulted in a potential 86% (100% female, 0% male) to 100% reduction in diamondback terrapins captured, respectively. Chavez and Southwood Williard (19) did comment that although there was no statistically significant reduction in blue crab catch numbers, there is a trend toward catch reduction in pots fitted with the smaller terrapin excluder device.

As terrapin excluder devices have been demonstrated to reduce the efficiency of crab pots, crab fisherman may respond by increasing the total number of pots fished in an area to offset reductions in crab catch, resulting in an increase in the potential for diamondback terrapin interactions within the DTMA's. The possibility for increased localized crab pot effort as a response to the requirement to the use of terrapin excluder devices highlights the need to employ the most effective terrapin excluder devices.

The best current available data from diamondback terrapin and blue crab research should be used when considering the dimensions and type of excluder devices to be approved by NCDMF, and to be required for use in DTMA's. Arendt et al. (22), when modelling diamondback terrapin exclusion probabilities for the range of device dimensions tested and published in the literature since 1994, determined the 4 x 8 cm (1.6 x 3 in.) shell height limiting excluder followed by the “SC design” 5.1-6.4 x 7.5 cm (2-2.5 x 3.1 in.) shell width limiting excluder to be the most effective at reducing the probability of diamondback terrapin entry into crab pots. These

exclusion probabilities were calculated using dimensions from blue crabs and diamondback terrapins captured in South Carolina. As regional variation in morphometric length x width relationships as well as size distributions may exist for both blue crabs and diamondback terrapins, the exact reductions in diamondback terrapin capture and impacts to blue crab catch may likely be site specific for each excluder dimension. In North Carolina field studies, excluders which limit based on shell height, with an opening no more than 4 cm vertical height and no more than 16 cm horizontal width (1.6 x 6.3 in.) have been shown to offer the greatest protection to both male and female diamondback terrapins, however this size excluder device is shown to impact the blue crab catch in pots where they are employed (see Table 4.5.1). When examining the size distribution of diamondback terrapins captured in North Carolina by researchers at the University of North Carolina Wilmington, both a height limiting excluder with a vertical opening of no greater than 4 cm (1.6 in.) and the “SC design” 5.1-6.4 x 7.5 cm (2-2.5 x 3.1 in.) shell width limiting excluder would appear to prevent the bycatch of the majority and most frequent size ranges of terrapins captured in North Carolina (Figure 4.5.2) and should be approved for use as bycatch reduction methods in any proposed DTMA.

To allow for collaboration between stakeholders, NCDMF a diamondback terrapin bycatch reduction workgroup consisting of North Carolina fisherman, academic researchers, and fishery managers should be formed. This workgroup may review and test existing excluder devices or work in partnership to examine novel bycatch reduction designs to minimize the impact to blue crab catch while reducing terrapin bycatch. Recommendations on additional excluder devices or modified pot designs by the workgroup will be considered for approved use in DTMA by the NCDMF in consultation with the Shellfish/Crustacean Advisory Committee. To be considered for approval by the NCDMF, the other devices or modified pot designs must be shown to reduce impacts to blue crab catch or cost to fisherman and maintain a level of diamondback terrapin protection offered by existing approved excluder devices.

Step 1 Summary:

The following terrapin excluder devices shall be considered approved for use in DTMA: the pre-made plastic shell width limiting “SC design” measuring 5.1-6.4 x 7.5 cm (2-2.5 x 3.1 in.); any pre-made plastic shell height limiting excluder devices with an internal opening no larger than 4 x 16 cm (1.6 x 6.3 in.) height by width; or any shell height limiting excluders made from at least 10-gauge galvanized wire and hog rings with an internal opening no larger than 4 x 16 cm (1.6 x 6.3 in.) height by width. A diamondback terrapin bycatch reduction workgroup of fisherman, academic researchers, and managers will be created. Additional or alternative terrapin excluder devices or modified pot designs recommended through the workgroup may be approved by NCDMF, in consultation with the Shellfish/Crustacean Advisory Committee, provided they have been shown to reduce impacts to blue crab catch or cost to fisherman and maintain the level of diamondback terrapin protection offered by the terrapin excluder devices initially approved and listed above.

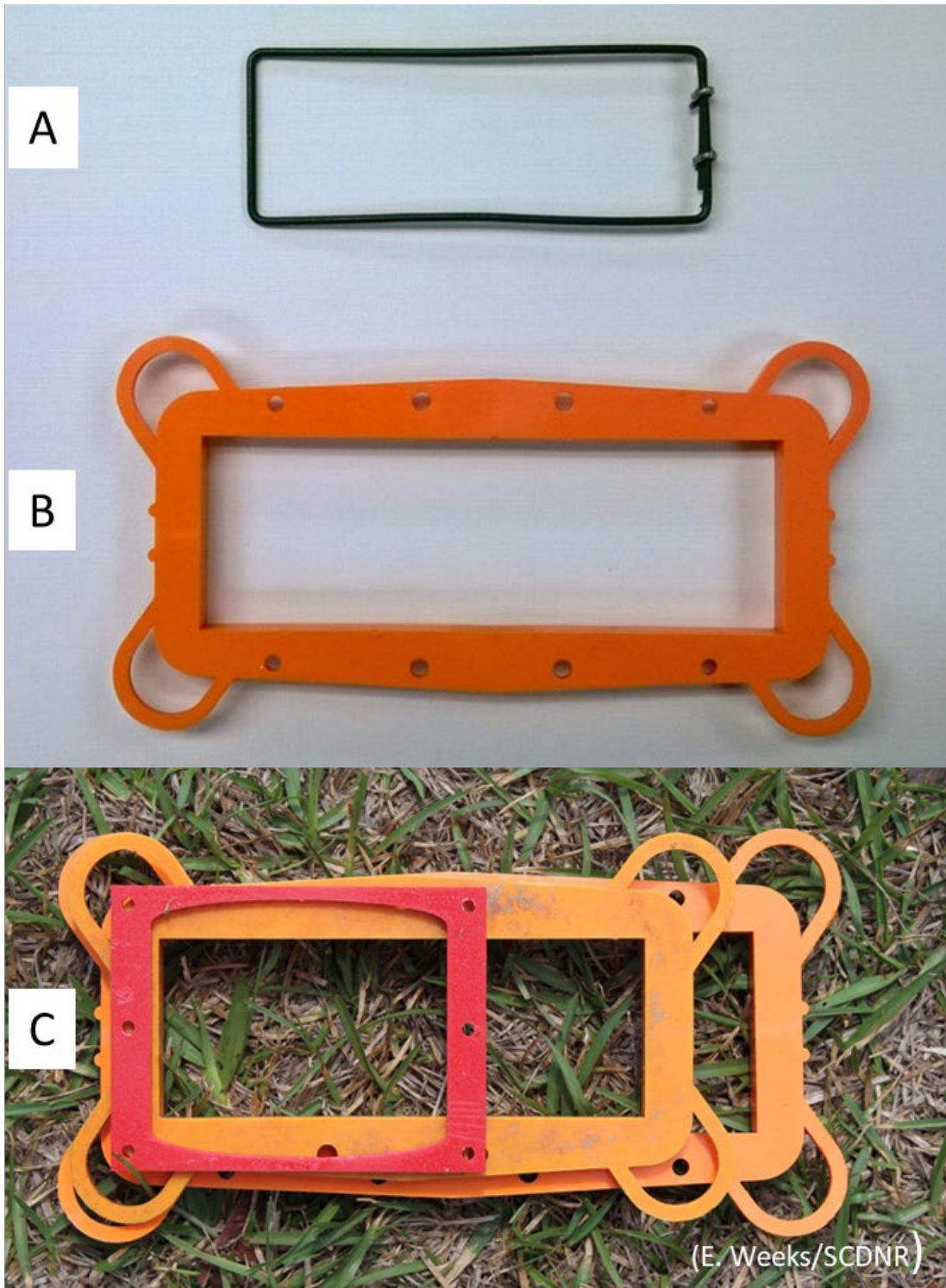


Figure 4.5.1. Examples of terrapin excluder devices for use in crab pots include: (A) wire and hog ring excluder made by a crab pot manufacturer, (B) premade plastic excluder made by Top-Me Products, (C) plastic “SC design” excluder, a shell width limiting device (red) shown on top of two premade plastic shell height limiting devices (photo credit: E. Weeks/SCDNR).

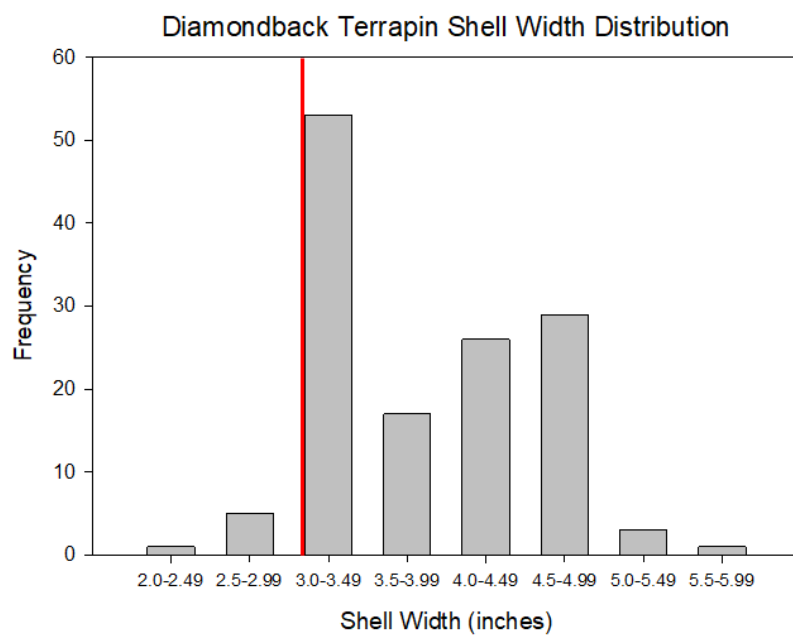
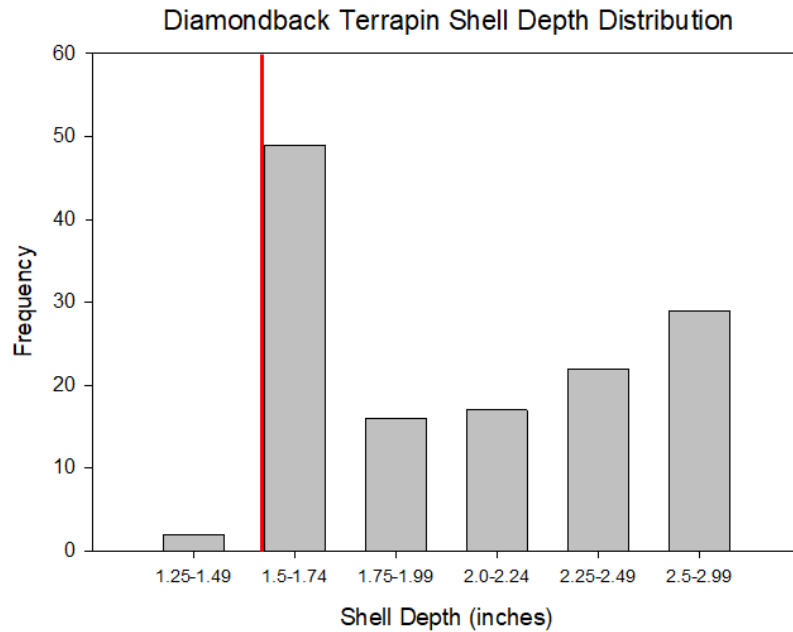


Figure 4.5.2. Distribution of shell depth and height for diamondback terrapins (N=135) in coastal North Carolina. Data compiled by Dr. Amanda Williard (Department of Biology and Marine Biology, University of North Carolina Wilmington). These data represent field records for terrapins captured by seine at multiple sites (Figure 8 Island, Masonboro Island, Bald Head Island, and Beaufort) 2008 to 2018. Vertical red lines approximate potential exclusion of individuals in the size frequency bins to the right of the line; in the upper panel by a height limiting excluder design with a vertical opening of no greater than 4 cm (1.6 in.) and by a shell width limiting “SC design” 5.1-6.4 x 7.5 cm (2-2.5 x 3.1 in.) in the lower panel.

Table 4.5.1. Summary results of field studies examining effectiveness of different terrapin excluder device dimensions and impacts to blue crab catch. A * signifies no diamondback terrapins were caught in the study.

Location	Reference	Excluder Dimensions (cm; height x width)	Impact to Diamondback Terrapin Bycatch	Impact to Blue Crab Catch
NJ	Mazarella 1994 (29)	5 x 10	93% reduction	No significant difference
NJ	Wood 1997 (30)	5 x 10	90% reduction	11% increase in catch rates
		4.5 x 10	100% reduction	9% increase in catch rates
DE	Cole and Helser 2001 (17)	5 x 10	59% reduction	No significant change in number
		4.5 x 12	66% reduction	12% reduction in legal crabs
		3.8 x 12	100% reduction	26% reduction in legal crabs
MD	Roosenburg and Green 2000 (16)	5 x 10	47% reduction	No significant effect on size or number
		4.5 x 12	82% reduction	No significant effect on size or number
		4 x 10	100% reduction	Significant reduction in size and number
VA	Rook et al. 2010 (31)	4.5 x 12	96% reduction	No significant effect on size or number
VA	Upperman et al. 2014 (18)	5 x 15.2	75% potential exclusion	No significant effect on size or number
		4.5 x 12	96% potential exclusion	Significant reduction in size and number
VA	Corso et al. 2017 (20)	5.1 x 15.2	83% reduction	No significant effect on number Significant reduction in size (1mm)
VA	Grubbs et al. 2017 (21)	5.1 x 15.3	87% reduction	No significant reduction in catch rate Significant reduction in size (2mm)
		6.4 x 7.3	87% reduction	No significant reduction in catch rate Significant reduction in size (2mm)
NC	Grant 1997 (25)	5 x 10	75% reduction	19% reduction
		4 x 12	100% reduction	29% reduction
NC	Thorpe and Likos 2008 (32)	5 x 12	*	5.7% reduction
		5 x 10	*	18.2% reduction
NC	Hart and Crowder 2011 (15)	5 x 16	28% potential exclusion	5.7% reduction in legal male crabs
		4.5 x 16	77% potential exclusion	21.2% reduction in legal male crabs
		4 x 16	100% potential exclusion	26.6% reduction in legal male crabs
NC	Chavez and Southwood Williard 2017	5 x 15	86% potential exclusion	No significant reduction in size or number

Location	Reference	Excluder Dimensions (cm; height x width)	Impact to Diamondback Terrapin Bycatch	Impact to Blue Crab Catch
	(19)	3.8 x 15	100% potential exclusion	No significant reduction in size or number
SC	Grubbs et al. 2017 (21)	5.1 x 15.3	*	No significant reduction in catch rate Significant reduction in size (1mm)
		6.4 x 7.3	*	Significant reduction in catch rate Significant reduction in size (2mm)
GA	Belcher and Sheirling 2007 (33)	5 x 16	98% reduction	7% reduction in number
FL	Butler and Heinrich 2007 (34)	4.5 x 12	73.2% reduction	No significant effect on size or number
LA	Guillory and Prejean 1998 (24)	5 x 10	*	25.7% increase in overall catch rate

Step 2 Determine dates when terrapin excluder devices will be required

Diamondback terrapins display seasonal differences in habitat use and are known to enter a state of torpor during the winter months. Hardin and Southwood Williard (23) observed radio tagged diamondback terrapins begin exiting the water column and burrow into the marsh mud once water temperatures drop below 20 degrees Celsius (68 °F) during October in Masonboro Sound, North Carolina. They then observed diamondback terrapins resuming activity in April as water temperatures rose. The peak catch of diamondback terrapins in crab pots was seasonal in South Carolina, with the majority of captures occurring during April and May (11). These elevated catches were probably associated with post hibernation feeding and reproductive activity (11). In Jarrett Bay, North Carolina, Hart and Crowder (15) observed all diamondback terrapin interactions with blue crab pots during April and May. In Masonboro Sound, North Carolina, Alford and Southwood Williard (35) sampled modified “tall” crab pots from May to late October. These modified pots are greater in height than standard commercial crab pots, which allows entrapped diamondback terrapins access to air during all tidal phases to prevent drowning mortality. During those months, 27 diamondback terrapins were captured with May having the highest capture rate with 12 diamondback terrapins, followed by June and July with five and four, respectively. There were no captures in August, four in September, and two in October. In southeastern North Carolina, the diamondback terrapin “active season”, was determined to be between April 1 and October 31 by observing the movement and activity patterns of radio tagged diamondback terrapins (23). NCDMF has recently encountered active diamondback terrapins in sampling programs in March, during higher than average spring temperatures. Allowing fisherman to use crab pots without terrapin excluder devices during the dormant season (November 1 – February 28) in DTMA's should not result in significant bycatch of diamondback terrapins, however, this may result in crab pots without terrapin excluder devices being lost and becoming “ghost pots” within DTMA's. Though not baited, these “ghost pots” may continue to cause bycatch mortality (36).

Step 2 Summary:

As peak captures of diamondback terrapins in crab pots occur in early spring as individuals emerge and become active, it is important to account for annual variability in spring temperature and have terrapin excluder devices employed before diamondback terrapins become active. Based on NCDMF interactions and research conducted in North Carolina, terrapin excluder devices shall be used in designated DTMA's from March 1 through October 31 to cover the entirety of the potential diamondback terrapin active season to limit diamondback terrapin bycatch. Both commercial and recreational crab pots would be required to use terrapin excluder devices when fishing in DTMA's during the diamondback terrapin active season.

Step 3 Identify the zone of potential diamondback terrapin interaction with crab pots

Crab pots are one of the most widely distributed fishing gears in the state, occurring throughout all coastal and joint fishing waters. Diamondback terrapins typically spend most of their lives in shallow water adjacent to tidal wetlands, resulting in only a small portion of the area used in the crab pot fishery spatially intersecting with diamondback terrapin habitat (27). The water depths in these nearshore diamondback terrapin habitat areas generally range from < 1 m to 3 m (< 3.3 to 9.8 ft.). In a cooperative research study between crab fishermen and the management agency

in South Carolina, 1,913 crab pots set between 0 and 9 m (0 and 29.5 ft.) in depth were sampled. All captured diamondback terrapins were from pots set at depths < 5 m (16.4 ft.), and 97% were captured in pots at depths < 3 m (9.8 ft.; 14).

Thorpe et al. (13) notes that at a study site in Carteret County, North Carolina, all pots sampled were set greater than 91 m (298.6 ft.) from shore and no diamondback terrapins were caught. However, at sites in Brunswick County, North Carolina, all pots were set within 4.5 m to 91 m (14.8 to 298.6 ft.) from shore, resulting in nine diamondback terrapins being caught (all of which were captured < 13 m (42.7 ft.) from shore). Grant (25), at three estuarine sites in North Carolina, showed significant reductions in diamondback terrapin captures as distance from shore increased. The majority of diamondback terrapins (84.5%) were captured less than 25 m (82 ft.) from shore and 15.5% were taken between 26 and 50 m (85.3 and 164 ft.) offshore. None were captured in pots more than 50 m (164 ft.) from shore. In Jarrett Bay (Core Sound), North Carolina, all diamondback terrapin captures occurred within 321 m (1,053.1 ft.) of the shoreline, with 90% occurring 250 m (820.2 ft.) or less from the shore and 76% occurring 150 m (492.1 ft.) or less from the shore (15).

From these studies, it can be inferred the potential zone of most diamondback terrapin interactions with crab pots in North Carolina are areas that are both less than 250 m (820.2 ft.) from any shoreline and less than 3 m (9.8 ft.) deep at low tide. However, using a specific depth and distance from shore as a metric for requiring a terrapin excluder device may be problematic to effectively enforce, due to changing tides and currents. The designation of discrete DTMAs, which primarily contain habitats less than this depth and distance from shore, are easier to enforce as a way to implement a terrapin excluder device requirement in the crab pots.

Using these parameters (less than 250 m (820.2 ft.) from any shoreline, and less than 3 m (9.8 ft.) deep at low tide), a GIS layer was created for the state and mapped to identify regions that meet both criteria (Figure 4.5.3). A narrow band of potential interaction zone lies immediately behind nearly all of the outer banks and other barrier islands. The southern shoreline of Albemarle Sound, as well as locations in the Alligator and Pasquotank rivers also contain areas of potential interaction zone. Broader regions of potential interaction zones occur within Currituck Sound, as well as the lower Newport River and areas around Fort Macon and Beaufort. The widest and most continuous area identified as a potential interaction zone occurs primarily in New Hanover and Brunswick counties in the coastal areas spanning from Figure 8 Island to Bald Head Island.

Step 3 Summary:

Based on currently available data, areas both less than 250 m from any shoreline and less than 3 m deep at low tide shall be generally identified as areas of potential overlap between diamondback terrapins and the crab pot fishery. These criteria may be revised as additional research is completed.

Step 4 Validate diamondback terrapin presence and overlap with potential crab pot interaction zone

Several sampling programs conducted by the NCDMF encounter diamondback terrapins. These programs include several fishery-independent trawl surveys, a commercial gill net observer

program, and fishery-independent gill net survey. These sampling programs are all conducted in brackish marsh areas across the state which contain possible suitable diamondback terrapin habitat. From 1970 to 2017, a total of 649 individual diamondback terrapin interactions were documented. Due to multiple captures at one site, or fixed station designs in sampling programs, these 649 individual diamondback terrapins have been recorded from 173 unique locations throughout coastal North Carolina.

The North Carolina Natural Heritage Program (NCNHP), maintains a database of natural resource information which also contains diamondback terrapin distribution information. This database is used by government agencies, industry, the military, and conservation groups to make economic development, infrastructure, and land conservation decisions. NCNHP diamondback terrapin distribution data comes from reported sightings as well as compiled data from published research, such as the Southwood Williard and Harden (28) postcard survey. Plotting both the NCDMF sampling program diamondback terrapin interactions and the NCNHP data over the potential interaction zone, visually illustrates the areas statewide where diamondback terrapin populations are likely to occur as bycatch in the crab pot fishery (Figure 4.5.4).



Figure 4.5.3. A map of coastal North Carolina showing the potential interaction zone (< 3 m (9.8 ft.) deep, < 250 m (820.2 ft.) from any shoreline) of diamondback terrapins and crab pots.

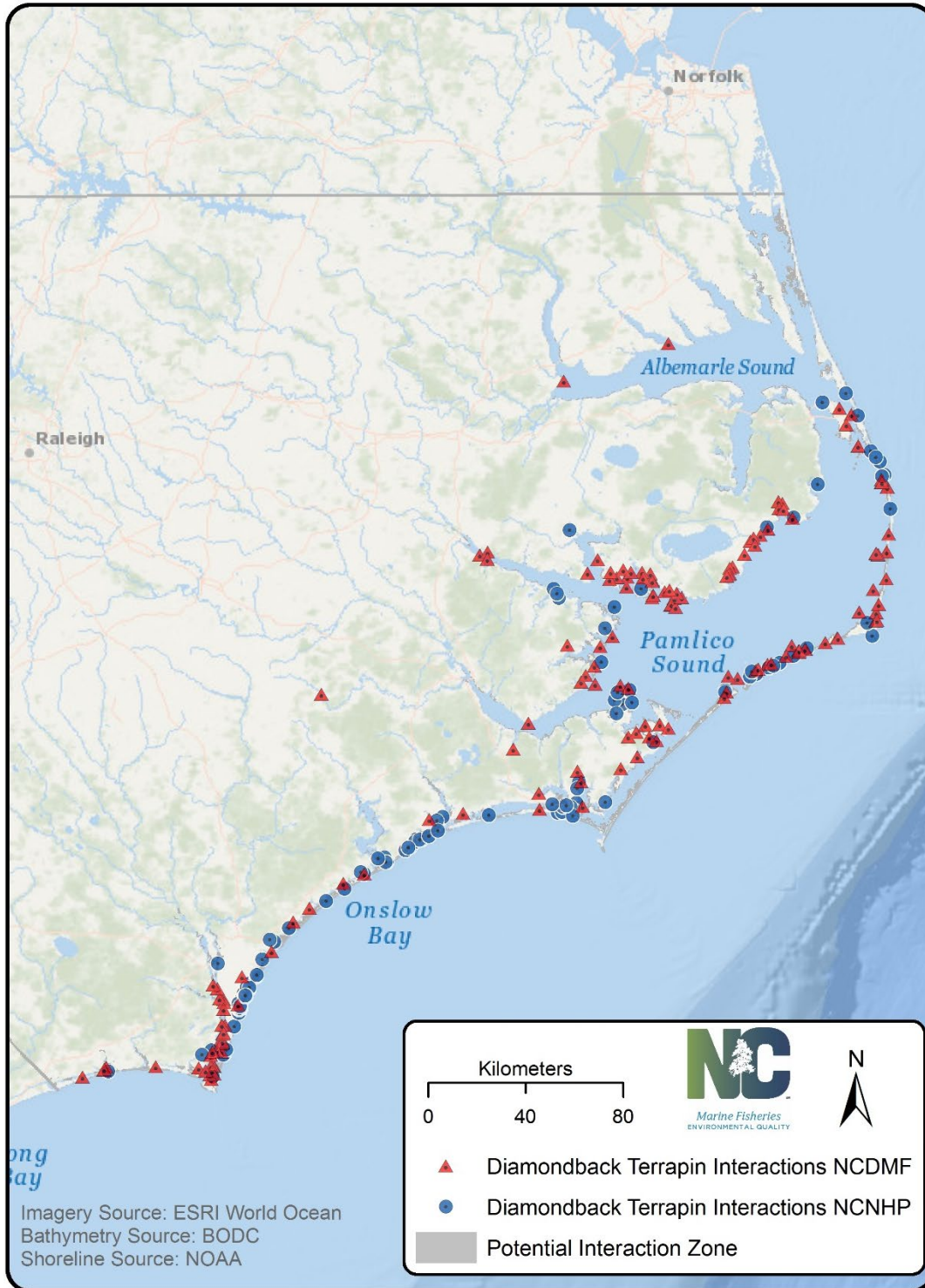


Figure 4.5.4. A map of coastal North Carolina showing the potential interaction zone (< 3 m (9.8 ft.) deep, < 250 m (820.2 ft.) from any shoreline) of diamondback terrapins and crab pots, overlaid with NCDMF (1971 – 2017) and NCNHP diamondback terrapin observations.

Diamondback terrapin distribution is observed primarily from Roanoke Island to the South Carolina line. There are two NCDMF interactions recorded in Albemarle Sound, however the rest of the region north of Roanoke Island does not have any diamondback terrapin occurrences documented in either the NCDMF or NCNHP datasets. The area in Currituck Sound which is highlighted as a potential interaction zone, also does not have documented diamondback terrapin occurrences. Some areas which have been identified as potential interaction zones with overlapping diamondback terrapin occurrences include: the areas immediately behind the Outer Banks from Roanoke Island to Portsmouth Island, portions of western Pamlico Sound, the lower Newport River, areas around Fort Macon and Beaufort, as well as the areas from Figure 8 Island to Bald Head Island. Detailed regional maps highlight the potential interaction zone and known terrapin occurrences for these areas (Figures 4.5.5 – 4.5.9). The region spanning from Wrightsville Beach to the lower Cape Fear River shows one of the relatively wide areas of potential interaction zone which also has numerous documented diamondback terrapin occurrences in the state (Figure 4.5.9).

Step 4 Summary:

Diamondback terrapin presence and overlap with the crab pot interaction zone shall be verified using any of the following: data from the NCDMF, NCNHP, other agencies, universities, and peer-reviewed published literature.

Step 5 Determine appropriate Diamondback Terrapin Management Area boundaries

The creation of DTMA's would focus the use of terrapin excluder devices or approved modified pot designs to essentially create sanctuary areas where diamondback terrapins would otherwise suffer mortality due to incidental catch in crab pots. Crab pots will not be banned in these areas, however to successfully ensure the maintenance of diamondback terrapin populations within these areas and to have them possibly serve as long-term regional source populations, bycatch should be reduced to low levels within the DTMA's.

Diamondback terrapins have been observed to have relatively small home ranges in North Carolina. In Core Sound, average radio tagged terrapin home range size was calculated to be 3.05 km² (1.18 mi.²), with a maximum observed home range of 7.41 km² (2.86 mi.²) (37). In coastal New Hanover County, NC, the maximum straight-line travel distance of radio tagged terrapins observed was 1.20 km (0.75 mi.) for individuals captured in Masonboro Sound, and 1.05 km (0.65 mi.) for Figure 8 Island marshes (23). The size of a DTMA should at a minimum allow for the protection of the entire possible home range size of the target local terrapin population and may include adjacent unoccupied suitable terrapin habitat to allow for population recovery. The smallest size to likely be an effective DTMA should encompass the largest known home range of diamondback terrapin in NC, or cover 7.41 km² (2.86 mi.², 1830 acres) of suitable terrapin habitat.

For an area to be considered for designation as a DTMA, a diamondback terrapin population must be documented (e.g., NCDMF, NCNHP, or other agency or university data), as well as being identified as a potential area for diamondback terrapin interactions with crab pots (via the GIS depth and distance layer). The boundaries should incorporate a significant portion of the selected region identified as a potential interaction zone. Natural boundaries for ease of marking

and enforcement should be considered, however the design should minimize including any waterbody area not designated as potential interaction zone. Boundaries of other existing natural or conservation areas may be used to identify DTMA's to simplify enforcement and marking, provided they are comprised primarily of the potential interaction zone.

Examples of possible types of natural or conservation areas in NC include State Natural Areas, National Estuarine Research Reserves, National Wildlife Refuges, and National Seashores. State Natural Areas have been designated by the North Carolina Division of Parks and Recreation to protect areas sensitive to human activities and preserve and protect areas of scientific, aesthetic, or ecological value. The National Estuarine Research Reserve System (NERR) is a network of protected areas across the United States which protects coastal and estuarine habitats for long-term research, education, and coastal conservation. The National Wildlife Refuge system (NWRS), and National Seashores are networks of federally managed lands and waters within the United States recognized and protected for their natural value. Considering these types of management areas when delineating DTMA's allows NCDMF to use boundaries that have been previously established and marked and serves as additional justification for requiring terrapin excluder devices in areas which have been independently determined as environmentally sensitive or important habitats for the protection of wildlife. An increase in crab pot density of one pot per creek is associated with a 74.6% decline in terrapin count, when estimating the impact of unmodified crab pots on a refuge wide scale (38). The use of terrapin excluder devices or modified pot designs for the reduction of diamondback terrapin mortality in crab pots would align with the wildlife protection and conservation goals of the various managing agencies for these existing designated areas. Negative impacts from crab pot mortality and low potential rates of recolonization may prevent maintaining ongoing populations of diamondback terrapins in refuges or reserves unless diamondback terrapin loss through bycatch is minimized (38).

Step 5 Summary:

Boundaries of DTMA's shall be drawn to incorporate a significant portion of the potential interaction zone containing verified population(s) of diamondback terrapins and to minimize the inclusion of areas not identified in the potential interaction zone. Boundaries of preexisting natural or conservation areas may be used as DTMA boundaries to simplify enforcement and support the conservation goals of these areas.

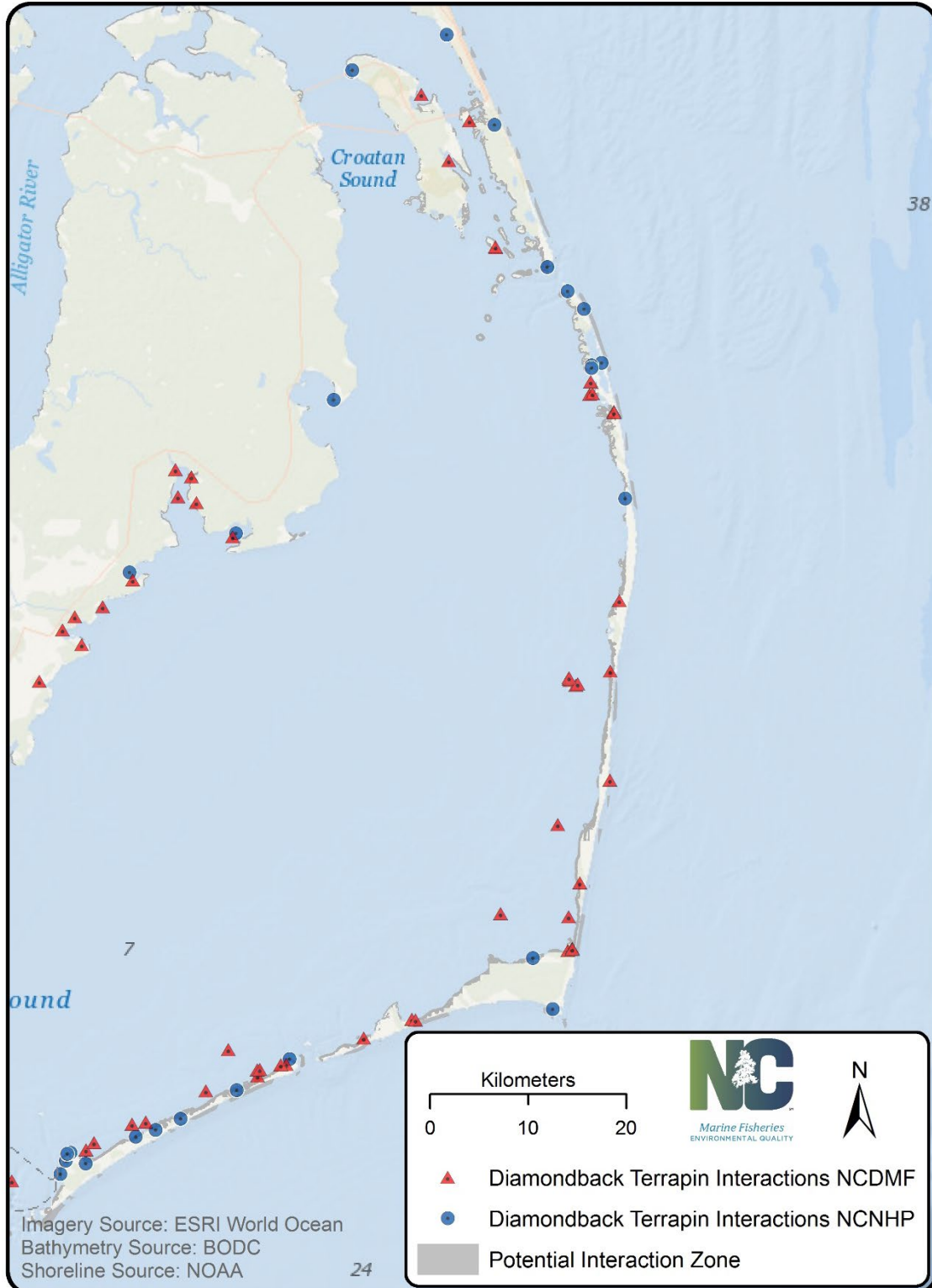


Figure 4.5.5. A map of eastern Pamlico Sound showing the potential interaction zone (< 3 m (9.8 ft.) deep, < 250 m (820.2 ft.) from any shoreline) of diamondback terrapins and crab pots, overlaid with NCDMF (1971 – 2017) and NCNHP diamondback terrapin observations.

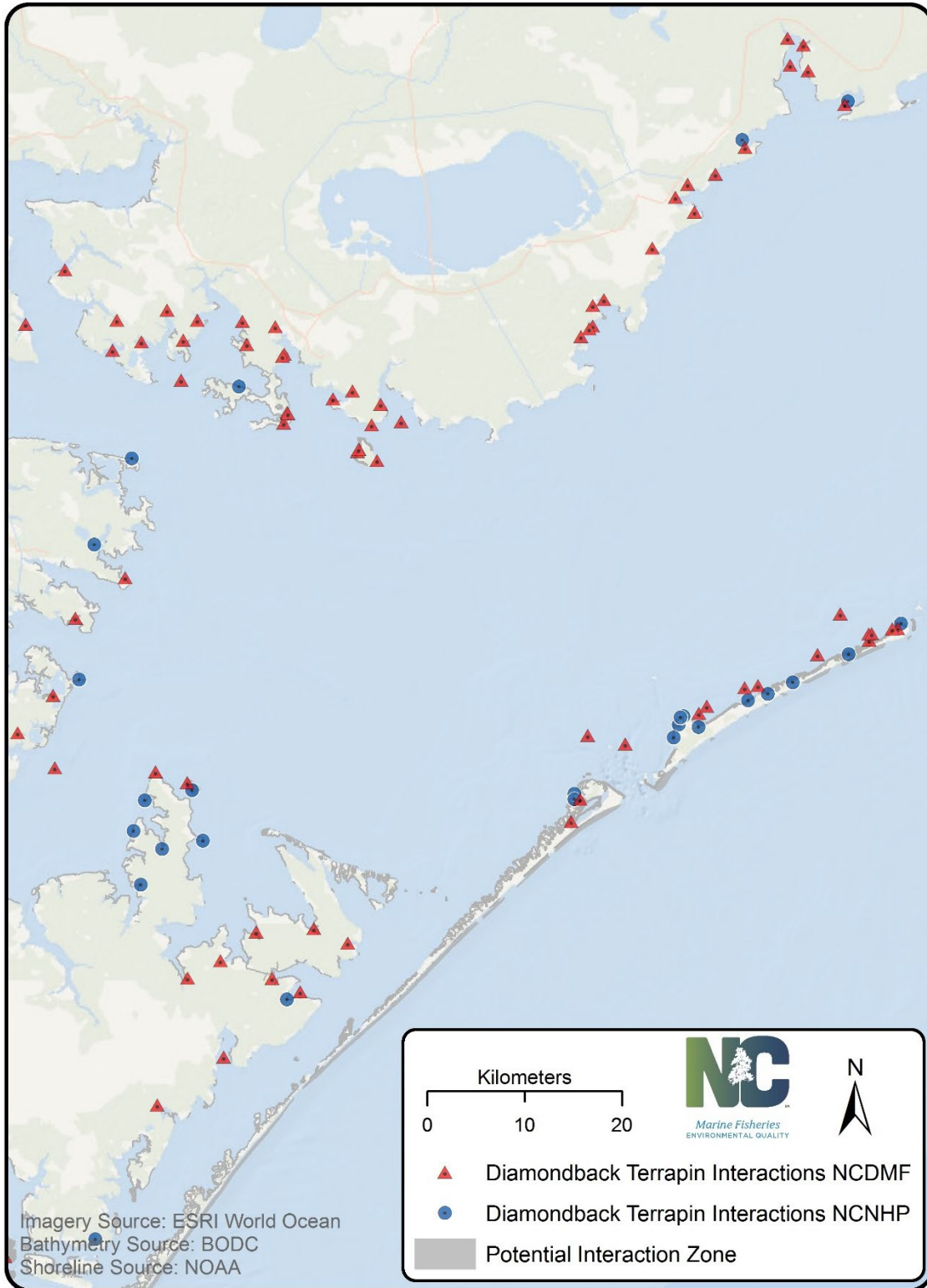


Figure 4.5.6. A map of western Pamlico Sound showing the potential interaction zone (< 3 m (9.8 ft.) deep, < 250 m (820.2 ft.) from any shoreline) of diamondback terrapins and crab pots, overlaid with NCDMF (1971 – 2017) and NCNHP diamondback terrapin observations.

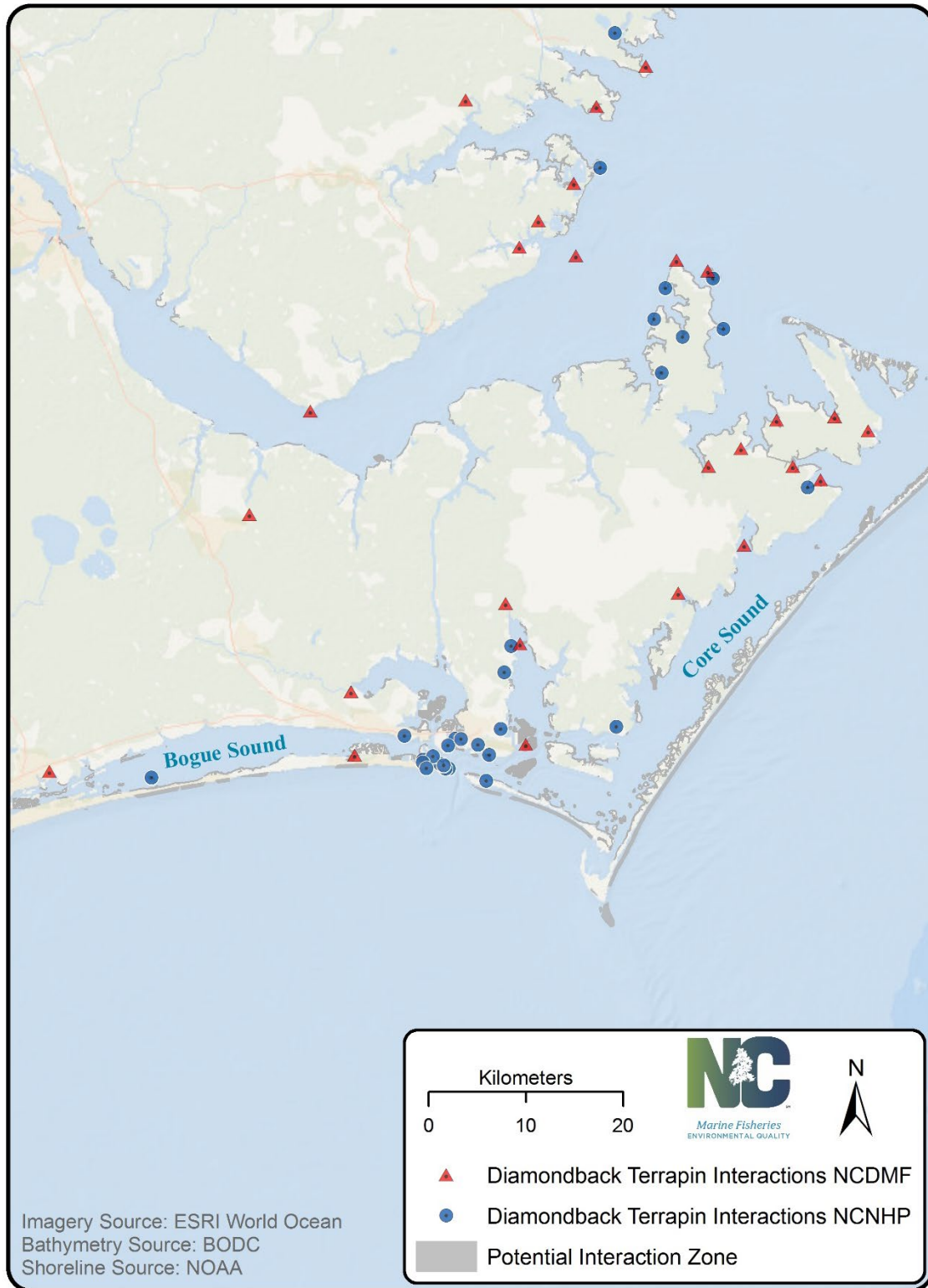


Figure 4.5.7. A map of Core and Bogue sounds showing the potential interaction zone (< 3 m (9.8 ft.) deep, < 250 m (820.2 ft.) from any shoreline) of diamondback terrapins and crab pots, overlaid with NCDMF (1971 – 2017) and NCNHP diamondback terrapin observations.

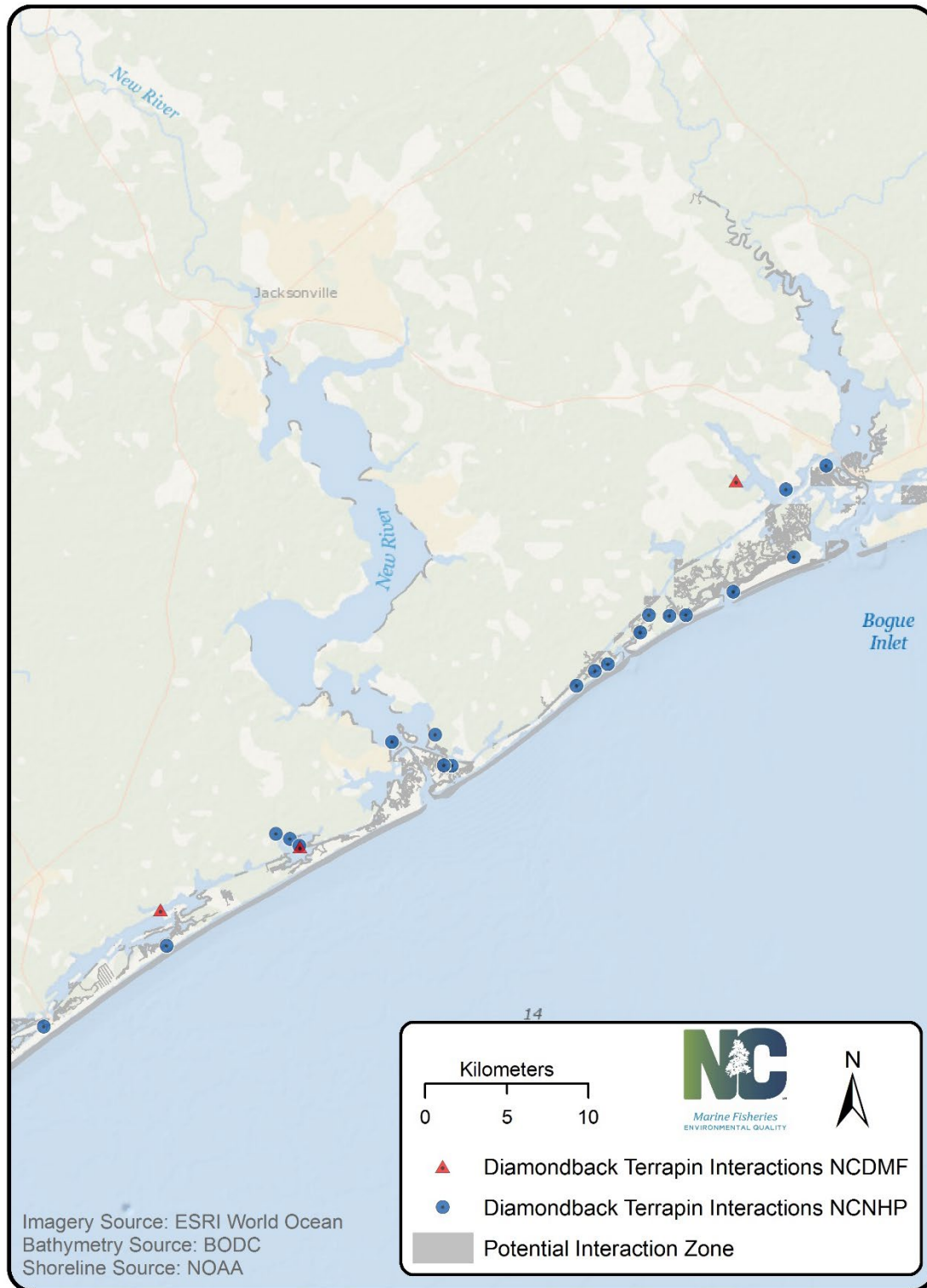


Figure 4.5.8. A map of coastal Onslow and Pender counties showing the potential interaction zone (< 3 m (9.8 ft.) deep, < 250 m (820.2 ft.) from any shoreline) of diamondback terrapins and crab pots, overlaid with NCDMF (1971 – 2017) and NCNHP diamondback terrapin observations.

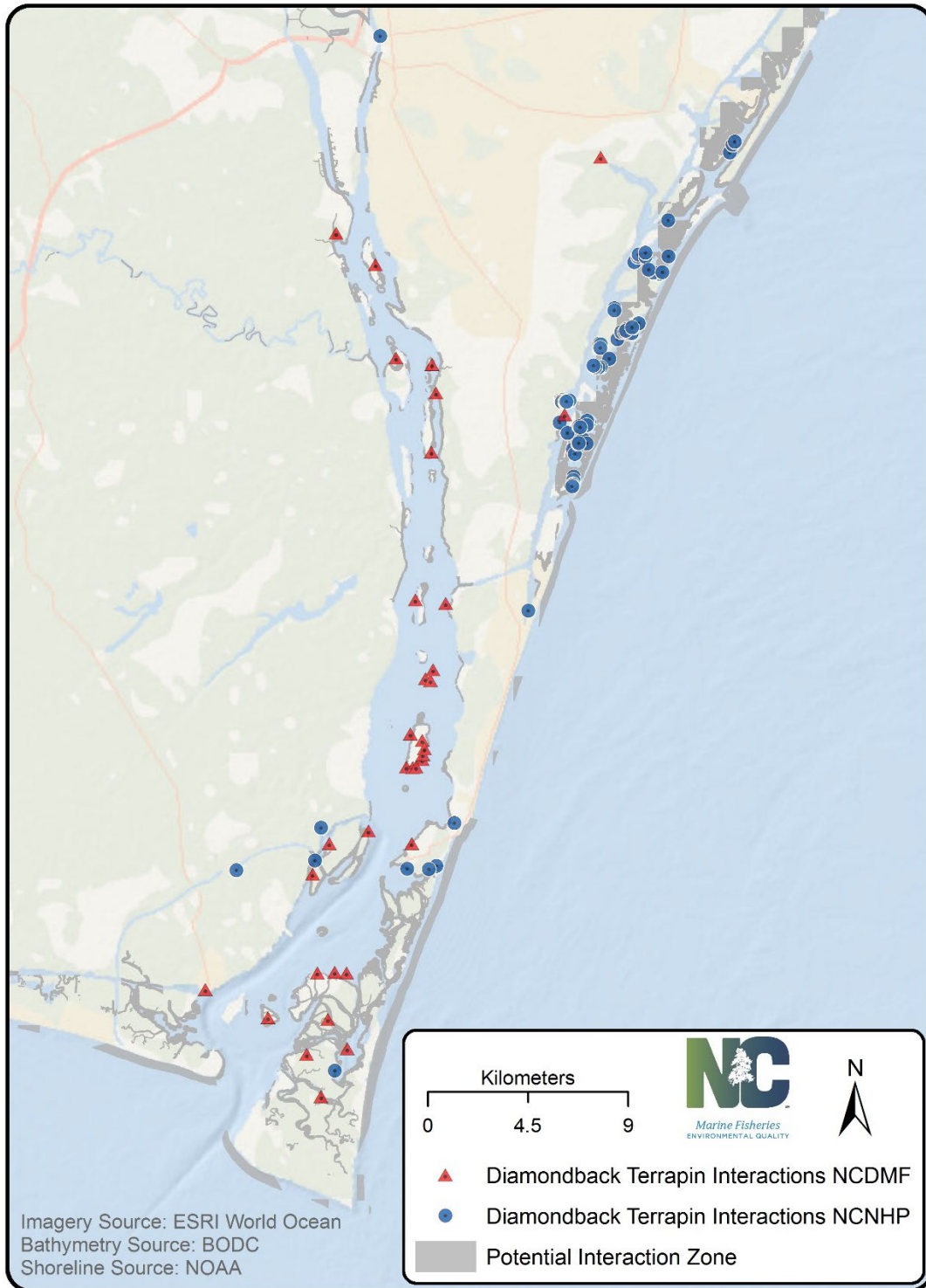


Figure 4.5.9. A map of coastal New Hanover and Brunswick counties showing the potential interaction zone (< 3 m (9.8 ft.) deep, < 250 m (820.2 ft.) from any shoreline) of diamondback terrapins and crab pots, overlaid with NCDMF (1971 – 2017) and NCNHP diamondback terrapin observations.

Step 6 Public notice of the proposed DTMA

Once an area has been identified by NCDMF as an area where establishing a DTMA would be appropriate, an information paper containing the following details of the proposed DTMA will be produced:

- 1) Map and coordinates of the proposed DTMA boundaries.
- 2) Cited sources and summary of diamondback terrapin presence data within the proposed DTMA.
- 3) Information on any existing natural or conservation areas overlapping with the proposed DTMA.
- 4) Data on the local blue crab fishery within the proposed DTMA.

Maps of the proposed DTMA shall illustrate the proposed DTMA boundaries as well as display the GIS layer illustrating the zone of potential diamondback terrapin interaction with crab pots based on the established depth and distance from shore criteria. Maps will also overlay known locations where diamondback terrapins have been documented to occur. Source data for diamondback terrapin occurrences from publications will be summarized and cited as references. Data sources such as NCDMF biological database records or NCNHP will also be listed and referenced. If the proposed location is within an existing natural or conservation areas (e.g. NERR, NWRS), supporting information about or from the managing agency will be provided. Participation and landings (pounds and value) data from the local blue crab fishery to be impacted by the proposed DTMA will also be presented. However, under certain situations limited data may be available to the public due to data confidentiality issues with landings data involving small numbers (less than three individuals) of fishery participants.

The resultant information paper will be presented to the appropriate regional advisory committee for their input and to receive public comment. Public notice will be made via a press release and the issue paper describing the proposed DTMA will be made available with a 30-day public comment period open prior to the regional advisory committee meeting. The division will contact local crab fishermen in the area to be impacted as well as any diamondback terrapin researchers working in the region for their comment. The division will take into consideration advisory committee and public comments and may work with fishermen and researchers to modify the proposed DTMA boundaries to maintain protections for diamondback terrapins while minimizing impacts to the local blue crab fishery.

Step 6 Summary:

The division shall produce an information paper (with the information outlined above), present the information to the appropriate regional advisory committee for their input, inform the public of the proposed DTMA via a press release, hold a 30-day public comment period, and contact local crab fishermen and diamondback terrapin researchers for their comment.

Step 7 Issuance of DTMA proclamation

Once the previous steps have been completed, the division shall issue a proclamation designating the DTMA without any NCMFC action as outlined in this issue paper and by NCMFC rule 15A

NCAC 03L .0204. The proclamation will contain GPS coordinates, a description of the boundaries, and a map illustrating the DTMA. All commercial and recreational hard or peeler crab pots fished within the DTMA shall be required to properly use any of the NCDMF approved terrapin excluder types, from March 1 through October 31. Terrapin excluders will be securely affixed by at least each of the four corners of the device in each funnel opening of the crab pot, in a manner that restricts the maximum dimensions of any opening in the funnel to that of the internal opening dimensions of the approved excluder device employed (Figure 4.5.10). Excluder devices would not be required to be used if the maximum inner opening dimensions of all funnel entrances did not exceed those of an approved excluder device. NCDMF will issue DTMA proclamations at least one month prior to their effective date, with a goal of designating DTMA's prior to the annual pot closure period to allow impacted fishermen time to make modifications to their gear for compliance to the proclamation.



Figure 4.5.10. Premade plastic diamondback terrapin excluder devices shown inside one entrance funnel opening of crab pots. (A) The “SC design” shell width limiting excluder. (B) A shell height limiting excluder.

NCDMF will mark boundaries of any proclaimed DTMA's and post informational signs similar to those marking other existing management areas. Posted signs will indicate all crab pots fished within the marked area will require the use of an approved terrapin excluder device from March 1 through October 31.

Step 7 Summary:

The division will issue a proclamation and mark the boundaries of the DTMA at least one month prior to its effective date.

Additional Discussion

The framework outlined in this issue paper is the next step necessary in implementing the NCMFC selected management strategy adopted in the 2013 Blue Crab FMP Amendment 2, which granted proclamation authority for the director of the North Carolina Division of Marine Fisheries (NCDMF) to require the use of terrapin excluder devices in crab pots. This framework defines the proclamation use criteria, and creates a stepwise process involving public comment, Advisory Committee consultation, and the most current scientific data, to develop Diamondback Terrapin Management Areas.

The targeted DTMA approach offers improved localized protection of diamondback terrapins and minimizes the impacts to the statewide crab fishery (commercial and recreational). As crabbers typically fish their pots within one specific region, terrapin excluder device requirements for DTMA's will disproportionately affect those fishermen who set pots within the DTMA. While this may be viewed as unfair to these impacted fishermen, these areas will be determined using the best available data to have significant overlap with diamondback terrapins and the highest probability of diamondback terrapin interactions occurring with crab pots. A broader seasonal application of a less restrictive 5 x 16 cm (2 x 6.3 in.) terrapin excluder device across all pots fished in less than 3 m (9.8 ft.) of water and less than 250 m (820.2 ft.) from shore, may be viewed as more equitable. However, using pot set depth or distance from shore as criteria for requiring terrapin excluder devices is not realistically enforceable, and the use of less restrictive terrapin excluder devices may not be effective at preventing size selective mortality and localized extirpations. Broader regional requirements for the use of terrapin excluder devices would result in a greater reduction of diamondback terrapin bycatch overall but would also have a significant impact on blue crab commercial harvest and place an undue restriction on crab pots fished too deep or far from shore to incidentally capture diamondback terrapins.

The goal of this management strategy is to reduce diamondback terrapin capture and mortality in crab pots. Areas designated as DTMA's will minimize the inclusion of areas too deep or far from shore and help prevent the capture of diamondback terrapins in crab pots during the active season. However, not all areas within the zone of potential interaction will be designated as DTMA's. Smaller management areas within the overall zone of potential interaction will be created to protect specific areas documented to contain populations of diamondback terrapins and focus on including areas such as reserves or refuges designated as environmentally sensitive or important habitats for the protection of wildlife. This targeted DTMA approach is the most focused way to offer diamondback terrapin populations the greatest protection from bycatch mortality while having the least overall impact to the statewide blue crab fishery. Proactively

taking these steps to address diamondback terrapin bycatch in crab pots may help mitigate the need to seek further state or federal protection (Threatened or Endangered listing) of diamondback terrapins. Additionally, addressing this issue may help improve future ratings the blue crab pot fishery receives from groups like Seafood Watch and the ability for the fishery to achieve sustainable harvest certifications from groups like the Marine Stewardship Council.

If the NCMFC does not agree with a particular DTMA established through this process, N.C. General Statute § 113-221.1 allows the NCMFC to call an emergency meeting, at the request of five or more members, to review a proclamation issued under the authority delegated to the Fisheries Director. At that meeting the NCMFC may approve, cancel, or modify the proclamation.

VI. PROPOSED RULE(S)

No rule change required. Proclamation authority is contained in existing rule (NCMFC Rule 15A NCAC 03L .0204(b)).

VII. RECOMMENDATIONS

NCMFC Selected Management Strategy

Use science on locally specific pot funnel design to reduce terrapin interactions and identify individual areas with terrapin population hot spots that would be closed to potting unless an excluder is used.

VIII. LITERATURE CITED

1. NCDMF (North Carolina Division of Marine Fisheries). 2013. North Carolina Fishery Management Plan Blue Crab - Amendment 2. North Carolina Department of Environment and Natural Resources. North Carolina Division of Marine Fisheries. Morehead City, NC. 408 pp.
2. Dorcas, M.E., J.C. Beane, A.L. Braswell, E.C. Corey, M. Godfrey, J. Humphries, T. Lamb, S.J. Price. 2011. Reevaluation of status listings for jeopardized amphibians and reptiles in North Carolina: Report of the Scientific Council on Amphibians and Reptiles submitted to the Nongame Wildlife Advisory Committee of the North Carolina Wildlife Resources Commission. February 2011. 60 pp.
3. Seigel, R.A. and J.W. Gibbons. 1995. Workshop on the ecology, status, and management of the diamondback terrapin (*Malaclemys terrapin*), Savannah River Ecology Laboratory, 2 August 1994: Final results and recommendations. *Chelonian Conservation and Biology*. 1: 240-243.
4. Roosenburg, W.M., W. Cresko, M. Modesitte, and M.B. Robbins. 1997. Diamondback terrapin (*Malaclemys terrapin*) mortality in crab pots. *Conservation Biology*. 11(5): 1166-1172.
5. Butler, J.A., G.L. Heinrich, and R.A. Seigel. 2006. Third workshop on the ecology, status and conservation of diamondback terrapins (*Malaclemys terrapin*): results and recommendations. *Chelonian Conservation and Biology*. 5: 331-334.

6. Dorcas, M.E., J.D. Wilson, and J.W. Gibbons. 2007. Crab trapping causes population decline and demographic change in diamondback terrapins over two decades. *Biological Conservation*. 137: 334-340.
7. Monterey Bay Aquarium Seafood Watch. 2019. Blue Crab *Callinectes sapidus* United States Pots and Trotline. Seafood Watch Consulting Research.
8. Palmer, W.M. and C.L Cordes. 1988. Habitat suitability index models: Diamondback terrapin (nesting) - Atlantic Coast. U.S. Fish & Wildlife Service Biological Report. 82(10.151). 18 pp.
9. Hildebrand, S.F. 1932. Growth of diamondback terrapin size attained, sex ratio and longevity. *Zoologica*. 9: 551-563.
10. Hart, K.M., M.E. Hunter, T.L. King. 2014. Regional differentiation among populations of Diamondback terrapins (*Malaclemys terrapin*). *Conservation Genetics*. 15(3): 593-603.
11. Bishop, J.M. 1983. Incidental capture of diamondback terrapin by crab pots. *Estuaries*. 6: 426-430.
12. Hart, K.M. 2005. Population biology of Diamondback terrapins (*Malaclemys terrapin*): defining and reducing threats across their geographic range. Dissertation, Duke University, Durham, North Carolina, USA.
13. Thorpe, T., M. Hooper, and T. Likos. 2005. Bycatch potential, discard mortality and condition of fish and turtles associated with the spring commercial blue crab (*Callinectes sapidus*) pot fishery. Final Report. North Carolina Sea Grant. 04-POP-03. 18 pp.
14. Powers, J.J. 2007. Terrapin excluder devices (TEDs) in commercial blue crab traps, a SCDNR cooperative research study. South Carolina Cooperative Research Program (power point presentation).
15. Hart, K.M. and L.K. Crowder. 2011. Mitigating by-catch of diamondback terrapins in crab pots. *Journal of Wildlife Management*. 75(2): 264-272.
16. Roosenburg, W.M. and J.P. Green. 2000. Impact of a by-catch reduction device on terrapin (*Malaclemys terrapin*) and crab (*Callinectes sapidus*) capture in pots. *Ecological Applications*. 10: 882-889.
17. Cole, R.V. and T.E. Helser. 2001. Effect of four by-catch reduction devices on diamondback terrapin (*Malaclemys terrapin*) capture and blue crab (*Callinectes sapidus*) harvest in the Delaware estuary. *North American Journal of Fisheries Management*. 21: 825-833.
18. Upperman, A.J., T.M. Russell, and R.M. Chambers. 2014. The influence of recreational crabbing regulations on diamondback terrapin by-catch. *Northeastern Naturalist*. 21(1): 12-22.
19. Chavez, S., and A. Southwood Williard. 2017. The effects of bycatch reduction devices on diamondback terrapin and blue crab catch in the North Carolina commercial crab fishery. *Fisheries Research* 186: 94-101.
20. Corso, A.D., J.C. Huettenmoser, O.R. Trani, K. Angstadt, D.M. Bilkovic, K.J. Havens, T.M. Russell, D. Stanhope, R.M. Chambers. 2017. Experiments with By-Catch Reduction Devices to Exclude Diamondback Terrapins and Retain Blue Crabs. *Estuaries and Coasts*. 40(5): 1516-1522.
21. Grubs, S.P, H. Funkhouser, P. Myer, M. Arendt, J. Schwenter, and R.M. Chambers. 2017. To BRD or not to BRD? A test of bycatch reduction devices for the blue crab fishery. *North American Journal of Fisheries Management*. 18(1): 18-23.
22. Arendt, M.A., J.A. Schwenter, J. Dingle, C.A. Evans, E. Waldrop, B. Czwartaki, A.E. Fowler, J.D. Whitaker. 2018 A “BRD” in the hand worthy of four in the trap: Validation of

- optimal bycatch reduction device (BRD) size to maximize blue crab *Callinectes sapidus* entry and diamondback terrapin *Malaclemys terrapin* exclusion through theoretical modeling and application. North American Journal of Fisheries Management. doi:10.1002/nafm.10045.
23. Harden, L.A., A. Southwood Williard. 2012. Using spatial and behavioral data to evaluate seasonal bycatch risk of diamondback terrapins *Malaclemys terrapin* in crab pots. Marine Ecology Progress Series. 467: 207-217.
 24. Guillory, V. and P. Prejean. 1998. Effect of terrapin excluder devices on blue crab, *Callinectes sapidus*, trap catches. Mar Fisheries Review. 60(1): 38-40.
 25. Grant, G.S. 1997. Impact of crab pot excluder devices on diamondback terrapin mortality and commercial crab catch. North Carolina Fisheries Resource Grant. University of North Carolina, Department of Biological Science. Wilmington, NC. 9 pp.
 26. McKee, R.K., K.K. Cecala, and M.E. Dorcas. 2015. Behavioral interactions of diamondback terrapins with crab pots demonstrate that bycatch reduction devices reduce entrapment. Aquatic Conservation: Marine and Freshwater Ecosystems.
 27. Roosenburg, W. 2004. The impact of crab pot fisheries on the terrapin, *Malaclemys terrapin*: Where are we and where do we need to go? In C. Swarth, W. M. Roosenburg and E. Kiviat (ed.) Southwood, A., J. Wolfe, and L.A. Harden. 2009. Diamondback terrapin distribution and habitat utilization in the lower Cape Fear River. Final Report NC Sea Grant 08-POP-06. 23 pp.
 28. Southwood Williard, A. and L.A. Hardin. 2010. North Carolina Sea Grant, Mini-grant – Using postcard surveys to investigate potential interactions between blue crab fisheries and diamondback terrapins in coastal North Carolina. Sea Grant unpublished.
 29. Mazarella, A.D. 1994. Great Bay blue claw crab study, diamondback terrapin interaction with crab pots: test of a turtle excluder device in commercial crab pots. New Jersey Division of Fish, Game, and Wildlife Report, 9 pp
 30. Wood, R.C. 1997. The impact of commercial crab traps on northern diamondback terrapins, *Malaclemys terrapin terrapin*. Pages 21-27 in J. Van Abbema, editor. Proceedings: conservation, restoration, and management of tortoises and turtles – an international conference. New York Turtle and Tortoise Society. New York City, New York, USA.
 31. Rook, M.A., R.L. Lipcius, B.M. Bronner, and R.M. Chambers. 2010. Conservation of diamondback terrapin and catch of blue crab with a bycatch reduction device. Marine Ecology Progress Series. 409: 171-179.
 32. Thorpe, T. and T. Likos. 2008. Evaluation of terrapin excluder devices on blue crab (*Callinectes sapidus*) pots: effects on diamondback terrapin (*Malaclemys terrapin*) bycatch and target catch efficiency. Final Report. North Carolina Sea Grant. 06-POP-04. 27 pp.
 33. Belcher, C. and T. Sheirling. 2007. Evaluation of diamondback terrapin excluders for use in commercial crab traps in Georgia waters – final report. University of Georgia Marine Extension Service. Final Report. 29 pp.
 34. Butler, J.A., and G.L. Heinrich. 2007. The effectiveness of bycatch reduction devices on crab pots at reducing capture and mortality of diamondback terrapins (*Malaclemys terrapin*) in Florida. Estuaries and Coasts 30:179-185.
 35. Alford, A. and A. Southwood Williard. 2010. Use of modified crab pots to monitor diamondback terrapin (*Malaclemys terrapin*) populations at Masonboro Island, NC. Poster session presented at the Fifth Symposium on the Ecology, Status, and Conservation of the Diamondback Terrapin, the Louisiana Universities Marine Consortium (LUMCON) Chauvin, LA.

36. Morris, A.S., S.E. Wilson, E.F. Dever, and R.M. Chambers. 2011. A test of by-catch reduction devices on commercial crab traps in a tidal marsh creek in Virginia. *Estuaries and Coasts*. 34: 386-390.
37. Spivey, P.B. 1998. Home range, habitat selection, and diet of the diamondback terrapin (*Malaclemys terrapin*) in a North Carolina estuary. Master Thesis. University of Georgia, Athens, Georgia.
38. Lovich, J.E., M. Thomas, K. Ironside, C. Yackulic, and S.R. Puffer. 2018. Spatial distribution of estuarine diamond-backed terrapins (*Malaclemys terrapin*) and risk analysis from commercial blue crab (*Callinectes sapidus*) trapping at the Savannah Coastal Refuges Complex, USA. *Ocean and Coastal Management*. 157: 160-167.

ATTACHMENT 1: INFORMATION PAPER ON PROPOSED DIAMONDBACK TERRAPIN MANAGEMENT AREAS IN MASONBORO SOUND AND THE LOWER CAPE FEAR RIVER

Diamondback terrapins are listed by the North Carolina Wildlife Resources Commission (NCWRC) as a North Carolina species of “Special Concern” statewide and as a Federal “Species of Concern” in Dare, Pamlico and Carteret counties in NC. Numerous studies have concluded that incidental bycatch in crab pots is the most serious threat to diamondback terrapins in North Carolina and throughout their range (1). Diamondback terrapins are susceptible to substantial population declines or even localized extirpations through incidental bycatch in crab pots and removal of a relatively low number of individuals from the population annually (2).

Diamondback Terrapin Management Areas (DTMAs) are discrete areas within the estuarine and coastal waters of North Carolina which have been designated by the North Carolina Division of Marine Fisheries (NCDMF) to reduce bycatch of diamondback terrapins in the blue crab pot fishery through the use of terrapin excluder devices. These areas have been documented to contain populations of diamondback terrapins through capture in NCDMF sampling programs, and/or through academic research, as well as contain significant waterbody area in which diamondback terrapins are susceptible to incidental capture in crab pots (water less than 3 m (9.8 ft.) deep as well as less than 250 m (820.2 ft.) from shore). The criteria and framework which identifies and creates a DTMA is described and established in the issue paper: Establish a Framework to Implement the Use of Terrapin Excluder Devices in Crab Pots, in Amendment 3 of the Blue Crab Fishery Management Plan. In an area designated as a DTMA, all crab pots (including peeler pots) fished between February 28 and October 31 are required to have approved terrapin excluder devices and constructed out of heavy plastic or wire no smaller than 10-gauge) properly secured in each funnel opening. Excluder devices would not be required to be used if the maximum inner opening dimensions of all funnel entrances did not exceed those of an approved excluder device.

The areas behind Masonboro Island and in the lower Cape Fear River behind Bald Head Island have been identified as containing populations of diamondback terrapins using NCDMF and North Carolina Natural Heritage Program (NCNHP) data sets, as well as being a potential area for diamondback terrapin interactions with crab pots (Figure A1). Both areas have also served as study sites for academic diamondback terrapin research on abundance as well as documenting and verifying interactions and bycatch in crab pots (3; 4; 5; 6; 7; 8; 9; 10; 11).

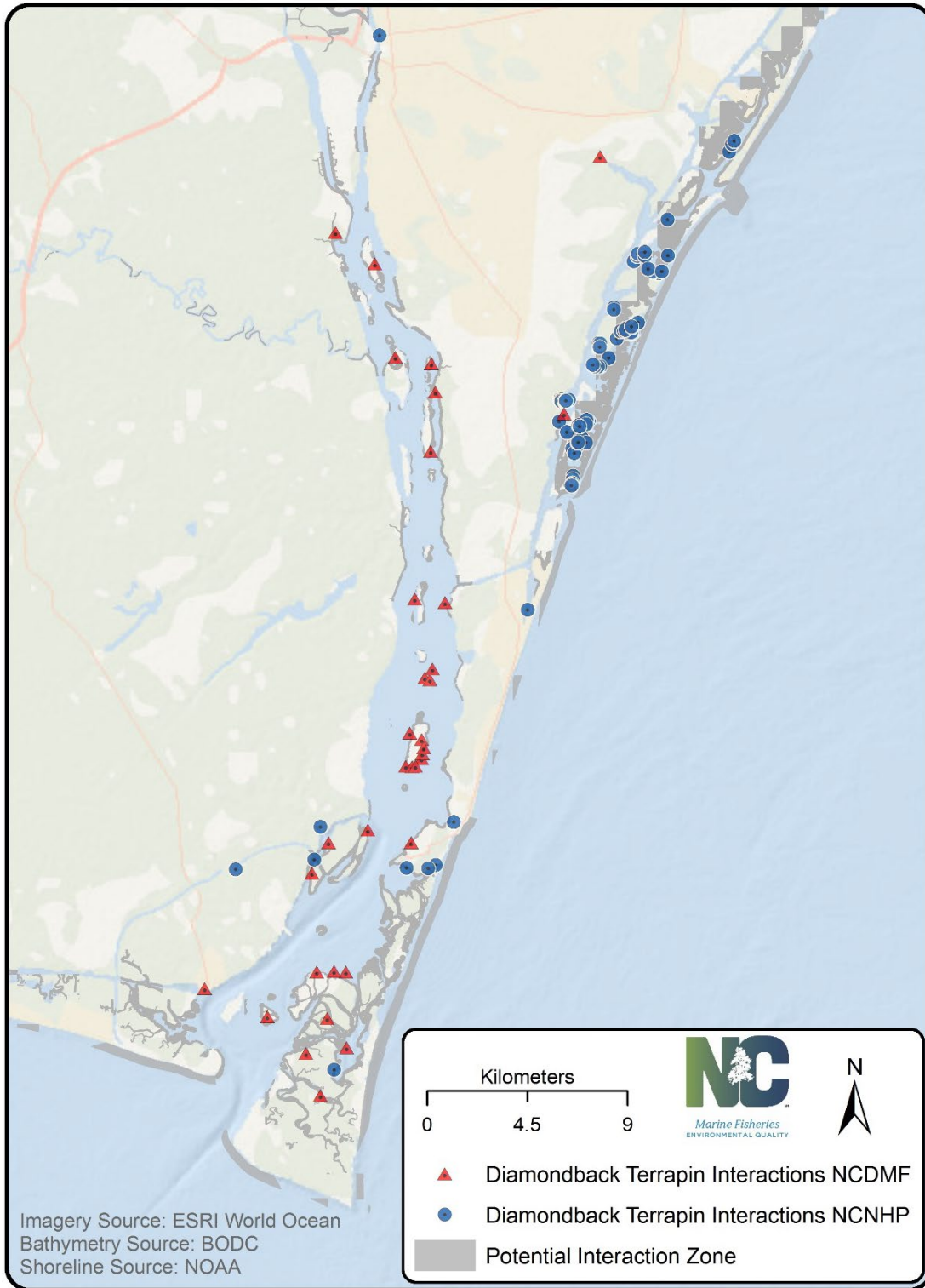


Figure A1. A map of coastal New Hanover and Brunswick counties showing the potential interaction zone (< 3 m (9.8 ft.) deep, < 250 m (820.2 ft.) from any shoreline) of diamondback terrapins and crab pots, overlaid with NCDMF (1971 – 2017) and NCNHP diamondback terrapin observations.

Summary of Diamondback Terrapin Research Documenting Presence and Interaction with Crab Pots

Grant (3) identified the marshes behind Masonboro Island as an area with both a population of diamondback terrapins and an active commercial blue crab pot fishery. Diamondback terrapins were documented and captured in crab pots. Terrapin excluder devices were tested and opening heights of 4 cm (1.6 in.) resulted in 100% exclusion of diamondback terrapins compared to 5 cm (2 in.) height terrapin excluder devices which still allowed diamondback terrapin capture in crab pots. Both terrapin excluder device dimensions resulted in reductions in blue crab catch.

Thorpe et al. (4) captured terrapins in crab pots fished in a typical manner by a commercial fisherman set in a location in the lower Cape Fear River near Bald Head Island, NC during a crab pot bycatch study. It was commented that the rate of diamondback terrapin capture suggests a high potential for bycatch.

Thorpe and Likos (5) evaluated terrapin excluder devices in commercial blue crab pots in the lower Cape Fear River near Bald Head Island, NC. One diamondback terrapin was captured in a crab pot using a 5 x 12 cm (2 x 4.7 inches) excluder, and recommended further assessment based on terrapin size and range in NC. Additionally, recreational and recreational commercial gear license crab pots were observed tied to piers and set close to shore in creeks in areas which would likely have diamondback terrapins.

Southwood et al. (6) used radio telemetry to document diamondback terrapin distribution and habitat use in the lower Cape Fear River and near Masonboro Island. Diamondback terrapins were documented in these areas, and when found swimming they were typically in shallow water less than 3 m (9.8 ft.). Both alive and dead diamondback terrapins were observed entrapped in a crab pot which was exposed during low tide. It was suggested that placing crab pots in deeper water and further from the marsh edge would help reduce diamondback terrapin bycatch.

Alford (7) used tall crab pots (which prevented bycatch mortality) to capture diamondback terrapins and monitor their population between May and October in the areas behind Masonboro Island. Diamondback terrapins were captured at the highest frequency in May, and 65% of all captured diamondback terrapins were male. As males were more likely to be captured in crab pots it was suggested there was the potential to cause a skewed sex ratio due to bycatch mortality.

Southwood Williard and Harden (8) used a postcard survey to investigate potential interactions between blue crab fisheries and diamondback terrapins. Results of this survey were incorporated into the NCNHP dataset, which include occurrences near Bald Head Island and behind Masonboro Island.

Harden and Southwood Williard (9) evaluated the seasonal bycatch risk of diamondback terrapins in crab pots. Diamondback terrapins were captured and monitored by radio telemetry behind Masonboro and Figure Eight Islands, New Hanover Co., NC. Diamondback terrapins were observed to be active and out of dormancy between April 1 and September 30. Crab pots were documented in these areas during the diamondback terrapin active season and were found

to typically be located between 15 and 30 m (49 and 98 ft.) from the marsh edge and in water ranging from 0 to 2.8 m (0 to 9.8 ft.) deep at low tide. Between June 2008 and May 2009, four of the 29 monitored diamondback terrapins were captured as bycatch in crab pots. Results indicate crab pots and diamondback terrapins co-occur with a patchy distribution, resulting in a greater than expected potential for interaction than if both were uniformly distributed.

Chavez and Southwood Williard (10) assessed the impact of two terrapin excluder device sizes, 5.1 x 15.2 cm, and 3.8 x 15.2 cm (2 x 6 in. and 1.5 x 6 in.), in crab pots on blue crab catch at sites in Masonboro and Bogue sounds, NC. Areas behind Masonboro Island had the highest rates of capture in crab pots. It was concluded the larger size terrapin excluder device allowed male diamondback terrapins to enter traps, while the smaller size would have prevented their capture. Neither terrapin excluder device has a statistically significant impact on blue crab size or catch. However, the smaller excluder did show a non-significant downward trend.

Munden (11) examined the population change of diamondback terrapins around Masonboro Island between 2009 and 2017, along with the number of crab pots. Diamondback terrapin head count and crab pot survey data collected as part of a fixed kayak route citizen science project during this period was analyzed. Mean number of diamondback terrapins observed per kilometer in 2017 decreased to a low of 0.016 from a high of 0.938 in 2014, while the mean number of crab pots observed per kilometer increased to 2.435 in 2017 from 0.804 in 2014.

Existing Ecological Areas

Both Masonboro Island and the region in the lower Cape Fear River north of Bald Head Island are comprised of lands designated as North Carolina Natural Heritage Natural Areas (hereinafter referred to as Natural Areas) as well as designated National Estuarine Research Reserves (NERRs; Figure A2). Natural Areas are designated by the North Carolina Division of Parks and Recreation to protect areas sensitive to human activities and preserve and protect areas of scientific, aesthetic, or ecological value. The NERR system is a network of protected areas across the United States which protects coastal and estuarine habitats for long-term research, education, and coastal conservation. The overarching goal of the national NERR system is to provide a foundation for effective coastal management through site research. Masonboro Island Reserve contains the largest undisturbed barrier island in the southern part of the North Carolina coast, and is considered an intact barrier island and estuarine ecosystem. Zeke's Island Reserve contains a complex of salt marshes, tidal flats, and barrier islands.

The site manager for both reserve locations has expressed concern for declining diamondback terrapin head count numbers coinciding with increased crab pot numbers observed in the annual citizen science fixed route kayak survey and has provided example results (Figures A3-A5). Negative impacts from crab pot mortality and low rates of recolonization may prevent maintaining existing populations of diamondback terrapins in refuges or reserves unless their loss through bycatch is minimized (12). The areas encompassing both Masonboro Island and the lower Cape Fear River north of Bald Head Island have also been nominated as Strategic Habitat Areas (SHAs) by the NCMFC (Figure A6). SHAs represent priority locations for protection or restoration due to their exceptional ecological functions or areas particularly at-risk due to imminent threats to their ability to support coastal fisheries. The large areas in Masonboro Sound

and the Cape Fear River were selected due to their biodiversity and high quality of habitats and fishery species. These SHAs also overlap with lands already managed for conservation, and were corroborated with biological data, ecological designations, and specific knowledge of the area.

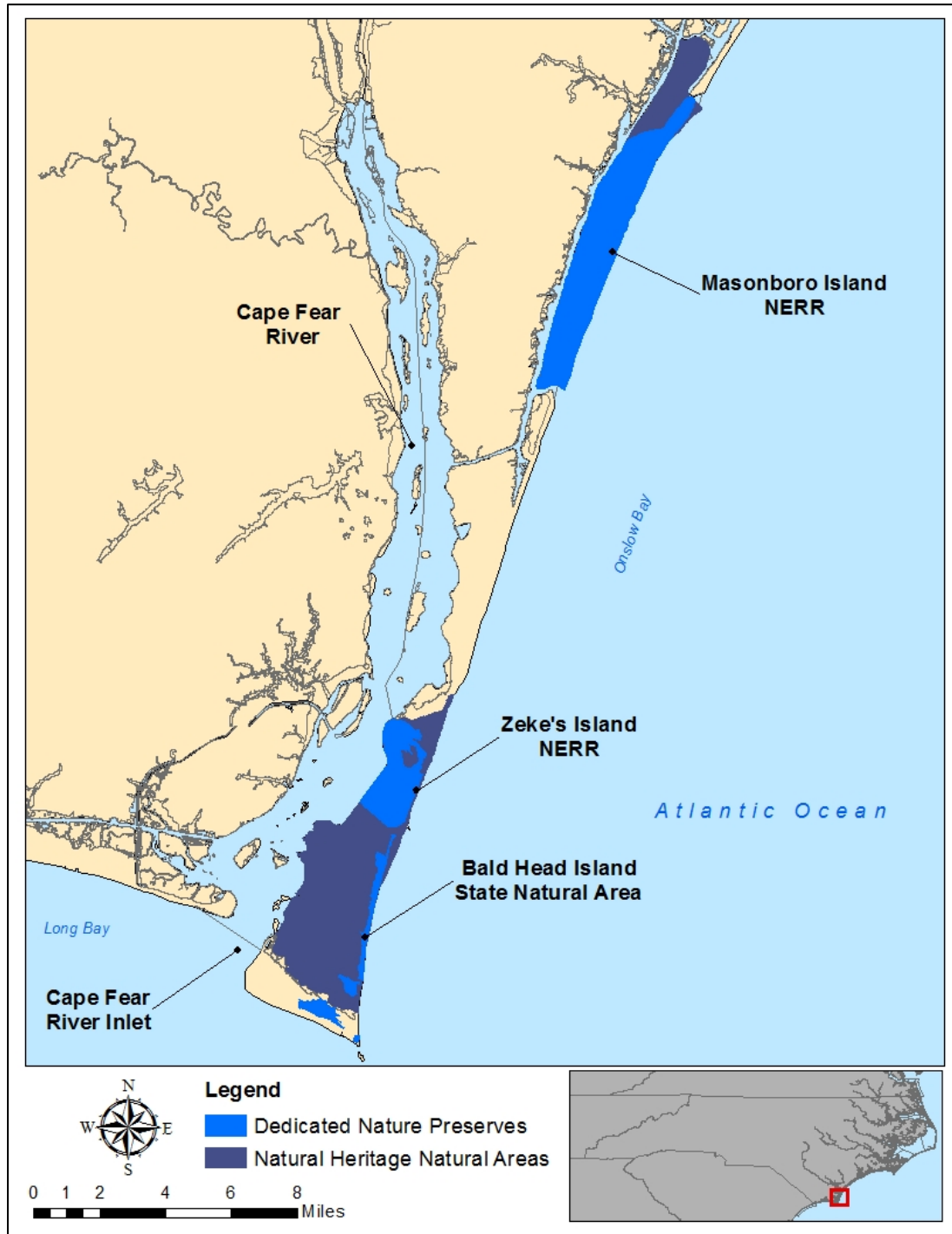


Figure A2. A map of coastal New Hanover and Brunswick counties showing North Carolina Natural Heritage Natural Areas and National Estuarine Research Reserves (NERRs)

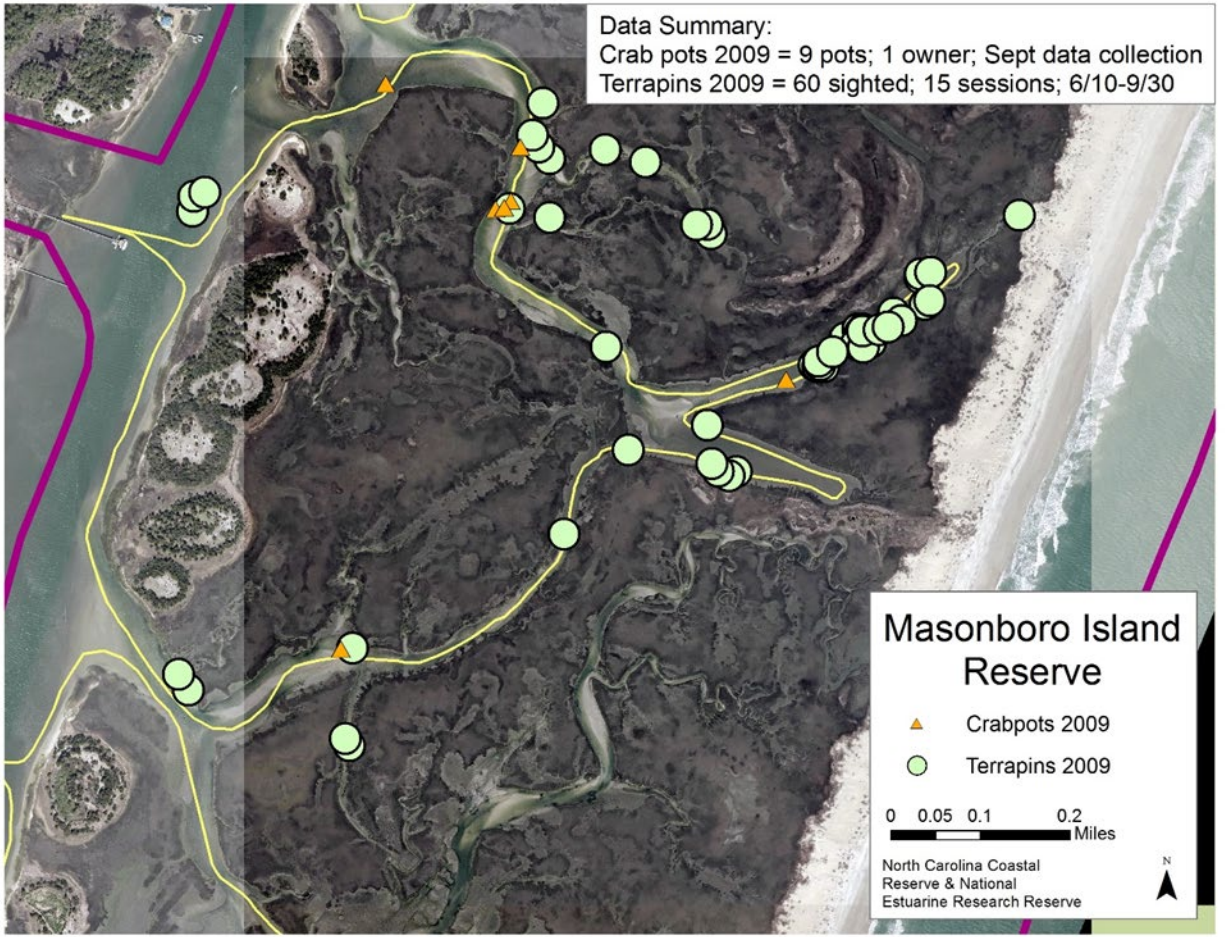


Figure A3. A map showing diamondback terrapin and crab pot locations and counts from a fixed route kayak survey conducted in the Masonboro Island NERR in 2009. Example results of diamondback terrapin and crab pot count data from fixed route kayak surveys in Masonboro Island National Estuarine Research Reserve.

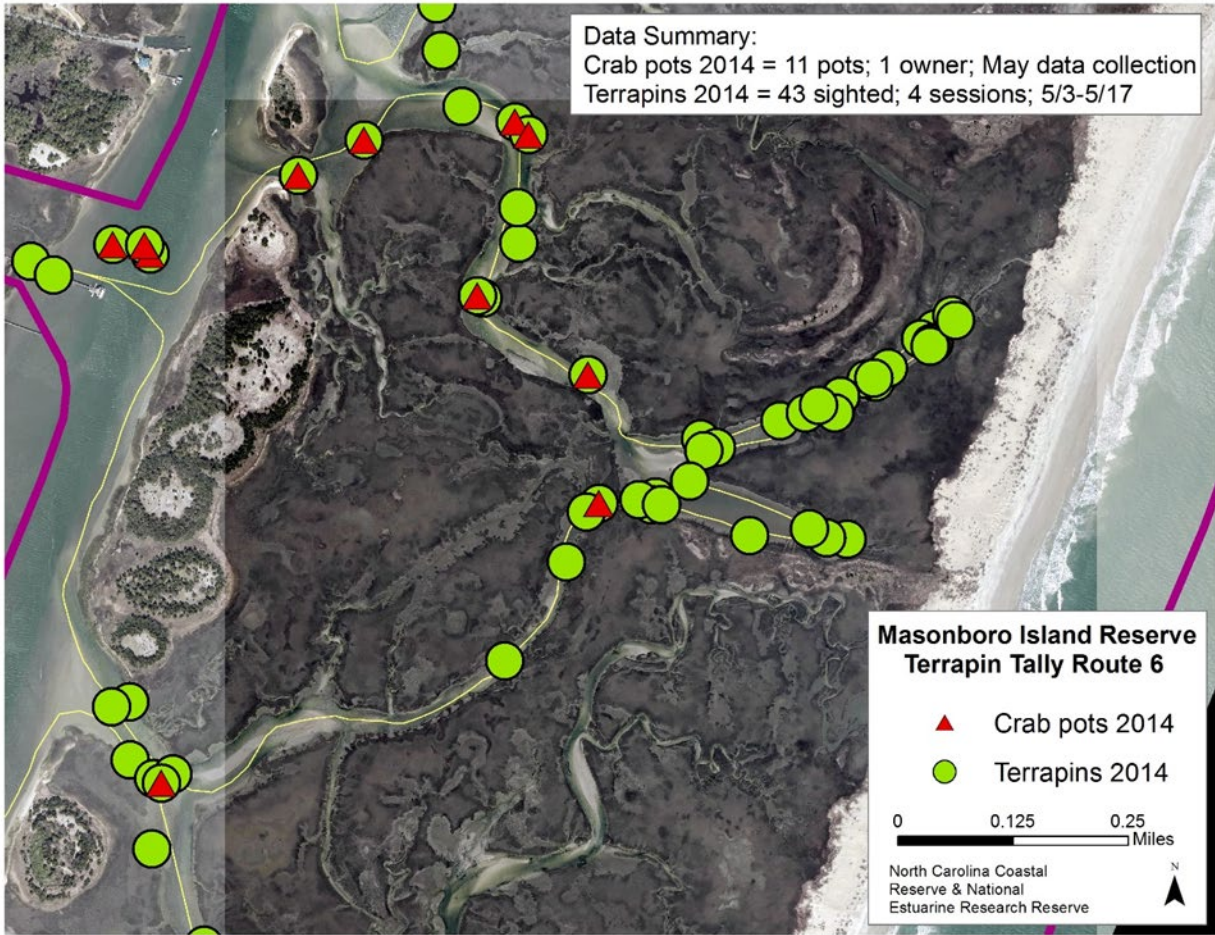


Figure A4. A map showing diamondback terrapin and crab pot locations and counts from a fixed route kayak survey conducted in the Masonboro Island NERR in 2014. Example results of diamondback terrapin and crab pot count data from fixed route kayak surveys in Masonboro Island National Estuarine Research Reserve.

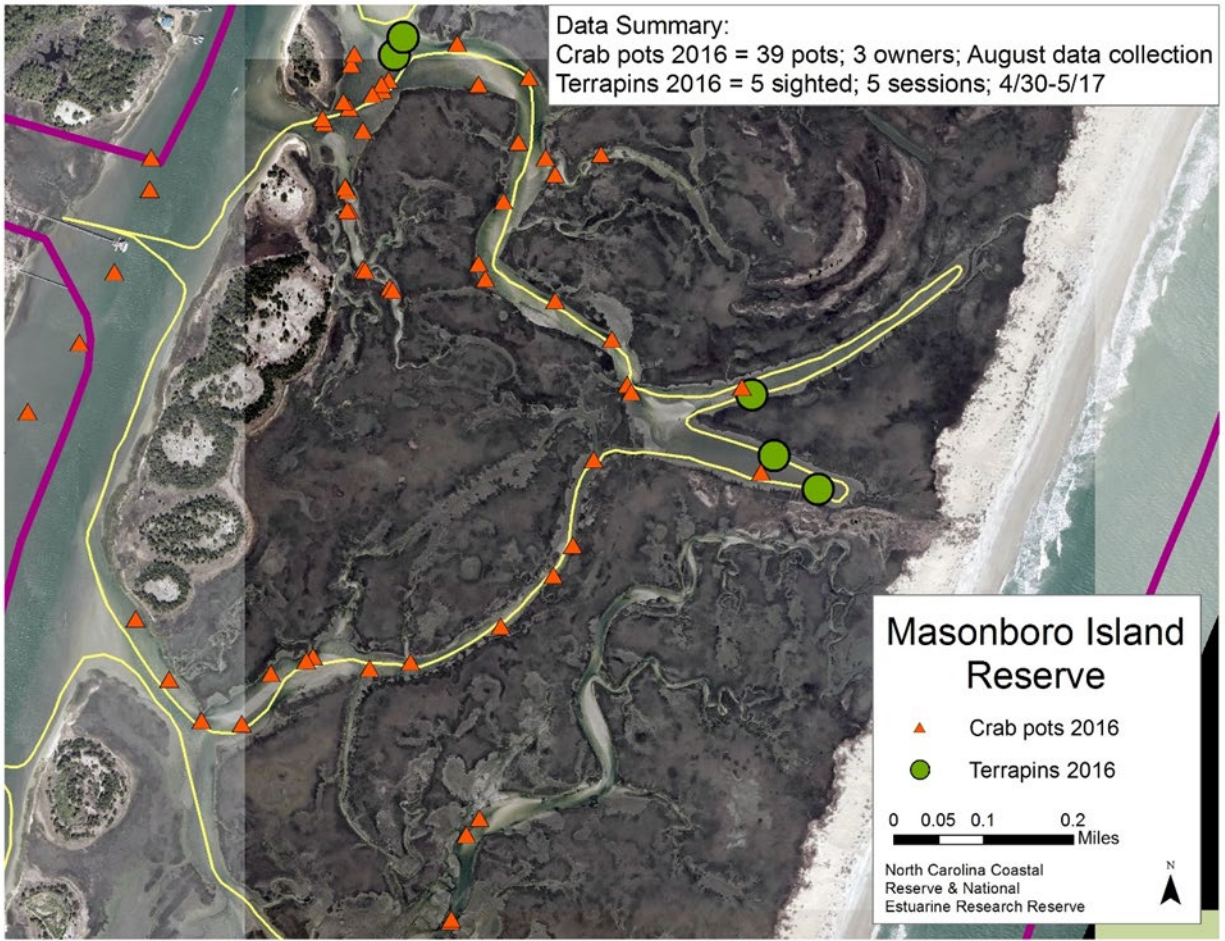


Figure A5. A map showing diamondback terrapin and crab pot locations and counts from a fixed route kayak survey conducted in the Masonboro Island NERR in 2016. Example results of diamondback terrapin and crab pot count data from fixed route kayak surveys in Masonboro Island National Estuarine Research Reserve.

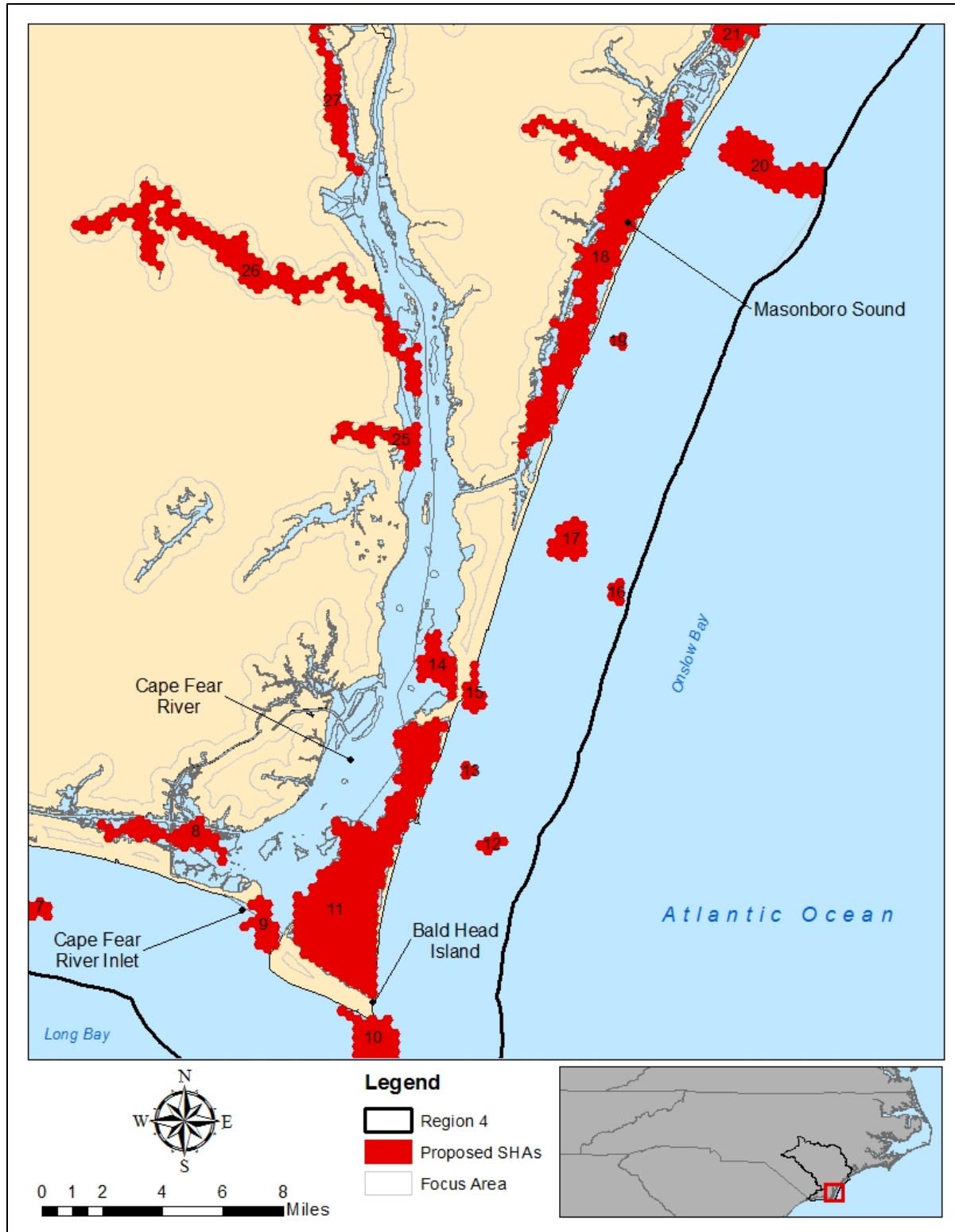


Figure A6. A map of coastal New Hanover and Brunswick counties showing nominated Strategic Habitat Areas in Region 4 of the North Carolina Coastal Habitat Protection Plan.

Proposed Management Areas

Two Diamondback Terrapin Management Areas (DTMAs) are proposed, the Masonboro Island DTMA and the Bald Head Island DTMA (Figure A7). The proposed Masonboro Island DTMA lies entirely within, and shares nearly the entire boundary with, the Masonboro Island Estuarine Research Reserve and Natural Area. This area is also naturally bounded on the east by Masonboro Island, and on the west by the Intracoastal Waterway (IWW). The proposed Bald Head Island DTMA is comprised of Zeke's Island Estuarine Research Reserve in the northern portion of the management area and the Bald Head Island State Natural Area as the southern portion. This area is also naturally bounded by a barrier island to the east, and Bald Head island to the south. The western boundary of this management area follows the "Wall", a rock structure that separates the Cape Fear River from Buzzard Bay, and also serves as the boundary for the Zeke's Island Estuarine Research Reserve. At the end of the wall, a line is drawn southwesterly to the northern tip of Bald Head Island. These two areas use boundaries such as the IWW, landmarks, or existing reserve borders to maximize ease of marking these areas and enforcement.

Each DTMA has been selected to minimize the inclusion of areas outside the zone of potential diamondback terrapin interaction with crab pots, without creating overly complex and unenforceable borders (Table A1). Of the area that is water in the Masonboro Island DTMA, 85% meets the depth and distance criteria considered within the interaction zone, and 61% of the water area in the Bald Head Island DTMA is considered within the interaction zone. The area in the Masonboro Island DTMA that does not fall within this zone is primarily in Dick Bay, which is mostly less than 3 m (9.9 ft.) deep at low tide, but is a large open area which contains area greater than 250 m (820.2 ft.) from any shoreline. Dick Bay is included within the proposed DTMA to reduce complexity in marking and enforcement, as the IWW forms a natural western boundary for this management area. In the Bald Head Island DTMA, the amount of water area that is not considered in the interaction zone is primarily caused by the larger open areas of water to the east of the Wall in the Basin, Second Bay, and Buzzard Bay. These areas are mostly less than 3 m (9.8 ft.) deep at low tide but have area that is greater than 250 m (820.2 Ft.) from any shoreline. These areas were also included in the proposed DTMA to reduce complexity in marking and enforcement, as the Wall forms a well-defined boundary for this management area.

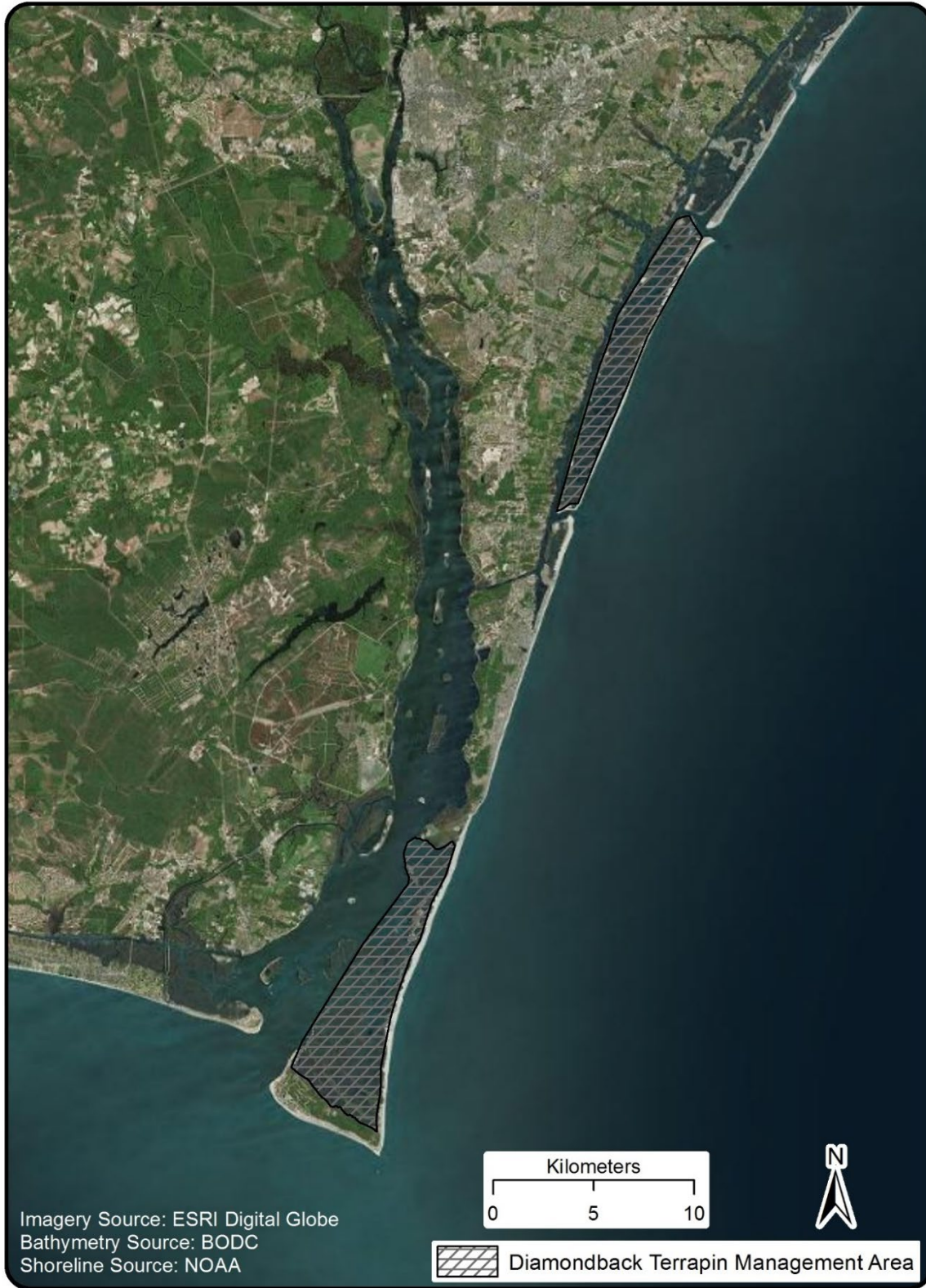


Figure A7. A map of coastal New Hanover and Brunswick counties showing proposed Diamondback Terrapin Management Areas.

Table A1. Total area in acres of proposed Masonboro and Bald Head Island DTMAs, including percent of DTMA that is water, percent of water area that is in the potential interaction zone (< 3 m (9.8 ft.) deep, < 250 m (820.2 ft.)), and percent of the total Trip Ticket reporting area (Masonboro Sound, Cape Fear River) the DTMA encompasses.

Acreage Category	Masonboro	Bald Head
Total land and water area of DTMA (acres)	5,739	9,945
Percent of DTMA area that is water	59%	39%
Percent of DTMA water area in interaction zone	85%	61%
Percent DTMA is of total Trip Ticket reporting area	64%	29%

Regional Commercial Blue Crab Fishery Information

Landings and participation data for the blue crab fishery does not exist at a fine enough scale relative to specific waterbodies to directly assess the number of participants which could be impacted by the creation of the proposed DTMAs. Trip ticket reporting areas for this region include Masonboro Sound, which encompasses the proposed Masonboro Island DTMA and the Cape Fear River, which encompasses the proposed Bald Head Island DTMA. The proposed Masonboro Island DTMA comprises 64% of the Masonboro Sound trip ticket reporting area, while the proposed Bald Head Island DTMA comprises 29% of the Cape Fear River trip ticket reporting area (Table A1). From 2007 and 2016, between 12 and 19 (average of 15) participants reported landings of blue crabs from hard crab and peeler pots from Masonboro Sound, and between 9 and 22 (average 15) participants reported landings of blue crabs from hard crab and peeler pots from the Cape Fear River (Figure A8). Participants reporting landings are generally declining in the Cape Fear River and increasing in Masonboro Sound. Although the proposed Masonboro Island DTMA occupies a smaller footprint, it may likely impact more individual participants than the proposed Bald Head Island DTMA as there are more participants and the proposed Masonboro Island DTMA occupies a greater percentage of the trip ticket reporting area.

Additional species which are landed from crab pots in these two trip ticket reporting areas include whelks “conch” (*Busycon and Busycotypus spp.*), and Florida stone crabs (*Menippe mercenaria*). Landings and participation data for whelk examined by trip ticket reporting area are considered confidential (having a small number of participants) when examined on an annual scale, and are presented as ten-year averages (Table A2). From 2007 and 2016, between 4 and 10 (average of 7) participants reported landings of stone crab from hard crab and peeler pots from Masonboro Sound, and between 3 and 8 (average 5 participants reported landings of stone crab from hard crab and peeler pots from the Cape Fear River (Figure A9). Landings of stone crabs show fluctuations in number between years and area, and average a very small percentage (less than .5%) of the overall landings from crab pots in these two reporting areas. Ten-year average (from 2007 to 2016) landings values for these three species from the Masonboro Sound and Cape Fear River trip ticket reporting areas show Blue Crab as the highest average landings values, followed by stone crab then whelk (Table A3).

Table A2. Average landings of whelk (conch) meats from hard crab and peeler pots, and average number of participants reporting landings between 2007 and 2016 from Trip Ticket reporting areas Masonboro Sound, and Cape Fear River.

Trip Ticket Area	Average Landings	Average Number of Participants
Masonboro Sound	43	2
Cape Fear River	76	3

Table A3. Average value of reported landings of blue crab, whelk (conch), and stone crab from hard crab and peeler pots, between 2007 and 2016 from Trip Ticket reporting areas Masonboro Sound, Cape Fear River, and statewide total. Numbers in parenthesis represent the percentage of each area to the statewide average for each species.

Species	Masonboro Sound	Cape Fear River	Statewide
Blue Crab	\$ 116,809 (0.46%)	\$ 580,185 (2.32%)	\$24,954,534
Whelk	\$ 87 (0.11%)	\$ 150 (0.19%)	\$80,890
Stone Crab	\$ 1,407 (7.52%)	\$ 970 (5.18%)	\$18,717

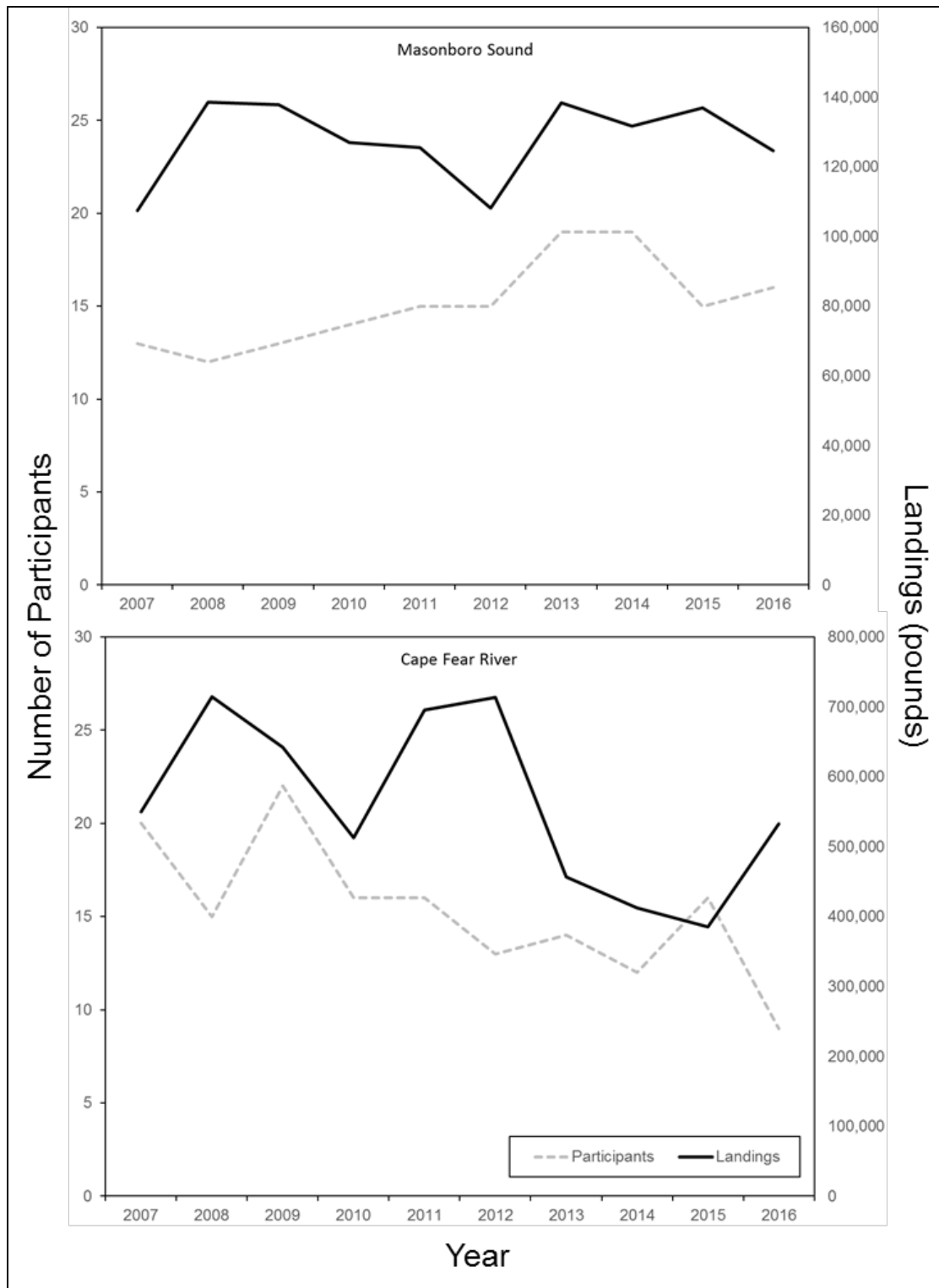


Figure A8. A graph showing number of participants (left axis, dashed line) and landings in pounds (right axis, solid line) of blue crabs in both, hard crab and peeler pots for the Masonboro Sound (upper panel) and Cape Fear River (lower panel) trip ticket reporting areas.

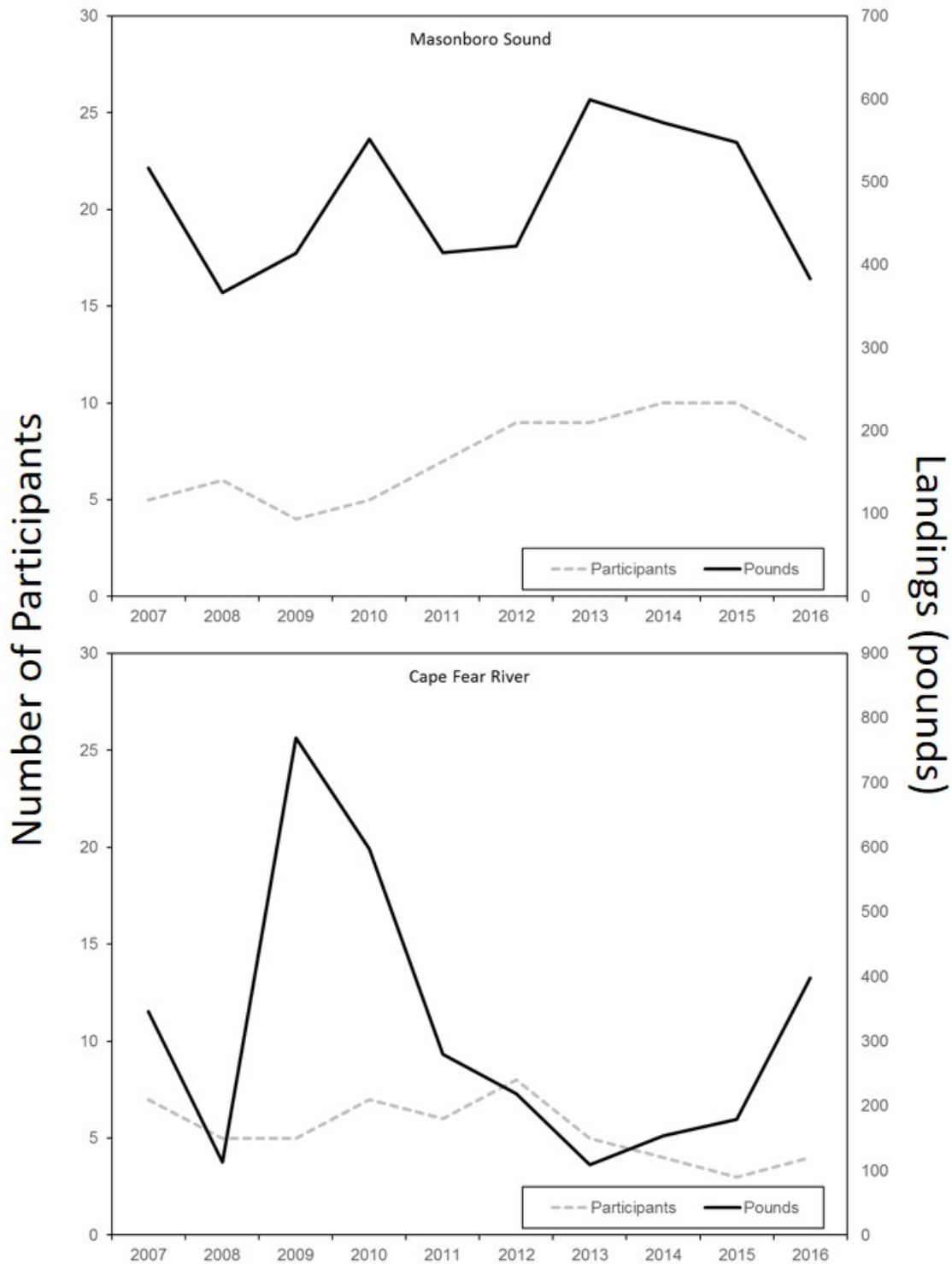


Figure A9. A graph showing number of participants (left axis, dashed line) and landings in pounds (right axis, solid line) of stone crabs in both, hard crab and peeler pots for the Masonboro Sound (upper panel) and Cape Fear River (lower panel) trip ticket reporting areas.

LITERATURE CITED

1. Dorcas, M.E., J.C. Beane, A.L. Braswell, E.C. Corey, M. Godfrey, J. Humphries, T. Lamb, S.J. Price. 2011. Reevaluation of status listings for jeopardized amphibians and reptiles in North Carolina: Report of the Scientific Council on Amphibians and Reptiles submitted to the Nongame Wildlife Advisory Committee of the North Carolina Wildlife Resources Commission. February 2011. 60 pp.
2. Dorcas, M.E., J.D. Wilson, and J.W. Gibbons. 2007. Crab trapping causes population decline and demographic change in diamondback terrapins over two decades. *Biological Conservation*. 137: 334-340.
3. Grant, G.S. 1997. Impact of crab pot excluder devices on diamondback terrapin mortality and commercial crab catch. North Carolina Fisheries Resource Grant. University of North Carolina, Department of Biological Science. Wilmington, NC. 9 pp.
4. Thorpe, T., M. Hooper, and T. Likos. 2005. Bycatch potential, discard mortality and condition of fish and turtles associated with the spring commercial blue crab (*Callinectes sapidus*) pot fishery. Final Report. North Carolina Sea Grant. 04-POP-03. 18 pp.
5. Thorpe, T. and T. Likos. 2008. Evaluation of terrapin excluder devices on blue crab (*Callinectes sapidus*) pots: effects on diamondback terrapin (*Malaclemys terrapin*) bycatch and target catch efficiency. Final Report. North Carolina Sea Grant. 06-POP-04. 27 pp.
6. Southwood, A., J. Wolfe, and L.A. Harden. 2009. Diamondback terrapin distribution and habitat utilization in lower Cape Fear River. Final Report NC Sea Grant 08-POP-06. 23 pp.
7. Alford, A. and A. Southwood Williard. 2010. Use of modified crab pots to monitor diamondback terrapin (*Malaclemys terrapin*) populations at Masonboro Island, NC. Poster session presented at the Fifth Symposium on the Ecology, Status, and Conservation of the Diamondback Terrapin, the Louisiana Universities Marine Consortium (LUMCON) Chauvin, LA.
8. Southwood Williard, A. and L.A. Hardin. 2010. North Carolina Sea Grant, Mini-grant – Using postcard surveys to investigate potential interactions between blue crab fisheries and diamondback terrapins in coastal North Carolina. Sea Grant unpublished.
9. Harden, L.A., A. Southwood Williard. 2012. Using spatial and behavioral data to evaluate seasonal bycatch risk of diamondback terrapins *Malaclemys terrapin* in crab pots. *Marine Ecology Progress Series*. 467: 207-217.
10. Chavez, S., and A. Southwood Williard. 2017. The effects of bycatch reduction devices on diamondback terrapin and blue crab catch in the North Carolina commercial crab fishery. *Fisheries Research* 186: 94-101.
11. Munden, M.P. 2018. Population change of Diamondback Terrapins (*Malaclemys terrapin*) around Masonboro Island from 2009-2017: Are crab pots a factor? Honors Thesis, University of North Carolina Wilmington, Wilmington, North Carolina, USA.
12. Lovich, J.E., M. Thomas, K. Ironside, C. Yackulic, and S.R. Puffer. 2018. Spatial distribution of estuarine diamond-backed terrapins (*Malaclemys terrapin*) and risk analysis from commercial blue crab (*Callinectes sapidus*) trapping at the Savannah Coastal Refuges Complex, USA. *Ocean and Coastal Management*. 157: 160-167.

APPENDIX 4.6: BOTTOM DISTURBING GEAR IN THE BLUE CRAB FISHERY

I. ISSUE

Limit the use of bottom disturbing fishing gear in the blue crab fishery (dredges and trawls), to reduce habitat impacts and improve spawning potential by mature females.

II. ORIGINATION

The “Fishery Impacts to the Ecosystem” section of this plan described habitat impacts associated with dredging and trawling. The NC Coastal Habitat Protection Plan requires that habitat is protected from adverse fishing gear effects. This issue paper will evaluate the need for regulatory changes associated with crab dredging and crab trawling.

III. BACKGROUND

The crab trawl and dredge fisheries have important historical and cultural significance to North Carolina’s commercial fishing past. Since the turn of the twentieth century, and the advent of the motorboat, these gears have provided a way for fishermen to harvest crabs in the winter when other gears are ineffective. Due to market demands and the predominance of crab pots for the better part of the last century, crab trawl and dredge landings have waned; making up less than one percent of all crab landings in 2017. Despite their historical significance, these gears present both fishery and habitat level concerns. As discussed in the issue paper “Management Options Beyond Quantifiable”, these fisheries predominately catch mature female crabs in some areas that are bedded down in the mud, overwintering. Crab trawl and dredge fisheries utilize bottom disturbing gear that can damage fragile habitats critical to a wide variety of North Carolina’s important fish and invertebrate species.

The targeting of blue crabs with dredges on public bottom is restricted to one designated area in northern Pamlico Sound, during certain times of year when open (NCMFC Rule 15A NCAC 03L .0203 (a)(1)); or when taken as incidental catch during lawful oyster dredging (NCMFC Rule 15A NCAC 03L .0203 (a)(2)). The taking of blue crabs with crab trawls on public bottom is permitted in large areas of coastal and joint waters south of the Albemarle Sound. Areas and times in which crab trawls may be used to harvest crabs is specified by proclamation (NCMFC Rule 15A NCAC 03L .0202).

In 2013, as part of the adaptive management framework approved in Amendment 2 to the Blue Crab Fishery Management Plan, NCMFC Rule 15A NCAC 03L .0201 CRAB HARVEST RESTRICTIONS was modified, adding:

15A NCAC 03L .0201

(f) In order to comply with management measures adopted in the N.C. Blue Crab Fishery Management Plan, the Fisheries Director may, by proclamation, close the harvest of blue crabs and take the following actions for commercial and recreational blue crab harvest:

(1) specify areas;

- (2) specify seasons;
- (3) specify time periods;
- (4) specify means and methods;
- (5) specify culling tolerance; and
- (6) specify limits on harvest based on size, quantity, sex, reproductive stage, or peeler stage.

A similar statement allowing proclamation authority to restrict the use of dredges to take crabs was also added (NCMFC Rule 15A NCAC 03L .0203 (a)(3)). Additionally, to reduce the bycatch of juvenile flounder in crab trawls, NCMFC Rule 15A NCAC 03L .0202 was modified, increasing the crab trawl minimum mesh length to take hard crabs to four inches in designated areas.

In Amendment 2, blue crabs were not overfished, but there were concerns due to declining indicators (1). A habitat recommendation to consider prohibiting crab dredging was included based on severe habitat damage that can result from dredging. Additionally, gear closure was a potential management strategy included in the blue crab adaptive management framework.

In the 2016 revision to Amendment 2, the NCMFC adopted a partial gear closure implemented through Proclamation M-11-2016. The designated crab dredge area in northern Pamlico Sound was closed; however, incidental harvest of crabs during lawful oyster dredging continued to be allowed as outlined in NCMFC Rule 15A NCAC 03L. 0203(a)(2). Once Amendment 3 to the Blue Crab FMP goes into effect, adaptive management measures for Amendment 2 will be discontinued unless re-adopted in Amendment 3 (2).

In part because the 2018 stock assessment indicated blue crabs were overfished and overfishing was occurring (3), a dredge gear closure, trawl gear modification, and area restriction are being revisited. However, the primary reason for evaluating the use of these gears in the blue crab fishery concerns their habitat impacts. While not contributing substantially to the blue crab fishery, bottom disturbing gears can substantially degrade SAV, shell bottom, soft bottom, and water quality due to high sediment disturbance (2). Further limiting the use of these gears would pose minimal economic impact to fishermen and reduce habitat impacts and fishing mortality of primarily adult females in some areas.

IV. AUTHORITY

North Carolina General Statute 113-134 – Rules
North Carolina General Statute 113-182 – Regulation of fishing and fisheries
North Carolina General Statute 113-221.1 – Proclamations; emergency review
North Carolina General Statute 143B-289.52 – Marine Fisheries Commission – powers and duties
NCMFC Rule 15A NCAC 03H .0103 – Proclamations, General
15A NCAC 03J .0104 Trawl nets
15A NCAC 03L .0202 Crab trawling
15A NCAC 03L .0203 Crab dredging
15A NCAC 03R .0109 Taking crabs with dredges
15A NCAC 03R .0110 Crab Spawning Sanctuaries

V. DISCUSSION

Taking crabs with dredges

The dredge fishery had minimal crab landings in recent years (Table 4.6.1), with most dredge landings coming from oyster dredges in January and February (Table 4.6.2). Since 1995, landings from crab dredging were less than 10,000 lb./year, with the exception of 2010 when 52,769 lb. were landed. Blue crab landings from oyster dredging were minimal (less than 1000 lb.) from 1995 to 2003. From 2004 to 2016, landings increased slightly, with the exception of a sharp increase in landings in 2010 and 2011 (Table 4.6.1, Figure 4.6.1). This increase is reflective of a high abundance of crabs in the crab dredge area during the open season due to cooler than normal temperatures and the ease of entering the oyster dredge fishery with a shellfish license that had been intended for hand harvest only. Beginning with the 2012-13 oyster season, management changes were made to the means and methods for Mechanical Harvest of oysters to encourage culled material be returned on a reef. Also, a statutory change in 2013 limited shellfish harvest using the shellfish license to hand harvest only. These changes, along with lower abundance of adult oysters in the Pamlico system, led to lower effort and crab landings after 2011.

The crab dredge fishery is only allowed by NCMFC rule in a designated crab dredge area in northern Pamlico Sound (Figure 4.6.2) in January and February. However, it has remained closed by proclamation since June 2016. The total designated dredge area is 86,899 acres. A Seed Oyster Management Area (SOMA) and three oyster sanctuaries (Crab Hole, Croatan, and Pea Island) occur within the crab dredge area. Dredging is not permitted within oyster sanctuary boundaries. The estuarine portion of the Oregon Inlet Crab Spawning Sanctuary is also within the designated crab dredge area (see Figure 4.4.4).

There are 8,071 acres of SAV and 308 acres of shell bottom mapped within the crab dredging area. Areas greater than 15-ft have not been mapped for shell bottom, therefore the total acreage of shell bottom is likely underestimated. These sensitive habitats are critical to various life stages of blue crabs along with numerous other fish and invertebrates. Because of the diversity of habitat in this area, the critical location as a migratory corridor to the ocean, and good quality of the habitats and water quality, and the ecosystem services provided by these habitats several [Strategic Habitat Areas](#) were designated within the dredge area as part of CHPP Regions 1 and 2. Ecosystem services provided by SAV and shell bottom include stabilizing sediment, improving water clarity, reducing shoreline erosion, and stabilizing marsh edge habitat (2). Additionally, SAV releases oxygen into the water, while subtidal oyster rocks with vertical relief provide refuge for crabs and other invertebrates during anoxic events. Maintaining these habitat complexes will not only enhance conditions needed for blue crab as well as numerous other fishery and non-fishery species, but benefit the entire coastal ecosystem. It is well recognized that crab dredging, which is designed to dig up overwintering crabs from the mud, causes more severe damage to benthic habitat than any other gear actively used in NC, particularly to SAV and oysters (4; 5; 6; 2). Since there are less habitat damaging methods available to harvest crabs, the CHPP recommended in 2010 that crab dredging be prohibited.

Table 4.6.1. Annual blue crab landings (pounds) and value (\$) from dredges, trawls, and overall, 1995 – 2017. Confidential data is given as less-than a rounded value.

Year	Crab Dredge		Oyster Dredge		Crab Trawl		Shrimp Trawl		Other Gears		Total	
	Weight (lb.)	Value (\$)	Weight (lb.)	Value (\$)	Weight (lb.)	Value (\$)	Weight (lb.)	Value (\$)	Weight (lb.)	Value (\$)	Weight (lb.)	Value (\$)
1995	7,403	4,220	541	308	1,065,578	736,465	225,228	137,832	45,144,790	35,360,461	46,443,541	36,239,286
1996	9,590	4,569	<250	<150	3,090,591	1,733,261	304,450	161,274	63,675,568	41,143,330	67,080,200	43,042,434
1997	2,567	1,328	<250	<150	3,291,288	2,019,161	312,823	189,607	52,483,431	35,475,942	56,090,109	37,686,039
1998	0	0	171	95	3,086,044	1,985,076	554,043	311,755	58,435,913	42,662,715	62,076,170	44,959,640
1999	0	0	213	110	1,817,726	1,149,536	281,370	159,002	55,447,368	36,503,552	57,546,676	37,812,199
2000	0	0	591	390	941,824	759,561	209,247	154,819	39,486,723	36,522,957	40,638,384	37,437,728
2001	7,101	5,524	358	226	997,763	778,549	186,053	122,757	30,989,115	31,324,540	32,180,390	32,231,596
2002	328	239	129	72	1,119,239	657,628	160,664	96,679	36,455,959	32,393,815	37,736,319	33,148,432
2003	8,704	5,016	<1,500	<1,000	1,259,721	850,996	305,582	193,035	41,195,791	36,059,046	42,769,797	37,108,093
2004	4,838	3,357	2,113	1,343	896,554	539,501	163,715	74,368	33,063,388	23,847,274	34,130,608	24,465,843
2005	<1,500	<1,000	6,007	3,030	388,996	365,568	61,807	31,144	24,973,309	19,874,171	25,430,119	20,273,913
2006	<100	<75	2,643	1,185	138,708	90,925	37,027	14,754	25,164,781	16,980,531	25,343,158	17,087,395
2007	2,656	2,742	572	402	28,789	30,811	31,772	15,613	21,361,171	21,382,387	21,424,960	21,431,955
2008	0	0	225	113	1,557,934	863,662	4,244	3,380	31,354,288	26,688,232	32,916,691	27,555,386
2009	7,981	7,166	<100	<75	913,928	556,676	17,298	11,484	28,768,025	26,853,669	29,707,232	27,428,995
2010	52,769	46,163	18,567	15,426	289,399	248,343	11,575	10,395	30,310,701	26,223,464	30,683,011	26,543,791
2011	6,843	4,348	31,861	19,584	201,940	112,871	5,785	4,902	29,788,963	21,140,558	30,035,392	21,282,264
2012	2,335	1,854	2,756	2,108	10,075	11,964	24,146	11,303	26,746,357	22,779,708	26,785,669	22,806,938
2013	0	0	1,305	1,412	56,470	59,638	41,609	31,125	22,103,238	29,914,273	22,202,623	30,006,447
2014	<50	<50	7,372	8,908	39,902	45,390	48,482	36,271	26,135,209	33,936,824	26,230,965	34,027,403
2015	<2,000	<1,500	5,216	5,395	187,107	212,337	12,551	14,187	31,928,245	33,492,505	32,134,501	33,724,424
2016	1,962	1,529	1,404	1,576	165,569	135,633	17,051	14,555	25,274,871	23,959,423	25,459,475	24,112,715
2017	0	0	1,302	1,413	120,135	123,169	17,771	22,045	19,134,770	22,072,006	19,273,156	22,217,815
Average 1995-2017	5,099	3,905	7,008	5,598	941,969	611,597	131,926	79,230	34,757,477	29,417,017	35,839,963	30,114,380
Average 2013-2017	671	548	3,320	3,741	113,473	114,916	27,493	23,637	24,915,267	28,675,006	25,060,144	28,817,761

Table 4.6.2. Average monthly blue crab landings (pounds) and value from crab and oyster dredges in the past ten years (2008-2017).

Month	Crab Dredge		Oyster Dredge		Total	
	Weight (lb.)	Value (\$)	Weight (lb.)	Value (\$)	Weight (lb.)	Value (\$)
January	4,016	3,316	1,851	1,344	5,867	4,660
February	3,313	2,911	2,041	1,547	5,436	4,540
March	0	0	656	562	656	562
April	0	0	25	16	25	16
October	0	0	5	3	5	3
November	0	0	1,303	1,060	1,303	1,060
December	0	0	1,126	1,065	1,126	1,065

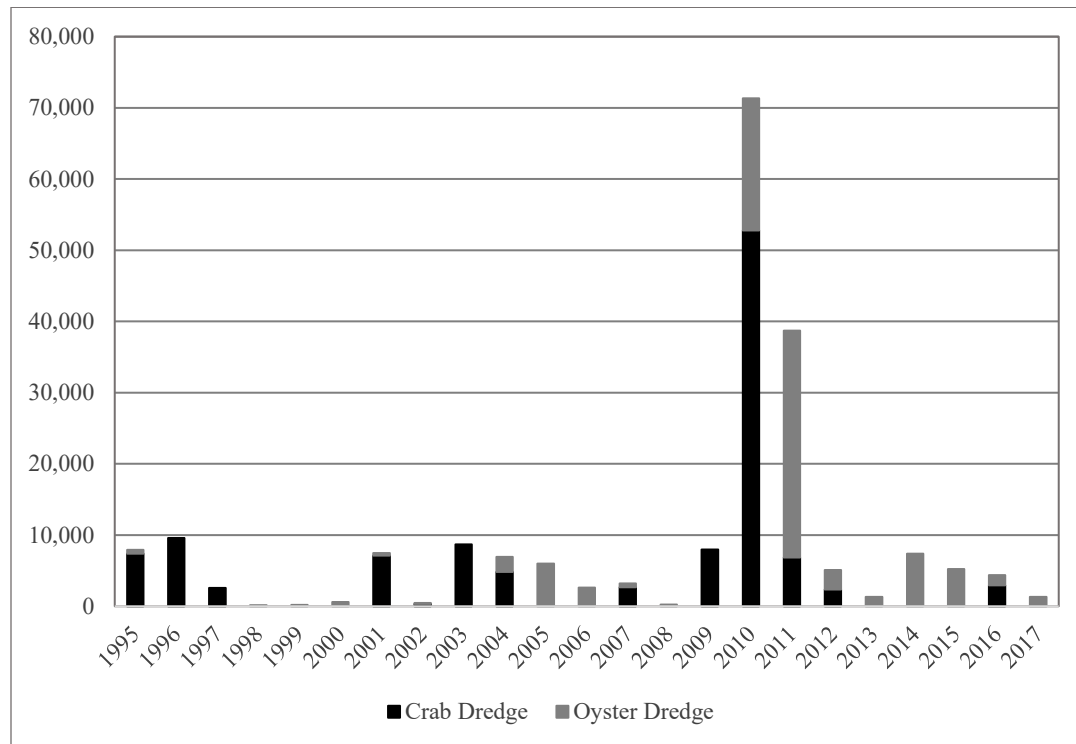


Figure 4.6.1. Blue crab landings from crab and oyster dredges, 1995-2017.

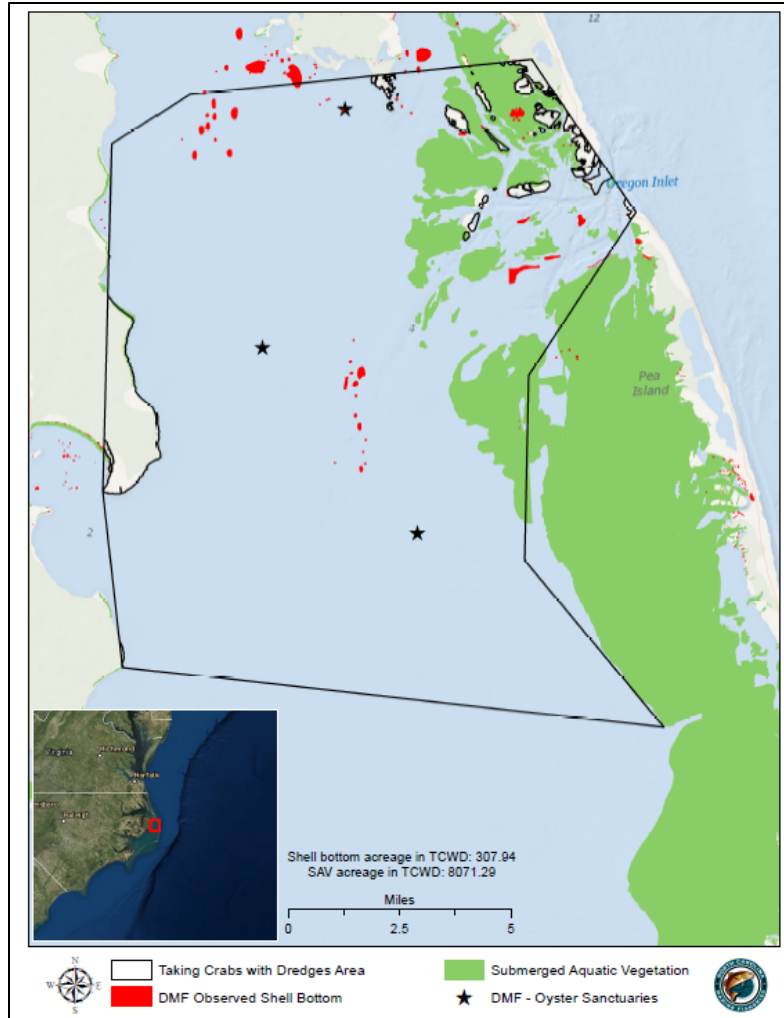


Figure 4.6.2. Location of SAV, shell bottom, and oyster sanctuaries within the designated crab dredge area in northern Pamlico Sound.

Allowing crab harvest in the oyster dredge fishery has enforcement issues. NCMFC Rule 15A NCAC 03L .0203 (a)(2) states that the weight of the crabs shall not exceed 50% of the total weight of the combined oyster and crab catch, or 500 pounds, whichever is less. However, Marine Patrol measures by volume (bushels), not weight, so enforcement of the weight criteria is difficult. The weight of a bushel can be highly variable, making conversion from bushels to weight inaccurate. Additionally, allowing the harvest of crabs could entice fishermen to dredge in soft bottom adjacent to the oyster rock once they have finished oyster fishing until they reach their trip limit. Oyster dredging rules have many requirements (e.g., deploying dredge from the side of the vessel, culling on site) to keep dredging activity on the rock rather than digging along the edges and dispersing culled shell material onto soft sediment. Targeting crabs in the soft bottom adjacent to the oyster rock was not the intent of this rule and could lead to unlawful oyster dredging operations, suspended sediments in the water column, siltation, and damage to shell bottom on the growing edge of the structure. Since the majority of crabs harvested in the oyster dredge fishery are mature females in some areas (7), allowing blue crab harvest can lead

to additional stress on the spawning stock and reduce reproductive output needed to increase the blue crab population.

Blue crab landings taken with oyster and crab dredges, as well as effort, are not a significant contributor to the overall blue crab fishery. Landings accounted for only 0.02% of the total blue crab landings over the past five years (2013-2017; average annual value \$4,711). Landings from trawls were similarly low. In contrast, while remaining gears, primarily pots, accounted for 99.42%. The number of participants in the crab dredge fishery in the past five years has ranged from 0-6, and in the oyster dredge fishery ranged from 119-268 (Table 4.6.3).

Table 4.6.3. Participation in the crab dredge, oyster dredge, and crab trawl fisheries

Year	Crab Dredge		Oyster dredge		Crab and Peeler Trawls	
	Participants	Trips	Participants	Trips	Participants	Trips
1995	9	36	15	88	225	2,133
1996	5	27	2	3	297	4,198
1997	3	11	6	31	309	4,916
1998	0	0	68	671	270	5,543
1999	0	0	80	940	208	3,447
2000	0	0	50	392	179	2,186
2001	8	26	58	822	200	2,517
2002	3	5	48	621	135	1,027
2003	3	14	56	892	137	1,672
2004	7	19	123	1,750	172	1,744
2005	2	7	167	2,333	99	1,092
2006	1	1	151	2,486	40	296
2007	3	18	150	1,729	32	157
2008	0	0	159	2,688	44	312
2009	9	44	258	4,481	59	473
2010	20	146	506	10,655	55	295
2011	12	69	355	7,400	41	253
2012	3	4	184	2,264	16	45
2013	0	0	220	3,763	18	104
2014	1	1	268	5,705	32	129
2015	2	14	212	4,028	50	384
2016	4	4	177	2,684	45	404
2017	0	0	119	1,540	32	317
Average 1995-2017	4	19	149	2,520	117	1,463
Average 2013-2017	1	4	199	3,544	35	268

Due to the location and season of the crab and oyster dredge fisheries, crab landings are primarily mature females in some areas. Converting pounds to numbers of individual crabs and using the average over the last five years, this equates to approximately 19,524 crabs/year taken with crab dredge and 49,797 crabs/year taken with oyster dredge. While these gears account for a small portion of the overall landings, closing the harvest of blue crabs from these gears would allow more mature females to reproduce the following season. Considering management changes

to prohibit the taking of blue crabs with crab and oyster dredges or lowering the crab catch limit from oyster dredges makes ecological sense with relatively minor economic impact (Table 4.6.1).

Trawling

Another example of a potential gear closure would be to limit crab trawling in the Pamlico, Pungo, and Neuse rivers to the current shrimp trawl lines in each river, or completely prohibit their use statewide.

Over the past five years there have been minimal landings of blue crabs from crab and shrimp trawls in the Pamlico, Pungo, and Neuse rivers (Table 4.6.4). Figures 4.6.3 and 4.6.4 show the current crab trawl boundary lines and the current shrimp trawl boundary lines for the Pamlico and Neuse river systems. Prohibiting crab trawling in the upper areas of the rivers would eliminate all bottom disturbing fishing gear in these areas.

Mobile disturbing bottom gear such as trawls and dredges can adversely impact fish habitat by re-suspending sediments and any associated pollutants into the water column. Suspended sediments can clog gills of juvenile and larval fish, reduce primary production in the water column or benthic community, and release toxins where they can be taken up by estuarine organisms. Dragged gear can cause structural damage or loss to benthic habitats such as SAV and shell bottom. Reviews of fishing gear impacts have categorized crab dredges and crab/shrimp trawls as having more severe impacts than other fishing gear, although the extent varies by the gear configuration, proximity of benthic habitats, and life stages of fish present (4; 2). Refer to the section “Fishery Impacts to the Ecosystem” for more details.

Limiting bottom disturbance could improve habitat conditions not only for blue crab but many other estuarine fishery species and provide additional protection to significant portions of NCMFC approved Strategic Habitat Areas (SHA). Strategic Habitat Areas are complexes of high quality, diverse habitats that provide exceptional ecological functions to important fishery species. These areas have been identified through a comprehensive spatial analysis and represent priority areas for protection and enhancement. Strategic Habitat Areas located within the Pamlico and Neuse systems, as well as other areas open to trawling are shown in Figures 4.6.5 and 4.6.6.

Statewide blue crab landing from crab trawls and shrimp trawls have accounted for only 0.05% and 0.1%, respectively, of the total blue crab harvest over the past five years (Table 4.6.1). The prohibition of blue crab harvest by use of crab and shrimp trawl, as well as crab dredge would have minimal economic effects on the fishery, while addressing fishery and habitat level concerns of these gears.

Table 4.6.4. Annual crab landings (pounds) from crab and shrimp trawls in the Pamlico, Pungo, and Neuse rivers, 1995 – 2017. Confidential data is given as less-than a rounded value.

Year	Crab Trawl			Shrimp Trawl		
	Neuse River	Pamlico River	Pungo River	Neuse River	Pamlico River	Pungo River
1995	35,618	154,056	267,400	34,019	7,452	0
1996	212,979	486,829	298,657	50,710	0	1,412
1997	411,998	400,922	401,605	57,808	11,144	2,883
1998	306,178	559,477	203,993	40,883	1,526	0
1999	243,473	457,575	208,396	31,644	4,264	1,123
2000	47,674	104,043	78,764	11,144	1,472	714
2001	41,030	43,164	17,625	5,390	2,284	462
2002	2,877	4,506	142,682	11,985	1,532	1,027
2003	41,411	139,386	81,037	6,410	<500	<3,000
2004	35,363	76,990	63,604	12,444	0	0
2005	18,982	159,327	8,857	4,992	<500	<500
2006	6,057	19,512	<5,000	1,195	76	<500
2007	1,283	<500	<500	<1,000	<500	0
2008	<500	<500	<500	900	0	0
2009	<500	<500	<500	105	<2,000	0
2010	<500	<500	0	<500	0	0
2011	0	<500	0	<500	<500	0
2012	<500	0	0	0	<500	0
2013	0	0	0	904	0	0
2014	<500	0	0	2,561	0	0
2015	<500	<500	<500	451	<500	0
2016	<1000	<500	<500	<500	<500	0
2017	<500	<500	0	360	0	0

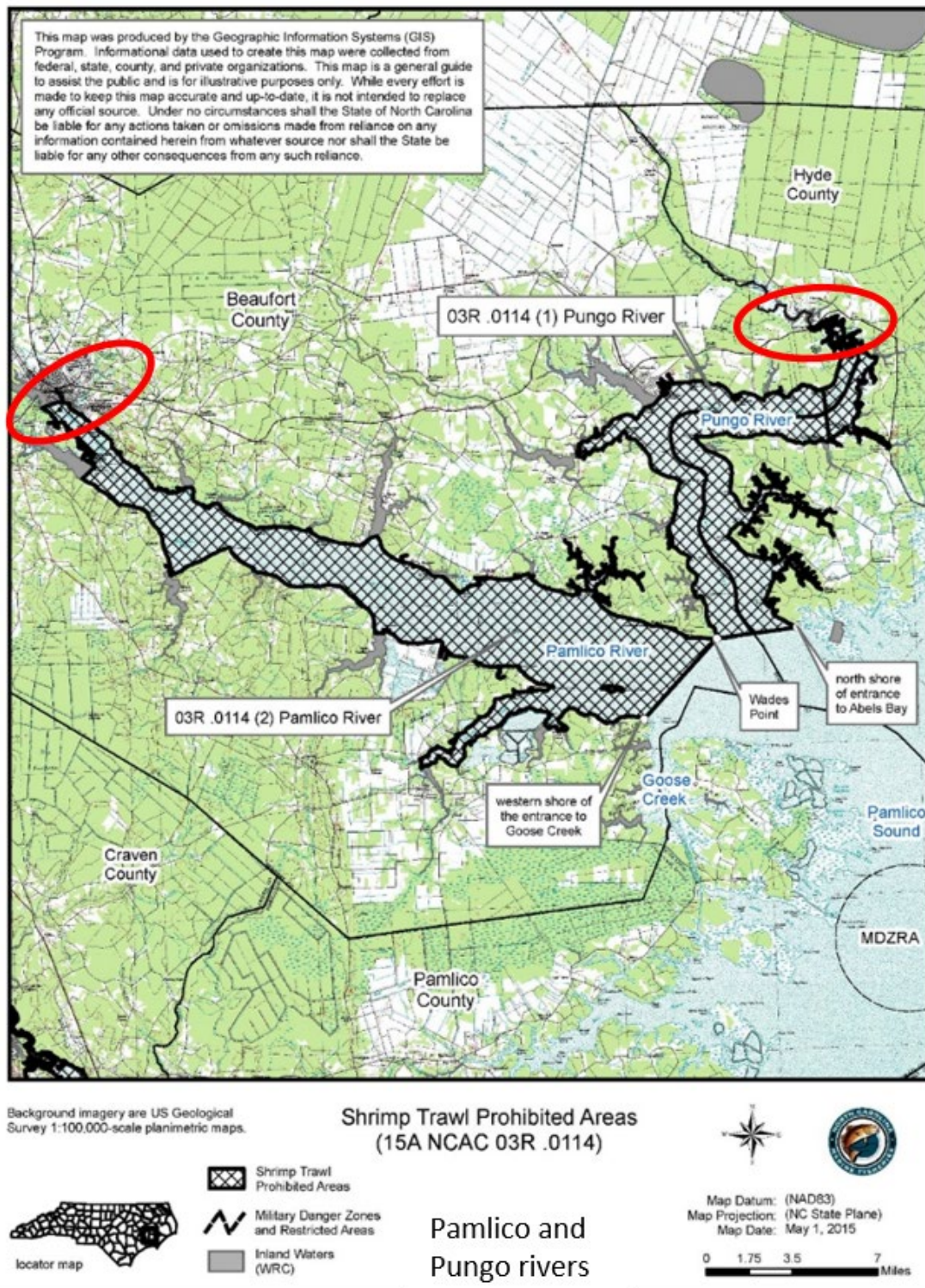


Figure 4.6.3. Areas where crab trawling is allowed within shrimp trawl prohibited areas in the Pamlico and Pungo rivers (hatched area). Red ovals mark the upper limit of trawling.

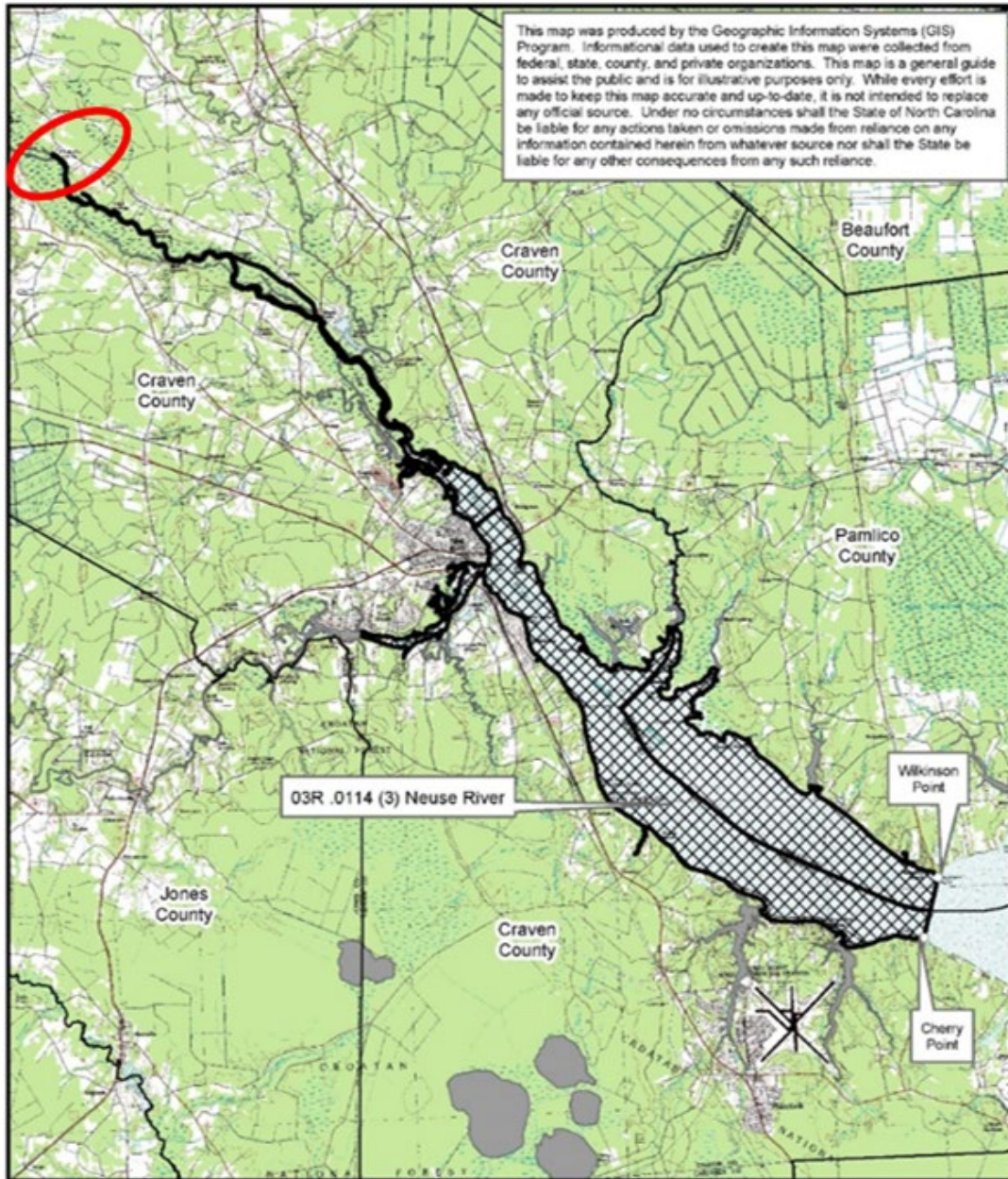


Figure 4.6.4. Area where crab trawling is allowed within the shrimp trawl prohibited area in the Neuse River (hatched area). Red oval marks the upper limit of trawling.

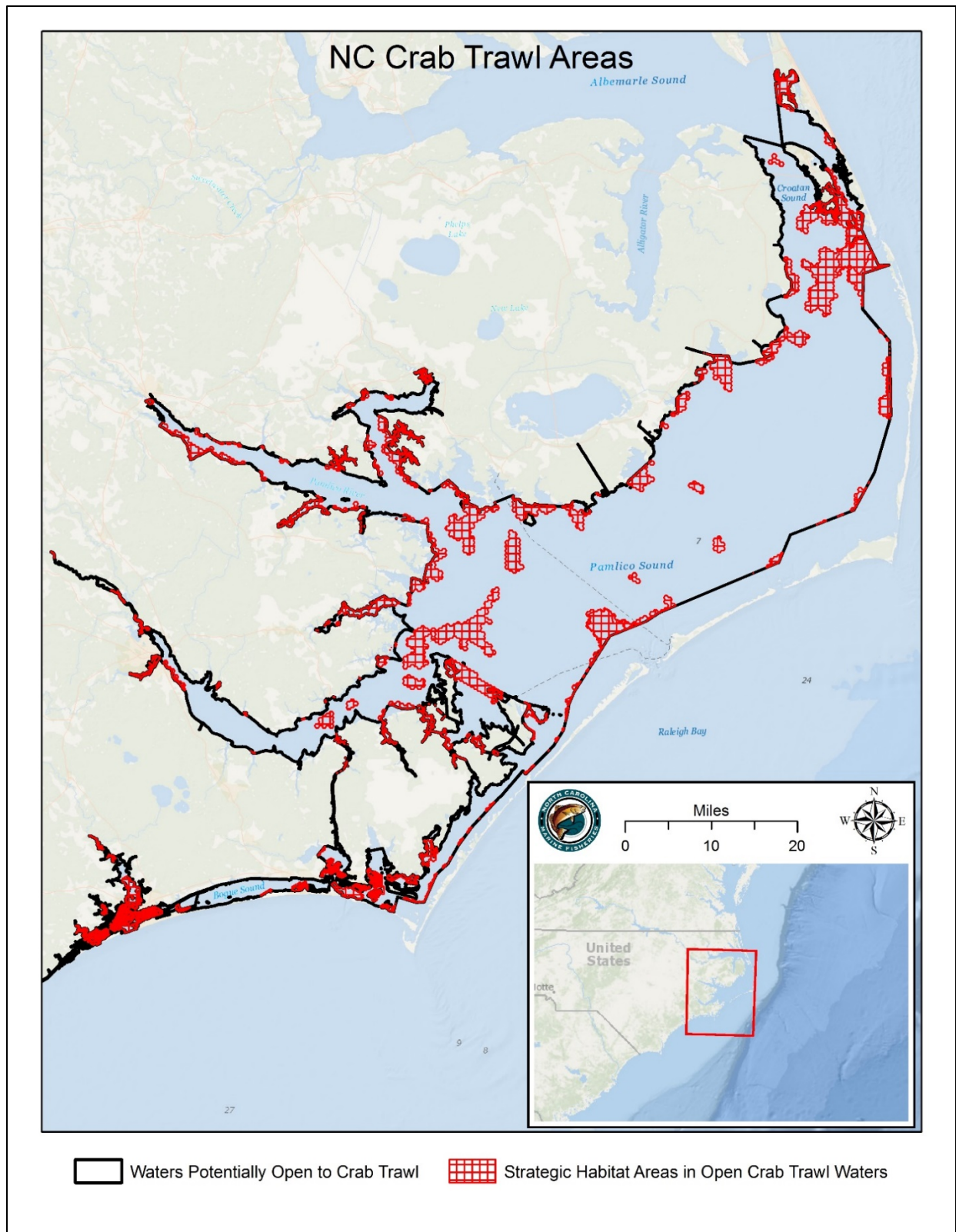


Figure 4.6.5. Current statewide crab trawl boundary lines (Bogue Sound North) with designated strategic habitat areas (SHA) shaded by region.

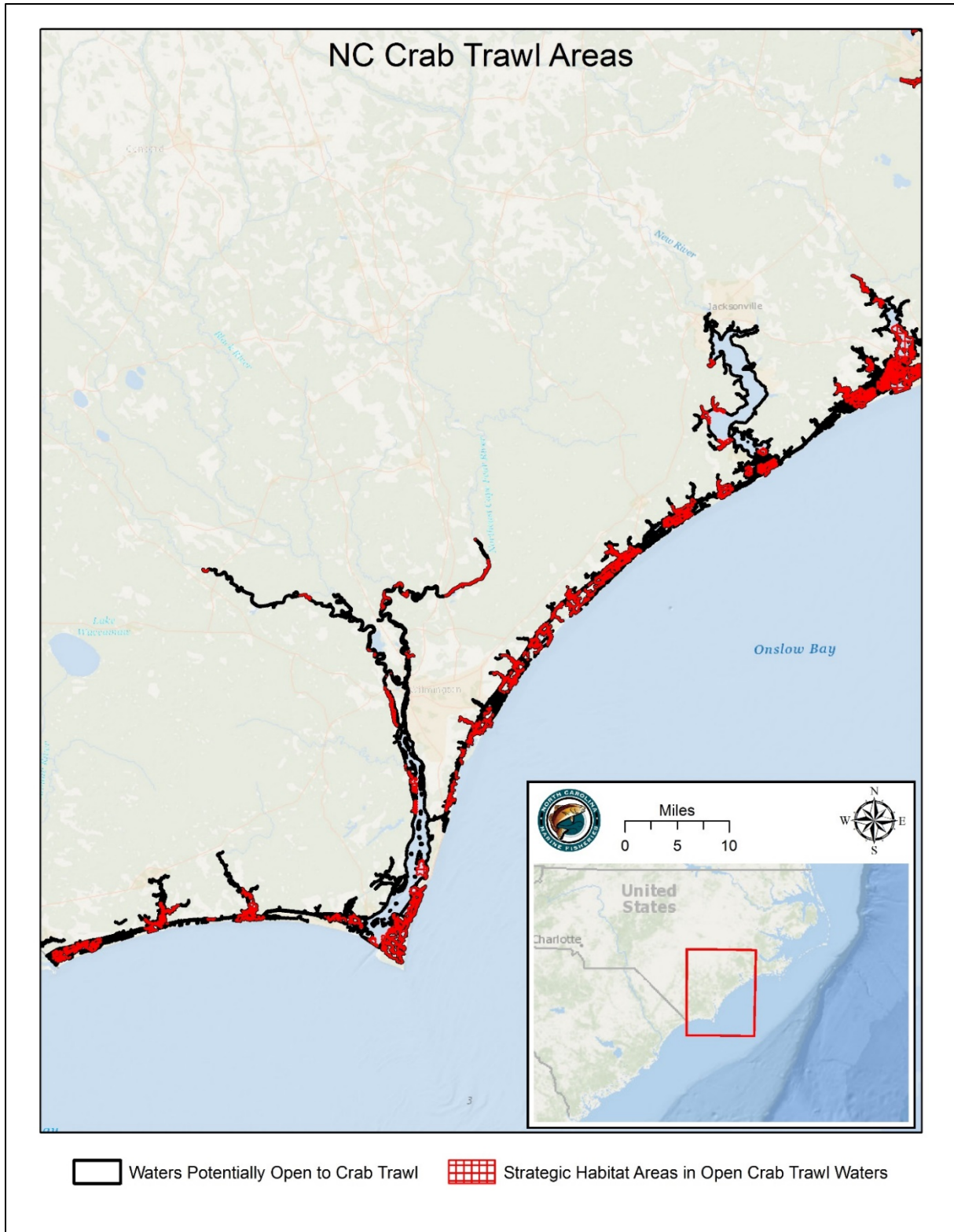


Figure 4.6.6. Current statewide crab trawl boundary lines (South of Bogue Sound) with designated strategic habitat areas (SHA) shaded by region.

VII. MANAGEMENT OPTIONS AND IMPACTS

(+ Potential positive impact of action)

(- Potential negative impact of action)

1. Limit the taking of crabs with dredges
 - a. Prohibit the taking of crabs with crab dredges
 - b. Prohibit taking of crabs as incidental bycatch during oyster dredging operations
 - c. Prohibit the taking of crabs with crab dredges and oyster dredges
 - d. Reduce the trip limit of crabs from oyster dredges to 10% of the total weight of the combined oyster and crab catch or 100 pounds, whichever is less
 - + Will reduce habitat damage to SAV, oyster reefs, and oyster sanctuaries in the crab dredge area
 - + May increase abundance of mature females helping to rebuild the spawning stock
 - + Will avoid additional impact to oyster rocks and soft bottom
 - + Will avoid unlawful targeting of blue crabs in the oyster dredge fishery
 - + Easier to enforce
 - Management change required
 - Could lead to some waste of crabs in the oyster fishery
 - Decreased harvest with economic loss to the fishery
2. Limit the use of crab trawls spatially
 - a. Prohibit the use of crab trawls in areas where shrimp trawls are already prohibited in the Neuse and Tar-Pamlico rivers (15A NCAC 3R .0114)
 - b. Prohibit the use of crab trawls coastwide
 - + Will reduce habitat damage to SHAs and other bottom habitat in crab trawl areas
 - + May increase abundance of mature females helping to rebuild the spawning stock
 - Decreased harvest with economic loss to the fishery
 - Some regions may be impacted more than others

VIII. RECOMMENDATION

NCMFC selected management strategy

- Option 1a: prohibit taking of crabs with crab dredges
- Option 1d: reduce the bycatch limit of crabs from oyster dredges to 10% of the total weight of the combined oyster and crab catch or 100 pounds, whichever is less
- Option 2a: prohibit use of crab trawls in areas where shrimp trawls are already prohibited in the Pamlico, Pungo, and Neuse rivers

IX. LITERATURE CITED

1. NCDEQ (North Carolina Department of Environmental Quality). 2016. North Carolina Coastal Habitat Protection Plan Source Document. Morehead City, NC. Division of Marine Fisheries. 475 p.

2. NCDMF. 2016. May 2016 Revision to Amendment 2 to the North Carolina Blue Crab Fishery Management Plan. North Carolina Department of Environmental Quality, Division of Marine Fisheries. Morehead City, NC. 53 p.
3. NCDMF. 2018. Stock assessment of the North Carolina blue crab (*Callinectes sapidus*), 1995–2016. North Carolina Division of Marine Fisheries, NCDMF SAP-SAR-2018-02, Morehead City, North Carolina. 144 p. NCDEQ (North Carolina Department of Environmental Quality). 2016. North Carolina Coastal Habitat Protection Plan Source Document. Morehead City, NC. Division of Marine Fisheries. 475 p.
4. MSC (Moratorium Steering Committee). 1996. Final report of the Moratorium Steering Committee to the Joint Legislative Commission of Seafood and Aquaculture of the North Carolina General Assembly. NC Sea Grant College Program. Raleigh, NC. NC-SG-96-11. 155 p.
5. NCDMF (North Carolina Division of Marine Fisheries). 1999. Shrimp and crab trawling in North Carolina's estuarine waters. Report to NC Marine Fisheries Commission. DENR, Morehead City, NC. 121p.
6. ASMFC (Atlantic States Marine Fisheries Commission). 2000. Evaluating fishing gear impacts to submerged aquatic vegetation and determining mitigation strategies. ASMFC Habitat Management Series #5. Washington D.C. 38 p.
7. Ipock, D., NCDMF. 2018 personal communication, A. Deaton

APPENDIX 4.7: SUMMARY OF ADVISORY COMMITTEE AND NCDMF
RECOMMENDATIONS FOR ISSUE PAPERS IN AMENDMENT 3

-This page intentionally left blank-

Table 25. Summary of the NCDMF, Blue Crab FMP and standing and regional AC, and Constant Contact online questionnaire recommendations for Amendment 3 to the Blue Crab FMP. Highlighted text denotes changes to the NCDMF and Blue Crab FMP AC recommendations since the last commission meeting in August 2019. **Bolded** items are measures currently in effect through the 2016 Revision to Amendment 2 of the Blue Crab FMP. *Only management options supported by more than 50% of respondents were included for the Constant Contact online questionnaire.

Issue	NCDMF	Blue Crab FMP AC	Northern Regional AC	Southern Regional AC	Shellfish/Crustacean AC	Habitat and Water Quality AC	Constant Contact Questionnaire*
Sustainable Harvest	Minimum harvest reduction of 2.2% (50% probability of success). The division encourages the commission to consider a reduction of at least 5.9% (90% probability of success) and to include: 1) prohibit immature female hard crab harvest , 2) 5-inch minimum size limit for mature females, and 3) a continuous closure period that results in a reduction of at least 4.6% to make up the remainder of the preferred reduction	Option 18.3: 1) North of the Highway 58 Bridge: January 1 through January 31 closed season, 6.75" mature female hard crab maximum size limit, and prohibit immature female hard crab harvest and 2) South of the Highway 58 Bridge: March 1 through March 15 closed season and prohibit immature female hard crab harvest (3.2% harvest reduction; 50% probability of success)	Support Blue Crab AC recommendation	Recommend Dec.-Jan. closure North of Hwy 58 Bridge and a Jan. closure South of Hwy 58 Bridge; 5-inch mature female minimum size limit; prohibit harvest of immature female hard crabs (4.3% harvest reduction; 67% probability of success)	Recommend tabling FMP process until the stock assessment is updated with data through 2019 to see the effects of the 2016 regulations	No position	Mature female size limit (67%)
	Recommended closure period will replace current pot closure period and will remain closed for the entire period	Recommended season closure will replace current pot closure period and will remain closed for the entire time period	Support NCDMF recommendation for adaptive management framework	Maintain 5% cull tolerance	Support consideration of habitat as part of the overall strategy for management of the blue crab fishery		Limit harvest of immature female hard crabs (67%)
	Maintain 5% cull tolerance established in 2016 Revision	Maintain 5% cull tolerance established in 2016 Revision		Leave adaptive management decision to MFC			
	Adopt proposed adaptive management framework which was updated to allow management measures to possibly be relaxed if the assessment update shows the stock is not overfished and overfishing is not occurring	Adopt proposed adaptive management framework and allow measures to be relaxed is assessment update says stock is not overfished and overfishing is not occurring					
		Recommend updating the stock assessment once 2019 data is available					

Issue	NCDMF	Blue Crab FMP AC	Northern Regional AC	Southern Regional AC	Shellfish/Crustacean AC	Habitat and Water Quality AC	Constant Contact Questionnaire*
Qualitative Management	Option 2a: increase number of cull rings in pots to 3	Leave in existing rules put in in 2016 and do not adopt anything else at this time, except with 2 options on cull rings: 1) 2 cull rings in proper corner placement or 2) keeping the 3 cull rings with 1 in proper placement	Support Blue Crab AC recommendation	Support Blue Crab AC recommendation regarding number and placement of cull rings	No position	No position	Limit the harvest of sponge crabs (100%)
	Option 3b: two cull rings placed within one full mesh of corner and the apron on opposite outside panels in the upper chamber			Support NCDMF recommendation for option 4c (remove cull ring exemptions)			Minimum size limit for soft and peeler crabs (61%)
	Option 4c: remove cull ring exemptions for Newport River and eastern Pamlico Sound and prohibit designation of exempt areas in future				Support option 7a (prohibit dark sponge crab harvest during month of April)		Impose a limit on the number of crab pots fished (61%)
	Option 7c: prohibit harvest of sponge crabs year-round						
	Option 8a: establish 3” minimum size limit for peeler and soft crabs						
Water Quality	Support all management options presented	Support all management options in this paper	Support Blue Crab AC recommendation	Support NCDMF and Blue Crab AC recommendations	No position	Recommend accepting the water quality recommendation from the Blue Crab AC and adding the Habitat and Water Quality AC to the reporting groups	Support recommendations to address water quality concerns (89%)
	Recommend Option 4 as the highest priority	Support making the highest priority option four tasking the CHPP steering committee to what is suggested here and follow up with each of the other recommendations as that step is justified					

Spawning Sanctuaries

Issue	NCDMF	Blue Crab FMP AC	Northern Regional AC	Southern Regional AC	Shellfish/Crustacean AC	Habitat and Water Quality AC	Constant Contact Questionnaire*
	Division habitat staff shall regularly report back to the Habitat and Water Quality and the Shellfish/Crustacean ACs with progress on each management option	Have the habitat staff report back to the Shellfish/Crustacean AC with progress					
	Expand boundaries as presented for Oregon, Hatteras, Ocracoke, and Barden inlets	Keep Oregon, Hatteras, and Ocracoke the same and change Drum and Barden to proposed boundaries	Split consensus on whether to expand or keep boundaries for existing spawning sanctuaries	Support Blue Crab AC recommendations	No position	Recommend keeping Oregon, Hatteras, and Ocracoke spawning sanctuary boundaries the same	Establish new crab spawning sanctuaries at all inlets without a crab spawning sanctuary (61%)
	Move boundary for Drum Inlet crab spawning sanctuary as presented	Add spawning sanctuaries from Beaufort through Tubbs inlets using AC recommended boundaries with a closure period of March 1 through Oct. 31 with same restrictions as existing sanctuaries	Support NCDMF and Blue Crab AC recommendation to move Drum Inlet spawning sanctuary			Support NCDMF and Blue Crab AC recommendation to move Drum Inlet spawning sanctuary	Establish a crab spawning sanctuary to serve as a migration corridor in Croatan Sound (56%)
	Concur with AC recommendations for Beaufort, Bogue, Bear, Browns, New River, Topsail, Rich, Mason, Masonboro, Carolina Beach, Shallotte, Lockwood Folly, and Tubbs inlets		Support Blue Crab AC recommendation for southern spawning sanctuary boundaries (excluding Cape Fear River)			Support Blue Crab AC recommendation for southern spawning sanctuary boundaries (excluding Cape Fear River)	
	Use NCDMF recommended boundary for Cape Fear River Inlet crab spawning sanctuary		Support NCDMF recommended boundary for Cape Fear River spawning sanctuary			Support NCDMF recommended boundary for Cape Fear River spawning sanctuary	
	Concur with AC recommendation of a March 1 through October 31 closure for Beaufort Inlet through Tubbs Inlet sanctuaries with same restrictions as existing crab spawning sanctuaries		Recommend March 1 - Oct. 31 closure for spawning sanctuaries south of the Hwy 58 Bridge (Bogue through Tubbs inlets). Beaufort Inlet would have same closure period as existing spawning sanctuaries (March 1 - Aug. 31)			Recommend March 1 - Oct. 31 closure for spawning sanctuaries south of the Hwy 58 Bridge (Bogue through Tubbs inlets). Beaufort Inlet would have same closure period as existing spawning sanctuaries (March 1 - Aug. 31)	

Issue	NCDMF	Blue Crab FMP AC	Northern Regional AC	Southern Regional AC	Shellfish/Crustacean AC	Habitat and Water Quality AC	Constant Contact Questionnaire*
	Establish a crab spawning sanctuary to serve as a migration corridor on the east side of Croatan Sound, as presented and in conjunction with expanding the Oregon Inlet spawning sanctuary, closed to blue crab harvest from May 16 through July 15 and with the same restrictions as existing sanctuaries		Do not support a spawning sanctuary (migration corridor) in Croatan Sound			Do not support a spawning sanctuary (migration corridor) in Croatan Sound	
Diamondback Terrapin	Use the criteria as outlined in this paper for the establishment of Diamondback Terrapin Management Areas (DTMAs)	Use science on locally specific pot funnel design to reduce terrapins and identify individual creeks with terrapin population hot spots that would be closed to potting	Support NCDMF recommendation	Support NCDMF recommendation	No position	No position	Support criteria for designating Diamondback Terrapin Management Areas (59%)
Bottom Disturbing Gear	Option 1a: prohibit taking of crabs with crab dredges	Not adopt any of the recommended management options on crab dredge and leave crab trawl lines as is	Support NCDMF recommendation Option 1a (prohibit taking of crabs with crab dredges)	Support Blue Crab AC recommendation	No position	Recommend accepting NCDMF recommendation 1a	Prohibit taking of crabs with crab dredges and oyster dredges (67%)
	Option 1d: reduce the bycatch limit from oyster dredges to 10% of the total weight of the combined oyster and crab catch or 100 pounds, whichever is less		Do not support reducing bycatch limits in oyster dredges until landings are examined			Recommend accepting NCDMF recommendation 1d	Reduce the bycatch limit of crabs from oyster dredges to 10% of the total weight of the combined oyster and crab catch or 100 pounds, whichever is less (78%)

Issue	NCDMF	Blue Crab FMP AC	Northern Regional AC	Southern Regional AC	Shellfish/Crustacean AC	Habitat and Water Quality AC	Constant Contact Questionnaire*
	Option 2a: prohibit use of crab trawls in areas where shrimp trawls are already prohibited in the Pamlico, Pungo, and Neuse rivers		Split consensus on support of NCDMF recommendation Option 2a (prohibit use of crab trawls above shrimp trawl lines in Pamlico, Pungo, and Neuse rivers)			Do not recommend accepting NCDMF recommendation 2a	Prohibit use of crab trawls coastwide (53%)



ROY COOPER
Governor

MICHAEL S. REGAN
Secretary

STEPHEN W. MURPHEY
Director

January 31, 2020

MEMORANDUM

TO: N.C. Marine Fisheries Commission

FROM: Michael S. Loeffler and Anne L. Markwith, Southern Flounder Fishery Management Plan Co-Leads

SUBJECT: Southern Flounder Fishery Management Plan Amendment 3

Issue

Review the draft goal and objectives for Amendment 3 to the Southern Flounder Fishery Management Plan (FMP) and discuss the potential management strategies to be considered during its development.

Actions Needed

- I. Vote on approval of the Southern Flounder FMP Amendment 3 Goal and Objectives
- II. Discuss and provide input on the potential management strategies to be considered during development of Amendment 3.

I. Goal and Objectives

As prescribed by the recently adopted Southern Flounder FMP Amendment 2, the division is now proceeding with development of Amendment 3 to implement more comprehensive, long-term management measures. Amendment 3 is based on the 2019 coast-wide stock assessment update that indicated the stock is overfished and overfishing is occurring. The next step in the FMP process is for the Marine Fisheries Commission (MFC) to vote on adoption of the goal and objectives. The division is continuing to develop the first draft of Amendment 3. Then the Southern Flounder FMP Advisory Committee will assist the division with development of Amendment 3, resulting in a second draft that will be brought to the MFC for its consideration. The draft goal and objectives are:

Goal:

Manage the southern flounder fishery to achieve a self-sustaining population that provides sustainable harvest using science-based decision-making processes. The following objectives will be used to achieve this goal.

Objectives:

- Implement management strategies within North Carolina and encourage interjurisdictional management strategies that maintain/restore the southern flounder spawning stock with expansion of the age structure of the stock and adequate abundance to prevent overfishing.
- Restore, enhance, and protect habitat and environmental quality necessary to maintain or increase growth, survival, and reproduction of the southern flounder population.
- Use biological, environmental, habitat, fishery, social, and economic data needed to effectively monitor and manage the southern flounder fishery and its ecosystem impacts.

Objectives continued:

- Promote stewardship of the resource through increased public outreach and interjurisdictional cooperation throughout the species range regarding the status and management of the southern flounder fishery, including practices that minimize bycatch and discard mortality.
- Promote the restoration, enhancement, and protection of habitat and environmental quality in a manner consistent with the Coastal Habitat Protection Plan.

II. Potential Management Strategies

Based on the draft goal and objectives that the MFC will vote on at its February meeting, the division identified potential management strategies for the southern flounder fishery. The division held a scoping period, discussed below, to solicit public input about these management strategies and any additional strategies suggested by the public. The division is now seeking input from the commission on the potential management strategies to be considered during development of Amendment 3.

Potential Southern Flounder FMP Amendment 3 Management Strategies

Sustainable Harvest	Species Specific Management	Inlet Corridors
<ul style="list-style-type: none">• Quotas with accountability measures• Seasons• Trip limits• Changes to bag limit• Changes to size limit• Gear modification• Development of fishing days	<ul style="list-style-type: none">• Separating management of southern flounder, summer flounder and Gulf flounder for recreational fishery• Simplified species management through ocellated vs. non-ocellated flounder	<ul style="list-style-type: none">• Designating inlet or corridor areas to protect mature female southern flounder during fall migration into the ocean.

Further explanation of these potential management strategies, as well as the proposed timeline for Amendment 3, can be found in the Amendment 3 Scoping Document.

[Southern Flounder Fishery Management Plan Amendment 3 Scoping Document](#)

Scoping Period

In support of the recent changes to the FMP process, the division held its public scoping period for Amendment 3 from Dec. 4 through Dec. 18, 2019. In addition to accepting comments through an online questionnaire and U.S. mail, the division held three in-person meetings in Morehead City, Wilmington, and Manteo. The division received 36 comments from attendees during the meetings, 241 online comments, and nine comments through U.S. mail. Comments were primarily focused on one or more of the potential management measures under the sustainable harvest management strategy. No potential additional management strategies were identified other than a single comment in support of stocking to augment the current southern flounder population with stocking from hatchery fish.

Scoping Document



Management Strategies for Amendment 3 to the Southern Flounder Fishery Management Plan



December 2019



Can't attend but want to submit comments? Here's how!

Written comments can be submitted by online form or by U.S. mail. Comments sent by U.S. mail must be postmarked by Dec. 18, 2019 to be accepted. The division will not accept public comment through email.

To comment by online form:

The online form can be accessed through the Southern Flounder Amendment Information Page (<http://portal.ncdenr.org/web/mf/southern-flounder-topic>). Please use the link at the bottom of the information page.

To comment by U.S. mail, please submit written comments to:

N.C. Division of Marine Fisheries
Southern Flounder FMP Amendment 3
Scoping Comments
P.O. Box 769
Morehead City, NC 28557

The N.C. Division of Marine Fisheries seeks your input on management strategies for the Southern Flounder Fishery Management Plan.

A scoping period for public comment begins Dec. 4, 2019 and ends Dec. 18, 2019.

Comments must be received/postmarked by 5 p.m. (EST) on Dec. 18, 2019.

Scoping Meetings

DMF staff will provide information about Amendment 3 to the Southern Flounder Fishery Management Plan (FMP) and will be available for questions from the public. A public comment period will follow.

Monday, Dec. 9, 2019 at 6 p.m. to 8 p.m.

Central District Office
5285 Highway 70 West
Morehead City, NC 28557

Wednesday, Dec. 11, 2019 at 6 p.m. to 8 p.m.

N.C. Department of Environmental Quality
Wilmington Regional Office
127 Cardinal Drive Extension
Wilmington, NC 28405

Tuesday, Dec. 17, 2019 at 6 p.m. to 8 p.m.

Dare County Government Complex, Commissioners Room
954 Marshall C. Collins Drive
Manteo, NC 27954

Questions about the southern flounder stock, fishery, or Amendment 3 to the Southern Flounder Fishery Management Plan?



Contact the leads:

Michael S. Loeffler

Fisheries Biologist, Elizabeth City

Southern flounder lead

252-264-3911

Anne Markwith

Fisheries Biologist, Wilmington

Southern flounder co-lead

910-796-7292

Questions about the FMP Process?

Kathy Rawls

Fisheries Management Section Chief, Morehead City

252-808-8074

Catherine Blum

Fisheries Management Plan and Rulemaking Coordinator, Morehead City

252-808-8014

Purpose of the Scoping Document

The purpose of this document is to inform the public the review of the Southern Flounder FMP is underway and to provide an opportunity for the public to comment on identified management strategies or identify other relevant strategies in the management of the southern flounder fishery. Input received at the start of the FMP review process may shape the final amendment and its management measures (solutions). To help focus the input received from the public, this document provides an overview of initially identified strategies, as well as background information on the fishery such as the status of the stock. A series of questions about each strategy is also provided for the public to consider when thinking about the strategies; in general: **“What should southern flounder management be? What changes are needed?”**

Additional management strategies may be considered in Amendment 3 dependent on statutory requirements, available data, research needs, and the degree of impact the management strategy would have and how effective the solution would be. If the division determines a management strategy raised during the scoping period might have significant impacts on the species, additional examination of the strategy may be undertaken in the development of the FMP.

Scoping provides an opportunity for the public to comment on strategies identified by the division as well as any additional relevant strategies for possible consideration for the development of the FMP.

What is Scoping?

Scoping is the first stage of the process to determine the appropriate contents of an FMP after a plan has been opened for review. Scoping serves many purposes including: (1) to provide notice to the public that a formal review of the FMP is underway by the N.C. Division of Marine Fisheries (DMF or division), (2) inform the public of the stock status of the species (if available), (3) solicit public input on a list of strategies identified by the DMF or identify other relevant strategies that may need to be addressed, and (4) recruit potential advisors to serve on the advisory committee (AC) for the FMP that is appointed by the N.C. Marine Fisheries Commission (MFC). You will have more opportunity to provide comments as the amendment is developed; however, scoping is the first and best opportunity to make suggestions for DMF to consider before an amendment is developed.

FISHERY MANAGEMENT PLANS- A TIERED APPROACH

Fishery Management



Management PLANS are implemented to achieve specified management goals for a fishery, such as sustainable harvest, and include background information, data analyses, fishery habitat and water quality considerations consistent with Coastal Habitat Protection Plans, research recommendations, and management strategies.

Management STRATEGIES are adopted to help reach the goal and objectives of the plan. They are the sum of all the management measures selected to achieve the biological, ecological, economic, and social objectives of the fishery.

Management MEASURES are the actions implemented to help control the fishery as stipulated in the management strategies.

FMP Timeline

Process Step	Date
Public scoping meetings	December 2019
DMF prepares draft Amendment 3	January – June 2020
FMP AC and DMF work together to further develop Amendment 3	June – September 2020
DMF selects initial management recommendations	October 2020
MFC votes to send draft FMP for public and AC review	November 2020
Public comment and AC meetings for review of draft Amendment 3	December 2020 – January 2021
MFC selects preferred management options	February 2021
NC DEQ Secretary and legislature review draft FMP	March – April 2021
MFC votes on final adoption of Amendment 3	May 2021

Developing an amendment

Annually, the DMF reviews all species for which there are FMPs for North Carolina and provides an update to the MFC. This review includes any recommended changes to the schedule for FMP review and amendment development. Per N.C. law, any changes to the schedule must be approved by the N.C. Department of Environmental Quality (NC DEQ) Secretary.

When a plan is opened for review, the first step of the formal amendment process is a scoping period. After relevant strategies have been identified by the DMF, the public (during the scoping period), and by the MFC, the division's plan development team (PDT) develops a preliminary draft amendment. The first draft will be completed before the FMP AC is appointed. Once appointed, the AC will meet with the PDT at a series of workshops. The purpose of these workshops is for the AC to assist the PDT and to work together to discuss the strategies and to further develop and refine the appropriate contents of the draft amendment and the management strategies it contains.

Upon completion of this draft, the amendment is taken to the MFC for approval to go out for public comment and review by the MFC's standing and regional ACs. Following consideration of public and AC comment, the Commission selects its preferred management options for Amendment 3. Next, draft Amendment 3 goes to the NC DEQ Secretary and the legislature for review before the MFC votes on final approval of the amendment.

Why is this happening now?

The DMF is proceeding with Amendment 3 to the FMP based on the 2019 coast-wide stock assessment update (containing data through 2017) for southern flounder that indicated the stock is overfished and overfishing is occurring. The division and the MFC are required under state law to end overfishing in two years and rebuild the spawning stock biomass to a level of sustainable harvest in 10 years. In August 2019, the MFC voted on final approval of Amendment 2 to the FMP. Amendment 2 contained short-term management measures (seasons) that meets the statutory timeframe; however, the approval of Amendment 2 specified the development of Amendment 3 to begin immediately to implement more comprehensive, long-term management measures to achieve sustainable harvest.

Amendment 3 Background

Coast-wide stock assessment and stock status

A coast-wide stock assessment was conducted on southern flounder in south Atlantic waters (North Carolina, South Carolina, Georgia, and the east coast of Florida) in 2018 and updated in 2019 with data through 2017 (Lee et al. 2018; Flowers et al. 2019). The stock assessment's current (2017) estimates of female spawning stock biomass (SSB) and fishing mortality indicate that the stock is overfished and overfishing is occurring (Figures 1 and 2).

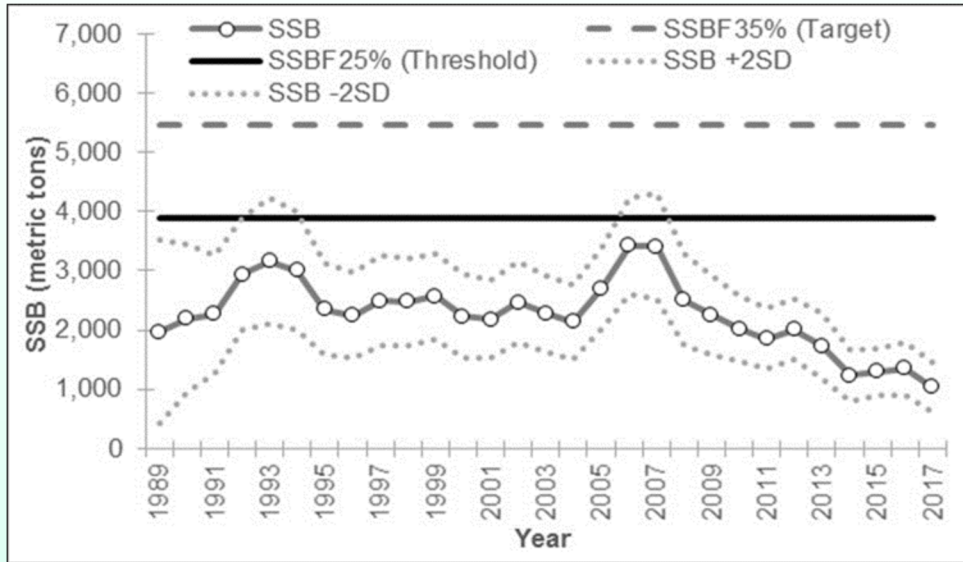
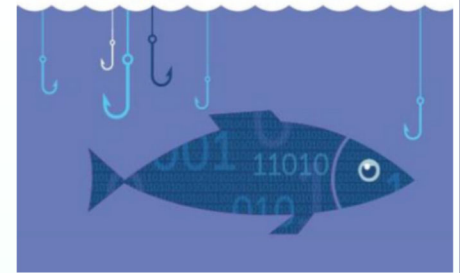


Figure 1. Estimated spawning stock biomass compared to established reference points, 1989–2017. (Source: Flowers et al. 2019).

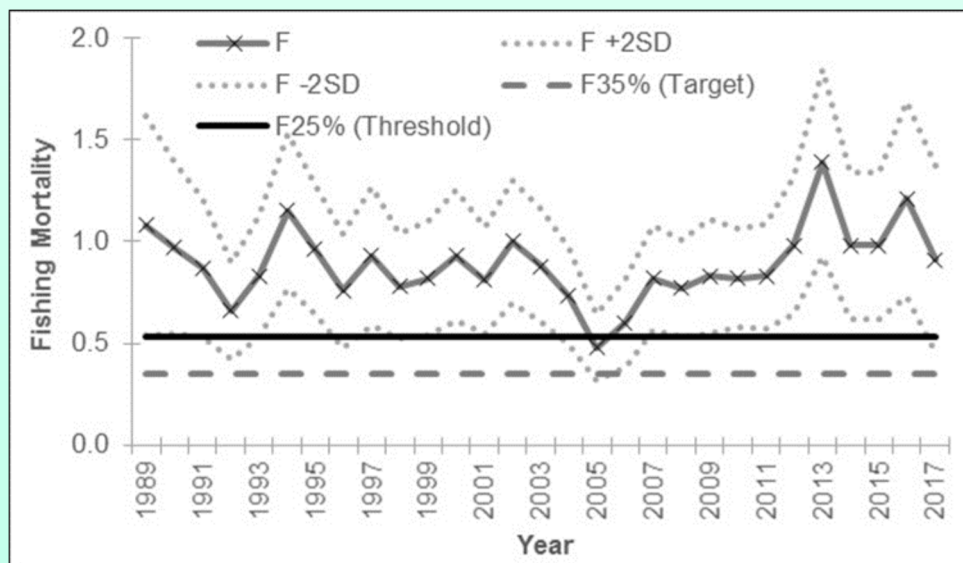


Figure 2. Estimated fishing mortality rates (numbers-weighted, ages 2–4) compared to established reference points, 1989–2017. (Source: Flowers et al. 2019).

A minimum 52% reduction in total removals is needed to rebuild the female spawning stock biomass to sustainable levels and end the overfished status within 10 years. Management in Amendment 2 called for a 62% reduction in 2019 and 72% reduction beginning in 2020 until Amendment 3 is passed. It is important to note that management measures in Amendment 3 will be based on the 2019 stock assessment, meaning a minimum of 52% reduction in total removals starting in 2021 is still needed to rebuild the spawning stock population within 10 years.



Southern flounder in North Carolina

Southern flounder supports one of the largest and most valuable commercial fisheries in North Carolina. Pound nets, gill nets, and gigs have accounted for 98% of commercial southern flounder landings in North Carolina for the last 10 years. North Carolina’s total commercial removals (landings and dead discards; in pounds) are equivalent to approximately 38.3% of the coast-wide removals of southern flounder for the last 10 years (Figure 3). In 2017, southern flounder commercial landings including dead discards, accounted for 71.8% of North Carolina’s removals (Figure 4).

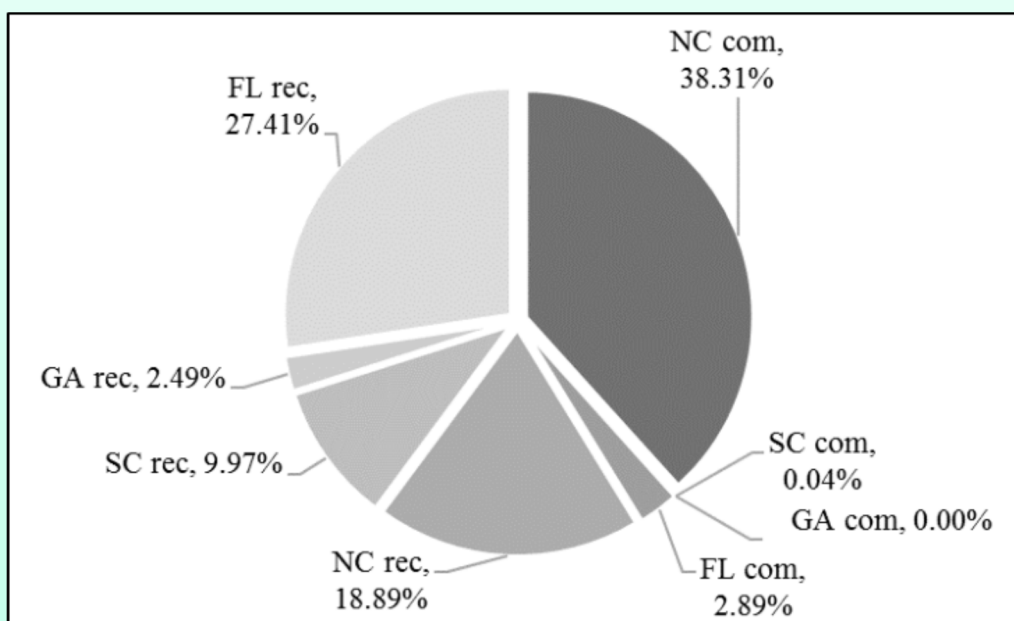


Figure 3. Average contribution to U.S. South Atlantic coast southern flounder commercial and recreational removals (observed harvest and dead discards) in pounds by state, 2008-2017. (Source: NOAA Fisheries Annual Commercial Landing Statistics, North Carolina Trip Ticket Program and the Marine Recreational Information Program).

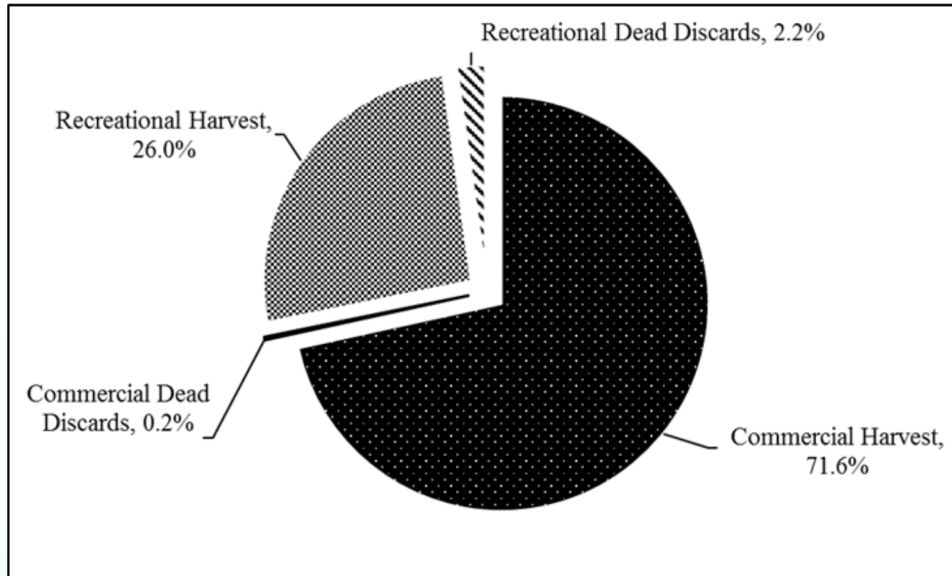


Figure 4. Breakdown of the total removals (observed harvest and dead discards) in % of pounds for the commercial and recreational (hook-and-line and gig) fisheries in North Carolina, 2017. (Source: North Carolina Trip Ticket Program and Marine Recreational Information Program).

Southern flounder, or flounder species in general, are one of the most sought-after recreational species in North Carolina. Southern flounder are taken by recreational fishers using hook-and-line, gigs, and through the recreational use of commercial gears such as gill nets. For the last 10 years (2008-2017), North Carolina’s total recreational removals (in pounds) are equivalent to approximately 19% of the total coast-wide removals (Figure 3). Recreational removals, including dead discards, accounted for 28.2% of all of North Carolina’s removals in 2017 (Figure 4).

The recreational harvest of southern flounder exhibits a distinct seasonality concentrated between May and October, whereas commercial harvest is concentrated between September and November. These harvest peaks helped to determine when to implement seasons in Amendment 2 for achieving the required reductions.



Amendment 3 Management Strategies

Statutorily Required Management Strategy: Sustainable Harvest

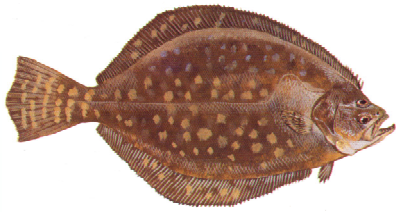
Background

The division and the MFC are required under state law to end overfishing in two years and rebuild the spawning stock biomass to a level of sustainable harvest in 10 years. Projections based on the stock assessment indicate that a minimum of a 52% reduction in coast-wide removals (harvest and dead discards) is needed to rebuild the spawning stock of southern flounder. The implementation of management measures (seasons) put into place with Amendment 2 to the FMP were deemed critical for rebuilding of the stock; these measures ensured that harvest reductions were not delayed while more comprehensive long-term management measures could be developed. Several management strategies could be introduced or redefined for achieving sustainable harvest, including:

- Management through a quota for both the commercial and recreational fisheries
- Setting accountability measures for both sectors (for example, paybacks)
- Trip limits
- Bag limit changes
- Changes in size limit, including changes to the minimum or maximum size or slot limits
- Development of fishing days (weekday vs. weekend) to allow for access to the fishery for a longer period of time
- Gear modifications as required by management actions above

Questions for the Public

- Do you support use of a quota instead of seasons? If so, how would you like to see a quota managed?
 - ◇ In the commercial fishery, how should the quota be allocated (by area, gear, both)?
 - ◇ Should the for-hire sector have their own quota outside of the general recreational quota?
- What options should be considered if there are overages for either sector?
- Should trip limits be implemented for the commercial sector?
 - ◇ Should trip limits be for all gears (gig, gill net, and pound nets)? Or just specific gears?
 - ◇ Should they be used more as an adaptive management tool (i.e., when a certain portion of the quota is caught trip limits would go into place)?
- Should DMF implement bag limit changes for the recreational fishery to help reduce harvest?
- Do you support changes to size limits? For which sector?
 - ◇ How do you support changing them? Increase the maximum size, decrease the minimum size, have a slot limit? What size would you support?
- Should allowable harvest days be consecutive? Or only selected days during the week (and which days)?



Additional Management Strategies

Increased Recreational Access by Managing Southern Flounder Separately from other Flounder Species

Background

In North Carolina, the recreational flounder fishery is managed as an aggregate fishery of the three main species of flounder (southern, summer, and Gulf). As a result, when the southern flounder recreational fishery is closed it is unlawful to harvest the other two species. In particular, the closure of the recreational ocean fishery (where summer and Gulf flounder are most likely to be caught) has been brought up as an unintended consequence of this aggregate management. Based on Marine Recreational Information Program (MRIP) data, approximately 50% of the recreational harvest from the ocean are flounder species other than southern flounder. As a result, unless some form of species-specific management is considered and recreational anglers are willing to learn how to identify the different species, recreational access to the other species of flounder will not be possible.

Questions for the Public

- Should flounder management measures apply independently for each of the three species (southern, summer and Gulf flounder)?
- Should it be simplified to ocellated (summer and Gulf flounder) and non-ocellated (southern flounder) flounders?
- What type of outreach would you recommend to educate anglers on species identification?
- Should the bag limit allow only a certain amount of southern flounder to be kept? If so, what amount do you recommend (e.g., 1 southern and 3 summer or Gulf flounders; 2 southern and 2 summer or Gulf flounders)?

Inlet Corridors

Background

Designation of inlet corridors would offer protections to mature female southern flounder during their migration through coastal inlets. A similar management strategy was adopted for the blue crab fishery in the Virginia waters of the Chesapeake Bay, was highly effective, and is being considered in Amendment 3 to the North Carolina Blue Crab Fishery Management Plan.

Questions for the Public

- Do you support creating protected areas to protect southern flounder migrating through coastal inlets?
- If you support creating corridors, what inlets would you consider?
- If you support protecting corridors, what distance from an individual inlet should be considered?
- If you support creating corridors, are there areas inside the estuaries that lead to inlets that should be considered)?





Questions for the Public about Potential Management Strategies



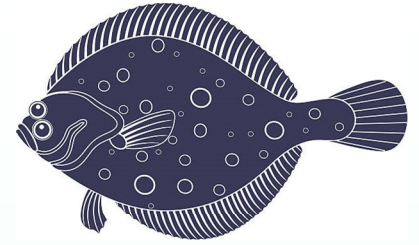
1. What management strategies already under consideration do you support for long-term management?
2. Are there other relevant strategies not included here that the Division should consider for Amendment 3?

Additional management strategies may be considered in Amendment 3 dependent on statutory requirements, available data, research needs, and the degree of impact the management strategy would have and how effective the solution would be. If the division determines a management strategy raised during the scoping period might have significant impacts on the species, additional examination of the strategy may be undertaken in the development of the FMP.



Literature Cited

Flowers, A.M., S.D. Allen, A.L. Markwith, and L.M. Lee (editors). 2019. Stock assessment of southern flounder (*Paralichthys lethostigma*) in the South Atlantic, 1989–2017. Joint report of the North Carolina Division of Marine Fisheries, South Carolina Department of Natural Resources, Georgia Coastal Resources Division, Florida Fish and Wildlife Research Institute, University of North Carolina at Wilmington, and Louisiana State University. NCDMF SAP-SAR-2019-01. 213 p.



Funderburk, S.L., S.J. Jordan, J.A. Mihursky, and D. Riley (eds.). 1991. Habitat requirements for Chesapeake Bay living resources. Second edition. Chesapeake Bay Estuary Program, U.S. Fish and Wildlife Service, Annapolis, MD.

Lee, L.M., S.D. Allen, A.M. Flowers, and Y. Li (editors). 2018. Stock assessment of southern flounder (*Paralichthys lethostigma*) in the South Atlantic, 1989–2015. Joint report of the North Carolina Division of Marine Fisheries, South Carolina Department of Natural Resources, Georgia Coastal Resources Division, Florida Fish and Wildlife Research Institute, University of North Carolina at Wilmington, and Louisiana State University. NCDMF SAP-SAR-2018-01. 425 p.

Grimes, C. B. 1998. Marine stock enhancement: sound management of techno-arrogance. *Fisheries* 23:18-23.

NCDEQ (North Carolina Department of Environmental Quality). 2016. North Carolina Coastal Habitat Protection Plan Source Document. Morehead City, NC. Division of Marine Fisheries. 475 p.

NCDMF (North Carolina Division of Marine Fisheries). 2005. North Carolina fishery management plan southern flounder (*Paralichthys lethostigma*). North Carolina Department of Environment and Natural Resources, Division of Marine Fisheries, Morehead City, North Carolina. 359 p.

NCDMF. 2013. North Carolina southern flounder (*Paralichthys lethostigma*) fishery management plan: Amendment 1. North Carolina Division of Marine Fisheries, Morehead City, North Carolina. 380 p.



NCDMF. 2018. Southern Flounder *in* 2017 Fishery Management Plan Review. North Carolina Division of Marine Fisheries, Morehead City, North Carolina. 590 p.

NCDMF. 2019a. Southern Flounder *in* 2018 Fishery Management Plan Review. North Carolina Division of Marine Fisheries, Morehead City, North Carolina. 730 p.

NCDMF. 2019b. North Carolina Southern Flounder (*Paralichthys lethostigma*) Fishery Management Plan Amendment 2. North Carolina Division of Marine Fisheries, Morehead City, North Carolina. 64 p.

Literature Cited

North Carolina Division of Water Quality (NCDWQ). 2000. A citizen's guide to water quality management in North Carolina. North Carolina Division of Environmental and Natural Resources. Division of Water Quality, Planning Branch, Raleigh, NC 156 p.

Rochman, C.M., 2015. The complex mixture, fate and toxicity of chemicals associated with plastic debris in the marine environment. In Marine anthropogenic litter 117-140pp. Springer, Cham.

Weis J.S. and P. Weis. 1989. Effects of environmental pollutants on early fish development. Aquatic Sciences. 1(1):45-55.

Wilbur, A. R. and M.W. Pentony. 1999. Human-induced nonfishing threats to essential fish habitat in the New England region. p. 299-321 in L.R. Benaka (ed.). Fish Habitat: Essential Fish Habitat and Rehabilitation. American Fishery Society, Silver Springs, MD, Symposium 22, 459 p.



Scoping Document

Management Strategies for Amendment 3 to the Southern Flounder Fishery Management Plan

NORTH CAROLINA DIVISION OF MARINE FISHERIES

DMF Headquarters
3441 Arendell Street
PO Box 769
Morehead City, NC 28557

800-682-2632
252-726-7021

<http://portal.ncdenr.org/web/mf/home>



North Carolina
Southern Flounder (*Paralichthys lethostigma*)
Fishery Management Plan
Amendment 2

By
North Carolina Division of Marine Fisheries

North Carolina Department of Environmental Quality
Division of Marine Fisheries
3441 Arendell Street
Post Office Box 769
Morehead City, NC 28557
September 2019

Amendment 2 to the N.C. Southern Flounder Fishery Management Plan

Achieving Sustainable Harvest

Sept. 23, 2019

I. ISSUE

The issue is to implement management measures to achieve sustainable harvest in the southern flounder fishery to end overfishing by 2021 and rebuild the spawning stock by 2028.

II. ORIGINATION

North Carolina Division of Marine Fisheries (NCDMF)

The N.C. Fishery Management Plan Review Schedule, as approved by the North Carolina Marine Fisheries Commission (NCMFC) at its August 2018 meeting, shows the review of the Southern Flounder Fishery Management Plan (FMP) is underway. As part of the review, a coast-wide stock assessment determined the stock is overfished and overfishing is occurring (Lee et al. 2018; Flowers et al. 2019). The NCDMF is proceeding with an amendment to the FMP to meet the statutory requirements to specify a time period not to exceed two years from the date of adoption of the amendment to end overfishing and a time period not to exceed 10 years from the date of adoption of the amendment for achieving a sustainable harvest.

III. BACKGROUND

Southern flounder supports one of the largest and most valuable commercial fisheries in North Carolina, accounting for landings of 1.39 million pounds with a dockside value of \$5.66 million in 2017. Pound nets, gill nets, and gigs have accounted for 98% of commercial southern flounder landings in North Carolina for the last 10 years (Figure 1). Historically, North Carolina has accounted for approximately 99% of annual U.S. South Atlantic coast commercial southern flounder landings since 1978 (Figure 2). North Carolina's total commercial removals (landings and dead discards; in pounds) are equivalent to approximately 38.3% of the coast-wide removals of southern flounder for the last 10 years (Figure 3). The commercial landings of southern flounder in North Carolina increased steadily in the mid-1970s, peaked in the mid-1990s at more than 4 million pounds, and have since declined to approximately 1.4 million pounds in 2017 (Figure 4). In 2017, dead discards in the North Carolina southern flounder commercial gill net fishery (the only commercial fishery with discard estimates) were the lowest they had been over the time series of the stock assessment (1989-2017), accounting for 0.3% of North Carolina's total commercial removals in 2017. Dead discards in the North Carolina commercial gill net fishery have steadily been declining from a peak in 1994. The total number of individual participants in the commercial southern flounder fishery during 2017 was 1,048 and has been variable the last 10 years ranging from 945 (2016) to 1,299 (2009). Many of the participants often use multiple gears and will fish multiple gears per trip in order to maximize effort. Commercial trips landing southern flounder have declined since 2008 primarily in the gill net and other gear categories. Pound net trips have been variable and gigs have increased (Table 1). Likewise, the number of participants landing southern flounder has declined since 2008, primarily in the gill net and other gear categories. Gig participants have increased and pound net trips have remained relatively constant since 2008 (Table 1).

Southern flounder, or flounder species in general, are one of the most sought-after recreational species in North Carolina. Historically, North Carolina accounted for approximately 21.1% of the total recreational removals (observed harvest and dead discards; in pounds) in the U.S. South Atlantic (Figure 5); in 2017, North Carolina accounted for 29.6% of the recreational removals coast-wide. For the last 10 years (2008-2017), North Carolina's total recreational removals (in pounds) are equivalent to approximately 19% of the total coast-wide removals (Figure 3). Southern flounder are taken by recreational fishers using hook-and-line, gigs, and through the recreational use of commercial gears such as gill nets. In the North Carolina recreational hook-and-line fishery, flounder species have been the most often reported target species in 20 of the last 37 years (Figure 6; Table 2). Species targeted during recreational angling trips are identified through interviews conducted by Marine Recreational Information Program (MRIP) agents.

The recreational harvest of southern flounder exhibits a distinct seasonality concentrated between May and October, whereas commercial harvest is concentrated between September and November (Figure 7; Figure 8). Since 2011, there has been a decrease in recreational harvest of southern flounder in the recreational hook-and-line fishery due, at least in part, from an increase to a 15-inch minimum size limit (Figure 9). Increases in the minimum size limit over time have also resulted in North Carolina having the largest recreational ratio of released to harvested flounder in the U.S. South Atlantic (Figure 10).

Additional information about stock assessments, fishery habitat and water quality considerations, and user conflicts may be found in Amendment 1 to the FMP, the 2018 FMP Review for Southern Flounder, the Coastal Habitat Protection Plan, and the 2018 updated coast-wide stock assessment for southern flounder (NCDMF 2013, 2018a; NCDEQ 2016; Flowers et al. 2019).

Amendment 1 Management

Southern flounder is currently managed under Amendment 1 and Supplement A to Amendment 1 as modified by the Aug. 17, 2017 settlement agreement of the N.C. Southern Flounder FMP (NCDMF 2013, 2017a; Table 3). Actions to achieve sustainable harvest in Amendment 1 included: 1) accepting certain management measures to reduce protected species interactions as the management strategy for achieving sustainable harvest in the commercial southern flounder fishery and 2) increasing the recreational minimum size limit to 15 inches total length (TL) and decreasing the daily creel limit to six fish. Amendment 1 also set new sustainability benchmarks of 25% Spawning Potential Ratio (SPR; threshold) and 35% SPR (target).

The NCMFC took final action on Supplement A to Amendment 1 at its November 2015 business meeting. The NCMFC adopted a suite of management measures with varied effective dates ranging from Jan. 1 through Oct. 16, 2016. Management actions approved included: 1) increasing the commercial minimum size limit to 15 inches TL; 2) increasing the minimum mesh size for gill nets to six inches stretched mesh (ISM) for the harvest of southern flounder; 3) annually closing the commercial gill net and recreational fisheries on Oct. 15; 4) a 38% harvest reduction in commercial pound net harvest based on 2011–2015 average landings; 5) closing the commercial gig fishery once the commercial pound net fishery closes; and 6) increasing the minimum mesh size of escape panels in flounder pound nets to five and three-quarter inches. On Oct. 10, 2016, a judge issued a temporary injunction against certain management changes adopted by the NCMFC as part of Supplement A to Amendment 1. The temporary injunction remained in effect until a settlement agreement was reached on Aug. 17, 2017. Per the settlement agreement, only certain provisions of Supplement A remain in place and no new temporary management measures can be

implemented until the adoption of the next amendment to the FMP. The management measures that were not implemented under the agreement were the Oct. 15 commercial gill net and recreational closure, the closure of the commercial gig fishery, and the 38% reduction in commercial pound net landings based on 2011–2015 average landings.

The current recreational bag limit of no more than four flounder per person per day is required through the N.C. Fishery Management Plan for Interjurisdictional Fisheries. This was implemented in 2017 to maintain compliance with the Atlantic States Marine Fisheries Commission (ASMFC) Summer Flounder, Scup, and Black Sea Bass Fishery Management Plan Addendum XXVIII.

IV. AMENDMENT 2 GOALS, OBJECTIVES, AND STOCK STATUS

The goal and objectives for the FMP are as stated below.

Goal

Manage the southern flounder fishery to achieve a self-sustaining population that provides sustainable harvest using science-based decision-making processes. The following objectives will be used to achieve this goal.

Objectives

1. Implement management strategies within North Carolina and encourage interjurisdictional management strategies that maintain/restore the southern flounder spawning stock with multiple cohorts and adequate abundance to prevent recruitment overfishing.
2. Restore, enhance, and protect habitat and environmental quality necessary to maintain or increase growth, survival, and reproduction of the southern flounder population.
3. Use biological, environmental, habitat, fishery, social, and economic data needed to effectively monitor and manage the southern flounder fishery and its ecosystem impacts.
4. Promote stewardship of the resource through increased public awareness and interjurisdictional cooperation throughout the species' range regarding the status and management of the southern flounder fishery, including practices that minimize bycatch and discard mortality.

Stock Assessment

The biological unit stock for southern flounder inhabiting U.S. South Atlantic coastal waters includes waters of North Carolina, South Carolina, Georgia, and the east coast of Florida, and is based on multiple tagging studies (Ross et al. 1982; Monaghan 1996; Schwartz 1997; Craig and Rice 2008), genetic studies (Anderson and Karel 2012; Wang et al. 2015), and an otolith morphology study (Midway et al. 2014), all of which provide evidence of a single unit stock occurring from North Carolina through the east coast of Florida. Based on this life history information, a multi-state cooperative group performed a stock assessment to determine the status of southern flounder in U.S. South Atlantic waters.

To address the coast-wide nature of the southern flounder stock, a comprehensive stock assessment approach, using the Age Structured Assessment Program (ASAP) model, was applied to available data from North Carolina through the east coast of Florida to assess the status of the U.S. South

Atlantic southern flounder stock from 1989 through 2017 (Flowers et al. 2019). The assessment is based on a forward-projecting, statistical catch-at-age approach using ASAP3 software (version 3.0.17; NOAA Fisheries Toolbox 2014). The model synthesized information from multiple fishery-independent and fishery-dependent data sources, tracked population dynamics, estimated critical demographic and fishery parameters such as fishing mortality (F), and thus, provided a comprehensive assessment of southern flounder status in the U.S. South Atlantic. The model estimated overall declining trends in recruitment and female spawning stock biomass (SSB). Recruitment has decreased throughout the time-series from approximately 13 million recruits in 1989 to approximately 4 million recruits in 2017 (Figure 11). The model also predicted a decline in SSB beginning in 2007, which corresponds with an increase in F beginning in 2007 with a time-series high in 2013 (Figure 12; Figure 13).

The model estimated $F_{35\%}$ (fishing mortality target) as 0.35 and $F_{25\%}$ (fishing mortality threshold) as 0.53. Estimated fishing mortality in 2017 was 0.91, which is higher than the F threshold of 0.53 and indicates overfishing is occurring (Figure 12). The probability the fishing mortality in 2017 was above the threshold value of 0.53 is 96.4%, whereas there is a 100% chance fishing mortality in 2017 was above the target value of 0.35.

Amendment 2 sustainability benchmarks were calculated using projected SSB values modeled using estimates of fishing mortality associated with a SPR 25% (threshold) and SPR 35% (target) instead of using static estimates of SPR as used in Amendment 1. Static SPR estimates only reflect changes in fishing mortality not SSB. The ASAP model estimated a value of 5,452 metric tons (approximately 12.0 million pounds) for $SSB_{35\%}$ (SSB target) and a value of 3,900 metric tons (approximately 8.6 million pounds) for $SSB_{25\%}$ (SSB threshold). The estimate of SSB in 2017 is 1,031 metric tons (approximately 2.3 million pounds), which is lower than the SSB threshold of 3,900 metric tons and indicates the stock is overfished (Figure 13). The probability that SSB in 2017 was below the threshold and target value (3,900 and 5,452 metric tons, respectively) is 100%.

V. AUTHORITY

North Carolina General Statutes

G.S. 113-134 RULES

G.S. 113-182 REGULATION OF FISHING AND FISHERIES

G.S. 113-182.1 FISHERY MANAGEMENT PLANS

G.S. 143B-289.52 MARINE FISHERIES COMMISSION – POWERS AND DUTIES

North Carolina Marine Fisheries Commission Rules

15A NCAC 03H .0103 PROCLAMATIONS, GENERAL

15A NCAC 03M .0503 FLOUNDER

VI. MANAGEMENT STRATEGIES FOR SUSTAINABLE HARVEST

The management measures implemented from the original FMP (2005), Amendment 1 (2013), and Supplement A to Amendment 1 as modified by the Aug. 17, 2017 settlement agreement (2017) have not resulted in the necessary decrease in fishing mortality and increase in SSB to end the stock's overfishing or overfished status, thus further reductions are necessary (NCDMF 2005, 2013, 2017a). Management measures will be selected and implemented based on the allowable total removals (landings and dead discards) calculated related to the 2017 fishing mortality estimates of the terminal year of the stock assessment through projections.

Projections for Rebuilding and Reductions

North Carolina General Statute 113-182.1 mandates that fishery management plans shall: 1) specify a time period not to exceed two years from the date of adoption of the plan to end overfishing, 2) specify a time period not to exceed 10 years from the date of adoption of the plan for achieving a sustainable harvest, and 3) must also include a standard of at least 50% probability of achieving sustainable harvest for the fishery. Sustainable harvest is defined in North Carolina General Statute 113-129(14a) as “the amount of fish that can be taken from a fishery on a continuing basis without reducing the stock biomass of the fishery or causing the fishery to become overfished.”

To meet statutory requirements, calculations were made to determine the reductions in total coast-wide removals (all fishery removals from each of the four states) necessary to end overfishing within two years and recover the stock from an overfished status within the 10-year period. To reach the fishing mortality threshold and end overfishing within two years, a 31% reduction in removals is necessary, while a 51% reduction is necessary to reach the fishing mortality target. However, while both reductions are enough to end overfishing in two years, neither are enough to end the overfished status within the 10-year time period (Figure 14).

An additional series of projections was performed to determine the reductions in total coast-wide removals necessary to end the overfished status by reaching the SSB threshold within 10 years and reaching the SSB target within 10 years. Projections were conducted for years 2018–2050 using the AgePro software version 4.2.2 (Brodziak et al. 1998). Four scenarios were performed that would achieve a sustainable harvest:

- 1) Determine F needed to end overfished status (i.e., reach the SSB threshold) within 10 years
- 2) Determine F needed to reach the SSB target within 10 years
- 3) Determine F needed to reach a value between the SSB threshold and target within 10 years
- 4) Determine F as a result of a partial moratorium (as requested by the MFC)

Projections assume all four states implement measures for the reductions required to rebuild SSB. In addition, projections detailing changes in SSB assume the shrimp trawl fleet removals will continue in all scenarios. However, the partial moratorium projection also assumes no removals from the commercial or recreational fisheries, whereas less restrictive scenarios account for the specified volume of removals including harvest and dead discards. These projections provide a mathematically optimistic rebuilding schedule for SSB and are unlikely to be fully achieved given the disparity of regulating commercial and recreational gear removals and without comparable management action from the other southeastern states. For further information on the interjurisdictional nature of this species, please see the Interjurisdictional Management section below.

All projections estimate necessary changes to fishing mortality when compared to the terminal year (2017) fishing mortality identified in the stock assessment. In addition, the projections assumed management would start in 2019 and the 10-year rebuilding deadline would be 2028. The projection scenarios are constrained to the current management regulations, including size limits, creel limits, and gear requirements.

Baseline projections were performed to provide guidance on a scenario where fishing continues with no reductions in removals. Under the assumption that fishing mortality continues at recent levels ($F_{2017}=0.91$) and the predicted declining trend in recruitment continues, projections indicate SSB will continue to decline (Figure 15). Other projection scenarios were carried out to determine the fishing mortality and the associated reduction in total removals (from 2017 levels and defined for the purpose of this document as the total pounds from observed harvest and dead discards within a fishery) necessary to end the overfished status (i.e., reach the SSB threshold), to reach the SSB target, and to reach a value between the SSB threshold and target within 10 years (by 2028, assuming management measures begin in 2019). The projections indicate a fishing mortality of 0.34 is needed for the SSB to reach the SSB threshold by 2028 and end the overfished status, as is statutorily required (Figure 16). This will require a 52% reduction in total removals coast wide. To reach the SSB target by 2028, fishing mortality would need to be lowered to 0.18 (Figure 17). This will require a 72% reduction in total removals coast wide. To reach a value of SSB between the threshold and the target, fishing mortality would need to be lowered to 0.26 (Figure 18). This will require a 62% reduction in total removals coast wide. All projections are associated with at least a 50% probability of achieving sustainable harvest for the fishery. These three scenarios for rebuilding SSB meet the statutory requirement to end overfishing in two years.

The Southern Flounder Stock Assessment group developed allowable harvest levels based on coast-wide reductions (North Carolina to the east coast of Florida) necessary for coast-wide stock rebuilding. However, in developing management measures, the NCDMF applied the reductions only to North Carolina's portion of total removals through the time series of this assessment.

For the purpose of this document total removals are defined as the total pounds of landed southern flounder plus dead discards. Dead discards are comprised of fish that were dead upon retrieval of gear and not harvested and fish that were released alive that experience delayed mortality. The discard mortality rate for recreationally released southern flounder is 9%, and for commercially released flounder from gill nets is 23% (Lee et al. 2018). Management measures specific to shrimp trawl bycatch were not included here because the estimates of discards and reductions needed could not be broken out by state as the calculations are coast-wide. The current level of discards for shrimp trawls was assumed to continue into the future and was maintained as a fleet when estimating necessary reductions. In addition, when the effects of removing shrimp trawl bycatch were analyzed during sensitivity analyses, they did not have an impact on the model results. The discussion below includes specific management measures that are quantifiable and projected to meet the reduction in southern flounder total removals needed to end overfishing within two years and achieve sustainable harvest within 10 years with at least a 50% probability of success as outlined in North Carolina General Statute 113-182.1. *Status quo*, or maintaining current regulations as are, does not meet the necessary reductions to end overfishing or the overfished status within the required time frame. As a result, *status quo* is not an option in Amendment 2.

Several management tools were explored to achieve North Carolina's contribution to sustainable harvest in the southern flounder fishery. Static quota, dynamic quota, slot limits, changes in size limits, and gear changes related to size limit changes, and species-specific management are not considered feasible options to address sustainable harvest in Amendment 2 due to the accelerated timeline and the immediate need to implement management measures to reduce harvest before the fall 2019 fishing season. The projections assume management would start in 2019 and the 10-year rebuilding period would need to be met by 2028; delayed implementation will further increase the magnitude of necessary reductions. Monitoring of static quotas cannot be implemented in a short

time frame as they require the Division to develop permits, evaluate the existing quota monitoring system to determine if southern flounder can be included without major revision, determine if additional staff would be necessary to monitor the quota, develop a means to verify reporting requirements, and identify the level of reporting needed (daily, weekly, monthly). In addition to logistics, the quota itself would need to be finalized, accountability measures for both the commercial and recreational fisheries developed, and the NCDMF would also need to determine what percentage of the landed quota would trigger a closure.

Likewise, changes to size limits require additional analyses and updates to the projections as they are based on 2017 regulations (minimum size limits). Analysis is limited by data currently not available (fecundity estimates) to describe the value of varying sizes of southern flounder and their impact to SSB. Additionally, selectivity estimates need to be identified for various scenarios to determine impacts due to size limit changes including slot limits. If the minimum size limit is decreased, then conservation equivalencies need to be discussed with ASMFC to account for potential impacts to the summer flounder fishery. Static quota and the other options mentioned above will be explored in Amendment 3 to the FMP, which is concurrently being developed with the Southern Flounder FMP Advisory Committee.

The NCDMF recognizes the need for quick implementation of management strategies to reduce total removals stemming from the continued overfished and overfishing status of southern flounder that have remained unchanged since 1989 relative to the 2017 thresholds. Therefore, the NCDMF recommends seasonal closures by sector, with additional management options for the commercial sector to include areas and/or gears, as the best short-term management strategy to initiate reductions to address sustainable harvest in 2019 given the status of the southern flounder stock. Additionally, several non-quantifiable management strategies (i.e., trip limits, gear changes) could be considered in conjunction with seasonal closures to help ensure the required reductions are achieved by mitigating probable effort changes due to shortened seasons. Seasonal closures can be implemented in 2019 to reduce fishing mortality and begin stock rebuilding while other management strategies are further developed and considered as part of Amendment 3 offering a more long-term approach. Implementation of season closures in 2019 with adoption of Amendment 2 starts the time period required by statute to end overfishing and rebuild SSB. Management strategies through Amendment 3 would not restart the time requirements but to further meet the mandates of the statutes.

To account for North Carolina's portion of these reductions in the recreational and commercial fisheries, the percent reduction was applied to the total removals for North Carolina from the terminal year of the assessment, which is 2017 (Figure 19). In 2017, the commercial fishery accounted for 71.8% while the recreational fishery (hook-and-line and gigs) accounted for 28.2% of the total North Carolina removals (Figure 19).

Identify Management Areas for the Commercial Fisheries

Landings data for the southern flounder commercial fishery were reviewed by North Carolina Trip Ticket Program (NCTTP) waterbody locations to determine if natural breaks by area occurred (NCDMF 2017b), thereby allowing the fishery to operate independently within multiple management areas. Areas were investigated by NCTTP waterbody because of the migratory nature of southern flounder; as the fall weather begins to change southern flounder begin to migrate to the south and east then into the ocean. The migration begins in the northern and western sounds and tributaries of the state before it begins in the southern areas. A natural break in effort and

landings occurs in several areas across the state; however, three areas appear to provide feasible management area options (Figure 20).

- A “northern” area that includes Albemarle, Currituck, Roanoke, and Croatan sounds and their associated rivers or waters north from a line extending across the 35° 46.3000’N latitude which runs approximately from the north end of Pea Island (old Coast Guard station) westerly to a point on the mainland Dare County shore at Point Peter Canal.
- A “central” area including Pamlico Sound and the Tar-Pamlico, Neuse, Pungo, and Bay rivers and their tributaries north of a line starting at a point on Portsmouth Island 35° 0.0765’ N – 76° 7.4123’ W running westerly to Cedar Island Ferry following the shoreline to a point at Cedar Island Ferry landing 35° 1.1349’ N – 76° 18.7599’ W following Highway 12 to the intersection of Highway 70 to the Core Creek bridge.
- A “southern” area comprising all waters from the line described above south to the South Carolina border.

These three management areas capture the seasonality of the commercial southern flounder fishery while providing each area an opportunity for harvest during a portion of the peak migration periods. Because the recreational fishery is not as reliant on the timing of fall migration for successful harvest by region there was no need to select management areas within the recreational fishery.

Identify Seasonal Time Frames

Landings data for the southern flounder commercial and recreational fisheries were evaluated to determine how landings fluctuate during the year. This helped to identify what time periods would allow for the most productive fishery while meeting the necessary reductions in total removals. As of 2019, commercial harvest of southern flounder is allowed from Jan. 1 through Nov. 30, while recreational harvest can occur all year. Commercial landings remain low through the majority of the first half of the year and begin to increase in late summer and peak in October and early November (Figure 8). These times vary by location and gear but typically landings increase in the Albemarle Sound area (northern) in early September, Pamlico Sound (central) in mid- to late September, and Core Sound and south (southern) by October. One exception is in the southern portion of the state where the commercial gig fishery harvests flounder beginning in early summer. Recreational hook-and-line harvest is low in the early months of the year, begins to increase in May and June, and remains high through the summer before dropping off in October (Figure 7). The recreational gig fishery shows a similar pattern in seasonality with a peak in harvest in the summer.

Reducing discards is extremely important for rebuilding the stock and meeting the necessary reductions in total removals. Therefore, significant periods without commercial gear that interact with flounder in the water and without targeted recreational trips will be necessary in order to reduce discards. Identifying time periods when southern flounder harvest is low, and the harvest of other species will not be significantly impacted confounds identifying potential management options. Due to the large volume of landings that occur in the summer and fall along with the necessary reductions required, any fishing season selected will be very short. After reviewing commercial landings data by day, the fall fishery was identified as the most productive portion of the commercial targeted southern flounder fishery. Varying start dates can be selected but landings data show the earlier the start date the earlier the total allowable removals will be harvested. Also,

with the earlier start dates, most of the harvest would come from gigs and gill nets, severely limiting harvest from pound nets. Flounder pound nets have a less protracted season and only operate in the fall. To maximize the commercial harvest period and maintain equitability across gears in the commercial fishery, the southern flounder commercial fishery would need to operate somewhere between the first of September and end of November, but the timing may need to account for variation by area or gear.

MRIP harvest data was analyzed by two-week intervals to identify appropriate recreational southern flounder fishing seasons. The recreational fishery peaks in mid-summer so to maximize opportunity and minimize discards harvest should be allowed to occur within a defined window between May and October. A large portion of the recreational harvest occurs in July, so the length of a season will be significantly reduced if that month is included in any selected season. Delaying harvest until August will maximize season length while still overlapping a portion of the peak harvest period.

Establish Seasonal Closures by Area for the Commercial Fishery

North Carolina commercial harvest accounts for 38.3% of total coast-wide removals (71.8% of total North Carolina removals in 2017) (Figure 3; Figure 19). Dead discards are a minor component of the removals and accounted for 0.2% of North Carolina total commercial removals in 2017. To meet the required reductions in total removals, the NCDMF recommends separating the commercial southern flounder fishery into three management areas as described above and reducing the 2017 removals associated within each area by the necessary reduction. Total removals in pounds are comprised of the landings plus estimates of dead discards from the commercial gill net fishery.

Flounder landings reported through the NCTTP are not broken out by species. To determine the commercial landings of each species, it is assumed that all flounder harvested from internal waters are southern flounder, while all flounder taken from the ocean are summer flounder. The NCDMF determined from dependent sampling efforts of commercial fish houses that southern flounder make up less than 1% of the catch from ocean waters, while summer flounder and Gulf flounder account for approximately 2% or less of the total flounder harvested from internal waters (NCDMF unpublished data).

Once the level of allowable removals by area was calculated, commercial removals that occurred from non-targeted flounder gear such as fyke nets, crab pots, and trawls were compiled. These “other gears” removals comprise approximately 0.6% of the overall total commercial removals. To minimize regulatory burden on the “other gear” fisheries, their removals were set at the 2017 level and subtracted from the allowable harvest prior to computing the allocation for targeted commercial fisheries of gill net, pound net and gig (Table 4). Daily harvest values were then summed across various time periods and averaged across a 10-year period to identify dates the fishery could operate and provide the best chance to not exceed the identified level of catch. To maximize opportunity and maintain the fishery during periods when southern flounder are the target species, a start date of Sept. 15 was selected for each area. However, additional options are available (Tables 5, 6, and 7) and will be further considered after review of committees and public comment. To meet the required reductions, it is necessary to remove gears (e.g., anchored large mesh gill nets, flounder pound nets, and large mesh RGCL gill nets) from the water during closed seasons in internal waters where southern flounder discards are likely to occur. Potential exceptions can be allowed for commercial large mesh gill net fisheries that target American and

hickory shad and catfish species if these fisheries are only allowed to operate during times of the year and locations where bycatch of southern flounder is unlikely. Any additional discards created during closed periods will negatively impact expected reductions. It is important to note that any selected open season does not take precedent over gill net regulations necessary to maintain compliance through incidental take permits for sea turtles and Atlantic sturgeon, therefore the seasons for gill nets may not be open for the times identified herein if allowable takes for endangered species are reached.

Establish Seasonal Closures by Area for the Commercial Fishery to Reduce F to the Overfishing Threshold

A 31% reduction in total removals is necessary to reduce fishing mortality to the threshold and end overfishing within the required two-year time period. **This does not rebuild the stock to end the overfished status.** The 31% reduction in total removals allows for 965,326 pounds of allowable commercial removals of which 8,416 pounds will be available for non-targeted “other” gears (Table 4). This reduction gives the northern area allowable removals of 224,250 pounds, the central area allowable removals of 480,473 pounds, and the southern area allowable removals of 252,187 pounds (Table 4). With a Sept. 15 start date the northern area will meet their removal level on average by Oct. 26, the central area by Nov. 11, and the southern area by Nov. 25 (Table 5; Figure 21).

Establish Seasonal Closures by Area for the Commercial Fishery to Increase SSB to the Threshold

A 52% reduction in total removals is necessary to allow the SSB to increase to the threshold within the required 10-year time period. The 52% reduction in total removals allows for 671,531 pounds of allowable commercial removals of which 8,416 pounds will be available for non-targeted “other” gears (Table 4). This reduction gives the northern area allowable removals of 155,834 pounds, the central area allowable removals of 332,956 pounds, and the southern area allowable removals of 174,325 pounds (Table 4). With a Sept. 15 start date the northern area will meet their removal level on average by Oct. 17, the central area by Oct. 24, and the southern area by Nov. 15 (Table 5; Figure 21).

Establish Seasonal Closures by Area for the Commercial Fishery to Increase SSB between the Threshold and Target

A reduction of 62% in total removals will end overfishing and achieve sustainable harvest by rebuilding SSB between the threshold and target within the required 10-year time period. The 62% reduction in total removals allows for 531,629 pounds of allowable commercial removals of which 8,416 pounds will be available for non-targeted “other” gears (Table 4). This reduction gives the northern area allowable removals of 123,255 pounds, the central area allowable removals of 262,710 pounds, and the southern area allowable removals of 137,248 pounds (Table 4). With a Sept. 15 start date the northern area will meet their removal level on average by Oct. 13, the central area by Oct. 17, and the southern area by Nov. 2 (Table 5; Figure 21).

Establish Seasonal Closures by Area for the Commercial Fishery to Increase SSB to the Target

A 72% reduction in total removals is necessary to allow the SSB to increase to the target within the required 10-year time period. The 72% reduction in total removals allows for 391,726 pounds of total removals of which 8,416 pounds will be available for non-targeted “other” gears (Table 4). This reduction gives the northern area allowable removals of 90,675 pounds, the central area

allowable removals of 192,464 pounds and the southern area allowable removals of 100,171 pounds (Table 4). With a Sept. 15 start date the northern area will meet their removal level on average by Oct. 6, the central area by Oct. 11, and the southern area by Oct. 20 (Table 5; Figure 21).

Establish Seasonal Closure for the Recreational Fishery

North Carolina recreational harvest accounts for 21.1% of the total recreational coast-wide removals (Figure 5). The recreational fishery accounts for 28.2% of the total removals in North Carolina; 26.0% of the total removals were from recreational harvest and 2.2% from recreational dead discards (Figure 19). In 2017, harvest accounted for 92% and dead discards accounted for 8% of the total North Carolina recreational removals. In the last 10 years, the proportion of dead discards in the total removals for the recreational fishery has been of a similar magnitude. North Carolina represents the largest proportion of southern flounder released by recreational anglers in the South Atlantic (Figure 10). Current regulatory measures have resulted in a ratio of nine discarded fish for every one fish harvested by hook-and line in North Carolina in 2017. Dead discards were identified at a rate of 9% of the recreational releases (discard mortality rate). Applying a weight of 0.21 pounds per released fish results in 37,597 pounds of dead discards for 2017. In 2017, the recreational hook-and-line fishery harvested 451,126 pounds of southern flounder. This added to the dead discards (37,597 pounds) results in 488,723 total pounds of southern flounder removed in the recreational hook-and-line fishery. In addition to the recreational hook-and-line fishery, the recreational gig fishery was examined to identify possible seasons to achieve necessary reductions. Gig harvest accounted for 11% of the total recreational harvest in 2017, with dead discards making up 2.6% of the total gig removals. The recreational gig fishery total removals in 2017 was 57,019 pounds. It is necessary to maintain concurrent seasons for the recreational hook-and-line and gig fisheries to keep from undermining the success of achieving necessary reductions.

Once the level of harvest for each reduction value was identified, catch from the MRIP was analyzed by two-week increments (the finest level of detail available) and summed to determine seasonal dates the fishery could operate while meeting the necessary reduction. When the recreational fishery is closed, recreational harvest of flounder in both internal and ocean waters will be unlawful as all flounder species (southern, summer, Gulf, etc.) are currently managed collectively in North Carolina.

Establish Seasonal Closure for the Recreational Fishery to Reduce F to the Overfishing Threshold

A reduction of 31% in total removals is necessary to reduce fishing mortality to the threshold and end overfishing within the required two-year time period. **This does not rebuild the stock to end the overfished status.** This equates to a total allowable removal of 337,219 pounds from the recreational hook-and-line fishery. Based on available harvest information seasonal dates that most closely meet the necessary reduction were identified as June 1 through Sept. 15 (Table 6).

Applying a 31% reduction leaves 39,343 pounds of allowable removals for the recreational gig fishery. Conducting the same two-week analysis as the hook-and-line fishery identified a 69% reduction in removals if the gig fishery operates during the same season, June 1 through Sept. 15 (Table 7).

Establish Seasonal Closure for the Recreational Fishery to Increase SSB to the Threshold

A reduction of 52% in total removals is necessary to allow the SSB to increase to the threshold within the required 10-year time period. This equates to a total allowable removal of 234,587 pounds from the recreational hook-and-line fishery. Based on available harvest information seasonal dates that most closely meet the necessary reduction were identified as July 16 through Sept. 30 or Aug. 1 through Sept. 30 (Table 6). It should be noted that the July 16 through Sept. 30 season will only result in a 51% reduction for the recreational hook-and-line fishery. This is the closest estimated reduction to the required 52% since MRIP estimates cannot be broken out into less than two-week windows.

Applying a 52% reduction leaves 27,369 pounds of allowable removals for the recreational gig fishery. Conducting the same two-week analysis as the hook-and-line fishery results in a 77% reduction in removals if the gig fishery operates during the July 16 through Sept. 30 season, or an 80% reduction in removals if the gig fishery operates during the Aug. 1 through Sept. 30 season (Table 7).

Establish Seasonal Closure for the Recreational Fishery to Increase SSB between the Threshold and Target

A reduction of 62% in total removals will end overfishing and achieve sustainable harvest by rebuilding SSB between the threshold and target within the required 10-year time period. This equates to a total allowable removal of 185,715 pounds from the recreational hook-and-line fishery. Based on available harvest information seasonal dates that most closely meet the necessary reduction were identified as Aug. 1 through Sept. 30 (Table 6).

Applying a 62% reduction leaves 21,667 pounds of allowable removals for the recreational gig fishery. Conducting the same two-week analysis as the hook-and-line fishery results in an 80% reduction in removals if the gig fishery operates during the Aug. 1 through Sept. 30 season (Table 7).

Establish Seasonal Closure for the Recreational Fishery to Increase SSB to the Target

A 72% reduction in total removals is necessary to allow the SSB to increase to the target within the required 10-year time period. This equates to a total allowable removal of 136,843 pounds for the recreational hook-and-line fishery. Based on available harvest information a single season from Aug. 16 through Sept. 30 was identified that meets the necessary reduction (Table 6).

Applying a 72% reduction leaves 15,965 pounds to be harvested in the recreational gig fishery. Conducting the same two-week analysis as the hook-and-line fishery identified an 84% reduction in removals if the recreational gig fishery operates during the same season, Aug. 16 through Sept. 30 (Table 7).

Establish Seasonal Closure for the Recreational Commercial Gear License (RCGL) Fishery

Recreational use of limited commercial fishing gears is allowed in North Carolina and is subject to the same reductions as the other recreational and commercial fisheries. Calculating reductions for the RCGL fishery is not possible as collection of RCGL harvest data has not occurred since 2008. Multiple management changes have also occurred since 2008, thus reducing the reliability of the data for estimating reductions for Amendment 2. The use of commercial gears for recreational purposes is also only allowed during an open recreational and commercial fishing

season that allows the specific gear, and the user is only allowed harvest that does not exceed the recreational limits. Due to these requirements, the only option available for harvest of flounder using a RCGL is during a period of time when the commercial and recreational fisheries are open simultaneously. Based on the above discussion RCGL gear used for harvesting southern flounder could operate between Sept. 15 and Sept. 30.

Establish a Partial Moratorium for the Commercial and Recreational Fisheries

For Amendment 2 a partial moratorium would prohibit the use of commercial and recreational gears to target southern flounder. In addition, it does not allow for any removals including incidental discards through commercial and recreational gears not targeting southern flounder, but it does allow for removals that occur through the shrimp trawl fleet. Implementation of a partial moratorium on the commercial and recreational fisheries meets the statutory requirements to end overfishing within two years and the overfished status within the 10-year time period. A projection that incorporates both commercial and recreational reductions shows the SSB rebuilding to the threshold by 2023, earlier than any other reduction scenario (Figure 22).

Additional Management Strategies

The recommendation of a seasonal approach presents some concern, as seasons do not enforce a maximum removal level on the fishery and only limit the time when targeted harvest can occur. Seasonal closure concerns include the potential to concentrate fishing effort during the open season, potentially altering fishing behaviors from previous years that were used to estimate harvest windows; that is, fishing effort may increase during the open season and lead to higher than predicted removals. To mitigate these concerns the NCDMF is evaluating additional specific quantifiable and non-quantifiable management measures, to augment the seasonal closures, that may serve to improve the overall southern flounder stock by helping to ensure total removals are reduced and southern flounder SSB and recruitment increase. In other words, incorporating management strategies in addition to seasonal closures may be necessary to make a seasonal closure approach more effective in constraining harvest to the anticipated levels. These additional strategies may not be quantifiable in this amendment but serve the purpose of addressing fishing behavior and changes in effort to minimize the possibility of catching southern flounder in a greater volume than predicted.

These potential additional strategies include items carried over from Amendment 1 and Supplement A as modified by the Aug. 17, 2017 settlement agreement.

Amendment 1 Management Carried Forward in Amendment 2

The following management measures from Amendment 1 and Supplement A to Amendment 1 are incorporated into Amendment 2 upon its adoption.

- From the Southern Flounder FMP Amendment 1:
 - Management measures including limiting the number of fishing days per week and the amount of yardage allowed for large mesh gill nets in various areas of the state;
 - A minimum distance (area dependent) between gill net and pound net sets, per NCMFC Rule 15A NCAC 03J .0103 (d); and
 - A recreational minimum size limit of 15 inches TL.
- From Supplement A to the Southern Flounder FMP Amendment 1, as modified by the Aug. 17, 2017 settlement agreement:

- A commercial minimum size limit of 15 inches TL;
- A minimum mesh size of 6.0-ISM to harvest southern flounder from a gill net; and
- A minimum mesh size of 5.75-ISM for pound net escape panels.

Additionally, the recreational bag limit of no more than four flounder per person per day will be maintained in Amendment 2. This bag limit is required through the N.C. Fishery Management Plan for Interjurisdictional Fisheries to maintain compliance with the ASMFC Summer Flounder, Scup, and Black Sea Bass FMP Addendum XXVIII. It is important to note, the December commercial closure period from Amendment 1 will no longer be in effect, as it will be encompassed by any seasonal closure periods implemented by the adoption of Amendment 2.

In addition to those items described above, the following potential options or strategies may mitigate expansion in effort due to shortened seasons and keep estimates more in line with projections.

Non-Quantifiable Harvest Reductions

There are two categories of management measures: quantifiable and non-quantifiable. “Quantifiable” are those reductions, as discussed in previous sections, that can be measured in terms of the impact they will have on reducing removals of southern flounder. “Non-Quantifiable” measures are those measures that will likely reduce removals, but the magnitude of the impact can only be qualified. This does not mean that non-quantifiable measures are not important to consider in management, they merely are not able to be included in the percent reduction needed to end the overfishing/overfished status as statutorily required. If non-quantifiable measures are implemented, future stock assessments will indirectly reflect their effect on the fishery status along with the impact of the quantifiable measures. These management strategies are intended to help constrain fishing effort in order to ensure required reductions are achieved; these are needed as the seasons do not cap total removals as a quota would. Various non-quantifiable management options under consideration include:

- Trip limits for the commercial gig and pound net fisheries;
- Limiting the number of fishing days per week in the large mesh gill net fishery as a means to control effort in the fishery;
- Limiting the fishing times in the large mesh gill net fishery as means to control effort in the fishery;
- Yardage reductions; and
- Prohibiting the use of picks when removing undersized fish from pound nets.

Trip Limits

As of 2019 there are no trips limits in place for the southern flounder commercial fishery. However, as seasons do not create a cap on harvest but only limit harvest to certain time periods, trip limits may enhance the effectiveness of Amendment 2. Trip limits are generally used within the confines of a quota to prevent harvesting the available amount of fish too quickly and to avoid exceeding the quota (overage). In the case of Amendment 2, the proposed seasons are meant to act in a similar capacity as a quota. NCMFC Rule 15A NCAC 03M .0503 allows for the Fisheries Director, by proclamation, to specify the quantity of flounder landed within the flounder fishery. To help ensure the required reductions are achieved, trip limits for pound nets and gigs could be recommended. To calculate the trip limits for the gig and pound net fisheries, average landings for the past 10

years by the areas proposed were reviewed in conjunction with the numbers of trips with landings in increments for each area based on the 10-year average for that fishery.

For the gig fishery, a trip limit in numbers of fish, not pounds, is needed for the restriction to be enforceable. To calculate this, the pounds harvested were converted to numbers of fish based on an average of 2.56 pounds per gilled fish as determined from commercial fish house sampling. Proposed trip limits for the commercial gig and pound net fishery have not been determined at this time, but information is available to identify the volume of trips that remove southern flounder based on various intervals (Table 8; Table 9).

With Amendment 2, trip limits for gill nets to minimize the impacts of additional discards to the total removals in 2019 are not recommended. Trip limits on gill net fisheries create additional discards, as captured fish in excess of a specified trip limit would not be retained but released with an estimated mortality of 23%. There are concerns with trip limits for the pound net fishery, particularly if set too low. Since southern flounder can be held in pound nets, it is possible for fishermen to hold southern flounder until they can be landed. Multiple people can harvest from a single operation in order to land the fish available. If the pound net trip limit is set too low, safety becomes a consideration as well and fisherman may be forced to fish their sets in unfavorable weather conditions; currently, sets are fished on good weather days, not every day.

Fishing Times

Pursuant to NCMFC Rule 15A NCAC 03J .0103 the Fisheries Director may, by proclamation, specify the means and methods for setting gill nets. Per proclamation it is unlawful to use gill nets with a stretched mesh length of 4.0 inches through 6.5 inches for daytime sets in Management Units B, D2, and E; only single overnight soaks are permitted where nets may be set no sooner than one hour before sunset and must be retrieved no later than one hour after sunrise the next morning. In Management Units D2 and E, overnight sets are allowed five out of seven days; in Management Unit B four out of seven days. Proclamation limits Management Unit A, sub unit A1 to single overnight soaks four out of seven days. The remainder of Management Unit A, which includes Albemarle Sound and its tributaries, as well as the Neuse and Tar/Pamlico rivers are currently exempt from prohibitions on the setting of gill nets and are required to actively fish net sets at least once during a 24-hour period no later than 12 noon each day. One recommendation to help ensure required reductions are achieved could be for gill nets set in the Albemarle Sound and its tributaries as well as the Neuse and Tar/Pamlico rivers to also be reduced to single overnight soaks where nets may be set no sooner than one hour before sunset and must be retrieved no later than one hour after sunrise the next morning. The number of allowable fishing days in these areas, unless otherwise stated in proclamation, could be reduced to setting Sunday night through Thursday night (five out of seven days). Changes to fishing times would bring consistency between soak times across areas of the state and limit potential discards.

Gear Changes

Gill Nets

Pursuant to NCMFC Rule 15A NCAC 03J .0103 the Fisheries Director may, by proclamation, specify the net number and length for setting gill nets. Per proclamation it is unlawful to use large mesh gill nets more than 2,000 yards in length in Management Units A, B and C, and more than 1,000 yards in length in Management Units D1, D2 and E. Table 10 provides the average yards of

large mesh gill nets fished by Management Unit for 2016-2017. These values were calculated from observer trips and responses from fishermen during fish house sampling. One recommendation to help ensure required reductions are achieved could be to further reduce the maximum yardage allowed, which could prevent fishermen from increasing the total length of large mesh gill nets set to offset the proposed shortened seasons.

Pound Nets

The use of puncturing devices (including fish picks, gaffs, gigs, and spears) could be prohibited when removing undersized flounder from a pound net. This would minimize additional discards to the total removals.

Socioeconomic Impacts to the Southern Flounder Commercial and Recreational Fisheries

North Carolina General Statute 113-182.1(b)(1) stipulates fishery management plans will include information about the social and economic impact of the fishery to the state. Despite the negative connotation of the term “impact”, it includes benefits of the fishery as well as costs. The socio-economic information presented is about the current fishery and is not intended to be used to predict potential impacts from management changes. However, this and other information pertaining to fishery management plans is included to help inform decision-makers regarding the long-term viability of the state’s commercially and recreationally significant species or fisheries.

IMPLAN economic impact modeling software is used to generate an input-output model of economic impacts associated with recreational southern flounder fishing (IMPLAN Group, LLC. 2013. IMPLAN System, Version 3.1.1001.2. Huntersville, NC. www.implan.com.) Input-output modelling and analysis provide a means to examine inter-industry relationships within an economy and relationships between businesses and final consumers. IMPLAN is a regional input-output modeling system consisting of regional data bases and trade flow data. IMPLAN is used by several state agencies, universities and federal agencies, including the U.S. Forest Service, National Oceanic and Atmospheric Administration (NOAA) Fisheries, the U.S. Army Corps of Engineers, the National Park Service, and the Bureau of Land Management. Expenditure estimates are input into the appropriate industry sector and the model generates estimates for three types of impacts: employment, income, and output. Output is the gross sales impact from businesses within the economic region affected by an activity. Labor income impacts include personal income (wages and salaries) and proprietors generated as a result of the economic activity in a target area. Employment impacts are the estimated jobs generated from said economic activity.

Quantifying the potential economic impacts to the commercial and recreational fisheries has several uncertainties discussed below, and the commercial and recreational impact estimates cannot be directly compared due to how they are calculated. For a detailed explanation of the methodology used to estimate the economic impacts please refer to the NCDMF’s License and Statistics Section Annual Report (NCDMF 2018b). Each model is estimated using the best available data to capture economic activity in each sector. However, the data and the activity being captured in each sector are not the same. The commercial fishing sector is a predefined industry in IMPLAN that can be custom tailored based on NCTTP data. It is a straightforward impact assessment because it is a single industry demand change based on the ex-vessel value of landings. IMPLAN’s multipliers and inter-industry transactional data are well defined for this industry. The recreational sector does not have a defined single industry within IMPLAN. Recreational angling economic activity is measured through expenditures in a variety of industries. Angler trip

expenditures (fuel, bait, ice, food, lodging, etc.) occur across a variety of industries. The recreational impact model in its nature is of larger magnitude than the commercial aspect because it is describing spending changes in a greater variety of industries. Commercial fishing is driven by inter-industry (indirect) transactions, where recreational fishing is driven by induced household spending. Typically, induced impact magnitudes are higher by nature especially in rural areas because of the natural way industries are located. Household demand for lower order goods can be met with relative ease in rural areas but inputs are typically imported.

Commercial Impacts

The economic impact estimates presented represent those of commercial southern flounder harvesters, dealers, and processors and are calculated via the NCDMF commercial fishing economic impact model. The model now includes contributions from wholesalers, distributors, and retailers as sourced from NOAA's most recent Fisheries Economics of the U.S. These estimates are a product of IMPLAN economic impact modeling software customized with data from the NCTTP used as the primary inputs. Output is the gross sales impact from businesses within the economic region affected by an activity. Labor income impacts include personal income (wages and salaries) and proprietors generated because of the economic activity in a target area. Employment impacts are the estimated jobs generated from said economic activity (Table 11).

Due to the reductions in landings that are required, the commercial fishery will likely see a reduction in ex-vessel value of the fishery. Decreased supply of the commercial fishery will likely cause an acute jump in the average ex-vessel price per pound. Past landings and value have fluctuated widely. Ex-vessel prices fluctuate frequently and are often influenced by other substitute fisheries such as the summer flounder fishery. Southern flounder have exhibited a relatively flexible price elasticity of supply; meaning that a change in the price results in a bigger proportional change in supply. The management options presented here do not propose to explicitly remove participants in the fishery moving forward, although the potential for decreased profitability from reduced landings may cause some to exit the fishery.

Recreational Impacts

The economic impact estimates presented for southern flounder recreational fishing represent the economic activity generated from trip expenditures. These estimates are a product of annual trip estimations originating from the NOAA Fisheries MRIP effort data by area and by mode (i.e., shore, for-hire, private/rental vessel, and man-made), and trip expenditure estimates from the NCDMF economics program biennial socioeconomic survey of Coastal Recreational Fishing License holders (Dumas et al. 2009; Crosson 2010; Hadley 2012; Stemle and Condon 2018). Estimates for trips by charter fishing also include average charter fees and tips paid per trip, and pier trips include average pier admission costs.

Table 12 shows the economic impacts associated with recreational southern flounder fishing in North Carolina from 2009-2017. Over the past 10 years recreational trips targeting flounder have been declining slightly, approximately 3% on average every year. In turn, recreational trip expenditures and overall economic impacts have been declining slightly as well. The top industries impacted by recreational southern flounder fishing in terms of output sales and employment are retail gasoline stores, retail sporting goods stores, retail food and beverage stores, real estate, and wholesale trade businesses. It should be noted that not included in these estimates, but often presented in NCDMF overall recreational impacts models, are the durable good impacts from

economic activity associated with the consumption of durable goods (e.g., rods and reels, other fishing related equipment, boats, vehicles, and second homes). Durable goods represent goods that have multi-year life spans and are not immediately consumable. Most equipment related to fishing is considered durable goods. However, the durable good expense of anglers for a given species cannot be estimated. Durable goods expenses and impacts are estimated on an annual basis and serve to supplement angler expenditures outside of trip-based estimates.

The value of the economic impacts from the recreational fishery stem from directed southern flounder trips as well as trips that caught or harvested southern flounder. Trips that caught southern flounder that were not targeted trips are likely to remain at the same level, as flounder will still be available to catch and release during these trips. However, it is expected the total directed trips will likely be reduced if a season is implemented. This will reduce the overall expenditures anglers make annually pursuing southern flounder fishing, and in turn will reduce the economic impacts generated from those expenditures. It is difficult to determine the magnitude of potential losses to angler trips and the associated economic impacts. The NCDMF currently lacks data used in choice experiment methodologies which would enable modelling of predictive behavior of anglers in response to stated management actions. Anglers may choose to target another fishery more than not to fish all together. However, if management actions are successful, the stock would be rebuilt for long-term sustainable use. While there are acute economic costs for the proposed management actions for southern flounder, action is needed to rebuild and improve the fishery to ensure the long-term viability of the stock. Short-term economic costs are expected to be mitigated by the long-term sustainability of the fishery yielding positive economic returns into the fishery overall.

Interjurisdictional Management

While Amendment 2 will not impact other states' removals, it is important to describe the complexity of southern flounder management with regards to the continued cooperation among the state agencies involved with the stock assessment and the willingness of all states to enact management measures to rebuild the stock within their respective jurisdictional boundaries. There is currently no formal agreement in place requiring cooperation among the participating agencies on this particular stock and as a result, each South Atlantic state manages southern flounder in their own waters. Most other coast-wide stocks are managed by a larger governing body, such as the ASMFC or the South Atlantic Fishery Management Council, where states have common vested interests. The identified reductions to North Carolina's southern flounder total removals alone are likely not enough to rebuild the coast-wide stock without cooperation from the other states. In addition, future updates of this coast-wide stock assessment to monitor trends post-management changes hinge on cooperation among these partners. Discussions have taken place to continue cooperation and the NCDMF is spearheading efforts to further build collaborative relationships with these partners to ensure management of the stock provides for the best chance of recovery and sustainability. At an April 1, 2019 meeting with division directors and other representatives from all four states, the directors agreed to create a working group to continue informal collaboration to work towards coast-wide reductions within the constraints of each individual state management system.

An additional component to this complex jurisdictional situation is how requirements from the ASMFC Summer Flounder, Scup, and Black Sea Bass FMP will harmonize with certain southern flounder management strategies because of the overlap in management of the flounder species. It is possible that with certain management strategies (i.e., size limit changes), North Carolina may

have to apply for conservation equivalency measures for summer flounder in order to not be found out of compliance with current interstate regulations.

Current Regulations by State

North Carolina

North Carolina's commercial flounder fishery is subject to a 15-inch TL minimum size limit in internal waters and a 14-inch TL minimum size limit in ocean waters. There is a statewide closure in internal waters from Dec. 1 through Dec. 30. All flounder pound nets are required to use escapement panels of at least 5.75-ISM. In internal waters, the use of gill nets with a stretch mesh length less than 6.0 inches is prohibited for harvesting flounder. In all estuarine areas (except Pamlico, Pungo, Bay, and Neuse rivers and the Albemarle Sound Management Area), use of large mesh gill nets is limited to four nights per week and 2,000 yards, except south of Shackleford Banks and south of the Highway 58 Bridge to the South Carolina border; this gear is allowed five nights per week with a maximum of 1,000 yards. All other areas are limited to 2,000 yards of large mesh gill net. Additionally, the gill net fishery is subject to closures and other gear restrictions by Management Unit based on interactions with sea turtles and Atlantic sturgeon, which are managed through incidental take permits issued by NOAA Fisheries under the Endangered Species Act. In crab trawls, a minimum tailbag mesh size of 4-ISM is required in western Pamlico Sound to minimize bycatch of undersized southern flounder.

Current regulations for the recreational flounder fishery include a 15-inch TL minimum size limit in internal and ocean waters, a four-fish per person per day daily creel limit, and no closed season.

South Carolina

Regulations for the South Carolina flounder fishery in 2017 (*Paralichthys* spp.) include a 15-inch TL minimum size limit and a 10 flounder per person per day bag limit, not to exceed 20 flounder per boat per day. Bag limit and minimum size limits are applicable to both hook-and-line and gig fisheries in the state. It is unlawful to gig flounder in saltwater during daylight hours (excluding spearfishing). Commercial gill netting for flounder is only permitted in the Little River Inlet, a small estuary in the north of the state (no more than one hundred yards in length with a mesh size no smaller than 3.0-ISM and up to 5.5-ISM; must be attended within 500 feet).

Georgia

Current regulations for the commercial and recreational flounder fishery in Georgia include a 12-inch TL minimum size limit and a 15-fish daily bag limit. Gill nets are prohibited except for landing shad.

Florida

Current regulations for the commercial and recreational flounder fishery in Florida include a 12-inch TL minimum size limit, daily recreational bag limit of 10 fish, and harvest is limited to the use of hook-and-line, cast net, beach seine, and gigs.

Historical regulation histories for each state can be found in Lee et al. 2018.

VII. PROPOSED MANAGEMENT OPTIONS

(+ Potential positive impact of action)

(- Potential negative impact of action)

The following positive and negative impacts apply to all options; specific impacts are listed with each option.

- + May increase abundance of mature females to help rebuild SSB
- + Necessary reductions come from both commercial and recreational southern flounder fisheries
- + No rule changes required
- Decreased harvest may result in economic loss to the fishery

Commercial Fishery

- A. *Establish Seasonal Closures by Area for the Commercial Fishery to Reduce F to the Overfishing Threshold (31% reduction)*
 - + Projected to meet the reduction needed for the commercial fishery to end overfishing, per statutory requirements
 - + Season allows for equitability among gears
 - Possible increase in effort due to shortened season creating a “derby fishery”
 - Will not meet the reduction in the commercial fishery needed to achieve a level of SSB for sustainable harvest within the 10-year time period, failing to meet statutory requirements
- B. *Establish Seasonal Closures by Area for the Commercial Fishery to Reduce F and Allow the SSB to Rebuild to the Threshold (52% reduction)*
 - + Projected to meet the reduction needed for the commercial fishery to end overfishing, per statutory requirements
 - + Projected to meet the reduction for the commercial fishery needed to achieve a level of SSB equal to or greater than the threshold, per statutory requirements
 - + Season allows for equitability among gears
 - Possible increase in effort due to shortened season creating a “derby fishery”
- C. *Establish Seasonal Closures by Area for the Commercial Fishery to Increase SSB between the Threshold and Target (62% reduction)*
 - + Projected to meet the reduction needed for the commercial fishery to end overfishing, per statutory requirements
 - + Projected to meet the reduction for the commercial fishery needed to achieve a level of SSB between the threshold and target, per statutory requirements
 - + Projections show rebuilding occurring more quickly than the minimum reduction and this increases the probability of reaching the threshold
 - + Season allows for equitability among gears
 - Possible increase in effort due to shortened season creating a “derby fishery”
- D. *Establish Seasonal Closures by Area for the Commercial Fishery to Reduce F and Allow the SSB to Rebuild to the Target (72% reduction)*
 - + Projected to meet the reduction needed for the commercial fishery to end overfishing, per statutory requirements

- + Projected to meet the reduction for the commercial fishery needed to achieve a level of SSB equal to the target, per statutory requirements
 - + Projections show rebuilding occurring more quickly than the minimum reduction and this increases the probability of reaching the threshold
 - + Season allows for equitability among gears
 - Possible increase in effort due to shortened season creating a “derby fishery”
- E. *Establish a Partial Moratorium for the Commercial and Recreational Fisheries*
- + Projected to meet the reduction needed for the commercial fishery to end overfishing, per statutory requirements
 - + Projected to meet the reduction for the commercial fishery needed to achieve a level of SSB equal to the target, per statutory requirements
 - + Projections show rebuilding occurring more quickly than the minimum reduction and this increases the probability of reaching the threshold
 - + Prioritizes stock rebuilding
 - Discards due to incidental catch when targeting other species

Recreational Fishery

- A. *Establish a Seasonal Closure for the Recreational Fishery to reduce F to the Overfishing Threshold (31% reduction)*
- + Projected to meet the reduction needed for the recreational fishery to end overfishing, per statutory requirements
 - Will not meet the reduction in the recreational fishery needed to achieve a level of SSB for sustainable harvest within the 10-year time period, failing to meet statutory requirements
 - Discards due to incidental catch when targeting other species
- B. *Establish a Seasonal Closure for the Recreational Fishery to Reduce F and Allow the SSB to Rebuild to the Threshold (52% reduction)*
- + Projected to meet the reduction needed for the recreational fishery to end overfishing, per statutory requirements
 - + Projected to meet the reduction for the recreational fishery needed to achieve a level of SSB equal to or greater than the threshold, per statutory requirements
 - Discards due to incidental catch when targeting other species
- C. *Establish a Seasonal Closure for the Recreational Fishery to Increase SSB between the Threshold and Target (62% reduction)*
- + Projected to meet the reduction needed for the recreational fishery to end overfishing, per statutory requirements
 - + Projected to meet the reduction for the recreational fishery needed to achieve a level of SSB between the threshold and target, per statutory requirements
 - + Projections show rebuilding occurring more quickly than the minimum reduction and this increases the probability of reaching the threshold
 - Discards due to incidental catch when targeting other species
- D. *Establish a Seasonal closure for the Recreational Fishery to Reduce F and Allow the SSB to Rebuild to the Target (72% reduction)*

- + Projected to meet the reduction needed for the recreational fishery to end overfishing, per statutory requirements
- + Projected to meet the reduction for the recreational fishery needed to achieve a level of SSB equal to the target, per statutory requirements
- + Projections show rebuilding occurring more quickly than the minimum reduction and this increases the probability of reaching the threshold
- Discards due to incidental catch when targeting other species

E. *Establish a Partial Moratorium for the Commercial and Recreational Fisheries*

- + Projected to meet the reduction needed for the recreational fishery to end overfishing, per statutory requirements
- + Projected to meet the reduction for the recreational fishery needed to achieve a level of SSB equal to the target, per statutory requirements
- + Projections show rebuilding occurring more quickly than the minimum reduction and this increases the probability of reaching the threshold
- + Prioritizes stock rebuilding
- Discards due to incidental catch when targeting other species

Additional Management Options: Non-Quantifiable Harvest Restrictions

A. *Trip Limits*

- i. Limiting numbers per trip for the commercial gig fishery
- ii. Limiting pounds per trip for the commercial pound net fishery
 - + May ensure required reductions are achieved and alleviate concerns of a “derby fishery”
 - Some fisheries impacted more than others
 - Potential issue with enforceability for large volume pound net fishery

B. *Limiting Days per Week Allowed in the Neuse, Tar/Pamlico Rivers and the Albemarle Sound Areas that have Previously been Exempt*

- + May ensure required reductions are achieved
- + Reduce gear in the water
- + Consistency between harvest days across areas of the state
- + Limit the amount of potential discards
- Some regions impacted more than others

C. *Limiting Fishing Times Allowed in the Neuse, Tar/Pamlico Rivers and the Albemarle Sound Areas that have Previously been Exempt*

- + May ensure required reductions are achieved
- + Reduce gear in the water
- + Consistency between soak times across areas of the state
- + Limit the amount of potential discards
- Some regions impacted more than others

D. *Gear Modifications*

- i. Prohibiting the use of picks, gaffs, gigs, and spears when removing flounder from pound nets
- ii. Reducing the maximum yardage allowed in the large mesh gill net fishery

- + May ensure required reductions are achieved
- + Reduce gear in the water
- + Prevent expansion of gear
- + Limit the amount of potential discards
- Some regions impacted more than others

VIII. RECOMMENDATION

NCDMF Recommendation

Management Carried Forward

Under the NCDMF recommendation, the following management measures from Amendment 1 and Supplement A to Amendment 1 will be incorporated into Amendment 2 management upon its adoption.

- From the Southern Flounder FMP Amendment 1:
 - Management measures limiting the number of fishing days per week and the amount of yardage allowed for large mesh gill nets in various areas of the state;
 - A minimum distance (area dependent) between gill net and pound net sets, per NCMFC Rule 15A NCAC 03J .0103 (d); and
 - A recreational minimum size limit of 15 inches TL.
- From Supplement A to the Southern Flounder FMP Amendment 1, as modified by the Aug. 17, 2017 settlement agreement:
 - A commercial minimum size limit of 15 inches TL;
 - A minimum mesh size of 6.0-ISM to harvest southern flounder from a gill net; and
 - A minimum mesh size of 5.75-ISM stretched mesh for pound net escape panels.

Additionally, the recreational bag limit of no more than four flounder per person per day will be maintained in Amendment 2. This bag limit is required through the N.C. FMP for Interjurisdictional Fisheries to maintain compliance with the ASMFC Summer Flounder, Scup, and Black Sea Bass FMP Addendum XXVIII. It is important to note that the December commercial closure period from Amendment 1 will no longer in effect, as it will be encompassed by the seasonal closure periods implemented by the adoption of Amendment 2.

Amendment 2 Management Strategy

In concurrence with the incorporated actions from Amendment 1 and Supplement A to Amendment 1 as modified by the Aug. 17, 2017 settlement agreement, the N.C. Department of Environmental Quality and the NCDMF recommend a management strategy be implemented in Amendment 2 to reduce fishing mortality in the commercial and recreational fisheries to a level that ends overfishing within two years and allows the SSB to increase between the threshold and the target within 10 years via a 62% reduction ($F=0.26$) in total removals in 2019 and beginning in 2020, via a 72% reduction ($F=0.18$) in total removals (Figure 23).

Adoption of Amendment 2 Includes Continued Development of Amendment 3

Implementation of the management strategy recommended in Amendment 2 is deemed critical to successful rebuilding of the southern flounder stock, so management actions can be implemented during the 2019 calendar year and reducing harvest is not delayed while more comprehensive

strategies are developed for Amendment 3. The N.C. Department of Environmental Quality and the NCDMF recommendation includes that the adoption of Amendment 2 authorizes concurrent development of Amendment 3 and more robust management strategies. Amendment 3 will be completed as quickly as possible with the ongoing contributions of the existing FMP committee appointees. This will best serve to assist the NCDMF in development of Amendment 3, by building on the knowledge, expertise, and cooperation already underway and continue the work uninterrupted from meetings that began in January 2018.

Amendment 2 Management Recommendations

Management measures to implement the strategy from Amendment 2 include:

- The commercial harvest season will close by proclamation immediately following the August 2019 MFC meeting, the division will establish three commercial southern flounder management areas with open flounder harvest seasons during 2019 as follows:
 - Northern – Sept. 15 through Oct. 13;
 - Central – Sept. 15 through Oct. 17; and
 - Southern – Sept. 15 through Nov. 2.

Note: Monitoring, reporting, and closure requirements identified through the NCDMF's sea turtle and Atlantic sturgeon incidental take permits will remain in effect and may impact dates identified.

- The recreational hook-and-line and gig flounder harvest season will close by proclamation immediately following the August 2019 MFC meeting and will not re-open until the identified season in 2020.
- Upon the closure of the recreational hook-and-line flounder harvest season, the RCGL large mesh gill net flounder harvest season will also close as the recreational and commercial seasons must both be open to allow this gear.
- Beginning in 2020, continue use of the three commercial southern flounder management areas with open flounder harvest seasons as follows:
 - Northern – Sept. 15 through Oct. 6;
 - Central – Sept. 15 through Oct. 11; and
 - Southern – Sept. 15 through Oct. 20.

Note: Monitoring, reporting, and closure requirements identified through the NCDMF's sea turtle and Atlantic sturgeon incidental take permits will remain in effect and may impact dates identified.

- Allow an Aug. 16 through Sept. 30 recreational hook-and-line and gig fishery;
- Allow RCGL large mesh gill nets to operate from Sept. 15 through Sept. 30.

Additionally, it is necessary to remove all commercial gears targeting southern flounder from the water (e.g., commercial and RCGL anchored large mesh gill nets and gigs) or make them inoperable (flounder pound nets) in areas and during times outside of the seasons implemented. This is important, as any additional dead discards will negatively impact expected reductions in discards during periods not open for southern flounder harvest and further delay rebuilding of the stock.

Exceptions will be allowed for commercial large mesh gill net fisheries that target American and hickory shad and catfish species if these fisheries are only allowed to operate during times of the year and locations where bycatch of southern flounder is unlikely.

The NCDMF recommendation also addresses possession of southern flounder during closed seasons. During the recommended closed recreational season, it will be unlawful to possess flounder in internal and ocean waters.

During the recommended closed commercial season, it will be unlawful to possess flounder harvested from the internal waters of the state. With adoption of Amendment 2, it will also be unlawful to use any method of retrieving live flounder from pound nets that cause injury to released fish (no picks, gigs, spears, etc.).

Additionally, to minimize the likelihood of creating derby fisheries and to make a seasonal closure more effective in constraining harvest to the anticipated levels, the NCDMF also recommends the following:

- Reduce commercial anchored large-mesh gill net soak times to single overnight soaks where nets may be set no sooner than one hour before sunset and must be retrieved no later than one hour after sunrise the next morning in the Neuse, Tar/Pamlico rivers and the Albemarle Sound areas that have previously been exempt; and
- Reduce the maximum yardage allowed in the commercial anchored large-mesh gill net fishery by 25% for each Management Unit; allowing a maximum of 1,500-yards in Management Units A, B, and C, and a maximum of 750-yards in Management Units D and E unless more restrictive yardage is specified through adaptive management through the sea turtle or sturgeon Incidental Take Permits (ITP).

The N.C. Department of Environmental Quality and the NCDMF recognize that these reductions are significant but necessary to increase the probability of successfully rebuilding this important recreational and commercial resource. The department and the NCDMF recommend a 62% reduction in 2019 and a 72% reduction beginning in 2020 for the following reasons:

- The projections were made with the assumptions that each state that participated in the coast-wide stock assessment would implement measures for the necessary reductions required to rebuild SSB. There are uncertainties surrounding the other states with implementing cooperative management and the timing of regulations if implemented.
- With the ability to be implemented in 2019, seasonal closures by area provide the best short-term management tool available. It is important to act quickly for the immediate benefit of the stock but not to such a degree that fisheries are eliminated.
- It is best for the resource in the short-term by significantly decreasing fishing pressure and allowing a greater abundance of spawning stock to emigrate to the ocean to spawn, which will ultimately enhance the likelihood of stock rebuilding. The proposed seasonal closures are based on past removals and behavior and assume effort will be consistent with what has been observed in the past. Compared to quotas, seasonal closures do not place a maximum removal level on the fishery, but simply limit the time when targeted harvest can occur. Seasonal closures do present some concerns such as the potential to concentrate fishing effort during the open season, potentially altering fishing behaviors from previous years that were used to estimate harvest windows; that is, fishing effort may increase during the open season and lead to higher than predicted removals.
- The lack of rebuilding success related to management implemented from the original FMP (2005), Amendment 1 (2013), and Supplement A to Amendment 1 as modified by the Aug. 17, 2017 settlement agreement (2017) has not resulted in the necessary increase in SSB to end the stock's overfished status, thus further reductions are necessary.

Harvest of southern flounder has already been occurring during 2019 and the seasonal closures cannot be implemented until the adoption of Amendment 2. Upon adoption of Amendment 2 the director will issue a proclamation closing southern flounder harvest. The director will then issue a proclamation to open the harvest season for southern flounder consistent with the MFC selected management strategy. Seasons will still allow for some reductions and increased escapement in 2019. In 2020, reductions will more likely be realized in full, as management measures will already be in place at the start of the calendar year.

Advisory Committee Recommendations (Refer to Table 13 for a comparison of recommendations)

Southern Flounder FMP Advisory Committee

The Southern Flounder FMP Advisory Committee recommends that starting Jan. 1, 2019 a 52% reduction ($F=0.34$) be adopted with the following changes for the commercial fishery, calculated for the Northern, Central, and Southern areas:

- 40% reduction for the pound net fishery, with a start date of Sept. 15:
 - Northern – Sept. 15 through Oct. 28;
 - Central – Sept. 15 through Nov. 2; and
 - Southern – Sept. 15 through Nov. 3.
- 40% reduction for the gig fishery, with a start date of April 1:
 - Northern – April 1 through Oct. 24;
 - Central – April 1 through Nov. 11; and
 - Southern – April 1 through Aug. 25.
- For the large mesh gill net fishery, a reduction to make up the difference to yield a 52% reduction for the commercial fishery overall, with a start date of Sept. 15, recognizing that the NCDMF proposal for the RCGL large mesh gill net season of Sept. 15-Sept. 30 may be changed by this final percent reduction.

The percent reduction for the large mesh gill net fishery, based on the Southern Flounder FMP Advisory Committee recommendation, would be approximately 71% compared to the 2017 removals. This reduction to the large mesh gill net fishery is equal to 162,770 pounds in total removals. A start date of Sept. 15 results in the following seasons:

- Northern – Sept. 15 through Oct. 12;
- Central – Sept. 15 through Oct. 5; and
- Southern – Sept. 15 through Oct. 21.

The committee recommendation also includes that management measures from Amendment 1 and Supplement A to Amendment 1, as stated above in the NCDMF recommendation, be carried forward. The recommendation also maintains regulations from the ASMFC Summer Flounder, Black Sea Bass, and Scup Addendum XXVIII for recreational size and bag limit for flounder and approves the continued development of Amendment 3.

In addition, the committee recommends prohibiting the use picks, gaffs, gigs, and spears when removing flounder from pound nets. As of Jan. 1, 2020, the committee also recommends implementing a 1,500-yard limit for large mesh gill nets in Management Unit A, a 1,000-yard limit for large mesh gill nets in Management Units B and C, and a 750-yard limit for large mesh gill nets in Management Units D and E.

Finally, the committee recommends a 52% reduction be applied to the recreational fisheries. The season for the recreational hook-and-line and gig fisheries will be July 16 through Sept. 30.

After analysis of the Southern Flounder FMP Advisory Committee recommendation, the NCDMF determined the recommendation meets the statutory requirement of ending overfishing within two years. The recommendation also meets the statutory requirement of ending the overfished status within the required 10-year time period.

Southern Regional Advisory Committee

The Southern Regional Advisory Committee met on June 3, 2019 and did not reach consensus on a recommendation for draft Amendment 2.

Northern Regional Advisory Committee

The Northern Regional Advisory Committee met on June 3, 2019 and passed a motion supporting the NCDMF recommendation of the 62% reduction in 2019 and 72% percent reduction from 2020 forward to include management carried forward from Amendment 1 and Supplement A to Amendment 1, maintaining the size and bag limits established by the ASMFC Summer Flounder, Black Sea Bass, and Scup Addendum XXVII, and the continued development of Amendment 3. In addition, the Northern AC passed a motion asking the MFC to consider dividing the allowable days for gill netting amongst allowable fishing months for a given area due to the Sea Turtle ITP.

Finfish Advisory Committee

The Finfish Advisory Committee met on June 3, 2019 and recommended a reduced harvest of 52%, not to exceed 52%, until Amendment 3 is completed. This recommendation includes management carried forward from Amendment 1 and Supplement A to Amendment 1, maintaining the size and bag limits established by the ASMFC Summer Flounder, Black Sea Bass, and Scup Addendum XXVII, and the continued development of Amendment 3. The committee also recommended that the MFC ask the Secretary of DEQ to allow the Director of DMF to go out of compliance with ASMFC Summer Flounder Plan and adopt a 12-inch size limit and a 4-fish bag limit for southern flounder in North Carolina waters. The committee also requested the Southern Flounder AC look at a moratorium on all southern flounder harvest from Nov. 1, 2019 to Sept 1, 2022.

MFC Selected Management Strategy and Final Action

At the Aug. 23, 2019 Marine Fisheries Commission business meeting, the commission passed a motion to adopt Amendment 2 to the Southern Flounder Fishery Management Plan as proposed by NCDMF while allowing for seasonal flexibility in the commercial and recreational sectors to be determined by proclamation issued by the director of the Division of Marine Fisheries as long as the 62% harvest reductions in 2019 and the 72% harvest reductions for 2020 onward are met. The commission also passed a motion asking the director of NCDMF to consider a proclamation that would allow for the for-hire charter captains to possess four flounder per vessel per day when the recreational season is closed. An additional motion was passed by the NCMFC to ask the DMF director to consider an exemption to Rule 15A NCAC 03J.0501(b)(2) for existing flounder pound net sets.

FMP Implementation

On Aug. 28, 2019 the NCDMF issued proclamations closing the commercial estuarine fishery and certain ocean gears (FF-31-2019) and the recreational fishery in internal and ocean waters (FF-32-2019). Proclamation FF-34-2019 was issued Sept. 12, 2019 opening the commercial estuarine fishery for the fall 2019 season. Using the flexibility allowed by the NCMFC, the season dates deviated slightly from the Sept. 15 start date as proposed above; the northern area season started Sept. 15, but the seasons for the central and southern fishing areas will start Oct. 1. After careful consideration and looking at available data, the director of NCDMF did not issue a proclamation to create a special season for the for-hire industry outside of the recreational closure for 2019. The motion requesting an exemption for flounder pound net sets was handled through NCDMF policy. Additional proclamations will be issued to address changes in soak times and yardage restrictions prior to each flounder management unit opening, and to address the opening of the 2020 recreational and commercial seasons.

Prepared by

Michael S. Loeffler

Anne L. Markwith

Michael.loeffler@ncdenr.gov

Anne.Markwith@ncdenr.gov

252-264-3911

910-796-7292

IX. LITERATURE CITED

- Anderson, J.D., and W.J. Karel. 2012. Population genetics of southern flounder with implications for management. *North American Journal of Fisheries Management* 32(4):656–662.
- Brodziak, J., P. Rago, and R. Conser. 1998. A general approach for making short-term stochastic projections from an age-structured fisheries assessment model. In: F. Funk, T. Quinn II, J. Heifetz, J. Ianelli, J. Powers, J. Schweigert, P. Sullivan, and C.-I. Zhang (editors), *Proceedings of the International Symposium on Fishery Stock Assessment Models for the 21st Century*. Alaska Sea Grant College Program, Univ. of Alaska, Fairbanks.
- Craig, J.K., and J.A. Rice. 2008. Estuarine residency, movements, and exploitation of southern flounder (*Paralichthys lethostigma*) in North Carolina. North Carolina State University, North Carolina Sea Grant, Final Report Grant 05-FEG-15, Raleigh.
- Crosson, S. 2010. A Social and Economic Survey of Recreational Saltwater Anglers in North Carolina. Department of Environment and Natural Resources, Division of Marine Fisheries.
- Dumas, C., J. Whitehead, C. Landry, and J. Herstine. 2009. Economic Impacts and Recreational Value of the North Carolina For-Hire Fishing Fleet. North Carolina Sea Grant Fishery Resource Grant Report 07-FEG-05.
- Flowers, A.M., S.D. Allen, A.L. Markwith, and L.M. Lee (editors). 2019. Stock assessment of southern flounder (*Paralichthys lethostigma*) in the South Atlantic, 1989–2017. Joint report of the North Carolina Division of Marine Fisheries, South Carolina Department of Natural Resources, Georgia Coastal Resources Division, Florida Fish and Wildlife Research Institute, University of North Carolina at Wilmington, and Louisiana State University. NCDMF SAP-SAR-2019-01. 213 p.
- Fournier, D.A., H.J. Skaug, J. Ancheta, J. Ianelli, A. Magnusson, M. Maunder, A. Nielsen, and J. Sibert. 2012. AD Model Builder: using automatic differentiation for statistical inference of highly parameterised complex non-linear models. *Optimisation Methods & Software* 27:233–249.
- Hadley, J. 2012. A Social and Economic Profile of Ocean Fishing Piers in North Carolina. Department of Environment and Natural Resources, Division of Marine Fisheries.
- IMPLAN Group, LLC. 2013. IMPLAN System, Version 3.1.1001.2. Huntersville, NC. www.implan.com
- Lee, L.M., S.D. Allen, A.M. Flowers, and Y. Li (editors). 2018. Stock assessment of southern flounder (*Paralichthys lethostigma*) in the South Atlantic, 1989–2015. Joint report of the North Carolina Division of Marine Fisheries, South Carolina Department of Natural Resources, Georgia Coastal Resources Division, Florida Fish and Wildlife Research Institute, University of North Carolina at Wilmington, and Louisiana State University. NCDMF SAP-SAR-2018-01. 425 p.
- Midway, S.R., S.X. Cadrin, and F.S. Scharf. 2014. Southern flounder (*Paralichthys lethostigma*) stock structure inferred from otolith shape analysis. *Fisheries Bulletin* 112(4):326–338.

- Monaghan, J.P. 1996. Life history aspects of selected marine recreational fishes in North Carolina: Study 2 migration of Paralichthid flounders tagged in North Carolina, Completion Report, Grant F-43, North Carolina Division of Marine Fisheries, Morehead City, North Carolina. 44 p.
- NCDEQ (North Carolina Department of Environmental Quality). 2016. North Carolina Coastal Habitat Protection Plan Source Document. Morehead City, NC. Division of Marine Fisheries. 475 p.
- NCDMF (North Carolina Division of Marine Fisheries). 2005. North Carolina fishery management plan southern flounder (*Paralichthys lethostigma*). North Carolina Department of Environment and Natural Resources, Division of Marine Fisheries, Morehead City, North Carolina. 359 p.
- NCDMF (North Carolina Division of Marine Fisheries). 2013. North Carolina southern flounder (*Paralichthys lethostigma*) fishery management plan: Amendment 1. North Carolina Division of Marine Fisheries, Morehead City, North Carolina. 380 p.
- NCDMF 2017a. North Carolina southern flounder (*Paralichthys lethostigma*) fishery management plan: Supplement A to Amendment 1. North Carolina Division of Marine Fisheries, Morehead City, North Carolina. 83 p
- NCDMF 2017b. North Carolina Division of Marine Fisheries Trip Ticket User Manual. Version 9. North Carolina Department of Environmental Quality, Division of Marine Fisheries, Morehead City, North Carolina. 43 p.
- NCDMF 2018a. Southern Flounder *in* 2017 Fishery Management Plan Review. North Carolina Division of Marine Fisheries, Morehead City, North Carolina. 590 p.
- NCDMF 2018b. North Carolina Division of Marine Fisheries License and Statistics Section Annual Report. North Carolina Department of Environmental Quality, Division of Marine Fisheries, Morehead City, North Carolina.
- NOAA Fisheries Toolbox. 2014. Age Structured Assessment Program, version 3.0.17. [Available at <http://www.nefsc.noaa.gov/nft>, accessed October 2018]
- Ross, S.W., J.H. Hawkins, D.A. DeVries, C.H. Harvell, R.C. Harriss Jr. 1982. North Carolina Estuarine Finfish Management Program, Completion Report for Project 2-372-R. North Carolina Department of Natural Resources and Community Development, Division of Marine Fisheries, Morehead City, N. C. 175 p.
- Schwartz, F.J. 1997. Distance movements of fishes, white shrimp, and blue crabs tagged in or near the estuarine Cape Fear River and adjacent Atlantic Ocean, North Carolina, 1973 through 1978. The Journal of Elisha Mitchell Scientific Society 113:123–132.
- Stemle, A., and M. Condon. 2018. Socioeconomic Survey of Recreational Saltwater Anglers in North Carolina 2016. Division of Marine Fisheries, Morehead City, N.C.

Wang, V.H., M.A. McCartney, and F.S. Scharf. 2015. Population genetic structure of southern flounder inferred from multilocus DNA profiles. *Marine and Coastal Fisheries: Dynamics, Management, and Ecosystem Science* 7(1):220–232.

X. TABLES

Table 1. Number of Commercial Trips and Participants that landed southern flounder by gear, 2008-2017.

Year	Trips				Participants			
	Gear				Gear			
	Gigs	Gill Net	Other	Pound Net	Gigs	Gill Net	Other	Pound Net
2008	1,459	23,493	2,510	1,508	140	924	413	83
2009	1,450	23,691	2,510	1,746	143	992	426	85
2010	2,283	15,134	1,384	1,610	226	837	329	84
2011	2,076	11,403	963	1,370	212	759	250	63
2012	3,001	14,713	1,462	1,754	288	855	291	84
2013	2,408	16,968	2,094	2,111	270	933	343	82
2014	2,655	11,778	1,887	1,806	316	799	373	88
2015	2,616	8,465	1,002	1,803	307	674	249	81
2016	2,657	8,422	838	1,423	323	591	227	77
2017	2,752	12,363	943	1,908	310	713	237	88
Average	2,336	14,643	1,559	1,704	254	808	314	82

Note: Participants often participate using multiple gears and fish multiple gears per trip, individuals and trips may be duplicated across gears.

Table 2. Top five ranked species that are reported targeted in the North Carolina **recreational hook-and-line fishery**, 1981-2017. Top rank for each year is in **bold**. (Source: Marine Recreational Information Program).

Species	Trip Year																		
	1981	1982	1983	1984	1985	1986	1987	1988	1989	1990	1991	1992	1993	1994	1995	1996	1997	1998	1999
Flounder	3	1	2	2	2	2	3	4	4	2	2	2	1	1	1	1	1	1	1
Bluefish	1	2	1	1	1	1	1	1	1	1	1	1	2	2	4	2	2	2	5
Red Drum	4	4	3	4	4	5	4	3	3	4	4	4	3	3	3	5	5	3	2
Spanish Mackerel	5	5	5	5	5	4	5	5	5	5	5	5	4	5	5	4	3	4	3
Spotted Seatrout	2	3	4	3	3	3	2	2	2	3	3	3	5	4	2	3	4	5	4

Species	Trip Year																		
	2000	2001	2002	2003	2004	2005	2006	2007	2008	2009	2010	2011	2012	2013	2014	2015	2016	2017	
Flounder	1	1	1	1	1	1	1	1	1	1	1	1	2	3	3	3	3	3	
Bluefish	4	2	4	4	3	2	4	4	4	5	5	3	4	4	5	4	4	4	
Red Drum	2	3	3	3	4	5	3	2	2	3	2	4	3	1	1	1	1	1	
Spanish Mackerel	3	4	2	2	2	4	5	5	5	4	4	5	5	5	4	5	5	5	
Spotted Seatrout	5	5	5	5	5	3	2	3	3	2	3	2	1	2	2	2	2	2	

Table 3. Management action taken as a result of Amendment 1 and Supplement A to the Southern Flounder Fishery Management Plan.

MANAGEMENT STRATEGY	OUTCOME	Source Document
<p><u>Commercial</u>: Accept management measures to reduce protected species interactions as the management strategy for achieving sustainable harvest in the commercial southern flounder fishery.</p> <p><u>Recreational</u>: Increase the minimum size limit to 15 inches and decrease the creel limit to six fish-20.2% harvest reduction</p>	<p><u>Commercial</u>: No Action Required; Specific minimum measures for the flounder gill net fishery are provided in Issue Paper 10.1.1 (Amendment 1, page 129).</p> <p><u>Recreational</u>: Proclamation FF-29-2011 (refer to Supplement A to the 2005 FMP)</p>	Amendment 1
Status quo and address research recommendations	No Action Required	Amendment 1
Status quo (implement mediation and proclamation authority to address user conflicts with large mesh gill nets)	No Action Required	Amendment 1
Status quo (minimum distance (area dependent) between pound nets and gill nets; per rule 15A NCAC 03J .0103 (d))	No Action Required	Amendment 1
Status quo and address research recommendations	No Action Required	Amendment 1
Status quo and expand research on flatfish escape devices and degradable panels under commercial conditions to other parts of the state	No Action Required	Amendment 1
Status quo and expand research on factors impacting the release mortality of southern flounder and on deep hooking events of different hook types and sizes	No Action Required	Amendment 1
<ul style="list-style-type: none"> • Request funding for state observer program • Apply for Incidental Take Permit for large mesh gill net fishery • Continue gear development research to minimize protected species interactions 	No Action Required	Amendment 1
Status quo minimum mesh size for escape panels (5.5-inch stretched mesh) and recommend further research on 5.75-inch stretched mesh escape panels	No Action Required	Amendment 1
Status quo minimum mesh size (5.5-inch stretched mesh)	No Action Required	Amendment 1
<p>Increase minimum mesh size to harvest southern flounder to 6.0- inch stretched mesh</p> <p>Increase minimum size limit for commercial fisheries to 15 inches</p>	Proclamation FF-3-2016 (refer to Supplement A to Amendment 1 of the 2005 FMP)	Supplement A to Amendment 1
Increase minimum mesh size for escape panels to 5.75-inch stretched mesh	Proclamation M-34-2015 (refer to Supplement A to Amendment 1 of the 2005 FMP)	Supplement A to Amendment 1
Reduce daily bag limit for recreational harvest of southern flounder from 6 fish to 4 fish	Proclamation FF-4-2017 (refer to Addendum XXVIII to ASMFC Summer Flounder, Scup, Black seabass FMP)	Addendum XXVIII to the Summer Flounder, Scup, Black seabass FMP

Table 4. Southern Flounder Amendment 2 total allowable removals (observed harvest and dead discards) in pounds by management area to meet the necessary reductions for the overfishing threshold and SSB threshold and target of the commercial fishery in 2019 compared to the 2017 harvest and dead discards.

Reduction	Management Area	2017 Landings Value	Dead Discards	2017 Total Catch	After Reduction	“Other” Gear Allocation	Gill Net, Pound Net, Gig Allocation
Overfishing Threshold 31%	Northern	324,779	1,014	325,793	224,797	547	224,250
	Central	700,258	2,203	702,461	484,698	3,644	480,473
	Southern	369,580	1,190	370,770	255,831	4,225	252,187
	Total	1,394,617	4,407	1,399,024	965,326	8,416	956,910
SSB Threshold 52%	Northern	324,779	1,014	325,793	156,381	547	155,834
	Central	700,258	2,203	702,461	337,181	3,644	332,956
	Southern	369,580	1,190	370,770	177,969	4,225	174,325
	Total	1,394,617	4,407	1,399,024	671,531	8,416	663,115
62%	Northern	324,779	1,014	325,793	123,802	547	123,255
	Central	700,258	2,203	702,461	266,935	3,644	262,710
	Southern	369,580	1,190	370,770	140,892	4,225	137,248
	Total	1,394,617	4,407	1,399,024	531,629	8,416	523,213
SSB Target 72%	Northern	324,779	1,014	325,793	91,222	547	90,675
	Central	700,258	2,203	702,461	196,689	3,644	192,464
	Southern	369,580	1,190	370,770	103,815	4,225	100,171
	Total	1,394,617	4,407	1,399,024	391,726	8,416	383,310

*Other gear included gear that catch southern flounder incidentally. These gears include, but aren't limited to, crab post, trawls, peeler post, fyke nets, channel nets, and seines.

Table 5. Southern Flounder Amendment 2 dates of fishery opening (formatted in **bold font**) and associated closure dates by management area necessary to meet the reductions in total removals (observed harvest and dead discards) to the overfishing threshold and SSB threshold and target **for the commercial fishery** in 2019.

Reduction	Management Area	Season Start Date						
		1-Jan	1-Feb	1-Mar	1-Apr	1-May	1-Jun	1-Jul
Overfishing Threshold 31%	Northern	30-Sep	30-Sep	30-Sep	1-Oct	4-Oct	7-Oct	11-Oct
	Central	23-Oct	23-Oct	24-Oct	24-Oct	25-Oct	26-Oct	28-Oct
	Southern	5-Oct	6-Oct	6-Oct	7-Oct	11-Oct	23-Oct	5-Nov
	Statewide	14-Oct	14-Oct	14-Oct	15-Oct	17-Oct	19-Oct	23-Oct
SSB Threshold 52%	Northern	10-Sep	10-Sep	11-Sep	12-Sep	16-Sep	22-Sep	1-Oct
	Central	7-Oct	7-Oct	8-Oct	8-Oct	9-Oct	11-Oct	14-Oct
	Southern	3-Sep	4-Sep	4-Sep	6-Sep	11-Sep	27-Sep	9-Oct
	Statewide	22-Sep	22-Sep	22-Sep	23-Sep	26-Sep	1-Oct	7-Oct
62%	Northern	29-Aug	30-Aug	30-Aug	31-Aug	5-Sep	12-Sep	20-Sep
	Central	29-Sep	29-Sep	29-Sep	1-Oct	2-Oct	3-Oct	6-Oct
	Southern	7-Aug	8-Aug	9-Aug	11-Aug	17-Aug	10-Sep	30-Sep
	Statewide	9-Sep	9-Sep	10-Sep	11-Sep	14-Sep	21-Sep	28-Sep
SSB Target 72%	Northern	16-Aug	17-Aug	17-Aug	18-Aug	24-Aug	1-Sep	12-Sep
	Central	17-Sep	17-Sep	17-Sep	19-Sep	21-Sep	23-Sep	28-Sep
	Southern	15-Jul	16-Jul	16-Jul	18-Jul	24-Jul	17-Aug	17-Sep
	Statewide	22-Aug	23-Aug	23-Aug	25-Aug	31-Aug	7-Sep	18-Sep

Note: Monitoring, reporting, and closure requirements identified through the NCDMF's sea turtle and Atlantic sturgeon Incidental Take Permits will remain in effect and may impact dates identified in this table.

Table 5. Continued

Reduction	Management Area	Season Start Date					
		1-Aug	1-Sep	15-Sep	1-Oct	Jan. 1, mid-year closure, re-open Sept. 1	Jan. 1, mid-year closure, re-open Sept. 15
		Season End Date					
Overfishing Threshold 31%	Northern	14-Oct	18-Oct	26-Oct	11-Nov	15-Oct	22-Oct
	Central	2-Nov	7-Nov	11-Nov	21-Nov	4-Nov	7-Nov
	Southern	19-Nov	25-Nov	25-Nov	29-Nov	17-Nov	24-Nov
	Statewide	29-Oct	4-Nov	17-Nov	20-Nov	31-Oct	4-Nov
SSB Threshold 52%	Northern	6-Oct	10-Oct	17-Oct	31-Oct	5-Oct	13-Oct
	Central	18-Oct	21-Oct	24-Oct	5-Nov	19-Oct	21-Oct
	Southern	24-Oct	7-Nov	15-Nov	24-Nov	23-Oct	29-Oct
	Statewide	12-Oct	19-Oct	24-Oct	7-Nov	14-Oct	20-Oct
62%	Northern	26-Sep	2-Oct	13-Oct	27-Oct	27-Sep	10-Oct
	Central	10-Oct	14-Oct	17-Oct	26-Oct	11-Oct	14-Oct
	Southern	13-Oct	26-Oct	2-Nov	15-Nov	11-Oct	17-Oct
	Statewide	5-Oct	12-Oct	17-Oct	28-Oct	6-Oct	11-Oct
SSB Target 72%	Northern	20-Sep	27-Sep	6-Oct	22-Oct	12-Sep	21-Sep
	Central	2-Oct	8-Oct	11-Oct	19-Oct	4-Oct	8-Oct
	Southern	1-Oct	14-Oct	20-Oct	2-Nov	29-Sep	7-Oct
	Statewide	26-Sep	3-Oct	9-Oct	21-Oct	27-Sep	3-Oct

Note: Monitoring, reporting, and closure requirements identified through the NCDMF's sea turtle and Atlantic sturgeon Incidental Take Permits will remain in effect and may impact dates identified in this table.

Table 6. Southern Flounder Amendment 2 seasons needed to meet the necessary reduction in total removals (observed harvest and dead discards) for the overfishing threshold and SSB threshold and target of **the NC recreational hook-and-line fishery** in 2019.

	Percent Reduction	Total removals (lbs)
Terminal Year	2017	488,723
Target	72%	136,843
62 percent	62%	185,715
Threshold	52%	234,587
Overfishing	31%	337,219

Season	Percent Reduction	Total removals (lbs)
no closure	0%	488,723
Apr 16 -Jul 31	57%	211,477
Apr 16 -Jul 16	66%	165,474
Apr 16 -Jun 30	76%	118,254
May 1 -Jul 31	58%	204,398
May 1 -Jul 16	68%	158,394
May 1 -Jun 30	77%	111,175
May 16 -Jul 31	61%	192,156
May 16 -Jul 16	70%	146,153
Jun 1 - Aug 16	54%	222,471
Jun 1 - Jul 31	66%	165,932
Jun 1 - Jul 16	75%	119,928
May 1 - Sept 30	18%	399,908
Jun 1 - Sept 30	26%	360,813
Jul 1 - Sept 30	41%	286,724
Jul 16 - Sept 30	51%	240,876
Aug 1 - Sept 30	60%	195,868
Aug 16 - Sept 30	72%	138,362
Jul 1 - Oct 15	35%	318,760
Jun 1 - Sept 15	33%	325,691
Jul 1 - Sept 15	48%	253,123
Jun 16 - Sept 15	40%	294,998
Jul 16 - Oct 15	44%	271,391
Aug 1 - Oct 30	49%	249,887
Jul 16 -Oct 30	40%	294,894

Table 7. Southern Flounder Amendment 2 seasons needed to meet the necessary reduction in total removals (observed harvest and dead discards) for the overfishing threshold and SSB threshold and target of **the NC recreational gig fishery** in 2019.

	% Reduction	Total removals (lbs)
Terminal Year	2017	57,019
Target	72%	15,965
62%	62%	21,667
Threshold	52%	27,369
Overfishing	31%	39,343

Season	% Reduction	Total Removals (lbs)
no closure	0%	57,019
Mar 1 - Oct 15	15%	48,707
Mar 16 - Oct 31	16%	47,734
Mar 1 - Sept 30	21%	45,207
Apr 1 - Oct 31	24%	43,260
Mar 16 - Sept 30	29%	40,732
Apr 1 - Oct 15	30%	39,759
Apr 1 - Sept 30	36%	36,258
May 1 - Oct 31	40%	34,311
Apr 16 - Sept 30	44%	31,784
May 1 - Oct 15	46%	30,811
May 1 - Sept 30	52%	27,310
Jun 1 - Sept 30	63%	21,374
Jul 16 -Oct 31	64%	20,330
Jul 1 - Oct 15	67%	18,938
Aug 1 - Oct 31	68%	18,221
Jun 1 - Sept 15	69%	17,873
Jul 16 - Oct 15	70%	16,829
Jul 1 - Sept 30	73%	15,438
Jun 16 - Sept 15	74%	14,905
Jul 16 - Sept 30	77%	13,329
Jul 1 - Sept 15	79%	11,937
Aug 1 - Sept 30	80%	11,219
Aug 16 - Sept 30	84%	9,110

Table 8. Southern Flounder Amendment 2 trip limit options (in pounds) for the commercial pound net fishery, including the number, % of trips, and % of harvest within each trip limit option for each management area, September through November 2008-2017.

Pounds Per Trip	Management Area					
	Northern			Central		
	Number of Trips	% of Trips	% of Harvest	Number of Trips	% of Trips	% of Harvest
<251	1,633	65.2%	8.5%	4,173	51.3%	10.5%
251-500	291	11.6%	7.8%	1,533	18.8%	13.5%
501-750	159	6.3%	7.3%	794	9.8%	11.9%
751-1,000	86	3.4%	5.7%	518	6.4%	11.0%
1,001-1,250	63	2.5%	5.2%	315	3.9%	8.7%
1,251-1,500	43	1.7%	4.5%	212	2.6%	7.2%
1,501-2,000	66	2.6%	8.3%	252	3.1%	10.7%
2,001-3,000	63	2.5%	11.4%	209	2.6%	12.4%
3,001-4,000	36	1.4%	9.8%	76	0.9%	6.4%
4,001+	66	2.6%	31.6%	59	0.7%	7.8%
Average Pounds Per Trip	539			503		

Pounds Per Trip	Management Area					
	Southern			Statewide		
	Number of Trips	% of Trips	% of Harvest	Number of Trips	% of Trips	% of Harvest
<251	1,850	65.8%	17.7%	7,656	56.9%	11.2%
251-500	420	14.9%	15.4%	2,244	16.7%	12.6%
501-750	197	7.0%	12.6%	1,150	8.5%	11.0%
751-1,000	123	4.4%	10.9%	727	5.4%	9.9%
1,001-1,250	63	2.2%	7.4%	441	3.3%	7.8%
1,251-1,500	40	1.4%	5.7%	295	2.2%	6.4%
1,501-2,000	48	1.7%	8.8%	366	2.7%	9.9%
2,001-3,000	40	1.4%	10.4%	312	2.3%	11.8%
3,001-4,000	20	0.7%	6.8%	132	1.0%	7.2%
4,001+	9	0.3%	4.4%	134	1.0%	12.3%
Average Pounds Per Trip	344			475		

Table 9. Southern Flounder Amendment 2 trip limit options (in number of fish) for the commercial gig fishery, including the number, % of trips, and % of harvest within each trip limit option for each management area, 2008-2017.

Number of Fish	Management Area						
	Northern				Central		
	Equivalent pounds	Number of Trips	% of Trips	% of Harvest	Number of Trips	% of Trips	% of Harvest
25	64	77	81.9%	54.1%	859	69.4%	35.5%
50	128	14	14.9%	33.3%	268	21.6%	33.6%
75	192	2	2.1%	7.1%	75	6.1%	16.2%
100	256	1	1.1%	5.5%	24	1.9%	7.8%
125	320		0.0%	0.0%	5	0.4%	2.1%
150	384		0.0%	0.0%	1	0.1%	0.5%
175	448		0.0%	0.0%	3	0.2%	1.7%
200	512		0.0%	0.0%	3	0.2%	2.7%
Average Pounds Per Trip		41.2			57.2		

Number of Fish	Management Area						
	Southern				Statewide		
	Equivalent pounds	Number of Trips	% of Trips	% of Harvest	Number of Trips	% of Trips	% of Harvest
25	64	16,352	74.7%	44.8%	17288	74.4%	44.3%
50	128	4,222	19.3%	32.9%	4504	19.4%	33.0%
75	192	864	3.9%	11.8%	941	4.1%	12.0%
100	256	299	1.4%	5.8%	324	1.4%	5.9%
125	320	87	0.4%	2.2%	92	0.4%	2.2%
150	384	31	0.1%	1.0%	32	0.1%	0.9%
175	448	16	0.1%	0.6%	19	0.1%	0.7%
200	512	20	0.1%	1.0%	23	0.1%	1.1%
Average Pounds Per Trip		51.6			51.9		

*used an average of 2.56 pounds per fish (2008-2017 average)

Table 10. Average yards of large mesh gill net fished per trip by ITP Management Unit and season during 2016 and 2017.

Management Unit	Season	Average Yards
A	December-February	N/A
	March-May	1,464
	June-August	1,424
	September-November	1,590
B	December-February	N/A
	March-May	1,000
	June-August	921
	September-November	1,007
C	December-February	425
	March-May	951
	June-August	1,042
	September-November	964
D	December-February	600
	March-May	936
	June-August	971
	September-November	951
E	December-February	525
	March-May	586
	June-August	638
	September-November	669

Table 11. Economic impacts associated with **commercial southern flounder fishing** in North Carolina, 2009-2017.

Year	Participants ¹	Pounds ¹	Ex-Vessel Value ¹	Economic Impacts		
				Jobs ^{2,3}	Income Impacts (thousands of dollars) ³	Output Impacts (thousands of dollars) ^{3,4}
2009	1,299	2,396,240	\$4,609,932	419	\$9,908	\$17,769
2010	1,182	1,689,557	\$3,695,889	328	\$7,963	\$14,222
2011	1,039	1,247,450	\$2,753,128	246	\$5,977	\$10,669
2012	1,202	1,646,137	\$4,451,482	393	\$9,633	\$17,259
2013	1,286	2,186,391	\$5,673,190	487	\$12,347	\$21,801
2014	1,222	1,673,511	\$4,839,672	396	\$10,753	\$18,933
2015	1,029	1,202,930	\$3,823,707	300	\$8,397	\$14,722
2016	945	897,765	\$3,610,533	286	\$7,167	\$14,925
2017	1,048	1,394,552	\$5,655,489	453	\$14,660	\$21,442

1 As reported by the North Carolina Trip Ticket Program

2 Represents both full-time and part-time jobs

3 Economic impacts calculated using the NCDMF commercial fishing economic impact model and IMPLAN economic impact modeling software. Economic impact estimates are for the state economy of North Carolina.

4 Represents sales impacts

Table 12. Economic impacts associated with **recreational southern flounder fishing** in North Carolina from 2009-2017.

Year	Trips ¹	Estimated Expenditures (thousands of dollars) ²	Economic Impacts		
			Jobs ^{3,4}	Income Impacts (thousands of dollars) ⁴	Output Impacts (thousands of dollars) ⁴
2009	2,577,363	\$442,934	3,572	\$108,658	\$273,219
2010	2,900,583	\$497,196	4,052	\$124,734	\$310,591
2011	2,519,959	\$436,762	3,736	\$118,739	\$293,707
2012	2,552,146	\$444,117	3,686	\$119,177	\$294,023
2013	2,623,195	\$452,931	3,542	\$115,739	\$286,489
2014	2,685,072	\$460,707	3,486	\$115,658	\$286,196
2015	2,536,854	\$434,272	3,286	\$110,637	\$274,761
2016	2,420,326	\$415,870	3,041	\$103,370	\$254,916
2017	2,107,301	\$362,466	2,574	\$87,722	\$216,218

1 Trip estimates from MRIP include trips in which any Flounder was targeted, harvested, or discarded

2 Estimated expenditures include only trip expenditures.

3 Includes full time and part time jobs

4 Economic impacts calculated using the NCDMF coastal recreational fishing economic impact model and IMPLAN economic impact modeling software. Economic impact estimates are for the state economy of North Carolina.

Table 13. Draft NCDMF and Advisory Committee recommendations for public comment in draft Amendment 2 of the Southern Flounder FMP. Recommendations will be provided by the MFC Regional and Standing Committees and public from June 2019.

Issue	NCDMF	Southern Flounder Advisory Committee	MFC Committees	Public Comment
Sustainable harvest in the commercial fishery	Establish seasonal closures by area for the commercial fishery to reduce F and increase SSB to rebuild between the threshold and the target in 2019 (Option C, 62% reduction) and establish seasonal closures by area for the commercial fishery to reduce F and allow the SSB to rebuild to the target beginning in 2020 (Option D, 72% reduction).	<p>The Southern Flounder Advisory Committee recommends that starting Jan. 1, 2019 a 52% reduction be adopted (Option B) and implemented through seasonal closures by area and major gear type with the following changes for the commercial fishery, calculated for the Northern, Central, and Southern areas:</p> <ul style="list-style-type: none"> -40% reduction to the pound net fishery -40% reduction to the gig fishery 71% reduction to the gill net fishery (to make the total reduction to the commercial fishery equal 52%) 	<p>Southern – No recommendation</p> <p>Northern – Supports NCDMF recommendation (Option C in 2019, Option D beginning in 2020), in addition ask the MFC to consider dividing up the allowable fishing days for gill netting amongst allowable fishing months for a given area due to Sea Turtle ITP.</p> <p>Finfish – A reduced harvest of 52%, not to exceed 52% until Amendment 3 is completed (Option B). The committee also requested the Southern Flounder AC look at a moratorium on all southern flounder harvest from Nov. 1, 2019 to Sept 1, 2022.</p>	<p>Mail – 11 letters received all oppose draft Amendment 2.</p> <p>Online – 91 of 241 respondents supported draft Amendment 2. Of those that indicated support of draft Amendment 2 Option C (62% reduction) was the most selected option for 2019 and option D (72% reduction) was the most selected option for 2020.</p> <p>Public Comment – Thirteen total comments, 3 (23%) in favor of and 10 (77%) oppose draft Amendment 2.</p>

Table 13. Continued.

Issue	NCDMF	Southern Flounder Advisory Committee	MFC Committees	Public Comment
Sustainable harvest non-quantifiable harvest restrictions in the commercial fishery	<p>NCDMF recommends expanding the commercial gill net management measures by reducing to single overnight soaks where nets may be set no sooner than one hour before sunset and must be retrieved no later than one hour after sunrise the next morning in the Neuse, Tar/Pamlico rivers and the Albemarle Sound areas that have previously been exempt;</p> <p>Reduce the maximum yardage allowed in the commercial anchored large mesh gill net fishery by 25% for each Management Unit; allowing a maximum of 1,500-yards in Management Units A, B, and C, and 750-yards in Management Units D and E;</p> <p>Prohibit the use of any method of retrieving live flounder from pound nets that cause injury to released fish (no picks, gigs, spears, etc.).</p>	<p>As of Jan. 1, 2020, implement a 1,500-yard limit for large mesh gill nets in Management Unit A, a 1,000-yard limit for large mesh gill nets in Management Units B and C, and 750-yard limit for large mesh gill nets in Management Units D and E.</p> <p>Prohibit the use of any method of retrieving live flounder from pound nets that cause injury to released fish (no picks, gigs, spears, etc.).</p>	<p>Southern – No recommendation</p> <p>Northern – No recommendation</p> <p>Finfish – No recommendation</p>	<p>Mail – No respondents commented on this item.</p> <p>Online – 183 of 193 responses supported one or more additional non-quantifiable management measures.</p> <p>Public Comment – No respondents commented on this item.</p>

Table 13. Continued.

Issue	NCDMF	Southern Flounder Advisory Committee	MFC Committees	Public Comment
Sustainable harvest in the recreational fishery	<p>Establish seasonal closures by area for the recreational fishery to reduce F and increase SSB to rebuild between the threshold and the target in 2019 (Option C, 62% reduction) and establish seasonal closures by area for the recreational fishery to reduce F and allow the SSB to rebuild to the target beginning in 2020 (Option D, 72% reduction).</p> <p>The Recreational Commercial Gear License fishery, for large mesh gill nets, will operate during the dates where the recreational and commercial seasons overlap.</p>	<p>The Southern Flounder Advisory Committee recommends that starting Jan. 1, 2019 a 52% reduction be adopted (Option B) and implemented through seasonal closures for the recreational hook-and-line and gig fisheries. The recreational gig fishery will follow the same season as the hook-and-line season.</p> <p>The Recreational Commercial Gear License large-mesh gill net season the same as NCDMF</p>	<p>Southern – No recommendation</p> <p>Northern – Supports NCDMF recommendation (Option C in 2019, Option D beginning in 2020).</p> <p>Finfish – A reduced harvest of 52%, not to exceed 52% until Amendment 3 is completed (Option B). The committee also recommended that the MFC ask the Secretary of DEQ to allow the Director of DMF to go out of compliance with ASMFC Summer Flounder Plan and adopt a 12-inch size limit and a 4-fish bag limit for southern flounder in North Carolina waters. The committee also requested the Southern Flounder AC look at a moratorium on all southern flounder harvest from Nov. 1, 2019 to Sept 1, 2022</p>	<p>Mail – No respondents commented on this item.</p> <p>Online – 91 of 241 respondents supported draft Amendment 2. Option C (62% reduction) was the most selected option for 2019 and option D (72% reduction) was the most selected option for 2020.</p> <p>Public Comment - No respondents commented on this item.</p>

Table 13. Continued.

Issue	NCDMF	Southern Flounder Advisory Committee	MFC Committees	Public Comment
Sustainable harvest, management carried forward and Amendment 3	<p>Current management measures, including size limits, the recreational bag limit, minimum mesh size for gill nets and the pound net escape panels, the number gill net fishing days and amount of yardage allowed in various areas of the state, and minimum distance requirements between gill net and pound nets, will be carried forward in Amendment 2.</p> <p>Amendment 3 will continue to be developed with more robust management strategies.</p>	Supports NCDMF recommendation that Amendment 3 will continue to be developed with more robust management strategies	<p>Southern – No recommendation</p> <p>Northern – Supports NCDMF recommendation</p> <p>Finfish – Supports NCDMF recommendation</p>	<p>Mail – No respondents commented on this item.</p> <p>Online – N/A</p> <p>Public Comment - No respondents commented on this item.</p>

XI. FIGURES

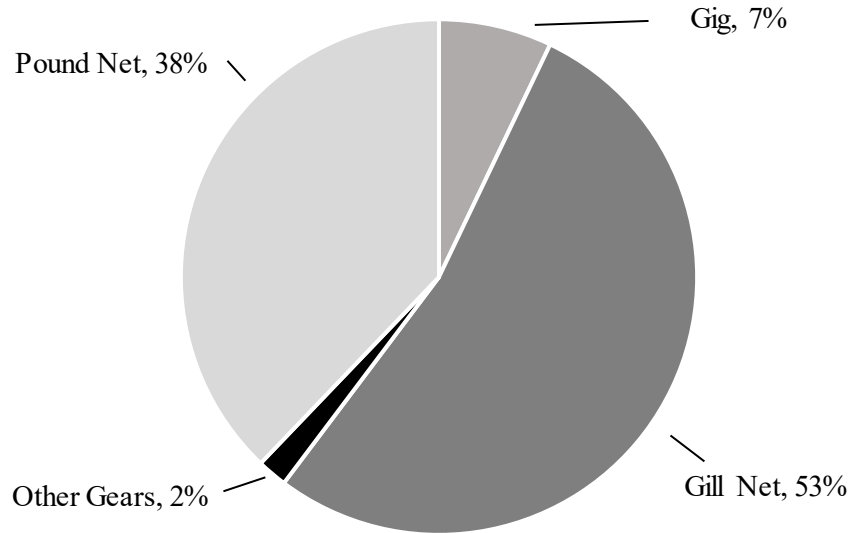


Figure 1. Contribution (pounds) to the North Carolina southern flounder commercial fishery total removals (observed landings and dead discards) by gear, 2008-2017. (Source: North Carolina Trip Ticket Program and North Carolina Estuarine Gill Net Observer Program).

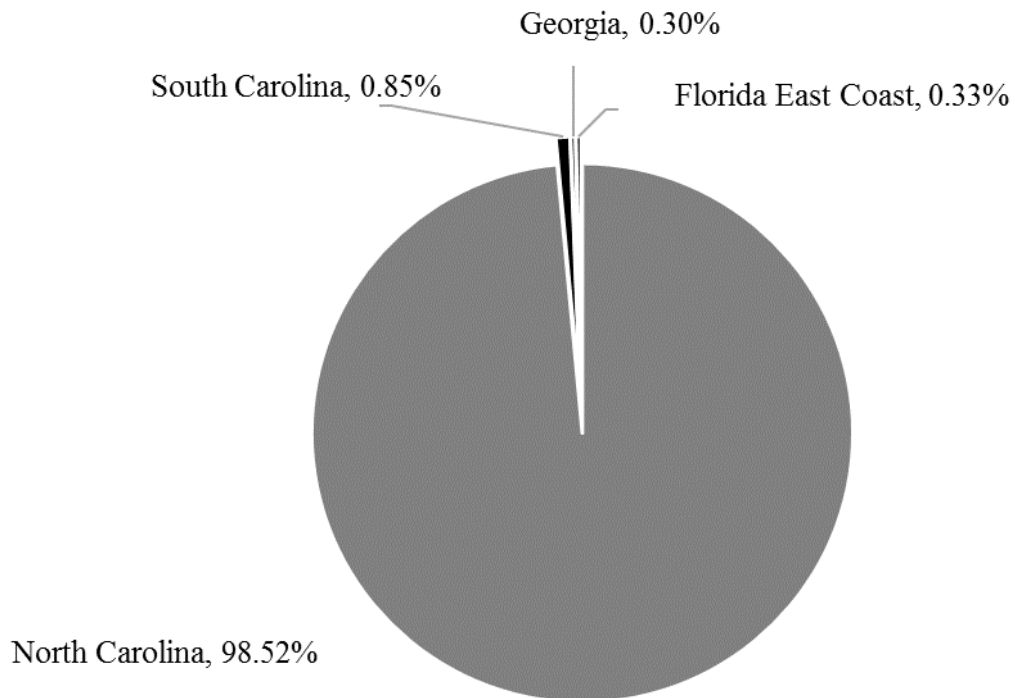


Figure 2. Average contribution to U.S. South Atlantic coast southern flounder commercial landings (pounds) by state, 1978-2017. (Source: NOAA Fisheries Annual Commercial Landing Statistics and North Carolina Trip Ticket Program).

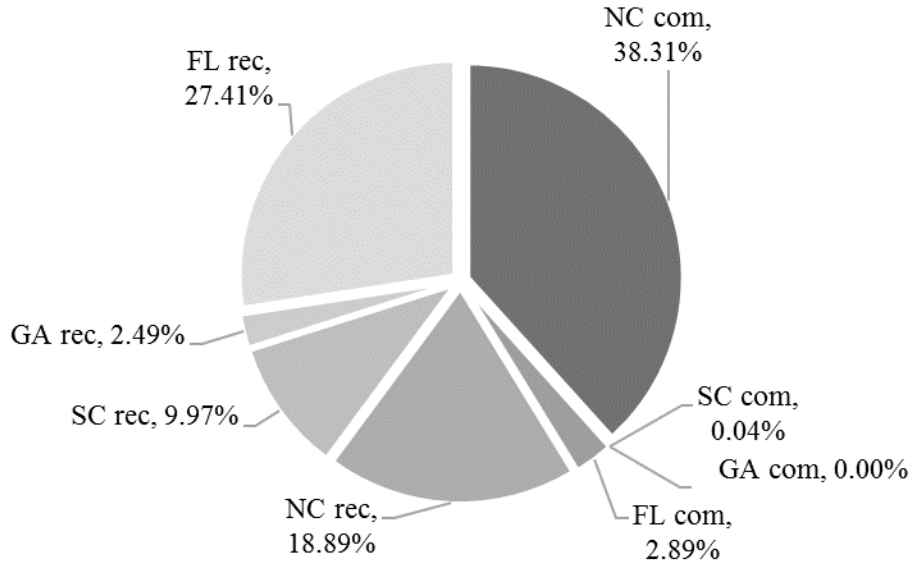


Figure 3. Average contribution to U.S. South Atlantic coast southern flounder commercial and recreational removals (observed harvest and dead discards) in pounds by state, 2008-2017. (Source: NOAA Fisheries Annual Commercial Landing Statistics, North Carolina Trip Ticket Program and the Marine Recreational Information Program).

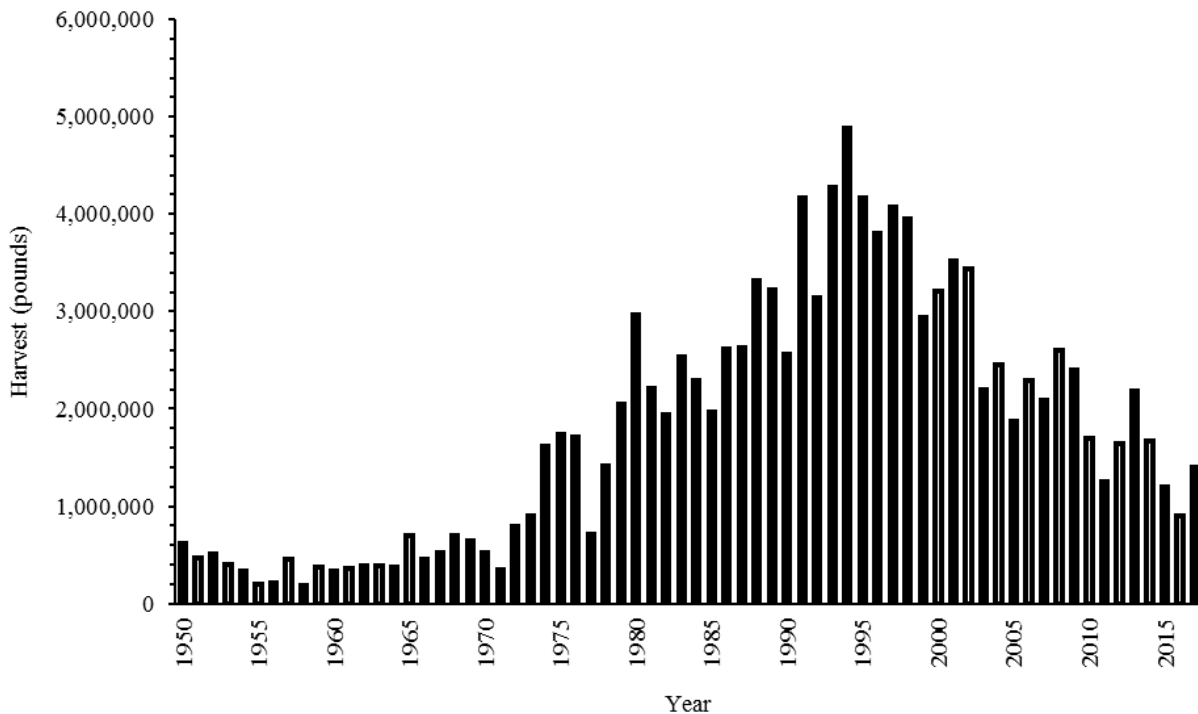


Figure 4. North Carolina annual southern flounder commercial harvest (pounds), 1950-2017. (Source: North Carolina Trip Ticket Program).

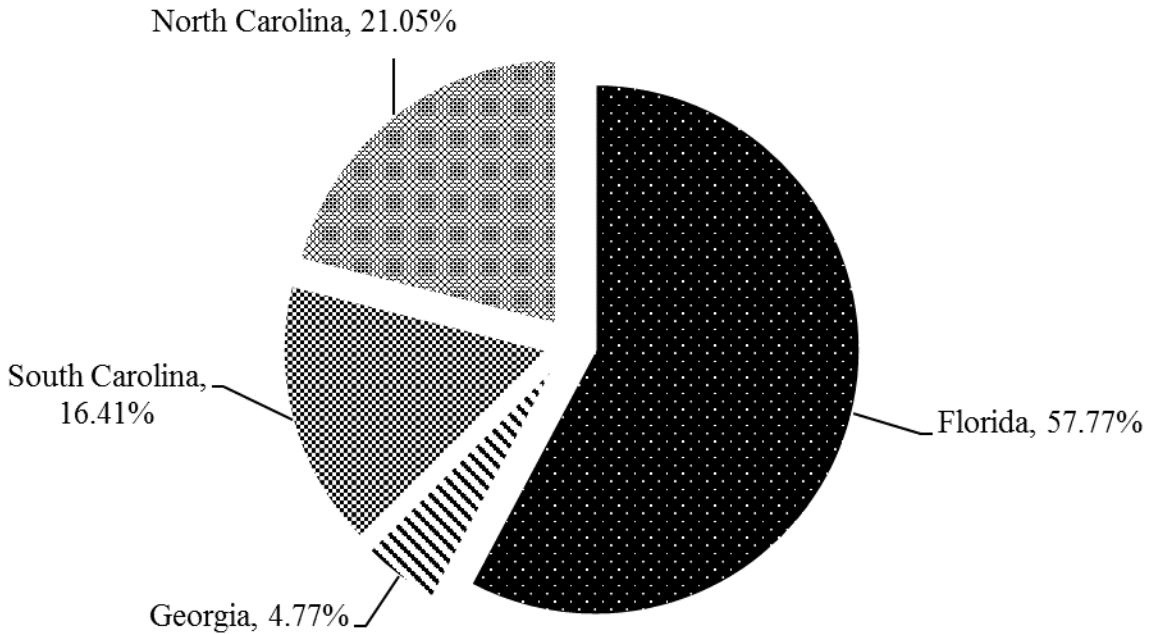


Figure 5. Average contribution to U.S. South Atlantic coast southern flounder recreational removals (observed harvest and dead discards; in pounds) by state, 1981-2017. (Source: Marine Recreational Information Program).

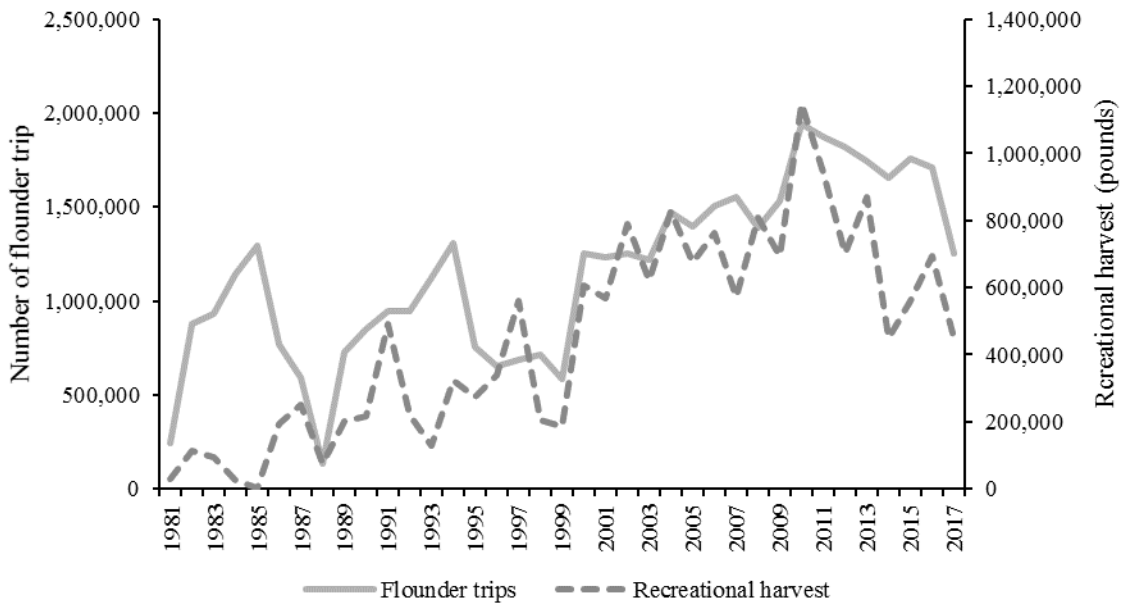


Figure 6. Recreational hook-and-line trips targeting flounder species in North Carolina, 1981-2017. (Source: Marine Recreational Information Program, targeted trips identified by angler interviews)

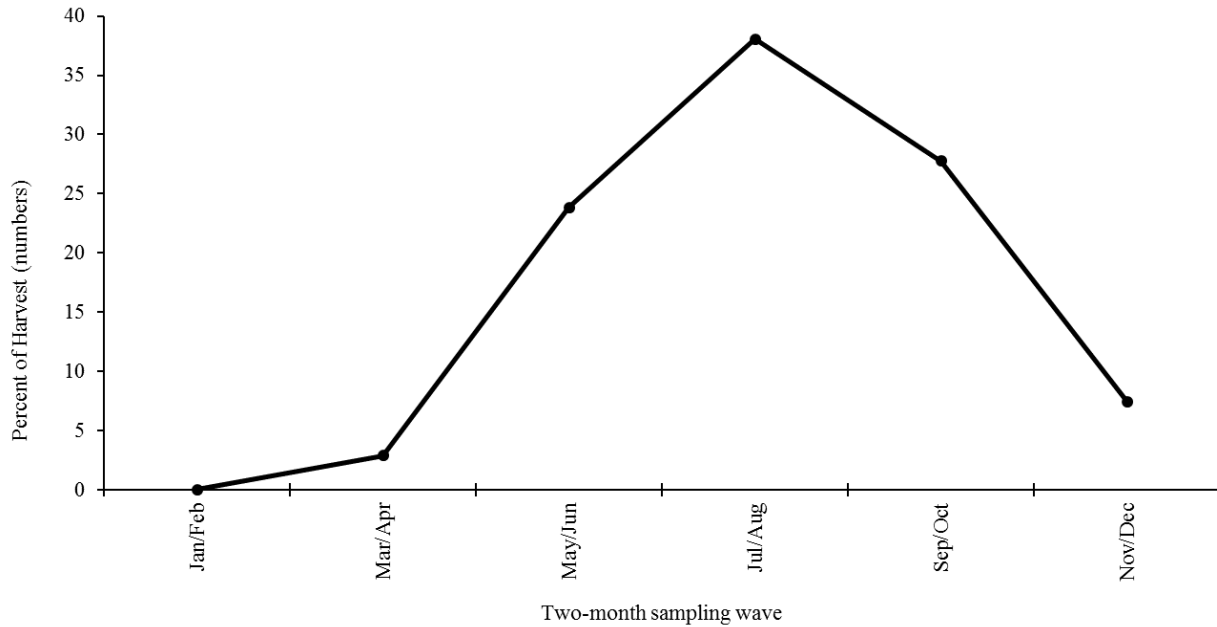


Figure 7. Average percent of recreational harvest (numbers of fish) of hook-and-line caught southern flounder in North Carolina by two-month wave, 1981-2017. (Source: Marine Recreational Information Program).

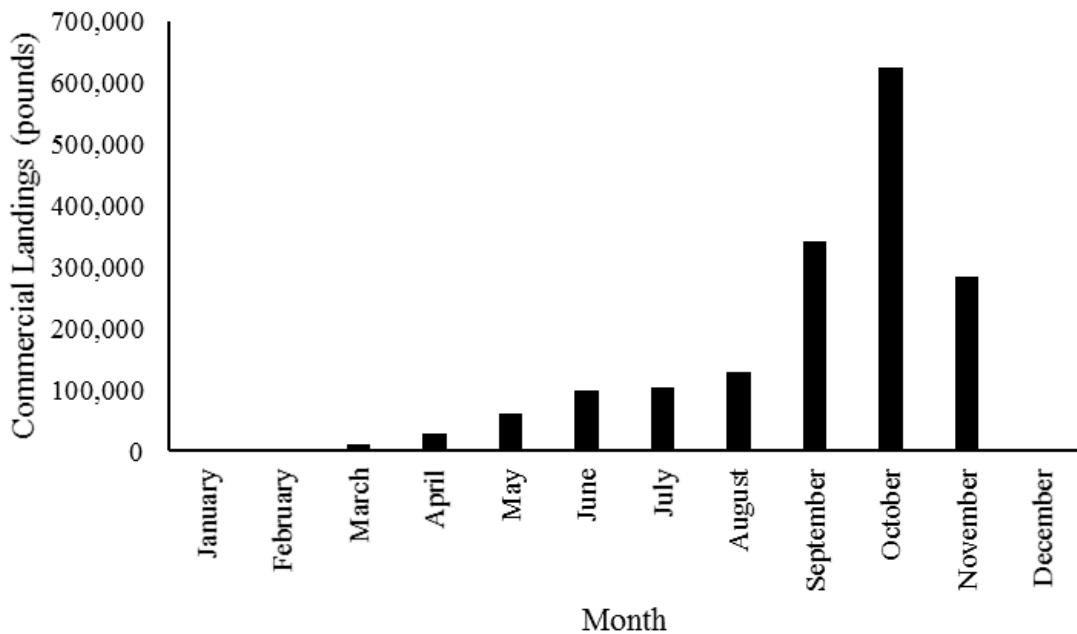


Figure 8. Average commercial southern flounder landings (pounds) by month in North Carolina, 2008-2017. (Source: North Carolina Trip Ticket Program).

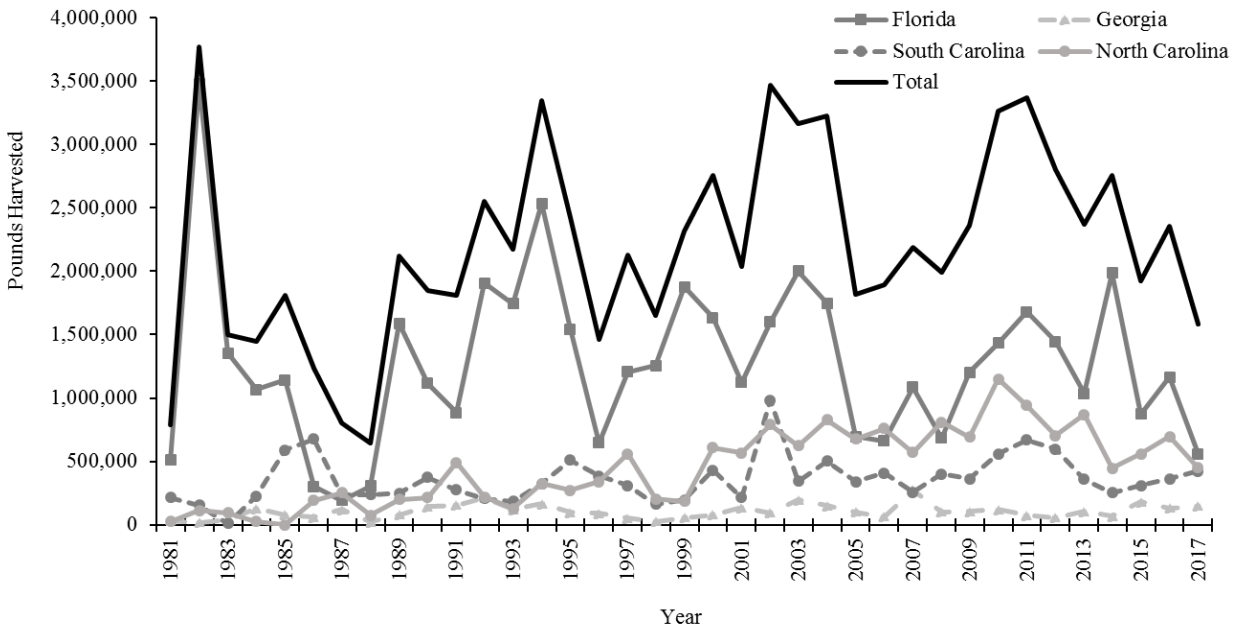


Figure 9. Recreational hook-and-line harvested pounds of southern flounder estimated through MRIP for North Carolina through Florida, 1981-2017. (Source: Marine Recreational Information Program).

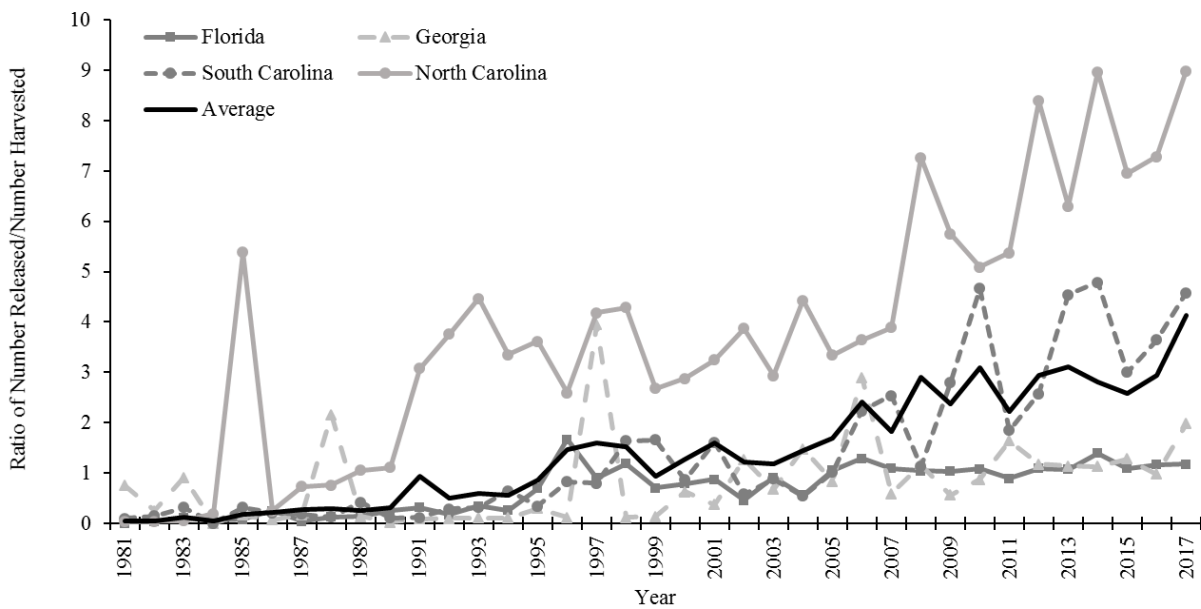


Figure 10. The ratio of released southern flounder compared to harvested southern flounder by number from recreational hook-and-line caught fish for North Carolina through Florida, 1981-2017. (Source: Marine Recreational Information Program).

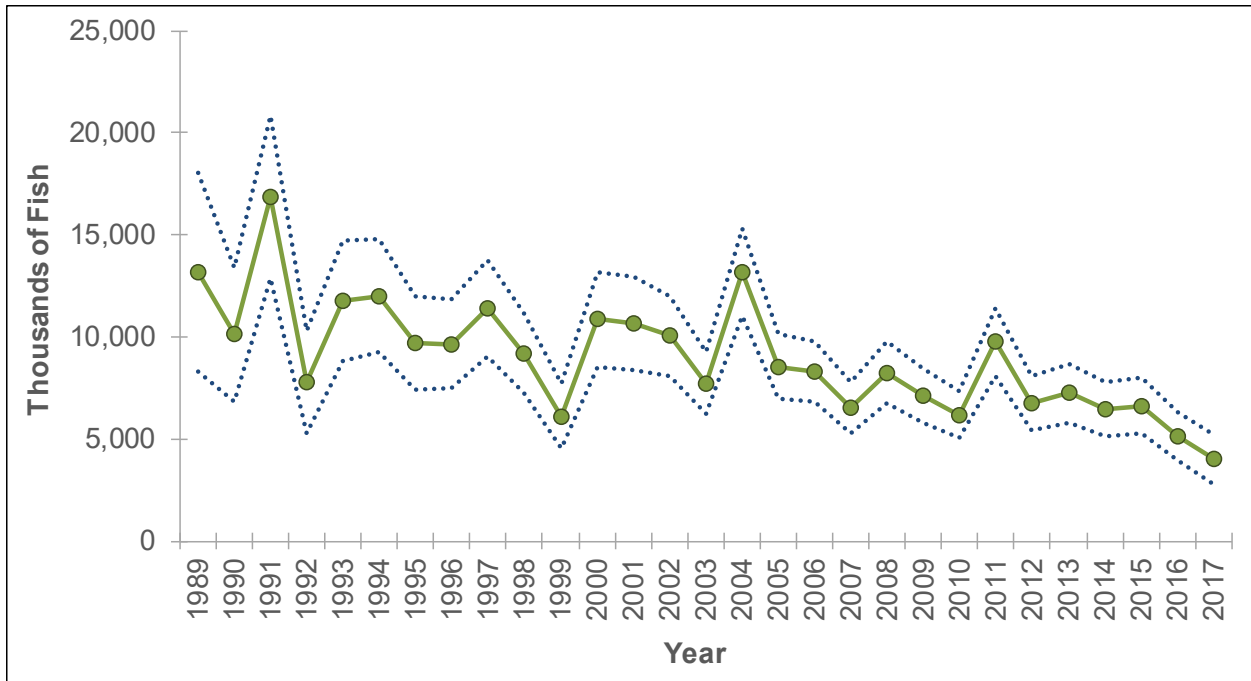


Figure 11. Predicted number of recruits (in thousands of fish) from the base run of the ASAP model, 1989-2017.

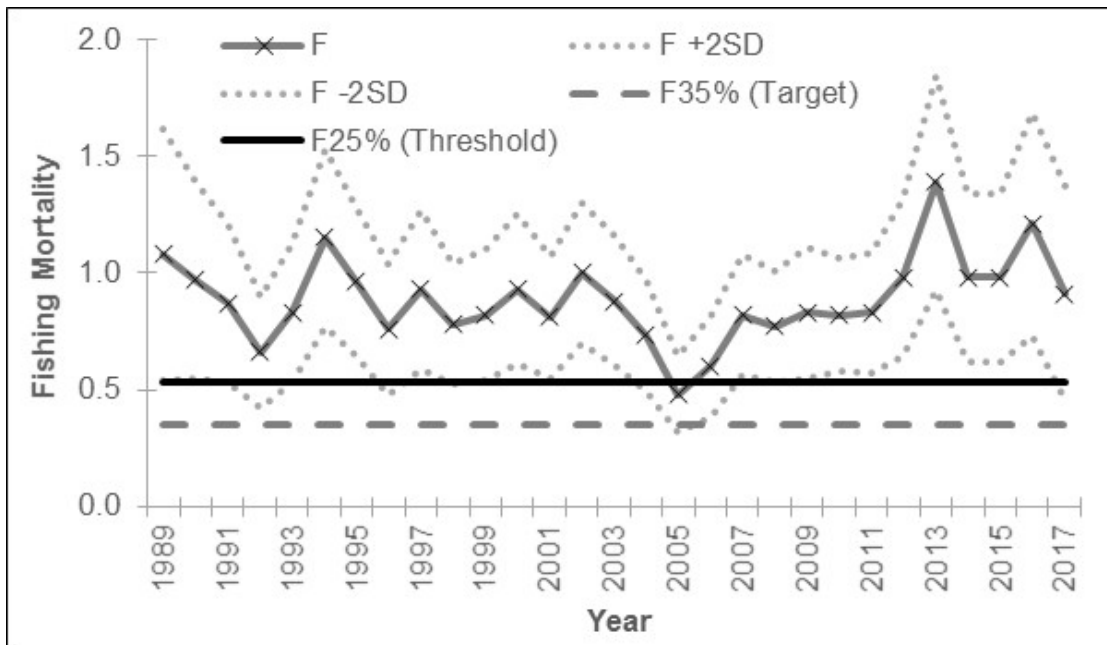


Figure 12. Estimated fishing mortality rates (numbers-weighted, ages 2–4) compared to established reference points, 1989–2017. (Source: Flowers et al. 2019).

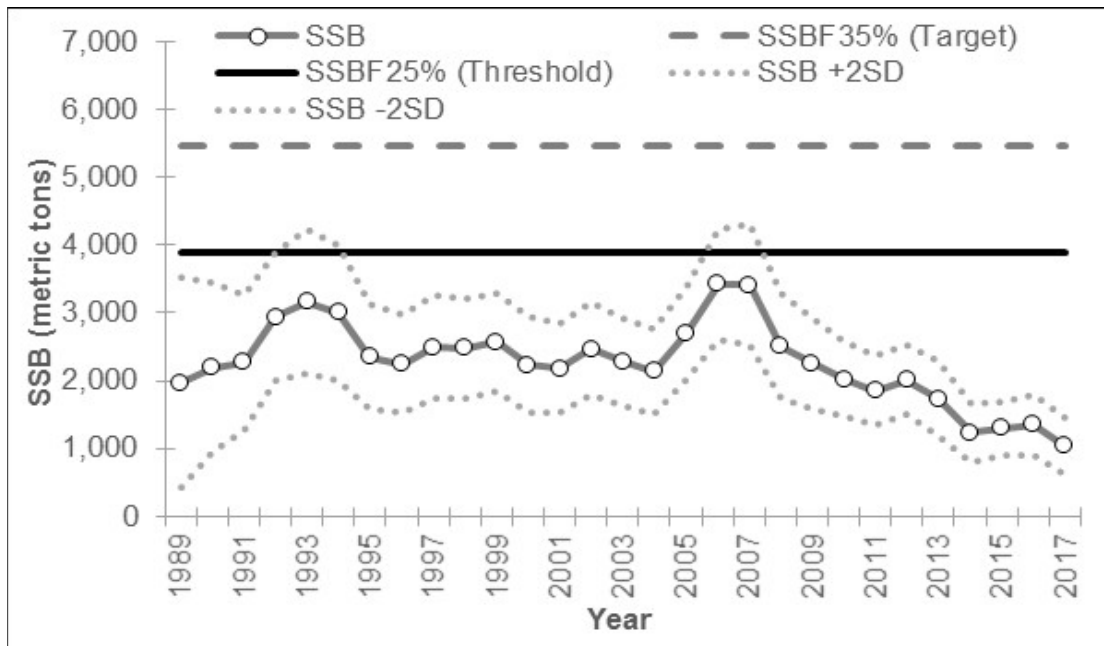


Figure 13. Estimated spawning stock biomass compared to established reference points, 1989–2017. (Source: Flowers et al. 2019).

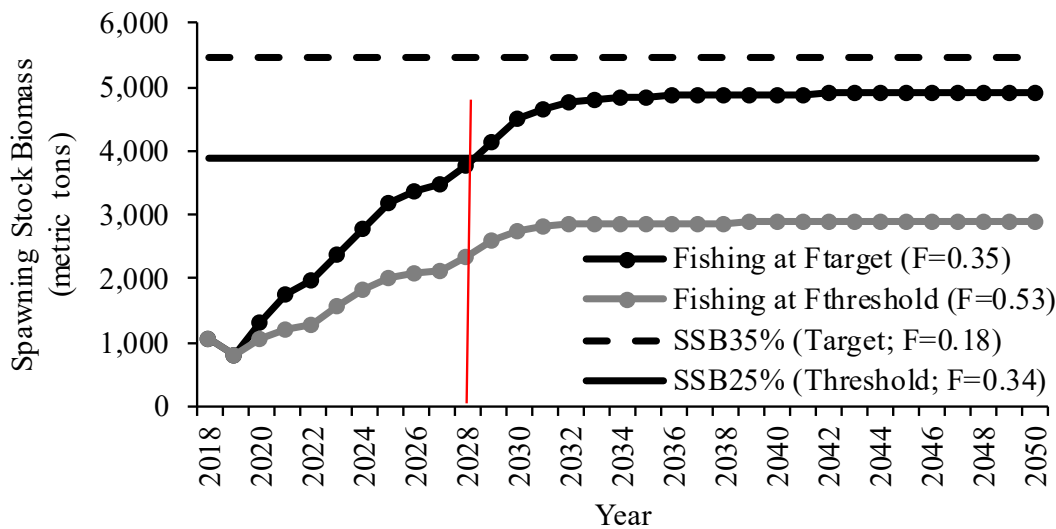


Figure 14. Projections of SSB related to fishing at a level to end overfishing in the required two-year time period. Fishing at $F_{\text{threshold}}$ equates to a 31% reduction in total removals, while Fishing at F_{target} equates to a 51% reduction in total removals. (Note: SSB does not rebuild within required 10-year time period; Source: Flowers et al. 2019).

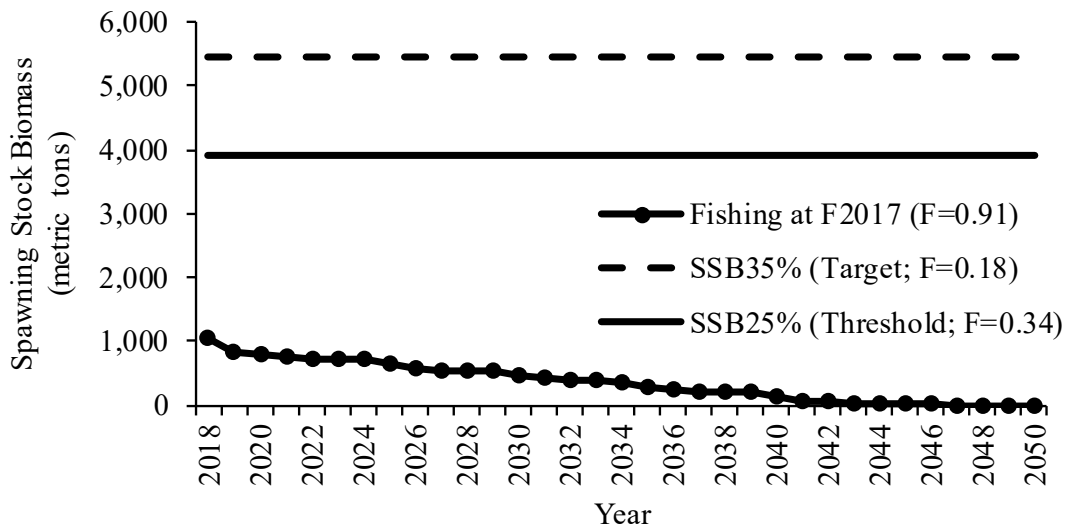


Figure 15. Predicted future spawning stock biomass (metric tons) assuming fishing at recent levels ($F_{2017}=0.91$) and continuing decline in recruitment. (Source: Flowers et al. 2019).

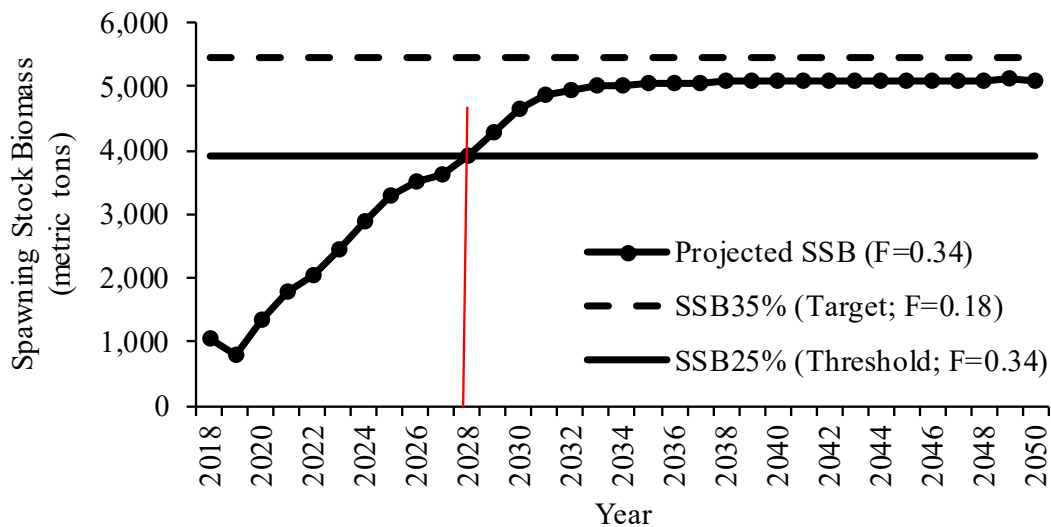


Figure 16. Predicted future spawning stock biomass (metric tons) assuming the fishing mortality value ($F_{25\%} = 0.34$; 52% reduction in total removals) necessary to end the overfished status ($SSB_{\text{Threshold}}$) by 2028. (Source: Flowers et al. 2019)

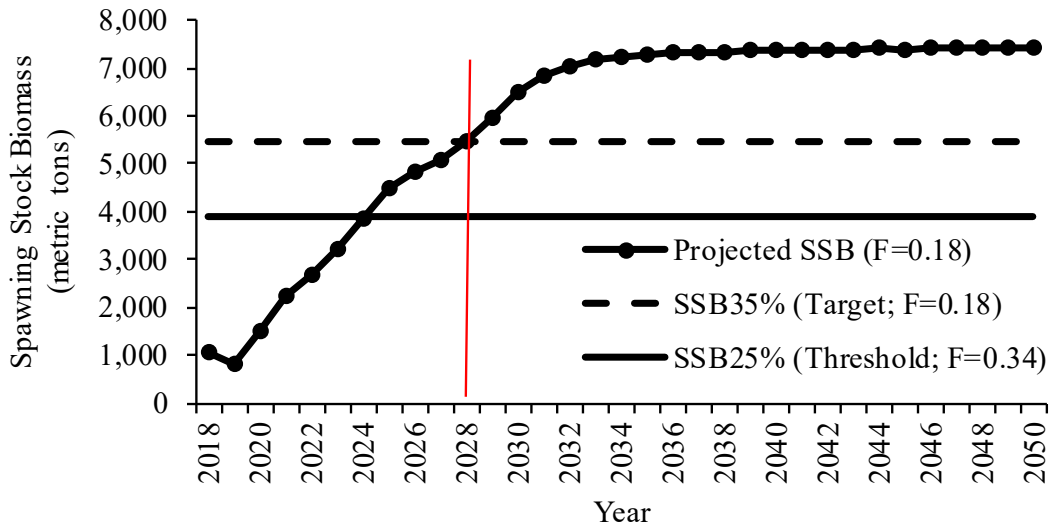


Figure 17. Predicted future spawning stock biomass (metric tons) assuming the fishing mortality value ($F_{35\%} = 0.18$; 72% reduction in total removals) necessary to reach the SSB_{Target} by 2028. (Source: Flowers et al. 2019).

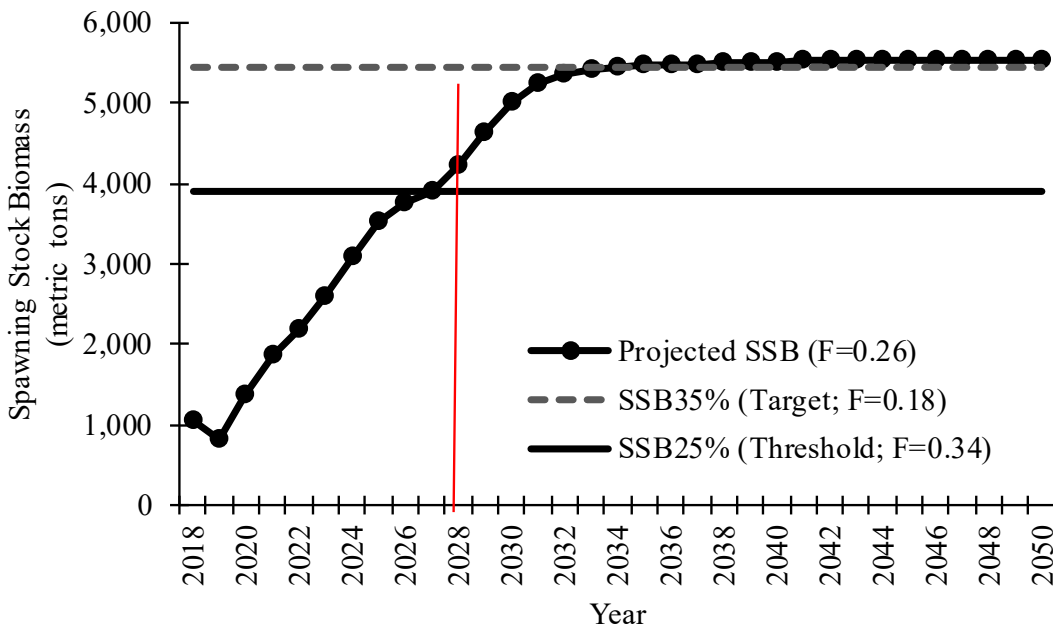


Figure 18. Predicted future spawning stock biomass (metric tons) assuming the fishing mortality value ($F = 0.26$; 62% reduction in total removals) necessary to reach between the SSB_{Target} and $SSB_{Threshold}$ by 2028.

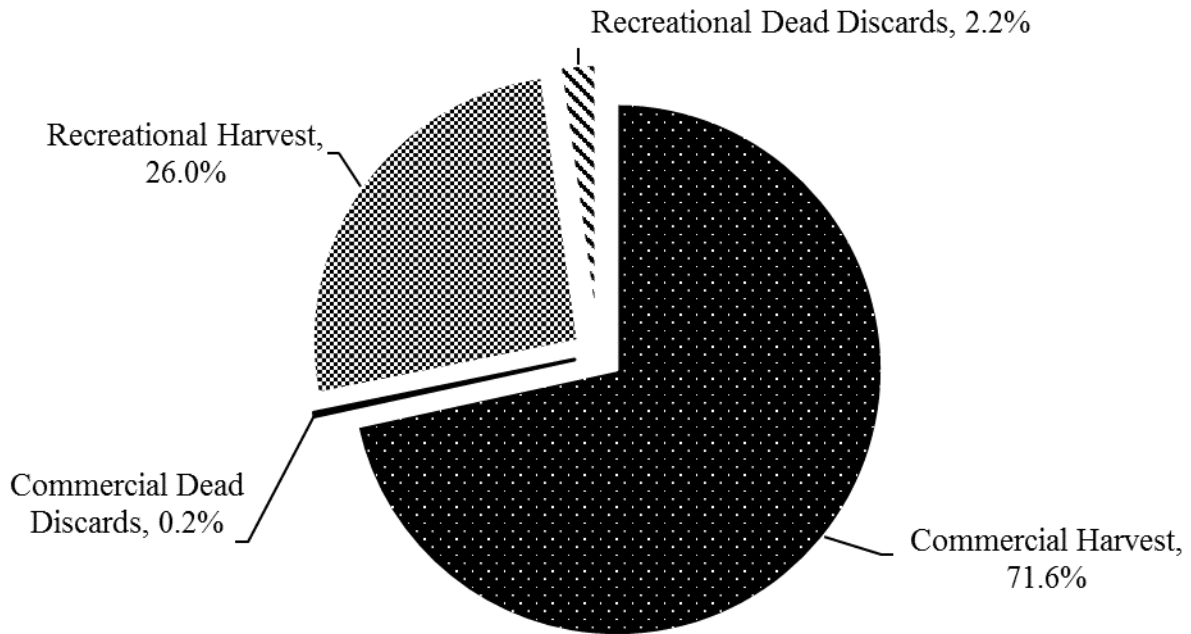


Figure 19. Breakdown of the total removals (observed harvest and dead discards) in % of pounds for the commercial and recreational (hook-and-line and gig) fisheries in North Carolina, 2017. (Source: North Carolina Trip Ticket Program and Marine Recreational Information Program).

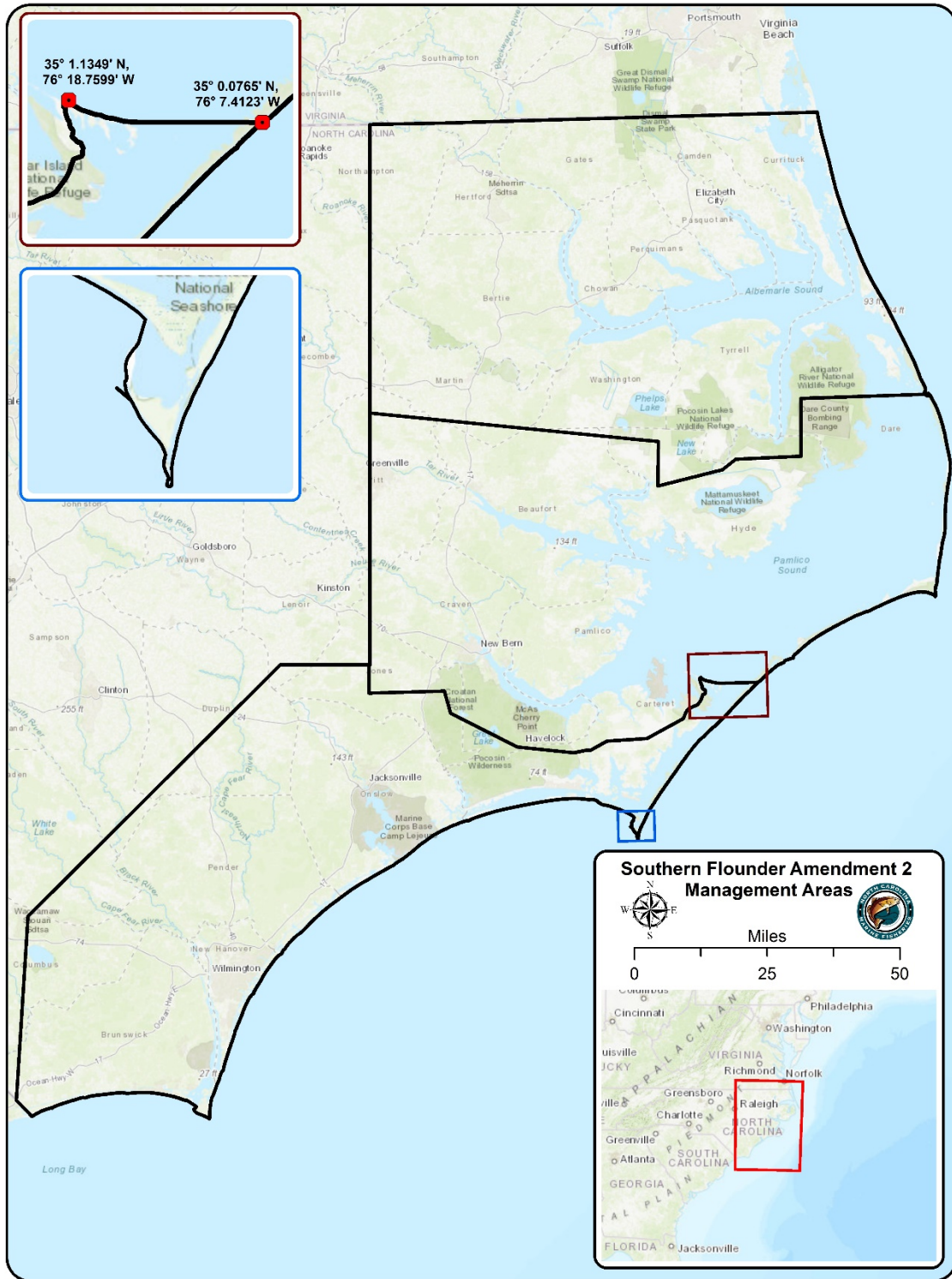


Figure 20. Southern Flounder Amendment 2 management areas for the commercial fishery, 2019.

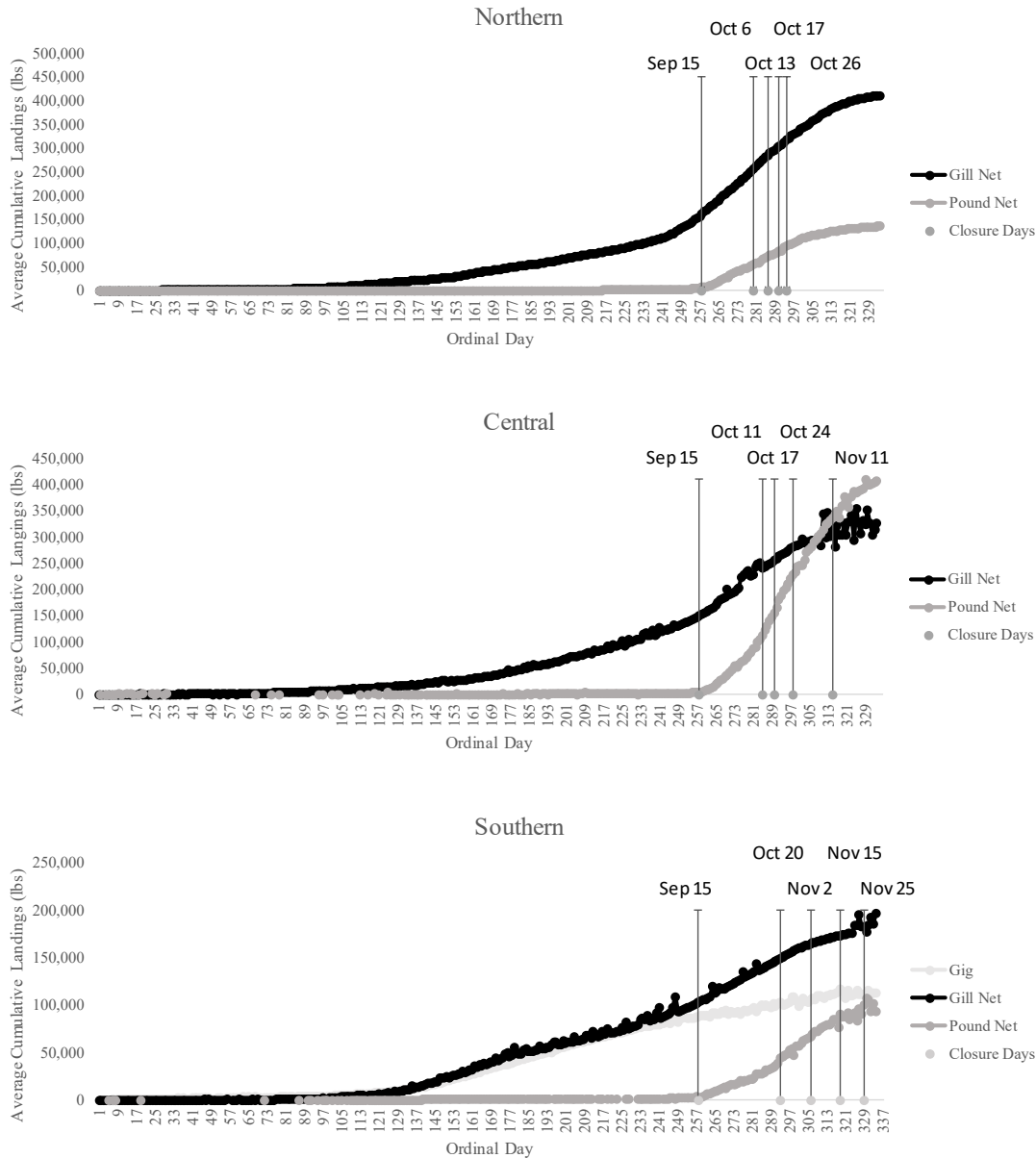


Figure 21. Cumulative commercial landings of the North Carolina southern flounder fishery in three proposed management areas by major gear type and proposed season needed to meet the threshold and target rebuilding reductions. (Source: North Carolina Trip Ticket Program). ***First vertical line indicates the opening date of Sept. 15, the second vertical line indicates the date of closure based on the overfished target (72%), the third vertical line indicates the date of closure based between the threshold and target (62%), the fourth vertical line indicates the date of closure based on the overfished threshold (52%), and the fifth vertical line indicates the date of closure based on the overfishing threshold (31%).** Note: Monitoring, reporting, and closure requirements identified through the NCDMF’s sea turtle and Atlantic sturgeon Incidental Take Permits will remain in effect and may impact dates identified in this figure.

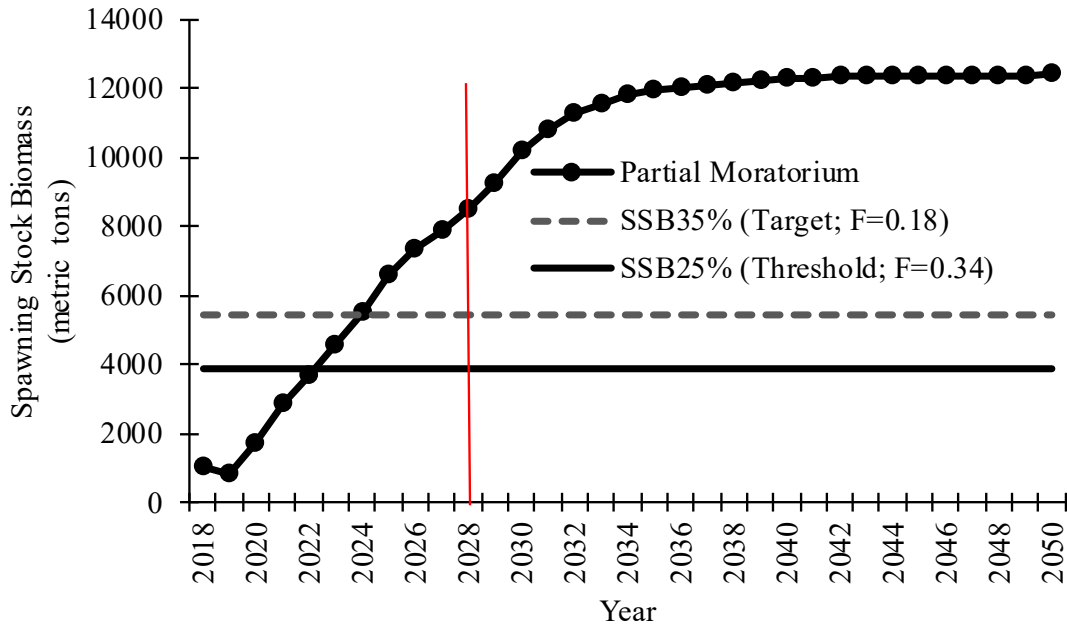


Figure 22. Predicted future spawning stock biomass (metric tons) based on a partial moratorium. This projection is for a coastwide moratorium with the only removals coming from the commercial shrimp trawl fleet.

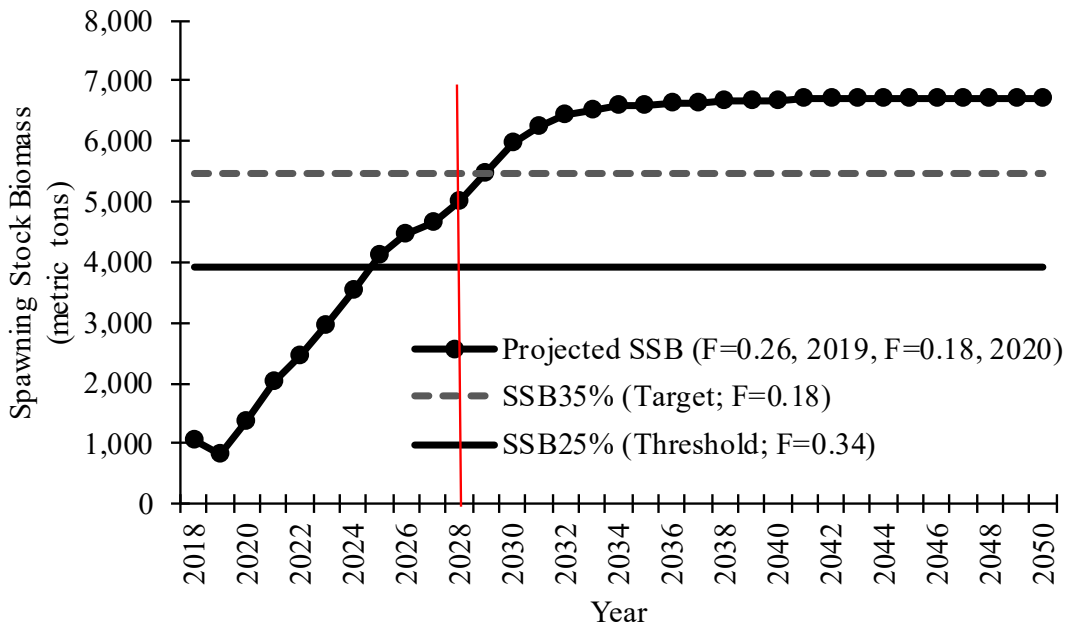


Figure 23. Predicted future spawning stock biomass (metric tons) based on the Department of Environmental Quality/NCDMF recommendation for a 62% reduction in 2019 ($F=0.26$), and a 72% reduction beginning in 2020 ($F=0.18$).



ROY COOPER
Governor

MICHAEL S. REGAN
Secretary

STEPHEN W. MURPHEY
Director

February 10, 2020

MEMORANDUM

TO: N.C. Marine Fisheries Commission

FROM: Chris Stewart, Kimberlee Harding, and Jason Rock, Shrimp Fishery Management Plan Co-Leads

SUBJECT: Shrimp Fishery Management Plan Amendment 2

Issue

Review the draft goal and objectives for Amendment 2 to the Shrimp Fishery Management Plan (FMP) and discuss the potential management strategies to be considered during its development.

Actions Needed

- I. Vote on approval of the Shrimp FMP Amendment 2 goal and objectives
- II. Discuss and provide input on the potential management strategies to be considered during development of Amendment 2.

I. Goal and Objectives

The division is now proceeding with development of Amendment 2 to the Shrimp FMP to further examine potential management strategies to reduce bycatch of non-target species in the shrimp trawl fishery and potential changes to existing shrimp management strategies that were adopted in the 2006 FMP, 2015 Amendment 1, and 2018 Revision to Amendment 1. The next step in the FMP process is for the Marine Fisheries Commission (MFC) to vote on adoption of the goal and objectives. The division is continuing to develop the first draft of Amendment 2. The Shrimp FMP Advisory Committee will then assist the division with development of Amendment 2, resulting in a second draft that will be brought to the MFC for its consideration. The draft goal and objectives are:

Goal:

Manage the shrimp fishery to provide adequate resource protection, optimize long-term harvest, and minimize ecosystem impacts.

Objectives:

- Reduce bycatch of non-target species of finfish and crustaceans, as well as protected, threatened, and endangered species.
- Promote the restoration, enhancement, and protection of habitat and environmental quality in a manner consistent with the Coastal Habitat Protection Plan.
- Develop a strategy through the Coastal Habitat Protection Plan to review current nursery areas and to identify and evaluate potential areas suitable for designation.
- Use biological, environmental, habitat, fishery, social, and economic data needed to effectively monitor and manage the shrimp fishery and its ecosystem impacts (i.e., bycatch, habitat degradation).
- Promote implementation of research and education programs designed to improve stakeholder and the general public's understanding of shrimp trawl bycatch impacts on fish population dynamics.

II. Potential Management Strategies

Based on the draft goal and objectives the MFC will vote on at its February meeting, the division identified potential management strategies for the shrimp fishery. The division held a scoping period to solicit public input about these potential management strategies and any additional strategies suggested by the public. The division is now seeking input from the MFC on the potential management strategies to be considered during development of Amendment 2.

Potential Shrimp FMP Amendment 2 Management Strategies

Bycatch Reduction	Shrimp Management	Habitat
<ul style="list-style-type: none">• Additional day(s) of week closure• Develop closed seasons in internal coastal waters (estuarine) and the Atlantic Ocean (0-3 miles)• Headrope reductions• Close additional areas to shrimp trawling (bycatch hotspots, Intracoastal Waterway, Special Secondary Nursery Areas)• Develop migration corridors closed to shrimp trawling	<ul style="list-style-type: none">• Evaluate the current shrimp management strategies that determine season openings in Special Secondary Nursery Areas based on shrimp count size and finfish abundance within set dates	<ul style="list-style-type: none">• Close additional critical fish habitat areas to shrimp trawling

Further explanation of these potential management strategies, as well as the proposed timeline for Amendment 2, can be found in the

[Shrimp FMP Amendment 2 Scoping Document.](#)

Beyond the current management strategies used to manage the shrimp fishery, the division collects biological data to provide long-term indices of abundance for several ecologically and economically important species. This data has previously been used to characterize and designate nursery areas. Additionally, this data is being used by several ongoing projects funded by the Coastal Recreational Fishing License Fund (CRFL) to evaluate the current productivity and suitability of NC's designated estuarine nursery areas and should aid in the evaluation of future nursery areas. This data will also be used to quantify the variability of juvenile abundance and suitable habitat in nursery areas for ecologically and economically important species.

Scoping Period

In support of the recent changes to the FMP process, the division held its public scoping period for Amendment 2 from Jan. 7 through Jan. 21, 2020. In addition to accepting comments through an online questionnaire and U.S. mail, the division held three in-person meetings in Washington, Wilmington, and Morehead City. The division received 19 comments from attendees during the meetings, 229 online comments, and six comments through U.S. mail. Comments were primarily focused on one or more of the potential management measures under the bycatch reduction management strategy, which included additional effort controls and area closures as well as continued industry collaboration in developing and testing new bycatch reduction device configurations. Additional potential management strategies identified focused on shrimp management and habitat, which included developing a live bait shrimp permit and addressing water quality concerns.

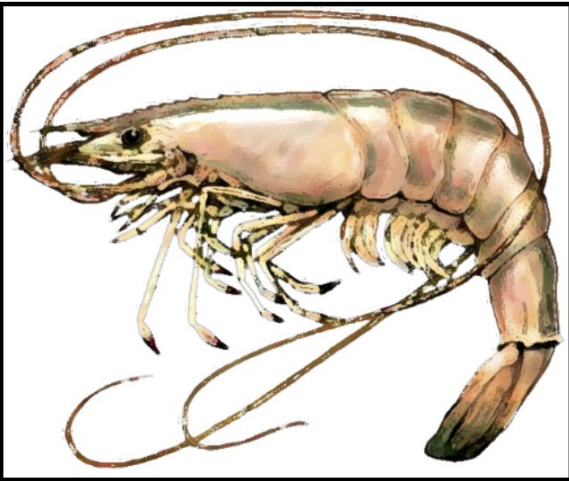
Scoping Document



Management Strategies for Amendment 2 to the Shrimp Fishery Management Plan



December 2019



The N.C. Division of Marine Fisheries seeks your input on management strategies for the Shrimp Fishery Management Plan.

A scoping period for public comment begins
Jan. 7, 2020 and ends Jan. 21, 2020.

Comments must be received/postmarked by
5 p.m. (EST) on Jan. 21, 2020.

Scoping Meetings

DMF staff will provide information about Amendment 2 to the Shrimp Fishery Management Plan (FMP) and will be available for questions from the public. A public comment period will follow.

Tuesday, Jan. 7, 2020 at 6 p.m. to 8 p.m.

N.C. Department of Environmental Quality
943 Washington Square Mall, Highway 17
Washington, NC 27889

Thursday, Jan. 9, 2020 at 6 p.m. to 8 p.m.

N.C. Department of Environmental Quality
Wilmington Regional Office
127 Cardinal Drive Extension
Wilmington, NC 28405

Monday, Jan. 13, 2020 at 6 p.m. to 8 p.m.

Central District Office
5285 Highway 70 West
Morehead City, NC 28557

Can't attend but want to submit comments? Here's how!

Written comments can be submitted
by online form or by U.S. mail.
Comments sent by U.S. mail must be
postmarked by Jan. 21, 2020 to be
accepted. **The division will not accept
public comment through email.**

To comment by online form:

The online form can be accessed
through the Shrimp Amendment
Information Page [http://
portal.ncdenr.org/web/mf/shrimp-
fmp-amendment-2-topic](http://portal.ncdenr.org/web/mf/shrimp-fmp-amendment-2-topic). Please use
the link at the bottom of the
information page.

To comment by U.S. mail, please submit written comments to:

N.C. Division of Marine Fisheries
Shrimp FMP Amendment 2
Scoping Comments
P.O. Box 769
Morehead City, NC 28557

Questions about the shrimp stock, fishery, or Amendment 2 to the Shrimp Fishery Management Plan?



Contact the leads:

Chris Stewart

Fisheries Biologist, Wilmington

Shrimp lead

910-796-7370

Kimberlee Harding

Fisheries Biologist, Washington

Shrimp co-lead

252-948-3875

Jason Rock

Fisheries Biologist, Morehead City

Shrimp co-lead

252-808-8091

Questions about the FMP Process?

Kathy Rawls

Fisheries Management Section Chief, Morehead City

252-808-8074

Catherine Blum

Fishery Management Plan and Rulemaking Coordinator, Morehead City

252-808-8014

Purpose of the Scoping Document

The purpose of this document is to inform the public the review of the Shrimp FMP is underway and to provide an opportunity for the public to comment on identified management strategies or identify other relevant strategies in the management of the shrimp fishery. Input received at the start of the FMP review process may shape the final amendment and its management measures (solutions). To help focus the input received from the public, this document provides an overview of initially identified strategies, as well as background information on the fishery and the stock. A series of questions about each strategy is also provided for the public to consider when thinking about the strategies; in general: "What should shrimp management be? What changes are needed?"

Additional management strategies may be considered in Amendment 2 dependent on statutory requirements, available data, research needs, and the degree of impact the management strategy would have and how effective the solution would be. If the division determines a management strategy raised during the scoping period might have significant impacts on the species, additional examination of the strategy may be undertaken in the development of the FMP.

Scoping provides an opportunity for the public to comment on strategies identified by the division as well as any additional relevant strategies for possible consideration for the development of the FMP.

What is Scoping?

Scoping is the first stage of the process to determine the appropriate contents of an FMP. Scoping serves many purposes including: (1) to provide notice to the public that a formal review of the FMP is underway by the N.C. Division of Marine Fisheries (DMF or division), (2) inform the public of the stock status of the species (stock status is not available for shrimp as they are considered an annual crop), (3) solicit stakeholder input on a list of strategies identified by the DMF and identify other relevant strategies that may need to be addressed, and (4) recruit potential advisors to serve on the advisory committee (AC) for the FMP that is appointed by the N.C. Marine Fisheries Commission (MFC). The public will have more opportunity to provide comments as the amendment is developed; however, scoping is the first and best opportunity to provide input on potential strategies for DMF to consider before an amendment is developed.

FISHERY MANAGEMENT PLANS- A TIERED APPROACH

Fishery Management



Management PLANS are implemented to achieve specified management goals for a fishery, such as sustainable harvest, and include background information, data analyses, fishery habitat and water quality considerations consistent with Coastal Habitat Protection Plans, research recommendations, and management strategies.

Management STRATEGIES are adopted to help reach the goal and objectives of the plan. They are the sum of all the management measures selected to achieve the biological, ecological, economic, and social objectives of the fishery.

Management MEASURES are the actions implemented to help control the fishery as stipulated in the management strategies.

FMP Timeline

Process Step	Date
Public scoping meetings	January 7-21, 2020
DMF prepares draft Amendment 2	January – June 2020
FMP AC and DMF work together to further develop Amendment 2	July – September 2020
DMF selects initial management recommendations	October 2020
MFC votes to send draft FMP for public and AC review	November 2020
Public comment and AC meetings for review of draft Amendment 2	December 2020 – January 2021
MFC selects preferred management options	February 2021
NC DEQ Secretary and legislature review draft FMP	March – April 2021
MFC votes on final adoption of Amendment 2	May 2021

Developing an amendment

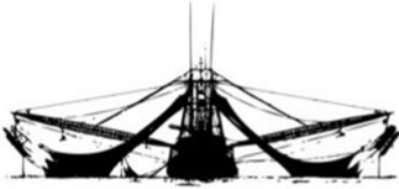
Annually, the DMF reviews all species for which there are FMPs for North Carolina and provides an update to the MFC. This review includes any recommended changes to the schedule for FMP review and amendment development. Per N.C. law, any changes to the schedule must be approved by the N.C. Department of Environmental Quality (N.C. DEQ) Secretary.

When a plan is opened for review, the first step of the formal amendment process is a scoping period. After relevant strategies have been identified by the DMF, the public (during the scoping period), and by the MFC, the division's plan development team (PDT) develops a preliminary draft amendment. The first draft will be completed before the FMP AC is appointed. Once appointed, the AC will meet with the PDT at a series of workshops to assist in developing the FMP by further refining the draft amendment.

Upon completion of this draft, the amendment is taken to the MFC for approval to go out for public comment and review by the MFC's standing and regional ACs. Following consideration of public and AC comment, the Commission selects its preferred management measures for Amendment 2. Next, draft Amendment 2 goes to the NC DEQ Secretary and the legislature for review before the MFC votes on final approval of the amendment.

Why is this happening now?

The 2019 N.C. Fishery Management Plan (FMP) Review Schedule shows the review of the Shrimp FMP is underway. To begin the development of the Shrimp FMP Amendment 2, the division is examining management strategies to further reduce bycatch of non-target species in the shrimp trawl fishery and potential changes to existing shrimp management strategies that were adopted in the 2006 FMP, 2015 Amendment 1, and 2018 Revision to Amendment 1. The division is also taking into consideration input received from the Marine Fisheries Commission through motions passed at its August 2018 and February 2019 meetings regarding general areas of focus and possible goals and objectives for Amendment 2.



Amendment 2 Background

Shrimp in North Carolina

There are three primary shrimp species (brown, pink, and white) that are harvested recreationally and commercially in North Carolina. In 2018, shrimp was the most economically important commercial fishery in North Carolina with a total ex-vessel revenue of \$20,047,148. Shrimp are harvested throughout the state by otter trawls, skimmer trawls, channel nets, seine nets, cast nets, shrimp pots, and pounds. In 2018, 78% of commercial shrimp landings were harvested in estuarine waters and 18% were harvested in the Atlantic Ocean (less than 3 miles) by otter trawls. Commercial landings have averaged 7,345,451 pounds a year from 1994 to 2018 (Figure 1). Total landings from the recreational fishery are unknown; however, estimates from the recreational cast net and seine survey indicate that 168,010 trips were made from 2012 to 2018.

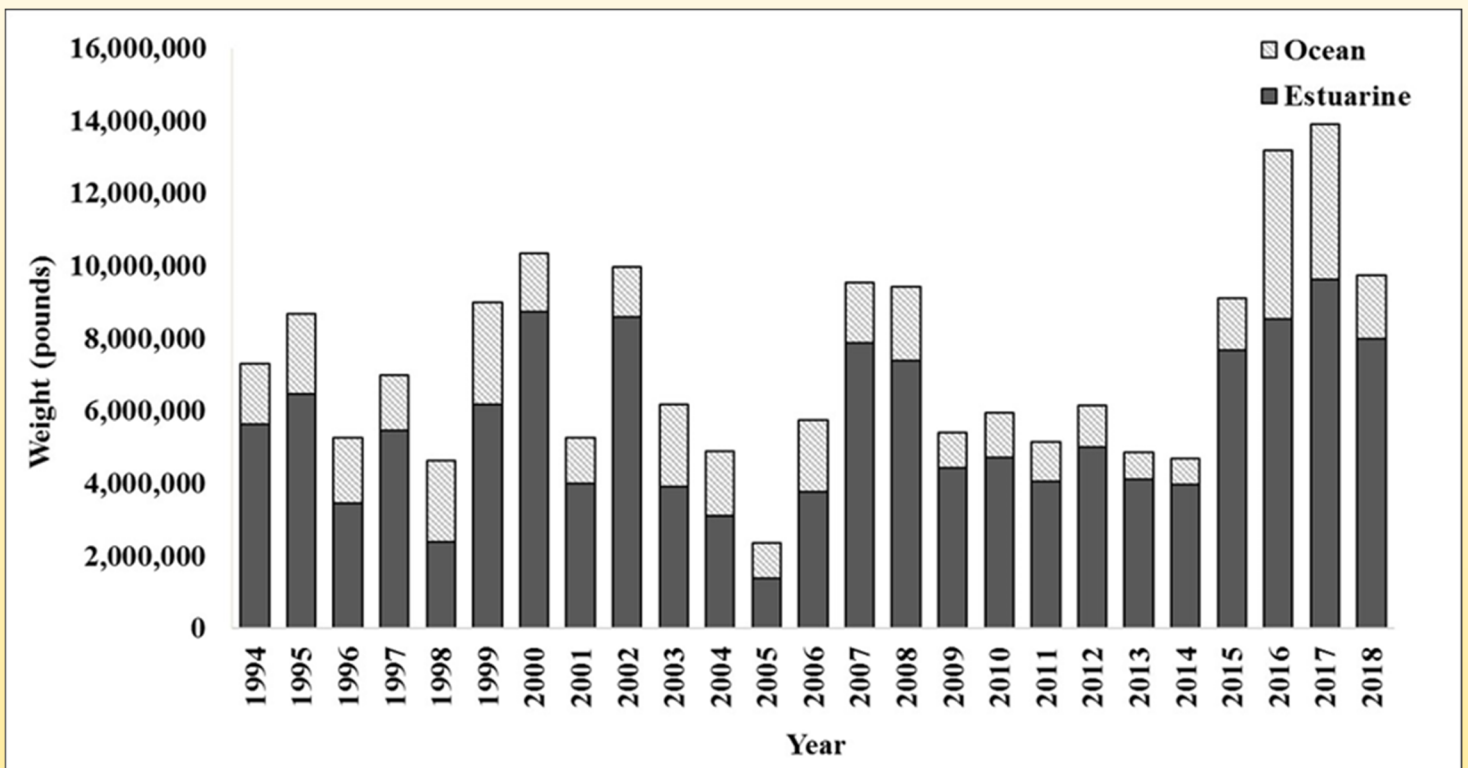


Figure 1. Annual commercial shrimp landings (pounds, heads-on) by area from all three shrimp species combined in North Carolina, 1994-2018. (Source: North Carolina Trip Ticket Program).

Stock Status

Stock status is not available for shrimp as they are considered an annual crop. Shrimp population size is heavily influenced by environmental conditions, and while fishing reduces the population over the season, fishing mortality is not believed to have any impact on subsequent year class strength unless the spawning stock is reduced below a minimum threshold. Because of their high reproductive output and migratory behavior, all three species are capable of rebounding from a very low population size in one year to a large population size in the next, provided environmental conditions are favorable.

Estimates of population size are not available and there are no juvenile or adult indices of abundance for white and pink shrimp in North Carolina; however, estimates of brown shrimp recruitment are available. The only other data available for shrimp are commercial landings and associated effort from the N.C. Trip Ticket Program. Since the fishery is considered an annual crop and fished near maximum levels, annual landings are likely a good indication of relative abundance. Annual variations in landings are presumed to be due to a combination of prevailing environmental conditions, fishing effort, and market forces.

Annual crop species are short-lived and the annual abundance of the stock is a function of the strength of the incoming year class.



Amendment 2 Management Strategies

Bycatch Reduction

Effort Controls

Background

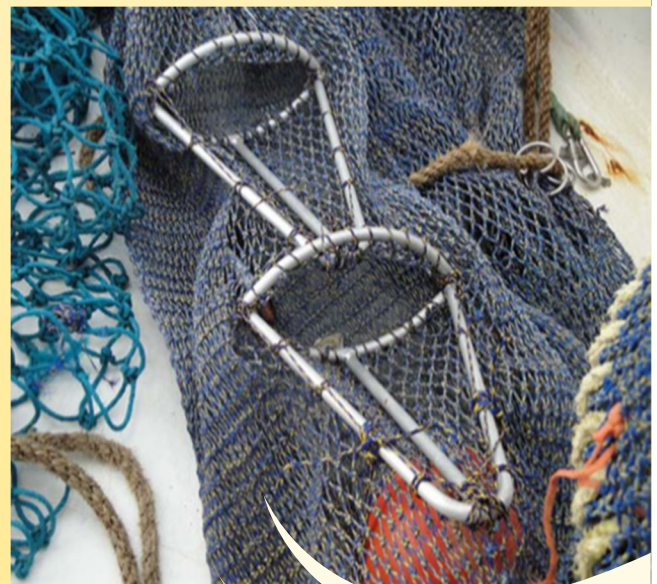
Bycatch is an important topic in fisheries management and marine conservation in the United States and around the world (NCDMF 2015). North Carolina became the first state to require the use of Bycatch Reduction Devices (BRDs) in all shrimp trawls in 1992. Many of the management strategies examined in Amendment 1 focused on limiting effort to reduce bycatch and could be considered again, or refined, they include:

Bycatch is defined as the portion of a catch taken incidentally to the targeted catch because of non-selectivity of the fishing gear to either species or size differences (ASMFC 1994).

- Additional day(s) of week closure
- Develop closed seasons in internal coastal waters (estuarine) and the Atlantic Ocean (0-3 miles)
- Headrope reductions

Questions for the Public

- Do you support additional day(s) of the week closures to reduce bycatch in internal coastal waters or Atlantic Ocean (0-3 miles)? If so, how many additional days?
- Should an additional day of the week closure in internal coastal waters be continuous with the current weekend closure (9:00 p.m. Friday through 5:00 p.m. Sunday) or should it be in the middle of the week (for example Tuesday or Thursday)?
- Do you support the use of closed seasons to reduce bycatch? If so, when should closed seasons be implemented?
 - Should there be closed seasons in internal coastal waters, the Atlantic Ocean, or both?
 - Should the seasons have static opening and closing dates?
 - Should the current season (August 16 to May 14) allowing special secondary nursery areas to be opened by proclamation be adjusted?
- Do you support reducing headrope lengths in shrimp trawls in internal coastal waters, the Atlantic Ocean, or both? If so, what maximum headrope length should be considered in each area?



Area Restrictions

Background

In the 1980s, Special Secondary Nursery Areas (SSNAs) were established to allow shrimp harvest to occur after most fish have migrated out of the bays. Many of these areas, such as portions of the Intracoastal Waterway, function as nursery areas and act as migration corridors. Corridors provide connectivity among various habitats and are critical to the dispersal of larvae and the overall health of the habitats they connect. Closing these migration corridors may help reduce bycatch of juvenile finfish and invertebrates as they migrate through estuarine bays toward coastal inlets.

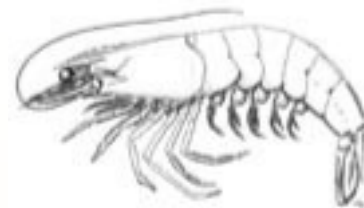
In areas closed to the harvest of shrimp, only cast nets are allowed but are limited to no more than four quarts (heads-on) or two and one-half quarts (heads-off) of shrimp per person per day. If additional areas are closed to shrimp trawling, increased catch limits and the use of alternate gears may provide fishermen additional opportunities to harvest shrimp for bait and food consumption while minimizing bycatch and protecting habitat from bottom disturbing gears. Further, non-quantifiable, reductions in bycatch could be achieved if shrimp trawls were phased out as a recreational commercial gear in areas opened to shrimp trawls. Several management strategies could be introduced or refined to reduce bycatch in the shrimp fishery while still allowing harvest in some areas closed to shrimp trawling, including:

- Close additional areas to shrimp trawling, for example potential bycatch hotspots in internal coastal waters, Intracoastal Waterway, and SSNAs
- Develop migration corridors closed to shrimp trawling

Questions for the Public

- Do you support additional area closures to reduce bycatch?
- Should special secondary nursery areas be closed to shrimp trawling?
- Do you support the creation of migration corridors? If so, are there specific areas that should be considered?
- Should inlets be closed to shrimp trawling to create migration corridors?
- Should migration corridors be considered in areas identified as bycatch hotspots?
- If additional areas are closed to shrimp trawling, should shrimp harvest limits in closed areas be increased?
- If additional areas are closed to shrimp trawling, should alternate gears (e.g., shrimp pots and pounds, seines, cast nets) be allowed for use in commercial harvest?
- Should shrimp trawls be phased out as a recreational commercial gear?

Shrimp Management

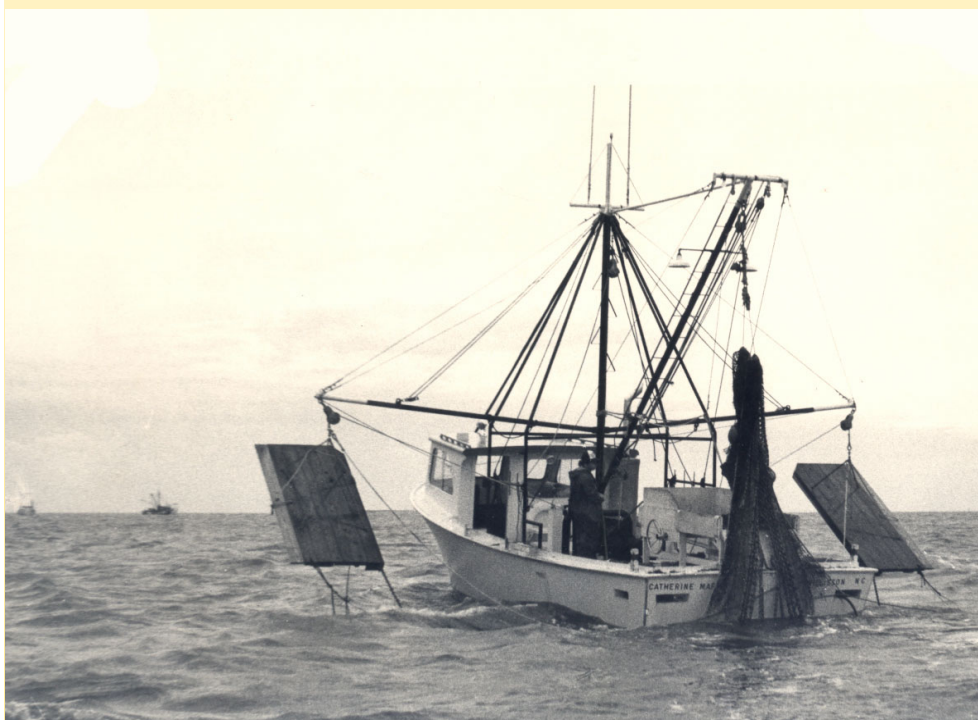


Size Restrictions

Background

Shrimp are spawned offshore in the winter. Post-larval shrimp move from the ocean into the estuaries on wind and tide driven currents in early spring and move high up into the upper reaches of small creeks to grow. As shrimp grow, they migrate from the creeks to deeper saltier rivers and sounds and finally to the ocean. When shrimp enter the estuaries, growth is rapid and is dependent on salinity and temperature. DMF conducts independent sampling in some SSNAs to determine openings, which are based on count size (number of shrimp per pound) as well as the abundance of bycatch. The division Director can open these areas by proclamation authority from August 16 through May 14. This strategy was originally put in place to allow fishermen to catch shrimp late in the season that have not migrated out into the larger estuaries. However, the occurrence of unusual weather patterns and changes in market demands (bait use versus human consumption), have complicated the division's ability to minimize bycatch, while allowing harvest. Current efforts to manage shrimp by size could be refined or eliminated to allow a greater size range of shrimp to be harvested, these strategies could include:

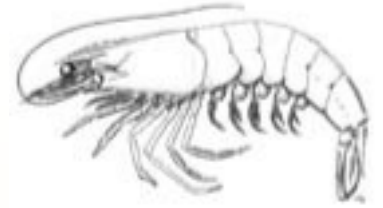
- Eliminate shrimp management by size
- Adjust target opening sizes



Questions for the Public

- Should shrimp management by size be eliminated?
- Should target count sizes used to determine opening be adjusted?
- Should the bait shrimp fishery be exempt from target opening sizes?

Habitat



Area Restrictions

Background

A number of criteria have been used to determine if trawling should be allowed in estuarine waters. These criteria include habitat qualities such as structure, aquatic vegetation, water depth, and bottom types. The closure of nursery areas and the protection of habitat through MFC rules and proclamations are designed to minimize the bottom-disturbing effects of some fishing gears such as dredges and trawls. The Coastal Habitat Protection Plan (CHPP) recommends that some areas of fish habitat be designated as “Strategic Habitat Areas” (SHAs; NCDEQ 2016). SHAs are defined as general locations of individual fish habitat or systems of habitat that have been identified to provide critical habitat functions or that are particularly at risk due to imminent threats, vulnerability, or rarity. Additionally, the CHPP focuses on the fish habitat and threats to the habitat. The process of identifying SHAs was completed in 2018 with the approval of nominated SHAs by the MFC and the next phase of field verification is underway.

Questions for the Public

- Do you support closing additional critical fish habitat areas to shrimp trawling? If so, how should these areas be determined?





Questions for the Public about Potential Management Strategies



1. What management strategies already under consideration do you support for long-term management?
2. Are there other relevant strategies not included here that the division should consider for Amendment 2?

Additional management strategies may be considered in Amendment 2 dependent on statutory requirements, available data, research needs, and the degree of impact the management strategy would have and how effective the solution would be. If the division determines a management strategy raised during the scoping period might have significant impacts on the species, additional examination of the strategy may be undertaken in the development of the FMP.

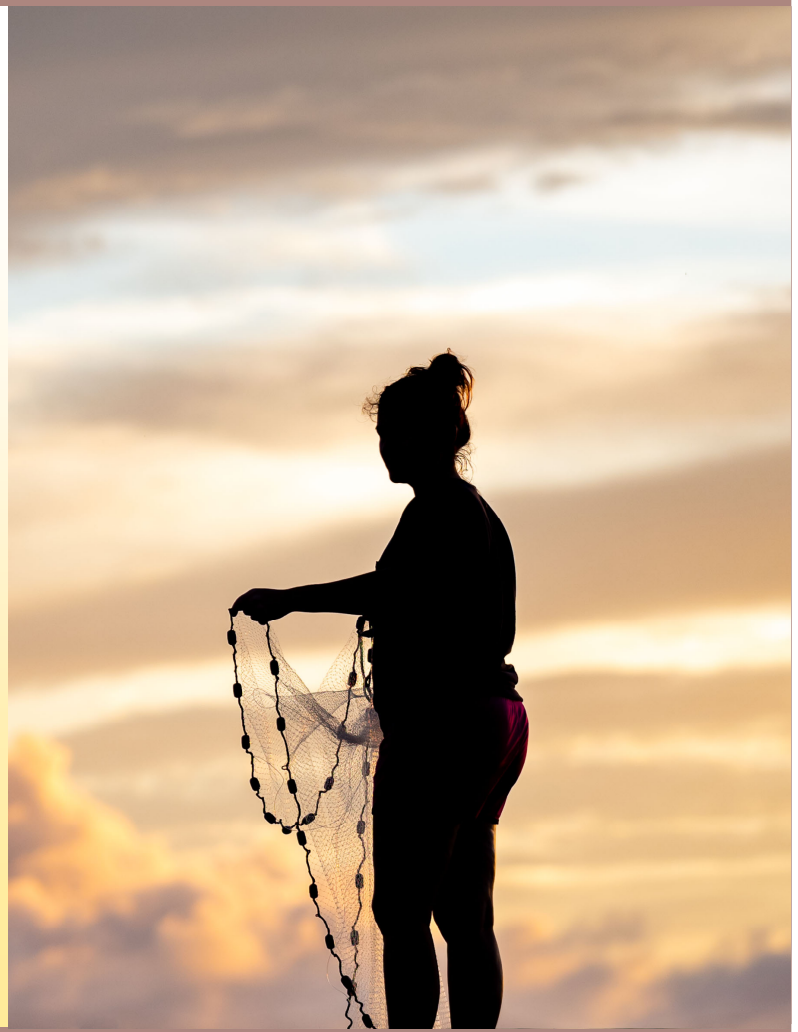


Literature Cited

ASMFC (Atlantic States Marine Fisheries Commission). 1994. Acronyms, abbreviations, and technical terms used in ASMFC fishery management programs. Special Report No. 33 of the Atlantic States Marine Fisheries Commission, Washington D.C. 22p.

NCDEQ (North Carolina Department of Environmental Quality). 2016. North Carolina Coastal Habitat Protection Plan Source Document, Division of Marine Fisheries, Morehead City, N.C. 475 p.

NCDMF (North Carolina Division of Marine Fisheries). 2015. North Carolina Shrimp Fishery Management Plan, Amendment 1. North Carolina Department of Environment and Natural Resources, Division of Marine Fisheries, Morehead City, N.C. 514 p.



Scoping Document

Management Strategies for Amendment 2 to the Shrimp Fishery Management Plan

NORTH CAROLINA DIVISION OF MARINE FISHERIES

DMF Headquarters
3441 Arendell Street
PO Box 769
Morehead City, NC 28557

800-682-2632

252-726-7021

<http://portal.ncdenr.org/web/mf/home>



MFC Motions Impacting Development of Shrimp FMP Amendment 2

The full discussion around these motions is summarized in the meeting minutes and can be heard in the meeting audio. Please reference the meeting date and year below to locate the appropriate meeting materials. Both are available on the Commissions meetings webpage:

<http://portal.ncdenr.org/web/mf/mfc-meetings>

August 2018 MFC Motion:

Motion by Cameron Boltes to include the following general focus in the development of Amendment 2 to the Shrimp FMP:

- Continue minimizing waste and enhance economic value of the shrimp resource by promoting more efficient harvesting practices.
- Further reduce mortality of non-target species of finfish and crustaceans and protected, threatened and endangered species.
- Promote the protection, restoration and enhancement of habitats and environmental quality.
- Encourage research and education to improve the understanding of the overall cumulative impacts of shrimp trawl bycatch on fish population dynamics.

Second by Brad Koury.

Motion carries 5-0 with 2 abstentions.

February 2019 MFC Motion:

Motion by Chuck Laughridge to refer the Wildlife Federation's Petition for Rulemaking (excluding spot and croaker) to the Shrimp FMP Advisory Committee for consideration in developing Amendment 2 to the FMP and to consider the following goals and objectives for the Shrimp FMP:

- Reduce takes and interactions of non-targeted species and threatened species.
- Improve the survival of non-target and threatened species at the population level.
- Continue to minimize bycatch and enhance the economic value of shrimp.
- Promote habitat enhancement and provide environmental quality necessary to improve the shrimp resource.
- Review nursery areas with an updated look at secondary nursery areas.
- Implement research and education programs to allow a better understanding of the public, industry and consumers of shrimp bycatch impact on fish population dynamics.

Second by Brad Koury.

Motion carries 5-3, with one abstention.

May 2018 Revision
to
Amendment 1
to the
North Carolina Shrimp
Fishery Management Plan

Prepared by the

North Carolina Department of Environmental Quality
Division of Marine Fisheries
3441 Arendell Street
P.O. Box 769
Morehead City, NC 28557



Executive Summary

There are three shrimp species (brown, pink, and white) that make up the shrimp fishery in North Carolina. In 2018, shrimp were the most economically important species for commercial fisheries in North Carolina. Amendment 1 to the Shrimp Fishery Management Plan (FMP) was developed to address bycatch in the commercial and recreational shrimp fishery as well as the development of a live bait shrimp fishery. In February 2015, the North Carolina Marine Fisheries Commission (NCMFC) adopted Amendment 1 and recommended a wider range of certified bycatch reduction devices to choose from, required two bycatch reduction devices in shrimp trawls and skimmer trawls, increased the daily harvest limit for cast nets in closed areas, and allowed live bait fishermen to fish until noon on Saturdays. In accordance with Amendment 1 as an adaptive management measure, the NCMFC also formed a Shrimp Bycatch Reduction Industry Workgroup (workgroup) made up of fishermen, net makers, and scientists from North Carolina Division of Marine Fisheries (NCDMF), National Marine Fisheries Service (NMFS), and N.C. Sea Grant to develop different gear configurations to reduce bycatch to the greatest extent practicable with a 40 percent target reduction.

During 2015-2017, a series of gear comparisons were made using modified shrimp trawls in Pamlico Sound and the Atlantic Ocean to determine gear configurations that best reduce bycatch, while maintaining acceptable shrimp harvest. The workgroup had initially desired acceptable shrimp loss as between 3% to 5%, depending on the reduction in bycatch achieved. However, after reviewing the results of the testing, the workgroup noted that a higher range of shrimp loss would be acceptable if significant finfish bycatch reduction occurred. Twelve experimental otter trawl configurations were tested (14 comparisons total) against a control net consisting of a federally certified Turtle Excluder Device (TED) with 4-inch bar spacing, one state fisheye Bycatch Reduction Device (BRD), and a 1 1/2-inch stretch mesh tailbag (current industry standard). Paired t-tests and a randomization test were used to determine whether the catches between the control and experimental nets were significantly different for each catch category (shrimp and bycatch species).

Four of the 12 gear combinations tested met or exceeded the 40% target reduction in finfish bycatch while also minimizing shrimp loss. Overall, finfish bycatch reductions ranged from 4.5 to 57.2%. Differences in shrimp catch between the control and experimental nets ranged from a 16.2 percent loss to a 9.9% gain. Results from the industry workgroup testing and the workgroup recommendation were presented to the NCMFC at its May 2018 business meeting. At this meeting the NCMFC voted to require fishermen to use one of four gear combinations tested by the workgroup that achieved at least a 40 percent reduction in finfish bycatch. The four gear configurations that achieved or exceeded these bycatch reductions without significantly reducing shrimp catch (less than 6 %) were:

- Double federal fisheyes used with a 1 7/8-inch stretch mesh tailbag and a 4-inch spaced bar TED
- Double federal fisheyes used with a 1 3/4-inch stretch mesh tailbag and a 4-inch spaced bar TED
- Double federal fisheyes used with a 1 3/4-inch stretch mesh tailbag and a 3-inch spaced bar TED
- A single state fisheye used with a 1 3/4-inch stretch mesh tailbag and a Virgil Potter BRD

Tows made with 4-inch TED, double federal fisheyes, and 1 3/4-inch tailbag significantly reduced finfish bycatch from 54.0% (randomization test) to 57.2% (t-test) and had the greatest reduction in finfish bycatch of all the gear combinations tested by the workgroup. Tows made with the 3-inch TED, double federal fisheyes, and 1 3/4-inch tailbag gears yielded the second highest reduction of the gear combinations tested, reducing finfish bycatch by 44.9% (t-test and randomization test). Tows made with the Virgil Potter BRD, and 1 3/4-inch tailbag gear combination was found to significantly reduce finfish bycatch by 43.2% (t-test) to 44.3% (randomization test). While not significant, the mean weight of shrimp was reduced by 5.5% for this gear combination. The double federal fisheye, 4-inch TED and 1 7/8-inch tailbag gear combination was found to significantly reduce finfish bycatch by 40.8% based on the t-test results. Randomization test results also found that finfish bycatch was reduced by 40.1% for this gear. The new gear configurations will be required in all shrimp trawls, except skimmer trawls, used in inside waters where up to 220 feet of combined headrope is allowed (Pamlico Sound and portions of the Pamlico, Bay, and Neuse rivers).

An issue paper outlining the results of the gear testing and industry workgroup recommendation were presented to the NCMFC at its May 2018 business meeting. At that time, the NCMFC selected their preferred management strategy. Management measures approved by the NCMFC were implemented via Proclamation SH-3-2019, effective July 1, 2019. The commission also voted to continue the shrimp industry workgroup and explore funding options for more studies; to survey fishermen to determine what bycatch reduction devices the shrimp trawl industry currently uses; and to begin development of Amendment 2 to the Shrimp Fishery Management Plan. This document serves as the Revision to Amendment 1 to the N.C. Shrimp FMP and documents the supporting data and rationale of the NCMFC for the following changes in shrimp management under Amendment 1 to be implemented May 1, 2018, unless otherwise specified. All other management strategies contained in Amendment 1 remain in force until another revision, supplement, or amendment to the N.C. shrimp FMP occurs.

I. SUBJECT

Investigate gear modifications that could be implemented to reduce bycatch in the shrimp trawl fishery.

II. ORIGINATION

The North Carolina Shrimp Fishery Management Plan (FMP) Amendment 1 and the North Carolina Marine Fisheries Commission (NCMFC).

III. BACKGROUND

NCMFC Action

In February 2015, the MFC adopted the Shrimp FMP Amendment 1 and its associated rules (NCDMF 2015). The amendment's primary focus is bycatch reduction in the shrimp trawl fishery. The MFC's preferred management strategy called for three years of industry testing of various gear configurations to reduce bycatch to the greatest extent practicable, with a 40% target reduction goal. Testing is to be conducted by a stakeholder group consisting of fishermen, net/gear manufacturers and scientific/gear specialists, partnered with staff from the North Carolina Division of Marine Fisheries (NCDMF) and North Carolina Sea Grant.

Results should minimize shrimp loss and maximize reduction of finfish bycatch. Promising gear configurations are to be brought back to the NCMFC for consideration for mandatory use in the shrimp trawl fishery.

Various gear combinations were tested against a control net that used a Florida Fish Eye bycatch reduction device (BRD), a federally-approved turtle excluder device (TED) and a 1 1/2-inch mesh stretch tailbag. Gear combinations tested include:

- Composite/square mesh panels,
- State and federal fisheyes,
- Minimum tailbag mesh size, and
- Reduced bar spacing in TED.

In the development of the final management strategies the NCMFC passed a motion at its February 2014 business meeting specifying the composition of the stakeholder workgroup and gear testing to be conducted. This was presented to the Shrimp FMP Advisory Committee (AC), as well as the NCMFC regional and standing advisory committees. In February 2015, the Shrimp FMP Amendment 1 and its rules were adopted by the NCMFC (see Appendix 1 for supporting motions).

Gear specific management strategies implemented by Amendment 1 not only required the development of the stakeholder group and gear testing, but also required fishermen to use either a T-90/square mesh tailbag or other applications of square mesh panel (e.g., skylight panel), reduced bar spacing in a TED, or another federal or state certified BRD in addition to existing TED and BRD requirements in all skimmer and otter trawls (Proclamation SH-2-2015, Appendix 4; Figure 1). To further address bycatch issues and provide fishermen more flexibility, the NCMFC also allowed the use of any federally certified BRD in all internal and offshore waters of NC. A maximum combined headrope length of 220 feet was also established in all internal coastal waters

that did not have existing maximum headrope requirements to put a cap on fleet capacity as a management tool.

Industry Workgroup

The Shrimp Bycatch Reduction Industry Workgroup was formed in 2015. The workgroup met throughout the gear testing process to discuss results and plan for testing. A list of workgroup members is provided in Appendix 2.

Workgroup meeting summary:

- March 31, 2015 – Reviewed existing and previously completed BRD research and selected designs to be tested by the workgroup. Developed operating procedures and established a schedule and protocols for gear testing in 2015.
- Jan. 25, 2016 – Reviewed first year of testing and plan for the second year. Based on testing results, the workgroup further recommended that new BRD/gear configurations should have an acceptable shrimp loss between 3% to 5%, depending on the reduction in bycatch achieved.
- Jan. 9, 2017 – Reviewed results from the second round of testing and selected gears to be tested in 2017. After focusing on large vessels in estuarine waters the first two years, the workgroup added gear testing for small vessels and testing in the ocean in the third year of the study.
- Jan. 22, 2018 – Reviewed the data and findings from the third year of gear testing.
- April 4, 2018 – Reviewed results from the three years of testing and made recommendations for consideration by the NCMFC. Upon reviewing the results of gear testing, the workgroup noted that a higher range of shrimp loss beyond the 3% to 5% originally set would be acceptable if significant finfish bycatch reduction occurred.

NCDMF staff provided the NCMFC updates on the workgroup's efforts during the testing period. NCDMF staff presented the workgroup's recommendations to the NCMFC at its May 2018 business meeting.

Industry Gear Testing

To evaluate the effectiveness of the various gear combinations selected by the workgroup, comparative tows were conducted aboard large commercial vessels (>46 ft) in 2015 and 2016; testing in 2017 also included smaller vessels (<45 ft) and in the ocean. Comparative tows consisted of paired net tests where a control net and an experimental net were fished simultaneously. Experimental nets were equipped with the candidate BRD or modification to be tested. Control nets for this project consisted of a typical commercial shrimp two-seam otter trawl with a Florida Fish Eye BRD (state certified), 4-inch bar spacing TED, and 1 1/2-inch stretched mesh tailbag. Headrope length was standardized for both control and experimental nets for each vessel. All experimental nets were calibrated prior to formal field trials to minimize potential net bias and all prototype testing following the National Oceanic and Atmospheric Administration (NOAA) BRD Testing Manual (NOAA 2008). A successful tow was defined as the control and experimental trawl fishing without an indication of problematic events (i.e., crab pots in net) occurring during the tow to impact or influence the fishing efficiency (catch) of one or both nets. Experimental and control nets were also switched from side to side to reduce the potential for side bias and ensure

an equal number of successful tows. To eliminate bias associated with the use of a try net (test net pulled for brief periods), the control and experimental nets were tested in the outside nets of the four-barrel (quad) rigs. Gear specification data were collected for both experimental and control nets and included headrope length, mesh size of wing and tailbag, TED type, TED bar spacing, BRD type, location, and duration (tow time). The catch from each net (experimental and control) were sampled by two NCDMF observers. After each paired tow, the entire catch was sampled and the total weight (kg) of each catch category was recorded. In 2015, only Penaeid shrimp and finfish were recorded; non-shrimp invertebrates, elasmobranchs (sharks/rays), and miscellaneous categories were added for the 2016 and 2017 testing.

Following the completion of each trip, all data were coded and entered into the NCDMF database. Tows were dropped from subsequent analyses if a problematic event (i.e., crab pots in net, hang) was experienced. Paired t-tests ($\alpha = 0.05$) were used to determine whether the catches between the control and experimental nets were significantly different for each category (shrimp and bycatch species). While calibration tows were made prior to testing, some side bias was still assumed in testing. To account for this, test gears were switched between the sides of the vessel throughout testing with the goal of having an even number of tows with the experimental gear on each side of the vessel. When this was not achieved, analyses randomly picked tows so the comparisons would be made with an equal number of tows (with the control and experimental gear) on each side of the vessel. Observed weights were standardized to the target two-hour tow time to adjust for differences in tow times. In 2017, tow-times were standardized to one hour to accommodate the addition of small vessels. The average weight of each net (control and experimental) was computed for each gear and species combination along with the difference in average weight and percent change (percent reduction). A randomization procedure (Manly 2007) was also used to compare catches between control and experimental nets for each gear/species/net combination. The randomization test does not require the data to be normally distributed and does not require tows to be dropped from the analysis. In 2016 and 2017, exploratory analyses were performed to investigate tow side (port versus starboard), time of day (day versus night), and location (2017 only). The results of these analyses indicate that variation in bycatch catch rates is not always due to changes in gear alone; tow side, time of day, and spatial location may also play a role in influencing bycatch catch rates. Generalized linear modeling (GLM) was not used to adjust randomization catch values for potential biases and may differ from those reported in Brown et al. 2017. For a detailed description of the sampling methodology, gear parameters, and full data analysis see Brown et al. (2017, 2018).

Results

A total of 267 comparative tows were made using nine experimental gears during the summer and fall in the Pamlico Sound in 2015 and 2016 (Figure 2). In 2017, a total of 120 comparative tows were made on four experimental gears during the summer and fall in the Pamlico Sound and the nearshore waters of the Atlantic Ocean (Figure 2). Only larger vessels (>46 ft) were used for testing in 2015 and 2016. Testing in 2017 also included smaller vessels (<45 ft). Approximately 98% of the tows (2015-2017) were available for analyses; problematic tows were excluded.

In 2015, only one gear met the 40% target reduction in finfish bycatch set by the NCMFC (Table 1). The double federal fisheye, 4-inch TED, and 1 7/8-inch tailbag gear combination was found to significantly reduce finfish bycatch by 40.8% based on the t-test results. The randomization test

found that finfish bycatch was reduced by 40.1% for this gear combination. While the other experimental gears tested in 2015 failed to meet the 40% target, many of the gears were found to reduce finfish bycatch while minimizing shrimp loss. The composite panel with fish spooker cone significantly reduced finfish bycatch by 25.8% (t-test) to 27.6% (randomization test). Tows made with a 3-inch TED, square mesh panel, and 1 7/8-inch tailbag significantly reduced finfish bycatch by 25.3% (t-test) to 27.5% (randomization test). T-test results indicated the mean weight of finfish bycatch was significantly reduced by 16.2% using a 3-inch TED and one state fisheye. Of all the gears tested by the workgroup in 2015, the Ricky BRD had the lowest observed reduction in finfish bycatch. Finfish reductions ranged from 4.5% (randomization test) to 6.6% (t-test). The mean weight of shrimp was not significantly different from the control net for all gears tested in 2015.

During the second year of testing, three out of four gears tested met or exceeded the 40% target reduction in finfish bycatch (Table 2). Tows made using a 4-inch TED, double federal fisheyes, and a 1 3/4-inch tailbag significantly reduced finfish bycatch by 54.0% (randomization test) to 57.2% (t-test) and had the greatest reduction in finfish bycatch of all the gears tested by the workgroup. Tows made with a 3-inch TED, double federal fisheyes, and 1 3/4-inch tailbag yielded the second highest reduction of the gear combinations tested, reducing finfish bycatch by 44.9% (t-test and randomization test). Finfish bycatch reductions were slightly lower in the fall using one state fisheye, the Virgil Potter BRD, and 1 3/4-inch tailbag gear combination. Finfish bycatch reductions ranged from 43.2% (t-test) to 44.3% (randomization test). While not significant, t-test results indicated the mean weight of shrimp was reduced by 5.5% for this gear combination. A similar gear combination tested in the summer using a slightly smaller mesh tailbag (1 1/2-inch), one state fisheye, and Virgil Potter BRD reduced finfish bycatch by 26.9% (t-test) to 28.5% (randomization test). The mean weight of non-shrimp invertebrates and elasmobranchs was not significantly different from the control net for all gears tested in 2016.

While none of the gear combinations tested in 2017 met the 40% target reduction for finfish bycatch (Table 3), the 3-inch TED, double state fisheye, and 1 5/8-inch tailbag did significantly reduce finfish bycatch in the ocean by 32.6% (t-test and randomization test) during summer testing. The mean weight (kg) of shrimp for this gear was also found to be significantly different from the control net, reducing the catch of shrimp by 6.8% (t-test). Testing the same gear combination in the ocean in the fall using a 3-inch TED, double state fisheye, and 1 5/8-inch tailbag did not significantly reduce finfish bycatch and shrimp loss almost tripled the acceptable range originally recommend by the workgroup. The t-test and randomization test did however indicate the catch of non-shrimp invertebrates and elasmobranchs were significantly reduced by 65.1% and 57.1%, respectfully for this gear combination. The 3-inch TED, single state fisheye, and 1 5/8-inch tailbag experimental gear combination significantly reduced finfish bycatch by 22.8% (t-test) in the summer in Pamlico Sound. However, the mean weights of the other species groups were not significantly different from the control net for this gear. Though not statistically significant, tows made using this gear combination also reduced the shrimp catch by 7.8% (t-test) to 9% (randomization test).

IV. AUTHORITY

§ 113-134. Rules

§ 113-173. Recreational Commercial Gear License

§ 113-182. Regulation of fishing and fisheries
§ 113-182.1 Fishery Management Plans
§ 113-221.1 Proclamations; emergency review
§ 143B-289.52 Marine Fisheries Commission - powers and duties

15A NCAC 03H .0103 Proclamation Authority of Fisheries Director
15A NCAC 03J .0104 Trawl Nets
15A NCAC 03L .0101 Shrimp Harvest Restrictions
15A NCAC 03L .0103 Prohibited Nets, Mesh Lengths and Areas

V. DISCUSSION

Reducing bycatch in the shrimp trawl fishery and the development of gear configurations that maximize finfish reduction and minimize shrimp loss has been an ongoing task for the Division since the 1980s (NCDMF 2015). The 1992 Atlantic States Marine Fisheries Commission (ASMFC) Weakfish FMP recommended that states implement programs to reduce bycatch mortality of weakfish in the shrimp trawl fishery by 40% (ASMFC 1992). Following this recommendation, the NCDMF conducted a series of independent gear tests as well as tests in cooperation with the shrimp industry. Results from this testing lead to the development of new BRDs and gear modifications to reduce bycatch and North Carolina became the first state to require BRDs in shrimp trawls in 1992. Amendments 3 and 4 to the ASMFC Weakfish FMP later changed the certification requirement to demonstrate a 40% reduction in catch (by number) or a 50% reduction in bycatch mortality of weakfish (ASMFC 1996, 2002). In 2004, Addendum III to Amendment 4 of the ASMFC Weakfish FMP again changed the BRD requirements from a 40% reduction in weakfish by number to a 30% reduction by weight (ASMFC 2007). This change was made to complement the South Atlantic Fishery Management Council (SAFMC) Shrimp FMP and has allowed for more flexible testing and development of BRDs. With the adoption of Amendment 1 to the NC Shrimp FMP, the use of any federally certified BRD in all internal and offshore waters was approved as well as a recommendation to update testing protocols for state BRD certification (NCDMF 2015). These changes, as well as continued industry collaboration, should give fisheries managers more flexibility identifying, developing, and implementing new gears to reduce bycatch.

The use of minimum tailbag mesh regulations has been a common management strategy used by fisheries managers to reduce bycatch. As early as 1949, researchers in North Carolina have examined how larger mesh sizes in tailbags can reduce finfish bycatch in shrimp trawls (Roelofs 1950). Testing conducted by the NCDMF has also shown that larger tailbag mesh sizes and how they are hung (diamond vs. square) can reduce bycatch. Brown (2010) compared the catch rates of shrimp and bycatch in modified trawls with various tailbag mesh sizes in the Neuse River and Pamlico Sound. Experimental nets with 1 3/4-inch tailbags showed significant reductions in Atlantic croaker (16%) and spot (50%) as compared to the control net (standard 1 1/2-inch mesh tailbag); however, no significant difference in the catch of shrimp was detected between the control and experimental net. Experimental nets with a 2-inch tailbag (hung on the square) were found to have even greater reductions for Atlantic croaker (69%) and spot (82%). Results from the 2015-2017 industry field testing also showed that gears with larger tailbag mesh sizes had greater reductions in finfish bycatch than those constructed with smaller mesh tailbags. Of the four gear combinations that met or exceeded the 40% target reduction in finfish bycatch, three of those used

a 1 3/4-inch tailbag. Gear combinations using a 1 7/8-inch mesh tailbag were also found to significantly reduce finfish bycatch by 25.3% to 40.8% (randomization test data: 27.5% to 40.1%).

NOAA Fisheries has required the use of TEDs since 1992 to reduce the number of strandings and incidental takes of sea turtles (NCDMF 2015). TEDs have also been shown to reduce the bycatch of smaller finfish and invertebrates in both otter and skimmer trawls (Broome 2011; Price and Gearhart 2011). Currently, federal law mandates a 4-inch maximum TED bar spacing between grids. Broome et al. 2011, found that reduced TED grid spacing was very effective at reducing finfish bycatch while maintaining minimal shrimp loss. The authors also noted a noticeable reduction in large rays, sharks, jellyfish and horseshoe crabs in the 2-inch reduced grid TED. Of the gear combinations tested by the workgroup that met the 40% reduction in finfish bycatch, only one used a 3-inch TED. Results from both the t-test and randomization test indicated that tows made using double federal fisheyes, 1 3/4-inch tailbag, and 3-inch bar TED reduced finfish bycatch by 44.9% and only had a 4.9% loss of shrimp. Tows made with double state fisheyes, 1 5/8-inch mesh tailbag, and 3-inch TED bar spacing were also found to significantly reduce the catch of elasmobranchs by approximately 57% (t-test and randomization test) in the fall ocean fishery. Raborn et al. (2012) noted that the use of TEDs in the Gulf of Mexico Penaeid shrimp fishery reduced the catch of blacknose sharks by 94% and bonnethead sharks by 31%. The authors further note, that smaller coastal sharks, such as Atlantic sharpnose sharks, may be more effectively excluded by TEDs with reduced bar spacing. Both t-test and randomization tests indicated the catch of non-shrimp invertebrates was significantly reduced (by 65.1%) for tows made using double state fisheyes, 1 5/8-inch tailbag, and a 3-inch TED. When used in combination with larger tailbag mesh sizes (>1 1/2-inch), TEDs with reduced bar spacing appear to be very effective at reducing the bycatch of elasmobranchs and non-shrimp invertebrates in the ocean.

With the adoption of Amendment 1 the NCMFC also mandated the use of an additional federal or state certified BRD in all skimmer and otter trawls. Most fishermen have opted to use an additional state fisheye due to their low cost and ease of installation (K. Brown. NCDMF, personal communication). State fisheyes are a diamond shaped BRD (sometimes oval) that measure 5 1/2 inches by 6 1/2 inches, which provides an opening of approximately 20 square inches (Figure 3). The use of two state fisheyes provides approximately 40 total square inches of opening. Federal fisheyes must have a minimum opening of 36 square inches; however, all federal fisheyes tested by the workgroup were built with a margin of error that expanded the opening to 40 square inches (Figure 3). Thus, the use of two federal fisheyes provided approximately 80 square inches of opening. Of the four gear combinations that met or exceeded the 40% target reduction in finfish bycatch, three used double federal fisheyes. Gear combinations tested using double federal fisheyes were found to reduce finfish bycatch by 54.0% (randomization test) to 57.2% (t-test), whereas those using two state fisheyes only reduced finfish bycatch by as much as 32.6% (t-test and randomization test). The additional 40 square inches of opening gained using double federal fisheyes appears to provide greater escape of finfish than the use of double state fisheyes. Overall shrimp loss of gears using double federal fisheyes was comparable to losses of gears using double state fisheyes. However, tows made with double federal fisheyes with the addition of a float (Ricky BRD) had shrimp losses nearly double the industry recommendation and only minimal reduction in finfish bycatch. Gear combinations that incorporated two federal fisheyes and large mesh tailbags (1 3/4-inch or greater) appeared to provide the greatest reductions in finfish bycatch and

further allow fishermen to use the same gear in both state and federal waters within the Exclusive Economic Zone (EEZ).

While all the gear combinations tested resulted in reductions in finfish bycatch, it is hard to specify what element of the design made the largest contribution. Conversely, it is also hard to identify what design elements played the greatest role in minimizing shrimp loss. However, results from the industry field testing do indicate that small modifications in gear configuration such as TED bar spacing and tailbag mesh size can significantly impact gear performance. The addition of a 1 3/4-inch tailbag to the Virgil Potter BRD was found to reduce finfish bycatch an additional 15.8% (randomization test) to 16.3% (t-test) as compared to same gear rigged with a 1 1/2-inch tailbag. These reductions could be even greater with the addition of a 3-inch reduced grid TED. Nevertheless, the individual contribution of each modification cannot be quantified until further testing is done to test each specific design element of the gear combinations that met the 40% target reduction in finfish bycatch. Future testing should also incorporate design elements of gear combinations that did not meet the 40% target reduction in finfish bycatch. While several of those tested failed to meet the target, many obtained finfish bycatch reductions ranging from 25% to 30%. Thus, it is important to note that these reductions in bycatch are in addition to the 30% reduction in finfish bycatch mandated by the federal BRD certification process, and gears that met the NCMFC's 40% finfish bycatch reduction achieved nearly twice the federal requirements for reducing bycatch. Results from the industry gear testing should further encourage the use and development of new and innovative BRD designs.

Management decisions based on the results of the industry gear testing should not only consider which gear combinations had the greatest reduction in finfish bycatch, but should also consider vessel size as well as their contribution to the overall landings. In the last ten years (2007-2016), vessels greater than 55 feet made up roughly 30% of North Carolina's shrimp trawl fleet and landed 73% of the total shrimp landings (Table 4). In North Carolina's estuarine waters, roughly 67% of the vessels were 45 feet or less in length and harvested 17% of the total estuarine shrimp landings. Of the gear combinations that met the 40% reduction in finfish bycatch, vessel size ranged from 68 to 88 feet in the Pamlico Sound (Tables 1-2). Thus, it's important to note that observed finfish reductions obtained on larger vessels may not be directly applied to smaller vessels that operate in smaller waterbodies. The mandated use of untested gears on smaller boats could negatively impact gear performance and efficiency due to differences in tow times and haul-back practices. Furthermore, bycatch reductions achieved on smaller vessels should not be directly applied to larger vessels until further testing can be done. Future gear testing should include a wide variety of vessels across multiple areas throughout the state to determine how seasonal differences in species abundance, movement associated with life stage, and environmental factors influence gear performance.

All the necessary data do not currently exist to adequately quantify the overall reduction in bycatch gained by the mandated use of the gear combinations tested that met the 40% target reduction in finfish bycatch. Thus, management decisions should further consider the full extent of the social and economic factors that may impact the shrimp trawl fishery and its associated gears. Costs associated with purchasing and installing gear could become cost prohibitive making it no longer feasible for fishermen to continue in the fishery once their current gear configuration is obsolete; these costs could further be amplified for vessels using double and four-barrel rigs. To lessen these

costs, a phase-in period should be considered. Furthermore, the mandated use of untested gear combinations could further hinder the development and voluntary use of new BRDs. While gears such as the Ricky BRD did not meet the 40% target reduction in finfish, it is important to note that these gears were developed by fishermen and had promising results. Industry involvement is a key factor in not only the development and testing of new gears, but the overall acceptance of new gears. Murry et al. (1992) noted that shrimpers prefer to reduce bycatch because of the additional culling time, damage it causes to the quality of shrimp, and the extra weight in the tailbags which can reduce trawl door spread and fuel efficiency. Without acceptance from the public, the overall reduction in bycatch could be minimal if gear specific regulations are difficult to enforce. Regulations based on vessel length would be easier to enforce than those based on total combined headrope length. Vessel length can be determined from the Commercial Fishing Vessel Registration. Gear specific regulations should also consider user group (recreational, commercial) and gear type (otter trawl, skimmer trawl, crab trawl) in addition to vessel size. Recommendations from the industry workgroup on bycatch reduction in shrimp trawls that may be adopted by the NCMFC do not require an amendment and could be implemented by existing proclamation authority. Based on the motion passed at their February 2014 business meeting, the NCMFC may consider promising gear configurations that were tested by the industry workgroup for mandatory use in the shrimp trawl fishery. Management decisions based on industry collaboration, such as the work summarized in this paper, should provide further insight on solutions that limit bycatch while minimizing shrimp loss.

VI. THE FOUR GEAR COMBINATIONS THAT ACHEIVED AT LEAST A 40% REDUCTION IN FINFISH BYCATCH

- 1) Double federal fisheyes, 1 7/8-inch tailbag, and 4-inch TED
 - + Significantly reduces finfish bycatch (t-test: -40.8%, randomization test: -40.1%)
 - + Net gain in shrimp observed; however, not significant (t-test: +1%, randomization test: +2.2%)
 - + Reduces culling time due to less bycatch
 - + Implements actions of Amendment 1 to the Shrimp FMP
 - Costs associated with purchasing and installing gear (+\$600 per net)
 - Untested on smaller vessels, skimmer trawls, and in the Atlantic Ocean

- 2) Double federal fisheyes, 1 3/4-inch tailbag, and 4-inch TED
 - + Significantly reduces finfish bycatch (t-test: -57.2%, randomization test: -54.0%)
 - + Reduces non-shrimp invertebrate bycatch; however, not significant (t-test: -15.7, randomization test: -4.9%,)
 - + Reduces culling time due to less bycatch
 - + Implements actions of Amendment 1 to the Shrimp FMP
 - Shrimp losses greater than 5%; however, not significant (t-test: -12.1%, randomization test: -16.2%)
 - Costs associated with purchasing and installing gear (+\$600 per net)
 - Untested on smaller vessels, skimmer trawls, and in the Atlantic Ocean

- 3) Double federal fisheyes, 1 3/4-inch tailbag, and 3-inch TED
 - + Significantly reduces finfish bycatch (t-test and randomization test: -44.9%)

- + Observed shrimp losses less than 5%; however, not significant (t-test and randomization test: -4.9%)
 - + Reduces non-shrimp invertebrate bycatch; however, not significant (t-test and randomization test: -13.3%)
 - + Reduces elasmobranch bycatch; however, not significant (t-test and randomization test: -18.6%)
 - + Potential reductions in debris and jellyfish
 - + Reduces culling time due to less bycatch
 - + Implements actions of Amendment 1 to the Shrimp FMP
 - Costs associated with purchasing and installing gear (+\$1,250 per net)
 - Potential fouling issues in areas and times of high grass concentrations
 - Untested on smaller vessels, skimmer trawls, and in the Atlantic Ocean
- 4) Single state fisheye, 1 3/4-inch tailbag, and Virgil Potter BRD
- + Significantly reduces finfish bycatch (t-test: -43.2%, randomization test: -44.3%)
 - + Reduces culling time due to less bycatch
 - + Implements actions of Amendment 1 to the Shrimp FMP
 - Costs associated with purchasing and installing gear (+\$800 per net)
 - Shrimp losses greater than 5%; however, not significant (t-test: -5.5%, randomization test: -5.8%)
 - Untested on smaller vessels, skimmer trawls, and in the Atlantic Ocean

VII. RECOMMENDATION

Shrimp Industry Bycatch Reduction Workgroup

- Does not want to go on record recommending a range of acceptable shrimp loss; if finfish bycatch reduction is significant, a larger range could be acceptable (beyond range used by workgroup of 3-5%).
- Does want to recommend continued collaborative bycatch reduction research, specifically continuance of the N.C. Shrimp Bycatch Reduction Industry Workgroup, requesting that funding from gear testing possibly come from surplus funds from increased license fees (i.e., Commercial Fishing Resources Fund). Industry continues to be willing to provide in-kind contributions.
- Does endorse for use on otter trawls fishing in inside waters (in areas where a combined headrope of 90-feet or greater is allowed as identified in the Shrimp FMP; Figure 4) the four combinations of bycatch reducing gears that met the target of 40% bycatch reduction, but specifically recommends:
- Use of the combination gear of double Federal fisheyes, 4-inch TED and 1 3/4-inch tailbag, again, in inside waters where an otter trawl with a combined head rope of 90-feet or greater is allowed. (Specific intent is not to have this change applied to other areas open to otter trawls, channel nets, and skimmer trawls until further bycatch reduction testing has been completed.)
- Recommends the N.C. Division of Marine Fisheries explores valid survey techniques to gather information on current bycatch reduction devices being used by industry.

Summary of Additional Comments from Absentee Workgroup Members*

- Some members gave blanket support.
- Would like consideration of a phase-in period.
- Had reservations on more than 5 percent shrimp loss.
- Support not setting arbitrary shrimp loss levels.
- Support for reduced bar spaced TED, but defer to those working affected areas.
- The double federal fisheyes and 1 3/4-inch tailbag produced desired goal and should not be a burden for affected boats.
- 1 3/4-inch tailbag not tested on smaller boats
 - Anecdotal testing showed shrimp loss on 21/25 and 16/20 count shrimp
- More testing on small vessels
 - Allow more time to find working combination for small vessels

**See Appendix 3 for complete correspondences received from absentee workgroup members on proposed recommendations.*

NCDMF Recommendation, none offered

VIII. MANAGEMENT REVISIONS TO AMENDMENT 1 TO THE N.C. SHRIMP FMP

Amendment 1 to the North Carolina Shrimp FMP provides the adaptive management framework (see Appendix 1) for the changes in management proposed herein and titled as the May 2018 Revision. This document serves as the Revision to Amendment 1 to the N.C. Shrimp FMP and documents the supporting data and rationale of the NCMFC for the following changes in shrimp management under Amendment 1 to be implemented May 1, 2018, unless otherwise specified. All Revision management measures were implemented through Proclamation SH-3-2019 (Appendix 5).

NCMFC Approved Management Revisions for Bycatch Reduction

- Continue the NC shrimp industry workgroup and explore funding options
- Require shrimp trawls, with the exception of skimmer trawls, fishing the inside waters where greater than 90-foot headrope length is required to use a gear combination that has been studied and achieves at least a 40 percent finfish bycatch reduction (to be implemented July 1, 2019)
- Following peer review of workgroup study, re-evaluate results and continue bycatch reduction study with industry workgroup
- Task the division to implement a survey to gather information on current bycatch reduction devices used by the industry
- Begin development of Amendment 2 to the Shrimp FMP

All other management strategies contained in Amendment 1 remain in force until another revision, supplement, or amendment to the North Carolina Shrimp FMP occurs.

IX. REFERENCES CITED

- ASMFC (Atlantic State Marine Fisheries Commission). 1992. Weakfish Fishery Management Plan Amendment 1. ASMFC, Washington, D. C. Fishery Management Report No. 20. 69 p.
- ASMFC. 1996. Amendment 3 to the Interstate Fishery Management Plan for Weakfish. ASMFC, Washington, D. C. Fishery Management Report No. 27. 66 p.
- ASMFC. 2002. Amendment 4 to the Interstate Fishery Management Plan for Weakfish. ASMFC, Washington, D. C. Fishery Management Report No. 39. 101 p.
- ASMFC. 2007. Addendum III to Amendment 4 to the Interstate Fishery Management Plan for Weakfish. ASMFC, Washington, D. C. 6 p.
- Broome, J.D., Anderson, J.W., and D.W. Anderson. 2011. By-catch volume reduction through turtle excluder device (TED) reduced grid spacing. North Carolina Sea Grant Project # 10-FEG-03. 37 p.
- Brown, K.B. 2010. Compare catch rates of shrimp and bycatch of other species in standard (control) and modified (experimental) otter trawls in the Neuse River and Pamlico Sound, North Carolina Completion report for NOAA award no. NA08NMF474076 North Carolina Department of Environment and Natural Resources, Division of Marine Fisheries. 22 p.
- Brown, K.B., B. Price, L. Lee, S. Baker, and S. Mirabilio. 2017. An evaluation of bycatch reduction technologies in the North Carolina shrimp trawl fishery. North Carolina Department of Environment and Natural Resources, Division of Marine Fisheries, Morehead City, NC. 40 p.
- Brown, K.B., B. Price, L. Lee, S. Baker, and S. Mirabilio. 2018. Technical solutions to reduce bycatch in the North Carolina Shrimp Trawl Industry. North Carolina Department of Environment and Natural Resources, Division of Marine Fisheries, Morehead City, NC. 50 p.
- Manly, B. 2007. Randomization, bootstrap and Monte Carlo methods in biology, 3rd edition. Chapman & Hall/CRC, New York. 455 p.
- Murray, J.D., J.J. Baden, and R.A. Rulifson. 2011. Management considerations for by-catch in the North Carolina and Southeast Shrimp Fishery. *Fisheries*, 17:1, 21-26.
- NCDMF (North Carolina Division of Marine Fisheries). 2015. North Carolina Shrimp Fishery Management Plan, Amendment 1. North Carolina Department of Environment and Natural Resources, Division of Marine Fisheries, Morehead City, NC. 514 p.

NOAA (National Oceanic and Atmospheric Administration). 2008. Bycatch reduction device testing manual. National Marine Fisheries Service, Southeast Regional Office, St. Petersburg, FL. 42 p.

Raborn S.W., B.J. Gallaway, J.G. Cole, W.J. Gazey, and K.I. Andrews. 2012. Effects of turtle Excluder Devices (TEDs) on the bycatch of three small coastal sharks in the Gulf of Mexico penaeid shrimp fishery, *North American Journal of Fisheries Management*, 32(2): 333-345.

Roelofs, E.W. 1950. Observations of the capture of small fish by the shrimp trawls. Annual Report, Institute of Fisheries Research UNC, Morehead City, NC, pp 111-115.

Price, A.B., and J.L. Gearhart. 2011. Evaluations of turtle excluder device (TED) performance in the U.S. southeast Atlantic and Gulf of Mexico skimmer trawl fisheries. NOAA technical Memorandum NMFS-SEFSC-615. 15 p.

Prepared by: Chris Stewart
Chris.Stewart@ncdenr.gov
910-796-7370

Revised: July 18, 2018

Table 1. Results from the paired t-test and randomization test of the five experimental gears tested during 2015. Mean weight of catch data reported in kg. Values in bold indicate significant p-values (alpha = 0.05). Gears in grey met or exceeded the 40% reduction target for finfish bycatch.

Season / Waterbody	Vessel size (ft)	Gear	Tailb ag (in.)	TED (in.)	Species group	Control		Exp.		T-test		Control		Exp.		Randomization*	
						N	Mean	Mean	% Change	p-value	N	Mean	Mean	% Change	p-value		
Summer / Pamlico Sd.	68	Composite panel, spooker cone	1 1/2	4	Finfish	44	178.1	132.1	-25.8	< 0.001	60	177.3	128.4	-27.6	< 0.001		
					Shrimp	44	64.3	63.9	-0.7	0.754	60	67.3	65.2	-3.1	0.776		
Summer / Pamlico Sd.	75	Single state fisheye	1 1/2	3	Finfish	16	107.3	90.0	-16.2	0.029	19	112.8	89.8	-20.4	0.217		
					Shrimp	16	49.6	46.0	-7.4	0.078	19	48.2	45.5	-5.6	0.739		
Summer / Pamlico Sd.	75	Single state fisheye, square mesh panel	1 7/8	3	Finfish	40	104.8	78.2	-25.3	< 0.001	51	102.3	74.1	-27.5	0.007		
					Shrimp	40	65.7	64.4	-1.9	0.309	51	67.3	65.2	-3.0	0.775		
Summer / Pamlico Sd.	88	Ricky BRD	1 1/2	4	Finfish	10	110.6	103.3	-6.6	0.503	15	100.0	95.5	-4.5	0.793		
					Shrimp	10	35.3	31.8	-9.9	0.449	15	35.4	33.3	-6.1	0.728		
Summer / Pamlico Sd.	88	Double federal fisheye	1 7/8	4	Finfish	25	90.0	53.3	-40.8	< 0.001	32	88.3	52.9	-40.1	< 0.001		
					Shrimp	25	61.3	61.9	1.0	0.778	32	60.6	61.9	2.2	0.862		

* Generalized linear modeling (GLM) was not used to adjust randomization catch values for potential biases and may differ from those reported in Brown et al. 2017.

Table 2. Results from the paired t-test and randomization test of the five experimental gears tested during 2016. Mean weight of catch data reported in kg. Values in bold indicate significant p-values (alpha = 0.05). Gears in grey met or exceeded the 40% reduction target for finfish bycatch.

Season / Waterbody	Vessel size (ft)	Gear	Tailbag (in.)	TED (in.)	Species group	T-test				Randomization*					
						N	Control Mean	Exp. Mean	% Change	p-value	N	Control Mean	Exp. Mean	% Change	p-value
Summer/ Pamlico Sd.	68	Single state fisheye, Virgil Potter BRD	1 1/2	4	Finfish	30	146.3	106.9	-26.9	< 0.001	33	149.4	106.9	-28.5	0.005
					Shrimp	30	62.6	68.8	9.9	0.050	33	61.8	67.0	8.5	0.696
					Invertebrates [†]	10	3.3	2.7	-18.8	0.384	33	1.0	0.8	-18.8	0.681
					Elasmobranchs	7	5.3	5.9	11.1	0.589	33	1.1	1.2	11.1	0.912
Summer / Pamlico Sd.	75	Double federal fisheye	1 3/4	4	Finfish	6	201.5	86.3	-57.2	0.001	23	164.5	75.6	-54.0	< 0.001
					Shrimp	6	23.0	20.2	-12.1	0.215	23	28.1	23.6	-16.2	0.280
					Invertebrates [†]	6	7.2	6.1	-15.7	0.081	23	5.4	5.1	-4.9	0.833
					Elasmobranchs	6	1.8	2.6	45.8	0.509	23	2.1	2.5	18.8	0.573
Summer / Pamlico Sd.	75	Double federal fisheye	1 3/4	3	Finfish	30	115.4	63.6	-44.9	< 0.001	30	115.4	63.6	-44.9	0.007
					Shrimp	30	27.0	25.7	-4.9	0.435	30	27.0	25.7	-4.9	0.706
					Invertebrates [†]	30	2.1	1.8	-13.3	0.418	30	2.1	1.8	-13.3	0.601
					Elasmobranchs	27	1.8	1.4	-18.6	0.404	30	1.6	1.3	-18.6	0.568
Fall / Pamlico Sd.	68	Single state fisheye, Virgil Potter BRD	1 3/4	4	Finfish	20	189.0	107.0	-43.2	< 0.001	25	172.3	96.1	-44.3	0.001
					Shrimp	20	33.1	31.3	-5.5	0.055	25	31.3	29.5	-5.8	0.691
					Invertebrates [†]	25	0.0	0.0	n/a	n/a	25	0.0	0.0	n/a	n/a
					Elasmobranchs	25	0.0	0.1	n/a	n/a	25	0.0	0.0	n/a	n/a

* *Generalized linear modeling (GLM) was not used to adjust randomization catch values for potential biases and may differ from those reported in Brown et al. 2017.*

[†] *Non-shrimp invertebrates*

Table 3. Results from the paired t-test and randomization test of the five experimental gears tested during 2017. Mean weight of catch data reported in kg. Values in bold indicate significant p-values (alpha = 0.05). Gears in grey met or exceeded the 40% reduction target for finfish bycatch.

Season / Waterbody	Vessel size (ft)	Gear	Tailbag (in.)	TED (in.)	Species group	Control				T-test		Exp.		Randomization**	
						N	Mean	Mean	% Change	p-value	N	Mean	Mean	% Change	p-value
Summer / Pamlico Sd.	44	Single state fisheye	1 1/2	3	Finfish	*	*	*	*	*	5	12.3	12.9	5.1	0.732
					Shrimp	*	*	*	*	*	5	18.7	17.3	-7.8	0.827
					Invertebrates [†]	*	*	*	*	*	5	4.9	6.8	38.8	0.281
					Elasmobranchs	*	*	*	*	*	4	0.2	0.4	75.0	0.487
Summer / Pamlico Sd.	40	Single state fisheye	1 5/8	3	Finfish	20	34.6	26.7	-22.8	0.019	22	34.9	27.8	-20.4	0.341
					Shrimp	20	12.1	11.2	-7.8	0.294	22	11.6	10.6	-9.0	0.556
					Invertebrates [†]	18	2.3	2.1	-6.1	0.692	22	2.1	2.1	-0.4	0.993
					Elasmobranchs	*	*	*	*	*	3	0.3	0.1	-80.0	0.397
Summer / Ocean	40	Double state fisheye	1 5/8	3	Finfish	30	146.0	98.5	-32.6	< 0.001	30	146.0	98.5	-32.6	0.002
					Shrimp	30	2.9	2.7	-6.8	0.039	30	2.9	2.7	-6.6	0.598
					Invertebrates [†]	30	17.2	15.9	-7.6	0.086	30	17.2	15.9	-7.6	0.505
					Elasmobranchs	29	3.0	2.5	-16.3	0.184	30	2.9	2.4	-16.7	0.425
Fall / Ocean	35	Double state fisheye	1 5/8	3	Finfish	30	57.5	54.9	-4.6	0.670	30	57.5	54.9	-4.6	0.890
					Shrimp	30	9.8	8.3	-14.9	< 0.001	30	9.8	8.3	-14.8	0.365
					Invertebrates [†]	30	8.2	2.9	-65.1	0.001	30	8.2	2.9	-65.1	< 0.001
					Elasmobranchs	28	4.4	1.9	-57.1	0.009	29	4.3	1.8	-57.3	0.014
Fall / Ocean	60	Double federal fisheye	1 5/8	3	Finfish	30	75.6	97.7	29.3	0.204	30	75.6	97.7	29.3	0.250
					Shrimp	30	17.3	15.7	-9.0	0.002	30	17.3	15.1	-12.5	0.234
					Invertebrates [†]	25	2.2	2.7	21.9	0.276	30	2.3	2.9	25.1	0.455
					Elasmobranchs	15	1.3	1.0	-24.3	0.271	28	0.9	0.7	-24.5	0.360

* Tows were dropped from analysis due to the low number of matched pairs.

** Generalized linear modeling (GLM) was not used to adjust randomization catch values for potential biases.

† Non-shrimp invertebrates

Table 4. North Carolina commercial shrimp trawl landings (all species) by vessel length and waterbody, 2007-2016 (NC Trip Ticket Program).

Waterbody	Vessel length		Vessels (10-year)		Trips (10-year)			Landings (10-year)		
	(Feet)	(Total number)	(% Total)	(Avg.)	(Total number)	(% Total)	(Avg.)	(Total number)	(% Total)	(Avg.)
Estuarine	0-15	99	2.6	10	294	0.7	29	74,368	0.1	7,437
	16 to 30	1,648	43.9	165	16,996	42.1	1,700	3,036,958	5.8	303,696
	31 to 45	765	20.4	77	10,597	26.3	1,060	5,839,690	11.2	583,969
	46 to 55	287	7.6	29	3,187	7.9	319	4,728,222	9.1	472,822
	> 55	956	25.5	96	9,275	23	928	38,563,295	73.8	3,856,329
State Ocean (0-3 mi)	0-15	9	0.7	2	21	0.1	4	30,802	0.2	5,134
	16 to 30	265	21	27	3,194	18.3	319	620,296	4.2	62,030
	31 to 45	292	23.2	29	4,640	26.6	464	1,708,624	11.6	170,862
	46 to 55	174	13.8	17	3,874	22.2	387	1,990,624	13.6	199,062
	> 55	519	41.2	52	5,721	32.8	572	10,333,660	70.4	1,033,366
Federal Ocean (3-200 mi)	0-15	3	2.5	3	5	1.6	5	1,289	0.1	1,289
	16 to 30	5	4.1	1	17	5.4	4	2,518	0.2	629
	31 to 45	13	10.7	2	31	9.9	5	11,109	1.1	1,852
	46 to 55	14	11.6	2	43	13.7	7	39,582	3.9	6,597
	> 55	86	71.1	10	217	69.3	24	968,016	94.7	107,557
Total (all waters)	0-15	111	2.2	7	320	0.6	525	106,459	0.2	6,262
	16 to 30	1,918	37.4	80	20,207	34.8	19	3,659,771	5.4	152,490
	31 to 45	1,070	20.8	41	15,268	26.3	842	7,559,424	11.1	290,747
	46 to 55	475	9.3	18	7,104	12.2	587	6,758,428	9.9	259,940
	> 55	1,561	30.4	54	15,213	26.2	273	49,864,971	73.4	1,719,482

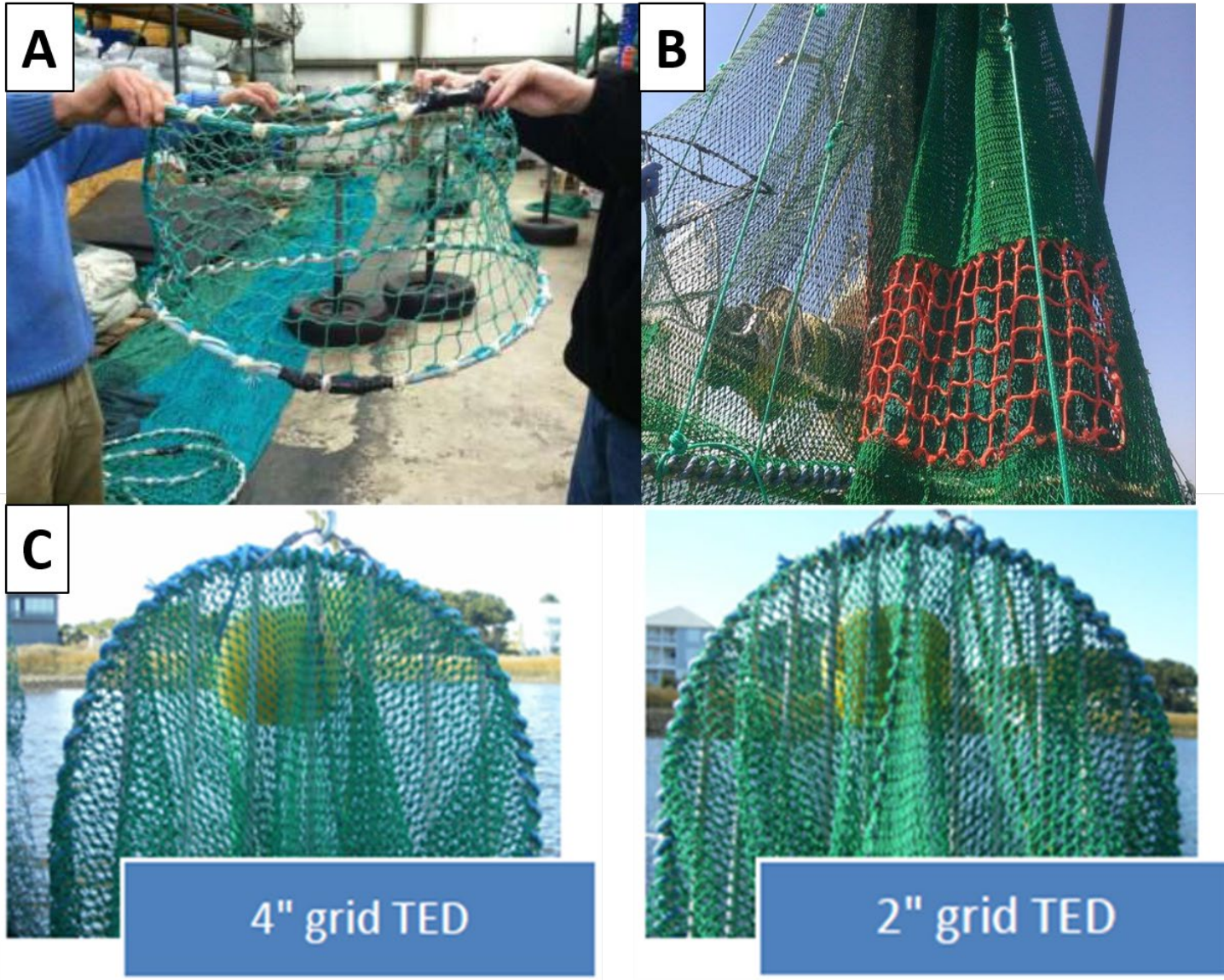


Figure 1. Newly approved BRDs as part of Amendment 1 to the NC Shrimp FMP: A) T-90 BRD, B) square mesh panel (skylight panel), and C) reduced bar spacing turtle excluder device (2-inch grid TED).

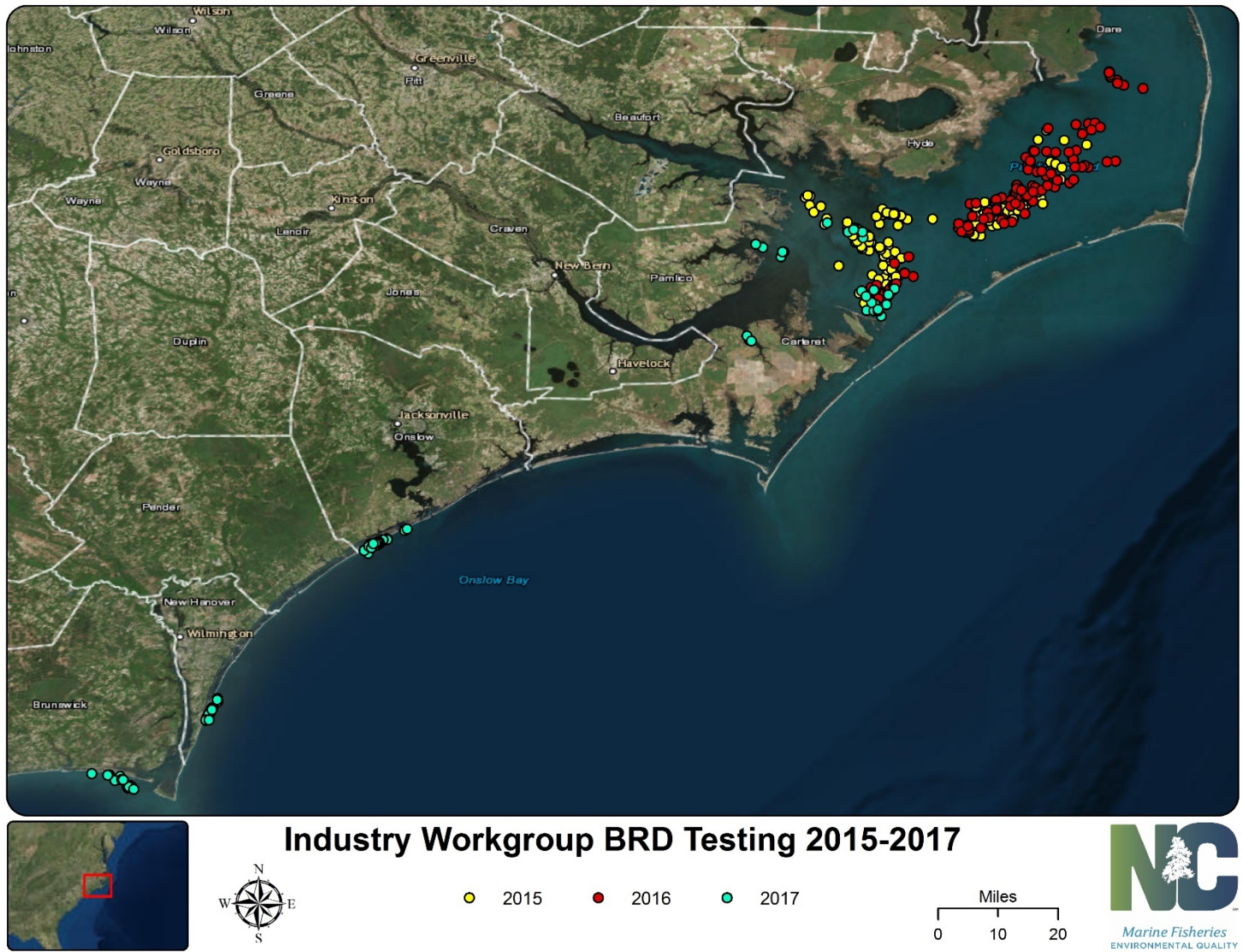


Figure 2. Location of Shrimp Bycatch Reduction Industry Workgroup shrimp trawl gear testing (all gears), 2015-2017.

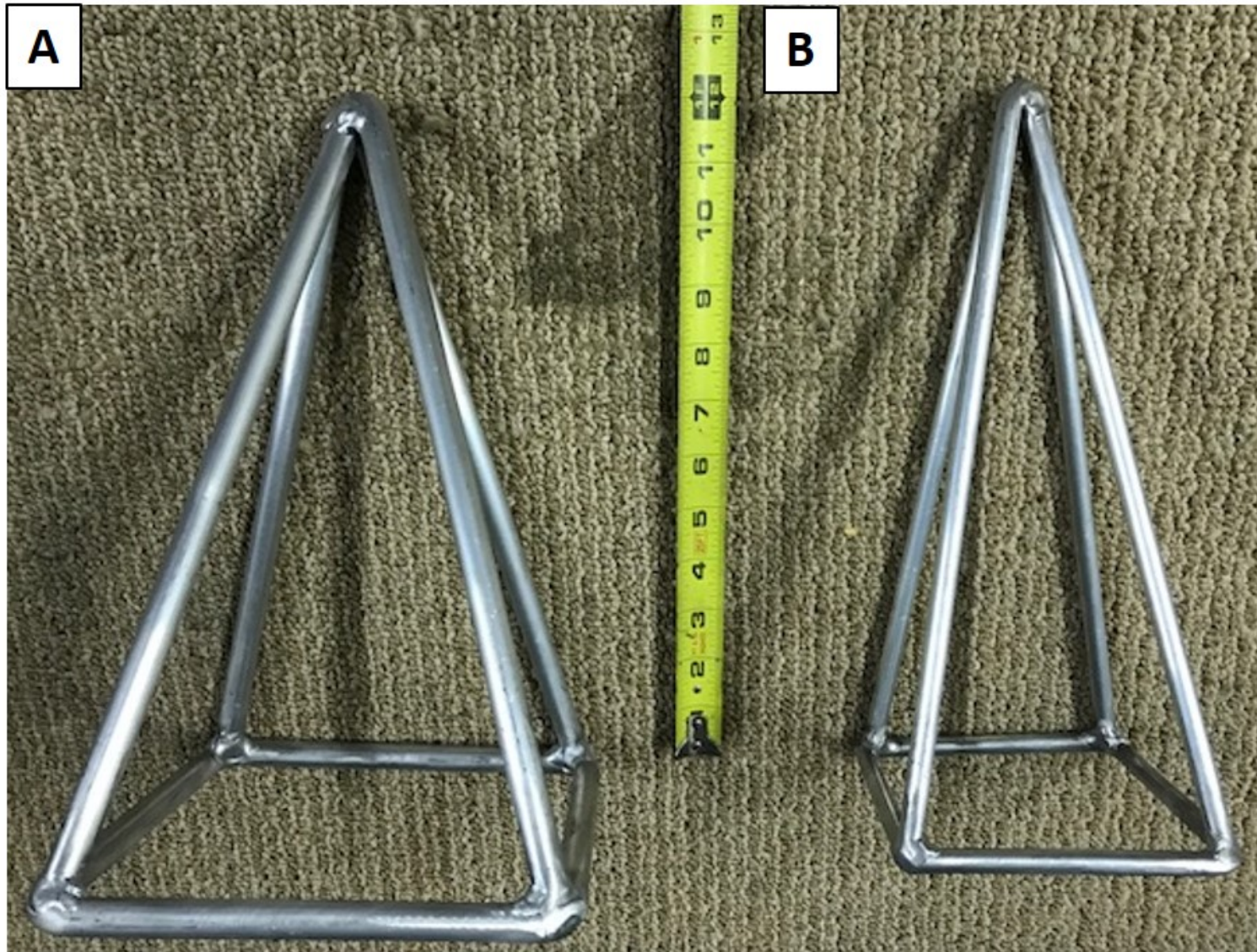
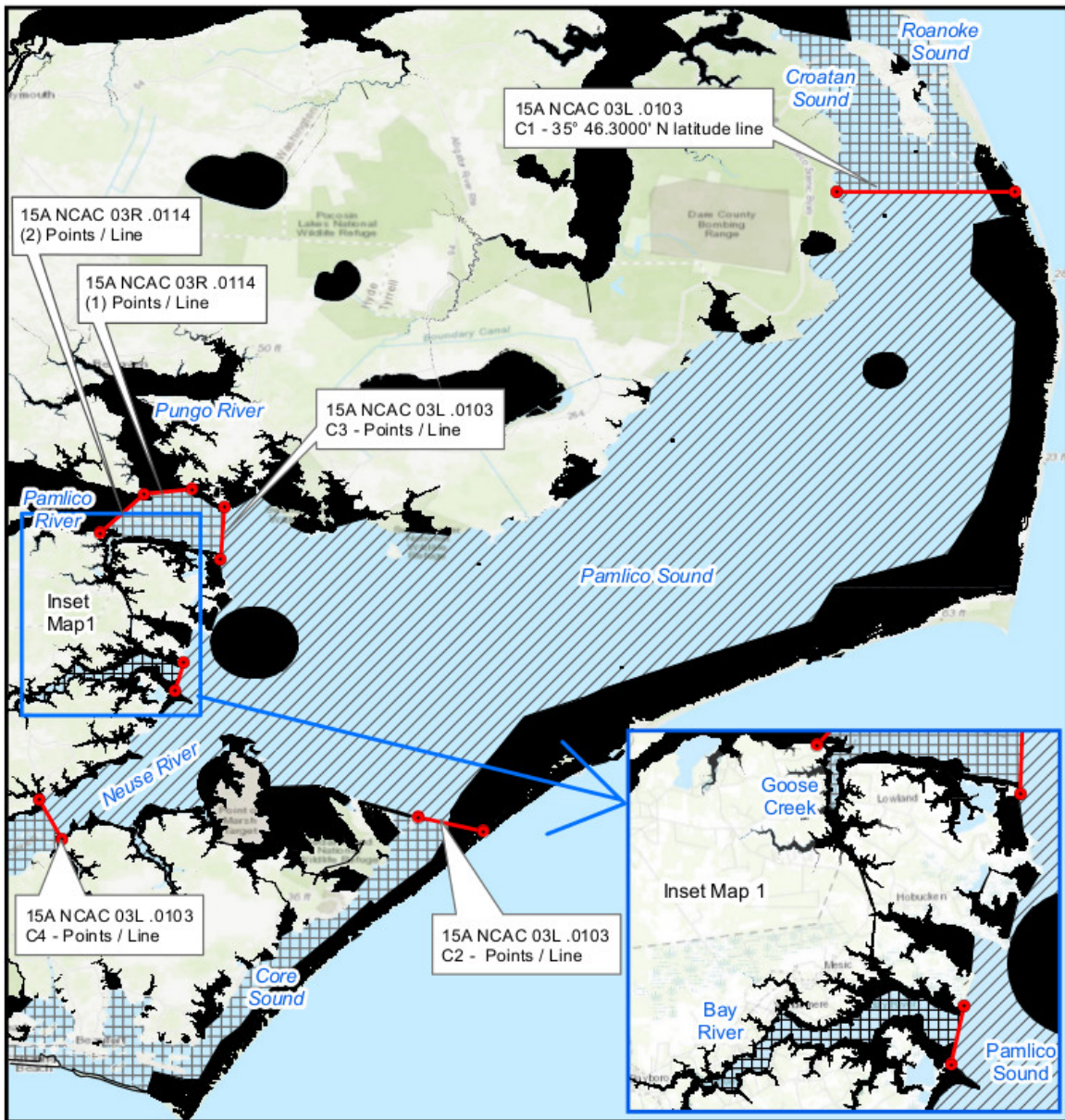


Figure 3. Federal fisheye BRD (A) compared to state fisheye BRD (B).



Prohibited and allowed areas for shrimp trawling

Figure 4. Location of area affected (combined headrope of 220 ft or greater prohibited) by proposed recommendations from the Shrimp Bycatch Reduction Industry Workgroup.

Appendix 1. MFC motions for Amendment 1 to the North Carolina Shrimp FMP to address bycatch.

In November 2013, prior to approving Amendment 1 for public comment the NCMFC passed a motion to:

Motion to add a recommendation to the draft Shrimp Fishery Management Plan Amendment 1 for a stakeholder group to initiate a three-year study testing minimum tailbag mesh T-90 (square mesh) panels, skylight panels, reduced bar spacing in turtle excluder devices and any other new methods of reducing unwanted finfish bycatch to achieve a minimum of a 40 percent reduction by weight compared to a control net with a Florida fish excluder, a federally approved turtle excluder device, and 1 1/2 inch mesh tailbag. The stakeholder group should partner with the Division of Marine Fisheries and N.C. Sea Grant to help secure funding for the study. If the target of a 40 percent reduction by weight in finfish is not achieved, further restrictions will be placed on the shrimp trawl industry to achieve the 40 percent reduction by weight. Those restrictions will be reviewed and discussed at that time.

Based on this motion management options examined in the FMP were separated into: 1) gear modifications, 2) effort management, 3) area restrictions, and 4) the use of other fishing gears. For each of these management options, issue papers were developed and presented to the Shrimp FMP Advisory Committee (AC), as well as the regional and standing advisory committees. Gear modifications evaluated included: tailbag mesh size, Turtle Excluder Devices (TEDs) with reduced bar spacing, T-90 tailbags, and Skylight Panels (Figure 1).

In February 2014, prior to the approval of the draft Shrimp FMP Amendment 1 for review by the Secretary of the Department of Environment and Natural Resources and the Joint Legislative Commission on Governmental Operations, the NCMFC passed a motion that became the final management strategy in Amendment 1 to address bycatch:

Motion to convene a stakeholder group to initiate industry testing of minimum tailbag mesh size, T-90 panels, skylight panels, and reduced bar spacing in turtle excluder devices to reduce bycatch to the extent practicable with a 40 percent target reduction. Upon securing funding, testing in the ocean and internal waters will consist of three years of data using test nets compared to a control net with a Florida Fish Eye, a federally-approved turtle excluder device and a 1.5-inch mesh tailbag. Results should minimize shrimp loss and maximize reduction of bycatch of finfish. Promising configurations will be brought back to the Marine Fisheries Commission for consideration for mandatory use. The stakeholder group may be partnered with the Division of Marine Fisheries and Sea Grant. Members should consist of fishermen, net/gear manufacturers and scientific/gear specialists.

The commission gave its final approval of the Shrimp Fishery Management Plan Amendment 1 and associated rules Feb. 19, 2015 and implementation of the rules came into effect May 1, 2015. Gear specific management strategies from Amendment 1 not only required the development of the stakeholder group and gear testing, but also required fishermen to use either a T-90/square mesh tailbag or other applications of square mesh panel (e.g., skylight panel), reduced bar spacing in a TED, or another federal or state certified bycatch reduction device (BRD) in addition to existing

TED and BRD requirements in all skimmer and otter trawls (Proclamation SH-2-2015, Appendix 4; Figure 1).

Appendix 2. List of industry workgroup members, collaborators, and guest presenters.

Workgroup members:

Steve Parrish, net maker, Supply (passed, replaced by Douglas Todd)
Kenny Midget, net maker, Wanchese
Brent Fulcher, fish house owner/industry leader, New Bern
Clyde Potter, fishermen, Hobucken
Stevie Davis, fishermen, Sneads Ferry
Clyde Phillips, fishermen, Swansboro
Kenny Rustick, fishermen (skimmer), Gloucester
John Broome, fishermen, Wilmington
Virgil Potter, net maker, Bayboro
Douglas Todd, fishermen, Supply (replaced Steve Parrish)
Gordon Winfree, net maker, Shallotte
Mikey Daniels, industry leader/fish house owner (previously), fishermen, Wanchese
David Jarvis, fishermen, Bear Creek (added in 2018, tested gear in 2017)
Robbie Metcalf, fishermen, Carolina Beach (added in 2018, tested gear in 2017)

Collaborators:

Kevin Brown, NCDMF
Laura Lee, NCDMF
Blake Price, NOAA-HSU
Scott Baker, N.C. Sea Grant
Sara Mirabilio, N.C. Sea Grant

Guest Presenters:

Pingguo He, U-Mass Dartmouth
Frank Helies, GSAF
Dan Foster, NOAA-HSU
Gary Graham, Texas Sea Grant
Steve Eayrs, GMRI

Appendix 3. Comments from absentee workgroup members on proposed recommendations.

Robbie Metcalf verbal communication 4/18/18:

- Supported all of the recommendations, but has some concern with any shrimp loss over 5%.
- He supports continuing the workgroup and gear testing and improving the gear survey.
- He always wants to make things better for the industry and what's best for the fishery.

Clyde Phillips phone conversation 4/19/18:

- Supported a phase in period.

David Jarvis phone conversation 4/19/18:

- Does not want to go on record recommending a range of acceptable shrimp loss; if finfish bycatch reduction is significant, a larger range could be acceptable (beyond range used by workgroup of 3%-5%).
 - Comments: Supportive, even 10% is acceptable if finfish loss is significant.
- Does want to recommend continued collaborative bycatch reduction research, specifically continuance of the N.C. Shrimp Bycatch Reduction Industry Workgroup, requesting that funding from gear testing possibly come from surplus funds from increased license fees (i.e., Commercial Fishing Resources Fund). Industry continues to be willing to provide in-kind contributions.
 - Comments: Fully supportive, willing to offer his vessel for continued testing.
- Does endorse for use on otter trawls fishing in inside waters (in areas where a combined head rope of 90-feet or greater is allowed as identified in the Shrimp FMP) the four combinations of bycatch reducing gears that met the target of 40% bycatch reduction, but specifically recommends:
 - Comments: Supportive with some reservations because these gears haven't been tested on small boats. Doesn't believe it will be a burden on the industry.
- Use of the combination gear of double Federal fisheyes, 4-inch TED and 1 ¾-inch tailbag, again, in inside waters where an otter trawl with a combined head rope of 90-feet or greater is allowed. (Specific intent is not to have this change applied to other areas open to otter trawls, channel nets, and skimmer trawls until further bycatch reduction testing has been completed.)
 - Comments: Supportive with some reservations because these gears haven't been tested on small boats. Doesn't believe it will be a burden on the industry.
- Recommends the N.C. Division of Marine Fisheries explores valid survey techniques to gather information on current bycatch reduction devices being used by industry.
 - Comments: Supports as long as they are valid techniques.

14 Apr 18

To: Kevin Brown

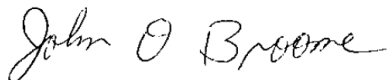
RE: Industry Workgroup Draft Recommendation to the Marine Fisheries Commission

Kevin: The recommendations set forth in the Memorandum dated 6 Apr 2018 seem very logical proposals based on the testing results thus far.

○ I totally agree that a range of acceptable shrimp loss should not arbitrarily be set. Any acceptable shrimp loss should be a function of the BRD's efficiency.

○ I work in the ocean off New Hanover County and Brunswick County and I have very little knowledge of the working conditions in Pamlico Sound. After conducting research with a FRG through N.C. Sea Grant (2" reduced spaced TED vrs. 4" spaced TED), I have been using 2" reduced spaced TED's as BRD's. Because of different conditions, such as large quantities of moss, a reduced spaced TED might not be the best BRD for Pamlico Sound or other areas. Because of this, I would like to defer to the boat owners that this proposal would affect.

○ The double Federal fisheye and 1 ¾ -inch tail bag produced the desired goal and should not be a burden for the boats affected.



John D. Broome

April 18, 2018.

Dear Marine Fisheries Commissioner,

My name is Kenny Rustick. I am a commercial fisherman from Carteret County, North Carolina and I serve on the Shrimp Industry Work Group. I was unable to attend the group's last meeting on April 4th, 2018 due to a prior surgery. I have been informed that several recommendations were voted on to pass onto the commission at it's May meeting.

I know one of the recommendations was for a 1 3/4" mesh tail bag. While the 1 3/4" mesh tail bag combined with other byrds showed a sizable reduction for the larger boats, it was never tested on the smaller boats like mine. I have tried this size tail bag before in the ocean on my boat and I noticed shrimp loss on 21/25 and 16/20 count shrimp. There were shrimp hanging out of the meshes on the tail bags when I would retrieve the trawls. I changed one tail bag to a 1 1/2" mesh and did not notice shrimp hanging out of the tail bag, and the 1 1/2" tail bag produced more shrimp.

Although this was by no means a scientific study, the 1 3/4" bags were a set of tail bags on a set of nets and turtle excluders I purchased. I tell you this because I believe we can reduce bycatch and do it with a minimal shrimp loss. I do believe we need more testing on the small boats. We could possibly try 1 5/8" and different byrd combinations. I have always found that what works for someone else might not work for me. So please give us some more time to find a combination of byrds that we know works for the small class boats.

Thank you for your time,

A handwritten signature in black ink, appearing to read "Kenny Rustick". The signature is written in a cursive style with a long, sweeping underline.

Kenny Rustick

Brown, Kevin

From: DOUGLAS TODD <dtodd@atmc.net>
Sent: Thursday, April 19, 2018 2:02 PM
To: Brown, Kevin
Subject: [External] Bycatch

CAUTION: External email. Do not click links or open attachments unless verified. Send all suspicious email as an attachment to Report Spam.

Kevin the only comment that I have got back is some of the them want to know if the one fisheye with the 3-inch or less TED is still going to be approved to be used. The rest on the inform they were good with. Thanks Douglas Todd

Brown, Kevin

From: stevie <steviedavis134@hotmail.com>
Sent: Thursday, April 19, 2018 3:22 PM
To: Brown, Kevin
Subject: [External] Recommendations

CAUTION: External email. Do not click links or open attachments unless verified. Send all suspicious email as an attachment to Report Spam.<mailto:report.spam@nc.gov>

I , Stevie Davis, support each of the recommendations the workgroup is proposing to the Marine Fisheries Commission
Stevie Davis
04/18/2018

Sent from my iPhone

Brown, Kevin

From: gordonsnet <gordonsnet@atmc.net>
Sent: Thursday, April 19, 2018 5:52 PM
To: Brown, Kevin
Subject: [External] Industry Workgroup Draft Recommendation to the Marine Fisheries Commission

CAUTION: External email. Do not click links or open attachments unless verified. Send all suspicious email as an attachment to Report Spam.

I, Gordon Winfree, owner Gordons' Networks Inc. agree with the draft recommendations to the Marine Fisheries Commission listed in the memorandum.

Sent from Mail for Windows 10

PROCLAMATION

RE: SHRIMP TRAWL BRD REQUIREMENTS

Dr. Louis B. Daniel III, Director, Division of Marine Fisheries, hereby announces that effective at 12:01 A.M. Monday, June 1, 2015 the following restrictions apply to shrimp trawls (otter and skimmer trawls):

I. **GEAR RESTRICTIONS:**

It is unlawful for a person to use a shrimp trawl in coastal fishing waters without an authorized North Carolina Division of Marine Fisheries (NCDMF) Bycatch Reduction Device(s) (BRD) properly installed and operational in the cod end of EACH net as outlined below. Authorized NCDMF BRDs include:

A. Florida Fish Excluder (FFE) (Figure 1 and Table 1):

1. Description: Cone-shaped rigid frame constructed from aluminum, steel, or stainless steel round bar or tubing which is inserted into the cod end to form an escape opening. Minimum construction and installation requirements stated below.
2. The FFE shall be installed on the outside of the trawl. The webbing of the trawl attached to the FFE cannot cover more than 50% of the FFE.
3. The escapement opening of the FFE shall be diamond in shape and shall remain unobstructed at all times. Diamond shaped FFE shall measure at least 5 1/2 inches x 6 1/2 inches or 6 inches x 6 inches, inside diameter (see Figure 1).
4. Placement of the apex (narrow end) of the FFE shall be toward the headrope of the trawl (forward).
5. A FFE shall have at least three (3) legs and no more than four (4) legs and measure at least 12 inches in length (see Figure 1).
6. The opening of the FFE shall be installed on the outside of the cod end of the trawl no further forward than 65% of the functional cod end length measured from the cod end tie-off rings (Table 1).
7. The center of the FFE escapement opening shall be installed no more than 19 meshes from the top centerline of the cod end.
8. A FFE shall be constructed from aluminum, steel, or stainless steel round bar or tubing.

B. Fisheye (Figures 2 and 3):

1. Description: The Fisheye BRD is a cone-shaped rigid frame constructed from aluminum or steel rod of at least $\frac{1}{4}$ inch (6.35 mm) diameter, which is inserted into the cod end to form an escape opening. Minimum construction and installation requirements stated below.
2. The Fisheye has a minimum escape opening dimension of 5 inches (12.7 cm) and a minimum total escape opening area of 36 in^2 (91.4 cm^2) [inside dimensions, not bar lengths] (Figure 2 and 3).
3. The Fisheye shall be installed on the outside of the trawl. The webbing of the trawl attached to the Fisheye cannot cover more than 50% of the Fisheye.
4. When the Fisheye BRD is installed, no part of the lazy line attachment system (i.e., any mechanism, such as elephant ears or choker straps, used to attach the lazy line to the cod end) may overlap the Fisheye escape opening when the Fisheye is installed aft of the attachment point of the cod end retrieval system. The escapement opening of the Fisheye BRD shall remain unobstructed at all times.
5. The Fisheye BRD must be installed at the top center of the cod end of the trawl to create an escape opening in the trawl facing the direction of the mouth of the trawl no further forward than 11 ft (3.4 m) from the cod end tie-off rings.
6. Placement of the apex (narrow end) of the Fisheye shall be toward the headrope of the trawl (forward).

C. Gulf Fisheye (Figures 2, 3, and 4):

1. Description: The Gulf Fisheye is a cone-shaped rigid frame constructed from aluminum or steel rod of at least $\frac{1}{4}$ inch (6.35 mm) diameter, which is inserted into the top center of the cod end, and is offset not more than 15 meshes perpendicular to the top center of the cod end to form an escape opening. Minimum construction and installation requirements stated below.
2. The Gulf Fisheye has a minimum escape opening dimension of 5 inches (12.7 cm) and a minimum total escape opening area of 36 in^2 (91.4 cm^2) [inside dimensions, not bar lengths] (Figure 2 and 3).
3. The Gulf Fisheye shall be installed on the outside of the trawl. The webbing of the trawl attached to the Gulf Fisheye cannot cover more than 50% of the Fisheye.
4. The Gulf Fisheye BRD must be installed in the cod end of the trawl to create an escape opening in the trawl, facing in the direction of the mouth of the trawl, no less than 8.5 ft (2.59 m) and no further forward than 12.5 ft (3.81 m) from the cod end tie-off rings, and may be offset no more than 15 meshes perpendicular to the top center of the cod end (Figure 4).

5. When the Gulf Fisheye BRD is installed, no part of the lazy line attachment system (i.e., any mechanism, such as elephant ears or choker straps, used to attach the lazy line to the cod end) may overlap the Fisheye escape opening when the Fisheye is installed aft of the attachment point of the cod end retrieval system. The escapement opening of the Gulf Fisheye shall remain unobstructed at all times.
6. Placement of the apex (narrow end) of the Gulf Fisheye shall be toward the headrope of the trawl (forward).

D. Eight (8) inch PVC "Sea Eagle" Fish Excluder (Figure 5 and Table 2):

1. Description: The "Sea Eagle" Fish Excluder is a cone-shaped device similar to the Florida Fish Excluder and is constructed out of PVC pipe and has a trap door that is designed to close on haul back to prevent escapement of shrimp. The device is inserted into the cod end to form an escapement opening. Minimum construction and installation requirements stated below.
2. Placement of the apex (narrow end) of the "Sea Eagle" shall face the cod end of the trawl (aft).
3. The opening of the "Sea Eagle" shall be eight (8) inches in diameter and installed in the cod end of the trawl no further forward than 38% of the functional cod end length from the cod end tie-off rings (Table 2).
4. The center of the "Sea Eagle" escapement opening shall be installed on either side of the cod end between 0 and 15 meshes from the top centerline of the cod end.
5. The escapement opening of the "Sea Eagle" shall be unobstructed (the escapement flap shall be free to move and a fish retention grate shall not be present).

E. General Eight (8) Inch and Ten (10) Inch Large Mesh and Extended Mesh Funnel BRD (Figures 6, 7, 8, 9, and 10):

1. Description: Devices consist of a funnel of small mesh netting within a cylinder of large mesh netting, held open by one semi-rigid hoop, and are installed in the trawl net behind a National Marine Fisheries Service (NMFS) certified Turtle Excluder Device (TED). One side of the funnel is extended vertically to provide passage for shrimp to the cod end and to create an area of reduced water flow to allow for fish escapement through the larger mesh outer netting. Minimum construction and installation requirements stated below.
2. The small mesh funnel and large mesh section shall be positioned within extension sections constructed of 1 5/8 inch stretched mesh # 30 nylon twine. The extension section shall be 120 meshes in circumference. The extension section in front of the large mesh section shall be 6 1/2 meshes long, and the extension section behind the large mesh section shall be 23 meshes long.
3. The small mesh funnel shall be constructed from four (4) pieces of 1 1/2 inch stretched mesh, size # 24 twine or larger, depth stretched and heat set polyethylene webbing.

4. The small mesh funnel shall have a circumference of 120 meshes at the leading edge and 78 meshes at the trailing edge. The short side of the funnel shall be 23 meshes long, while the long side of the funnel shall be 38 1/2 meshes long. The leading edge of the funnel shall be attached three (3) meshes forward of the leading edge of the large mesh section. The eight (8) meshes at the back edge of the top and bottom sections are attached three (3) meshes behind the soft cable hoop, and are centered at the top and bottom of the extension webbing, mesh for mesh. The long side section of the funnel shall be attached to the extension webbing on the top and bottom beginning at the back edge of the top and bottom section. The sewing sequence for this section shall be two (2) meshes down, one (1) mesh over toward the top and bottom centerlines.
5. The large mesh outer section shall be 10 inch stretched mesh netting, 10 mm polyester, or # 120 nylon or heavier, hung on the square, with a **circumference of 19 meshes (95 inches)** and a length of three (3) meshes (15"), or the large mesh outer section shall be 8 inch stretched mesh netting, 4 mm polyester, or # 120 nylon or heavier, hung on the square, **with a circumference of 23 meshes (95 inches)** and a length of four (4) meshes (15 inches").
6. The leading edge of the large mesh section shall be attached to the trailing edge of the front extension. The trailing edge of the large mesh outer section is attached to the leading edge of the back extension.
7. A single hoop, constructed from 1/2 inch (0.5 inch") plastic coated cable measuring **94 1/4 inch** in length (30 inch diameter), shall be attached five (5) meshes back from the leading edge of the back extension.
8. The large mesh escapement opening must be unobstructed.
9. This BRD is installed between the TED and the cod end. When installed behind a hard TED, the leading edge of the 6 1/2 mesh front extension is attached five (5) meshes behind the posterior edge (trailing edge) of the TED. Any part of the TED extension greater than five (5) meshes long must be removed. When installed behind a soft TED, the device is placed between the TED extension and the cod end.

F. Eight (8) Inch and Ten (10) Inch Inshore Large Mesh and Extended Funnel BRD (Figures 6, 7, 8, 9, and 10):

1. Description. Devices consist of a funnel of small mesh netting within a cylinder of large mesh netting, held open by one semi-rigid hoop, and are installed in the trawl net behind a National Marine Fisheries Service (NMFS) certified Turtle Excluder Device (TED). One side of the funnel is extended vertically to provide passage for shrimp to the cod end and to create an area of reduced water flow to allow for fish escapement through the larger mesh outer netting. Minimum construction and installation requirements stated below.
2. The small mesh funnel and large mesh section shall be positioned within extension sections constructed of 1 3/8 inch stretched mesh #18 nylon twine. The extension section shall be 120 meshes in circumference. The extension section in front of the large mesh section shall be 6 1/2 meshes long and the extension section behind the large mesh section shall be 23 meshes long.

3. The small mesh funnel shall be constructed from four (4) pieces of 1 3/8 inches stretched mesh, size # 18 twine or larger, depth stretched and heat set polyethylene webbing.
4. The small mesh funnel shall have a circumference of 120 meshes at the leading edge and 78 meshes at the trailing edge. The short side of the funnel shall be 23 meshes long, while the long side of the funnel shall be 38 1/2 meshes long. The leading edge of the funnel shall be attached three (3) meshes forward of the leading edge of the large mesh section. The eight (8) meshes at the back edge of the top and bottom sections are attached three (3) meshes behind the soft cable hoop and are centered at the top and bottom of the extension webbing, mesh for mesh. The long side section of beginning at the back edge of the top and bottom section. The funnel shall be attached to the extension's webbing on the top and bottom. The sewing sequence for this section shall be two (2) meshes down, one (1) mesh over toward the top and bottom centerlines.
5. The large mesh outer section shall be 10 inch stretched mesh netting, 10 mm polyester, or #120 nylon or heavier, hung on the square with a circumference of **14 1/2 meshes (75 inches)** and a length of three (3) meshes (15 inch), or the large mesh outer section shall be 8 inch stretched mesh netting, 4 mm polyester, or # 120 nylon or heavier, hung on the square, **with a circumference of 19 meshes (75 inch)** and a length of four (4) meshes (15 inch).
6. The leading edge of the large mesh section shall be attached to the trailing edge of the front extension. The trailing edge of the large mesh outer section is attached to the leading edge of the back extension.
7. A single hoop, constructed from 3/8 inch (0.38 inch) plastic coated cable measuring **75 1/2 inch** in length shall be attached five (5) meshes back from the leading edge of the back extension.
8. The large mesh escapement opening must be unobstructed.
9. This BRD is installed between the TED and the cod end. When installed behind a hard TED, the leading edge of the 6 1/2 mesh front extension is attached five (5) meshes behind the posterior edge (trailing edge) of the TED. Any part of the TED extension greater than five (5) meshes long must be removed. When installed behind a soft TED, the device is placed between the TED extension and the cod end.

G. Large Mesh Funnel Excluder (LMFE) (Figures 6,7,8, 9, and 10):

1. Description. This device consists of a funnel of small mesh netting within a cylinder of larger mesh netting, held open by two (2) semi-rigid hoops, and is installed in the cod end of the trawl. This device must be installed behind a NMFS certified TED if a TED is required. This BRD shall meet the following specifications:
2. The small mesh funnel shall be made from two (2) sections of 1 1/2 inch or 1 5/8 inch, # 24 twine or larger, depth stretched and heat set polyethylene webbing. Funnels having a leading edge of 100 meshes circumference must have a trailing edge of at least 40 meshes and not more than 60 meshes circumference. The funnel

must be 30 meshes long. Funnels having a leading edge of 120 meshes circumference must have a trailing edge of at least 60 meshes and not more than 80 meshes in circumference. The funnel must be 30 meshes long.

3. The mesh escapement section shall be no smaller than 19 inch long and shall be 94 1/2 inch in circumference.
4. The large mesh escapement webbing shall be made from no smaller than 4 inch stretched mesh webbing hung on a square.
5. The mesh escapement opening shall remain unobstructed at all times.
6. The leading edge of the small mesh funnel and the leading edge of the large mesh escapement webbing shall be attached to a hoop, 94 1/2 inch in length (30 inch diameter), made from at least 3/8 inch diameter combination-cable or plastic coated towing cable. The trailing edge of the large mesh escapement webbing shall be attached to the second hoop constructed identical to the forward hoop.
7. The top and bottom ends of the trailing edge of the small funnel shall be attached to the top and bottom of the cod end, respectively, so the funnel remains taut while being towed.

H. Jones-Davis:

1. Description. The Jones-Davis BRD is similar to the expanded mesh and the extended funnel BRDs except that the fish escape openings are windows cut around the funnel rather than large-mesh sections. In addition, a webbing cone fish deflector is installed behind the funnel. Minimum construction and installation requirements stated below.
2. Webbing extension. The webbing extension must be constructed from a single piece of 1 5/8 inch (3.5 cm) stretch mesh # 30 nylon 42 meshes by 120 meshes. A tube is formed from the extension webbing by sewing the 42-mesh side together.
3. 28 inch (71.1cm) cable hoop. A single hoop must be constructed of 1/2 inch (1.3 cm) steel cable 88 inch (223.5 cm) in length. The cable must be joined at its ends by a 3 inch (7.6 cm) piece of 1/2 inch (1.3 cm) aluminum pipe and pressed with a 3/8 inch (0.95 cm) die to form a hoop. The inside diameter of this hoop must be between 27 and 29 inches (68.6 and 73.7 cm). The hoop must be attached to the extension webbing 17 1/2 meshes behind the leading edge. The extension webbing must be quartered and attached in four places around the hoop, and every other mesh must be attached all the way around the hoop using # 24 twine or larger. The hoop must be laced with 3/8 inch (0.95 cm) polypropylene or polyethylene rope for chaffing.
4. 24 inch (61.0 cm) hoop. A single hoop must be constructed of either # 60 twine 80 inches (203.2 cm) in length or 3/8 inch (0.95 cm) steel cable 75 1/2 inches (191.8 cm) in length. If twine is used, the twine must be laced in and out of the extension webbing 39 meshes behind the leading edge, and the ends must be tied together. If cable is used, the cable must be joined at its ends by a 3 inch (7.6 cm) piece of 3/8 inch (0.95 cm) aluminum pipe and pressed together with a 1/4 inch (0.64 cm) die to form a hoop. The inside diameter of this hoop must be between 23 and 25 inches

- (58.4 and 63.4 cm). The hoop must be attached to the extension webbing 39 meshes behind the leading edge. The extension webbing must be quartered and attached in four places around the hoop, and every other mesh must be attached all the way around the hoop using # 24 twine or larger. The hoop must be laced with 3/8 inch (0.95 cm) polypropylene or polyethylene rope for chaffing.
5. Funnel. The funnel must be constructed from four sections of 1 1/2 inch (3.8 cm) heat-set and depth-stretched polypropylene or polyethylene webbing. The two side sections must be rectangular in shape, 29 1/2 meshes on the leading edge by 23 meshes deep. The top and bottom sections are 29 1/2 meshes on the leading edge by 23 meshes deep and tapered 1 point 2 bars on both sides down to 8 meshes across the back. The four sections must be sewn together down the 23 mesh edge to form the funnel.
 6. Attachment of the funnel in the webbing extension. The funnel must be installed two meshes behind the leading edge of the extension starting at the center seam of the extension and the center mesh of the funnel's top section leading edge. On the same row of meshes, the funnel must be sewn evenly all the way around the inside of the extension. The funnel's top and bottom back edges must be attached one mesh behind the 28 inch (71.1 cm) cable hoop (front hoop). Starting at the top center seam, the back edge of the top funnel section must be attached 4 meshes each side of the center. Counting around 60 meshes from the top center, the back edge of the bottom section must be attached 4 meshes on each side of the bottom center. Clearance between the side of the funnel and the 28 inch (71.1 cm) cable hoop (front hoop) must be at least 6 inches (15.2 cm) when measured in the hanging position.
 7. Cutting the escape openings. The leading edge of the escape opening must be located within 18 inches (45.7 cm) of the posterior edge of the turtle excluder device (TED) grid. The area of the escape opening must total at least 864 in² (5,574.2 cm²). Two escape openings 10 meshes wide by 13 meshes deep must be cut 6 meshes apart in the extension webbing, starting at the top center extension seam, 3 meshes back from the leading edge and 16 meshes to the left and to the right (total of four openings). The four escape openings must be double-selvaged for strength. The escape openings shall remain unobstructed at all times.
 8. Alternative Method for Constructing the Funnel and Escape Openings. The following method for constructing the funnel and escape openings may be used instead of the method described in paragraphs F.2.d., F.2.e., and F.2.f. of this section. With this alternative method, the funnel and escape openings are formed by cutting a flap in each side of the extension webbing; pushing the flaps inward; and attaching the top and bottom edges along the bars of the extension webbing to form the V-shape of the funnel. Minimum requirements applicable to this method include: (1) The funnel's top and bottom back edges must be attached one mesh behind the 28 inch (71.1 cm) cable hoop (front hoop); (2) clearance between the side of the funnel and the 28 inch (71.1 cm) cable hoop (front hoop) must be at least 6 inches (15.2 cm) when measured in the hanging position; (3) the leading edge of the escape opening must be located within 18 inches (45.7 cm) of the posterior edge of the turtle excluder device (TED) grid; and, (4) the area of the escape opening must total at least 864 in² (5,574.2 cm²). To construct the funnel and escape openings using this method, begin 3 1/2 meshes from the leading edge of the extension, at the top center seam, count over 18 meshes on each side, and cut 13 meshes toward the back of the

extension. Turn parallel to the leading edge, and cut 26 meshes toward the bottom center of the extension. Next, turn parallel to the top center seam, and cut 13 meshes forward toward the leading edge, creating a flap of webbing 13 meshes by 26 meshes by 13 meshes. Lengthen the flap to 18 meshes by adding a 4 1/2 mesh by 26 mesh rectangular section of webbing to the 26 mesh edge. Attach the 18 mesh edges to the top and bottom of the extension by sewing 2 bars of the extension to 1 mesh on the flap in toward the top center and bottom center of the extension, forming the exit opening and the funnel. Connect the two flaps together in the center with a 7 inch piece of # 42 twine to allow adequate clearance for fish escapement between the flaps and the side openings. On each side, sew a 6-mesh by 10 1/2 mesh section of webbing to 6 meshes of the center of the 26 mesh cut on the extension and 6 meshes centered between the 13 mesh cuts 3 1/2 meshes from the leading edge. This forms two 10 mesh by 13 mesh openings on each side.

9. Cone fish deflector: The cone fish deflector is constructed of two pieces of 1 5/8 inch (4.13 cm) polypropylene or polyethylene webbing, 40 meshes wide by 20 meshes in length and cut on the bar on each side forming a triangle. Starting at the apex of the two triangles, the two pieces must be sewn together to form a cone of webbing. The apex of the cone fish deflector must be positioned within 10-14 inches (25.4-35.6 cm) of the posterior edge of the funnel.
10. 11 inch (27.9 cm) cable hoop for cone deflector. A single hoop must be constructed of 5/16 inch (0.79 cm) or 3/8 inch (0.95 cm) cable 34 1/2 inches (87.6 cm) in length. The ends must be joined by a 3 inch (7.6 cm) piece of 3/8 inch (0.95 cm) aluminum pipe pressed together with a 1/4 inch (0.64 cm) die. The hoop must be inserted in the webbing cone, attached 10 meshes from the apex and laced all the way around with heavy twine.
11. Installation of the cone in the extension: The cone must be installed in the extension 12 inches (30.5 cm) behind the back edge of the funnel and attached in four places. The midpoint of a piece of # 60 twine 4 ft (1.22 m) in length must be attached to the apex of the cone. This piece of twine must be attached to the 28 inch (71.1 cm) cable hoop at the center of each of its sides; the points of attachment for the two pieces of twine must be measured 20 inches (50.8 cm) from the midpoint attachment. Two 8 inch (20.3 cm) pieces of # 60 twine must be attached to the top and bottom of the 11 inch (27.9 cm) cone hoop. The opposite ends of these two pieces of twine must be attached to the top and bottom center of the 24 inch (61 cm) cable hoop; the points of attachment for the two pieces of twine must be measured 4 inches (10.2 cm) from the points where they are tied to the 11 inch (27.9 cm) cone hoop.

I. Modified Jones-Davis:

1. Description: The Modified Jones-Davis BRD is a variation to the alternative funnel construction method of the Jones-Davis BRD except the funnel is assembled by using depth-stretched and heat-set polyethylene webbing instead of the flaps formed from the extension webbing. In addition, no hoops are used to hold the BRD open. Minimum construction and installation requirements stated below.
2. Webbing extension: The webbing extension must be constructed from a single rectangular piece of 1 5/8 inch (4.1 cm) stretch mesh # 30 nylon with dimensions of 39

1/2 meshes by 150 meshes. A tube is formed from the extension webbing by sewing the 39 1/2 mesh sides together.

3. Funnel: The funnel must be constructed from two sections of 1 5/8 inch (4.1 cm) heat-set and depth-stretched polypropylene or polyethylene webbing. The two side sections must be rectangular in shape, 25 meshes on the leading edge by 21 meshes deep. The 25 mesh leading edge of each polyethylene webbing section must be sewn evenly two meshes in from the front of the extension webbing starting 25 meshes from the top center on each side. The 21 mesh edge must be sewn to the extension webbing on a 9 bar and 1 mesh angle in the top and bottom, forming a V-shape funnel.
4. Cutting the escape opening. The leading edge of the escape openings must be located within 18 inches (45.7 cm) of the posterior edge of the turtle excluder device (TED) grid. The area of the escape opening must total at least 635 in² (4,097 cm²). Two escape openings, 6 meshes wide by 12 meshes deep, must be cut 4 meshes apart in the extension webbing, starting at the top center extension seam, 7 meshes back from the leading edge, and 30 meshes to the left and to the right (total of four openings). The four escape openings must be double-selvaged for strength. The four escape openings shall remain unobstructed at all times.
5. Cone fish deflector. The cone fish deflector is constructed of 2 pieces of 1 5/8 inch (4.1 cm) polypropylene or polyethylene webbing, 40 meshes wide by 20 meshes in length and cut on the bar on each side forming a triangle. Starting at the apex of the two triangles, the two pieces must be sewn together to form a cone of webbing. The apex of the cone fish deflector must be positioned within 12 inches (30.5 cm) of the posterior edge of the funnel.
6. 11 inch (27.9 cm) cable hoop for cone deflector. A single hoop must be constructed of 5/16 inch (0.79 cm) or 3/8 inch (0.95 cm) cable 34 1/2 inches (87.6 cm) in length. The ends must be joined by a 3 inch (7.6 cm) piece of 3/8 inch (0.95 cm) aluminum pipe pressed together with a 1/4 inch (0.64 cm) die. The hoop must be inserted in the webbing cone, attached 10 meshes from the apex and laced all the way around with heavy twine.
7. Installation of the cone in the extension. The apex of the cone must be installed in the extension within 12 inches (30.5 cm) behind the back edge of the funnel and attached in four places. The midpoint of a piece of # 60 twine (or at least 4-mesh wide strip of # 21 or heavier webbing) 3 ft (1.22 m) in length must be attached to the apex of the cone. This piece of twine or webbing must be attached within 5 meshes of the aft edge of the funnel at the center of each of its sides. Two 12 inch (30.5 cm) pieces of # 60 (or heavier) twine must be attached to the top and bottom of the 11 inch (27.9 cm) cone hoop. The opposite ends of these two pieces of twine must be attached to the top and bottom center of the extension webbing to keep the cone from inverting into the funnel.

J. Cone Fish Deflector Composite Panel:

1. Description. The Cone Fish Deflector Composite Panel BRD is a variation to the alternative funnel construction method of the Jones-Davis BRD, except the funnel is assembled by using depth-stretched and heat-set polyethylene webbing with square mesh panels on the inside instead of the flaps formed from the extension webbing. In

addition, no hoops are used to hold the BRD open. Minimum construction and installation requirements stated below.

2. Webbing extension. The webbing extension must be constructed from a single rectangular piece of 1 1/2 inch to 1 3/4 inch (3.8 cm to 4.5 cm) stretch mesh with dimensions of 24 1/2 meshes by 150 to 160 meshes. A tube is formed from the extension webbing piece by sewing the 24 1/2 mesh sides together. The leading edge of the webbing extension must be attached no more than 4 meshes from the posterior edge of the TED grid.
3. Funnel. The V-shaped funnel consists of two webbing panels attached to the extension along the leading edge of the panels. The top and bottom edges of the panels are sewn diagonally across the extension toward the center to form the funnel. The panels are 2-ply in design, each with an inner layer of 1 1/2 inch to 1 5/8 inch (3.8 cm to 4.1 cm) heat-set and depth-stretched polyethylene webbing and an outer layer constructed of no larger than 2 inch (5.1 cm) square mesh webbing (1 inch bar). The inner webbing layer must be rectangular in shape, 36 meshes on the leading edge by 20 meshes deep. The 36 mesh leading edges of the polyethylene webbing should be sewn evenly to 24 meshes of the extension webbing 1 1/2 meshes from and parallel to the leading edge of the extension starting 12 meshes up from the bottom center on each side. Alternately sew 2 meshes of the polyethylene webbing to 1 mesh of the extension webbing then 1 mesh of the polyethylene webbing to 1 mesh of the extension webbing toward the top. The bottom 20 mesh edges of the polyethylene layers are sewn evenly to the extension webbing on a 2 bar 1 mesh angle toward the bottom back center forming a V-shape in the bottom of the extension webbing. The top 20 mesh edges of the polyethylene layers are sewn evenly along the bars of the extension webbing toward the top back center. The square mesh layers must be rectangular in shape and constructed of no larger than 2 inch (5.1 cm) webbing that is 18 inches (45.7 cm) in length on the leading edge. The depth of the square mesh layer must be no more than 2 inches (5.1 cm) less than the 20 mesh side of the inner polyethylene layer when stretched taught. The 18 inch (45.7 cm) leading edge of each square mesh layer must be sewn evenly to the 36 mesh leading edge of the polyethylene section and the sides are sewn evenly (in length) to the 20 mesh edges of the polyethylene webbing. This will form a V-shape funnel using the top of the extension webbing as the top of the funnel and the bottom of the extension webbing as the bottom of the funnel.
4. Cutting the escape opening. There are two escape openings on each side of the funnel. The leading edge of the escape openings must be located on the same row of meshes in the extension webbing as the leading edge of the composite panels. The lower openings are formed by starting at the first attachment point of the composite panels and cutting 9 meshes in the extension webbing on an even row of meshes toward the top of the extension. Next, turn 90 degrees and cut 15 points on an even row toward the back of the extension webbing. At this point turn and cut 18 bars toward the bottom front of the extension webbing. Finish the escape opening by cutting 6 points toward the original starting point. The top escape openings start 5 meshes above and mirror the lower openings. Starting at the leading edge of the composite panel and 5 meshes above the lower escape opening, cut 9 meshes in the extension on an even row of meshes toward the top of the extension. Next, turn 90 degrees, and cut 6 points on an even row toward the back of the extension webbing. Then cut 18 bars toward the bottom back of the extension. To complete the

escape opening, cut 15 points forward toward the original starting point. The area of each escape opening must total at least 212 in² (1,368 cm²). The four escape openings must be double-selvaged for strength. The four escape openings shall be unobstructed at all times.

5. Cone fish deflector. The cone fish deflector is constructed of 2 pieces of 1 5/8 inch (4.1 cm) polypropylene or polyethylene webbing, 40 meshes wide by 20 meshes in length and cut on the bar on each side forming a triangle. Starting at the apex of the two triangles, the two pieces must be sewn together to form a cone of webbing. The apex of the cone fish deflector must be positioned within 12 inches (30.5 cm) of the posterior edge of the funnel.
6. 11 inch (27.9 cm) cable hoop for cone deflector. A single hoop must be constructed of 5/16 inch (0.79 cm) or 3/8 inch (0.95 cm) cable 34 1/2 inches (87.6 cm) in length. The ends must be joined by a 3 inch (7.6 cm) piece of 3/8 inch (0.95 cm) aluminum pipe pressed together with a 1/4 inch (0.64 cm) die. The hoop must be inserted in the webbing cone, attached 10 meshes from the apex and laced all the way around with heavy twine.
7. Installation of the cone in the extension. The apex of the cone must be installed in the extension within 12 inches (30.5 cm) behind the back edge of the funnel and attached in four places. The midpoint of a piece of # 60 twine (or at least 4-mesh wide strip of # 21 or heavier webbing) 3 ft (1.22 m) in length must be attached to the apex of the cone. This piece of twine or webbing must be attached within 5 meshes of the aft edge of the funnel at the center of each of its sides. Two 12 inch (30.5 cm) pieces of # 60 (or heavier) twine must be attached to the top and bottom of the 11 inch (27.9 cm) cone hoop. The opposite ends of these two pieces of twine must be attached to the top and bottom center of the extension webbing to keep the cone from inverting into the funnel.

K. Square Mesh Panel (SMP) Composite Panel:

1. Description. The SMP is a panel of square mesh webbing placed in the top of the cod end to provide finfish escape openings. Minimum construction and installation requirements stated below.
2. Webbing extension. The webbing extension must be constructed from a single rectangular piece of 1 1/2 inch to 1 3/4 inch (3.8 cm to 4.5 cm) stretch mesh with dimensions of 24 1/2 meshes by 150 to 160 meshes. A tube is formed from the extension webbing piece by sewing the 24 1/2 mesh sides together. The leading edge of the webbing extension must be attached no more than 4 meshes from the posterior edge of the TED grid.
3. Funnel. The V-shaped funnel consists of two webbing panels attached to the extension along the leading edge of the panels. The top and bottom edges of the panels are sewn diagonally across the extension toward the center to form the funnel. The panels are 2-ply in design, each with an inner layer of 1 1/2 inch to 1 5/8 inch (3.8 cm to 4.1 cm) heat-set and depth-stretched polyethylene webbing and an outer layer constructed of no larger than 2 inch (5.1 cm) square mesh webbing (1 inch bar). The inner webbing layer must be rectangular in shape, 36 meshes on the leading edge by 20 meshes deep. The 36 mesh leading edges of the polyethylene

webbing should be sewn evenly to 24 meshes of the extension webbing 1 1/2 meshes from and parallel to the leading edge of the extension starting 12 meshes up from the bottom center on each side. Alternately sew 2 meshes of the polyethylene webbing to 1 mesh of the extension webbing then 1 mesh of the polyethylene webbing to 1 mesh of the extension webbing toward the top. The bottom 20 mesh edges of the polyethylene layers are sewn evenly to the extension webbing on a 2 bar 1 mesh angle toward the bottom back center forming a V-shape in the bottom of the extension webbing. The top 20 mesh edges of the polyethylene layers are sewn evenly along the bars of the extension webbing toward the top back center. The square mesh layers must be rectangular in shape and constructed of no larger than 2 inch (5.1 cm) webbing that is 18 inches (45.7 cm) in length on the leading edge. The depth of the square mesh layer must be no more than 2 inches (5.1 cm) less than the 20 mesh side of the inner polyethylene layer when stretched taught. The 18 inch (45.7 cm) leading edge of each square mesh layer must be sewn evenly to the 36 mesh leading edge of the polyethylene section and the sides are sewn evenly (in length) to the 20 mesh edges of the polyethylene webbing. This will form a V-shape funnel using the top of the extension webbing as the top of the funnel and the bottom of the extension webbing as the bottom of the funnel.

4. Cutting the escape opening. There are two escape openings on each side of the funnel. The leading edge of the escape openings must be located on the same row of meshes in the extension webbing as the leading edge of the composite panels. The lower openings are formed by starting at the first attachment point of the composite panels and cutting 9 meshes in the extension webbing on an even row of meshes toward the top of the extension. Next, turn 90 degrees and cut 15 points on an even row toward the back of the extension webbing. At this point turn and cut 18 bars toward the bottom front of the extension webbing. Finish the escape opening by cutting 6 points toward the original starting point. The top escape openings start 5 meshes above and mirror the lower openings. Starting at the leading edge of the composite panel and 5 meshes above the lower escape opening, cut 9 meshes in the extension on an even row of meshes toward the top of the extension. Next, turn 90 degrees, and cut 6 points on an even row toward the back of the extension webbing. Then cut 18 bars toward the bottom back of the extension. To complete the escape opening, cut 15 points forward toward the original starting point. The area of each escape opening must total at least 212 in² (1,368 cm²). The four escape openings must be double-selvaged for strength. The four escape openings shall remain unobstructed at all times.
5. SMP. The SMP is constructed from a single piece of square mesh webbing with a minimum dimension of 5 squares wide and 12 squares in length with a minimum mesh size of 3 inch (76 mm) stretched mesh. The maximum twine diameter of the square mesh is # 96 twine (4 mm).
6. Cutting the SMP escape opening. The escape opening is a rectangular hole cut in the top center of the cod end webbing. The posterior edge of the escape opening must be placed no farther forward than 8 ft (2.4 m) from the cod end drawstring (tie-off rings). The width of the escape opening, as measured across the cod end, must be four cod end meshes per square of the SMP (i.e., a cut of 20 cod end meshes for a SMP that is 5 meshes wide). The stretched mesh length of the escape opening must be equal to the total length of the SMP. No portion of the SMP escape opening may be covered with additional material or netting such as chaffing webbing, which

might impede or prevent fish escapement.

7. Installation of the SMP. The SMP must be attached to the edge of the escape opening evenly around the perimeter of the escape opening cut with heavy twine.

II. **SECOND BRD REQUIREMENTS:**

It is unlawful for a person to use a shrimp trawl in coastal fishing waters **without a second Authorized North Carolina Division of Marine Fisheries (NCDMF) Bycatch Reduction Device(s) (BRD)** as outlined in Section I. **OR** an additional Ancillary BRD, both operational and properly installed in each net. Ancillary BRDs include:

- A. Reduced bar spacing in a TED, to be considered ancillary BRD the bar spacing in the TED shall not exceed three inches from inside edge to inside edge of bars.
- B. If the primary BRD is a Florida Fish Excluder (Section I. A.), and the second authorized BRD is a FFE then the second Florida Fish Excluder shall be installed in accordance with section I.A. with the exception that the second FFE can be installed no further forward than 5 meshes from the apex of the primary FFE and the same distance from the centerline as the primary FFE with the apex of the second FFE facing the headrope of the trawl and shall be exempt from requirement I.A.5. as to the 65% placement of the FFE.
- C. A T-90 or square mesh (T-45) cod end shall be installed in a minimum of ½ the effective cod end length.
- D. T-90 or square mesh (T-45) panels shall be constructed with a minimum of 2 inch stretched mesh, cover a minimum of the top 1/3 of the effective circumference of the cod end, be a minimum of 3 feet in length, and shall be installed no further forward than 6 feet from the cod end tie-off rings.

III. **EXEMPTIONS:**

These BRD restrictions do not apply to a single test trawl net (try net) with a headrope length of 16 feet or less, if it is operated under the following conditions:

- A. net is either pulled immediately in front of another net or is not connected to another net in any way;
- B. no more than one net is used at a time; and
- C. net is not towed as a primary net.

IV. **DEFINITIONS:** For the purposes of this proclamation, the following terms are hereby defined:

- A. Bycatch reduction device (BRD) - any gear or trawl modification (including modifications to a TED that would enhance finfish exclusion) designed to allow finfish to escape from a shrimp trawl. BRD is defined based on its ability to facilitate the escape of finfish from a shrimp trawl.
- B. Turtle Excluder Device (TED) - An inclined grid or netting panel that prevents the passage of large animals such as sea turtles and large fish into the cod end and guides

them through an escape opening located in the cod end. TED is defined based on its ability to exclude sea turtles from a shrimp trawl.

- C. Tail bag/Cod end - That portion of the trawl net at which the trawl bodies taper ends and the straight extension begins, extending to the terminal end of the trawl.
- D. Functional Cod end Length - That length of the cod end of a trawl beginning at the cod end tie-off rings and extending forward for a maximum of 105 meshes or to the point where the straight extension ends and the trawl body taper begins, whichever is less. Trawls utilizing short cod ends may include those meshes of the TED extension that are behind the TED grid and are in-line with the center of the FFE escape opening.
- E. Centerline - The line running from the center point of the headrope to the top center of the end of the cod end.
- F. T-90 – Webbing turned 90°.

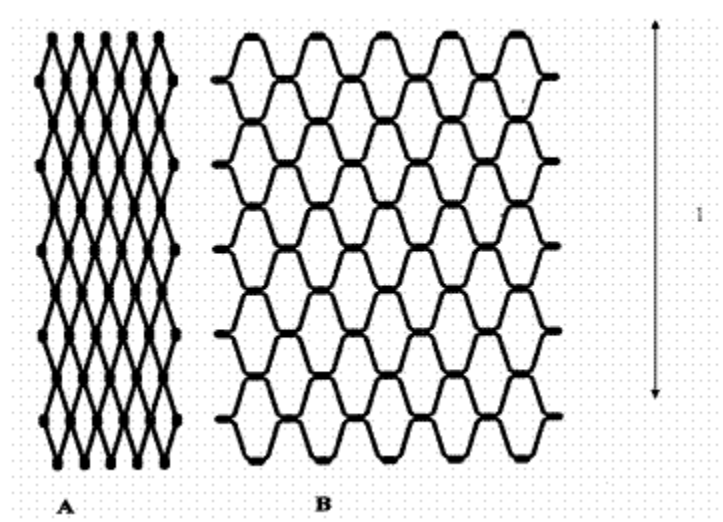


Illustration of (A) traditional (T-0) webbing and (B) T-90 webbing.

- G. Square mesh panel (T-45) – Webbing turned 45°, such that panels are sewed in with the bar width facing the headrope.

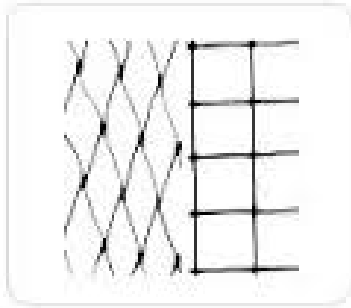


Illustration of traditional (T-0) webbing and square mesh (T-45) webbing.

V. GENERAL INFORMATION:

- A. This proclamation is issued under the authority of N.C.G.S. 113-170.4; 113-170.5; 113-182; 143B-289.52 and N.C. Marine Fisheries Rule 15A NCAC 3J .0104(d).
- B. The Florida Fish Excluder (I. A.) is measured diagonally from inside one corner edge to the inside edge of the opposite corner while the Fisheye (I.B.) and the Gulf Fisheye (I.C) are measured by measuring two inside leg lengths and multiplying those two distances to calculate the total square inches of the opening.
- C. It is unlawful to violate the provisions of any proclamation issued by the Fisheries Director under his delegated authority per N.C. Fisheries Rule 15A NCAC 3H .0103.
- D. Channel nets, float nets, fixed nets, and butterfly nets are not required to use BRDs.
- E. The intent of this proclamation is to allow federal approved bycatch reduction devices to be approved as state bycatch reduction devices and to require a second authorized BRD in accordance with the N.C. Shrimp Fishery Management Plan Amendment 1.
- F. Persons wishing to test BRD designs not covered by this proclamation may submit BRD designs to the NCDMF, Morehead City office, for consideration for field-testing.
- G. Contact N.C. Division of Marine Fisheries, P.O. Box 769, Morehead City, NC 28557 252-726-7021 or 800-682-2632 for more information or visit the division website at <http://portal.ncdenr.org/web/mf/>.
- H. For more information on the installation of the Modified Jones Davis BRD visit: http://sero.nmfs.noaa.gov/sustainable_fisheries/gulf_fisheries/shrimp/documents/pdfs/brds/mod_jones_davis_instructions.pdf and for more information on the installation of the Composite Panel BRD visit: http://sero.nmfs.noaa.gov/sustainable_fisheries/gulf_fisheries/shrimp/documents/pdfs/brds/composite_brd_instructions.pdf.
- I. In accordance with N.C. General Statute 113-221.1(c) All persons who may be affected

by proclamations issued by the Fisheries Director are under a duty to keep themselves informed of current proclamations.

- J. This proclamation supersedes Proclamation SH-3-2012, dated May 22, 2012. **There are significant changes in that additional Bycatch Reduction Devices are now approved for use in Coastal Fishing Waters and a second Bycatch Reduction Device is required.**

BY: _____
Dr. Louis B. Daniel III, Director
DIVISION OF MARINE FISHERIES

May 12, 2015
12:00 P.M.
SH-2-2015
/KB/sab

232 copies of the public document were printed at a cost \$1.25 each.

Table 1. Required placement of Florida Fish Excluders (FFE).

Functional Cod end Length *	Maximum FFE Placement**	Functional Cod end Length&	Maximum FFE Placement**
105 meshes or greater	68 meshes	82	53
104	68	81	53
103	67	80	52
102	66	79	51
101	66	78	51
100	65	77	50
99	64	76	49
98	64	75	49
97	63	74	48
96	62	73	47
95	62	72	47
94	61	71	46
93	60	70	46
92	60	69	45
91	59	68	44
90	59	67	44
89	58	66	43
88	57	65	42
87	57	64	42
86	56		
85	55		
84	55		
83	54		

* Functional Cod end Length – That length of the cod end of a trawl beginning at the cod end tie-off and extending forward for a maximum of 105 meshes or to the point where the straight extension ends and the trawl body taper begins, whichever is less. Trawls utilizing short cod ends may include those meshes of the TED extension that are behind the TED grid and are in-line with the center of the FFE escape opening.

** If your cod end is not included in this Table, you can figure the maximum placement for your net by following the formula: (mesh count multiplied by 65, divided by 100, using a 50 mesh cod end as an example $(50 \times 65) / 100 = 32.5$).

Table 2. Required placement of “SEA EAGLE” Excluders.

Functional Cod end Length *	Maximum “SEA EAGLE” Placement**	Functional Cod end Length&	Maximum “SEA EAGLE” Placement**
105 meshes or greater	40 meshes	82	31
104	40	81	31
103	39	80	30
102	39	79	30
101	38	78	30
100	38	77	29
99	38	76	29
98	37	75	29
97	37	74	28
96	36	73	28
95	36	72	27
94	36	71	27
93	35	70	27
92	35	69	26
91	35	68	26
90	34	67	25
89	34	66	25
88	33	65	25
87	33	64	24
86	33		
85	32		
84	32		
83	32		

* Functional Cod end Length – That length of the cod end of a trawl beginning at the cod end tie-off and extending forward for a maximum of 105 meshes or to the point where the straight extension ends and the trawl body taper begins, whichever is less. Trawls utilizing short cod ends may include those meshes of the TED extension that are behind the TED grid and are in-line with the center of the “SEA EAGLE” escape opening.

** If your cod end is not included in this Table, you can figure the maximum placement for your net by following the formula: (mesh count multiplied by 38, divided by 100, using a 50 mesh cod end as an example: $(50 \times 38) / 100 = 19$).

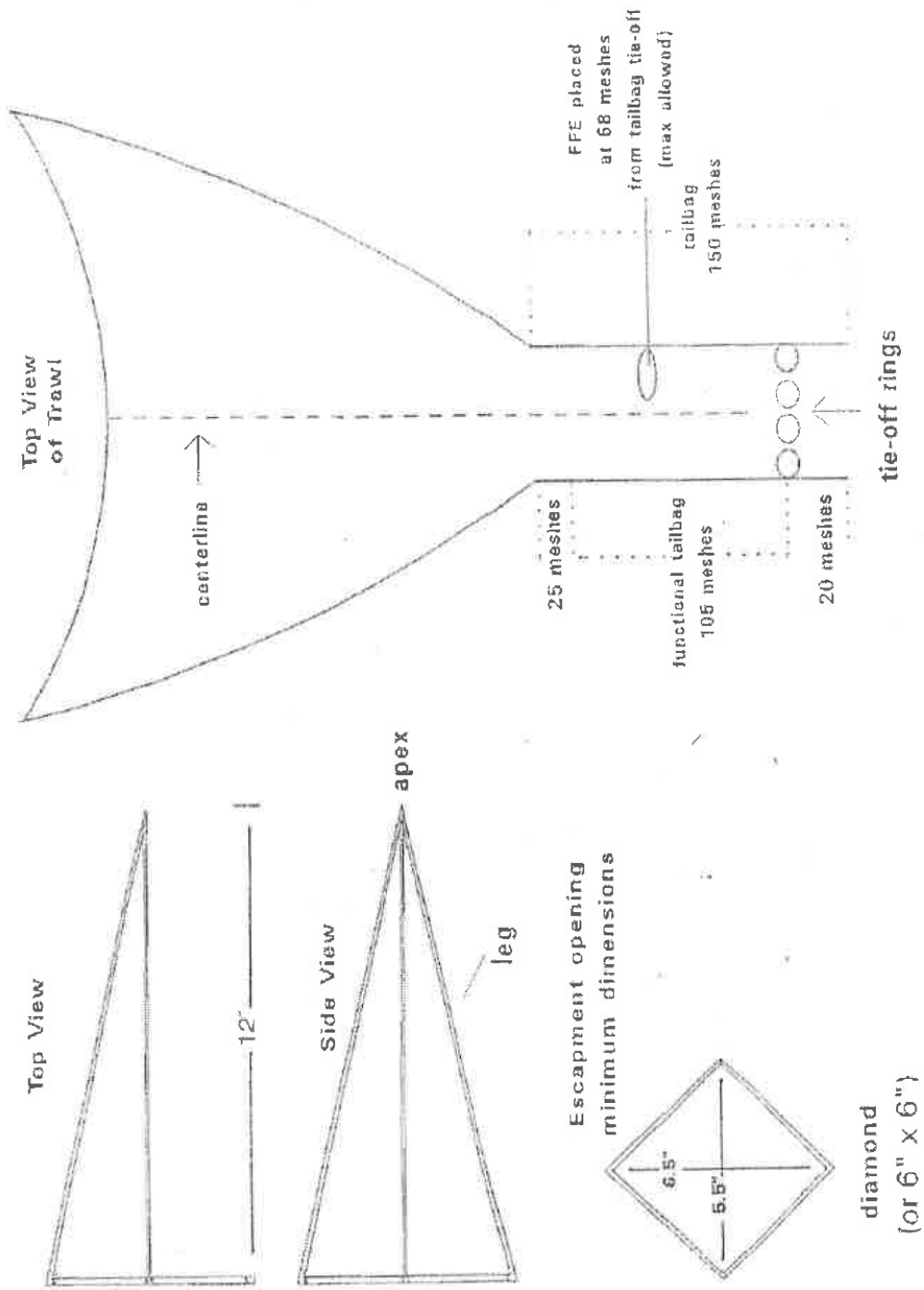


Figure 1. Diagram of Florida Fish Eye (FFE) (I.A.)

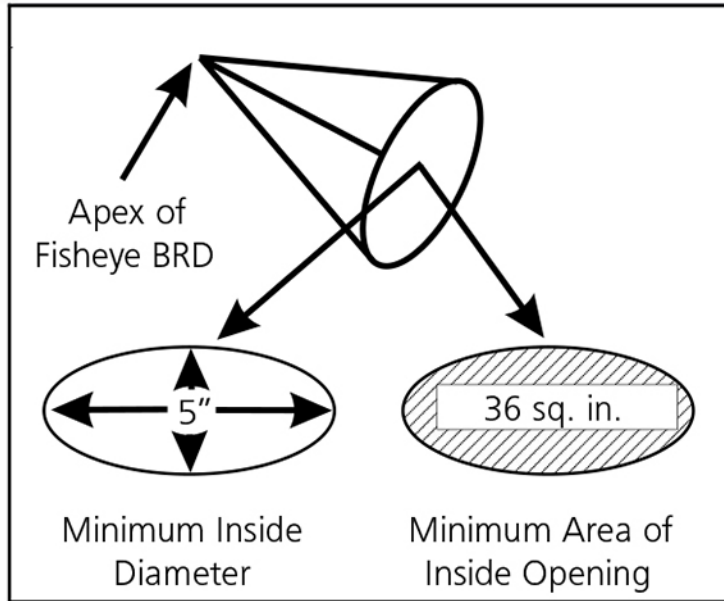


Figure 2. Minimum dimensions of the Fisheye (I.B.) and Gulf Fisheye (I.C.).

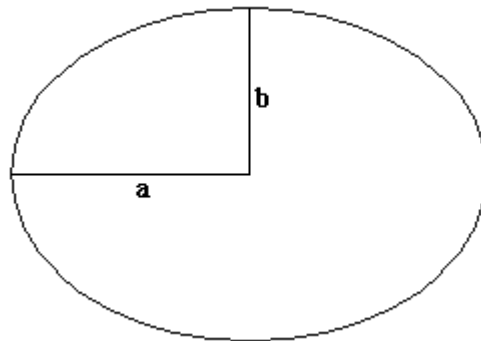


Figure 3. To determine the opening size of the oval Fisheye (I.B.) and the Gulf Fisheye (I.C.) use the following formula: $Area = \pi \times a \times b$

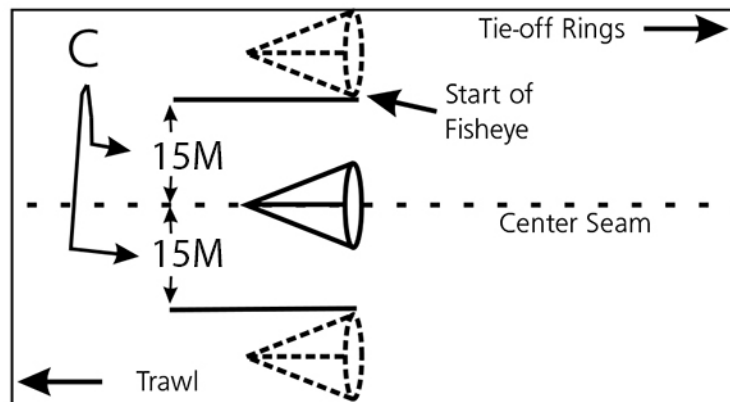


Figure 4. Placement of the Gulf Fisheye (I.C.) in relation to the center seam of the cod end.

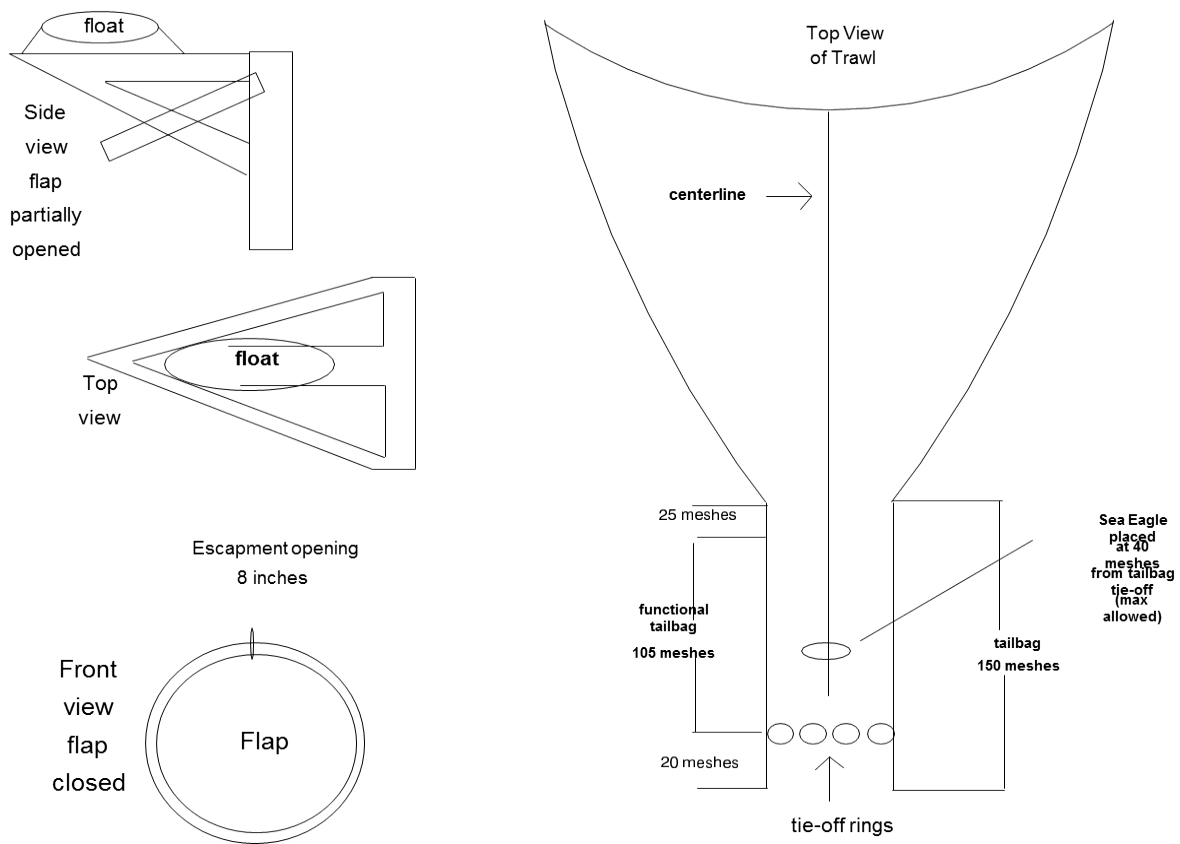
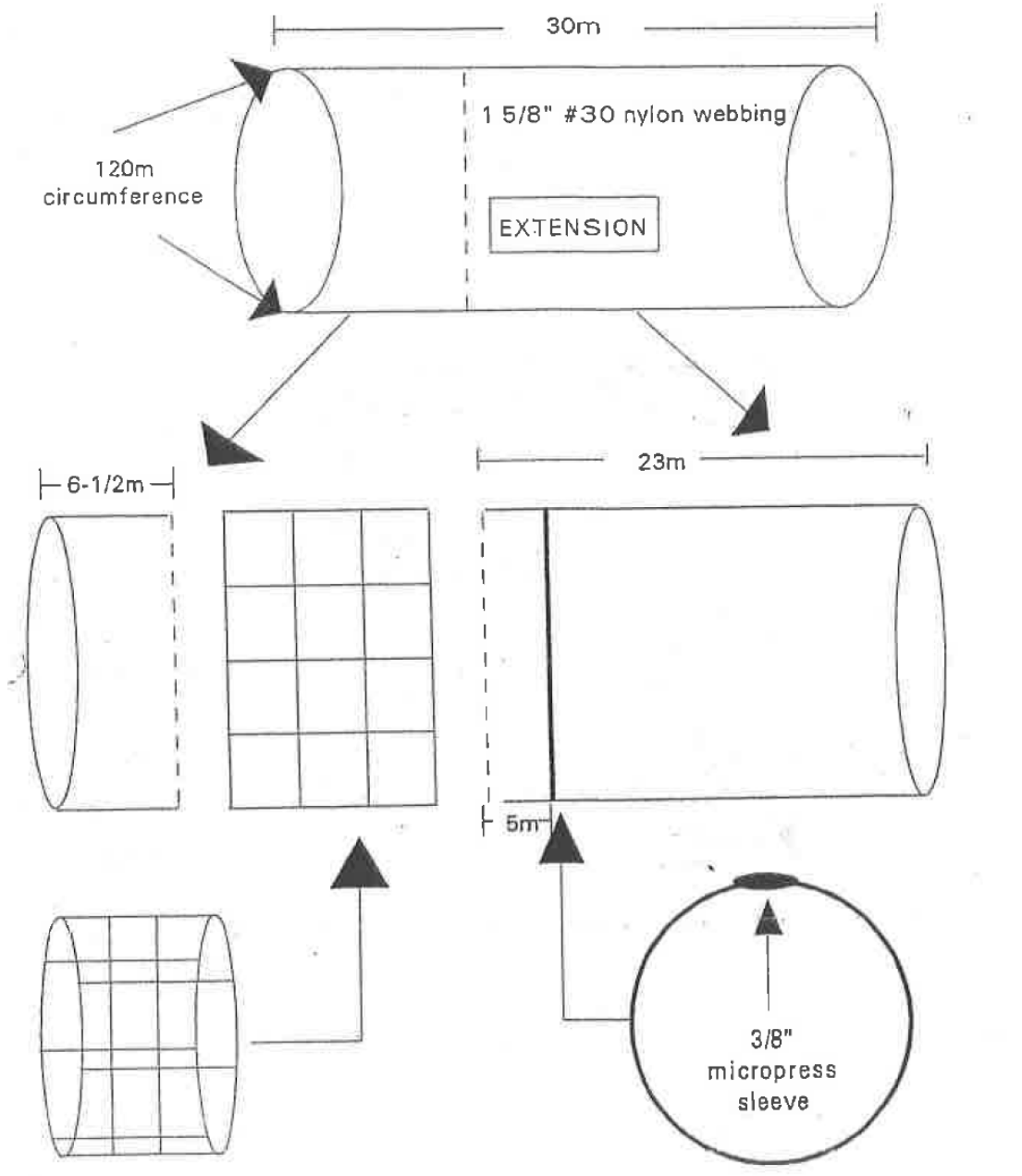


Diagram of "Sea Eagle" Fish Excluder.

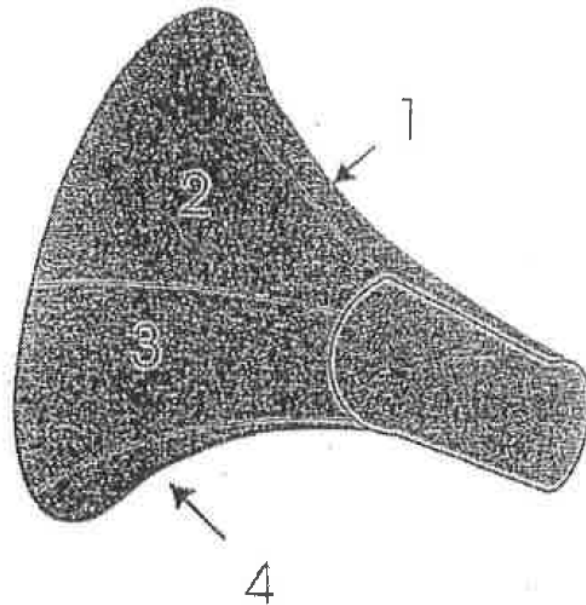
Figure 5. Diagram of "Sea Eagle" Fish Excluder.



10" Large mesh
 19 meshes (95") by 3 meshes (15")
 √
 8" Large mesh
 23 meshes (95") by 4 meshes (15")

Figure 6. Diagram of the Large Mesh and Extended Mesh Funnel BRDs (I.E, I.F, and I.G.).

Funnel

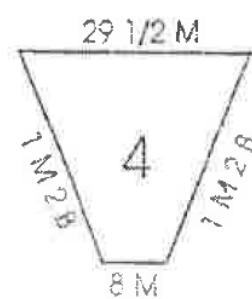
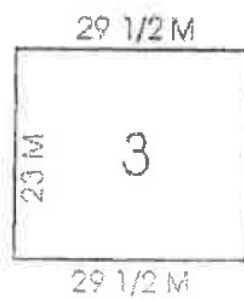
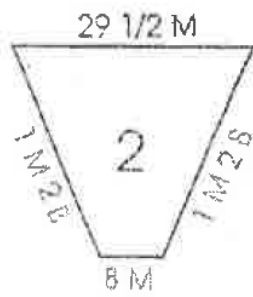


Side

Top

Side

Bottom



Webbing Panels

Figure 7. Webbing panels of the Large Mesh and Extended Mesh Funnel BRDs (I.E., I.F. and I.G.).

Top View

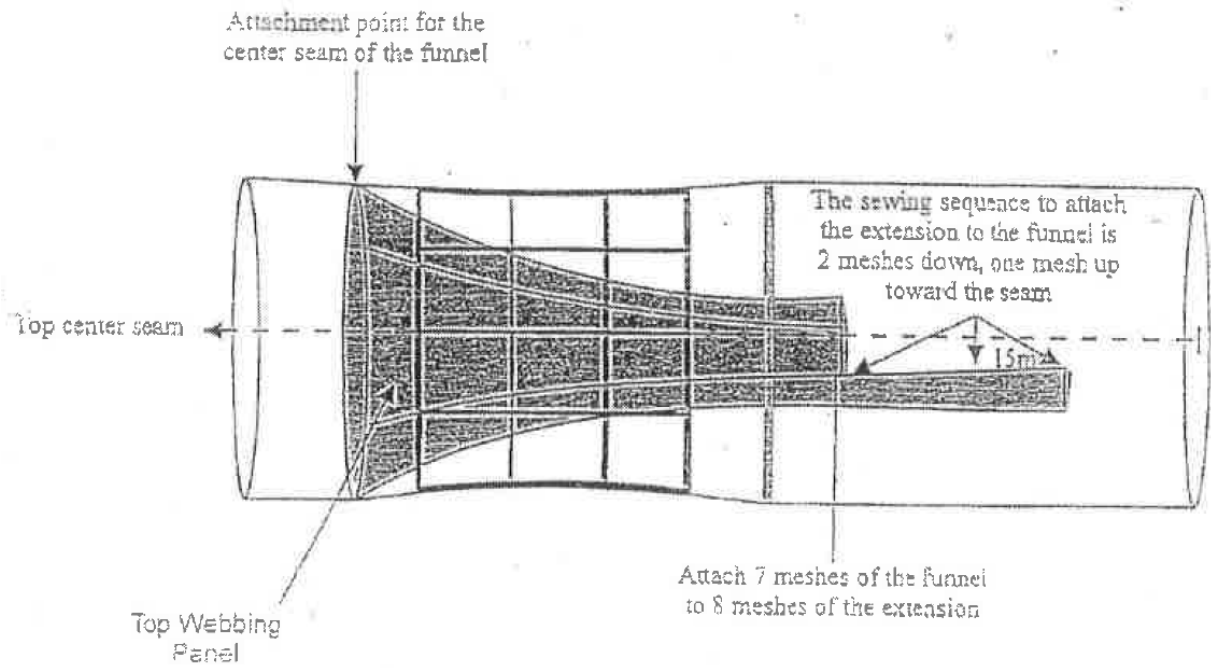


Figure 8. Top view of the Large Mesh and Extended Mesh Funnel BRDs (I.E., I.F., and I.G.).

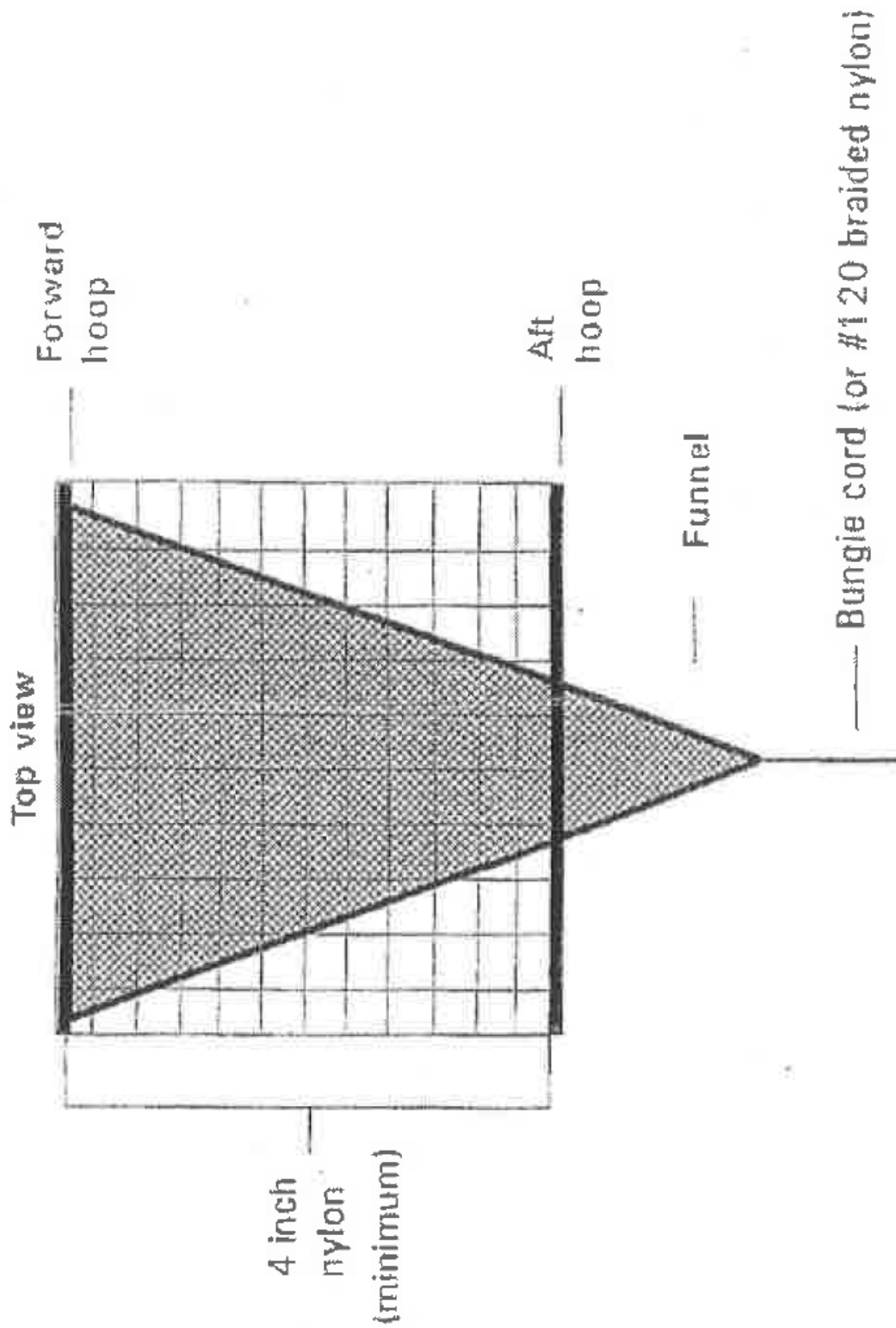
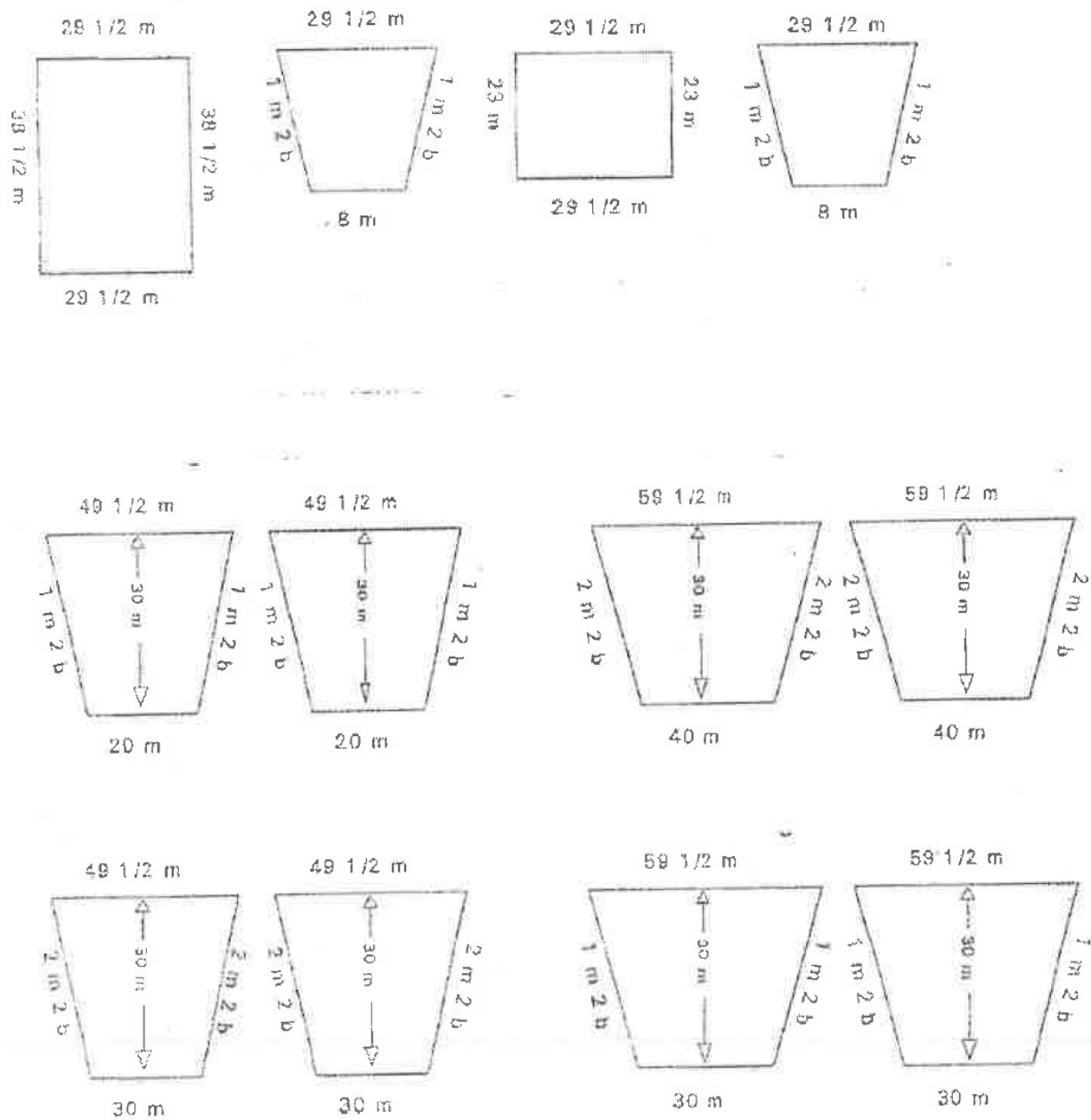


Figure 9. Diagram of the modified large mesh funnel excluder (LMFE) (I.G.)



* one of these four patterns may be used to construct the funnel for the large mesh funnel excluder.

Figure 10. Various funnel patterns of the Large Mesh Funnel Excluder (I.G.).

PROCLAMATION

RE: SHRIMP TRAWL BYCATCH REDUCTION DEVICE REQUIREMENTS – PAMLICO SOUND AND PORTIONS OF THE PAMLICO, BAY, AND NEUSE RIVERS

This proclamation supersedes proclamation SH-1-2019 (REVISED) dated April 23, 2019. It clarifies the mesh size requirements for the trawl body and tail bag/cod end and continues specific bycatch reduction device requirements for taking shrimp with trawls (except as described in Section IV.) in Pamlico Sound and the Pamlico, Bay, and Neuse rivers where up to 220 feet of combined headrope is allowed.

Stephen W. Murphey, Director, Division of Marine Fisheries, hereby announces that effective at 12:01 A.M. Monday, July 1, 2019 the following restrictions apply to shrimp trawls (skimmer trawls are exempt):

I. SUSPENSION OF A PORTION OF N.C. MARINE FISHERIES COMMISSION RULE 15A NCAC 03L .0103

The following portion of North Carolina Marine Fisheries Commission Rule 15A NCAC 03L .0103 is suspended effective at 12:01 A.M., Monday July 1, 2019:

Section (a)(1), which reads:

- (a) It is unlawful to take shrimp with nets with mesh lengths less than the following:
(1) Trawl net – one and one-half inches;

II. AREA DESCRIPTIONS:

It is unlawful to take shrimp with trawls, except as described in Sections III and IV, in the areas listed below:

- (1) Pamlico Sound south of the 35° 46.3000' N latitude line and north of a line beginning at a point 34° 59.7942' N - 76° 14.6514' W on Camp Point; running easterly to a point 34° 58.7853' N - 76° 09.8922' W on Core Banks;
- (2) Pamlico River downstream of a line from a point 35° 18.5882' N - 76° 28.9625' W at Pamlico Point; running northerly to a point 35° 22.3741' N - 76° 28.6905' W at Willow Point;
- (3) Bay River downstream of a line from a point 35° 11.0858' N - 76° 31.6155' W at Bay Point; running southerly to a point 35° 09.0214' N - 76° 32.2593' W at Maw Point; and
- (4) Neuse River northeast of a line from a point 34° 58.2000' N - 76° 40.5167' W at Winthrop Point on the eastern shore of the entrance to Adams Creek; running northerly to a point 35° 01.0744' N - 76° 42.1550' W at Windmill Point at the entrance of Greens Creek at Oriental. See Map 1.

III. GEAR RESTRICTIONS:

In the areas described in Section II, it is unlawful to take shrimp with trawls with mesh lengths less than one and one-half inches in the body of the net, mesh lengths less than one and three-quarter inches in the tail bag/cod end of the net, and without authorized North Carolina Division

of Marine Fisheries (NCDMF) Bycatch Reduction Devices (BRD) properly installed and operational in the tail bag/cod end of EACH net as described below (Figure 1):

A. Double Federal Fisheye (Figure 1, Table 1):

1. Description: The Double Federal Fisheye BRD is two Federal Fisheye BRDs placed inline as described below. The Fisheye BRD is a pyramid-shaped rigid frame constructed from aluminum or steel rod of at least $\frac{1}{4}$ inch (6.35 mm) diameter, which is inserted into the tail bag/cod end to form an escape opening. Minimum construction and installation requirements stated below.
2. The Federal Fisheye is a four-sided pyramid and has a minimum escape opening dimension of 6 inches (15.2 cm), minimum leg length of 12 inches (30.4 cm), and a minimum total escape opening area of 36 in² (91.4 cm²) [inside dimensions, not bar lengths] (Figure 1).
3. The Federal Fisheye shall be installed on the outside of the trawl. The webbing of the trawl attached to the Fisheye cannot cover more than 50% of the Federal Fisheye.
4. When the Federal Fisheye BRD is installed, no part of the lazy line attachment system (i.e., any mechanism, such as elephant ears or choker straps, used to attach the lazy line to the tail bag/cod end) may overlap the Federal Fisheye escape opening when the Federal Fisheye is installed aft of the attachment point of the tail bag/cod end retrieval system. The escapement opening shall remain unobstructed at all times.
5. The aft Federal Fisheye BRD must be installed at the top center of the tail bag/cod end of the trawl to create an escape opening in the trawl facing the direction of the mouth of the trawl no further forward than 65% of the functional tail bag/cod end length measured from the tail bag/cod end tie-off rings (Table 1).
6. Placement of the apex (narrow end) of the Federal Fisheye shall be toward the headrope of the trawl (forward).
7. The second Federal Fisheye BRD can be installed no further forward than 5 meshes from the apex of the primary Federal Fisheye BRD with the apex of the second Federal Fisheye BRD facing the headrope of the trawl.

B. Virgil Potter BRD and one Florida Fish Excluder (Figures 2, 3 and 4, Table 1):

1. Virgil Potter BRD
Description: The Virgil Potter BRD is a radial escape section constructed of large mesh webbing hung on the square. Minimum construction and installation requirements stated below.
 - a. The radial escape section shall be constructed of a minimum of 8 $\frac{1}{2}$ inch stretch mesh that is five meshes long installed between the TED extension and the cod-end, and includes a funnel constructed of 1 $\frac{1}{2}$ inch stretch mesh (Figure 2, 3).
2. Florida Fish Excluder (FFE) (Figure 4 and Table 1):
Description: pyramid-shaped rigid frame constructed from aluminum, steel, or stainless-steel round bar or tubing which is inserted into the tail bag/cod end to form an escape opening. Minimum construction and installation requirements stated below.
 - a. The FFE shall be installed on the outside of the trawl. The webbing of the trawl attached to the FFE cannot cover more than 50% of the FFE.
 - b. The escapement opening of the FFE shall be diamond in shape and shall remain unobstructed at all times. Diamond shaped FFE shall measure at least 5 $\frac{1}{2}$ inches x 6 $\frac{1}{2}$ inches or 6 inches x 6 inches, inside diameter (see Figure 4).
 - c. Placement of the apex (narrow end) of the FFE shall be toward the headrope of the trawl (forward).

- d. A FFE shall have at least three (3) legs and no more than four (4) legs and measure at least 12 inches in length (see Figure 4).
- e. The opening of the FFE shall be installed on the outside of the tail bag/cod end of the trawl no further forward than 65% of the functional tail bag/cod end length measured from the tail bag/cod end tie-off rings (Table 1).
- f. The center of the FFE escapement opening shall be installed no more than 19 meshes from the top centerline of the tail bag/cod end.
- g. A FFE shall be constructed from aluminum, steel, or stainless-steel round bar or tubing.
- h. When the FFE BRD is installed, no part of the lazy line attachment system (i.e., any mechanism, such as elephant ears or choker straps, used to attach the lazy line to the tail bag/cod end) may overlap the FFE escape opening when the FFE is installed aft of the attachment point of the tail bag/cod end retrieval system.

IV. **GEAR EXEMPTIONS:**

The gear restrictions in Section III do not apply to the following:

- D. Skimmer trawls; or
- E. A single test trawl net (try net) with a headrope length of 12 feet or less with a mesh size of one and one-half inches or greater, if it is operated under the following conditions:
 - 1. net is either pulled immediately in front of another net or is not connected to another net in any way;
 - 2. no more than one net is used at a time; and
 - 3. net is not towed as a primary net.

V. **DEFINITIONS:** For the purposes of this proclamation, the following terms are hereby defined:

- H. Bycatch reduction device (BRD) - any gear or trawl modification (including modifications to a TED that would enhance finfish exclusion) designed to allow finfish to escape from a shrimp trawl. BRD is defined based on its ability to facilitate the escape of finfish from a shrimp trawl.
- I. Turtle excluder device (TED) - An inclined grid or netting panel that prevents the passage of large animals such as sea turtles and large fish into the tail bag/cod end and guides them through an escape opening located in the tail bag/cod end. TED is defined based on its ability to exclude sea turtles from a shrimp trawl.
- J. Tail bag/cod end - That portion of the trawl net at which the trawl body's taper ends and the straight extension begins, extending to the terminal end of the trawl.
- K. Functional tail bag/cod end length - That length of the tail bag/cod end of a trawl beginning at the tail bag/cod end tie-off rings and extending forward for a maximum of 105 meshes or to the point where the straight extension ends and the trawl body taper begins, whichever is less. Trawls utilizing short tail bag/cod ends may include those meshes of the TED extension that are behind the TED grid and are in-line with the center of the FFE escape opening.
- L. Centerline - The line running from the center point of the headrope to the top center of the end of the tail bag/cod end.
- M. Radial escape section - This BRD features a guiding funnel to concentrate all animals into the middle of the tail bag/cod end and a panel of large square-meshes that extend radially around the tail bag/cod end that allows for fish escapement.
- N. Skimmer trawl - a trawl that is fished along the side of the vessel and is held open by a rigid frame and a lead weight. On its outboard side, the trawl is held open by one side of the frame extending downward and, on its inboard side, by a lead weight attached by cable or rope to the bow of the vessel.

- O. Try net – A net pulled for brief periods of time just before, or during, deployment of the primary net(s) in order to test for shrimp concentrations or determine fishing conditions (e.g. presence or absence of bottom debris, jellyfish, bycatch, seagrasses, etc.).

VI. **GENERAL INFORMATION:**

- K. This proclamation is issued under the authority of N.C.G.S. 113-170.4; 113-170.5; 113-182; 143B-289.52 and N.C. Marine Fisheries Commission Rule 15A NCAC 03J .0104(d).
- L. It is unlawful to violate the provisions of any proclamation issued by the Fisheries Director under his delegated authority per N.C. Marine Fisheries Commission Rule 15A NCAC 03H .0103.
- M. It is unlawful to use a shrimp trawl that does not conform with the federal requirements for Turtle Excluder Devices (TEDs) per N.C. Marine Fisheries Commission Rule 15A NCAC 03L .0103(h).
- N. **N.C. Marine Fisheries Commission Rule 15A NCAC 03L .0103(d) makes it unlawful to take shrimp with trawls with a combined headrope length greater than 220 feet in the areas described in Section II.**
- O. Channel nets, float nets, fixed nets, and butterfly nets are not required to use BRDs.
- P. The intent of this proclamation is to require the use of newly approved BRDs identified by a collaborative study that achieved at least a 40 percent finfish bycatch reduction in accordance with the N.C. Shrimp Fishery Management Plan Amendment 1.
- Q. Vessels operating in coastal fishing waters outside of those areas described in Section II. or using skimmer trawls must use a minimum of two authorized NCDMF BRDs as described in Proclamation SH-4-2019.
- R. Persons wishing to test BRD designs not covered by this proclamation may submit BRD designs to the NCDMF, Morehead City office, for consideration for field-testing.
- S. This proclamation only sets the gear requirements for taking shrimp with trawls in these areas as described in Section II., area openings and closings are done through separate proclamations. Individuals should check the division website (<http://portal.ncdenr.org/web/mf/>) for proclamations opening and closing specific areas for the taking of shrimp.
- T. Contact N.C. Division of Marine Fisheries, P.O. Box 769, Morehead City, NC 28557; 252-726-7021 or 800-682-2632 for more information or visit the division website at <http://portal.ncdenr.org/web/mf/>.
- U. In accordance with N.C. General Statute 113-221.1(c) All persons who may be affected by proclamations issued by the Fisheries Director are under a duty to keep themselves informed of current proclamations.
- V. **This proclamation supersedes proclamation SH-1-2019 (REVISED) dated April 23, 2019. It clarifies the mesh size requirements for the trawl body and tail bag/cod end and continues specific bycatch reduction device requirements for taking shrimp with trawls (except as described in Section IV.) in Pamlico Sound and the Pamlico, Bay, and Neuse rivers where up to 220 feet of combined headrope is allowed.**



BY: _____
Stephen W. Murphey, Director
DIVISION OF MARINE FISHERIES

May 14, 2019
10:20 A.M.

Table 1. Required placement of primary Federal Fisheye and Florida Fish Excluder.

Functional Tail bag/cod end Length*	Maximum FFE Placement**	Functional Tail bag/cod end Length**	Maximum FFE Placement**
105 meshes or greater	68 meshes	82	53
104	68	81	53
103	67	80	52
102	66	79	51
101	66	78	51
100	65	77	50
99	64	76	49
98	64	75	49
97	63	74	48
96	62	73	47
95	62	72	47
94	61	71	46
93	60	70	46
92	60	69	45
91	59	68	44
90	59	67	44
89	58	66	43
88	57	65	42
87	57	64	42
86	56		
85	55		
84	55		
83	54		

* Functional Tail bag/cod end Length – That length of the tail bag/cod end of a trawl beginning at the tail bag/cod end tie-off and extending forward for a maximum of 105 meshes or to the point where the straight extension ends and the trawl body taper begins, whichever is less. Trawls utilizing short tail bag/cod ends may include those meshes of the TED extension that are behind the TED grid and are in-line with the center of the FFE escape opening.

** If your tail bag/cod end is not included in this Table, you can figure the maximum placement for your net by following the formula: (mesh count multiplied by 65, divided by 100, using a 50 mesh tail bag/cod end as an example $(50 \times 65) / 100 = 32.5$).

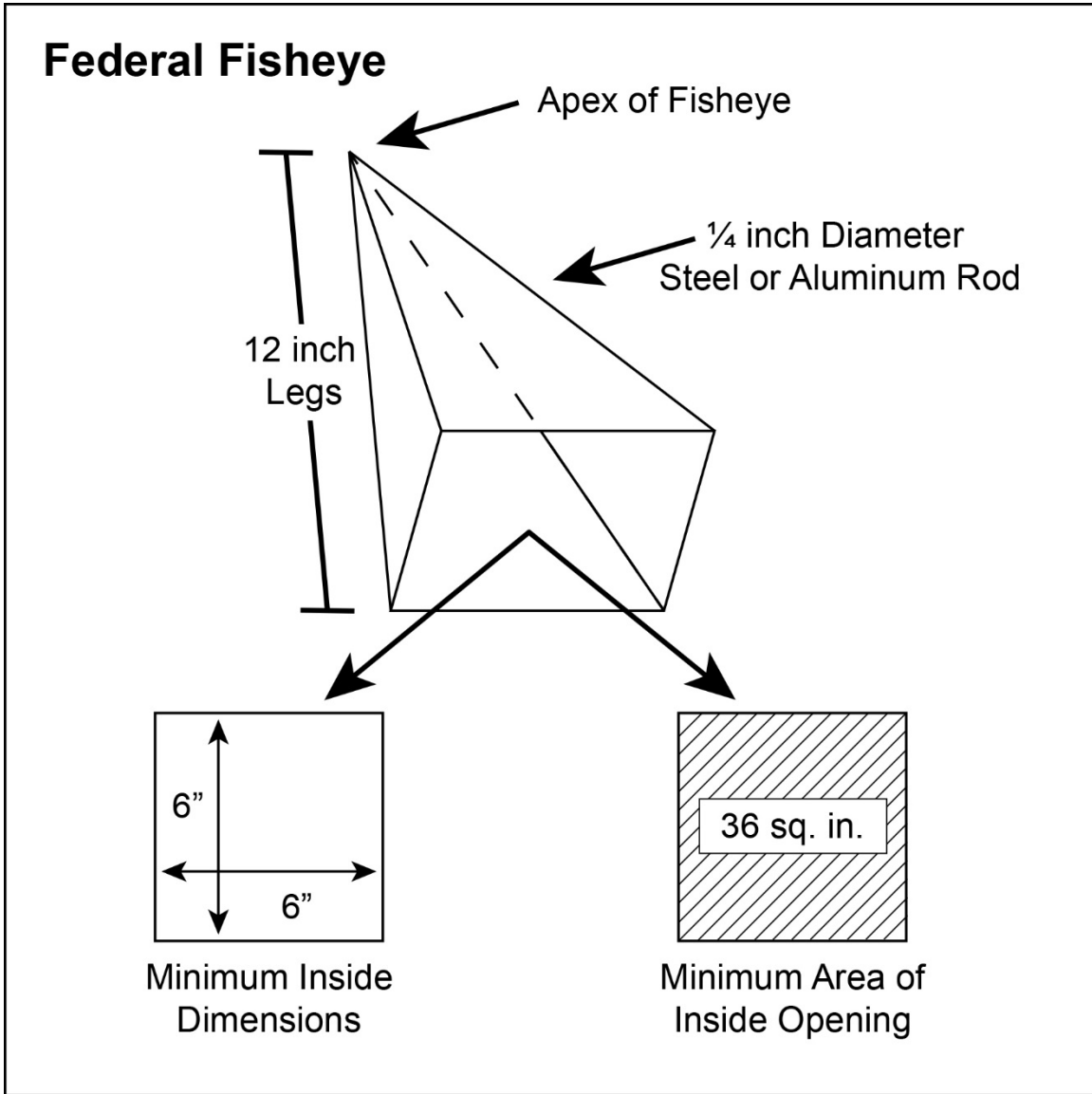


Figure 1. Minimum dimensions of the Federal Fisheye (III.A).



Figure 2. Virgil Potter BRD (III.B).

Virgil Potter BRD

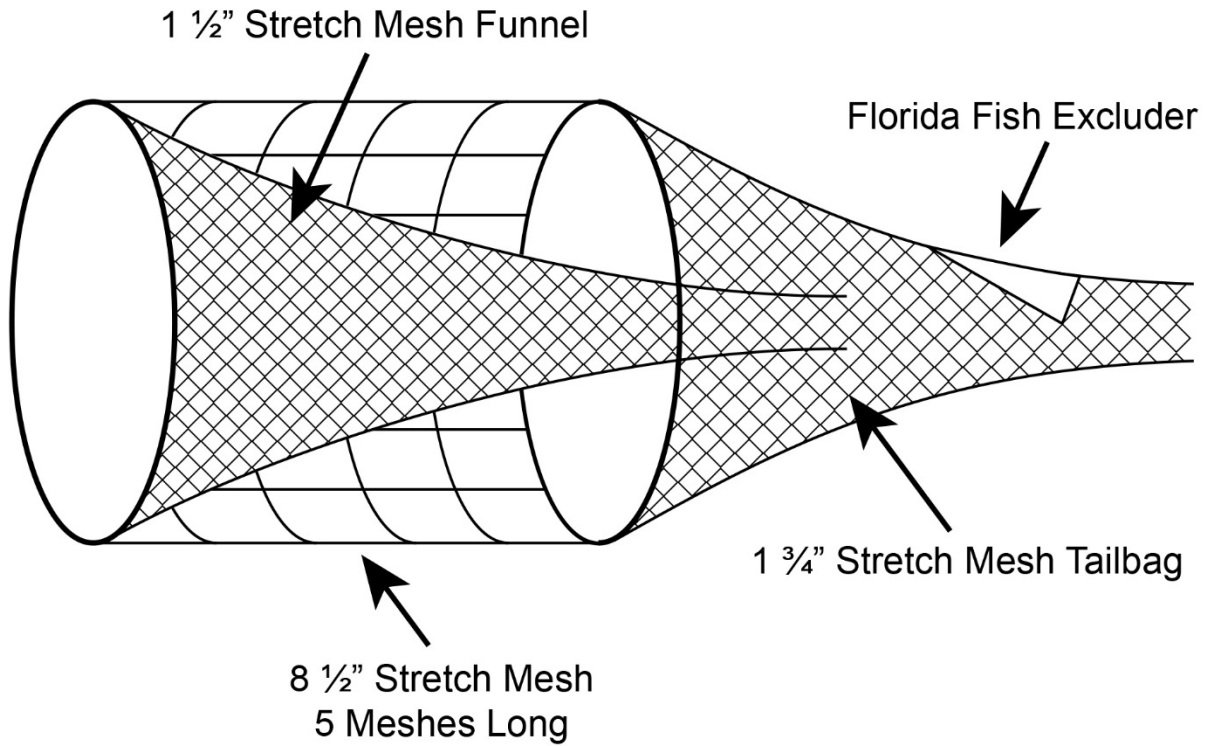


Figure 3. Specifications for the Virgil Potter BRD (III.B).

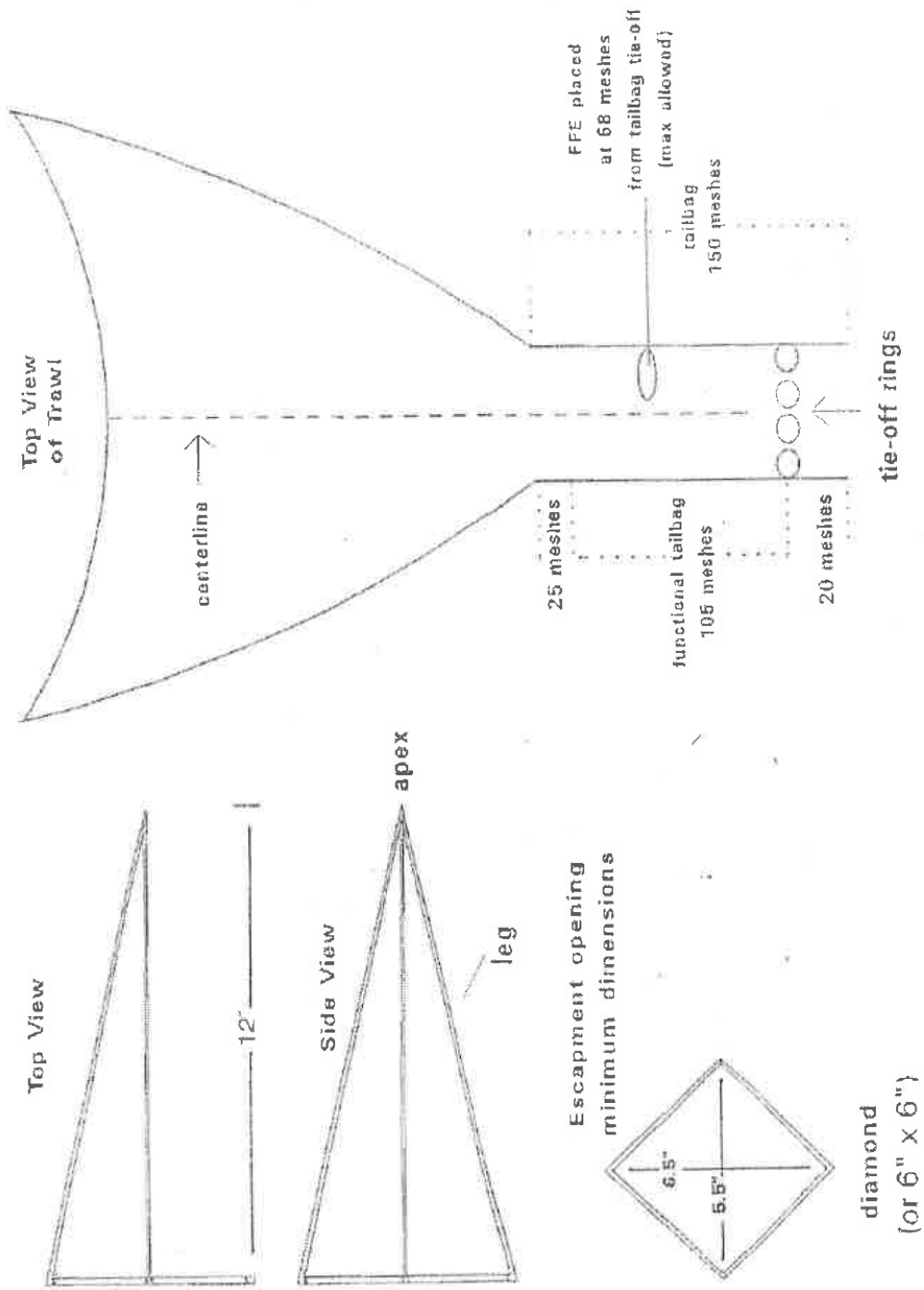


Figure 4. Diagram of Florida Fish Eye (FFE) (III.B).

North Carolina
Shrimp
Fishery Management Plan

Amendment 1

By

North Carolina Division of Marine Fisheries



North Carolina Department of Environment and Natural Resources
North Carolina Division of Marine Fisheries
3441 Arendell Street
P. O. Box 769
Morehead City, N.C. 28557

March 2015

Sept 2011	Timeline begins
July 2012	Internal review with DMF comments
Aug 2012	Draft Revision 1 approved by MFC for public comment
Nov 2012	Management changes proposed begin Draft Amendment 1
Nov 2013	Draft Amendment 1 approved by MFC for public comment
Feb 2014	MFC selects preferred management options
Mar 2014	Submit draft to DENR Secretary
Feb 2015	Plan amendment and rules adopted by the MFC

1.0 ACKNOWLEDGEMENTS

The Shrimp FMP Amendment 1 was prepared by the North Carolina Department of Environment and Natural Resources Division of Marine Fisheries (DMF) under direction of the North Carolina Marine Fisheries Commission (MFC) to address bycatch issues in the commercial and recreational shrimp fisheries with the advice of the Shrimp Advisory Committee.

DMF Plan Development Team

Trish Murphey Co-Lead
Chris Stewart Co-Lead
Alan Bianchi
Kevin Brown
John Hadley
Kevin Hart
Jack Holland
Dean Nelson
Greg Judy
Blake Price (NMFS)
David Taylor
Holly White
Katy West

Marine Fisheries Commission

Sammy Corbett, Chairman
Anna Barrios Beckwith, Vice-Chairman
Mikey Daniels
Kelly L. Darden, Jr.
Mark L. Gorges
Charles Laughridge III
Joe Shute
Mike Wicker
Alison Willis

Shrimp FMP Advisory Committee

Nancy Edens, Co-Chairman
Scott Whitley, Co-Chairman
Joe Albea
Julian Anderson
Frank Brown
Ray Brown
P.D. Mason
Steve Parrish
Kenny Rustick

2.0 TABLE OF CONTENTS

1.0	ACKNOWLEDGEMENTS	2
2.0	TABLE OF CONTENTS	3
2.1	LIST OF TABLES	8
2.2	LIST OF FIGURES	12
2.3	LIST OF ACRONYMS	16
3.0	EXECUTIVE SUMMARY	20
3.1	STATUS OF THE FISHERIES	21
3.1.1	Commercial Fishery.....	21
3.1.2	Recreational Fishery.....	22
3.1.3	Shrimp Trawl Bycatch.....	22
3.2	PROTECTED RESOURCES.....	23
3.3	ECONOMIC STATUS.....	23
3.4	SOCIOECONOMIC CHARACTERISTICS.....	23
3.5	ENVIRONMENTAL FACTORS	24
3.6	MANAGEMENT STRATEGIES	24
3.6.1	Shrimp Management by Size.....	25
3.6.2	Shrimp Management by Area	25
3.6.3	Shrimp Management in the Southern District.....	25
3.6.4	Shrimp Management in the Central District	25
3.6.5	Shrimp Management in Pamlico District	25
3.6.6	Shrimp Management in the Northern District	26
3.6.7	Atlantic Ocean	26
3.7	BYCATCH IN THE SHRIMP FISHERY AND MANAGEMENT OPTIONS	26
3.7.1	Marine Fisheries Commission Preferred Management Strategies and Required Actions	27
4.0	INTRODUCTION.....	29
4.1	LEGAL AUTHORITY FOR MANAGEMENT.....	29
4.2	RECOMMENDED MANAGEMENT PROGRAM	30
4.2.1	Goals and Objectives	30
4.2.2	Sustainable Harvest	31
4.2.3	Management Strategy	31
4.3	DEFINITION OF MANAGEMENT UNIT.....	31
4.4	GENERAL PROBLEM STATEMENT	31
4.4.1	New River Trawl Fishery.....	31
4.4.2	Use of Other Fishing Gears	31
4.4.3	Gear Modifications.....	32
4.4.4	Live Bait Shrimp Fishery.....	32
4.4.5	Effort Management.....	32
4.4.6	Area Restrictions	32
4.5	EXISTING PLANS STATUTES, AND RULES	32
4.5.1	Plans	32
4.5.2	Statutes.....	34
4.5.3	Marine Fisheries Commission Rules (June 1, 2013).....	34
4.5.3.1	General.....	34
4.5.3.2	Nets, Pots, Dredges, and Other Fishing Devices	35
4.5.3.3	Oysters, Clams, Scallops and Mussels	38
4.5.3.4	Shrimp, Crabs, and Lobster	38
4.5.3.5	Licenses, Leases, Franchises, and Permits	39
4.5.5	Federal Regulations	40

5.0 STATUS OF THE STOCK.....	41
5.1 GENERAL LIFE HISTORY	41
5.1.1 Brown Shrimp.....	41
5.1.2 Pink Shrimp.....	42
5.1.3 White Shrimp.....	42
5.1.4 Movement	43
5.1.5 Predation.....	44
5.1.6 Parasites and Disease.....	45
5.2 STOCK STATUS.....	46
6.0 STATUS OF FISHERIES	47
6.1 COMMERCIAL	47
6.1.1 History.....	47
6.1.2 State Landings and Effort	49
6.1.3 Landings by Waterbody.....	52
6.1.4 Landings by Gear	53
6.1.5 Landings by Species	54
6.1.2.5 Regional Summary	58
6.2 RECREATIONAL FISHERY	58
6.2.1 Recreational Commercial Gear License (RCGL) History	59
6.2.2 RCGL Survey	59
6.2.3 RCGL Survey Methodology	60
6.2.4 RCGL Survey Results	61
6.2.5 Regional RCGL Characterization for Shrimp Trawls	63
6.2.6 Contribution of RCGL Harvest compared to Other Fisheries	65
6.3 SHRIMP TRAWL BYCATCH	66
6.3.1 History of Bycatch Management in North Carolina	68
6.3.2 Incidental Catch.....	69
6.3.3 Discarded Catch.....	76
6.3.4 Biological Implications of Bycatch.....	81
6.3.5 Bycatch Impacts on Stock Assessment and Prediction.....	83
6.3.6 Bycatch Impacts on the Stock Assessment of Non-Target Species	85
6.3.6.1 Blue Crab Status	86
6.3.6.2 Weakfish Status.....	87
6.3.6.3 Atlantic Croaker Status	88
6.3.6.4 Spot Status.....	90
6.3.6.5 Southern Flounder Status	91
6.3.6.6 Summary	92
6.3.7 North Carolina Management Strategies to Reduce Bycatch	92
6.3.7.1 Tailbag Mesh Size	92
6.3.7.2 Bycatch Reduction Devices	93
6.3.7.3 Turtle Excluder Devices	98
6.3.7.4 Alternate Gears	99
6.3.7.5 Catch Restrictions.....	100
6.3.7.6 Harvest Seasons	101
6.3.7.7 Time Restrictions	101
6.3.7.8 Area Restrictions	101
6.3.7.9 Limited Entry.....	102
7.0 PROTECTED RESOURCES	103
7.1 PROTECTED RESOURCES LEGISLATION.....	103
7.1.1 Federal Endangered Species Act (ESA).....	103
7.1.2 Marine Mammal Protection Act (MMPA).....	104

7.1.3	North Carolina Endangered Species Act (Chapter 113 Article 25)	105
7.2	SPECIES THAT MAY INTERACT WITH THE SHRIMP FISHERY	106
7.2.3	Bottlenose Dolphin	106
7.2.4	Sea Turtles	107
7.2.4.1	Sea Turtles and the Shrimp Fishery	109
7.2.4.2	NCDMF Programs	110
8.0	ECONOMIC STATUS	113
8.1	COMMERCIAL FISHERY	113
8.1.1	Harvesting sector	113
8.1.1.1	Ex-vessel value and price	113
8.1.1.2	Gear	118
8.1.1.3	Water bodies	120
8.1.1.4	Participants and trips	127
8.1.1.5	Processing	132
8.1.1.6	Marketing and distribution	132
8.1.1.7	Economic impact of commercial fishery	133
8.1.2	Recreational fishery economics	134
8.1.2.1	Marine Recreational Information Program (MRIP)	134
8.1.2.2	Recreational use of commercial gear (RCGL)	134
8.1.2.3	Other Recreational Fisheries	135
9.0	SOCIOECONOMIC CHARACTERISTICS	136
9.1	SOCIAL IMPORTANCE OF THE FISHERY	136
9.1.1	Commercial fishermen	136
9.1.1.1	Historical importance	136
9.1.1.2	Community reliance on the commercial fishery	136
9.1.1.3	Perceived conflicts	138
9.1.1.4	Perception of important issues	139
9.2	RECREATIONAL FISHERY	140
9.2.1	Historical importance	140
9.2.2	Community reliance on the recreational fishery	140
9.2.3	Perceived conflicts	140
9.2.4	Perception of important issues	140
9.3	DEMOGRAPHIC CHARACTERISTICS	141
9.3.1	Commercial fishermen	141
9.3.2	Recreational fishermen	142
9.4	DEFINITIONS	143
10.0	ENVIRONMENTAL FACTORS	145
10.1	HABITAT	145
10.1.1	Water column	145
10.1.2	Wetlands	146
10.1.3	Soft bottom	147
10.1.4	Submerged Aquatic Vegetation (SAV)	153
10.1.5	Shell bottom	154
10.1.6	Hard Bottom	156
10.2	HABITAT CONCERNS	156
10.2.1	Wetland Loss	156
10.2.2	Soft Bottom Impacts	157
10.2.3	Submerged Aquatic Vegetation Impacts	159
10.3	WATER QUALITY	162
10.3.1	Hydrological modifications	162
10.3.2	Low oxygen	163

10.3.3	Toxins.....	165
10.3.4	Tiger Shrimp.....	166
10.4	HABITAT AND WATER QUALITY PROTECTION.....	167
10.4.1	MFC Authority	167
10.4.2	Authority of Other Agencies.....	167
10.4.3	Nursery Area Protection	168
10.4.4	Coastal Habitat Protection Plan.....	170
10.5	STATUS OF 2006 SHRIMP FMP ENVIRONMENTAL FACTORS RECOMMENDATION	171
10.5.1	Coastal Habitat Protection Plan Actions.....	172
11.0	MANAGEMENT STRATEGIES.....	175
11.1	HISTORY OF SHRIMP MANAGEMENT	175
11.2	SHRIMP MANAGEMENT BY SIZE	176
11.3	SHRIMP MANAGEMENT BY AREA.....	177
11.3.1	Shrimp Management in the Southern District.....	178
11.3.1.1	Brunswick County.....	178
11.3.1.2	Cape Fear River Complex	180
11.3.1.3	Intracoastal Waterway and Sounds from Carolina Beach to Rich's Inlet	182
11.3.1.4	Intracoastal Waterway and sounds from Rich's Inlet to New River.....	184
11.3.1.5	New River.....	184
11.3.1.6	Chadwick Bay.....	186
11.3.2	Shrimp Management in the Central District.....	187
11.3.2.1	White Oak River	187
11.3.2.3	Newport River.....	189
11.3.2.4	North River	191
11.3.2.5	Jarrett Bay	191
11.3.2.6	Core Sound	191
11.3.3	Shrimp Management in Pamlico District.....	193
11.3.3.1	Neuse River.....	194
11.3.3.2	South Side of Neuse River.....	196
11.3.3.3	Bay River.....	196
11.3.3.4	Pamlico River	196
11.3.3.5	Pungo River.....	198
11.3.3.6	Pamlico Sound	198
11.3.3	Shrimp Management in the Northern District	198
11.3.3.1	Croatan Sound	200
11.3.3.2	Roanoke Sound.....	201
11.3.4	Atlantic Ocean.....	201
11.4	SUMMARY OF MANAGEMENT ACTIONS	201
11.4.1	Rules (new, modifications, or technical changes)	201
11.4.2	Legislative Action (new, modifications, or technical changes).....	201
11.4.3	Actions by Other Agencies	201
11.4.4	Management Related Research Needs.....	203
11.4.5	Biological Research Needs.....	203
11.4.6	Social and Economic Research Needs.....	204
11.4.7	Data Needs	204
12.0	BYCATCH IN THE SHRIMP FISHERY AND MANAGEMENT OPTIONS.....	205
12.1	TRAWLING IN THE NEW RIVER ABOVE THE HIGHWAY 172 BRIDGE	206
12.2	EVALUATION OF THE SKIMMER TRAWL AND OTHER GEARS USED FOR SHRIMPING IN NORTH CAROLINA.....	221

12.3	RESEARCH RESULTS – THE USE OF TURTLE EXCLUDER DEVICES (TEDS) IN COMMERCIAL SKIMMER TRAWL OPERATIONS	247
12.4	CONSIDERATION FOR A COMMERCIAL LIVE BAIT SHRIMP FISHERY IN NORTH CAROLINA.....	270
12.5	GEAR MODIFICATIONS IN NORTH CAROLINA SHRIMP TRAWLS TO REDUCE FINFISH BYCATCH	276
12.6	EFFORT MANAGEMENT FOR BYCATCH REDUCTION IN THE NORTH CAROLINA SHRIMP TRAWL FISHERY.....	296
12.7	CHARACTERIZATION OF THE NORTH CAROLINA COMMERCIAL SHRIMP TRAWL FLEET.....	309
12.8	AREA RESTRICTIONS TO REDUCE SHRIMP TRAWL BYCATCH IN NORTH CAROLINA’S INTERNAL COASTAL WATERS.....	334
12.9	REMOVAL OF THE SHRIMP TRAWL FROM THE RECREATIONAL COMMERCIAL GEAR LICENSE.....	348
12.10	BYCATCH MANAGMENT RECOMMENDATIONS.....	354
	12.10.1 Trawling in the New River above the Highway 172 Bridge	354
	12.10.2 Evaluation of the skimmer trawl and other gears used for shrimping in North Carolina.....	354
	12.10.3 The use of TEDs in commercial skimmer trawl operations.....	354
	12.10.4 Consideration of a commercial live bait shrimp fishery in North Carolina	355
	12.10.5 Gear Modifications in North Carolina shrimp trawls to reduce finfish bycatch.....	355
	12.10.6 Effort Management for bycatch reduction in the North Carolina shrimp trawl fishery.....	357
	12.10.7 Characterization of the North Carolina commercial shrimp trawl fleet	357
	12.10.8 Area restrictions to reduce shrimp trawl bycatch in North Carolina’s internal coastal waters	358
12.11	PROPOSED RULES	358
	12.11.1 Trawling in the New River above the Highway 172 Bridge	358
	12.11.2 Evaluation of the Skimmer Trawl and other gears used for shrimping in North Carolina.....	358
	12.11.3 Gear Modifications in the North Carolina Shrimp Trawl to Reduce Finfish Bycatch	359
	12.11.4 Characterization of the North Carolina Commercial Shrimp Trawl Fleet	364
	12.11.5 Area Restrictions to Reduce Shrimp Trawl Bycatch in North Carolina’s Internal Coastal Waters.....	365
	12.11.6 Additional Rule Change to Address Clarity and Consistency	366
13.0	LITERATURE CITED	367
14.0	APPENDICES.....	387
14.1	APPENDIX1 – AMENDMENT 1 RULES – PUBLIC COMMENT.....	387
14.2	APPENDIX2 – AMENDMENT 1- PUBLIC COMMENT	396
14.3	APPENDIX 3 – REVISION REVIEW PROCESS.....	414
14.4	APPENDIX 4 – BYCATCH REDUCTION DEVICES AND TURTLE EXCLUDER DEVICES..	479

2.1 LIST OF TABLES

Table 5.1	Environmental Requirements of three shrimp species found in North Carolina. .43
Table 5.2	Migration studies in North Carolina of three shrimp species found in North Carolina.44
Table 6.1	Annual number of trips reported for shrimp in inside and ocean waters [†] , 1978-2010 (Detailed Shrimp Program and Trip Ticket Program).51
Table 6.2	Percent contribution of landings (1999 – 2010) by waterbody and species.53
Table 6.3	Shrimp landings in pounds from the South Atlantic, 1999-2010.56
Table 6.4	Number of fiscal license sales of Recreational Commercial Gear Licenses, 2002 through 2010 (fiscal year, July 1 through June 30).61
Table 6.5	Number of trips by shrimp trawl by region, 2002 through 2008.63
Table 6.6	Harvest (lb) and pounds per trip of shrimp by RCGL gear from 2002 through 2008.63
Table 6.7	Top four species harvested (lb) by RCGL shrimp trawls in the Southern Region, 2002-2008.64
Table 6.8	Top species harvested (lb) by RCGL shrimp trawls in the Central Region, 2002-2008.64
Table 6.9	Top species harvested (lb) by RCGL shrimp trawls in the Pamlico Region, 2002-2008.65
Table 6.10	Top species harvested (lb) by RCGL shrimp trawl in the Northern Region, 2002-2008.65
Table 6.11	Contribution in percent (pounds) of RCGL harvest to the overall harvest of finfish and shellfish based on the average yearly harvest from each sector during the period 2002 through 2008.66
Table 6.12	Percent shrimp trawl landings (lb) [‡] of major market groups for North Carolina, 1994-2010.70
Table 6.13	Percent shrimp trawl landings (lb) [‡] of major market groups for North Carolina by waterbody, 1994-2010.71
Table 6.14	Yearly finfish landings (lb) [‡] from shrimp trawls all North Carolina Waters combined, 1994-2010.72
Table 6.15	Percent shrimp trawl landings (lb) [‡] of top five finfish groups by waterbody, 1994-2010.73
Table 6.16	Percent shrimp trawl landings (lb) [‡] of major market groups landed for North Carolina (all waters combined) by month, 1994-2010.74
Table 6.17	Percent shrimp trawl landings (lb) [‡] of top five finfish groups by month, 1994-2010.75
Table 6.18	Author (year published), years sampled, area sampled, number of trips sampled, number of tows sampled, number of species observed , percent bycatch, percent finfish, percent shrimp, finfish to shrimp ratio (F:S), and bycatch to shrimp ratio (BC:S) of previous bycatch characterization work conducted in North Carolina and the South Atlantic.80
Table 8.1.	Detail values of pounds landed, total value, inflation adjusted value, price per pound, and percent change from year to year for shrimp landed in North Carolina, 1972 – 2010 (DMF Trip Ticket Program). 116
Table 8.2.	Gear type, pounds, price per pound, and total value of shrimp landings by gear in all North Carolina waters, 1994 – 2010 (DMF Trip Ticket Program). 119
Table 8.3.	Pounds and value of shrimp landed from North Carolina water bodies from 1994 – 2010 (DMF Trip Ticket Program). 121
Table 8.4.	Number of participants in the shrimp fishery by value of landings and year in North Carolina, 1999 – 2010 (DMF Trip Ticket Program). 127

Table 8.5.	Number of participants and the number of trips taken that landed shrimp in North Carolina, 1999 – 2010 (DMF Trip Ticket Program).....	128
Table 8.6.	Number of seafood dealer and pounds of shrimp purchased by North Carolina fish dealers from North Carolina fishermen, 1994 – 2010 (DMF Trip Ticket Program).....	130
Table 8.7.	Economic impact of the commercial shrimp fishery in North Carolina, 2010.....	134
Table 8.8.	Economic impact of RCGL fishing trips for shrimp in 2007 (DMF RCGL Survey).	135
Table 9.1.	Most frequently cited communities where shrimp fishermen live (DMF Socioeconomics Program).	137
Table 9.2.	Other prevalent species targeted by shrimp fishermen and average percent of fishing income made from non-target species (DMF Socioeconomics Program).	137
Table 9.3.	Fishing related issues considered most important to shrimp fishermen (DMF Socioeconomics Program).	139
Table 9.4.	Demographic characteristics of commercial shrimp fishermen (DMF Socioeconomics Program).	141
Table 9.5.	Demographic characteristics of RCGL holders who targeted shrimp in 2007. (DMF RCGL Survey Program).	142
Table 10.1	Spawning seasons for Penaeid shrimp species in North Carolina (Pattilo et al. 1997).	146
Table 10.2	Fishing gears used in North Carolina identified as potentially damaging to submerged aquatic vegetation habitat. (Source: MSC 1996).....	160
Table 10.3	Reported observations of tiger shrimp in NC since 2008.....	167
Table 12.1	Catch and effort data on shrimp and landed bycatch for channel nets in New River, 1994-2011 (courtesy of DMF trip ticket program).	212
Table 12.2	Catch and effort data on shrimp and landed bycatch for otter trawls in New River, 1994-2011 (courtesy of DMF trip ticket program).	212
Table 12.3	Catch and effort data on shrimp and landed bycatch for skimmer trawls in New River, 1994-2011 (courtesy of DMF trip ticket program).	213
Table 12.4	Catch and effort data on shrimp and landed bycatch for miscellaneous gear (cast nets, gill nets, etc.) in New River, 1994-2011 (courtesy of DMF trip ticket program). *Data confidential due to less than three participants reporting landings.	213
Table 12.5	Catch and effort data on crab and landed bycatch for crab trawls in New River, 1994-2010 (courtesy of DMF trip ticket program). *Data confidential due to less than three participants reporting landings.	214
Table 12.6	Statewide catch and effort data on shrimp and landed bycatch for channel nets, 1994-2011 (courtesy of DMF trip ticket program).	214
Table 12.7	Statewide catch and effort data on shrimp and landed bycatch for otter trawls, 1994-2011 (courtesy of DMF trip ticket program).	215
Table 12.8	Statewide catch and effort data on shrimp and landed bycatch for skimmer trawls, 1994-2011 (courtesy of DMF trip ticket program).	215
Table 12.9	Statewide catch and effort data on shrimp and landed bycatch for miscellaneous gear (cast nets, gill nets, etc.), 1994-2011 (courtesy of DMF trip ticket program).	216
Table 12.10	Statewide catch and effort data on crab and landed bycatch for crab trawls, 1994-2011 (courtesy of DMF trip ticket program).	217
Table 12.11	Number and average pounds, trips, and value in shrimp trawls, skimmer trawls, channel nets, cast nets and pound nets in state estuarine waters, 1994-2011.	241
Table 12.12	Number of pounds and trips in shrimp trawls, skimmer trawls, channel nets, cast nets and pound nets in the Southern District*, 1994-2011.....	242
Table 12.13	Number of pounds and trips in shrimp trawls, skimmer trawls, channel nets, cast nets and pound nets in the Central District*, 1994-2011.....	243

Table 12.14	Number of pounds and trips in shrimp trawls, skimmer trawls, channel nets, cast nets and pound nets in the Pamlico District*, 1994-2011.	244
Table 12.15	Number of pounds and trips in shrimp trawls, skimmer trawls, channel nets, cast nets and pound nets in the Northern District*, 1994-2011.	245
Table 12.16	Number of pounds and trips in shrimp trawls, skimmer trawls, channel nets, cast nets and pound nets in Pamlico Sound, 1994-2011.	246
Table 12.17	Summary statistics, results of paired t tests, percent differences and corresponding 95% confidence intervals for total catch (bycatch + shrimp catch), bycatch, and shrimp catch (kg) by vessel for 2008 skimmer trawl TED testing conducted in MS and AL.	257
Table 12.18	Summary statistics, results of paired t tests, percent differences and corresponding 95% confidence intervals for groups (crustaceans, invertebrates, teleost fish, and rays) (kg) by vessel for 2008 skimmer trawl TED testing conducted in MS and AL.	257
Table 12.19	Summary statistics, results of paired t tests, percent differences and corresponding 95% confidence intervals for total catch (bycatch + shrimp catch), bycatch, and shrimp catch (kg) by vessel for 2009 skimmer trawl TED testing conducted in MS and AL.	258
Table 12.20	Summary statistics, results of paired t tests, percent differences and corresponding 95% confidence intervals for groups (crustaceans, invertebrates, teleost fish, and rays) (kg) by vessel for 2009 skimmer trawl TED testing conducted in MS and AL.	258
Table 12.21	Summary statistics, results of paired t tests, percent differences and corresponding 95% confidence intervals for total catch (bycatch + shrimp catch), bycatch, and shrimp catch (kg) by vessel for 2010 skimmer trawl TED testing conducted in NC.	259
Table 12.22	Summary statistics, results of paired t tests, percent differences and corresponding 95% confidence intervals for groups (crustaceans, invertebrates, teleost fish, and rays) (kg) by vessel for 2010 skimmer trawl TED testing conducted in NC.	260
Table 12.23	Summary statistics, results of paired t tests, percent differences and corresponding 95% confidence intervals for total catch, bycatch, and shrimp catch (kg) for each experimental TED type in the 2011 NC skimmer trawl TED testing.	261
Table 12.24	Summary statistics, results of paired t tests, power analyses, percent differences (kg) and corresponding 95% confidence intervals for groups (crustaceans, debris, invertebrates, teleost fish) for each experimental TED type in the 2011 NC skimmer trawl TED testing.	261
Table 12.25	Summary statistics, results of paired t tests, percent differences and corresponding 95% confidence intervals for total catch, bycatch, and shrimp catch (kg) for each experimental TED type in the 2012 NC skimmer trawl TED testing.	262
Table 12.26	Summary statistics, results of paired t tests, power analyses, percent differences (kg) and corresponding 95% confidence intervals for groups (crustaceans, invertebrates, fish, debris, rays and sharks) for each experimental TED type in the 2012 NC skimmer trawl TED testing.	262
Table 12.27	Number of Pounds of Live Bait Shrimp (dozens, numbers) 1994 through 2011.	271
Table 12.28	Number and average pounds, trips, and value in shrimp trawls, skimmer trawls, channel nets, cast nets and pound nets in state estuarine waters, 1994-2011.	297
Table 12.29	Number and pounds, trips, and participants in shrimp trawls, skimmer trawls, channel nets, cast nets in state estuarine waters, 1994-2011.	298

Table 12.30	Average pounds of shrimp landed in North Carolina's inside waters per month by species, 2001-2011.....	300
Table 12.31	Average landings and effort by month of all shrimp species by waterbody* from otter and skimmer trawls combined), 2002-2011.....	303
Table 12.32	Maximum commercial, bait, and recreational shrimp trawl configurations by state	322
Table 12.33	North Carolina vessel and shrimp trawl configuration by area and year, 2010-2011.....	323
Table 12.34	Number of pounds, trips, value and participation in the estuarine shrimp trawl fishery.....	336
Table 12.35	Weighted CPUE, standard error (SE), total number collected (n), mean size (mm), and size range for select species during 2011 in the Pamlico Sound Survey (DMF 2012).....	338
Table 12.36	Current and past designated special secondary nursery areas.....	342
Table 12.37	Number of license sales of Recreational Commercial Gear Licenses, 2002 though 2011. (fiscal year, July 1 through June 30).....	349
Table 12.38	Number of trips by shrimp trawl by region, 2002-2008.	350
Table 12.39	Harvest (lb) and pounds per trip of shrimp by RCGL gear from 2002-2008.....	350
Table 12.40	Commercial estuarine shrimp trawl harvest and Recreational Commercial shrimp trawl harvest, 2002-2008.....	350
Table 12.41	Recreational Commercial trawl discard numbers and trips, 2002-2008.	351

2.2 LIST OF FIGURES

Figure 6.1.	Annual shrimp landings (lb) for North Carolina: 1962 – 2010.....	50
Figure 6.2.	Landings (lb) and trips for 1978-2010.	50
Figure 6.4.	North Carolina landings of shrimp by species 1978-1993.....	55
Figure 6.5.	North Carolina landings of shrimp by species: 1994 – 2010.	56
Figure 6.6.	Regions used to summarize findings from the RCGL surveys.....	60
Figure 6.7.	Distribution of RCGL residents.....	62
Figure 6.8.	Diagram of Florida Fish Excluder (FFE) tested in North Carolina waters.....	94
Figure 6.9.	Diagram of large mesh extended funnel BRD (LMEF) tested in North Carolina.....	95
Figure 6.10.	Diagram of modified large mesh funnel excluder (LMFE) tested in North Carolina.....	96
Figure 6.11..	Diagram of “Sea Eagle” fish excluder tested in North Carolina.	97
Figure 8.1..	Value of shrimp landings in North Carolina, 1972 – 2010 (DMF Trip Ticket Program).....	113
Figure 8.2..	Average price per pound of shrimp landings in North Carolina, 1972 – 2010 (DMF Trip Ticket Program).....	114
Figure 8.3..	Percent of landings by gear used to harvest shrimp in all North Carolina waters, 1994 – 2010 (DMF Trip Ticket Program).....	118
Figure 8.4..	Number of seafood dealers who purchased shrimp from 1994 to 2010 (DMF Trip Ticket Program).....	129
Figure 9.1.	Reported conflicts of North Carolina Shrimp Fishermen (DMF Socioeconomics Program).....	139
Figure 10.1a.	Shrimp nursery areas, including MFC designated nursery areas and SAV beds, in Pamlico Sound NC.	149
Figure 10.1b.	Shrimp nursery areas, including MFC designated nursery areas and SAV beds, for the Tar/Pamlico and Neuse Rivers.....	150
Figure 10.1c.	Shrimp nursery areas, including MFC designated nursery areas and SAV beds, for the Core Banks to Topsail Island.....	151
Figure 10.1d.	Shrimp nursery areas, including MFC designated nursery areas and SAV beds, for the Topsail Island to South Carolina.....	152
Figure 11.1.	Map of shrimp management areas in Brunswick County.	179
Figure 11.2.	Map of shrimp management areas in the Cape Fear River Complex.....	181
Figure 11.4.	Map of shrimp management areas in the Intracoastal Waterway and sounds from Rich’s Inlet to New River.	185
Figure 11.5.	Shrimp management areas in the White Oak River and Bogue Sound.....	188
Figure 11.6.	Map of the shrimp management areas in the Newport River, North River, Ward Creek, The Straits, and Back Sound.	190

Figure 11.7	Map of shrimp management areas in Core Sound and its surround estuaries.	192
Figure 11.8	Map of the shrimp management areas in The Neuse River and its tributaries.	195
Figure 11.9	Map of shrimp management areas in the Pamlico and Pungo Rivers.	197
Figure 11.10	Map of shrimp management areas in the Pamlico Sound and its tributaries.	199
Figure 11.11	Map of shrimp management areas in the Croatan and Roanoke Sounds.	200
Figure 12.1	Map of the New River showing the areas for the PNAs and SSNA as well as the otter trawl closure line.	218
Figure 12.2	Shrimp trips by gear in New River, 1994-2011. †Otter and crab trawls not allowed above Highway 172 Bridge in the New River.	219
Figure 12.3	Mean catch of shrimp in New River, 1994-2011. †Otter and crab trawls not allowed above Highway 172 Bridge in the New River.	219
Figure 12.4	Total catch of shrimp in pounds by gear in the New River, 1994-2011. †Otter and crab trawls not allowed above Highway 172 Bridge in the New River.	220
Figure 12.5	Number of trips and participants in the New River crab trawl fishery, 1994-2010.	220
Figure 12.6	Pounds of crab landed and number of pounds of crab landed per trip in the New River crab trawl fishery, 1994-2010.	221
Figure 12.7	NCDMF Fishery Management Districts	233
Figure 12.8	Skimmer Trawl Locations in Pender County.	234
Figure 12.9	Skimmer Trawl Locations in Onslow County.	235
Figure 12.10	Skimmer Trawl Locations in New River.	236
Figure 12.11	Skimmer Trawl Locations in Bogue Sound, White Oak River and Queens Creek.	237
Figure 12.12	Skimmer Trawl Locations in Newport River, North River, Back Sound and Lower Core Sound.	238
Figure 12.13	Skimmer Trawl Locations in Neuse River and Upper Core Sound.	239
Figure 12.14	Skimmer Trawl Locations in Pamlico Sound.	240
Figure 12.15	Diagram of typical skimmer trawl operation (Source: Hein and Meier 1995).	263
Figure 12.16	Skimmer trawl TED testing locations during 2008 in Mississippi and Alabama.	263
Figure 12.17	Skimmer trawl TED testing locations during 2009 in Mississippi and Alabama.	264
Figure 12.18	Skimmer trawl TED testing locations in 2010 in North Carolina.	264
Figure 12.19	Skimmer trawl track lines in the 2011 NC skimmer trawl TED testing.	265
Figure 12.20	Trawl locations for Vessel 1 (TODC TED configuration) in the 2012 NC Skimmer Trawl TED testing.	266

Figure 12.21	Trawl locations for Vessel 2 (BODC TED configuration) in the 2012 NC Skimmer Trawl TED testing.....	267
Figure 12.22	Percent difference for total catch, bycatch, and shrimp (kg) for each experimental TED type (TODC and BODC) in the 2012 NC skimmer trawl TED testing.	268
Figure 12.23	Percent difference for species groups by each experimental TED type (TODC and BODC) in the 2012 NC skimmer trawl TED testing.....	268
Figure 12.24	Percent difference for species groups by each experimental TED type (TOSC, BOSC, and TODC) in the 2011 LA skimmer trawl TED testing.....	269
Figure 12.25	Diagram of typical otter trawl (NOAA 2008).....	279
Figure 12.26	Topless trawl (Northeast Fisheries Science Center).....	280
Figure 12.27	Standard trawl (top) and T90 trawl (bottom) (Knuckey et al. 2008).....	286
Figure 12.28	T90 extension constructed by Mikey Daniels.....	287
Figure 12.29	Schematic of an otter trawl and its components (from NMFS 2012).....	324
Figure 12.30	Schematic of a skimmer trawl and its components (from NMFS 2012).....	324
Figure 12.31	Length frequency distribution of vessels using otter trawls in the Pamlico Sound, 2010-11.....	325
Figure 12.32	Length frequency distribution of total headrope length (ft) of otter trawls in the Pamlico Sound, 2010-11.....	325
Figure 12.34	Length frequency distribution of total headrope length (ft) of skimmer trawls in the Pamlico Sound, 2010-11.....	326
Figure 12.35	Length frequency distribution of vessels (ft) using otter trawls in the Neuse, Pamlico and Bay Rivers, 2010-11.....	327
Figure 12.36	Length frequency distribution of total headrope length (ft) of otter trawls in the Neuse, Pamlico and Bay Rivers, 2010-11.....	327
Figure 12.37	Length frequency distribution of vessels (ft) using skimmer trawls in the Neuse, Pamlico and Bay Rivers, 2010-11.....	328
Figure 12.38	Length frequency distribution of total headrope length (ft) of skimmer trawls in the Neuse, Pamlico and Bay Rivers, 2010-11.....	328
Figure 12.39	Length frequency distribution of vessels (ft) using otter trawls in the Bogue and Core Sounds as well as the Newport and North Rivers, 2010-11.....	329
Figure 12.40	Length frequency distribution of total headrope length (ft) of otter trawls in the Bogue and Core Sounds as well as the Newport and North Rivers, 2010-11.....	329
Figure 12.41	Length frequency distribution of vessels (ft) using skimmer trawls in the Bogue and Core Sounds as well as the Newport and North Rivers, 2010-11.....	330
Figure 12.42	Length frequency distribution of total headrope length (ft) of skimmer trawls in the Bogue and Core Sounds as well as the Newport and North Rivers, 2010-11.....	330
Figure 12.43	Length frequency distribution of vessels (ft) using otter trawls in the southern region of the state (New River, Cape Fear River, IWW to SC state line), 2010-11.....	331

Figure 12.44. Length frequency distribution of total headrope length (ft) of otter trawls in the southern region of the state (New River, Cape Fear River, IWW to SC state line), 2010-11.....	331
Figure 12.45. Length frequency distribution of vessels (ft) using skimmer trawls in the southern region of the state (New River, Cape Fear River, IWW to SC state line), 2010-11.	332
Figure 12.46. Length frequency distribution of total headrope length (ft) of skimmer trawls in the southern region of the state (New River, Cape Fear River, IWW to SC state line), 2010-11.....	332
Figure 12.47. Length frequency distribution of vessels (ft) using otter trawls in the Atlantic Ocean, 2010-11.	333
Figure 12.48. Length frequency distribution of total headrope length (ft) of otter trawls in the Atlantic Ocean, 2010-11.....	333
Figure 12.49. Scatter plot of vessel length (ft) and total headrope length (ft) of the North Carolina shrimp trawler fleet (all water bodies included), 2010-11.....	334
Figure 12.50. Weighted CPUE of Atlantic croaker, spot, and weakfish from the NCDMF Pamlico Sound Survey and number of shrimp trawl trips (effort lagged 1 year) in Pamlico Sound and Neuse, Pamlico and Pungo rivers (DMF 2012).....	339
Figure 12.52. Brunswick County Shrimp Management Areas.....	343

2.3 LIST OF ACRONYMS

AC – Advisory Committee

AEC – Areas of Environmental Concern

AFSA – Anadromous Fish Spawning Areas

ASMFC – Atlantic States Marine Fisheries Commission

BDTRT – Bottlenose Dolphin Take Reduction Team

BMP – Best Management Practices

BOD – Biological Oxygen Demand

BRD – Bycatch Reduction Device

CAHA – Cape Hatteras National Seashore

CAMA – Coastal Area Management Act

CEIP – Coastal Energy Impact Program

CHPP – Coastal Habitat Protection Plan

COE – United States Army Corp of Engineers

CPI – Consumer Price Index

CPUE – Catch Per Unit Effort

CRC – North Carolina Coastal Resources Commission

CRFL – Coastal Recreational Fishing License

DCM – North Carolina Division of Coastal Management

DENR – North Carolina Department of Environment and Natural Resources

DMF – Division of Marine Fisheries, The

DO – Dissolved Oxygen

DOT – North Carolina Department of Transportation

DPS – Distinct Population Segments

DWQ – North Carolina Division of Water Quality

E – Endangered

EDC – Endocrine Disrupting Chemicals

EEP – Ecosystem Enhancement Program

EEZ – Exclusive Economic Zone

EFH – Essential Fish Habitat

EMC – North Carolina Environmental Management Commission

EPA – United States Environmental Protection Administration

ESA – Endangered Species Act

FDA – United States Food and Drug Administration

FED – Fish Escape Device

FFE – Florida Fish Excluder

FMP – Fishery Management Plan

FRA – Fishery Reform Act

FRG – Fishery Resource Grant

FSC – Federal Species of Concern

GIS – Geographical Information System

GS – General Statute

GSAFDF – Gulf and South Atlantic Fisheries Development Foundation

HQW- High Quality Waters

IGNS – Independent Gill Net Study

ITP – Incidental Take Permit

IWW – Intracoastal Waterway

JHA - Juvenile Hormone Analogs

JLCSA – Joint Legislative Commission for Seafood and Aquaculture

LMEF – Large Mesh Extended Funnel

LMFE – Large Mesh Funnel Excluder

MAFMC – Mid Atlantic Fisheries Management Council

MFC – North Carolina Marine Fisheries Commission

MLMFE – Modified Large Mesh Funnel Excluder

MMAP – Marine Mammal Authorization Program

MMPA – Marine Mammal Protection Act

MRFSS – Marine Recreational Fisheries Statistical Survey

MRIP – Marine Recreational Information Program

MRT – Management Review Team

MSC – Moratorium Steering Committee

MSFCMA – Magnuson-Stevens Fishery Conservation and Management Act

NC – North Carolina

NCAC – North Carolina Administrative Code

NCDA – North Carolina Department of Agriculture

NCDACS – North Carolina Department of Agriculture and Consumer Services

NCDMF – North Carolina Division of Marine Fisheries

NCSU – North Carolina State University

NCTTP – North Carolina Trip Ticket Program

NEFSC – Northeast Fisheries Science Centers

NMFS – National Marine Fisheries Service

NOAA – National Oceanic and Atmospheric Administration

NWL – Normal Water Level

PDT – Plan Development Team

PNA – Primary Nursery Area

PPI – Producer Price Index

PPT – Parts Per Thousand

PSE – Proportional Standard Error

PSGNRA – Pamlico Sound Gill Net Restricted Area

RAT – Rules Advisory Team

RCGL – Recreational Commercial Gear License

RDD – Random Digit Dialing

RSCFL – Retired Standard Commercial Fishing License

SAFMC – South Atlantic Fishery Management Council

SAV – Submerged Aquatic Vegetation

SC – Species of Concern

SCFL – Standard Commercial Fishing License

SHA – Strategic Habitat Area

SNA – Secondary Nursery Area

SSB – Spawning Stock Biomass

SSA – Southern Shrimp Alliance

SSNA – Special Secondary Nursery Area

SSR – Stock Status Report

STAC – Sea Turtle Advisory Committee

STSSN – Sea Turtle Stranding and Salvage Network data

T – Threatened

TED – Turtle Excluder Device

TNC – The Nature Conservancy

TRP – Take Reduction Plan

USFWS – United States Fish and Wildlife Service

VPA – Virtual Population Analysis

WRC – North Carolina Wildlife Resources Commission

WS – Water Supply

YOY – Young of the Year

3.0 EXECUTIVE SUMMARY

The first North Carolina Shrimp Fishery Management Plan (FMP) was developed and approved by the Marine Fisheries Commission (MFC) in 2006. The plan set forth measures necessary to address bycatch, habitat, and conflict among shrimp fishermen as well as with other user groups. NC FMPs are reviewed at a minimum of every five years. A Shrimp FMP Plan Development Team (PDT) met beginning in the fall of 2011 to review the 2006 Shrimp FMP and determine whether it should be amended or revised. The PDT concluded that current management strategies in the plan continue to meet the goals and objectives of the Shrimp FMP and recommended to the Director of the Division of Marine Fisheries that the 2011 Shrimp FMP should proceed as a revision. After review by the MFC, the revision was taken to the MFC regional advisory committees, the MFC Habitat and Water Quality Advisory Committee and the MFC Crustacean/Shellfish Advisory Committee for review and public comment. Based on the concerns voiced at these meetings by the public on bycatch in the shrimp trawl fishery, the DMF recommended amending the 2006 Shrimp FMP. The MFC, at its November 2012 meeting, directed the DMF to amend the Shrimp Plan but to limit the scope of the amendment to bycatch issues in the commercial and recreational fisheries.

The goal of the North Carolina Shrimp FMP is to utilize a management strategy that provides adequate resource protection, optimizes the long-term commercial harvest, maximizes social and economic value, provides sufficient opportunity for recreational shrimpers, and considers the needs of all user groups. To achieve this goal, it is recommended that the following objectives be met:

1. Minimize waste and enhance economic value of the shrimp resource by promoting more effective harvesting practices.
2. Minimize harvest of non-target species of finfish and crustaceans and protected, threatened, and endangered species.
3. Promote the protection, restoration, and enhancement of habitats and environmental quality necessary for enhancing the shrimp resource.
4. Maintain a clear distinction between conservation goals and allocation issues.
5. Reduce conflicts among and within user groups, including non-shrimping user groups and activities.
6. Encourage research and education to improve the understanding and management of the shrimp resource.

There are three shrimp species that make up the shrimp fishery in North Carolina. These are the brown shrimp, *Farfantepenaeus aztecus*, the pink shrimp, *F. duorarum* and the white shrimp, *Litopenaeus setiferus*. Collectively, they are commonly referred to as penaeid shrimp. These species, considered annual crops, have similar life histories and are susceptible to similar predation, parasites and disease.

Population size is regulated by environmental conditions, and while fishing reduces the population size over the season, fishing is not believed to have a major impact on subsequent

year class strength unless the spawning stock has been reduced below a minimum threshold level by environmental conditions. Because of high fecundity and migratory behavior, shrimp are capable of rebounding from a very low population size in one year to a large population size in the next, provided environmental conditions are favorable. Fluctuations in abundance resulting from changes in environmental conditions will continue to occur. Shrimp stocks of all three species in North Carolina are considered viable.

3.1 STATUS OF THE FISHERIES

3.1.1 Commercial Fishery

Between the Civil War and the end of the first decade of the twentieth century, shrimp were caught with dip nets, cast nets and seines. The introduction of otter trawl technology in North Carolina seems to have first involved sampling nets used by the U.S. Bureau of Fisheries in Beaufort in 1912. The use of this technology prompted the development of trawl vessels. The type that was first used in the fishery involved open skiffs from 15 to 20 foot in length that were powered by small gasoline engines. As the fishery expanded during the 1930s, the construction of larger vessels specifically designed for shrimp trawling expanded. Technological advances in the shrimping industry have increased the catching efficiency of larger boats, particularly in Pamlico Sound. Modern safety and navigation equipment have allowed North Carolina shrimpers to steam longer distances, for longer periods of time to shrimp; and also to engage in a constantly changing variety of harvesting activities other than shrimping throughout the calendar year.

Landings in the North Carolina shrimp fishery vary from year to year and are dependent primarily on environmental conditions. The annual average was 6,460,849 lb for the period 1962-2010; 75% were harvested from inshore waters and 25% from the Atlantic Ocean. About 70-93% of shrimp trips occur in estuarine waters, with the remainder in ocean waters, primarily within state territorial seas (<3 mi offshore) off the central and southern coast of North Carolina. Total annual shrimping effort has decreased from a high of 40,000 trips in 1982 to a low of 6,500 trips in 2005. An examination of harvest by water body for the most recent twelve year period shows that 56% of the landings are from Pamlico Sound, 24% from the Atlantic Ocean and 6% from Core Sound. No other water bodies contribute more than 4% to the state's total landings.

The vast majority of the shrimp harvest (92%) is taken by otter trawls however, there has been a slight shift in the types of gear used to harvest shrimp in North Carolina in recent years. There has been an increase in number of vessels in Carteret, Onslow, and Pender counties that have switched from otter trawls to skimmers with skimmers accounting for 3% of the average annual state landings. Channel nets are stationary nets that fish the surface and middle depths on an outgoing tide. They resemble a staked-out trawl anchored to the bottom to keep it open. Channel nets account for 5% of the average annual shrimp landings.

North Carolina brown shrimp commercial landings have averaged 3.8 Mlb since 1999 with fluctuations from a high of 6.5 Mlb in 2000 to a low of 1.5 Mlb in 2005. Generally, 85% of all brown shrimp landed are caught in estuarine waters with Pamlico Sound, Core Sound, New River, and Neuse River accounting for most of the harvest.

Pink shrimp have historically (1978-1993) accounted for about 27% of the shrimp landings. North Carolina commercial pink shrimp landings averaged 1.8 Mlb from 1978 to 1993. However, since 1999, pink shrimp landings have averaged only 0.2 Mlb. despite mild winters in

the late 1990s and early 2000s. Pink shrimp have accounted for 4% of the state's harvest during the last 12 years. Core Sound accounts for 45% of the landings, followed by Pamlico Sound (29%), and the ocean (13%).

During the period 1978-1993, North Carolina commercial white shrimp landings averaged 0.5 Mlb with landings fluctuating from a high of 1.7 Mlb in 1993 to a low of 11,000 pounds in 1981. The landings increased significantly for the most recent 12 years to an average of 2.5 Mlb. The percentage of the white shrimp taken in the ocean is higher (40%) than the other two species, reflecting its greater abundance in the southern part of the state where the majority of the ocean fishery occurs. Since 1999 the majority of white shrimp have been harvested from the Ocean (40%), Pamlico Sound (35%) and New River (6%).

3.1.2 Recreational Fishery

Shrimp are harvested recreationally throughout the state by otter trawls, skimmer trawls, seines, cast nets, shrimp pots and shrimp pounds. As of July 1, 1999, anyone wishing to harvest shrimp recreationally with commercial gear is required to purchase a Recreational Commercial Gear License (RCGL). RCGL allow recreational fishermen to use limited amounts of commercial gear to harvest seafood for their personal consumption. Seafood harvested under this license cannot be sold. RCGL holders are limited to the same bag and size limits as Coastal Recreational Fishing License (CRFL) holders.

On average the highest number of RCGL trips using shrimp trawls from 2002 to 2008 occurred in the Pamlico region, followed by the southern region, the central region, and the northern region. In the Pamlico region, the number of trips ranged from 1,127 (2005) to 2,384 (2002), averaging 1,642 per year from 2002 to 2008. In the southern region, the number of trips ranged from 355 (2007) to 1,123 (2002), averaging 586 trips per year. An average of 413 trips a year were made in the central region, ranging from 132 (2008) to 1,070 (2002). In the Northern region, the number of trips ranged from 50 (2006) to 911 (2004). Overall, the highest number of trips made by RCGL using shrimp trawls was observed in 2002; the lowest was observed in 2007.

RCGL holders harvested an average of 52,352 pounds of shrimp a year from 2002 to 2008 with the highest landings occurring in 2002 (101,766 lb), followed by 2008 (54,359 lb) and 2003 (50,961 lb). RCGL holders harvested an average of 16.8 pounds of shrimp per trip from 2002 to 2008. The highest pounds of shrimp per trip was observed in 2009 (22.3 lb/trip), followed by 2006 (20.3 lb/trip) and 2002 (19.1 lb/trip).

3.1.3 Shrimp Trawl Bycatch

Bycatch can be divided into two components: incidental catch and discarded catch. Incidental catch refers to retained catch of non-targeted species. Discarded catch is that portion of the catch returned to the sea as a result of economic, legal, or personal considerations. While it is becoming increasingly apparent to scientists, natural resource managers, and much of the general public that bycatch is an important issue that must be addressed, characterizing the nature and extent of bycatch and its impact on fish stocks has proven extremely difficult. Although many species are caught as bycatch in the estuarine shrimp trawl fishery, four species, blue crab, weakfish, Atlantic croaker, and spot have, since the first studies were conducted in the 1950s and continuing to the present, accounted for the bulk of the bycatch.

Trawl minimum mesh size regulations are the principal method used to regulate fishing mortality on fish stocks and is the preferred management tool in lieu of other more stringent regulations. Bycatch reduction devices (BRDs) and turtle excluder devices (TEDs) are required in shrimp trawls for use in reducing bycatch of finfish and sea turtles. Other gears such as shrimp pots, pounds and cast nets also reduce finfish bycatch; minimize environmental concerns and conflicts with other fisheries. Catch restrictions have been used by fisheries managers to maintain fish stocks, extend fishing seasons, allocate resources, and reduce bycatch. In North Carolina this method is being used to reduce the targeting of marketable finfish with shrimp trawls. Area restrictions for trawling are also used to deal with allocation, resource, bycatch, habitat, and safety issues in North Carolina.

3.2 PROTECTED RESOURCES

Of the federal and state protected species listed, only bottlenose dolphins, and sea turtles interact with the shrimp fishery. Otter trawls and skimmer trawls are the predominant gear in the shrimp fishery. Both trawls are active gears that focus on the estuarine bottom, and are restricted to areas without submerged aquatic vegetation; interactions with protected species are plausible. Channel nets used less extensively in the shrimping fishery are a passive gear and use tide flow and current to fish. There is no information on interactions with protected species and channel nets.

3.3 ECONOMIC STATUS

The annual nominal (inflated) value of shrimp landings typically has been volatile with large changes between years. The lowest nominal value was \$3.5 million in 1972. The highest nominal value was \$25.4 million in 2000. Landings value in 1981 dropped 69% from 1980. The fishery rebounded in 1982 with a 210% increase in the nominal value of landings over 1981. The value of the fishery dropped by 53% in 2001 from the record high 2000 value. In 2002, the value increased 54% over the 2001 value, but it remained considerably lower than the 2000 value. The nominal value hit a 20 year low in 2005 (\$4.4 million), dropping 50% over the previous year's value; however, the fishery recovered to over \$19.2 million in 2008. Ex-vessel value of landings in 2010 was \$10.7 million.

3.4 SOCIOECONOMIC CHARACTERISTICS

DMF surveys (2005, 2007, 2008, and 2009) asked the fishermen for their opinion as to how historically important they think commercial fishing is to their community. On a scale of one to ten, with one being not at all important to ten being extremely important, the average rating across all 175 persons interviewed was 9.7, indicating almost universal agreement that fishing has been historically important to their community. When asked how much their community supports commercial fishing now (using the same 10-point scale), the rating was 8.1, indicating they largely feel supported.

North Carolina coastal communities rely significantly less on commercial fishing now than in the past. This is the result of the development of the communities as multiple use zones, with retirement, light industry, recreation, and tourism becoming the dominant domains of the local economies. Fewer and fewer native born residents make a full time living as fishermen like those in previous generations. DMF studies found that among commercial shrimp fishermen, the average fisherman earned about 76% of his income from commercial fishing. More specifically the studies found that just over half (51%) were totally reliant on fishing for their

incomes. This compares with data gathered in the late 1980s where nearly all full time fishermen captains were committed to fishing for nearly all (95%) of their incomes.

3.5 ENVIRONMENTAL FACTORS

Penaeid shrimp use a variety of estuarine and coastal ocean habitats with variations in habitat preference due to location, season, and ontogenetic stage. Penaeid shrimp are found in the water column, wetlands, submerged aquatic vegetation (SAV), soft bottom, and shell bottom. Each of these habitats is part of a larger habitat mosaic, which plays a vital role in the overall productivity and health of the coastal ecosystem. Although penaeid shrimp are found in all of these habitats, the usage varies by habitat. Additionally, these habitats provide the appropriate physicochemical and biological conditions necessary to maintain and enhance the penaeid shrimp population. Each habitat provides ecological services that aid in maintaining and enhancing shrimp stock sustainability, and also influences the functioning of the ecosystem overall. Protecting the integrity of the entire system is therefore necessary to manage this species.

Adequate water quality is also necessary to maintain the chemical properties of the water column that are needed by shrimp, as well as sustain SAV, shell bottom, and soft bottom habitats that support shrimp. Human activities that degrade water quality or alter water flow can negatively impact shrimp growth or survival. The common causes of water quality use support impairment in North Carolina's coastal river basins are excessive sediment loading and low dissolved oxygen (DO). Hydrological modifications, low DO and toxin contamination are probably the greatest water quality concerns for penaeid shrimp in North Carolina.

3.6 MANAGEMENT STRATEGIES

There were several major issues identified as being pertinent to the shrimp fishery in the 2006 FMP. These included trawling (bycatch, habitat), competition among shrimp fishermen as well as with other user groups and insufficient bycatch data. Management strategies were developed to address these issues and will remain in place in the Shrimp FMP Amendment 1. Shrimp trawling is a controversial topic and has been the subject of much debate. Strategies from the 2006 plan that address both bycatch and habitat concerns include area closures and restrictions in gear size in specific water bodies. Gear studies and shrimp trawl characterization studies have been carried out and will continue to be addressed in the future.

Protection of vulnerable habitats from the effects of trawling was also achieved through implementation of the 2006 FMP. Additional closures along with increased gear restrictions and gear more friendly to habitat continue to be implemented in this plan.

The use of trawls by RCGL holders and the significance of its impact on the shrimp fishery was examined. Management strategies include; a 48-quart limit on recreational shrimp catches, allowing skimmer trawls as a RCGL gear and defined dimensions of a shrimp pound for use as a RCGL gear.

Many of the management strategies are water body specific and address user conflicts through area and gear restrictions. A 90 foot headrope limit in internal waters, with the exception of Pamlico Sound and portions of the Neuse, Pamlico and Pungo rivers, also reduces conflict as well as decrease bycatch.

3.6.1 Shrimp Management by Size

Shrimp grow at different rates depending on water temperature and salinity. As growth increases, shrimp migrate to deeper, saltier waters of the sound and eventually to the ocean. As shrimp migrate to the ocean, they enter areas that are open or may be opened by DMF to the harvest of shrimp. Sampling is conducted by DMF staff to determine if an area should be opened or closed, based primarily on size and count. Over time, target sizes for opening different waterbodies have evolved and allow for better flexibility of management for both recreational and commercial shrimping.

3.6.2 Shrimp Management by Area

Historically, DMF has used a number of criteria to determine if trawling should be allowed in estuarine waters. These criteria include habitat issues such as aquatic vegetation, water depth and bottom types; shrimp size and abundance; economic and social factors; user conflicts; and bycatch issues. DMF uses rules and proclamations to manage trawling in internal coastal waters. The intention of these rules and proclamations has been to allow the harvest of shrimp and crabs in estuarine waters but prohibit directed finfish trawling. Openings and closings of specific areas are based primarily on the size of the shrimp.

3.6.3 Shrimp Management in the Southern District

The areas that can be opened to shrimping are typically located either in or landward of the Intracoastal Water Way (IWW) which runs the entire length of the Onslow, Pender, New Hanover and Brunswick counties coastline. In Brunswick and portions of New Hanover counties, where shrimp migrate at smaller sizes, DMF attempts to open on a 40-50 count shrimp. In Onslow and parts of Pender counties, sampling has shown that a 20-30 count can be attained before migration occurs. Channels that connect the IWW with the Atlantic Ocean are normally left open at all times to allow some harvest of shrimp as they migrate from closed areas to the ocean.

3.6.4 Shrimp Management in the Central District

Management of shrimping in the Central District takes place from the White Oak River on the Onslow/Carteret County line to Core Sound in Carteret County. The Central District also manages the south side of the Neuse River in Craven County. Areas that are open and closed to shrimping through proclamation include: West Bay/Long Bay, Thorofare Bay, several tributaries in Core Sound and Adams Creek, located on the south side of the Neuse River. Target counts vary dependent on the waterbody and range from 26 to 30 count to 31 to 35 count (heads-on).

3.6.5 Shrimp Management in Pamlico District

Management of shrimping in the Pamlico District occurs in the Neuse, Pamlico, Pungo and Bay rivers as well as Pamlico Sound. These areas with the exception of Bay River have permanent closure lines and requires little sampling. As sampling dictates, lines may be moved downstream by proclamation to protect small shrimp until they are large enough to harvest. The target count size is ranges from a 26-30 count or 31-35 count (heads-on). When sampling

indicates that the majority of the shrimp in a closed area have reached this target size, the area is opened by proclamation.

3.6.6 Shrimp Management in the Northern District

Species specific shrimp sampling occurs in the Northern District only when necessary (during banner shrimp years). An exception is data collected in Stumpy Point Bay for brown shrimp. The low relative abundance of white and pink shrimp in the Northern District requires minimal sampling effort except during times of extreme environmental conditions. In such cases, sampling efforts may be initiated on demand in order to provide the foundation for shrimp management decisions of DMF.

3.6.7 Atlantic Ocean

Since shrimp that migrate from the estuaries are usually large, DMF does not actively manage the ocean waters. However, in the past and exclusively off the Brunswick County coast, DMF has been requested by the fishermen to take a more active role in the management of the ocean shrimp fishery. These requests were precipitated as result of the heavy hurricane or tropical storm induced rains that have impacted southeastern North Carolina with regularity since the mid-1990s. Fresh water from these heavy rains dramatically reduces salinities in the estuaries causing the shrimp to prematurely migrate from the estuaries into the ocean. When this occurs, DMF generally closes the impacted ocean and estuarine waters to shrimp trawling.

3.7 BYCATCH IN THE SHRIMP FISHERY AND MANAGEMENT OPTIONS

The DMF, at the direction of the MFC, presented the 2012 Shrimp FMP revision to the MFC Southern Regional AC, the MFC Northern Regional AC, the MFC Habitat and Water Quality AC and the MFC Shellfish/Crustacean AC and also took public comment at each of these committees. With the exception of the Southern AC, all of the committees voted to revise the Shrimp FMP. However, due to the overwhelming public comment concerning the issue of bycatch in the shrimp trawl fishery and the acknowledgement that bycatch is an issue in the shrimp fishery; the DMF changed its recommendation to the MFC to move forward with amending the Shrimp FMP. The MFC then directed the division amend the plan but to limit the scope of the amendment to bycatch issues in the commercial and recreational fisheries.

Twenty-nine different management options were brought forward to a Shrimp FMP Advisory Committee (AC) to address eight different issues during monthly meetings from January through September 2013. Management strategies that were discussed included: Alternative fishing gears, Turtle Excluder Devices (TEDs) in skimmer trawls, gear modifications, effort management, head rope lengths, number of nets and vessel lengths, and area restrictions. In addition, at the request of the Southern AC, during the public comment review of the 2012 Shrimp FMP revision, the New River trawl fishery and the consideration of a live bait shrimp fishery was also addressed through Amendment 1.

The MFC, at its November 2013 meeting approved Amendment 1 for review by the public, regional and standing MFC committees and selected preferred management strategies during its February 2014 meeting.

3.7.1 Marine Fisheries Commission Preferred Management Strategies and Required Actions

The Commission's preferred management strategies and required actions based on input are listed in table 3.1 and are identified under each bycatch issue addressed. An overview of the Shrimp Advisory Committee's, the division's, and the commission's recommendations to reduce bycatch as provided to each regional and standing committee for input are provided in Appendix 1. Recommendations from each regional and standing committee as well as public input may also be found in Appendix 1.

Table 3.1 The Marine Fisheries Commission preferred management strategies, and required actions to reduce bycatch.

Management Strategy	Required Actions
Status quo (continue to prohibit otter trawls in the New River special secondary nursery area above the Highway 172 Bridge).	Rule change required in 15A NCAC 03J .0208
Allow hand cast netting of shrimp in all closed areas and increase the limit to four quarts, with heads on per person.	Rule change required in 15A NCAC 03L .0105
Status quo on a license requirement to fish a cast net for shrimp.	No action required
Upon federal adoption of TEDs in skimmer trawls, the division will support the federal requirement.	No action required
Establish a permitted live shrimp bait fishery and for DMF to craft the guidelines and permit fees after reviewing permitted operations in other states, and to allow live bait fishermen with a permit to fish until 12 p.m. (noon) on Saturday.	Based on review of other state operations, future rule changes will be required and include 15A NCAC 03J .0104, 03L .0102, 03O .0105, 03O .0503
Allow any federally certified BRD in all internal and offshore waters of NC.	Existing proclamation authority
Update the scientific testing protocol for the state's BRD certification program.	Existing authority
<p>Convene a stakeholder group to initiate industry testing of minimum tail bag mesh size, T-90 panels, skylight panels, and reduced bar spacing in TEDs to reduce bycatch to the extent practicable with a 40 percent target reduction.</p> <ul style="list-style-type: none"> • Upon securing funding, testing in the ocean and internal waters will consist of three years of data using test nets compared to a control net with a Florida fish eye, a federally approved TED and a 1.5-inch mesh tail bag. • Results should minimize shrimp loss and maximize reduction of bycatch of finfish. Promising configurations will be brought back to the commission for consideration for mandatory use. • The stakeholder group may be 	Existing authority

<p>partnered with the division and Sea Grant.</p> <ul style="list-style-type: none"> Members should consist of fishermen, net/gear manufacturers and scientific/gear specialists. 	
<p>Require either a T-90/square mesh tailbag or other applications of square mesh panels (e.g., skylight panel), reduced bar spacing in a TED, or another federal or state certified BRD in addition to existing TED and BRD requirements in all skimmer and otter trawls.</p>	<p>Existing proclamation authority Rule change required in 15A NCAC 03I .0101</p>
<p>Status quo on effort management (no change in season, weekend, or night time fishing).</p>	<p>No action required</p>
<p>In order to put a cap on fleet capacity as a management tool, establish a maximum combined headrope length of 220 feet in all internal coastal waters where there are no existing maximum combined headrope requirements with a two-year phase out period.</p>	<p>Rule change required in 15A NCAC 03L .0103</p>
<p>Prohibit shrimp trawling in the IWW channel from Sunset Beach to the SC state line, including Eastern Channel, lower Calabash River and Shallotte River.</p>	<p>Rule change required in 15A NCAC 03R .0114</p>
<p>Recommend the MFC Habitat and Water Quality Advisory Committee to consider changing designation of special secondary nursery areas that have not been opened to trawling since 1991 to permanent secondary nursery areas.</p>	<p>Based on review of the advisory committee, rule changes will be required and include 15A NCAC 03R .0104, 03R .0105</p>

4.0 INTRODUCTION

4.1 LEGAL AUTHORITY FOR MANAGEMENT

Fisheries management includes all activities associated with maintenance, improvement, and utilization of the fisheries resources of the coastal area, including research, development, regulation, enhancement, and enforcement.

Many different state laws (General Statutes - G.S.) provide the necessary authority for fishery management in North Carolina. General authority for stewardship of the marine and estuarine resources by the North Carolina Department of Environment and Natural Resources (DENR) is provided in G.S. 113-131. The Division of Marine Fisheries (DMF) is the arm of the Department that carries out this responsibility. Enforcement authority for DMF enforcement officers is provided by G.S. 113-136. General Statute 113-163 authorizes research and statistical programs. The North Carolina Marine Fisheries Commission (MFC) is charged to “manage, restore, develop, cultivate, conserve, protect, and regulate the marine and estuarine resources of the State of North Carolina” (G.S. 143B-289.51). The MFC can regulate fishing times, areas, fishing gear, seasons, size limits, and quantities of fish harvested and possessed (G.S. 113-182 and 143B-289.52). General Statute 143B-289.52 allows the MFC to delegate authority to implement its regulations for fisheries “which may be affected by variable conditions” to the Director of DMF by issuing public notices called “proclamations”. Thus, North Carolina has a very powerful and flexible legal basis for coastal fisheries management. The General Assembly has retained for itself the authority to establish commercial fishing licenses and mandates that there will be no fees charged for permits unless specifically authorized. It has delegated to the MFC authority to establish permits for various commercial fishing activities.

The Fisheries Reform Act of 1997 (FRA) establishes a process for preparation of coastal fisheries management plans in North Carolina (G.S. 113-182). The Act was amended in 1998 and again in 2004. The FRA states that “the goal of the plans shall be to ensure the long-term viability of the State’s commercially and recreationally significant species or fisheries. Each plan shall be designed to reflect fishing practices so that one plan may apply to a specific fishery, while other plans may be based on gear or geographic areas. Each plan shall:

- a. Contain necessary information pertaining to the fishery or fisheries, including management goals and objectives, status of the relevant fish stocks, stock assessments for multi-year species, fishery habitat and water quality considerations consistent with Coastal Habitat Protection Plans adopted pursuant to G.S. 143B-279.8, social and economic impact of the fishery to the State, and user conflicts.
- b. Recommend management actions pertaining to the fishery or fisheries.
- c. Include conservation and management measures that will provide the greatest overall benefit to the State, particularly with respect to food production, recreational opportunities, and the protection of marine ecosystems, and will produce a sustainable harvest.
- d. Specify a time period, not to exceed two years from the date of the adoption of the plan, for ending overfishing. This subdivision shall only apply to a plan for a fishery that is not producing a sustainable harvest.

- e. Specify a time period, not to exceed 10 years from the date of adoption of the plan, for achieving a sustainable harvest. This subdivision shall not apply if the Fisheries Director determines the biology of the fish, environmental conditions, or lack of sufficient data make implementing the requirement of this subdivision incompatible with professional standards for fisheries management.
- f. Include a standard of at least fifty percent (50%) probability of achieving sustainable harvest for the fishery or fisheries. This subdivision shall not apply if the Fisheries Director determines the biology of the fish, environmental conditions, or lack of sufficient data make implementing the requirement of this subdivision incompatible with professional standards for fisheries management.

Sustainable harvest is defined in the FRA as “The amount of fish that can be taken from a fishery on a continuing basis without reducing the stock biomass of the fishery or causing the fishery to become overfished”.

Overfished is defined as “The condition of a fishery that occurs when the spawning stock biomass of the fishery is below the level that is adequate for the recruitment class of a fishery to replace the spawning class of the fishery”.

Overfishing is defined as “Fishing that causes a level of mortality that prevents a fishery from producing a sustainable harvest”.

4.2 RECOMMENDED MANAGEMENT PROGRAM

4.2.1 Goals and Objectives

The goal of the North Carolina Shrimp Fishery Management Plan is to utilize a management strategy that provides adequate resource protection, optimizes the long-term commercial harvest, maximizes social and economic value, provides sufficient opportunity for recreational shrimpers, and considers the needs of all user groups. To achieve this goal, it is recommended that the following objectives be met:

1. Minimize waste and enhance economic value of the shrimp resource by promoting more effective harvesting practices.
2. Minimize harvest of non-target species of finfish and crustaceans and protected, threatened, and endangered species.
3. Promote the protection, restoration, and enhancement of habitats and environmental quality necessary for enhancing the shrimp resource.
4. Maintain a clear distinction between conservation goals and allocation issues.
5. Reduce conflicts among and within user groups, including non-shrimping user groups and activities.
6. Encourage research and education to improve the understanding and management of the shrimp resource.

4.2.2 Sustainable Harvest

Sustainable harvest for the penaeid shrimp fishery in North Carolina is defined as the amount of harvest that can be taken by fishermen without reducing the spawning stock below the level necessary to ensure adequate reproduction. This is appropriate for an annual crop such as shrimp when recruitment is dependent largely on environmental conditions rather than female biomass. That is, a relatively small number of mature shrimp can provide sufficient recruits for the subsequent year's production. The sustainable harvest for the Shrimp FMP in North Carolina is the annual harvest of the three species of shrimp combined.

4.2.3 Management Strategy

The management strategy for the shrimp fisheries in North Carolina is to continue to 1) optimize resource use over the long-term, and 2) minimize waste. The first strategy is accomplished by protection of critical habitats, and gear and area restrictions to protect the stock. Minimization of waste is accomplished by gear modifications, bycatch reduction devices, area closures, and harvest restrictions.

4.3 DEFINITION OF MANAGEMENT UNIT

The management unit includes the three major shrimp species of shrimp: brown (*Farfantepenaeus aztecus*), pink (*Farfantepenaeus duorarum*), and white (*Litopenaeus setiferus*) and its fisheries in all coastal fishing waters of North Carolina, which includes the Atlantic Ocean offshore to three miles.

4.4 GENERAL PROBLEM STATEMENT

During preparation of Amendment 1, bycatch in the commercial and recreational shrimp fishery was addressed. Management options were separated into 1) gear modifications; 2) effort management; 3) area restrictions; and 4) other fishing gears. In addition, at the request of the Southern AC, during the public comment review of the 2012 Shrimp FMP revision, the New River trawl fishery and the consideration of a live bait shrimp fishery was also addressed through Amendment 1.

4.4.1 New River Trawl Fishery

At the request of the Southern AC, the prohibition of otter trawls in the New River Special Secondary Nursery Area (SSN) was discussed. The use of otter trawls upstream of the Highway 172 Bridge was phased out in 2010 following the adoption of the 2006 Shrimp FMP. Those who wished to continue to harvest shrimp in the waters above the Highway 172 Bridge were allowed a four year grace period to convert to skimmers trawls.

4.4.2 Use of Other Fishing Gears

The majority (89%) of the estuarine shrimp harvest in North Carolina comes from otter trawls. However, major concerns associated with otter trawls are the capture and discard of various amounts of other non-target species and discard mortality associated with otter trawls. Skimmer trawls, channel nets, pound nets and cast nets are other gears that are used to harvest shrimp; however factors that impact these gears' effectiveness have to be considered.

4.4.3 Gear Modifications

One available management measure to reduce bycatch is gear modification requirements. Potential gear modifications requirements such as requiring TEDs in skimmer trawls, mesh size changes, bycatch reduction devices (BRDs), and square mesh panels modifications are considered to further reduce bycatch in the shrimp fishery. Also considered by the AC were testing of gear by the industry and the creation of a stakeholder group as well as updating the division's BRD certification program.

4.4.4 Live Bait Shrimp Fishery

At the request of the Southern AC, the consideration of a regulatory process for live bait shrimping was addressed. The division's current management for larger shrimp causes areas where live bait shrimping occurs to close due to the presence of small shrimp. Bycatch occurs in the smaller bait trawls but at-net bycatch mortality is generally low due to short tow times, and culling times. However as temperatures increase, mortality usually increases as well.

4.4.5 Effort Management

In considering ways to reduce bycatch, reducing effort in the shrimp trawl fishery with seasonal closures, closing trawling an additional day of the week, nighttime closures, and restricting tow times were discussed by the AC. Also considered were ways to make the fishery less efficient by looking at restricting headrope lengths, vessel size, and net size.

4.4.6 Area Restrictions

Since 1978 almost one million acres of estuarine waters have been closed to trawling through fishery nursery area designations (primary and secondary nursery areas), military danger zones and restricted areas, and trawl net prohibited areas. This is approximately 45 percent of the estuarine waters. Another 65,000 acres of estuarine waters are closed some time during the year, either due to shrimp size management or areas classified as SSNAs. Several area restrictions ranging from closing all internal waters to closing a small area in Brunswick County was discussed as another way to reduce bycatch.

4.5 EXISTING PLANS STATUTES, AND RULES

4.5.1 Plans

The South Atlantic Fishery Management Council (SAFMC) Shrimp Fishery Management Plan allows for concurrent closures of Federal waters in conjunction with State closures through emergency action, following severe winter cold weather that results in an 80% or more reduction in the population of overwintering shrimp or if water temperatures are 8°C (46° F) for a minimum of one week and was implemented through Amendment 9. This cooperative plan allows maximum protection of the remaining adult population. The Council plan and its amendments have had minimal impact on the NC shrimp fishermen until the addition of Amendment 6. In December 2003, as part of Amendment 6, the Council voted to establish a control date of December 10, 2003 for the shrimp fishery in the Atlantic Exclusive Economic Zone (EEZ). This control date was set to place the industry on notice that a limited access program may be developed. The amendment also includes options to monitor and measure bycatch within the fishery. The Council's preferred monitoring option is the implementation of the Atlantic Cooperative Statistics Program Release, Discard and Protected Species Module. This module

establishes a minimum set of standard data to be collected to characterize and estimate levels of bycatch.

The first North Carolina Shrimp Fishery Management Plan was developed and approved by the MFC in 2006. The plan set forth measures necessary to address bycatch, habitat, and competition among shrimp fishermen as well as with other user groups. NC FMPs are reviewed at a minimum of every five years. A Shrimp FMP PDT met beginning in the fall of 2011 to review the 2006 Shrimp FMP and determine whether it should be amended or revised. The PDT discussed several management issues that had developed since the implementation of the 2006 FMP and included discussion of:

- restricted trawl areas offshore of Bogue Banks;
- a permanent shrimping line in Newport River;
- trawling in New River above the highway 172 bridge; and
- volumetric measurement of shrimp.

Each issue was addressed by the PDT in issue papers, providing background information as well as management options and their potential positive and/or negative impacts on the fishery (see Appendix 1). After thorough discussion, no changes in management strategies were recommended for three of the four issues listed above. The group did make recommendations to change from a count of 100 shrimp per person per day to a volumetric measure of shrimp of two quarts per person per day that may be taken while fishing in a closed area with a cast net. This recommendation is due to the nature of this fishery, where several fishermen will work together and combine their harvest in a single large container. This often leads to one Marine Patrol Officer having to count shrimp while surrounded by numerous fishermen, putting that Officer's safety at risk. This does result in a rule change for the benefit of Officer's Safety and it was concluded that this rule change will not have an impact on the shrimp stock and will remain consistent with the 2006 Shrimp FMP.

To insure the public was aware that the 2006 Shrimp FMP was under review, a press release was sent out on November 7, 2011 requesting public comment as part of the review process to determine whether to proceed with an amendment or a revision of the 2006 Shrimp FMP. The Division received six comments which were reviewed and addressed by the PDT (see Appendix 1). The PDT concluded that these comments and recommendations were appropriately addressed within the 2006 Shrimp FMP and that current management strategies in place are continuing to meet the goals and objectives of the 2006 Shrimp FMP. Therefore, it was recommended by the PDT to the Director that the 2012 Shrimp FMP should proceed as a revision.

The DMF, at the direction of the MFC, presented the 2012 Shrimp FMP revision to the MFC Southern Regional AC, the MFC Northern Regional AC, the MFC Habitat and Water Quality AC and the MFC Shellfish/Crustacean AC and also took public comment at each of these committees. With the exception of the Southern AC, all of the committees voted to revise the Shrimp FMP. However, due to the overwhelming public comment concerning the issue of bycatch in the shrimp trawl fishery, the DMF changed its recommendation to the MFC to move forward with amending the Shrimp FMP. Meeting minutes from each committee and public comment may be found in Appendix 1 of this plan.

4.5.2 Statutes

All management authority for North Carolina's shrimp fishery is vested in the State of North Carolina. Statutes that have been applied to the shrimp fishery include:

- It is unlawful to engage in a commercial fishing operation in coastal fishing waters without holding a standard commercial fishing license (SCFL) [G.S. 133-1682].
- Individuals who are 65 years of age or older and are eligible for a SCFL may apply for a retired standard commercial fishing license (RSCFL) [G.S. 133-168.3].
- It is unlawful to fish in the ocean from vessels or with a net within 750 feet of a properly licensed and marked fishing pier [G.S. 113-185].
- It is unlawful to engage in trash or scrap fishing (the taking of young of edible fish before they are of sufficient size to be of value as individual food fish) for commercial disposition as bait, for sale to any dehydrating or nonfood processing plant, or for sale or commercial disposition in any manner. The MFC's rules may authorize the disposition of the young of edible fish taken in connection with the legitimate commercial fishing operations, provided it is a limited quantity and does not encourage "scrap fishing" [G.S. 113-185].
- It is unlawful to willfully take, disturb or destroy any sea turtles including green, hawksbill, loggerhead, Kemp's ridley, and leatherback turtles, or their nests or eggs. It shall be unlawful to willfully harm or destroy porpoises [G.S. 113-189].
- It is unlawful for any person without the authority of the owner of the equipment to take fish from nets, traps, pots, and other devices to catch fish which have been lawfully placed in the open waters of the State [G.S. 113-268 (a)].
- It is unlawful for any vessel in the navigable waters of the State to willfully, wantonly, and unnecessarily do injury to any seine, net or pot [G.S. 113-268 (b)].
- It is unlawful for any person to willfully destroy or injure any buoys, markers, stakes, nets, pots, or other devices or property lawfully set out in the open waters of the state in connection with any fishing or fishery [G.S. 113-268 (c)].

4.5.3 Marine Fisheries Commission Rules (June 1, 2013)

4.5.3.1 General

- Channel net is defined as a net used to take shrimp which is anchored or attached to the bottom at both ends or with one end anchored or attached to the bottom and the other end attached to a boat [15A NCAC 3I .0101 (3)(b)].
- Headrope is defined as a support structure for the mesh or webbing of a trawl that is nearest to the water surface when in use. [15A NCAC 3I .0101 (3)(i)].
- Nursery areas are defined as areas in which for reasons such as food, cover, bottom

type, salinity, temperature and other factors, young finfish and crustaceans spend the major portion of their initial growing season [15A NCAC 3I .0101 (4)(f)].

- There is a cooperative agreement between the DENR, the MFC, and the Wildlife Resources Commission (WRC) that the WRC will have regulatory jurisdiction over any species of sea turtle and their eggs and nests consistent with the designation of endangered or threatened. Law enforcement officers of both the DMF and the WRC have jurisdiction to enforce any state laws and rules relating to endangered or threatened species of sea turtles [15A NCAC 3I .0107 (a)].
- The Fisheries Director may close or restrict by proclamation any coastal waters with respect to taking or attempting to take any marine resources when the method used is a serious threat to an endangered or threatened species [15A NCAC 3I .0107 (b)].
- Military danger zones and restricted areas are designated in 15A NCAC 3R .0102 and are enforced by the appropriate federal agency [15A NCAC 3I .0110 (a)].
- Maps or charts showing the boundaries of areas identified by rule or in proclamations are available for inspection [15A NCAC 3I .0121 (a)].
- The DMF shall mark boundaries with signs insofar as may be practical. No removal or relocation of signs shall have the effect of changing the classification or affect the applicability of any rule pertaining to that body of water [15A NCAC 3I .0121 (b)].

4.5.3.2 Nets, Pots, Dredges, and Other Fishing Devices

- It is unlawful to use or set a fixed or stationary net in the Intracoastal Waterway where it may be a hazard to navigation, block more than two-thirds of any natural or manmade waterway, in the middle third of any marked navigation channel [15A NCAC 3J .0101 (1)(2)(3)].
- It is unlawful to possess aboard a vessel while using a trawl in internal waters more than 500 pounds of finfish from December 1 through February 28 and 1,000 pounds of finfish from March 1 through November 30 [15A NCAC 3J .0104 (a)].
- It is unlawful to use trawls nets in internal coastal waters from 9:00 p.m. on Friday through 5:00 p.m. on Sunday, except for the areas described in the next bullet [15A NCAC 3J .0104 (b) (1)].
- It is unlawful to use trawl nets from December 1 through February 28 from one hour after sunset to one hour before sunrise in portions of the Pungo, Pamlico, Bay, Neuse, and New rivers [15A NCAC 3J .0104 (b) (5)(A)(B)(C)(D)(E)].
- Trawls cannot be used to take oysters [15A NCAC 3J.0104 (2)].
- It is unlawful to use trawl nets in Albemarle Sound and its tributaries [15A NCAC 3J .0104 (b) (3)].
- The Director may by proclamation, require bycatch reduction devices or codend modifications in trawl nets to reduce the catch of finfish that do not meet size limits or are

unmarketable as individual foodfish by reason of size [15A NCAC 3J .0104 (d)].

- It is unlawful to use trawl nets in designated pot areas opened to the use of pots by 15A NCAC 3J .0301(a)(2) within an area bound by the shoreline to the depth of six feet [15A NCAC 3J .0104 (6)].
- It is unlawful to use shrimp trawls for the taking of blue crabs in internal waters, except that it shall be permissible to take or possess blue crabs incidental to commercial shrimp trawling provided that the weight of the crabs shall not exceed 50 percent of the total weight of the combined crab and shrimp catch; or 300 pounds, whichever is greater [15A NCAC 3J .0104 (f)(2)].
- For RCGL trawling, 50 crabs, not to exceed 100 blue crabs if two or more RCGL holders are on board [15A NCAC 3J .0104 (f)(1)].
- It is unlawful to use shrimp trawls for recreational purposes unless the trawl is marked with a pink buoy on the tailbag [15A NCAC 3J .0104 (e)].
- The Fisheries Director may, by proclamation, close any area to trawling for specific time periods in order to secure compliance with this rule [15A NCAC 3J .0104 (g)].
- It is unlawful to use a channel net until the Director specifies by proclamation when and where channel nets and other fixed nets for shrimping can be used [15A NCAC 3J .0106 (a)(1)].
- It is unlawful to set a channel net without yellow light reflective tape on the staffs, stakes and buoys [15A NCAC 3J .0106 (a)(2)].
- Channel nets cannot be set with any portion of the set within 50 feet of the center line of the Intracoastal Waterway (IWW) channel or in the middle third of any navigation channel marked by the Corps of Engineers or the Coast Guard. Fishermen must attend channel nets by being no more than 50 yards from the set at all times [15A NCAC 3J .0106 (a)(3)(4)(5)].
- The maximum corkline length of a channel net that can be used or possessed is 40 yards. No channel net, net buoys or stakes can be left in coastal waters from December 1 through March 1. From March 2 through November 30, cables and any attached buoy must be connected together with non-metal line when not attached to the net. Metallic floats or buoys to mark sets are unlawful [15A NCAC 3J .0106 (b)(c)(d)(e)].
- Channel nets must be properly marked with yellow light reflective tape and the owner's identification on each buoy. Identification includes one of the following: owner's NC motorboat registration number or the US vessel documentation number or owner's last name and initials. Channel nets, anchor lines or buoys are not to be used in any way that constitutes a hazard to navigation [15A NCAC 3J .0106 (f) and (g)].
- It is unlawful to use channel nets to take blue crabs in internal waters, except that it shall be permissible to take or possess blue crabs incidental to channel net operations provided that the weight of the crabs do not exceed 50% of the total weight of crab and shrimp or 300 lb whichever is greater [15A NCAC 3J .0106 (h)(1)(A)(B)].

- The Director may, by proclamation, close any area to channel net use for specific time periods in order to secure compliance with the above bullet [15A NCAC 3J .0106 (h)(2)].
- It is unlawful to use nets from June 15 through August 15 in the waters of Masonboro Inlet or in the ocean within 300 yards of the beach between Masonboro Inlet and a line running 138° through the water tank on the northern end of Wrightsville Beach, a distance parallel with the beach of 4,400 yards. It is unlawful to use trawls within one-half mile of the beach between the Virginia line and Oregon Inlet [15A NCAC 3J. 0202 (1)(2)].
- It is unlawful to use a trawl with a mesh length less than four inches in the body and three inches in the extension and on and three-fourths inches in the cod end or tail bag from the west side of Beaufort Inlet Channel to the shore off Salter Path within a half mile of shore [15A NCAC 3J .0202 (3)].
- From December 1 through March 31 it is unlawful to possess finfish caught incidental to shrimp and crab trawling in the Atlantic Ocean unless the weight of the combined catch of shrimp and crabs exceeds the weight of finfish; except that crab trawlers working south of Bogue Inlet may keep up to 300 pounds of kingfish, regardless of their shrimp or crab catch weight [15A NCAC 3J .0202 (5)].
- It is unlawful to use shrimp trawls in all waters west of a line beginning at the southeastern tip of Baldhead Island at a point 33° 50.4833'N – 77° 57.4667 W; running southerly in the Atlantic Ocean to a point 33° 46.2667'N – 77° 56.4000 W from 9:00 PM through 5:00 AM [15A NCAC 3J .0202 (8)].
- It is unlawful to use trawl nets upstream of the Highway 172 Bridge in New River from 9:00 p.m. through 5:00 a.m. when opened by proclamation from August 15 through November 30 (15A NCAC 3J .0208).
- It is unlawful to use any commercial fishing gear in the Southport Boat Harbor, Brunswick County and to use any commercial fishing gear in the Progress Energy Intake Canal between the fish diversion screen and the Brunswick nuclear power plant (15A NCAC 3J .0206, 15A NCAC 3J .0207).
- It is unlawful to use shrimp pots with mesh lengths smaller than one and one-fourth inches stretch or five-eighths inch bar [15A NCAC 3J .0301(e)].
- It is unlawful to use pots with leads or leaders to take shrimp. Leads are defined as any fixed or stationary net or device used to direct fish into any gear [15A NCAC 3J .0301(l)].
- It is unlawful for a RCGL holder to use pots, including shrimp pots unless each pot is marked by attaching one hot pink floating buoy; the buoy should be engraved with the gear owners boat registration number or US vessel documentation name [15A NCAC 3J .0302(a)(1)(2)].
- In Dare County commercial fishing gear may not be used within 750 feet of licensed fishing piers when opened to the public. Commercial fishing gear may not be used in the Atlantic Ocean off of portions of Onslow, Pender, and New Hanover counties during

specified time frames [15A NCAC 3J .0402(a)(1)(A)(ii)(2)(A)(B)(i)(ii)(3)(A)(B)(i)(iii)(4)].

- Shrimp pound net set is defined as a pound net set constructed of stretch mesh equal to or greater than one and one-fourth inches and less than or equal to two inches [15A NCAC 3J .0501(a)(6)].
- A permit is required to deploy a pound net set and must be operational for a minimum of 30 consecutive days during the permit period. Each pound required the permittee's identification on a sign attached to a stake at the permitted ends of each set at all times. They must have yellow light reflective tape or yellow light reflective devices on each pound and have a marked navigational opening at least 25 feet wide at the end of every third pound and marked with yellow light reflective tape or yellow light reflective devices [15A NCAC 3J .0501 (b)(c)].
- It is unlawful to use a RCGL shrimp pound net unless it is marked by attaching to the offshore lead, one hot pink floating buoy. The owner shall be identified on the buoy by engraving the gear owner's current boat registration number or the owners US vessel documentation name. Each shrimp pound must be set a minimum of 100 yards from a RCGL pound net set or 300 yards from an operational permitted shrimp pound net set [15A NCAC 3J .0501(d)(1)(2)].
- It is unlawful within 30 days of abandonment of a permitted pound net set to fail to remove all stakes and associated gear from coastal fishing waters [15A NCAC 3J .0501(g)].
- Pound net permit applications, renewals and transfers are to comply with the permitting procedures and requirements for obtaining all DMF-issued permits. Application process, criteria for the granting of the permit, operational requirements and other elements of the shrimp pound net set permits are found in 15A NCAC 3J .0502, 15A NCAC 3J .0503, 15A NCAC 3J .0504 and 15A NCAC 3J .0505.

4.5.3.3 Oysters, Clams, Scallops and Mussels

- It is unlawful to use a trawl net in any designated Shellfish or Seed Management area [(15A NCAC 03K .0103 (b))].
- It is unlawful to use a trawl in any designated Seed Oyster Management Area [15A NCAC 03K .0208 (b)].
- It is unlawful to use a trawl in Oyster Sanctuaries [15A NCAC 03K .0209 (a)].

4.5.3.4 Shrimp, Crabs, and Lobster

- It is unlawful to take shrimp with nets until the Director opens the season in various waters by proclamation (15A NCAC 03L .0101).
- It is unlawful to take shrimp by any method from 9:00 PM on Friday through 5:00 p.m. on Sunday except in the Atlantic ocean or with the use of fixed and channel nets, hand seines, shrimp pots and cast nets [15A NCAC 03L .0102 (1)(2)].

- It is unlawful to take shrimp with mesh lengths less than one and one-half inches in trawls, one and one-fourth inches in fixed nets, channel nets, float nets, butterfly nets and hand seines [15A NCAC 03L .0103)(a)(1)(2)].
- It is unlawful to take shrimp with a net constructed in a manner as to contain an inner or outer liner of any mesh size. Net material used as chafing gear shall be no less than four inches mesh length [15A NCAC 03L .0103) (b)].
- It is unlawful to take shrimp with trawls which have a combined headrope of greater than 90 feet in internal coastal waters except in Pamlico Sound, Pamlico River downstream of Pamlico Point/ Willow Point and Neuse River downstream of Winthrop Point/Windmill Point [15A NCAC 03L .0103)(c)(1)(2)(3)].
- It is unlawful to use a shrimp trawl in the Pungo River, upstream of Wades Point/Abel Bay, Pamlico River upstream of the entrance to Goose Creek/Wades Point and Neuse River upstream of Cherry Point/Wilkerson Point 15A [NCAC 03L .0103)(d)].
- It is unlawful to use a shrimp trawl that does not conform with the federal requirements for TEDs [15A NCAC 03L .0103)(g)].
- It is unlawful to possess more than 48 quarts, heads-on or 30 quarts heads-off of shrimp per person per day or per vessel per day for recreational purposes [15A NCAC 03L .0105)(1)].
- It is unlawful to take or possess shrimp taken from any area closed to the taking of shrimp except for 2 quarts per person per day may be taken with a cast net in a closed area [15A NCAC 03L .0105)(2)].
- It is unlawful to use trawls in the crab spawning sanctuaries from March 1 through August 31 [15A NCAC 03L .0205(a)].
- It is unlawful to use a trawl net in any primary or permanent secondary nursery area [15A NCAC 3N .0104, 3N .0105 (a)].
- Special secondary nursery areas may be opened to shrimp and crab trawling from August 16 through May 14 [15A NCAC 3N .0105(b)].

4.5.3.5 Licenses, Leases, Franchises, and Permits

- RCGL gear includes one shrimp trawl with a headrope not exceeding 26 feet in length per vessel, five shrimp pots, skimmer trawls, not exceeding 26 feet in total combined width and one shrimp pound net with each lead 10 feet or less in length and with a minimum lead net mesh of 1 ½ inches and enclosures constructed of net mesh of 1 ¼ inches or greater and with all dimensions being 36 inches or less. Attendance is required at all times for shrimp pounds [15A NCAC 3O .0302(a)(2)(3)(7)(8)].
- It is unlawful to possess more than 48 quarts, heads-on, or 30 quarts, heads-off, of shrimp when only one person aboard a vessel possesses a valid RCGL and recreational commercial fishing equipment [15A NCAC 3N .0303(e)].

- It is unlawful to possess more than 96 quarts, heads on or 60 quarts, heads off of shrimp if more than one person aboard a vessel possesses a valid RCGL and recreational commercial fishing equipment [15A NCAC 3N .0303(f)].
- It is unlawful to trawl for shrimp in the Atlantic Ocean without TEDs within one nautical mile of shore from Browns Inlet to Rich's Inlet without a valid permit to waive the requirement to use TEDs in the Atlantic Ocean when allowed by proclamation from April 1 through November 30. It is unlawful to tow more than 55 minutes from April 1 through October 31 and 75 minutes from November 1 through November 30. It is unlawful to not fully empty the contents of each net after each tow. It is unlawful to refuse to take observers. It is unlawful to fail to report any sea turtle captured [15A NCAC 03O .0503 (d) (1)(2)(3)(4)(5)].

4.5.5 Federal Regulations

33 CFR 334.410 through 334.450

These rules designate prohibited and restricted military areas, including locations within North Carolina coastal fishing waters, and specify activities allowed in these areas.

50 CFR 223.206 - Exceptions to prohibitions relating to sea turtles.

The incidental taking of sea turtles in the shrimp trawl fishery is exempted from section 9 of the Endangered Species Act (ESA) if conservation regulations are followed and include the installation of NOAA Fisheries approved TEDs and alternative tow times for skimmer trawls, pusher-head trawls and butterfly trawls.

50 CFR 223.207 – Approved TEDs

This lists NOAA Fisheries approved TEDs such as the single-grid hard TEDs, hooped hard TEDs, special hard TEDs and soft TEDs, along with materials and gear specifications. Testing protocols for TEDs are also included in this rule.

50 CFR 229.7 – Monitoring of incidental mortalities

.This requires that fishermen who participate in a Category I or II fishery are required to accommodate an observer onboard your vessel(s) up on request

50 CFR 622, Appendix D – Approved BRDs

This lists NOAA Fisheries approved BRDs and provides technical specifications for the construction and subsequent legal enforcement of these BRDs.

5.0 STATUS OF THE STOCK

5.1 GENERAL LIFE HISTORY

There are three shrimp species that make up the shrimp fishery in North Carolina. These are the brown shrimp, *Farfantepenaeus aztecus*, the pink shrimp, *F. duorarum* and the white shrimp, *Litopenaeus setiferus*. The lifecycle of these three species are similar in that the adults spawn offshore and eggs are hatched into free-swimming larvae. These larvae develop through several stages into post-larvae. Once post-larval shrimp enter the estuaries, growth is rapid and is dependent on salinities and temperatures. After reaching sub-adult sizes between 70 - 120 mm TL, they migrate seaward. It is hypothesized that as shrimp increase in size, they seek higher more stable salinities because of a decrease in the ability to osmoregulate (Bishop et al. 1980). In low salinity environments the growth rates of juvenile shrimp have been found to be significantly reduced because energy that would be allocated to somatic growth is used for osmoregulation (Rozas and Minello 2011). In general, shrimp are omnivorous, feeding primarily on sediment, detritus, algae, and benthic organisms. Feeding occurs mostly at night, although some daytime feeding will occur in turbid water. Shrimp are dioecious (separate sexes) with females growing larger than males. Shrimp copulate with the male depositing spermatophore onto the female's thelycum. Fertilization takes place when the female expels ova and spermatozoa simultaneously. Shrimp are very fecund with females expelling between 500,000 to 1,000,000 eggs. Spawning occurs before they reach 12 months old. Environmental requirements for the three species are listed in Table 5.1.

5.1.1 Brown Shrimp

Brown shrimp occur from Massachusetts to the Florida Keys and into the Gulf of Mexico to northwestern Yucatan. Highest abundances occur in the Gulf of Mexico, off Mississippi, Louisiana, and Texas. The species supports a major commercial fishery along the South Atlantic coast, primarily in North and South Carolina.

Brown shrimp reach sexual maturity at 140-145 mm and spawn in the ocean in deep water during February and March. Brown shrimp are thought to have the potential to spawn more than once within a year in the Gulf of Mexico (Calillouet Jr. et al. 2008); however, St. Amant et al. (1966) suggest that brown shrimp die after spawning once. After the eggs are hatched, larvae are then transported by wind and currents from the high salinity ocean waters to the estuaries. Ten to 17 days later, the larval shrimp have grown into postlarvae and are approximately between 8 and 14 mm. They generally enter the inlets on a flood tide. They are then carried by wind driven currents to the upper reaches of the estuaries beginning in February with peaks occurring in mid-March through mid-April (Williams 1955a, 1965). It takes approximately 4-6 weeks for postlarvae to grow to the juvenile stage. Rapid development into sub-adults begins to occur with reported growth rates ranging from 1 to 2.5 mm per day and is dependent on temperature and salinities (Williams 1955; Steele 2002). Significant growth occurs between 11°C and 18°C (Zein-Eldin and Aldrich 1965; Steele 2002). Growth is enhanced if salinities are greater than 10 ppt (Amant et al. 1966; Steele 2002) and reduced if salinities are less than 4 ppt (Saoud and Davis 2003). As the individuals increase in size, they move to the deeper, saltier waters of the sound and return to the sea in late fall. Brown shrimp are omnivorous, and feed on different plants and animals and organic debris (Steele 2002). Juveniles between 25 and 65 mm feed on detritus and microorganisms from the top layer of sediment while larger shrimp (65-104 mm) become active predators feeding on polychaetes, amphipods, nematodes as well as detritus and algae (Jones 1973; Steele 2002). Brown shrimp prefer peat and muddy bottoms but are also found on sand, silt, or clay mixed with shell and

rock fragments (Steele 2002). They also are found on bottoms covered with plant debris (Williams 1959). They are often more active in open waters at night than in daytime. Brown shrimp have a maximum life span of 18 months and may reach a size of 7 to 9 in.

5.1.2 Pink Shrimp

Pink shrimp are found from southern Chesapeake Bay to the Florida Keys, and around the coast through the Gulf of Mexico to Yucatan. The largest population of pink shrimp is off southwestern Florida in the Tortugas and Sanibel as well as in the southeastern portion of Golfo de Campeche. However, significant quantities of pink shrimp are also found off North Carolina, and along the northeast Florida coast (Steele 2002).

Spawning occurs in ocean waters from April to July with post larvae being carried into the estuary on wind-driven currents from May through November (Williams 1965). Histological examination of the ovaries of pink shrimp in Florida indicates year-round spawning; however, seasonal differences in water temperatures may inhibit spawning in the northern most regions (Kennedy and Barber 1981). The northernmost breeding population of pink shrimp is off North Carolina (Williams 1955a). Once in the nursery areas, the shrimp undergo rapid growth (1 to 1.8 mm/day). As they grow and develop, they move toward the deeper waters of the sound and eventually into the ocean. Browder et al. (2002) noted that pink shrimp growth is optimal at a salinity of 30 ppt and decreases as salinity increases or decreases around this mark; however growth was found to increase with temperature up to 35°C. Pink shrimp are active at night and burrow into the bottom during the day. A significant number of pink shrimp overwinter in the North Carolina estuaries before moving into the ocean the following spring. Pink shrimp are bottom feeders and feed primarily in shallow waters among marine plants. As with brown shrimp, the majority of feeding occurs at night, but feeding may also occur during the day when the water is turbid. Stomach content analysis of pink shrimp in Tampa Bay revealed sand, debris, algae, diatoms, seagrass particles, dinoflagellates, foraminiferans, nematodes, polychaetes, ostracods, copepods, mysids, isopods, caridean shrimp, caridean eggs, mollusks and fish scales. Female pink shrimp reach sexual maturity at 85 mm while males are sexually mature at 74 mm. They have a maximum life span of 24 months and can reach a size of 10 to 11 in.

5.1.3 White Shrimp

White shrimp occur along the Atlantic coast from Fire Island, New York to Saint Lucie Inlet Florida (Steele 2002). They also are found in the Gulf of Mexico from the mouth of the Ochlockonee River, Florida to the Golfo de Campeche to the vicinity of Ciudad Campech usually in depths less than 90 ft (Muncy 1984; Steele 2002).

Spawning occurs in the ocean at depths greater than 30 ft and within five miles of shore from March to November, peaking from April to October. White shrimp are capable of spawning more than once in a year (Nance et al. 2010); however, it is thought that they may only spawn once in North Carolina waters (Williams 1965). Spawning appears to be triggered by increasing bottom water temperatures in the spring and decreases with decreasing water temperature in the fall (Muncy 1984). In South Carolina, extremely cold spring water temperatures were found to delay sexual maturation while slightly warmer temperatures promoted maturation (DeLancey et al. 2005). Planktonic postlarvae move inshore with tidal currents, entering estuaries two to three weeks after hatching where they then become benthic. Shallow muddy bottoms in waters of low to moderate salinity serve as optimum nursery grounds for juvenile white shrimp. Juveniles reach lengths of about 20-31 mm by July, and move from shallow marshes into

deeper creeks, rivers, bays and sounds. White shrimp migrate out of the estuaries and southward during fall and early winter, and make up the valuable spring fishery for adult females in Georgia, South Carolina, and southern North Carolina. Some of the slower-growing individuals overwinter in the estuaries, but usually do not survive in North Carolina. White shrimp mortality has been reported at water temperatures of 46° F and lower, with total mortality occurring at 37° F or lower. Winter water temperatures in North Carolina sometimes are lethal for white shrimp. DeLancey et al. (2005) noted that the relative abundance of white shrimp was strongly influenced by winter water temperature, indicating that periods of milder winters yielded higher relative abundances of white shrimp in South Carolina. White shrimp are omnivorous, selective particulate feeders that search the sand grains and pass bits of food forward to the mouth. Gut content analysis findings include inorganic and organic debris, as well as fragments of different animals including nematodes, annelids, mollusks, crustaceans, particles of higher plants and a variety of diatoms and algae (Steele 2002). Soft muddy bottoms are the preferred habitat of white shrimp with highest abundances in areas of extensive brackish marshes. White shrimp have a maximum life span of 16 months and can reach a size of 7 to 8 in.

Table 5.1 Environmental Requirements of three shrimp species found in North Carolina.

Species	Salinity	Temperature	Oxygen	Juvenile recruitment	Season
Brown Shrimp	2-35 ppt	7° to 37 ° C (44.6 ° to 98.6 ° F)	< 2 ppm causes stress	February - March	Summer and fall
Pink Shrimp	0-45 ppt	6° to 38 ° C (42.8 ° to 100.4 ° F)	0.2 to 6.0 ppm	June - October	Spring Late
White Shrimp	2-35 ppt	7° to 38 ° C (44.6 ° to 100.4 ° F)	< 2 ppm causes stress	April - May	Summer and fall

5.1.4 Movement

DMF conducted several tagging studies on the three species of shrimp in the 1960s through the early 1970s (Table 5.2). Shrimp were marked with biological stains and fluorescent pigments and released throughout this time period within different areas of Pamlico Sound, Core Sound, Bogue Sound, New River and Cape Fear River. These shrimp were recovered in shrimp houses throughout the coastal counties. Rewards ranged from 0.50 cents to \$1.00 per returned shrimp.

McCoy and Brown (1967) marked brown and pink shrimp from Jarrett Bay and North River in Core Sound and white shrimp in Dutchman Creek-Elizabeth River and Cape Creek of the lower Cape Fear River. A combined average of 65% of all returned shrimp were recaptured before reaching the Atlantic ocean with resulting movement toward the higher salinity areas of Beaufort Inlet from Core Sound and Cape Fear Inlet from Cape Fear River.

White shrimp did move upriver in the Cape Fear River. However, this was caused by the strong tidal influences in the river. Of those shrimp that made it to the Atlantic Ocean, all three species had a pronounced southward coastal migration. It was concluded in this study that the brown and pink shrimp are more endemic to North Carolina while the white shrimp from the

southeastern coastal NC contribute to the shrimp fishery of South Carolina, Georgia, and Florida.

Table 5.2 Migration studies in North Carolina of three shrimp species found in North Carolina.

Study	Year	Waterbodies	Species	Release number	Percent return
McCoy and Brown (1967)	April-Oct, 1966	Core Sound, Lower Cape Fear	Brown, Pink, White	26,989	6.2
McCoy (1968)	June-Sept, 1967	Pamlico Sound	Brown, Pink	11,414	10.5
McCoy (1972)	May, July, 1968	Core and Bogue Sound, New River	Brown, Pink	9,231	42.4
Purvis and McCoy (1974)	1971-1972	Pamlico Sound	Brown	7,325	19.1

McCoy (1968) marked pink shrimp from West Bay that moved to the Atlantic Ocean through Core Sound and through Drum and Beaufort inlets. Pink shrimp from Adams Creek moved toward Beaufort Inlet and through southern Pamlico Sound to Drum Inlet and Bardens Inlet. This suggests that a significant portion of Pamlico Sound pink shrimp reach the ocean through Beaufort and Bardens inlets by migrating through Core Sound.

Brown shrimp marked by McCoy (1968) in Swan Quarter Bay and Jones Bay generally moved toward the central and southern Pamlico Sound area. Data were unclear as to the most probable route to the Atlantic Ocean but it did suggest that few shrimp from the northern and western sound reached the ocean. Brown shrimp randomly released in Pamlico Sound in 1972 generally moved toward the nearest inlet (Ocracoke). However, no mass migration from the sound to the ocean occurred to any appreciable degree resulting in the conclusion that the Pamlico Sound brown shrimp fishery is a self-contained fishery with shrimp growing to large sizes (16-30 count heads-off) before migrating to the ocean (Purvis and McCoy 1972).

Pink shrimp marked in Core Sound moved to the ocean through Barden and Beaufort inlets with the majority of the movement through Beaufort Inlet. Bogue Sound pink shrimp moved toward the ocean via Beaufort and Bogue inlets with the largest number of recaptures occurring from the western half of the sound. There appeared to be no significant movement of pink shrimp between Core and Bogue Sound. Brown shrimp released in New River moved to the ocean in a southerly direction along the coast (McCoy 1972).

5.1.5 Predation

Shrimp are preyed upon by numerous species of finfish and invertebrates at various stages of their life cycle (Bielsa et al. 1983; Muncy 1984; Larson et al. 1989; Minello et al. 1989). Facendola and Scharf (2012) found that penaeid shrimp made up 30.7% of the diet (by weight) of age 0-1 juvenile red drum and 1.1% (by weight) of the diet of age 1-2 red drum in the New River; indicating as red drum grow, their diets shift from shrimp and crabs to primarily fish. Penaeid shrimp also have been reported to make up a large portion of the diets of other sciaenids as well as the diets of numerous finfish commonly found in marine and estuarine environments (Carr and Adams 1973; Minello and Zimmerman 1983). Additionally, a wide variety of coastal and wading birds are also known to prey upon shrimp. Given that penaeid

shrimp are such an important food source for multiple species of organisms it is hard to quantify exactly how much is consumed by each species and what affect it has on the year-to-year fluctuations in shrimp abundance.

5.1.6 Parasites and Disease

Diseases and parasites in penaeid shrimps come in the forms of viruses, bacteria, fungi, protozoa, flatworms and nematodes. Johnson (1978) noted that penaeid shrimp are vulnerable to numerous diseases which may be caused by microbes (bacteria, fungi, viruses), protozoa (microsporidians, gregarines, apostome ciliates, ectocommensal protozoa), as well as physical and chemical factors (lack of oxygen, poisons, low temperatures, salinity extremes). Disease ranks second only to predation and mass kills of natural populations in the Gulf and South Atlantic (Couch 1978) in shrimp mortality. The *Baculovirus* infects larval and adult shrimp and is associated with mortality, especially in larval shrimp. The effect of bacteria on mortality is unclear; however *Vibrio*, *Beneckea*, and *Leucothrix* are associated with disease in penaeid shrimps. Several types of fungi can be very destructive to tissue of larval shrimp. There are several types of protozoa that are parasitic and commensal and include Microsporidia which cause the condition commonly known as “cotton shrimp” or “milk shrimp” and Ciliata which causes black gill disease. Flatworms and nematodes can also be found in muscles and viscera of penaeid shrimp (Couch 1978).

Cotton disease is widespread and is found in all three species of shrimp on the South Atlantic and Gulf coasts (Johnson 1978; Bielsa 1983; Muncy 1984; Larson 1989). There are several species of *Microsporidia* that infects the tail muscle of the shrimp, as well as the organs and tissues with masses of spores. These spores cause the white discoloration of muscle giving infected shrimp a cotton or paper-white color. These types of infections can also cause black banding throughout the abdomen of infected shrimp and can render shrimp incapable of reproduction (Johnson 1978). This parasite kills shrimp. A typical catch of wild shrimp contains a few infected individuals. Infected shrimp are not thought to be harmful to humans; however they are often discarded due to appearance and texture of the infected tissue.

Black gill disease results from infection by a single-celled protozoan called a Ciliata (SC DNR 2002). It attaches itself to a thin area around the gills of the shrimp's shell. This attachment either causes structural damage or erodes a hole through the shell, causing inflammation. The black pigmentation of the gill results from an immune response to the inflammation. Black gill is thought to inhibit respiration, slowing growth and potentially making shrimp more prone to predation. However, the infestation of black gill disease does not result in any noticeable mortality in the wild and appears to attach in mass when shrimp are stressed (SC DNR 2002). Black gill has been observed in pink, brown, and white shrimp (Johnson 1978). Black gill poses no threat to humans.

Several penaeid shrimp viruses may be carried by imports from Asia and South America as well as from expanding aquaculture. These viruses enter processing facilities and aquaculture facilities through infected brood stock, contaminated feed, infected transport containers or by migratory birds. These viruses may infect our three species of native shrimp but there is little information on the presence of exotic shrimp viruses in populations of our native shrimp in North Carolina. There is currently one permitted, *Penaeus vannamei* (Pacific White Shrimp) farm in Vass, NC and another under review in Morrisville (C. Hardy. NCDMF, personal communication).

5.2 STOCK STATUS

All three species of shrimp included in this FMP are essentially annual crops. Population size is regulated by environmental conditions, and while fishing reduces the population size over the season, fishing is not believed to have any impact on subsequent year class strength unless the spawning stock has been reduced below a minimum threshold level by environmental conditions. Estimates of population size are not available but since the fishery is considered to be fished at near maximum levels, annual landings are probably a good indication of relative abundance. Annual variations in catch are presumed to be due to a combination of prevailing environmental conditions and fishing effort. More recently, landings are showing the effects of changes in the economics of the fishery.

Because of high fecundity and migratory behavior, the three species are all capable of rebounding from a very low population size in one year to a large population size in the next, provided environmental conditions are favorable. Fluctuations in abundance resulting from changes in environmental conditions will continue to occur. Perhaps the most serious threat to the stocks is loss of habitat due to pollution or physical alteration. Especially vulnerable and critical to shrimp production is the salt marsh (for white and brown shrimp) and inshore seagrass habitat (especially for pink shrimp) which comprise the nursery areas for juvenile shrimp. Since the inception of the 2006 Shrimp FMP, shrimp stocks of all three species in North Carolina are still considered viable.

6.0 STATUS OF FISHERIES

6.1 COMMERCIAL

6.1.1 History

Between the Civil War and the end of the first decade of the twentieth century, shrimp were caught with dip nets, cast nets and seines. Most were consumed locally but some were used as bait and fertilizer. Distant markets were limited because of little interest in shrimp for food, production capability, few transportation options, and the lack of refrigeration (Maiolo 2004; Maiolo et al. 1980).

Just after the turn of the twentieth century, the South Atlantic and Gulf states became the center of the commercial shrimp fishery in the United States. Interest in the fishery developed rapidly in the Southport, N.C. area. The adoption of the otter trawl completely changed the means of harvesting, which fit nicely with the earlier innovations in power boating at the end of the previous century and market stimulation from the New York area. The creation of canning factories in Southport followed (Maiolo 2004; Maiolo et al. 1980).

The introduction of the otter trawl technology in North Carolina seems to have first involved sampling nets used by the U.S. Bureau of Fisheries in Beaufort in 1912. Even with this new and efficient capture technology, interest in the fishery was not uniform among coastal fishing villages. As late as the 1920s many fishermen still referred to shrimp as “pests” that fouled their nets and many residents, both coastal and inland, did not consider the animals suitable to eat (Maiolo 1981).

In March of 1916, a New Jersey fisherman brought a shrimp trawler to Southport and taught local fishermen how to use the otter trawl in the near shore ocean waters. Interest among fishermen expanded quickly in spite of a sluggish local market. By 1925, over 300 North Carolina fishermen were engaged in the shrimp fishery, mostly in Brunswick County (Maiolo 2004).

The use of otter trawl net technology prompted the development of trawl vessels. The type that was first used in the fishery involved open skiffs from 15 to 20 ft in length that were powered by small gasoline engines. “Decked” trawlers were introduced in the 1920s. Refrigeration (in the form of production of ice for shipment of fishery products), rail and truck transportation, and a close proximity to the eastern markets (as opposed to Florida and the Gulf states) began to make the North Carolina shrimp fishery lucrative. More than two hundred seasonal and part time workers found employment in the Southport packinghouses where many headed shrimp for a nickel per five gallon bucket. The majority of shrimp were shipped to markets in northeastern New York because local markets were still not developed (Maiolo 2004; Maiolo et al. 1980).

The first shrimp trawling in Carteret County occurred around 1930 after local fishermen learned how to harvest the resource from the Southport fishermen. At first, shrimping only occurred in between finfishing seasons. At the same time, a channel net fishery was developing near Harkers Island and in other communities in eastern Carteret County. A series of local customs developed among the fishermen by which the fishery was prosecuted. Many remain in place even today. A similar fishery has recently developed near Snead’s Ferry, but without the same kinds of local customs (Maiolo 2004).

Pamlico County fishermen began landing shrimp caught in pound nets about this time as well, and shrimp trawling caught on in northern Pamlico Sound in the late 1930s when a Louisiana fisherman demonstrated the use of the otter trawl. Shrimping in the northern counties was conducted both nearshore and in the Pamlico Sound. In 1934, the Pamlico Sound was closed to trawling to prevent finfish bycatch. But the following year, the regulation was modified to allow shrimp trawling from 15 August to 1 December (Maiolo et al. 1980; Maiolo 2004).

Like fishermen in other coastal communities in North Carolina who stitched shrimp harvesting into their patterns of annual rounds, fishermen in the northern part of the state pursued shrimping during the summer between oyster dredging and fall finfishing. Just as today, in the southern part of the state, some fishermen followed the shrimp south into South Carolina and Georgia in late summer and into fall (Maiolo 2004; Maiolo et al. 1980).

As the fishery expanded during the 1930s, the construction of larger vessels specifically designed for shrimp trawling expanded. Two of the most common vessels were the “Florida trawler” for ocean trawling in the southern part of the state, and the “Core Sounder” for estuarine trawling. Along with this, masts and booms, or masts and “A” frames, were developed. Additionally, power winches replaced retrieval of the nets by hand. The construction of trawls and doors locally which, up to then had occurred in Florida and Louisiana, began during this period (Maiolo 2004; Maiolo et al 1980).

Difficulties in organizing production and distribution capacity, along with the failure to expand markets into the interior of the state, resulted in inconsistencies in the demand for North Carolina shrimp prior to the outbreak of World War II. Additionally, poor ex-vessel prices hampered development of the state’s fishery. The War created a jolt in the popularity of the shrimp with consumers, because, unlike meat products, seafood was not rationed. There were still problems in the industry. The supply of seafood products, including shrimp decreased because of the war effort. There were fewer fishermen, boats, and equipment, until about 1944 when restrictions on strategic materials were eased. Also during this period trawling was restricted to inside waters because of the threat of German submarine attacks outside of the inlets. One result of this was increased effort in Pamlico Sound (Maiolo 2004).

Quick freezing technology was developed during the war years as well. Shrimp was no longer a perishable product, but a relatively stable commodity that the producer could control by freezing and holding for better prices when the market changed. However, this seems to have had a limited effect on North Carolina harvesting and distribution. Frozen shrimp from other regions had an impact on the markets, but most of North Carolina’s product was still shipped fresh to Northern markets (Maiolo 2004).

When the war concluded, and a recovering economy was redirected toward domestic matters, the fishing industry benefited along with the rest of the nation. There was a boom in construction of diesel-powered, large trawlers, and a considerable increase in shrimping effort. Prices increased dramatically, and North Carolina’s contribution to the Southeast shrimp landings became significant. Vessels were equipped with radar, fathometers, radios, steel cables and drum hoists (Maiolo 2004; Maiolo et al 1980).

Technological advances in the shrimping industry have increased the catching efficiency of larger boats, particularly in Pamlico Sound. In the 1940s and early 1950s, a 45 to 60 foot vessel pulled a single trawl with a headrope length of 60 to 65 feet. Now, with “four-barreled rigs” the same vessel can pull four nets with a combined headrope length of up to 200 feet. Four-barreled rigs allow fishermen to pull two nets from each outrigger. Conventional two-seam otter

trawls are used for the bottom-hugging pink and brown shrimp, while four-seam and tongue trawls with floats on the headrope are used for the white shrimp which have the ability to jump over two-seam trawls when disturbed. In Pamlico Sound, these large vessels stay out four or five days and tow from one to three hours, often working day and night. Smaller vessels make daily trips and employ shorter tow times. In the Core Sound area, the fishery occurs mainly at night, with trips lasting one night. In the southern area, fishing is conducted on a day-trip basis, mostly during daylight hours (Maiolo 2004).

Modern safety and navigation equipment have allowed North Carolina shrimpers to steam longer distances, for longer periods of time to shrimp; and also to engage in a constantly changing variety of harvesting activities other than shrimping throughout the calendar year. This widely recognized diversity of fishing activity occurs all along the Atlantic coastline and in the Gulf of Mexico. It is a continuation of adaptive strategies to changing resource opportunities and regulations as well as technology that dates back before the shrimp industry was born. In this respect, the history and development of harvesting activity in the shrimp industry may be seen as one more addition to the annual cycle of North Carolina's commercial (and to some extent, recreational) fishermen (Maiolo 2004; Orbach and Johnson 1988).

6.1.2 State Landings and Effort

Five different data sources are analyzed to describe the trends in the commercial shrimp industry. The first data source covers the years from 1962 to 1971 and was collected by NMFS. This older data set contains annual summarized landings of shrimp by county of landing, gear type used and water body harvested. The second data source covers the years from 1972 to 1977 and was also collected by NMFS. It also contains summarized landings of shrimp by the same categories as the older data set but it also contains the month of landing. The third data set analyzed covers the years from 1978 to 1993 and was collected under a cooperative statistics program between DMF and NMFS. This file is more detailed than the previous data sets as it contains summarized landings by county of landing, gear type used, water body harvested, month harvested and dealer landed. Another cooperative program between the DMF and NMFS was also started in 1978 that was designed to capture the number of trips and vessels in the shrimp fishery (commonly called the Detailed Shrimp Program). The Detailed Shrimp Program covers the years from 1978 to 1992. The last data source is the NC Trip Ticket Program and covers the years of 1994 to 2010. The data collected in the NC Trip Ticket Program is the most detailed and the most reliable of all the data collection programs as it contains the actual trip level commercial catch for all commercial landings in the state. However, from 1994 to 1998 the species composition of shrimp was not recorded in the NC Trip Ticket Program so analysis of species composition will be from 1978 to 1993 and 1999 to 2010.

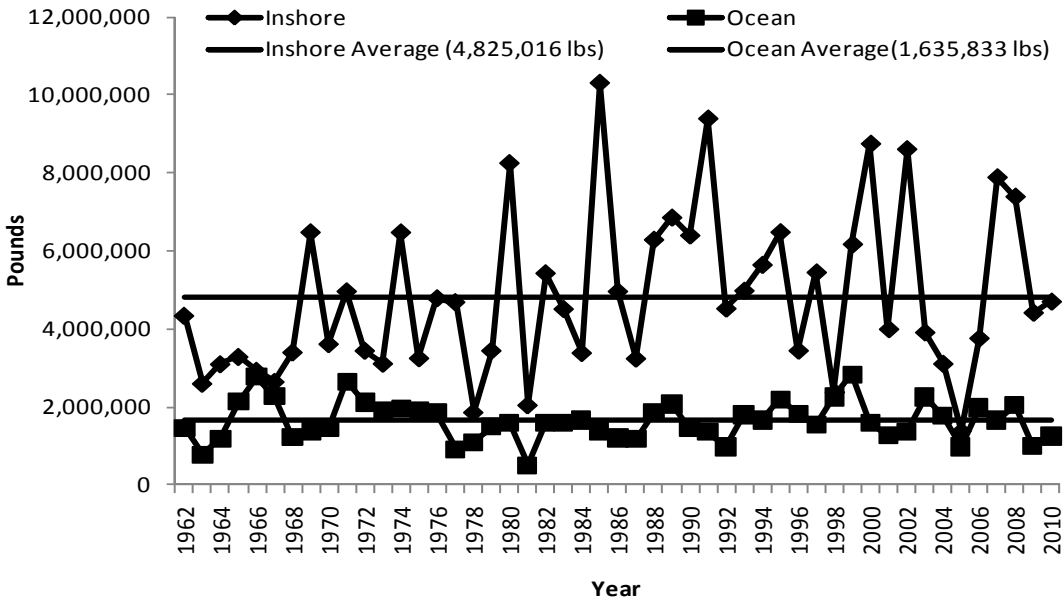


Figure 6.1 Annual shrimp landings (lb) for North Carolina: 1962 – 2010.

Landings in the North Carolina shrimp fishery vary from year to year and are dependent primarily on environmental conditions (Figure 6.1 and Table 6.1). The annual average was 6,460,849 lb for the period 1962-2010; 75% were harvested from inshore waters and 25% from the Atlantic Ocean. This management plan will concentrate on landings from 1978 to 1993 and from the most recent 17 year period, 1994-2010, to evaluate trends in the fishery. The information from the earlier period will be used to illustrate historical trends while that from the later period will demonstrate changes in the fishery, especially species composition. Total landings from 1994 to 2010 have averaged 6,875,737 lb per year (range 2.4-10.3 Mlb) caught on an average of 14,256 annual trips (range 7,770-23,891 trips). The contribution to the landings continues to be 75% for inshore waters and 25% for the Atlantic Ocean (Figure 6.2).

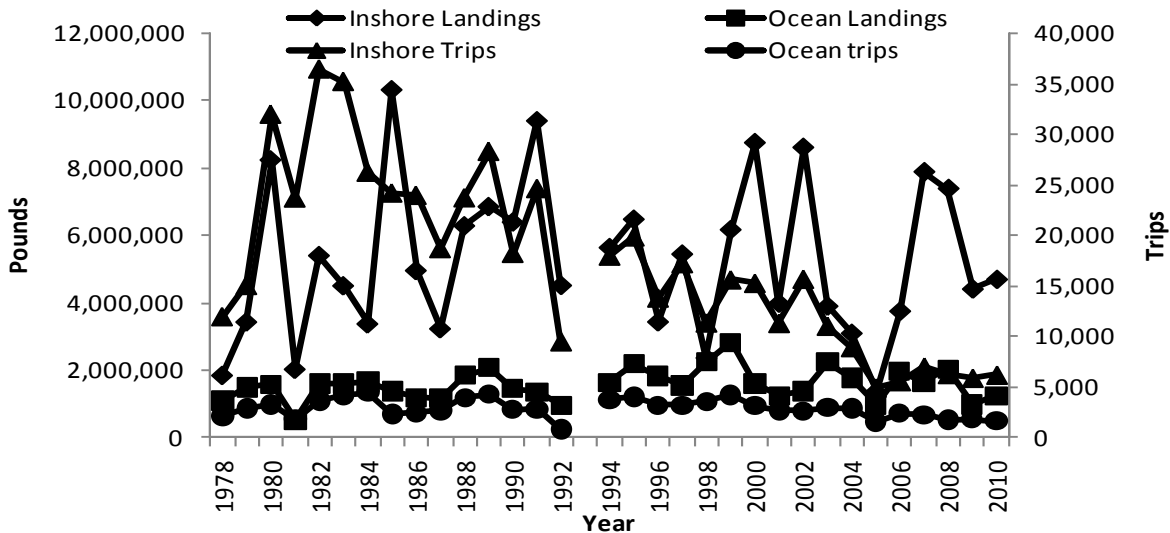


Figure 6.2 Landings (lb) and trips for 1978-2010.

Annual effort for commercial shrimp harvest in North Carolina waterbodies is shown in Table 6.1 from 1978 to 2010 (Detailed Shrimp Program and TT Data). About 70-93% of the shrimp trips occur in estuarine waters, with the remainder in ocean waters, primarily within state territorial seas (<3 mi offshore) off the central and southern coast of North Carolina. Total annual shrimping effort has decreased from a high of 40,000 trips in 1982 to a low of 6,500 trips in 2005 while in 2010 7,800 trips were recorded. Annual shrimping effort has fluctuated with shrimp abundance, but it appears to have gradually declined since 1994 (Figure 6.2). This is due to a number of things including cheaper imported shrimp prices, increasing fuel prices, increased regulations, and fishermen retiring out of the industry.

Regionally, shrimping effort has generally been greatest in Core and Bogue sounds and associated estuaries [1,692-22,998 trips/year (Table 6.1)]. The Southern estuaries account for the second largest number of inside trips per year, ranging from 599 to 7,999 trips/year. In ocean waters, shrimping is highly concentrated in the southern portion of the state [Onslow through Brunswick counties (716-3,645 trips/year)], primarily in the summer (Table 6.1). In contrast, the annual effort in the central district (Carteret County) has ranged from 120 to 1,871 trips per year, and in the northern district (Virginia line through Hyde County) has ranged from 0 to 52 trips per year. Commercial shrimping effort has remained relatively stable over time in the southern ocean waters of the state.

Table 6.1 Annual number of trips reported for shrimp in inside and ocean waters[†], 1978-2010 (Detailed Shrimp Program and Trip Ticket Program).

Year	River and Sounds				Ocean Waters (<3 miles)				Percent Inside	Percent Ocean
	Albemarle	Core/Bogue	Pamlico	Southern	Northern	Central	Southern	Total		
1978	0	8,393	3,015	599	0	571	1,593	14,171	84.73	15.27
1979	0	9,031	2,391	3,665	9	777	2,120	17,993	83.85	16.15
1980	0	17,235	6,924	7,803	13	692	2,568	35,235	90.71	9.29
1981	0	15,854	3,654	4,195	14	383	1,450	25,550	92.77	7.23
1982	37	22,998	5,441	7,943	0	1,128	2,505	40,051	90.93	9.07
1983	0	22,274	4,912	7,999	5	1,236	2,890	39,317	89.49	10.51
1984	0	15,330	3,042	7,873	37	1,197	3,254	30,733	85.40	14.60
1985	0	12,207	8,075	3,911	22	1,246	1,056	26,517	91.24	8.76
1986	0	15,151	5,170	3,648	25	1,197	1,224	26,415	90.74	9.26
1987	0	13,348	2,574	2,797	0	1,322	1,406	21,447	87.28	12.72
1988	0	15,162	4,347	4,216	7	1,677	2,314	27,723	85.58	14.42
1989	0	18,403	4,997	4,901	0	1,871	2,402	32,574	86.88	13.12
1990	0	7,784	4,160	6,302	1	855	1,925	21,027	86.77	13.23
1991	0	12,497	5,277	6,859	0	591	2,266	27,490	89.61	10.39
1992	0	5,042	2,278	2,207	0	145	716	10,388	91.71	8.29
1993										
1994	0	9,494	4,603	3,893	3	332	3,439	21,764	82.66	17.34
1995	0	9,965	5,091	4,814	52	505	3,465	23,892	83.17	16.83
1996	1	7,615	2,817	3,412	19	420	2,802	17,086	81.03	18.97
1997	0	8,189	4,515	4,530	27	319	2,864	20,444	84.30	15.70
1998	0	6,006	1,750	3,630	7	550	3,026	14,969	76.06	23.94

Table 6.1 (continued). Annual number of trips reported for shrimp in inside and ocean waters[†], 1978-2010 (Detailed Shrimp Program and Trip Ticket Program).

Year	River and Sounds				Ocean Waters (<3 miles)				Total	Percent Inside	Percent Ocean
	Albemarle	Core/Bogue	Pamlico	Southern	Northern	Central	Southern				
1999	0	6,933	3,959	4,738	21	525	3,645	19,821	78.86	21.14	
2000	4	5,490	5,385	4,409	16	342	2,795	18,441	82.90	17.10	
2001	7	5,110	3,123	3,095	10	165	2,562	14,072	80.55	19.45	
2002	1	6,579	4,837	4,276	7	231	2,411	18,342	85.56	14.44	
2003	0	5,804	1,721	3,537	2	430	2,563	14,057	78.69	21.31	
2004	0	3,835	2,746	2,377	7	367	2,550	11,882	75.39	24.61	
2005	0	2,555	853	1,565	2	208	1,398	6,581	75.57	24.43	
2006	0	2,386	1,887	1,330	1	334	2,083	8,021	69.85	30.15	
2007	0	2,338	3,129	1,569	12	418	1,824	9,290	75.74	24.26	
2008	0	1,993	2,841	1,471	33	231	1,513	8,082	78.01	21.99	
2009	1	2,064	2,251	1,616	12	186	1,640	7,770	76.34	23.66	
2010	0	1,692	2,105	2,440	13	120	1,491	7,861	79.34	20.66	
Avg	2	9,336	3,746	3,988	12	643	2,243	19,969	83.49	16.51	

† Albemarle Area: Albemarle Sound, Currituck sound, and all tributaries of Albemarle Sound.

Pamlico Area: Pamlico, Croatan, and Roanoke sounds; Pamlico, Bay, Neuse, and Pungo rivers.

Core/Bogue Area: Core and Bogue sounds; Newport, White Oak, and North rivers.

Southern Area: Masonboro, Stump, and Topsail sounds; Cape Fear, New, Shallotte, and Lockwood Folly rivers; IWW.

Northern district ocean waters: Virginia line through Hyde County.

Central district ocean waters: Carteret County.

Southern district ocean waters: Onslow County to the South Carolina line.

A trip may consist of multiple days in Pamlico Sound and the Atlantic Ocean.

6.1.3 Landings by Waterbody

An examination of harvest by waterbody for the most recent twelve year period shows that 56% of the landings are from Pamlico Sound, 24% from the Atlantic Ocean and 6% from Core Sound (Table 6.2). No other water bodies contribute more than 4% to the state's total landings. The totals for some water bodies have been combined for purposes of this discussion. For example, some of the water bodies in the southern part of the state where shrimp trawling is not allowed have been combined into the Inland Waterway; the shrimping activity took place in the Waterway that runs through the waterbody where the landings were recorded. It must also be taken into consideration that species composition was not noted on trip tickets for the years 1994 – 1998.

Table 6.2 Percent contribution of landings (1999 – 2010) by waterbody and species.

Waterbody	Percent brown	Percent pink	Percent white	Percent unclassified	Percent total
Pamlico Sound	70.84	29.22	35.18	60.51	55.95
Ocean	14.85	13.29	39.66	15.82	23.76
Core Sound	5.50	45.47	2.48	11.57	6.19
New River	1.12	4.46	5.55	1.91	2.87
Newport River	1.21	0.48	4.51	1.60	2.39
Neuse River	2.82	2.52	1.01	3.58	2.20
North River-Carteret	0.86	2.91	3.88	0.37	1.99
Other	0.79	0.52	1.28	1.25	0.98
Cape Fear River	0.66	0.46	1.39	0.91	0.93
Inland Waterway	0.04	0.02	2.26	1.12	0.90
White Oak River	0.09	0.03	1.75	0.10	0.68
Bogue Sound	0.40	0.61	0.98	0.14	0.60
Pamlico River	0.60	0.02	0.05	0.62	0.38
Bay River	0.16	0.01	0.01	0.50	0.12
Pungo River	0.06	0.00	0.00	0.00	0.04

6.1.4 Landings by Gear

The vast majority of the shrimp harvest (92%) is taken by otter trawls however, there has been a slight shift in the types of gear used to harvest shrimp in North Carolina in recent years (Figure 6.3). A type of trawl that has gained wide popularity in the central and southern areas since about 1991 is the skimmer trawl. This gear originated in the Gulf Coast states and is very effective at capturing white shrimp. Skimmers are modified wing nets sewn to an aluminum or steel pipe frame. The bottom of each outside pipe has a skid that rides over the bottom. The vessel can work in depths from two to fifteen feet and the tailbags can be hauled in more often without stopping to haul back. This increases the efficiency of the harvest and allows the bycatch to be released more frequently, thus reducing mortality. An increasing number of vessels in Carteret, Onslow, and Pender counties are switching from otter trawls to skimmers as their efficiency on brown shrimp harvest is improved. Skimmer nets account for 3% of the average annual state landings.

Channel nets are stationary nets that fish the surface and middle depths on an outgoing tide. They resemble a trawl anchored and staked to the bottom to keep it open. The nets are set at night on an ebb tide across a channel or slough in the path of seaward-migrating shrimp. The mouth of the net is oriented toward the direction of the oncoming current. The tailbag of the channel net is emptied into a skiff every 15 to 30 minutes. The net is retrieved from the water before the tide changes to prevent it from being turned inside out. The channel net must be set near inlets where the current is strong and where shrimp have concentrated to move out to sea. This activity is concentrated in estuarine waters from Beaufort Inlet to Rich's Inlet. Channel nets account for 5% of the average annual shrimp landings. Although not a significant contributor to shrimp landings, shrimp pound nets have recently been developed and employed in the taking of primarily brown shrimp. Shrimp pound nets are trap nets with a V-shaped lead that directs a shrimp to a funnel connected to a box-shaped pound. One of the leads extends to the shoreline

and the other extends out towards a channel or deeper water. Shrimp enter the nets at night as they migrate. The larger shrimp are trapped in the pound while the smaller ones are allowed to pass through. Interest in the use of shrimp pounds has increased since 2003 and issues raised were addressed in the 2006 FMP.

The cast net is another type of gear used to harvest shrimp. A few pink and brown shrimp are captured around the marshes and shallows during the summer with this circular net weighted around the perimeter that is thrown out over the shrimp. The weighted edges of the cast net sink to the bottom entrapping the shrimp, and they are pulled into the catcher by a line attached to the top of the net. The cast net is most successful on white shrimp in the fall as they school in large concentrations and leave the creeks and tributaries and head for the sounds and, eventually, the ocean. Throwing from boats or bridges over creeks is productive when they are migrating.

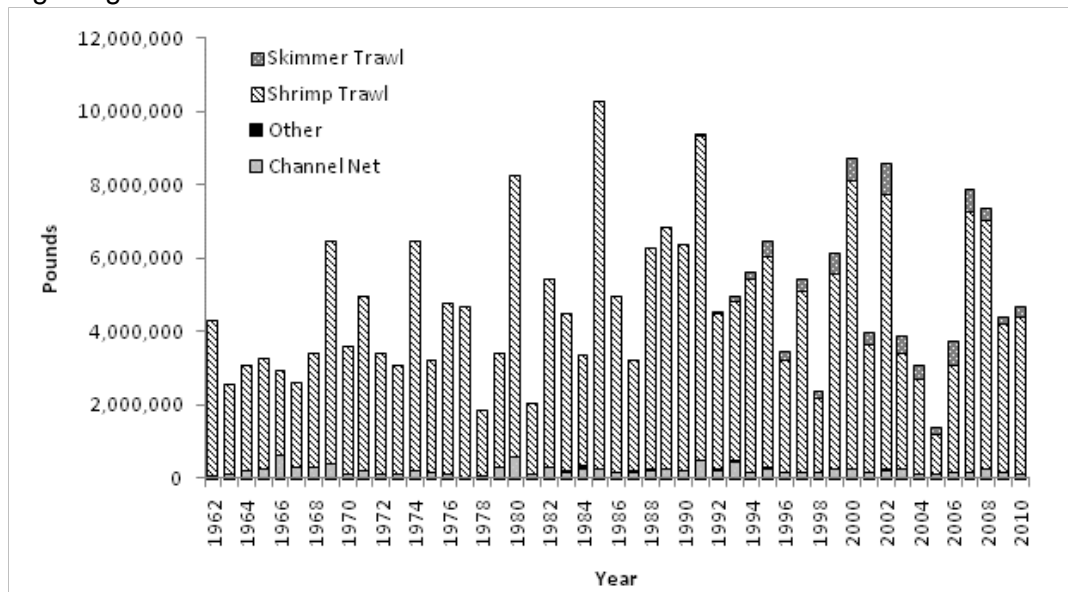


Figure 6.3 Inshore shrimp landings by gear for North Carolina: 1962 – 2010.

6.1.5 Landings by Species

The North Carolina shrimp fishery harvests three species: brown, pink, and white. Data on the species composition of the shrimp catch were collected from 1978 to 1982 through the Detailed Shrimp Program, from 1983 to 1993 through the DMF/NMFS Cooperative Statistics Program and from 1999 to 2010 through the DMF Trip Ticket program. Species composition was not collected from 1994 through 1998 so discussion of the contribution of each species to the total landings will concentrate on the time periods 1978-1993 and 1999-2010. Historically (1978-1993) brown shrimp accounted for 66% of the state total, averaged 4.5 Mlb and annual totals ranged from 1.1 Mlb in 1987 to 10.4 Mlb in 1985 (Figure 6.4). North Carolina brown shrimp commercial landings have averaged 3.8 Mlb since 1999 (Figure 6.5). During this time, landings have fluctuated from a high of 6.5 Mlb in 2000 to a low of 1.5 Mlb in 2005. Environmental factors, principally temperature and salinity, have a major influence on the yearly harvest. Generally, 85% of all brown shrimp landed are caught in estuarine waters with Pamlico Sound, Core Sound, New River, and Neuse River accounting for most of the harvest (Table 6.2). Since 1999, over 96% of all brown shrimp landed are caught by shrimp trawls. Channel nets and skimmer trawls account for the remaining landings.

Pink shrimp have historically (1978-1993) accounted for about 27% of the shrimp landings. North Carolina commercial pink shrimp landings averaged 1.8 Mlb from 1978 to 1993 (Figure 6.4). Environmental factors especially severity of winter temperatures, have a significant influence on the yearly harvest. However, since 1999, pink shrimp landings have averaged only 0.2 Mlb, despite a series of mild winters in the late 1990s and early 2000s. Pink shrimp have accounted for 4% of the state's harvest during the last 12 years (Figure 6.5). The cause of this decrease is not known. The majority of pink shrimp landed are caught in estuarine waters (87%). There are two seasonally distinct fisheries, one from late April through June, and the fall fishery that runs from September through November. Core Sound accounts for 45% of the landings, followed by Pamlico Sound (29%), and the ocean (13%) (Table 6.2). Since 1999, over 87% of all pink shrimp landed are caught by shrimp trawls. Channel nets (11%) and skimmer trawls (2%) account for the remainder.

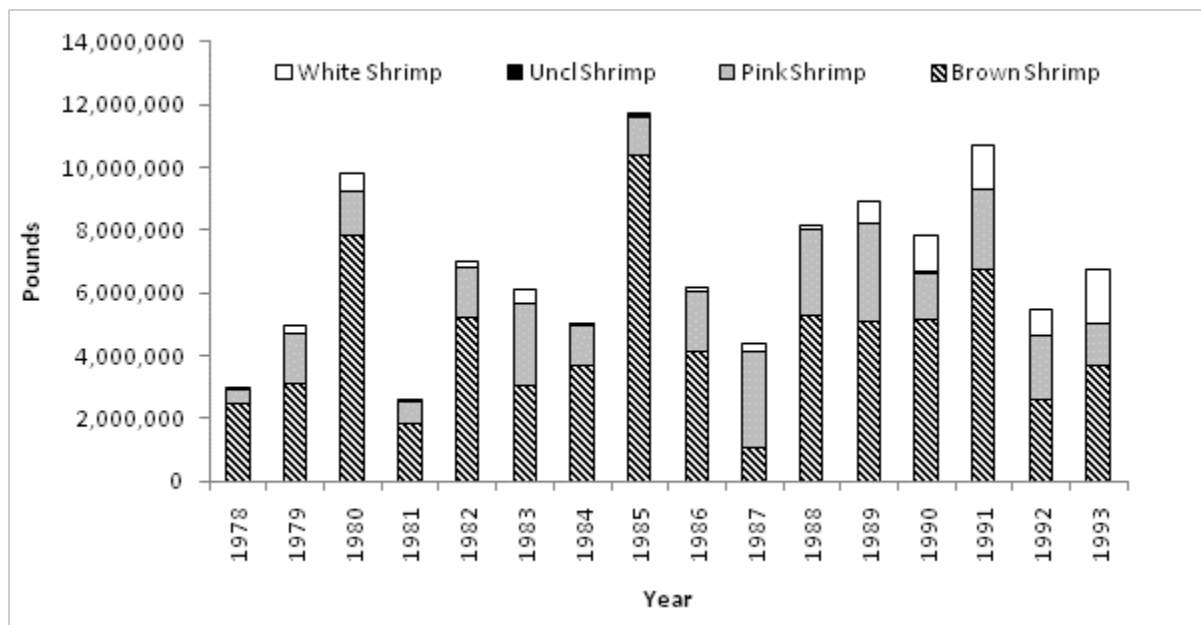


Figure 6.4 North Carolina landings of shrimp by species 1978-1993.

During the period 1978-1993, North Carolina commercial white shrimp landings averaged 0.5 Mlb (Figure 6.4). Landings fluctuated from a high of 1.7 Mlb in 1993 to a low of 11,000 pounds in 1981 (Figure 6.4). The landings increased significantly for the most recent 12 years to an average of 2.5 Mlb that was 36% of the state landings (Figure 6.5). These fluctuations are not unusual for a species so vulnerable to environmental conditions, especially low winter water temperatures. The percentage of the white shrimp catch taken in the ocean is higher (40%) than the other two species, which reflects its greater abundance in the southern part of the state where the majority of the ocean fishery occurs. Since 1999, over 82% of white shrimp landed were caught in shrimp trawls. The other 18% were captured in channel nets (3%) or skimmer trawls (15%). On average, during 1978-1990, 60% of all white shrimp were landed in the southern coastal area (Onslow, Pender, New Hanover and Brunswick counties) and 26% in the central area (Pamlico and Carteret counties), and the remaining 12% were taken in the northern area. Since 1999 the majority of white shrimp have been harvested from the Ocean (40%), Pamlico Sound (35%) and New River (6%); which reflects the effects of a series of mild winters that has allowed white shrimp populations to be abundant in the northern portion of the state (Table 6.4).

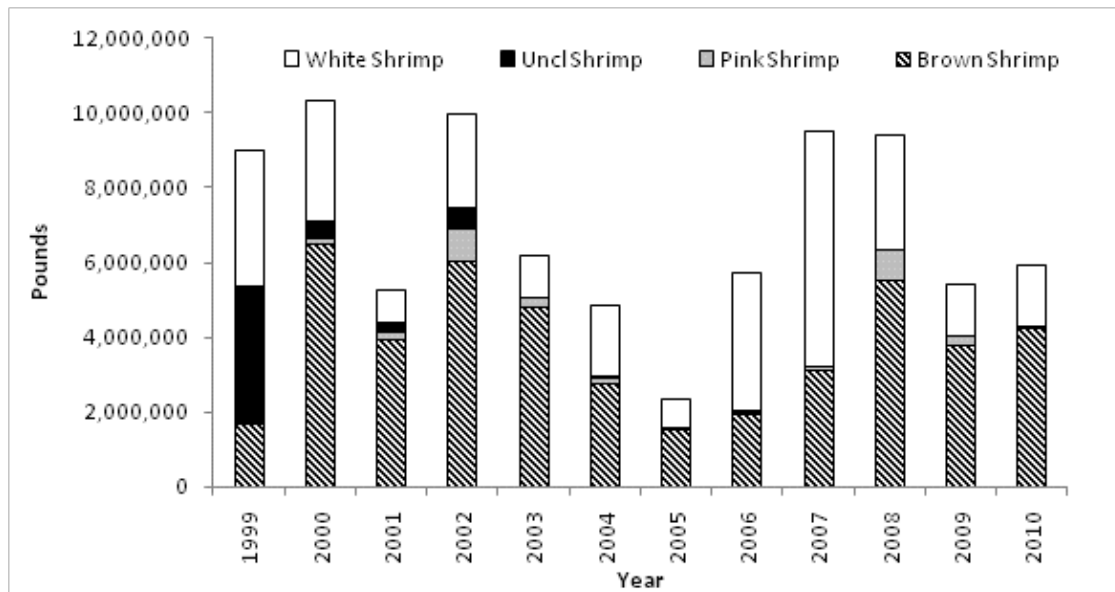


Figure 6.5 North Carolina landings of shrimp by species: 1999 – 2010.

There are two seasonal fisheries for white shrimp in North Carolina. The spring fishery lasts from late April until June and the fall fishery that begins in late August and may last through December. In the spring fishery, trawlers primarily target "roe" (female) white shrimp. The majority of white shrimp landed come from the fall fishery, where it is the target species in the southern coastal area and other areas if they are abundant.

North Carolina's shrimp fishery is unusual in the southeast because all three species are taken here and the majority of the effort, about 83%, is expended in internal waters. While South Carolina, Georgia and Florida allow limited inside shrimping, the majority of their fisheries are conducted in the Atlantic Ocean and white shrimp comprise the most of their harvest (Table 6.3). North Carolina's landings for the period 1999-2010 were 34% of the total for the South Atlantic followed by Florida (25%), Georgia (23%) and South Carolina (19%).

Table 6.3 Shrimp landings in pounds from the South Atlantic, 1999-2010.

Area		Brown Shrimp	Pink Shrimp	White Shrimp	Grand Total
Florida East Coast	1999	1,014,167	1,035,004	3,947,723	5,996,894
	2000	639,573	905,375	2,455,165	4,000,113
	2001	1,221,035	482,736	2,386,053	4,089,824
	2002	1,008,681	615,462	3,316,938	4,941,082
	2003	884,123	209,988	2,098,503	3,192,614
	2004	1,037,684	456,313	3,813,020	5,307,017
	2005	393,985	408,183	3,801,199	4,603,367
	2006	606,855	642,531	3,964,873	5,214,258
	2007	1,284,146	210,949	3,633,139	5,128,234
	2008	641,537	379,926	3,952,565	4,974,028
	2009	701,369	256,923	3,264,738	4,223,029
2010	1,093,991	777,657	4,383,569	6,255,217	
Florida Total		10,527,146	6,381,046	41,017,485	57,925,677

Table 6.3 (continued).

Area		Brown Shrimp	Pink Shrimp	White Shrimp	Grand Total
Georgia	1999	1,352,545	0	5,340,885	6,693,430
	2000	772,932	0	4,599,183	5,372,115
	2001	1,471,975	0	2,789,070	4,261,045
	2002	683,818	0	4,246,202	4,930,020
	2003	1,407,018	0	4,015,844	5,422,862
	2004	568,241	0	4,410,584	4,978,825
	2005	1,421,386	0	3,013,279	4,434,665
	2006	207,816	0	3,467,257	3,675,073
	2007	510,169	0	2,211,691	2,721,860
	2008	378,332	0	2,642,896	3,021,228
	2009	326,382	0	2,594,351	2,920,733
2010	599,068	0	3,869,213	4,468,281	
Georgia Total		9,699,682	0	43,200,455	52,900,137
North Carolina	1999	1,672,959	10,060	3,659,302	5,342,321
	2000	6,489,495	161,422	3,214,862	9,865,779
	2001	3,923,540	211,858	863,153	4,998,551
	2002	6,029,219	879,894	2,514,342	9,423,455
	2003	4,828,513	219,010	1,100,128	6,147,651
	2004	2,749,009	143,954	1,923,460	4,816,423
	2005	1,523,028	43,489	780,169	2,346,686
	2006	1,944,380	65,232	3,682,529	5,692,141
	2007	3,110,266	84,168	6,339,883	9,534,317
	2008	5,502,793	830,488	3,076,444	9,409,725
	2009	3,804,694	250,213	1,347,561	5,402,468
2010	4,233,181	52,657	1,658,681	5,944,519	
North Carolina Total		45,811,078	2,952,446	30,160,513	78,924,037
South Carolina	1999	1,253,824	9,836	3,858,202	5,121,862
	2000	887,302	28,431	3,001,515	3,917,248
	2001	1,445,911	1,111	1,360,590	2,807,612
	2002	919,621	508	2,423,729	3,343,858
	2003	1,469,998	66	2,449,051	3,919,115
	2004	1,139,895	0	4,485,856	5,625,751
	2005	1,213,979	0	2,742,780	3,956,759
	2006	368,326	0	3,319,573	3,687,899
	2007	845,687	0	1,970,594	2,816,281
	2008	688,416	0	2,478,418	3,166,834
	2009	375,719	0	2,343,203	2,718,922
2010	968,916	0	2,988,253	3,957,169	
South Carolina Total		11,577,594	39,952	33,421,764	45,039,310
Grand Total		77,615,500	9,373,444	147,800,217	234,789,161

6.1.2.5 Regional Summary

The shrimp fishery in the northern portion of the state is conducted in Pamlico, Croatan, and Roanoke sounds and Pamlico, Pungo, Bay and Neuse rivers. The otter trawl is the predominant gear used in this portion of the state. Commercial activity occurs in all waters, while recreational activity usually occurs in the rivers and nearshore areas of the sounds.

The shrimp fishery in the central coastal area of the state occurs in Neuse River, Core Sound, North River, Newport River, Bogue Sound, and White Oak River. A variety of methods are used to catch shrimp including trawls, skimmers, channel nets, shrimp pounds, and cast nets. Trawls are used on all three species in both the estuary and the ocean with two seam trawls used for brown and pink shrimp and four seam and tongue trawls for white shrimp, which tend to swim higher in the water column and have the ability to jump to the surface when disturbed. Most trawling in the central portion of the state is conducted at night. Channel nets are popular around Harkers Island in the Straits and North River while skimmer trawling is very popular in Newport River.

In the southern portion of the state, the fishery is characterized by a large number of small boats fishing internal waters (primarily the Intracoastal Waterway, New and Cape Fear rivers) and larger craft fishing the Atlantic Ocean primarily off New River, Carolina Beach, and Brunswick County. Many of the small boats are fished by individuals who shrimp part-time or for personal consumption. Use of gears other than trawls has increased primarily in the area from New River to Rich's Inlet. Channel, float, and butterfly nets make use of tidal currents to push shrimp into the nets and offer the advantages of less fuel consumption and less bycatch than traditional shrimp trawls. Channel nets are fished extensively in the areas around New River and Topsail inlets. To shrimp with a "float net", fishermen attach large floats to the doors and top lines of trawls to make the net fish up in the water column and are pulled slowly forward to harvest shrimp that are migrating to the inlets at night. Butterfly nets use this same harvest strategy but are attached to a metal frame and are held stationary in the water column to capture shrimp as the current carries them into the net. Skimmer trawls have become more popular around New River and Topsail Sound. These alternative gears are employed very little in areas south of Rich's Inlet, however tidal conditions seem favorable for their use. Cast nets and seines are also used to harvest shrimp primarily for recreational uses, personal consumption, and to provide live shrimp for the commercial bait fishery.

6.2 RECREATIONAL FISHERY

Shrimp are harvested recreationally throughout the state by otter trawls, skimmer trawls, seines, cast nets, shrimp pots and shrimp pounds. As of July 1, 1999, anyone wishing to harvest shrimp recreationally with commercial gear is required to purchase a RCGL. RCGL holders are restricted to using otter and skimmer trawls with a headrope length of up to 26 feet, a 100 foot seine, five shrimp pots and one shrimp pound. Seines measuring less than 30 feet long and cast nets are exempt from this license. Cast nets are the only gear allowed in areas closed to other commercial methods of shrimping with a limit of 100 shrimp per person. This limit will change to two quarts beginning June 2013 due to concerns of law enforcement officer safety while enforcing this rule.

6.2.1 Recreational Commercial Gear License (RCGL) History

On August 14, 1997, the Fisheries Reform Act (FRA) was signed into law. One aspect of this law was the creation of the RCGL. According to the Fisheries Moratorium Steering Committee (MSC), a group that provided the recommendations for the FRA, the purpose of creating this license was to: (1) allow individuals and families who have traditionally accessed the State's public trust fishery with commercial gear to supply themselves with fresh seafood; (2) limit the effort that may be expended by this class of fishermen both individually and as a group; and (3) implement the principle that all persons who harvest state public trust resources pay for that privilege by investing in coastal fisheries conservation and management (Moratorium Steering Committee, 1996). DMF began selling this license July 1, 1999.

The MSC also recommended that the MFC be authorized to establish specific gear limits with "standing advisory committees" and those limits could vary by region. The MFC should be required to re-examine and revise the gear limitations on a recurring basis. The MSC further recommended that the RCGL be restricted to the use of the following gears and amounts during the period final gear limitation rules are being developed by the MFC: one – 100 yards of gill net; 2) five crab/fish pots and 3) a single trawl with a headrope less than or equal to 26 feet. These limits were meant to serve as the starting point for the MFC rule development on RCGL gear and were the result of extensive public input and deliberation by the MSC.

The FRA provided that the MFC: 1) shall adopt rules authorizing the use of a limited amount of commercial fishing equipment or gear for recreational fishing under a RCGL (G.S.113-173(c)); 2) may authorize the limited use of commercial gear on a uniform basis in all coastal fishing waters or may vary the limited use of commercial gear within specified areas of the coastal fishing waters; and 3) shall periodically evaluate and revise the authorized use of commercial gear for recreational fishing.

RCGL allow recreational fishermen to use limited amounts of commercial gear to harvest seafood for their personal consumption. Seafood harvested under this license cannot be sold. RCGL holders are limited to the same bag and size limits as CRFL holders. The 2006 Shrimp FMP added two new allowable RCGL gears, one shrimp pound and a 26 foot skimmer trawl. The FMP also limited all recreational harvesters, including RCGL holders to 48 quarts of head-on (32 quarts of head-off) shrimp per day, greatly reducing the harvest in some areas. If there are two valid license holders on board a vessel, then the shrimp possession limit may be doubled. The MFC also passed a rule allowing mechanical retrieval gear as long as a TED was properly installed in the trawl; prior to the FMP shrimp trawls could only be retrieved by hand.

6.2.2 RCGL Survey

Many of the species taken by recreational users of commercial gear are included in fisheries management plans. Until 2002, the influence that RCGL holders may have on these species was unknown. Two survey strategies were used to collect information from RCGL holders; a socioeconomic survey, conducted in 2001, 2004, and 2007, and catch and effort surveys conducted monthly from 2002 through 2008. Both of these surveys were terminated in 2008 due to budget constraints. While the harvest of RCGL holders has been shown to be minimal, the lack of current data could foster further debate over the impact of the use of commercial gear by recreational fishermen. Findings from these surveys are summarized by regions, using the DMF Fisheries Management District boundaries (Figure 6.6).

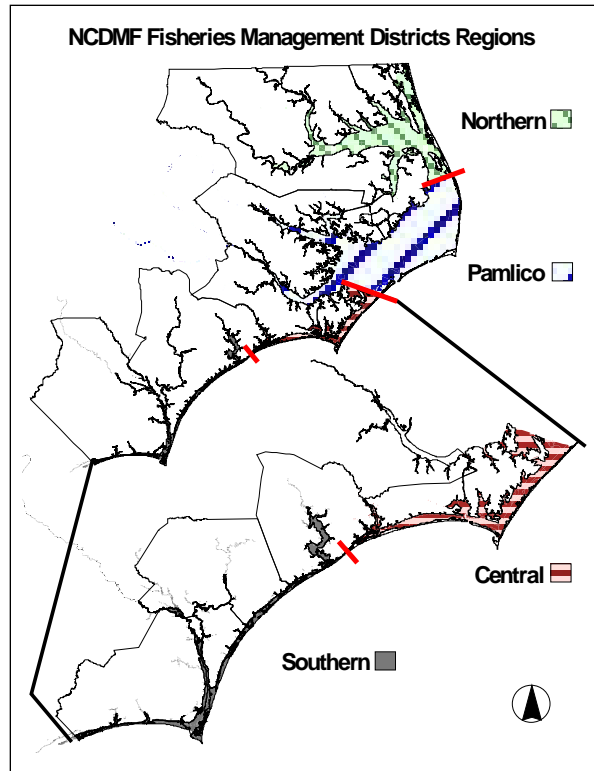


Figure 6.6 Regions used to summarize findings from the RCGL surveys.

6.2.3 RCGL Survey Methodology

Catch and effort survey questionnaires were designed to determine the number of trips taken and type and quantities of gear used during the month of the survey. Participants were also requested to provide estimates for the numbers and pounds of each species caught and retained as well as the number of each species discarded.

Participants for the survey were randomly selected using two different rates of sampling. A 30.0% coverage rate by county of residence for the period May through December was used. This is the period when the bulk of RCGL holders are actively fishing and is sufficient for the gears used and majority of the species targeted.

To estimate the total number of trips taken by all RCGL holders, the monthly survey data were extrapolated for each monthly sample period and gear combination by:

- Calculating the level of participation by dividing the total number of participants actively using a specific gear by the total number of returned questionnaires,
- Calculating the mean number of trips taken by the participants indicating actively using a specific gear, and
- The effort estimate was the product of the mean number of trips, level of participation, and the total number of RCGL holders for the given sample period.

Determinations of the estimated catch for each species were also calculated for each sample period and gear level by:

- Summing the total catch by species, sample period, and gear combination,
- Summing the total number of trips taken by sample period and gear combination,
- Dividing total catch by the total number of trips to determine the mean catch for each species for every sample period and gear combination, and
- The catch estimate was the product of the mean catch and the estimated effort.

Participants were also asked to specify the average amount of gear used. Quantities were categorized into ranges of values for head rope length of trawls, and length of seine. RCGL holder use of shrimp pots, shrimp pounds, and seines is negligible and only information gathered from RCGL holders that use otter trawls is presented.

6.2.4 RCGL Survey Results

With the exception of 2002, the number of RCGLs sold on a fiscal basis has declined each year from 2002 through 2010 (Table 6.4); with 24% overall decline from the first to last year in this period. The largest single year decline occurred in 2001 (8%) followed by 2006 (5%). In 2009 and 2010 there was an average of 3.1% increase in sales. This increase is probably due to the downward trend of the economy, thus, increasing the need of seafood for personal consumption. Twenty-five counties consistently comprise approximately 85% of the total number of RCGLs purchased each year. Southern counties such as Onslow, Pender, New Hanover, and Brunswick consistently rank in the top ten counties each year.

Table 6.4 Number of fiscal license sales of Recreational Commercial Gear Licenses, 2002 through 2010 (fiscal year, July 1 through June 30).

Fiscal Year	Number of RCGLs Sold	Percent Change from Previous Sales Year
2000	6,740	
2001	6,202	-8.0%
2002	6,300	1.6%
2003	6,157	-2.3%
2004	5,868	-4.7%
2005	5,653	-3.7%
2006	5,368	-5.0%
2007	5,134	-4.4%
2008	5,113	-0.4%
2009	5,268	2.9%
2010	5,451	3.3%

Typical RCGL holders were married Caucasian males with an average age of 56. Findings from license sales statistics and the three socioeconomic surveys conducted in 2001, 2004, and 2007 indicated that coastal counties, in particular, southern coastal counties, substantially contributed to the overall number of RCGL holders (Figure 6.7).

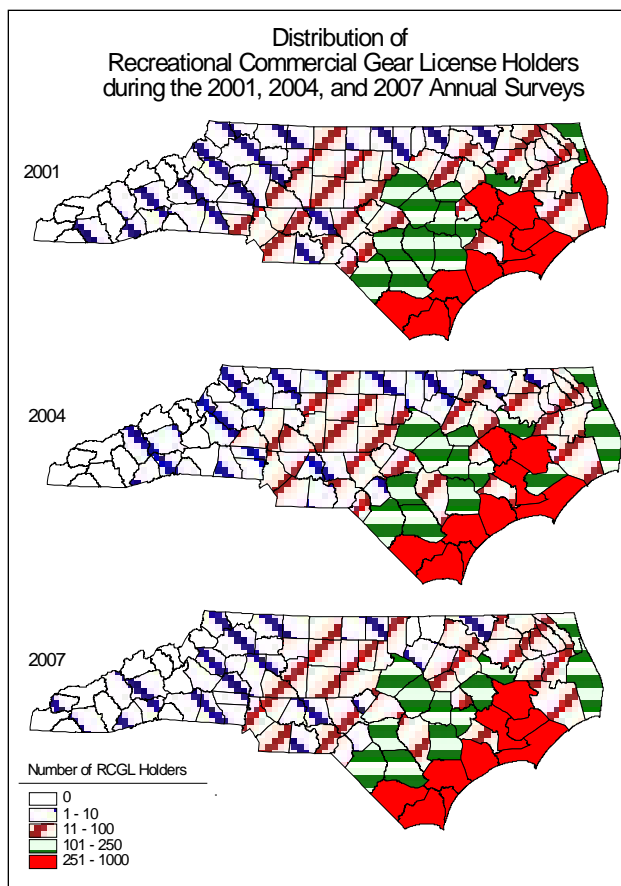


Figure 6.7 Distribution of RCGL residents.

The top three gears utilized by RCGL holders fishing in all regions were crab pot, small mesh gill net, and large mesh gill net. Shrimp trawls were the fourth most common gear utilized in the Pamlico, Southern, and Central Regions while fish pots were the fourth most common gear utilized in the Northern Region. On average the highest number of trips using shrimp trawls from 2002 to 2008 occurred in the Pamlico region, followed by the southern region, the central region, and the northern region (Table 6.5). In the Pamlico region, the number of trips ranged from 1,127 (2005) to 2,384 (2002), averaging 1,642 per year from 2002 to 2008. In the southern region, the number of trips ranged from 355 (2007) to 1,123 (2002), averaging 586 trips per year. An average of 413 trips a year were made in the central region, ranging from 132 (2008) to 1,070 (2002). In the Northern region, the number of trips ranged from 50 (2006) to 911 (2004). Overall, the highest number of trips made by RCGL using shrimp trawls was observed in 2002; the lowest was observed in 2007.

RCGL holders harvested an average of 52,352 pound of shrimp a year from 2002 to 2008 (Figure 6.6). The highest landings occurred in 2002 (101,766 lb), followed by 2008 (54,359 lb) and 2003 (50,961 lb). RCGL holders harvested an average of 16.8 pounds of shrimp per trip from 2002 to 2008 (Figure 6.6). The highest pounds of shrimp per trip was observed in 2009 (22.3 lb/trip), followed by 2006 (20.3 lb/trip) and 2002 (19.1 lb/trip).

Table 6.5 Number of trips by shrimp trawl by region, 2002 through 2008.

Year	Region				Total
	Southern	Central	Pamlico	Northern	
2002	1,123	1,070	2,384	742	5,319
2003	711	246	1,448	348	2,753
2004	392	318	2,122	911	3,743
2005	553	365	1,127	387	2,432
2006	471	464	1,441	50	2,426
2007	355	295	1,510	69	2,229
2008	500	132	1,464	337	2,433
Mean	586	413	1,642	406	3,048

Table 6.6 Harvest (lb) and pounds per trip of shrimp by RCGL gear from 2002 through 2008.

Year	Pounds	Pounds/trip
2002	101,766	19.1
2003	50,961	18.5
2004	43,698	9.3
2005	32,542	13.4
2006	49,362	20.3
2007	33,778	15.2
2008	54,359	22.3
Mean	52,352	16.8

6.2.5 Regional RCGL Characterization for Shrimp Trawls

Southern Region

The top species harvested by RCGL shrimp trawls in the Southern Region from 2002 to 2008 were shrimp, blue crab, flounder, and spot (Table 6.7). On average, shrimp made up 88.0% of the harvest, blue crab 5.2%, flounder 2.9% and spot 2.8%. Shrimp harvests ranged from 2,400 pounds (2007) to 25,642 pounds (2002), averaging 11,900 pounds annually. Overall, 22.7% of the total RCGL harvest was landed by shrimp trawls in the Southern Region.

Table 6.7 Top four species harvested (lb) by RCGL shrimp trawls in the Southern Region, 2002-2008.

Species	2002	2003	2004	2005	2006	2007	2008	Average
Shrimp	25,642	14,897	5,810	9,585	20,041	2,400	4,928	11,900
Blue crab	1,271	1,363	826	640	221	339	268	704
Flounder	603	383	365	1,151	121	15	143	397
Spot	0	29	667	65	789	256	839	378
Other*	58	9	80	15	704	0	36	129
Total	27,574	16,681	7,748	11,456	21,876	3,010	6,214	13,508

*Other includes: Atlantic menhaden, croaker, pigfish, pinfish, sharks and rays, sheepshead, shellfish (misc.), Spanish mackerel, weakfish

Central Region

The top five species harvested by shrimp trawls in the Central Region from 2002 to 2008 were shrimp, blue crab, flounder, croaker, and pigfish (Table 6.8). On average, shrimp made up 95.5% of the harvest, blue crab 3.5%, flounder 0.6%, croaker 0.3% and pigfish <0.1%. Shrimp harvests ranged from 2,175 pounds (2008) to 19,095 pounds (2002), averaging 7,501 pounds annually. Overall, 14.3% of the total RCGL harvest was landed by shrimp trawls in the Central Region.

Table 6.8 Top species harvested (lb) by RCGL shrimp trawls in the Central Region, 2002-2008.

Species	2002	2003	2004	2005	2006	2007	2008	Average
Shrimp	19,095	4,100	6,966	7,213	9,280	3,677	2,175	7,501
Blue crab	927	189	0	581	200	7	15	274
Flounder	246	41	0	0	51	14	0	50
Croaker	0	0	0	78	61	0	0	20
Pigfish	0	0	0	0	25	21	0	7
Total	20,268	4,330	6,966	7,888	9,617	3,719	2,190	7,852

Pamlico Region

The top five species harvested by shrimp trawl in the Pamlico Region were shrimp, blue crab, flounder, spot, and croaker (Table 6.9). On average, shrimp made up 82.1% of the harvest, blue crab 16.8%, flounder 0.2%, spot 0.2%, croaker <0.1%. Shrimp harvests ranged from 10,764 pounds (2005) to 48,982 pounds (2002), averaging 27,739 pounds annually. Overall, 53.0% of the total RCGL harvest was landed by shrimp trawls in the Pamlico Region; the highest among the four regions.

Table 6.9 Top species harvested (lb) by RCGL shrimp trawls in the Pamlico Region, 2002-2008.

Species	2002	2003	2004	2005	2006	2007	2008	Average
Shrimp	48,983	24,622	19,963	10,764	19,536	26,574	43,734	27,739
Blue crab	11,815	6,792	10,808	4,195	3,268	800	1,844	5,646
Flounder	283	17	18	0	110	68	0	71
Spot	0	0	48	0	137	170	0	51
Croaker	0	0	20	0	0	136	0	22
Other*	0	0	36	0	0	67	21	18
Total	61,081	31,431	30,893	14,959	23,051	27,815	45,599	33,547

*Other includes: Atlantic menhaden, pigfish, pinfish, sharks and rays, sheepshead, shellfish (misc.), Spanish mackerel, weakfish

Northern Region

The top species harvested by shrimp trawl in the Northern Region were shrimp, blue crab, croaker, flounder, and catfish (Table 6.10). On average, shrimp made up 72.8% of the harvest, blue crab 12.1%, croaker 7.9%, flounder 6.4% and catfish 0.7%. Shrimp harvests ranged from 57 pounds (2007) to 9,374 pounds (2004), averaging 3,914 pounds annually. Overall, 7.5% of the total RCGL harvest was landed by shrimp trawls in the Northern Region.

Table 6.10 Top species harvested (lb) by RCGL shrimp trawl in the Northern Region, 2002-2008.

Species	2002	2003	2004	2005	2006	2007	2008	Average
Shrimp	7,875	5,172	9,374	1,952	118	57	2,852	3,914
Blue crab	1,404	1,112	488	1,227	2	251	66	650
Croaker	0	78	2,815	65	0	0	0	423
Flounder	433	134	1,500	41	0	316	0	346
Catfish	0	0	276	0	0	0	0	39
Total	9,712	6,496	14,453	3,285	120	624	2,918	5,373

6.2.6 Contribution of RCGL Harvest compared to Other Fisheries

When compared to North Carolina's commercial harvest statistics from the NCTTP and recreational angling harvest estimates from the Marine Recreational Information Program (MRIP), the average yearly RCGL harvest has been shown to contribute only minimally to the overall harvest of those species encountered using RCGL gears (Table 6.11). From 2002 thru 2008 there was an average 52,352 pounds of shrimp that were landed by RCGL holders using shrimp trawls. In comparison, the total percent of RCGL shrimp landings account for 0.87% of the total commercial shrimp harvest.

The MRIP is a survey of marine and estuarine finfish species. The vast majority of interviews conducted each year are from angling trips; therefore species such as menhaden, striped mullet, and anadromous species are not encountered frequently enough to provide precise estimates.

Resource or conflict issues related to the RCGL since its implementation have been minimal. There have been instances, as with all gear, where the user was not acting responsibly. Reports to the DMF have ranged from shrimpers harvesting over the legal limit, improperly marked gear, and the illegal sale of RCGL harvested shrimp.

Table 6.11 Contribution in percent (pounds) of RCGL harvest to the overall harvest of finfish and shellfish based on the average yearly harvest from each sector during the period 2002 through 2008.

	Recreational Angling Harvest (lb) MRIP ¹	RCGL Harvest (lb) RCGL Surveys	Commercial Harvest (lb) NCTTP	Percent contribution from RCGL Harvest
Crustacean and Shellfish Species				
Shrimp		60,334	6,868,230	0.87
Blue Crab		116,797	31,392,856	0.37
All Shellfish		169,445	40,294,392	0.42
Finfish Species				
Bluefish	1,081,016	17,022	2,778,336	0.44
Catfish		6,864	405,198	1.67
Croaker, Atlantic	194,940	14,534	10,286,338	0.14
Drum, Black	313,684	6,101	189,932	1.2
Drum, Red	207,967	7,522	142,492	2.1
Flounder	535,996	65,059	6,086,025	0.97
Herring, River		10,873	132,193	7.6
Mackerel, Spanish	544,071	3,611	490,265	0.35
Menhaden, Atlantic		5,959	26,404,767	0.02
Mullet, Striped		41,197	1,788,300	2.25
Perch, White		15,531	272,052	5.4
Pigfish	51,777	1,263	36,327	1.41
Pinfish	121,754	268	43,224	0.16
Seatrout, Spotted	612,409	13,207	229,927	1.54
Shad, American		14,623	247,917	5.57
Shad, Hickory		12,053	91,260	11.67
Sheepshead	326,030	1,298	67,130	0.33
Spot	1,397,217	203,535	1,605,764	6.35
Striped bass	1,908,784	5,225	610,673	0.21
Weakfish	154,301	602	641,914	0.08
All finfish	21,656,437	453,065	62,021,830	0.54

6.3 SHRIMP TRAWL BYCATCH

Over the last two decades, bycatch has remained an important and controversial topic in fisheries management and marine conservation both in the United States and around the world (Alverson et al. 1994; Alverson and Hughes 1996; Crowder and Murawski 1998; Diamond 2003; Kelleher 2005; Davies et al. 2009). Interest in bycatch has shifted from its potential commercial

use to concerns about impacts on finfish populations, biodiversity, and ecosystem trophic structure (Murray et al. 1992; Hall et al. 2000; Davies et al. 2009). In spite of increased public awareness, greater management scrutiny, and significant research efforts, many basic issues remain unresolved. Only recently has the term bycatch been defined in any standard manner, and important information on the magnitude of bycatch is severely lacking for many fisheries. Given this situation, it is not surprising that little is known of the impacts of bycatch on specific fisheries, fish populations, and marine communities. Although more information is needed to fully assess the effect of bycatch on fish populations and the ecosystem, continued concern and public policy dictates that bycatch be either eliminated or reduced to insignificant levels (Crowder and Murawski 1998). As perhaps the prime example of the new policy positions, the re-authorized Magnuson-Stevens Fishery Conservation and Management Act (MSFCMA) contains a National Standard (#9) requiring bycatch minimization (USDOC 1996). National Standard 9 states: "Conservation and management measures shall, to the extent practicable, (A) minimize bycatch and (B) to the extent bycatch cannot be avoided, minimize the mortality of such bycatch." Additionally, in 1991 the MFC adopted a policy directing the DMF to establish the goal of reducing bycatch losses to the absolute minimum and to consciously incorporate that goal into all of its, management considerations (Murray et al. 1991).

Bycatch is defined by the Atlantic States Marine Fisheries Commission (ASMFC) as "the portion of a catch taken incidentally to the targeted catch because of non-selectivity of the fishing gear to either species or size differences" (ASMFC 1994). In the MSFCMA, bycatch is defined as "fish which are harvested in a fishery, but which are not sold or kept for personal use" (USDOC 1996). Bycatch can be divided into two components: incidental catch and discarded catch. Incidental catch refers to retained catch of non-targeted species. Discarded catch is that portion of the catch returned to the sea as a result of economic, legal, or personal considerations. Differences in market prices for a given size-class of species or limited storage space can also lead to "high grading", where less valuable species and size classes are discarded to make space for more valuable fish (Bellido et al. 2011). The biological significance of bycatch can be judged from a number of different perspectives, including those of the populations (e.g., of a particular species), of the fishery or fisheries that target or otherwise encounter the species, and of the general biological community (Murawski 1995).

During the late 1980s the DMF initiated gear testing to reduce bycatch in the shrimp trawl fishery (Pearce et al. 1988; Holland 1988). Due to growing concern over bycatch in shrimp trawl fisheries the MSFCMA was amended in 1990 to include bycatch research. Congress mandated that the US Secretary of Commerce conduct a three year research program to assess the impact of the incidental harvest by the shrimp trawl fishery on fishery resources in the South Atlantic and the Gulf of Mexico areas. The National Marine Fisheries Service (NMFS), along with the Gulf and South Atlantic Fisheries Development Foundation (GSAFDF), began a cooperative bycatch research program to: (1) update and expand bycatch estimates temporally and spatially; (2) identify, develop and evaluate gear options for reducing bycatch; (3) develop an information transfer and education program on bycatch; and (4) develop and operate a standardized data management system for centralized dissemination and access (NMFS 1995). Starting in 1992, observers were placed aboard cooperating vessels to characterize bycatch and to test BRDs during normal commercial shrimp trawling.

While it is becoming increasingly apparent to scientists, natural resource managers, and much of the general public that bycatch is an important issue that must be addressed, characterizing the nature and extent of bycatch has proven extremely difficult. These difficulties are generally attributed to inadequate monitoring of many pertinent characteristics, including actual bycatch levels, effort of the directed fishery, distribution of the bycatch species, and the mortality rate of

the discarded species. The problem is exacerbated by the patchy distribution of effort and juvenile finfish in both time and space. The amount of bycatch in a particular trip is usually skewed, with many tows having some bycatch and fewer tows with high bycatch. Additionally, available effort data are often inadequate. Although research indicates that tow duration is often a significant factor when estimating bycatch losses, the DMF and most other agencies typically record effort data by trip without any accompanying information on tow duration or the number of tows made during a trip. Mortality of bycatch captured in trawls varies considerably, not only by species, but also in response to factors such as water temperature, tow time, fishing location, time of year, and gear configuration.

The lack of reliable discard estimates has not stopped researchers from investigating assessment impacts, but it has prevented increases in precision. Most assessments address the range of bycatch estimates through sensitivity analyses by comparing basic assessment results over the range of bycatch estimates and assumptions. If none of the results seem plausible, the assessment may proceed without the bycatch estimates included but with the caveat that results may be biased or contain additional uncertainties due to unknown levels of missing catch. However, the omission of discard data may result in an underestimation of fishing mortality and can lead to a biased assessment (Bellido et al. 2011).

6.3.1 History of Bycatch Management in North Carolina

Shrimp trawling in North Carolina began in the southern coastal area in the mid-1900s and by 1925 there were 300 fishermen participating in the shrimp trawl fishery. By the 1930s, trawling had spread into Core Sound and Pamlico Sound with the center of the industry in Carteret County. Concerns of bycatch began to be raised in the 1950s after experiencing serious declines in the catch of commercial fish in North Carolina waters with attention being focus on the shrimp fishery in Pamlico Sound.

In 1951 the ASMFC published a report on bycatch from trawling and its ultimate effect on abundance and weight of fish when they reached commercial size and what its impacts were on fishing mortality on top of natural mortality. Findings at that time were there was doubt of significant effects because finfish landings varied greatly and species such as spot, croaker and weakfish experience high natural mortality. ASMFC recommended additional studies on natural mortality and other causes of landing fluctuations.

During the 1960s and early 1970s, there was a primary concern of bycatch from directed ocean finfish trawling for bait and pet food. Rules were established by the MFC to prohibit directed scrap fishing. Nursery area designation also began during this time. The Albemarle Sound was closed to trawling in 1987 due to conflicts between crab potters and trawlers and in 1988 a subgroup of the Tar-Pamlico River Foundation called for the elimination of trawling because of bycatch and habitat concerns. By 1993, the MFC requested that the division prepare an issue paper on estuarine trawling. This paper was a comprehensive report on the knowledge of the issues at the time and addressed bycatch, overfishing, habitat and water quality concerns as well as conflict and competition. The division proposed a 50 ft headrope limit for a single trawl and 70 ft total headrope limit in all internal waters except Pamlico Sound. In Pamlico Sound, a 160 ft headrope limit with a two year phase in was proposed. Resulting rules in 1994 were the prohibition of trawling in the Outer Banks sea grass beds, the elimination of weekend trawling, and special secondary nursery areas could be opened by proclamation only from August 16 through May 14.

In 1997, a proposed net ban bill was introduced in the North Carolina General Assembly which proposed banning inside trawling and all net fishing with the exception of cast nets, dip nets and seines less than 12 ft long. It also proposed a buy-back program. However, a 1998 amendment to the 1997 FRA directed the Joint Legislative Commission on Seafood and Aquaculture (JLCSA) to study the biological, habitat, and socioeconomic impacts of the use of trawl nets in the sounds, river and estuaries.

In the meantime, the MFC Inland AC requested that the division examine estuarine trawling and determine the possibility of banning shrimp and crab trawling. Also, a 1999 petition was sent to the MFC and the General Assembly along with a letter requesting the management of estuarine trawling go through the FMP process. This all culminated into a 1999 division report on trawling and its effects on bycatch and habitat and again summarized the current knowledge of the time.

The JLCSA requested an analysis of research and information needs to address bycatch and habitat issues. Academia and division staff summarized current knowledge on trawling impacts and data needs necessary to make decisions. These included an accurate depiction of area and frequency of trawling by season and type of habitat involved, and the effect so bycatch on subsequent population yields of species. Other important data include rate of recovery of trawled bottom based on habitat type and trawl intensity and socioeconomic consequence of various alternative management options. An eight year study was presented to the JLCSA with budget needs of one to two million dollars a year. Although the JLCSA supported the concept, of the study, no funding was made available.

6.3.2 Incidental Catch

Total annual landings in the North Carolina shrimp trawl fishery have averaged 7.3 million pounds, ranging from 2.1 to 9.9 million pounds (DMF Trip Ticket data 1994-2010; Table 6.12). Shrimp (brown, pink, and white) account for 93% of the total landings followed by finfish (4%), crabs [3% (blue, stone, and horseshoe crabs)] and mollusks [0.19% (conchs/whelks, squid, and octopus)].

On average 255,776 pounds of finfish are landed and sold annually by shrimp trawls (Table 6.12). Eighty-nine percent of the total finfish landings were reported in the ocean (< 3 miles) and the Pamlico Sound (Table 6.13). Six groups; sea mullet [whiting, and kingfish 46.14%, 1,925,720 pounds), flounder [summer and southern (17%, 711,590 pounds), spot (17%, 697,715 pounds), Atlantic croaker (6%, 256,741 pounds), weakfish (4%, 166,669 pounds), and butterfish (4%, 156,131 pounds) account for 94% of the finfish landings (Table 6.14). Ninety-seven percent of sea mullet, flounder, spot, Atlantic croaker, and weakfish were reported from two areas, the Pamlico Sound and the ocean (Table 6.15). The ocean accounts for 85% of the croaker, 62% of the sea mullet, and 54% of the spot, 32% of the flounder, and 9% of the weakfish landed from shrimp trawls (Table 6.14). The Pamlico Sound accounts for 88% of the weakfish, 62% of the flounder, 41% of the spot, 37% of the sea mullet, and 14% of the croaker landings for this gear. The peak months for finfish landings from shrimp trawls are in October (22%) and November (22%), with the period of August through December accounting for 80% of all finfish landings (Table 6.16). The peak month for sea mullet landings from shrimp trawls is November (32%), while the period from July through December accounts for 84% of the landings (Table 6.17). Eighty-one percent of the flounder are landed from July through November, with October accounting for 23% of the landings. The period of August through November accounts for 95% of the spot landings, with October accounting for 44% of the landings. Sixty-nine percent of the Atlantic croaker are landed in December, and 94% are

landed from September through January. Weakfish landings peaked in August (26%), while 92% of the landings occur from July through November.

An average of 171,523 pounds of crabs were landed and sold annually by shrimp trawls from 1994 to 2010 (Table 6.12). Fifty-nine percent of the crab landings were reported in Core Sound and 27% in the Pamlico Sound (Table 6.13). The period of April through August accounts for 82% of the crab landings. Seventy-one percent of the mollusk landings were reported from the ocean (< 3 miles) and 14% from the Pamlico Sound. The peak month for mollusk in shrimp trawls is November (22%), while the period of May through December accounts for 94% of the landings.

Table 6.12 Percent shrimp trawl landings (lb)[†] of major market groups for North Carolina, 1994-2010.

Year	Shrimp		Fish		Crabs		Mollusk		Total pounds
	Pounds	% total	Pounds	% total	Pounds	% total	Pounds	% total	
1994	6,888,784	89.46	391,585	5.09	394,817	5.13	25,066	0.33	7,700,252
1995	7,903,144	90.77	562,058	6.46	203,379	2.34	38,285	0.44	8,706,866
1996	4,874,017	85.81	530,605	9.34	266,296	4.69	9,225	0.16	5,680,143
1997	6,451,315	91.51	317,716	4.51	264,656	3.75	16,008	0.23	7,049,696
1998	4,270,740	85.62	197,277	3.95	508,457	10.19	11,574	0.23	4,988,048
1999	8,108,209	92.34	411,973	4.69	247,198	2.82	13,063	0.15	8,780,443
2000	9,442,710	94.90	320,997	3.23	169,906	1.71	16,449	0.17	9,950,063
2001	4,749,564	93.86	141,304	2.79	161,169	3.18	8,256	0.16	5,060,293
2002	8,879,729	95.87	231,457	2.50	143,367	1.55	7,481	0.08	9,262,034
2003	5,432,418	92.85	142,410	2.43	266,528	4.56	9,687	0.17	5,851,042
2004	4,351,064	92.65	185,373	3.95	147,715	3.15	12,136	0.26	4,696,287
2005	2,046,274	95.46	34,746	1.62	58,178	2.71	4,445	0.21	2,143,643
2006	4,862,890	97.24	93,963	1.88	36,224	0.72	8,086	0.16	5,001,163
2007	8,781,019	97.18	216,117	2.39	27,984	0.31	10,345	0.11	9,035,464
2008	8,789,623	96.56	296,496	3.26	4,246	0.05	12,305	0.14	9,102,671
2009	5,039,827	96.50	168,523	3.23	4,827	0.09	9,605	0.18	5,222,782
2010	5,532,780	97.80	105,587	1.87	10,936	0.19	7,895	0.14	5,657,198
Average	6,259,065	93.32	255,776	3.72	171,523	2.77	12,936	0.19	6,699,299

[†]Single gear Trip Tickets

Table 6.13 Percent shrimp trawl landings (lb)[†] of major market groups for North Carolina by waterbody, 1994-2010.

Area	Shrimp		Fish		Crabs		Mollusk		Total	
	Pounds	% of total	Pounds	% of total	Pounds	% of total	Pounds	% of total	Pounds	%
Pamlico Sound	61,577,667	57.87	1,852,608	42.61	773,966	26.54	30,911	14.06	64,235,152	56.40
Ocean < 3 Miles	26,123,378	24.55	2,001,168	46.02	9,630	0.33	155,853	70.87	28,290,028	24.84
Core Sound	7,578,742	7.12	60,120	1.38	1,730,141	59.34	2,536	1.15	9,371,539	8.23
Ocean > 3 Miles	3,272,314	3.08	332,977	7.66	1,911	0.07	19,586	8.91	3,626,789	3.18
Neuse River	2,245,066	2.11	20,597	0.47	256,138	8.78	437	0.20	2,522,238	2.21
Inland Waterway	1,443,181	1.36	17,160	0.39	17,217	0.59	6,702	3.05	1,484,260	1.30
Cape Fear River	1,296,961	1.22	16,738	0.38	6,721	0.23	1,786	0.81	1,322,207	1.16
New River	928,421	0.87	30,189	0.69	35,553	1.22	1,222	0.56	995,385	0.87
Newport River	501,687	0.47	682	0.02	4,349	0.15	133	0.06	506,850	0.45
Pamlico River	472,582	0.44	7,535	0.17	9,665	0.33	*	*	489,868	0.43
North River/Back Sound	313,448	0.29	1,791	0.04	8,669	0.30	396	0.18	324,304	0.28
White Oak River	216,472	0.20	896	0.02	113	0.00	*	*	217,578	0.19
Bay River	152,702	0.14	1,369	0.03	13,271	0.46	*	*	167,360	0.15
Croatan Sound	142,549	0.13	2,993	0.07	30,102	1.03	0	0.00	175,644	0.15
Roanoke Sound	94,879	0.09	1,204	0.03	16,539	0.57	0	0.00	112,623	0.10
Pungo River	31,429	0.03	*	*	*	*	0	0.00	33,324	0.03
Shalotte River	11,847	0.01	149	0.00	*	*	*	*	12,157	0.01
Lockwood Folly	765	0.00	0	0.00	0	0.00	0	0.00	765	0.00
Albemarle Sound	*	*	0	0.00	0	0.00	0	0.00	18	0.00
Total	106,404,108	100.00	4,348,187	100.00	2,915,886	100.00	219,908	100.00	113,888,089	100.00

*Confidential

†Single gear Trip Tickets

Table 6.14 Yearly finfish landings (lb)[†] from shrimp trawls all North Carolina Waters combined, 1994-2010.

Year	Sea Mullet	Flounders	Spot	Croaker	Weakfish	Butterfish	Other Species	Sheepshead	Harvestfish	Spanish Mackerel	Pigfish
1994	93,244	131,247	57,835	14,305	47,385	8,710	29,957	4,206	1,722	850	2,123
1995	226,595	74,176	78,795	18,642	40,312	50,685	56,802	4,326	6,658	3,287	1,781
1996	132,953	70,688	72,924	190,251	18,492	18,905	14,681	3,155	4,077	2,273	2,208
1997	105,149	63,457	76,050	15,695	13,786	7,142	20,806	3,265	4,813	5,043	2,512
1998	78,843	39,143	43,493	1,857	5,014	6,657	12,874	2,749	3,199	1,911	1,538
1999	231,075	68,648	45,351	6,956	17,304	10,167	16,376	4,366	8,627	2,271	832
2000	154,700	38,810	80,608	1,129	7,190	7,347	18,440	4,911	5,327	1,439	1,097
2001	47,414	30,419	43,176	2,254	1,793	2,316	8,868	1,811	2,040	497	717
2002	113,705	48,581	36,013	1,661	2,983	6,925	12,926	4,315	2,534	1,183	632
2003	67,859	24,257	33,884	994	1,360	1,638	7,582	2,622	1,234	164	815
2004	107,529	24,223	27,090	705	2,917	9,230	8,479	3,684	869	173	473
2005	14,399	5,427	3,578	78	596	1,154	7,041	1,556	643	211	64
2006	45,688	16,080	15,740	449	1,959	3,800	8,125	1,418	554	45	107
2007	129,316	21,588	20,714	208	1,561	6,916	11,529	16,579	7,437	151	120
2008	211,946	24,873	21,609	519	2,787	8,325	16,931	5,445	3,228	583	252
2009	86,553	19,367	36,725	603	752	4,585	13,290	2,658	2,663	1,200	128
2010	78,750	10,605	4,130	436	480	1,631	6,313	1,329	1,457	307	150
Total lbs	1,925,720	711,590	697,715	256,741	166,669	156,131	96,436	68,390	57,079	21,585	15,547
% of total	46.14	17.05	16.72	6.15	3.99	3.74	2.31	1.64	1.37	0.52	0.37

[†]Single gear Trip Tickets

Table 6.15 Percent shrimp trawl landings (lb)[†] of top five finfish groups by waterbody, 1994-2010.

Waterbody	Sea Mullet		Flounders		Spot		Croaker		Weakfish		Total	
	Pounds	% sea mullet	Pounds	% flounder	Pounds	% spot	Pound	% croaker	Pounds	% weakfish	Pounds	%
Ocean	1,191,867	61.90	231,021	32.47	372,837	53.51	218,132	85.02	14,213	8.54	2,028,070	53.96
Pamlico Sound	709,326	36.84	437,684	61.51	287,497	41.26	35,329	13.77	146,633	88.15	1,616,469	43.01
Core Sound	9,269	0.48	16,457	2.31	6,363	0.91	366	0.14	2,019	1.21	34,473	0.92
New River	2,101	0.11	7,843	1.10	14,055	2.02	1,161	0.45	107	0.06	25,266	0.67
Neuse River	6,521	0.34	4,894	0.69	3,482	0.50	444	0.17	1,701	1.02	17,040	0.45
Inland Waterway	1,405	0.07	3,855	0.54	7,769	1.11	553	0.22	94	0.06	13,675	0.36
Cape Fear River	2,430	0.13	4,736	0.67	2,352	0.34	290	0.11	185	0.11	9,993	0.27
Pamlico River	2,107	0.11	2,837	0.40	860	0.12	100	0.04	384	0.23	6,287	0.17
Croatan Sound	204	0.01	574	0.08	1,087	0.16	113	0.04	452	0.27	2,430	0.06
North River/Back Sound	78	0.00	135	0.02	*	*	*	*	*	*	1,296	0.03
Bay River	224	0.01	366	0.05	131	0.02	54	0.02	455	0.27	1,229	0.03
Roanoke Sound	18	0.00	452	0.06	389	0.06	29	0.01	101	0.06	989	0.03
White Oak River	*	*	603	0.08	*	*	0	0.00	0	0.00	833	0.02
Newport River	*	*	108	0.02	*	*	*	*	*	*	233	0.01
Shalotte River	0	0.00	*	*	*	*	0	0.00	0	0.00	143	0.00
Pungo River	0	0.00	*	*	0	0.00	*	*	0	0.00	12	0.00
Total	1,925,720	100.00	711,590	100.00	697,715	100.00	256,741	100.00	166,669	100.00	3,758,435	100.00

*Confidential

†Single gear Trip Tickets

Table 6.16 Percent shrimp trawl landings (lb)[†] of major market groups landed for North Carolina (all waters combined) by month, 1994-2010.

Month	Shrimp		Fish		Crabs		Mollusk		Total	
	Pounds	% total	Pounds	% total	Pounds	% total	Pounds	% total	Pounds	%
January	663,541	0.62	71,145	1.64	11,235	0.39	2,305	1.05	748,226	0.66
February	458,803	0.43	86,844	2.00	6,317	0.22	3,708	1.69	555,672	0.49
March	308,600	0.29	90,926	2.09	49,284	1.69	1,272	0.58	450,082	0.40
April	598,610	0.56	54,255	1.25	271,902	9.32	6,733	3.06	931,499	0.82
May	2,306,314	2.17	105,169	2.42	531,624	18.23	16,205	7.37	2,959,311	2.60
June	7,243,268	6.81	130,633	3.00	616,100	21.13	21,785	9.91	8,011,786	7.03
July	28,302,130	26.60	351,103	8.07	663,163	22.74	24,838	11.29	29,341,234	25.76
August	22,540,167	21.18	505,297	11.62	298,053	10.22	29,606	13.46	23,373,123	20.52
September	15,816,897	14.86	566,800	13.04	131,437	4.51	16,298	7.41	16,531,432	14.52
October	17,060,394	16.03	965,699	22.21	134,967	4.63	31,018	14.10	18,192,078	15.97
November	8,996,863	8.46	975,606	22.44	152,002	5.21	48,802	22.19	10,173,273	8.93
December	2,108,521	1.98	444,712	10.23	49,802	1.71	17,338	7.88	2,620,374	2.30
Total	106,404,108	100.00	4,348,187	100.00	2,915,886	100.00	219,908	100.00	113,888,089	100.00

[†]Single gear Trip Tickets

Table 6.17 Percent shrimp trawl landings (lb)[†] of top five finfish groups by month, 1994-2010.

Month	Sea Mullet		Flounders		Spot		Croaker		Weakfish		Total	
	Pounds	% sea mullet	Pounds	% flounder	Pounds	% spot	Pounds	% croaker	Pounds	% weakfish	Pounds	%
January	46,808	2.43	5,331	0.75	33	0.00	9,691	3.77	289	0.17	62,151	1.65
February	79,560	4.13	2,679	0.38	20	0.00	10	0.00	401	0.24	82,670	2.20
March	65,996	3.43	7,231	1.02	557	0.08	1,000	0.39	636	0.38	75,420	2.01
April	30,151	1.57	16,118	2.27	992	0.14	391	0.15	393	0.24	48,044	1.28
May	30,595	1.59	35,175	4.94	2,263	0.32	339	0.13	2,288	1.37	70,658	1.88
June	49,894	2.59	44,655	6.28	3,072	0.44	661	0.26	4,198	2.52	102,481	2.73
July	171,832	8.92	71,455	10.04	25,665	3.68	4,206	1.64	27,593	16.56	300,750	8.00
August	217,017	11.27	89,113	12.52	74,100	10.62	9,300	3.62	42,543	25.53	432,073	11.50
September	107,601	5.59	163,400	22.96	163,107	23.38	16,316	6.36	27,360	16.42	477,785	12.71
October	323,726	16.81	166,200	23.36	306,548	43.94	18,031	7.02	31,539	18.92	846,043	22.51
November	635,332	32.99	84,050	11.81	117,991	16.91	18,770	7.31	24,630	14.78	880,772	23.43
December	167,211	8.68	26,182	3.68	3,367	0.48	178,027	69.34	4,802	2.88	379,588	10.10
Total	1,925,720	100.00	711,590	100.00	697,715	100.00	256,741	100.00	166,669	100.00	3,758,435	100.00

[†]Single gear Trip Tickets

6.3.3 Discarded Catch

In 1998 the NMFS completed a report summarizing the results from their Southeastern United States Shrimp Trawl Bycatch Program in response to a Congressional requirement imposed by the Sustainable Fisheries Act of 1996. The shrimp trawl bycatch program was initiated in 1992 as part of Section 405(e) of The Magnuson-Stevens Fishery Conservation and Management Act. In that report, more than 150 taxa were identified in shrimp trawl catches in the South Atlantic, with an average overall catch rate of 57.33 pounds per hour (Nance 1998). Finfish made-up 54% of the catch by weight, shrimp 18%, other invertebrates 18%, and the remaining 13% was composed of crustacean. Seasonal distribution of finfish bycatch in the south Atlantic indicates that the highest percentage by weight occurs in the summer, while numerically finfish bycatch is highest in the spring. The top ten species by weight were: cannonball jelly (14%), white shrimp, spot, and Atlantic menhaden each at 9%, brown shrimp and other jellyfish at 6% each, Atlantic croaker contributes 6%, southern kingfish, and blue crab each at 4%, and star drum at 3%.

In the Gulf of Mexico over 450 taxa were identified in shrimp trawls (Nance 1998). The average hourly catch was approximately 59 pounds per hour of tows. Finfish made-up 67% of the catch by weight, shrimp 16%, crustacean 13%, and the remaining 4% was composed of other invertebrates. Seasonally, finfish bycatch was highest, by weight, in the fall. The 10 most abundant species by weight were: longspined porgy (15%), brown shrimp (9%), Atlantic croaker (9%), inshore lizardfish (6%), pink shrimp (3%), gulf butterfish, and lesser blue crab, white shrimp, longspined swimming crab, and brown rock shrimp each comprising 2% of the catch.

In 1950 sampling was conducted aboard commercial shrimp trawlers working in Core and Pamlico sounds (Roelofs 1950). Although only total weights were reported for shrimp and finfish, Roelofs (1950) indicated that for Core Sound "85 to 90% of the fish taken were croakers and spot, with croaker predominating; while in late August, hogfish, pinfish and other trash species increased until they made up over 50 per cent of the catch". Seven tows were sampled in Pamlico Sound during September of 1950. Atlantic croaker comprised 73% of the finfish taken, with spot and trout each accounting for 10% (Roelofs 1950).

Prior to the work done by Diamond-Tissue (1999) and Johnson (2003; 2006), there was little information characterizing the bycatch in the North Carolina shrimp trawl fishery. Diamond-Tissue's (1999) 1995 characterization study examined 52 tows conducted over 15 trips. Samples from Pamlico Sound (n=16 tows) and the Cape Fear River (n=24 tows) were collected monthly from July through October 1995. Additionally, four tows were sampled in Core Sound in August 1995, and eight tows were examined off Carolina Beach during July and August. Sampled boats had one or two nets, and all nets contained the required TED and BRD. A total of 92 different species, including 66 species of finfish, 10 species of crabs, and 13 other invertebrates were identified. For all areas combined, market-size penaeid shrimp made up 44.3% of the organisms by number and 30.8% by weight. The top finfish species by number were star drum, Atlantic croaker, weakfish, and spot, while Atlantic croaker, weakfish, spot, and star drum were the top finfish species by weight. In Pamlico Sound, 38 species were identified in the catches, 37 were identified in Core Sound, and 50 species were identified in Cape Fear River. Market-size penaeid shrimp were the top species in terms of both numbers and weight for all areas combined, as well as for all individual areas by number, and all areas by weight except Core Sound. The composition of finfish in the bycatch varied by area, with Atlantic croaker, spot, and weakfish accounting for 53% of the total catch by number and 56% by weight in Pamlico Sound. In Core Sound, pigfish, spot, and Atlantic croaker were the most abundant

finfish species in terms of number and weight. Star drum, weakfish, and Atlantic croaker were the most abundant species in the Cape Fear River.

Johnson (2003) quantified the catch of shrimp trawlers working in Core Sound (n=46 tows) and the Neuse River (n=8 tows) during the summers of 1999 and 2000. Overall, blue crabs accounted for 26% by weight of the total combined catch. Spot accounted for 17% of the total catch and 40% of the total finfish bycatch. Core Sound catches were dominated by invertebrates, crabs, and shrimp, which accounted for 71% of the total catch. Three species of finfish; spot (48%), Atlantic croaker (13%), and pinfish (12%) accounted for 73% of the finfish bycatch from this area. In the Neuse River, invertebrates made up 24% of the sampled catches. Atlantic croaker (44%) and spot (33%) accounted for 77% of the finfish bycatch.

During the spring and summer of 1999 and 2000 Johnson (2006) also characterized the bycatch of inshore commercial shrimp trawlers working in Core Sound, Southern Pamlico Sound and Back Sound. All nets sampled were fitted with BRDs and TEDs, the Florida Fish Eye (FEE) excluder was cited as the most commonly used BRD. A total of 52 trawls were sampled, however only 50 trawls were analyzed for species composition. Overall, shrimp accounted for 21% of the catch by weight. Fish, blue crabs, and other organisms, such as jellyfish, horseshoe crabs, and other species of crabs made up 27%, 33%, and 20% of the catch by weight, respectively. The majority of the bycatch and discards were made up of juvenile estuarine fish and juvenile and adult blue crabs. Spot (21%), Atlantic croaker (8%) and pinfish (4%) were the most abundant finfish by weight. The average CPUE for shrimp was 15.3 kg/hr and 19.0 kg/hr for fish (1 kilogram [kg] = 2.20 pounds).

Logothetis and McCuiston (2004) characterized the bycatch of the inshore commercial shrimp fishery in southeastern North Carolina during the 2004 shrimp season. From April through November, 64 trips were observed, consisting of 132 tows in five regions (IWW of Brunswick, New Hanover, Onslow, and Pender Counties, and the Cape Fear River). Fishing took place on a 24 foot shrimp trawler using single-rig otter trawls; trawl type depended on the target species. All tailbags were 1 ½" stretch mesh, all nets were fitted with diamond shaped FFEs and an aluminum TED. Shrimp (brown, pink, white) made up 55% of the total catch. Bycatch made up roughly 45% of the total catch and consisted of 84 different species. Blue crabs accounted for 9% by weight of the total combined catch. Atlantic croaker (8%), weakfish (4%), pinfish (4%), spot (4%), and flounder species (southern and summer flounder) accounted for (2%) by weight of the total catch. One Kemp's ridley sea turtle was also caught during the study. The length frequencies of the bycatch indicated that nearly all of the bycatch were juvenile to subadult species. Roughly 50% of the blue crab, 100% of the weakfish, and 95% of the flounder species would have been regulatory discards using today's minimum size limits [blue crab - 5" carapace length, weakfish - 12" minimum TL, flounder species - 14" minimum TL (commercial)]. Overall, the catch rates for bycatch peaked in July, elevated levels of bycatch were also observed in May and September. The highest observed mean CPUE (kg/min) for invertebrates in all regions occurred in August (0.149) and for commercial and recreational finfish in May (0.226) and July (0.273).

Brown (2009) characterized the near-shore commercial shrimp trawl fishery from Carteret County to Brunswick County from 2007 to 2008. In this study commercial fishermen were randomly selected, and observer effort was weighted by region using the NCDMF Trip Ticket Program. Over the course of the study, observations were made on 142 trips, consisting of 314 tows, achieving 5.92% coverage in number of trips. The results were stratified by net type (double seamed and tongue nets) and season (Winter: January-March, Spring: April-June, Summer: July-September, Fall: October-December). All observed trips used FFEs, Super

Shooter, Straight Bar and Inshore Hard TEDs were also observed on the majority of the trips; however, 4% of tongue net trips used no TED. Over 100 species were observed throughout the study in all net types; 80 in the double seamed nets and 90 in the tongue nets. Shrimp (brown, white, pink) accounted for 21% of the catch by weight in all net types. Atlantic croaker (25%) and spot (7%) were the most abundant finfish bycatch in all net types. In the double seamed fishery, the CPUE [(total weight (kg) / (headrope length* number of nets*tow time)] of Atlantic croaker was significantly higher than the other commercially important finfish bycatch in the spring and summer; in the tongue net fishery it was higher during the summer. The CPUE of spot was higher in the summer for the double seamed trawl nets. In the tongue net fishery, the spot CPUE was the highest in the fall. Overall, roughly 99% of spot by weight were classified as unmarketable bycatch. Weakfish represented the largest regulatory discard (60%) by weight in both nets. The CPUE for weakfish was the highest during the summer in the tongue net fishery; almost three times as high as what was observed in double seamed fishery during that same period. In the double seamed nets, Spanish mackerel, southern flounder, and summer flounder represented 16%, 8%, and 9% of the regulatory discards, respectively. In the tongue net fishery Spanish mackerel, southern flounder, and summer flounder represented 15%, 8%, and 8% of the regulatory discards, respectively.

In 2009, Brown (2010b) conducted another study characterizing the inshore commercial shrimp trawl fishery in the Pamlico Sound and its tributaries. Using the same protocol as used in Carteret and Brunswick County survey (Brown 2009) the catch of federally and state managed species of finfish caught in double seamed, four seamed and tongue nets was quantified. Over the course of the study, 66 commercial shrimp trawl fishing days were observed, consisting of 191 tows, achieving 1.21% coverage in fishing days. Similar to the previous study, all observed trips used the FFE. Super Shooter, Straight Bar and Inshore Hard TEDs were also observed on the majority of the trips. Sixty-nine species were observed throughout the study in all net types, 56 were observed in the double seamed shrimp trawl nets, 51 in the four seamed nets and 38 in the tongue nets. Shrimp (brown, white, pink) accounted for 23% of the catch by weight in all net types. Atlantic croaker (33%) and spot (13%) were the most abundant finfish bycatch by weight in all net types and accounted for the largest percentage of unmarketable discards. Weakfish, kingfish (*Menticirrhus spp.*), and spotted sea trout represented 6.34%, 0.79%, and 0.02% of the catch in all net types by weight, respectively. The highest observed CPUEs of Atlantic croaker and spot were observed in summer double seamed fishery. Weakfish represented the largest regulatory discards in the double seamed net (98%), four seamed nets (100%) and the tongue net fishery (86%). The highest observed CPUE for weakfish occurred in the summer four seamed fishery. Spanish mackerel, southern flounder, and summer flounder represented 0.48%, 5%, and 17% of the regulatory discards in the double seamed nets, respectively. In the four seamed net fishery, Spanish mackerel, southern flounder, and summer flounder represented 2%, 3%, and 6% of the regulatory discards, respectively. Spotted seatrout, Spanish mackerel, southern flounder, and summer flounder represented 4%, 1 %, 1%, and 9% of the regulatory discards in the tongue net fishery, respectively.

Another way of presenting and expanding bycatch data is by using the ratio of finfish to shrimp (F:S). A common method of calculating F:S ratios is to subsample the entire catch and to expand the shrimp to finfish ratio of subsample to the weight of the entire catch. Diamond (2003) cautions that F:S ratios tend to overestimate bycatch and that a CPUE estimator is the most appropriate method of scaling up individual observations to the entire fishery. The F:S ratio can be a factor of the environment and a fisherman's experience, thus if there are few shrimp in the area or a fisherman's gear is not fishing properly or he is in a poor area, a higher F:S ratio will result (Coale et al. 1994). In a study using both field data and computer simulations to compare the methods of bycatch estimation, total bycatch estimates derived with

the basic F:S ratio estimator by both weight and number were two to seven times higher than those based on the CPUE-mean per unit method (Diamond 2003). Both the CPUE and F:S methods tend to ignore sources of variability at several hierarchical levels, assuming that total shrimp catch and effort data are without error and that the catches are thoroughly mixed so a single sample characterizes the entire catch without variance (Diamond-Tissue 1999). Additionally, both estimation methods add a certain degree of error when they get expanded from the sampled net to the number of nets per tow. While both methods of estimating bycatch have their advantages and disadvantages, the F:S method is much easier to obtain and use than effort data and allows the use of observer data at the tow level without the additional variance caused by averaging the number of tows per trip (Vaughan and Nance 1998).

Nance (1998) reported a F:S ratio of 5.3:1 for the Gulf of Mexico, and 4.5:1 for the South Atlantic. Reported F:S ratios for North Carolina are 1.5:1 (Roelofs 1950), 1.6:1 (Diamond-Tissue 1999), 3.1:1 (Johnson 2003), 0.5:1 (Logothetis and McCuiston 2005), 1.6:1 (Johnson 2006). Using the relative biomass tables (kg) in Brown's (2010b) study characterizing the inshore commercial shrimp trawl fishery in the Pamlico Sound and its tributaries, the calculated F:S ratio (excluding sharks, and rays) was 2.7:1 (all gear types), 2.9:1 (double seamed net fishery), 2.4:1 (four seamed net fishery) and 3.4:1 (tongue net fishery). Again using Brown's (2009) relative biomass tables (kg) the calculated F:S ratio of the near-shore commercial shrimp trawl fishery from Carteret County to Brunswick County was 2.7:1 (all gears), 2.0:1 (double seamed net fishery) and 3.3:1 (tongue net fishery). Johnson (2006) notes that the F:S ratios reported in her study were highly variable (ranging from 0 to 6.9:1) and were included solely for comparison to other studies and not intended for use to estimate the total bycatch in the fishery. Diamond (2003) also cautions that due to statistically significant two- and three-way interactions among parameters (mean or variance of catch, observer coverage, correlation between the catch of fish and shrimp), bycatch estimates obtained with different methods should not be compared directly. Additionally, the methods used to analyze F:S ratios are often not well described and vary from study to study (Diamond-Tissue 1999). Table 6.18 lists the findings of various studies characterizing the commercial shrimp trawl fisheries in North Carolina and the South Atlantic.

Numerous gear evaluation studies have also been conducted in North Carolina waters (McKenna and Monaghan 1993; Coale et al. 1994; Murray et al. 1995; McKenna et al. 1996, Brown 2010a). However, this data should not be used for characterization analysis since these studies are often relegated to times of low shrimp catch rates, and as such, the bycatch data are not representative of times when shrimp catch rates are higher. For example the F:S ratio for gear studies conducted in 1994 (McKenna et al. 1996) was 5.5:1, while characterization studies conducted in 1995 by Diamond-Tissue (1999) found the F:S ratio to be 1.6:1. While these data should not be used for characterization analysis, catches can provide information on species and sizes of species vulnerable to shrimp trawls. However, it is important to note that for all discard and bycatch studies, variability exists within time periods as short as 24 hours and extends to year-to-year variability and it may not be reasonable to assume that bycatch rates in neighboring areas can give an accurate approximation of an unsampled area (Alverson et al. 1994; Alverson and Hughes 1996; Diamond-Tissue 1999). Furthermore, the ratio of discards to retained or total catch as well as raw numbers of weight are not, in themselves indicators of serious biological or ecological problems (Mangel 1993; Alverson and Hughes 1996).

Table 6.18 Author (year published), years sampled, area sampled, number of trips sampled, number of tows sampled, number of species observed, percent bycatch, percent finfish, percent shrimp, finfish to shrimp ratio (F:S), and bycatch to shrimp ratio (BC:S) of previous bycatch characterization work conducted in North Carolina and the South Atlantic.

Report	Years Sampled	Area Sampled	Percent Coverage	Number Trips	Number of Tows	Number of Species	Percent Bycatch†	Percent Finfish†	Percent Shrimp†	F:S Ratio†	BC:S Ratio††
Roelofs (1950)	1950	Core Sd, Pamlico Sd			17					1.5:1	
Nance (1998)	1992-96	South Atlantic (shown), Gulf of Mexico		604**	5,695**		82	54	18	4.5:1	
Diamond-Tissue (1999)	1995	Pamlico Sd, Core Sd, Cape Fear River, Ocean (off Carolina Beach)		15	52	92	69	51	31	1.6:1	
Johnson (2003)	1999-00	Core Sd, Neuse River			52		80		20	3.1:1	5.7:1
Johnson (2006)	1999-00	Back Sd, Core Sd, Southern Pamlico Sd		15	52		79	27	21	1.6:1	
Logothetis & McCuiston (2004)	2004	IWW of Brunswick Co, Onslow Co, Pender Co, Cape Fear River		64	132	87	45		55	0.5:1	0.8:1
Brown (2009)	2007-08	Brunswick Co, Cape Fear River, New Hanover Co, Onslow Co, Pender Co	5.92	142	314	110	79	56**	21	2.7:1*	3.8:1*
Brown (2010)	2009	Pamlico Sd	1.21	66	191	69	77	61**	23	2.7:1*	3.4:1*

†By weight (kg)

††By weight (kg), includes finfish, jellyfish, rays, sharks, crabs, etc.

*Calculated using relative biomass tables (kg) from report using Logothetis and McCuiston's (2005) method that excludes sharks and rays.

**Number of trips and tows includes both South Atlantic and Gulf of Mexico

6.3.4 Biological Implications of Bycatch

Evaluating the biological impacts of bycatch is a two stage process. First, the bycatch must be characterized in both magnitude and nature. Second, information obtained from characterization efforts must be applied to population and ecosystem models to evaluate potential impacts at those levels. Although, by definition, bycatch can include both incidental and discarded catch, much of the current concern is directed toward discarded animals. This concern is largely due to a general perception that discarded bycatch is a waste of natural resources and leads to overfishing (Crowder and Murawski 1998). Beyond the obvious impacts on discarded individuals, there are also potential population and ecosystem level effects (Alverson et al. 1994; Crowder and Murawski 1998). Kept bycatch has biological impacts also, but since it is accounted for as catch such impacts are encompassed in harvest management strategies.

As previously noted, the biological significance of bycatch can be judged from a number of different perspectives, including those of the populations (e.g., of a particular species), of the fishery or fisheries that target or otherwise encounter the species, and of the general biological community (Murawski 1995). The first phase of characterization starts at the level of an individual animal. Discarded individuals suffer one of two immediate alternative fates: survival or death. Further, initial survival may still lead to chronic effects, such as delayed mortality, reduced growth, interrupted maturation, and displacement. Discarded animals are also vulnerable to increased predation, as shown by numerous observations of live discarded animals being preyed upon by birds, marine mammals, and finfishes. If this initial predation is avoided, the animals must still seek shelter and return to their normal environments, all the while exposed to the risk of predation (Murawski 1995).

In survival experiments examining the fate of discarded bycatch in the Core Sound and Neuse River shrimp trawl fisheries, 34% of the overall organisms caught were alive and healthy at the time of “discarding”, 11% were injured or non-responsive, and 56% were dead (Johnson 2003). Survival was also found to vary among species and the amount of time on deck. On average 80% of the blue crabs survived uninjured, survival did not improve with shorter tow durations or time on deck. Eleven percent of the finfish survived uninjured, 11% survived but were injured or unresponsive, and 78% were dead. Survival of croaker declined significantly with increasing time on deck; however, pinfish and spot showed no change in survival with time out of water or tow time. Spot had the lowest survival of the common species in the discards. In another survival experiment, 45% of the fish caught as bycatch were alive and healthy, 3% were alive and weak, and 52% were dead after an average holding time of 3.22 hours (Logothetis and McCuiston 2005). Logothetis and McCuiston (2005) also found that significantly more fish survived if cull times were 30 minutes or less and water temperatures were less than ~80°F; however, the survivability of weakfish was less than 50% even when the cull times were short. Birds and blue crabs were found to be the primary scavengers on the discards, most of which were dead juvenile finfish (Johnson 2003; Logothetis and McCuiston 2005).

While discarding is generally thought of in an active sense, most fishing gears are designed to provide some degree of passive discarding. In trawling, mesh sizes are selected by choice or mandated by regulation to prevent the harvest of small sized animals and it is generally assumed that animals escaping through the mesh survive. However the possibility remains that not all animals survive, resulting in some level of unobserved mortality. This unobserved mortality is a difficult issue for both managers and scientists because when it occurs, the actual reduction in bycatch and thus mortality is lessened (Chopin and Arimoto 1995). Furthermore, since gear escapees cannot be counted by conventional fishery observer programs, they cannot

be monitored or included in stock assessment calculations. Chopin and Arimoto (1995) suggest that escapee mortality should be considered if gear-based measures are used as a primary management tool.

When viewed at the population level, the first instinct of many people is to assume that discarding adversely impacts populations or stocks. Such ideas lead to the widely held view that discarding, especially when the magnitude in pounds or numbers is large, contributes to overfishing and the decline of many stocks. Even if a bycatch associated fish stock is in decline, proving cause and effect is difficult because other factors such as environmental degradation may be involved (Murray et al. 1992). Unfortunately, few hypotheses about population-level impacts have been tested (Crowder and Murawski 1998). Regardless, just as large levels of discarding do not necessarily lead to significant biological impacts; it cannot be assumed that minimal discarding has only minor effects (Alverson et al. 1994). Discard impacts can only be determined through proper data collection and analytical investigations. Various studies suggest that discarding has harmed some stocks, while others seem unaffected. For example, discarding has been implicated in the decline of Gulf of Maine groundfish, Atlantic croaker in the Gulf of Mexico, and scup and black seabass in the Mid-Atlantic (Alverson et al. 1994; ASMFC 1996a; ASMFC 1996b). Conversely, sizable discarding of redfish in the Northwest Atlantic and pollock, cod, and sablefish in the Northeast Pacific represents only a fraction of the total mortality of these species and is not believed to have a significant adverse impact on population abundance (Alverson et al. 1994).

The magnitude of discarding should not be the only concern when examining population-level impacts because such effects are also related to the size or life-stage of the discarded animal. If discards are immature or below the size for optimum yield, both yield-per-recruit and spawning potential may be adversely impacted (Crowder and Murawski 1998). In other words, it is commonly known that harvesting fish before they mature and spawn can lead to recruitment overfishing and can impair a stock's ability to sustain itself. Also, harvesting a fish before it reaches some optimal size can lead to growth overfishing and reduced overall yield from the fishery. Thus, fish with slow growth rates may be more affected by bycatch mortality. These principles are unavoidable consequences of exploitation that can occur whether the fish are harvested or discarded.

In addition to impacts on individuals and populations, it is suspected that discarding can also alter entire communities. Community effects are still largely unknown, but in theory they could be significant. For instance, if an abundant species that dominates a community is removed by harvest while another species is discarded and survives, the community could eventually change to the extent that the discarded species becomes the dominant species in the ecosystem (Murawski 1995). If the newly dominant species is of less value, either ecologically or economically, both the ecosystem and the fishing economy could suffer. It is thought that such species-specific exploitation could be more damaging to the productivity of an ecosystem than exploitation of the entire community. However, such effects remain largely speculative as there has been little research on community-level effects.

Deehr (2012) investigated and modeled the impacts of shrimp trawling on the estuarine ecosystem in Core Sound, North Carolina. Using field collections, fisheries data from the NC Trip Ticket program, and Ecopath network modeling software, she created four network models of areas open and closed to shrimp trawling during spring (2007) and fall (2006 and 2007). Each model consisted of 65 compartments (including non-living detritus, bycatch, producers, and various invertebrate and vertebrate consumers), and harvests by different types of fishery

gears (crab pots, gill nets, haul seines, and pound nets in closed areas; shrimp trawls, skimmer trawls were added to the models in areas open to trawling).

Based on the benthic sampling, shrimp trawling had a major impact on the Core Sound ecosystem. Contrary to expectation, biomass (g C/m²) of infaunal benthic invertebrates, especially deposit-feeding polychaetes, was significantly greater in areas open to trawling. Meiofaunal biomass was significantly greater in the closed areas. Field collections of fish and invertebrates revealed that there was more biomass (g C/m²) of benthic-invertebrate feeders (such as blue crabs, spot, and pinfish) in areas closed to trawling. These results suggest a trophic cascade due to trawling may have occurred in the open areas, whereby trawls removed benthic-feeding fishes and blue crabs, released their prey (benthic polychaetes) from predation pressure, and lowered the abundance of meiofauna (prey of the polychaetes). Alternatively, the dead biomass from by-catch could fuel the growth in polychaetes and other benthos due to a direct subsidy from trawling. Further experimental work is required to test these model-derived hypotheses.

Ecopath-calculated effective trophic levels were validated using stable isotopes of $\delta^{15}\text{N}$ and $\delta^{13}\text{C}$. Trophic fractionation occurred across trophic levels, and results were comparable to published studies (for each unit effective trophic level increase there was a fractionation of +2.637‰ for $\delta^{15}\text{N}$ and +1.084‰ for $\delta^{13}\text{C}$). These results indicate that the trophic relationships established in the diet matrices reflect the observed trophic positions revealed through stable isotope analysis.

Ecopath whole-ecosystem metrics indicated that net primary productivity, trophic efficiency, ascendancy, and net primary production: respiration ratios were greater in the areas open to trawling; total system throughput and Finn Cycling Index were greater in the areas closed to trawling. Compartment-level comparisons were made using mixed trophic impacts (MTI) to determine how a small increase in the biomass of one compartment impacts all other compartments in the models. The MTI analysis for the Spring Open model indicated that a small increase in shrimp trawling in Core Sound caused large (>10%) negative impacts only on jellyfish, a bycatch species, whereas the resulting increased bycatch caused large (>10%) positive impacts on blue crabs, other smaller crabs and the crab pot fishery. The Fall Open models showed no large MTI impacts (neither positive nor negative) on any compartments with small increases in shrimp trawling or bycatch. In both Spring Open and Fall Open models, skimmer trawls caused large negative impacts on two bycatch groups: smooth dogfish and skates/rays. Thus, the greatest impacts of trawling are experienced in the spring in areas open to trawling, resulting in increases that benefit the crab pot fishery.

6.3.5 Bycatch Impacts on Stock Assessment and Prediction

Any population is a dynamic entity that will fluctuate in abundance as members enter and members leave. In a simplified example of a fish population, the entering members (or recruits) are the fish born each year and the leaving members are those removed by natural mortality and harvest (or catch). However, as indicated previously, bycatch can result in largely unknown levels of additional removals from the population. Most quantitative stock assessment techniques involve statistical analysis of catch data and, thus, require an accurate record of the entire catch to reliably estimate stock parameters such as recruitment, abundance, and selectivity. Since these parameters are crucial to forecasts of future stock conditions, any error or bias in them will lead to additional uncertainty in the predictions.

Before bycatch estimates can be used in stock assessments, it is necessary to convert total numbers to numbers at age and to expand estimates from known strata to unknown strata so that the entire fishing area is encompassed. Diamond-Tissue (1999) concluded that the best way to obtain unbiased estimates of bycatch is through an observer program based on randomly observed trips. A stratified random sampling design based on five geographic regions and four shrimp seasons (spring, summer, fall, winter) would be optimal. Nance (1998) notes that it is impossible to evaluate just how well a sample represents the entire fleet using objective, statistical means if vessels and trips are non-random. Based on initial estimates of variance among nets, tows, trips, months, and areas, a minimum of 60 trips per strata is needed to narrow the confidence intervals to one-half of their current range (Diamond-Tissue 1999).

Very little discard information was available in the past, so it was often assumed that discarding was a constant that could be largely ignored without causing any serious bias in assessment results (Murawski 1995). This trend is changing with the availability of additional research suggesting that while discarding may be constant in some fisheries, it is quite variable in many others; either way discards represent an unaccounted mortality in fisheries (Alverson and Hughes 1996). The challenge now lies in determining whether the additional precision gained by including discard losses justifies the expense and effort of collecting the data (Alverson et al. 1994). Since the impacts of overlooked bycatch on assessment results will vary from fishery to fishery, each case must be evaluated separately, and at least some characteristics of the bycatch must be determined.

In the most basic sense, discarded bycatch causes an underestimate of the total catch and evaluating how an assessment model responds to such an underestimate is fairly simple. It is known that responses vary among analytical techniques and depend on such factors as the age distribution of the discarded fish, the magnitude of harvest to discards, the variability and predictability of discard rates, relative year class strength, and the exploitation patterns of the involved fisheries (Alverson et al. 1994; Murawski 1995). Much of this knowledge is intuitive, and stems from understanding the interactions between input data (catch) and model outputs such as stock size and fishing mortality. Still lacking at this time are adequate bycatch estimates that could support the transition from generalized to quantitative responses. For example, if the discarded bycatch is composed of young fish and the actual removal of young fish from the population is more than that indicated by the available data then this portion of the total catch is underestimated. In generalized terms, omitting the discard data from the analysis will underestimate recruitment and, to a lesser extent, mortality rates at age. If the discarded bycatch is older fish, both numbers at age and recruitment will be underestimated and thus overall stock biomass will be underestimated as well. Quantitative responses are desirable and certainly feasible, but they require some estimate of the magnitude of the discarded bycatch.

Similar to status estimates, how discards will affect stock predictions depends on several factors, including the type of predictions being considered, variability and predictability of discard characteristics, and fishery selectivity (Alverson et al. 1994). In all situations, if discard rates cannot be predicted, then the fishery predictions will contain additional error. Short-term yield forecasts are robust if discarding and fishery selectivity are constant and predictable, but if discarding represents varying proportions of the total catch, these predictions may be impacted significantly. The impact will likely be expressed as additional uncertainty rather than as a bias (Alverson et al. 1994, Murawski 1995). According to Alverson (1994) and Murawski (1995), long-term forecasts such as equilibrium yield and spawning biomass per recruit analyses require inclusion of all sources of mortality and thus are very sensitive to discard effects. Even constant discard rates influence long-term predictions when the exploitation pattern of a fishery

changes, a point that can have important consequences when contemplating changes in size or mesh restrictions.

The lack of reliable discard estimates has not stopped researchers from investigating assessment impacts, but it has prevented increases in precision. Exploration of such sources as the SEAMAP database and the NMFS vessel logbook entries has provided a wide range of discard estimates for a number of fish stocks. Most assessments address the range of bycatch estimates through sensitivity analyses by comparing basic assessment results over the range of bycatch estimates and assumptions. However, estimates of the weight or number of species taken as bycatch, no matter how large or small, are meaningless without an estimate of population abundance (Diamond 2003). Those preparing or reviewing the estimates must decide which scenario seems most likely. If none of the results seem plausible, the assessment may proceed without the bycatch estimates included but with the caveat that results may be biased or contain additional uncertainty due to unknown levels of missing catch.

Unlike in the past, it is no longer acceptable to assume discards represent an unimportant removal from a stock. Under certain circumstances, discarding can and does impose uncertainty and potential bias on both estimates of current stock status and predictions of future stock conditions. This bias and error can make proper management even more difficult. While qualitative analyses of discard impacts are readily available at this time, providing the quantitative estimates that are necessary to improving stock assessments will require significant additional research and monitoring. Further, due to the extreme variation of discard characteristics, such efforts must be directed to specific fisheries and areas and must represent a long-term commitment.

6.3.6 Bycatch Impacts on the Stock Assessment of Non-Target Species

Although many species are caught as bycatch in the estuarine shrimp trawl fishery, four species, blue crab, weakfish, Atlantic croaker, and spot have, since the first studies were conducted in the 1950s and continuing to the present, accounted for the bulk of the bycatch. The bycatch of southern flounder (*Paralichthys lethostigma*) is of concern due to its overfished status. Because these five species and many other species of commercially and recreationally important finfish spend a portion of their lives in estuarine waters, bycatch in North Carolina's estuarine shrimp trawl fisheries, mainly ages 0 and 1, may have the potential to impact the stocks of these species. Natural mortality at these stages is high; however, it is believed that bycatch may adversely increase overall mortality potential (Diamond et al. 2010). Possible impacts from this increased mortality include reducing spawning stock potential and reduced yields to the fisheries (West et al. 1994). Due to the magnitude of the bycatch of these species and their importance to other commercial and recreational fisheries, a brief summary of their stock status is presented below.

However, it should be noted that resource conservation issues for these species are contained and principally evaluated in species specific management plans, from either solely North Carolina jurisdictional FMPs like blue crab and southern flounder, or coast wide ASMFC plans for weakfish, spot, and Atlantic croaker. These latter three species are also species that are covered in the North Carolina Interjurisdictional (IJ) FMP that selectively adopts management measures contained in approved federal council or ASMFC FMPs by reference as minimum standards. North Carolina in the IJ FMP acknowledges the expertise and process employed in the development of the council and ASMFC plans and that a coast wide perspective and coordinated management actions are paramount for stocks that are not within a single state's jurisdiction. So while one of the stated goals of this shrimp amendment is to "minimize harvest

of non-target species of finfish and crustaceans and protected, threatened, and endangered species, the extent and benefit of actions to be considered should be viewed in this broader coast wide context. Due to all the aforementioned lack of and limitations with shrimp trawl discard data, none of the ASMFC FMPs have called for additional restrictions in state's shrimp trawl fisheries.

6.3.6.1 Blue Crab Status

Reduced landings of hard blue crabs during 2000-2002 and 2005-2007, following record-high landings observed during 1996-1999 have caused concern for blue crab stocks. The 2011 fishery yielded the fifth lowest landings during the 10-year period of 2002-2011. Harvest from the Pamlico/Core sounds and tributaries increased, but continue to remain significantly below historical levels. Results of the 2011 Traffic Light Stock Assessment suggest the North Carolina blue crab stock is not overfished. However, overfishing cannot be determined at this time because data are insufficient for estimating reliable fishing mortality rates. Discard reductions of blue crabs in non-target fisheries were originally reviewed in Amendment 1 of the Blue Crab FMP; however, due to the limited amount of shrimp trawl data, discard estimates were not incorporated into the stock assessment. Amendment 2 of the Blue Crab FMP indicates there is still some concern for discards in the shrimp trawl fishery and that more fishery-dependent data are needed. The extent of delayed mortality of blue crabs in the shrimp trawl fishery was of particular concern. Amendment 2 also cites that limited tow times would help reduce mortality of sublegal crab bycatch.

The bycatch of blue crabs in the shrimp trawl fishery is of concern due to the mortality (immediate and delayed) and physical injury of culled individuals. Johnson (2006) notes mortality of crabs caught in shrimp trawls is thought to primarily to occur in the nets during trawling or the hauling back of nets. In a study of post-harvest mortality and physical injury to trawl and pot-caught crabs, McKenna and Camp (1992) found the incidence of physical injury to those crabs was similar; that is, the appendages were the most frequently damaged area. The chelipeds (pincher appendages) were the most frequently damaged appendage for both gear types; crab pot-crabs showed a greater loss than did trawl-caught crabs, 52% and 33%, respectively. There were no differences between the survival rates of damaged crabs and undamaged crabs. These findings are in agreement with those of Smith and Howell (1987), who found the appendages were the most frequently damaged structure in pot and trawl-caught American lobsters in Long Island Sound, N.Y. Additionally, Wassenberg and Hill (1989) found that 99% of the trawl-induced damage to sand crabs was restricted to the appendages.

The only observed cases of immediate mortality in crab-trawl-caught crabs occurred in June (McKenna and Camp 1992). During this trip, a large number of paper shell and soft crabs were killed in the trawling process. These findings agree with those of other investigators who found that immediate mortality in trawl-caught crustaceans was almost entirely limited to soft or paper stage individuals (Smith and Howell 1987; Wassenberg and Hill 1989).

Factors affecting the level of delayed mortality in crustaceans are temperature, exposure time, amount and level of physical injury, and total catch biomass (Smith and Howell 1987; Wassenberg and Hill 1989). Overall survival rates for trawl-caught crabs was 64%, while 93% of the crab-pot crabs survived (McKenna and Camp 1992). The effects of temperature were readily apparent; survival rates for trawl-caught crabs during the winter months were 74%, while the individuals caught in June had a 20% survival rate.

6.3.6.2 Weakfish Status

Weakfish are managed under the ASMFC plan as a single stock throughout their coastal range. All states from Massachusetts to Florida and the Potomac River Fisheries Commission have a declared interest in the Weakfish FMP. Responsibility for the FMP is assigned to the ASMFC Weakfish Management Board, Plan Review Team, Technical Committee, Stock Assessment Sub-Committee and Advisory Panel. The FMP for weakfish was adopted in 1985 by the ASMFC. Weakfish are currently managed under Addendum IV to Amendment #4 to the ASMFC FMP, adopted in November, 2009. Due to the depleted stock size, Addendum IV requires management measures aimed at aiding in any recovery of the weakfish stock. Addendum IV recognizes that natural mortality, rather than fishing mortality, appears to be the primary culprit in the current stock decline. As a result, the ASMFC Weakfish Management Board has implemented strict coastwide harvest limits that are intended to limit fishing pressure to aid in the recovery should conditions governing the high natural mortality subside. Amendment #4 to the FMP was designed to manage the recovered fishery and similar to Amendment #3 it had specific restrictions including: Bycatch Reduction Devices for shrimp trawls and escape panels in long haul seines, 12 inch commercial minimum size limit for all fisheries but estuarine pound net and long haul seine fisheries (seasonal 10 inch size limit), minimum mesh sizes for gill nets and trawls, and a recreational bag and size limit (currently one fish at 12 inches). According to Amendment #3 to the weakfish FMP, discard losses in the South Atlantic shrimp trawl fishery significantly increased mortality of age-0 and 1 weakfish, and both yield and spawning potential could be increased if these age classes were protected (ASMFC 1996c). BRD requirements for shrimp fisheries in the South Atlantic were introduced specifically to reduce mortality of age-0 and age-1 weakfish 30% to 40%. In addition, North Carolina is still required to maintain a closure of the area south of Cape Hatteras to flynets. One major change in Amendment #4 was an increase in the bycatch allowance for commercial fisheries from 150 pounds to 300 pounds provided that there is at least equal poundage of other species on board the vessel. In North Carolina this bycatch provision applies to gears used that do not meet the minimum mesh size requirements of Amendment #4 designed to prevent weakfish bycatch.

The 1996 stock assessment for weakfish represents one of the few examples of use of specific bycatch information in the stock assessment process. Vaughan et al. (1991) ran analyses based on different multipliers (0.0, 0.25, 0.50, 1.0) of weakfish to shrimp landings. They made the assumption that bycatch was proportional to shrimp landings and that this ratio was constant over time. However, these proportions are variable depending on location and time of year. Generally, weakfish to shrimp ratios in weight appear to range from 0.1:1 to 0.5:1.

Based on Vaughan et al. (1991), VPAs for 1982-1987 with natural mortality $M=0.3$ and without bycatch estimates, fishing mortality estimates (F) for age-0 were very small (around 0.015), while those for age-1 were much larger and increasing. However, estimates of fishing mortality at age-0 and age-1 increased values with increasing bycatch multipliers. For example, at the lowest bycatch multiplier (0.25) the estimate of F_{age} ranged from 0.3 to 0.7, a much higher value than the $F=0.015$ in the initial analysis. Initial yield-per-recruit estimates without bycatch showed almost no gain from raising the age at entry from age-0.25 to age-1, but moderate gains from age-1 to age-2 and from age-2 to age-3. However, when the bycatch multipliers entered the analysis, a significant reduction in estimated yield-per-recruit was found, and a significant gain was demonstrated from raising the age at entry from age-0 to age-1 and from age-1 to age-2. There were moderate gains from raising the age at entry from age-2 to age-3. Maximum spawning stock potential (without bycatch) showed small declines, but when the

bycatch multipliers were introduced, significant reductions were estimated. The 0.25 multiplier showed a small but significant gain in spawning stock potential when the age at entry was raised from age-0 to age-1 and even higher gains from increasing the age at entry to age-2.

The assumptions made in Vaughan et al. (1991) created the effect that trends in weakfish discards reflected shrimp harvest, in other words, the more shrimp caught, the more weakfish discarded. Another assumption that may be applied to weakfish stock estimates is to consider bycatch of weakfish as a function of weakfish abundance and shrimp fishing effort, but not shrimp catch. Gibson (1994) used shrimp trawl effort rather than shrimp catch and produced new estimates of weakfish bycatch in the shrimp trawl fishery. Gibson (1994) found nearly 90% of weakfish discards were age-0 fish; however, these estimates were imprecise. Discard numbers were 50% higher on average compared to a later assessment by Vaughan (1994) and showed opposite trends. Gibson's (1994) fishing mortality rates were also slightly higher than Vaughan's method and agreed with the trends in spawning stock biomass and the decline in recruitment strength.

The effect of shrimp trawl discards on the stock biomass of weakfish is still uncertain. In the 2009 ASMFC Weakfish Stock Assessment Report several methods to estimate discards were investigated, including effort based estimates, regression based estimates, and ratio extrapolation (ASMFC 2009). It was determined that there was not enough effort data for all states and years to do effort based estimations. Regression analysis was also considered inappropriate for use due to the poor fit of the predictive models. Seasonal, annual, and multi-year ratio methods were investigated as well. The multi-year estimate was found to provide the most reliable discard estimate due to the high interannual variability and large standard errors associated with the short time groupings. A positive linear relationship between the response and explanatory variable are needed for ratio extrapolation methods to work best; however, there was no evidence of such a relationship in several of the gear-species combinations investigated. It is also important to note that discard data in the southern region (North Carolina to Florida) were considered insignificant and not evaluated. Commercial discards were only evaluated for the northern region and later found to be bias by two reviewers who were concerned that the methods used to estimate discards could result in substantial uncertainty. One reviewer was concerned that discards were overestimated because multiplying the discard ratio for a given target species by total harvest of species includes harvest when that species was not the target species. The second reviewer was concerned that the gear-species combinations were too limited, missing historic fisheries with large weakfish discards. The Weakfish Technical Committee is aware of these potential sources of bias with commercial discards, citing a lack of observer data. The report also indicated that fishing mortality and discard mortality have remained low in recent years and the recent drop in weakfish productivity did not coincide with rising exploitation; however, there was a strong positive correlation between the recent rise in weakfish juvenile mortality and rising striped bass and spiny dogfish abundance (ASMFC 2009). The recent emergence of a weakfish bottleneck at age-0 is thought to be largely due to enhanced predation by these two species and not due to a surge in unreported landings and discards.

6.3.6.3 Atlantic Croaker Status

A peer-reviewed stock assessment was completed by ASMFC Technical Committee and accepted by the South Atlantic State/Federal Fisheries Management Board in August 2010. The assessment used data from both Mid- Atlantic and South Atlantic regions to produce a single, coast wide assessment, indicating that Atlantic croaker is not experiencing overfishing and is likely not overfished. Trends in independent data indicate biomass has been increasing and

more, older fish have been observed in the catch since the late 1980s. Absolute estimates of spawning stock biomass and fishing mortality were not given because of uncertainty in the assessment resulting from inadequate data on the magnitude of croaker discards in the South Atlantic shrimp trawl fishery. The 2010 assessment also indicates that while there are no monitoring programs in place to document the annual magnitude of discards, rough estimates of shrimp trawl discards suggest a general decline since 1995. Rough estimates of shrimp trawl discards were also used to conduct sensitivity runs of the model to determine how Spawning Stock Biomass (SSB) can be apportioned to different sources of uncertainty in the model input. Sensitivity runs of the model including rough estimates of shrimp trawl discards did not change the overall trend in SSB. Overall, the Review Panel concluded that the stock is not in trouble, noting that biomass has been on the rise, commercial catches are stable, and discards from the shrimp trawl fishery have been much reduced.

The 2004 ASMFC stock assessment also determined the stock was not overfished and overfishing was not occurring in the Mid-Atlantic region (North Carolina and north). The stock assessment showed both fishing mortality and spawning stock biomass for the Mid-Atlantic region exhibiting a cyclical trend over the time series. The Atlantic croaker stock status for the South Atlantic region (South Carolina and south) was unknown at the time and thought to make up a relatively small component of the total stock biomass. However, fishing pressure was below the target MSY and the spawning stock biomass was well above the target level. Much like the 2010 assessment, shrimp trawl bycatch was not included in the final model due to the uncertainty of the bycatch data. Model runs were completed including shrimp trawl bycatch to show the effects this fishery has on the stock even with the limited data. Sensitivity analysis evaluating the inclusion and non-inclusion of shrimp bycatch estimates, indicate that SSB_{msy} estimates are sensitive to the inclusion of Atlantic croaker caught as shrimp bycatch. However, increased SSB_{msy} estimates are also accompanied by higher total SSB estimates. The ratio of $SSB_{2002}:SSB_{msy}$ when preliminary estimates of shrimp bycatch was included indicated that the stock was unlikely to be below the threshold estimates. Also, biomass reference points from the simulation runs including shrimp trawl bycatch indicated higher SSB_{msy} values and the lower estimates of $SSB_{2002}:SSB_{msy}$ than those obtained for the base model. The range of estimates for F_{msy} (~0.4) was similar to the base model (~0.39). SSB_{msy} estimates from the simulation ranged from 48,000 to 67,000 MT with a median of 56,467 MT and were much higher than those for the base run (28,932 MT).

Diamond-Tissue (1999b) showed that by separating Atlantic croaker into different life history stages, she could examine the effects on the population of mortality at different life stages. This approach provides some insight into population changes that may be caused by bycatch. She used a stage-within age based matrix model. In this type of model, a stage-based model of the first year of life was combined with an age-based model of adults. The first year (age-0) was divided into six stages separated by biologically significant events based on major changes of morphology or habitat. Within each life stage model, she examined the population growth rate, the stable age distribution, and the elasticity (sensitivity) of the population to increases and decreases of mortality in each life stage. In order to determine elasticity of the population, baseline matrices were constructed from published and unpublished data on the life history of Atlantic croaker. Of all the data examined, only late-stage juvenile and adult mortality rates were shown to be affected anthropomorphically (fishing mortality). She then examined the trade-offs between regulating directed fisheries for adults and regulating fisheries that cause mortality on late juveniles. These simulations varied mortality from the baseline values established from data in the literature.

In the Atlantic and the Gulf of Mexico areas, the baseline model showed 99% of the population to be in the first year of life. The elasticity analyses showed that croaker were more sensitive to survival during age-0 than other age classes. In both regions, croaker were more sensitive to changes in fertility of age-1 fish (the age of first full reproduction) than fertility in any other year. In the analyses of other life stages, the south Atlantic population was more sensitive to fecundity than the Gulf population, but both populations were most sensitive to mortality in the oceanic larval stage than in any other stage.

By altering the late stage juvenile mortality from 10% to 200% of the baseline rate while keeping adult mortality constant, Gulf population growth rates decreased. Changing the adult mortality rates yielded similar effects. If juvenile or adult mortality was decreased, population growth rates increased. In the south Atlantic, the model was much more reactive to change. As in the Gulf, changing the mortality rate from 10% to 200% of the baseline caused population growth rates to decrease. Changing the adult mortality rate had a much larger effect on population growth rates.

Diamond-Tissue's (1999b) model results indicate that bycatch mortality at the estimated levels is not the most important factor affecting Atlantic croaker populations in the Gulf of Mexico or in the south Atlantic areas, although it can have a large negative impact on population growth rates. Both populations were most sensitive to mortality during the ocean's larval stage, followed by mortality of estuarine larvae and adults in the Gulf, and by early juvenile and adult mortality in the Atlantic. Bycatch mortality would have to be 2.5 times higher in the Gulf of Mexico and about 3.5 times higher in the south Atlantic for bycatch mortality to be the most important factor affecting population growth rate. Simulations showed that reducing late juvenile mortality by 1% and adult mortality by 3% of the baseline would stabilize the Atlantic population.

6.3.6.4 Spot Status

Commercial landings and effort have generally been decreasing in the major fisheries. This decrease accelerated in 2006 and 2007 and 2010 showed a historical low. Commercial catches in 2011 increased 64% from 2010. Catch per unit effort in the inshore gill net and offshore gillnet fisheries increased in 2011 relative to 2010. The catch per unit effort in the long haul fishery decreased in 2011 relative to 2010. Recreational landings have increased 58% from a historical low in 2010 and the mean catch per angler trip also increased. Given that spot are a short-lived species; these types of fluctuations in landings are not uncommon (Mercer 1987).

The ASMFC FMP for spot, adopted in 1987 included the states from Delaware through Florida. However, a formal coastwise spot stock assessment has not been conducted. Concerns addressed in the 1987 FMP included growth overfishing, as indicated by the dominance of unmarketable fish being landed, especially in the shrimp trawl and flynet fisheries, but also in the sciaenid pound net and long haul seine fisheries. North Carolina has addressed these concerns. North Carolina has tested bycatch reduction devices in the shrimp trawl fishery and achieved finfish reductions of 50% to 70% with little loss of shrimp. Finfish reduction devices have been required in all shrimp trawls since the fall of 1992 (15A NCAC 3J.0104) and escape panels have been required (since April 1999) in the bunt nets of long haul seines in an area south and west of Bluff Shoals in the Pamlico Sound (15A NCAC 03J.0109). The North Carolina Marine Fisheries Commission modified this rule in August 2003 to include more specific wording on installation and placement of the culling panels. Additionally, in the North Carolina flynet fishery, where a large portion of the spot catch occurs, there is a requirement for a minimum tailbag mesh of 3 1/2 inch diamond or 3 inch square. Furthermore, the state of North Carolina has banned flynet fishing in waters south of Cape Hatteras.

The 2010 review of the spot FMP indicates that the largest bycatch component for spot comes from the South Atlantic shrimp trawl fishery (ASMFC 2011a). The review also indicates that the non-quantifiable incidental bycatch and discard mortality of small spot in non-directed fisheries is an extremely problematic issue, citing limited discard data as one of the major problems. While the magnitude of discards from the shrimp trawl fishery is still highly uncertain, Peuser (1996) indicated that spot could account for as much as 80% of the catch by weight and 60% by number and that spot landed in these trawls are generally small and represent only one or two age classes. High priority research and monitoring recommendations listed in the 2010 ASMFC FMP review include: state monitoring and reporting on the extent of unutilized bycatch and fishing mortality on age-0 fish in fisheries that take significant numbers of spot and an evaluation of the effects of mandated bycatch reduction devices on spot catch in states with significant commercial harvest (ASMFC 2011). The 2011 Omnibus Amendment to the Interstate FMPs for Spanish mackerel, spot, and spotted seatrout states that until adequate discard estimates from the South Atlantic shrimp trawl fishery, as well as several other state fisheries that incidentally catch spot are available, a stock assessment cannot be initiated (ASMFC 2011b).

6.3.6.5 Southern Flounder Status

Based on the NCDMF 2009 stock assessment, the southern flounder stock is overfished and overfishing is occurring (Takade-Heumacher and Batsavage 2009). These findings concur with those of the 2004 stock assessment indicating that the southern flounder stock has been overfished for at least the past decade if not longer. The 2004 stock status catch-at-age indicated extremely high exploitation of age-1 and age-2 southern flounder (57% and 38% respectively), that was a concern since only 59% of age-1 and 79% of age-2 female southern flounder were sexually mature. With the addition of 1.0 million age 0-2 fish from the shrimp trawl bycatch, exploitation of juvenile southern flounder was more pronounced (19%, 52%, and 26% respectively). In absence of quantifiable observer data, the Pamlico Sound trawl survey (Program 195) was used as a proxy for estimating shrimp trawl bycatch of southern flounder in the 2006 Shrimp FMP. This data was then used to conduct a catch curve analysis and a Virtual Population Analysis (VPA) to compare the original southern flounder stock assessment with the results that included the shrimp trawl bycatch-at-age. Catch curve analysis conducted for ages 1-6 revealed that when bycatch estimates were added to the original catch-at-age model the average total mortality increased from 2.30 to 2.75, fishing mortality rate increased from 1.89 to 2.35, and fishing exploitation rate increased from 85% to 90%. Again using the same data, VPA analysis revealed that when shrimp trawl bycatch catch-at-age was added to the original data set, the fishing mortality rate did not change. At the time of the 2006 Shrimp FMP catch curve analysis and VPA indicated minimal to no differences in the affects upon the high exploitation rate of southern flounder through the fishery.

While little has changed in the availability of adequate discard data since the 2004 flounder stock assessment, aging samples from the ocean, a new January 1 birth date and a new forward calculating model (ASAP2) was used to estimated mortality and abundance. While this model was configured using discard at age matrices for the commercial gill net and recreational hook and line fishery, it was not possible to calculate discards for the shrimp trawl fishery as well as the recreational gig fishery. Thus, the current assessment could not account for all sources of removals of age-0 and age-1 fish. The inability to estimate shrimp trawl bycatch, which would consist primarily of age-0 fish, could lead to a systematic overestimation of young fish, confounding estimates of total abundance. This problem could be further compounded if there have been changes in the amount of fish caught as bycatch over time. The 2009 stock

assessment stresses the need for more discard information to be collected from the shrimp trawl fishery as well as other fisheries.

The 2006 Shrimp FMP took measures to address the issue of discarded sublegal flounder in the shrimp trawl fishery as directed in the approved 2004 Southern Flounder FMP recommendation 10.8.4 that stated “Recommend that the Shrimp FMP address the issue of the discard of sublegal southern flounder in the shrimp trawl fishery.” The 2006 Shrimp FMP closed upper portions of the Neuse, Pamlico, and Pungo rivers to shrimp trawling to minimize southern flounder bycatch in the shrimp trawl fishery and implemented a maximum combined 90 ft. headrope length in the mouths of the Pamlico and Neuse rivers and all of Bay River.

6.3.6.6 Summary

While the bycatch of these species has been a concern to managers since the 1950s only recently has the effect of bycatch mortality been examined. This is due in large part to the lack of adequate assessment data for these and most other species. The bycatch of weakfish in the shrimp trawl fishery has been identified as a major source of mortality for this species; however, through the use of BRDs and other management measures this mortality has been reduced. The bycatch mortality of Atlantic croaker may need to be 3.5 times higher to be the most important factor affecting population growth rate for this species (Diamond et al. 2010). It is unclear what specific impacts shrimp trawl bycatch has on the overall stock status of southern flounder given this species suppressed stock scenario. These analyses show the importance of combining adequate assessment data with the appropriate management measures to insure healthy stocks.

Obtaining unbiased and precise estimates of bycatch clearly represents a significant technical and financial challenge. However, for many target and non-target trawl species, these data may be critical to determining exploitation status and the effectiveness of management measures. The importance of discard estimates to a given species will depend on the magnitude of the discards, the fraction of the total catch represented by discards, and the variability in discard losses over time (Murawski 1995). Because of the unique nature of North Carolina’s estuarine habitats and the fact that bycatch rates vary by fishery, season, and area, North Carolina cannot depend on research efforts of the NMFS or other states in addressing bycatch losses.

While the effect that shrimp trawl bycatch has on finfish stocks is unknown, the reduction or elimination of the bycatch has a number of important implications. The reduction of fishing mortality on juvenile finfish stocks might result in more individuals recruiting into the commercial and recreational fisheries. From the commercial fisherman's perspective, less time will be spent culling the catch, fuel savings might be realized due to lower biomass in the nets, and the quality of shrimp catch should be improved. Methods and management options to reduce bycatch are discussed below.

6.3.7 North Carolina Management Strategies to Reduce Bycatch

6.3.7.1 Tailbag Mesh Size

Trawl minimum mesh size regulations are the principal method used to regulate fishing mortality on fish stocks (Smolowitz 1983). The control of net selectivity is the preferred management tool in lieu of other more stringent regulations such as temporal and spatial closures, quotas, or limited entry. The underlying principle of mesh size regulations is that undersized fish will

escape from the tailbag, survive, and become part of the future spawning biomass. Recent studies on the survival of fish escaping from tailbags (Main and Sangster 1988; J.T. DeAlteris, Univ. Rhode Island, Personal Communication; Simpson 1990) support the use of minimum mesh sizes as a means of reducing fishing mortality on juvenile fish. In North Carolina, the current minimum mesh size for a shrimp trawl, including the tailbag, is 1.5 inches (15A NCAC 03L .0103 (1)).

In 1949 Roelofs (1950) tested three tailbag sizes (2", 2 ¼", and 2 ½") in Pamlico Sound. Reduction rates were reported for spot, Atlantic croaker, and shrimp. Reduction rates for spot were 12.2% (2"), 42.8% (2 ¼"), and 50.5% (2 ½"). Atlantic croaker reductions were 24.8% (2"), 59% (2 ¼"), and 38% (2 ½"). Overall shrimp reduction rates were 5.6% (2"), 14.9% (2 ¼"), and 9.2% (2 ½"). In all cases, reduction rates were influenced by the size of the fish and shrimp.

The DMF conducted some preliminary tests on diamond tailbag mesh size in 1991, and square mesh tailbags in 2000. The two tailbags tested in 1991 were 1 5/8" stretched mesh (13/16" bar), and 2" stretched mesh (1" bar) tested against a 1 ½" standard stretched mesh tailbag. In 2000 a 1 ½" stretched square mesh tailbag was tested against a 1 ½" stretched mesh diamond tailbag. Results of the 1991 tests indicated that there was no apparent difference between the catches in the control net and the 1 5/8" tailbag. Tests with the 2" stretched mesh tailbag did show a difference between catch rates of spot (-46%), Atlantic croaker (-22%), total fish (-37%) and total catch (-18%). However, as was the case with the 1 5/8" tailbag not enough tows were made to test for significance differences. Tests conducted in 2000 with the 1 ½" square mesh tailbag showed a significant reduction in the catch of young of the year (YOY) weakfish (-51%), and bay whiff (-32%).

Brown (2010) compared the catch rates of modified (experimental) otter trawls in the Neuse River and Pamlico Sound. Experimental otter trawls (1 ¾" stretch mesh hung on diamond, 1 ¾" stretch mesh hung on square, 2" stretch mesh hung on square) were tested against a standard (1 ½" stretch mesh hung on the diamond) tail bag; all nets were equipped with standard TEDs. Results indicated that the catch of shrimp by weight was virtually identical in both the standard net and the experimental 1 ¾" inch stretch net that was hung on the diamond. However, testing did show a difference between catch rates of croaker (-16%), spot (-50%), flounder species (-13%) and weakfish (-2%). Tests with the 1 ¾" stretch mesh, hung on square resulted in significant reductions in croaker (-76%), spot (-77%) and weakfish (-46%). Tests with the 2" stretch mesh hung on square resulted in significant reductions in croaker (-69%), spot (-82%) and weakfish (-2%). The mean weight (kg) of bycatch in the 1 ¾" stretch mesh net hung on diamond was not significantly different from the standard net, however both the 1 ¾" stretch mesh net hung on square and the 2" stretch mesh hung on square caught significantly less bycatch compared to the standard net during the trials.

6.3.7.2 Bycatch Reduction Devices

During the 1980s the DMF and NMFS conducted studies on shrimp retention rates for various [TEDs (1985 - 1986 DMF unpublished data, and 1988 - 1989 NMFS unpublished data)], and started work on identifying means to reduce finfish bycatch in the shrimp trawl fishery (Pearce et al. 1988; Holland 1988). The 1991 Weakfish FMP recommended that South Atlantic states implement programs to reduce bycatch mortality of weakfish in their shrimp trawl fisheries by 40% by January 1, 1994. Based on results obtained during development work in 1990 and 1991 on DMF research vessels and operational testing conducted aboard a commercial trawler in 1992, the DMF required all shrimp trawlers working in state waters to equip their nets with functional fish excluders in October 1992. However, North Carolina was the only state that

required finfish excluders. On October 20, 1994 Amendment 2 of the weakfish FMP was passed. This amendment again required all South Atlantic states (NC-FL) to implement management measures to achieve the 40% reduction in bycatch of weakfish in the shrimp trawl fisheries by the start of the 1996 shrimping season.

Starting in 1992 DMF staff has worked with fishermen and used its own research vessel to test many different BRDs in a variety of waterbodies, seasons, and under various tidal and environmental conditions. The goal of the testing was to find devices, which maximized finfish reduction, minimized shrimp loss and meet the requirements of Amendments 1 and 2 of the weakfish FMP. The effectiveness of this gear in reducing weakfish and other fish species is a function of the size of the FFE opening and the placement of the gear in the tailbag of the trawl. A minimum opening of 5 1/2" X 6 1/2" is required for the reduction of weakfish at the mandated level. Placement in the tailbag is a function of the distance the gear is placed from the tailbag tie-off and general location in the net (top, side, or bottom). The distance from the tailbag tie-off is expressed as a ratio, BRD length/tailbag length. Where BRD length is equal to the distance from the tailbag tie-off to the opening of the FFE, and tailbag length is the length of the tailbag from the tie-off rings to the beginning of the tailbag (excluding any extension). To obtain a 40% value in weakfish reduction this ratio cannot exceed 0.65:1. Regardless of the tailbag length, the maximum mesh count cannot exceed 68 meshes from the tie-off rings. Data collected during the development of FFEs indicated that maximum reduction of weakfish was obtained when the FFE was placed 15 meshes down from to the side of the tailbag (Figure 6.8).

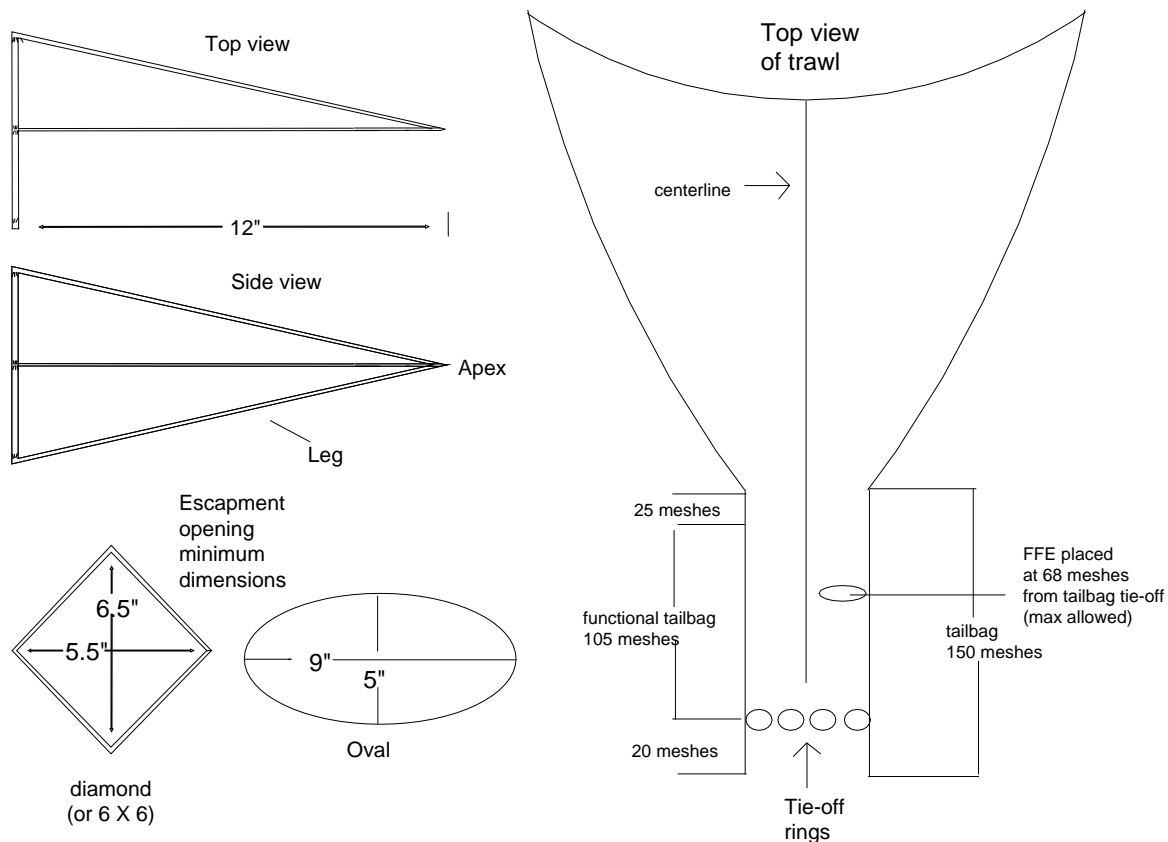


Figure 6.8 Diagram of Florida Fish Excluder (FFE) tested in North Carolina waters.

The large mesh extended funnel [LMEF (Figure 6.9)] is constructed from three sections of webbing. The forward piece is 62 meshes long, 120 meshes in circumference, 1 5/8" stretch mesh, #30 nylon twine. The center is made of 8" stretched mesh, 4 mm polyethylene, hung on the square. This section is five meshes long and 23 meshes in circumference. The rear section is similar to the first section except that it's 232 meshes long. A single hoop, constructed of 1/2" diameter plastic coated towing cable is sewn into the rear section of webbing, 4 meshes aft of the 8" webbing. This hoop is 30" in diameter. An accelerator funnel, constructed of 1 1/2", #24 depth stretched and heat set polyethylene webbing is attached to the forward section of small webbing. The funnel extends back past the 8" webbing and is reattached 4 meshes behind the hoop. Only seven meshes on top and seven meshes on the bottom are attached in the rear section. This device showed good potential in its ability to retain shrimp and exclude weakfish and other fish species. Overall this gear showed a -2% reduction in shrimp weight. Significant reduction in the weight of spot (-71%), sea mullet (-45%), Atlantic croaker (-63%), bluefish (-32%), weakfish (-50%), and total finfish (-55%) was observed with this gear.

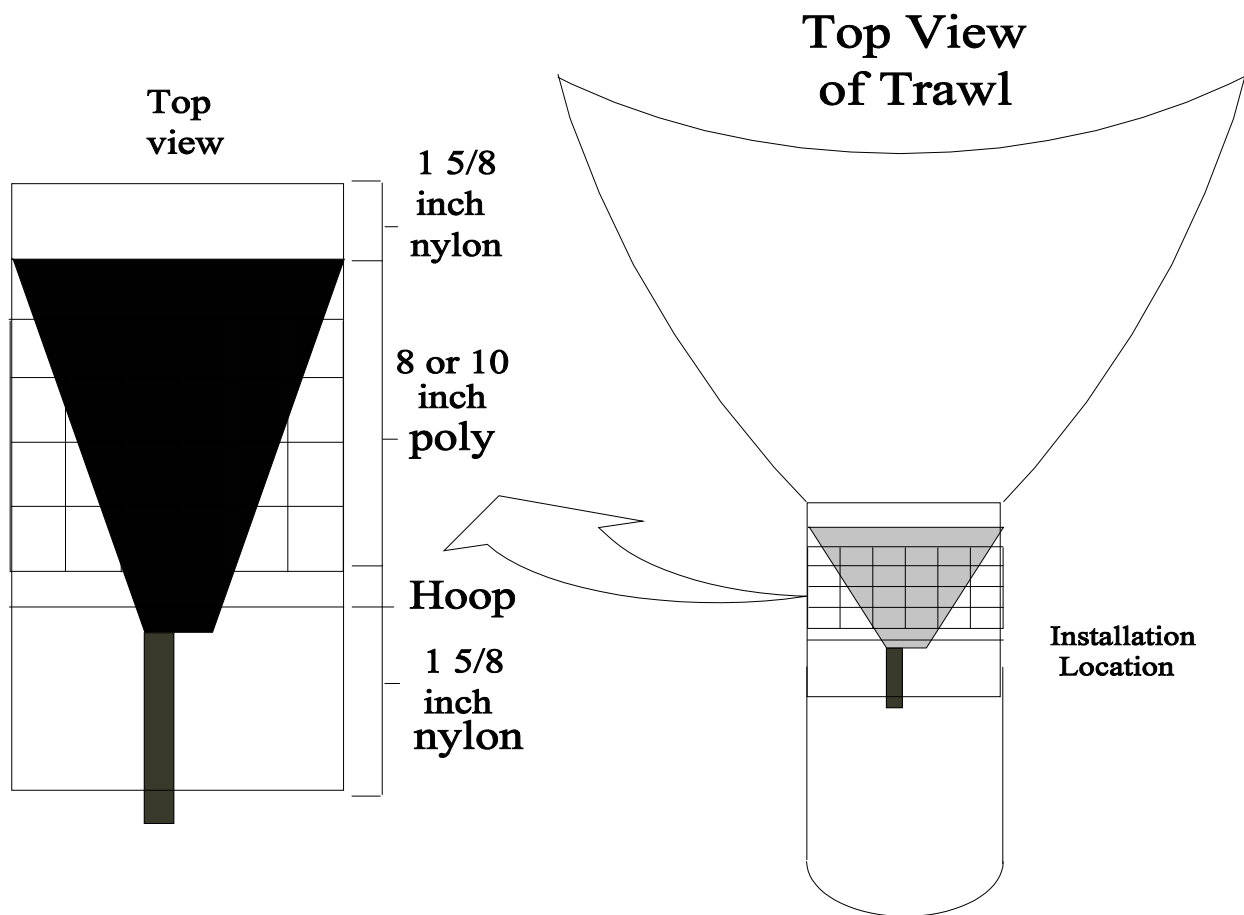


Figure 6.9 Diagram of large mesh extended funnel BRD (LMEF) tested in North Carolina.

During the summer of 1995, a series of tests with a modified large mesh funnel excluder (LMFE; Figure 6.10) was conducted using the R/V Carolina Coast. This device consists of an extension of 4" stretched mesh, #60 nylon, hung on the square (50 meshes in circumference and 12 meshes long). Hoops of 1/2" combination cable are attached to both ends of the 4" extension. An accelerator funnel made of 1 7/8" stretched mesh, #15 nylon, runs through the 4" escapement webbing into the tailbag (15 meshes beyond the escapement webbing). The aft

end of the funnel is pulled tight by bungee cord attached at the top and bottom of the funnels end. The accelerator funnel is constructed from two pieces of webbing, 49 meshes (points) at the large end, 30 meshes long and cut on a 2 to 1 taper. The device was installed immediately behind the TED (mini-super shooter). Shrimp catches were reduced by 12% in the MLMEF equipped net. Significant reductions in total finfish (-24%), and total catch (-23%) weight was also observed. Since there was no reduction in weakfish weight, the accelerator funnel was modified in an attempt to increase reduction rates. The original funnel was replaced with an accelerator funnel, constructed of ½", #24 depth stretched and heat set polyethylene webbing cut on a 1 to 1 taper. This device was tested in Brunswick County in late August 1995. Significant reductions in the weight of weakfish (-58%), spot (-71%), and Atlantic croaker (-36%) were observed in the test net.

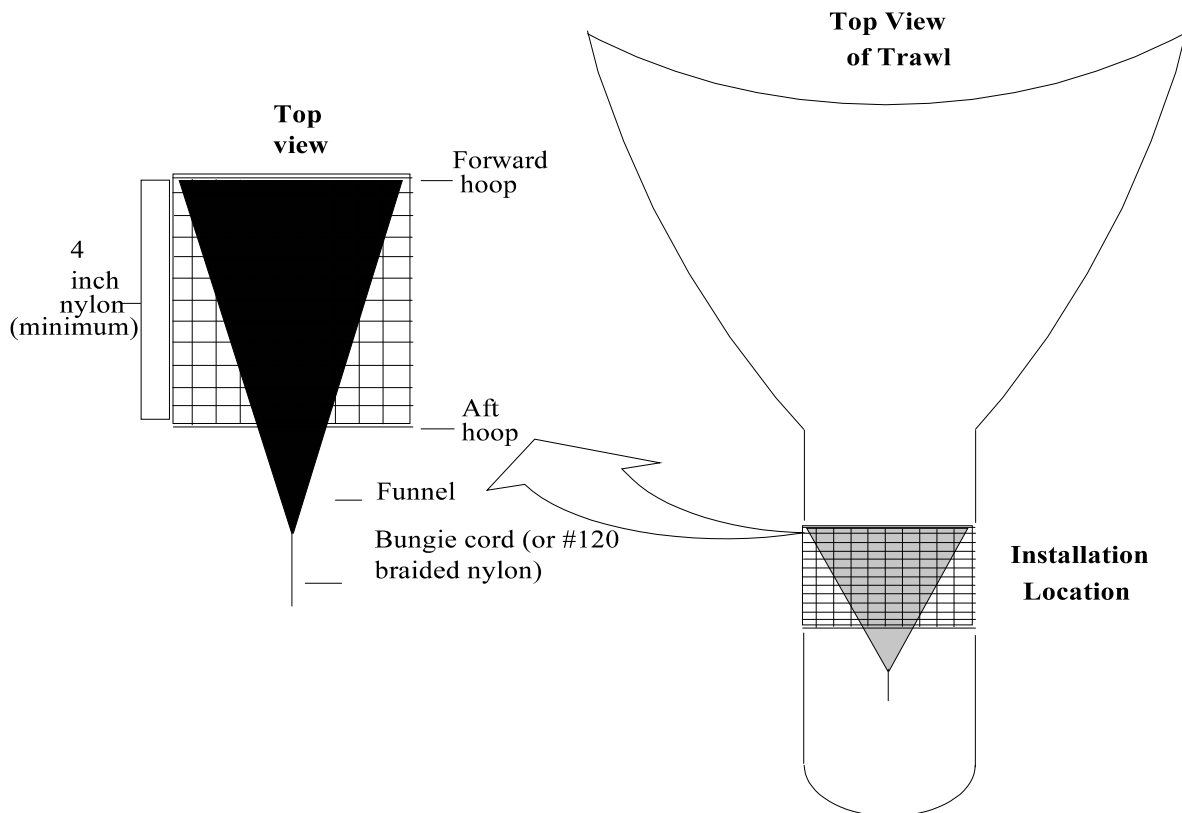


Figure 6.10 Diagram of modified large mesh funnel excluder (LMFE) tested in North Carolina.

From 1995 through 1996 gear development work continued using state funds. New designs developed by a local fisherman were examined for their ability to reduce weakfish. Designs tested were a 6" and 8" PVC excluder ["Sea Eagle" (Figure 6.11)]. The 6" "Sea Eagle" was tested 40 meshes above the tailbag tie-off at the top of the tailbag. Since the 6" "Sea Eagle" did not meet the minimum weakfish reduction requirement, tests were conducted with an 8" version of the device. Work with the 8" "Sea Eagle" showed that the weight of shrimp (-4.77%), weakfish (-57.80%), spot (-53.39%), Atlantic croaker (-56.70%), and total finfish (-54.33%) were significantly reduced with this gear.

In 1996, the MFC approved four BRDs for use in shrimp trawls. Proclamation SH-9-97, effective September 1, 1997, required shrimp trawlers to be equipped with one of the following approved designs: (1) a FFE measuring at least 5 1/2" x 6 1/2" (inside measurement) positioned no more than 19 meshes from the top centerline of the tailbag and located no more than 65%

up from the tailbag tie-off; (2) a large mesh funnel [8 or 10 inches stretched mesh]; (3) a modified large mesh funnel excluder; or (4) a circular excluder constructed of PVC material measuring at least eight inches in diameter, positioned no more than 15 meshes from the top centerline and located no more than 38% up from the tailbag tie-off.

Amendment 3 to the Weakfish FMP was approved in May 1996 and changed the BRD certification requirements demonstrate a 40% reduction in catch (by number) or 50% reduction in bycatch mortality of weakfish when compared to catch rates in a naked net. Amendment 4, approved in November 2002, extended these measures.

The South Atlantic Fishery Management Council also has bycatch reduction requirements in its Shrimp FMP. Shrimp Amendment 2, approved in 1996, was consistent with Weakfish Amendment 4. However, Shrimp Amendment 6, effective in 2006 altered the Shrimp Amendment 2 BRD certification requirements creating an inconsistency with Amendment 4 of the weakfish plan. Under the 2006 amendment, the certification of any new BRD now required a reduction in the total weight of finfish by at least 30%. This inconsistency was addressed in Addendum III. This change now allows more flexible testing of BRDs, and allows the South Atlantic Council to achieve an ecosystem approach in fisheries management. On May, 11 2012 NOAA certified two new BRD devices for use in the Gulf of Mexico and the South Atlantic. Both new devices are modifications to the composite panel BRD, one of the devices adds a square mesh panel in the cod-end and the other adds a “spooker” cone inside the cod-end behind the BRD. See Appendix 2 for detailed descriptions, specifications, recommended construction and installation instructions for certified BRDs.

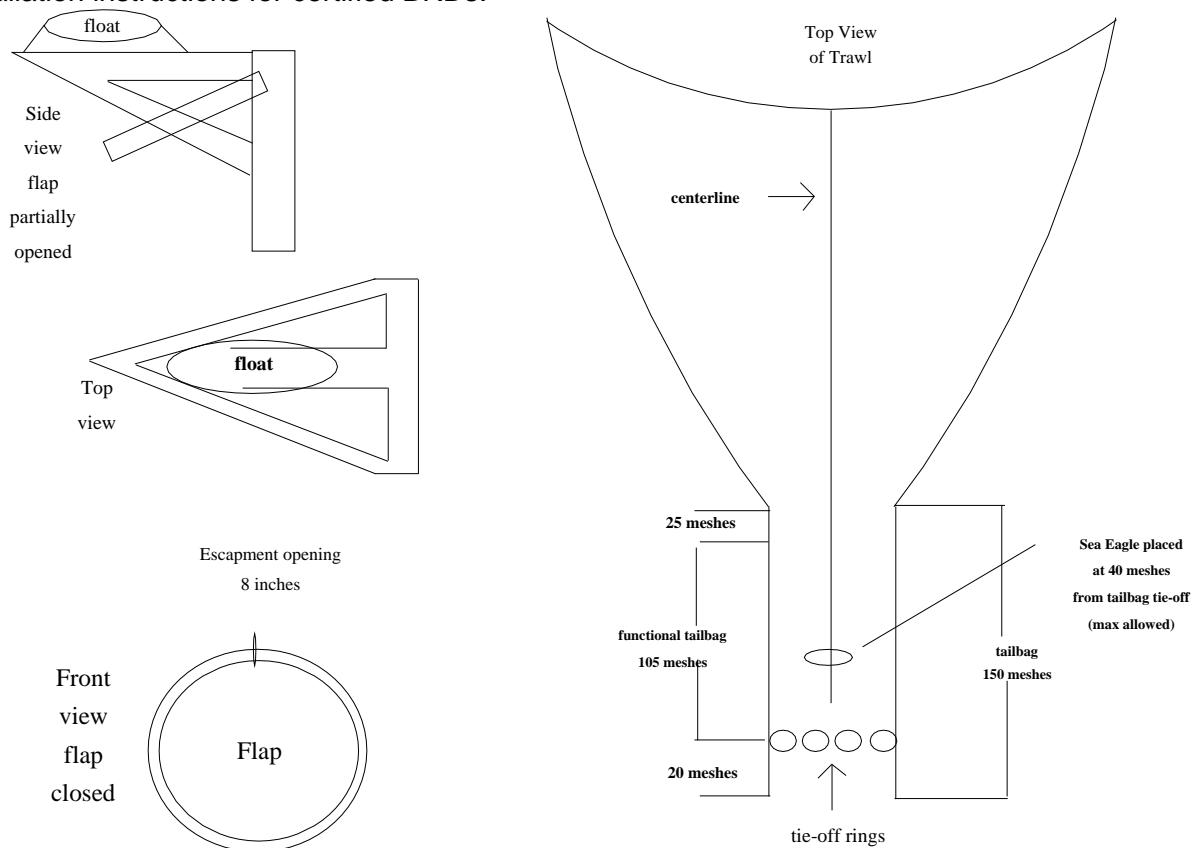


Figure 6.11. Diagram of “Sea Eagle” fish excluder tested in North Carolina.

Brown (2010) compared the effectiveness of two otter trawls equipped with a Jones-Davis BRD and a skylight panel against a standard trawl (1 ½" stretch mesh tailbag, hung on the diamond) in the Neuse River and Pamlico Sound. The Jones-Davis BRD is NMFS certified design that is similar to the expanded mesh and extended funnel BRDs, however it also has fish escape openings (windows) cut around a funnel and a webbing cone fish deflector installed behind the funnel. The skylight panel tested (4 inch stretch mesh, measuring 18 inches by 50 inches) is a commonly used Fish Escape Device (FED) that allows small fish to escape through the large mesh at the top of the net. The Jones-Davis BRD significantly reduced the mean weight of bycatch with no significant difference in the mean weights of shrimp. The Jones-David BRD was found to reduce the catch of spot by 52%. The skylight panel was also found to significantly reduce the mean weight of bycatch. There were significant reduction in the weight of spot (-12%) and flounder species (-46%) in the skylight net compared to the standard net. However, there was no significant difference in the mean weight of the shrimp catch between the net tested with the skylight panel and the standard net.

When the BRD requirements were adopted by the MFC, recreational and commercial shrimpers were considered as a single group. With the passage of the Recreational Commercial Gear License (RCGL) in 1997, recreational shrimpers were limited to a single shrimp trawl with a maximum headrope length of 26 feet and were prohibited from using mechanical retrieval methods. In 2009, mechanical retrieval was allowed however a TED was required in the trawl if mechanical retrieval was used. When testing FFEs, work was conducted aboard commercial trawlers with tow times of 60 minutes or longer. Since most RCGL holders have shorter tow times (20 minutes or less) FFEs placed 65% up from the tailbag tie-off most likely do not maximize finfish reduction. Additionally, gear testing conducted by the DMF in 1986 on the effects of light vs. heavy footrope chains on 20 foot trawls showed that bycatch of flounder, and crabs was higher in a heavily chained net while there was no difference in shrimp catches. To better reduce bycatch in RCGL shrimp trawls FFEs should be tested closer to the tailbag tie-off, and specific requirements for footrope chains should be examined.

6.3.7.3 Turtle Excluder Devices

Since 1992, the NMFS has required shrimp trawls to use TEDs to reduce the number of sea turtle strandings and incidental takes (see Protected Species section 7.2 for more information on TEDs). However, TEDs are also thought to reduce substantial amounts of bycatch as well. In Australia's northern prawn fishery, TEDs were shown to reduce the bycatch of smaller fish and invertebrates as well as reduce the number of larger sharks and rays by as much as 86% and 94%, respectively (Brewer et al. 2006). Broome et al. (2011) found that TEDs with reduced grid spacing (2 inches) was extremely effective in reducing total bycatch while maintaining minimal shrimp loss. The authors also noted that there were substantially more large rays, sharks, jelly balls and horseshoe crabs in the traditional 4 inch grid TED. Current federal law mandates that the maximum spacing between grids is four inches. In another study evaluating the performance of TEDs in the southeast Atlantic and Gulf of Mexico skimmer trawl fisheries, Price and Gearhart (2011) found that bycatch was significantly reduced for skimmers with TEDs. Reductions ranged from a mean of 40% to 98% for rays (primarily cownose rays) and 10% to 47% for finfish.

6.3.7.4 Alternate Gears

The development of species specific gears such as shrimp pots, pounds and cast nets could reduce finfish bycatch, minimize environmental concerns and conflicts with other fisheries, and could be more cost-effective than trawling. Even if these gears are ineffective in catching commercial quantities of shrimp, their use by recreational fishermen could result in a significant decrease in finfish bycatch.

Shrimp pots have been used in Pacific Northwest to harvest the British Columbia prawn (*Pandalus platyceros*) and in Maine to harvest northern shrimp [(*P. borealis*) Boutillier and Sloan 1987]. In 2003, the DMF became aware of the emergence of a new form of shrimp pot/trap with wings. These traps were constructed of 5/8" rigid hardware cloth and have two V-shaped wings to direct the shrimp into the traps. The wings of these pots were up to 50 feet in length and the distance between the ends of the wings measured approximately 80 feet. However, by definition these "traps" resemble pound nets more so than true pots; pound nets are defined as a trap consisting of a holding pen, one or more enclosures, lead or leaders, and stakes or anchors used to support the trap (15A NCAC 03I .0101 (3) (O)). Currently, DMF regulates shrimp traps under the same rules applied to pound nets. Thus, for a commercial shrimp pound net to be set, a permit must be issued by the DMF and the Fisheries Director shall issue a public notice of intent to consider assurance of a Pound Net Set Permit. In order for a site to be deemed suitable of a pound net set, the location shall not interfere with public navigation and be set a minimum of 300 yards from the permitted location of an existing pound net (see rule 15A NCAC 03J .0502 for full pound net permit requirements).

Brown (2006) evaluated a non-baited shrimp pound consisting of two stacked pots (18" by 18" by 36" of 5/8" mesh rigid galvanized hardware cloth) and two wings (leads) from Carteret County to Brunswick County to determine its potential as a recreational fishing gear. Brown shrimp were the predominant species, representing 96% of the total weight of the flood tide sets and 99% of the ebb tide sets. Bycatch consisted of blue crabs, white shrimp, and pinfish with mortality being extremely low. The gear was relatively inexpensive gear, easy to set up and operate. Results from this study led to the development of this gear as a RCGL gear.

Following the adoption of the 2006 Shrimp FMP, actions were taken limiting those who possess a RCGL to one shrimp pound net with each lead/wing measuring 10 feet or less with a minimum lead net mesh of 1 ½ inches, and enclosures constructed of net mesh 1 ¼ inches or greater and with all dimensions being 36 inches or less. Attendance is required at all times and all gear must be removed from the water when not being fished. The traps are most successful when set during a flood tide with one of the wings against a bulkhead or marsh shoreline. The devices are staked or anchored in place. The ends of the wings face away from the direction of the tide flow when deployed.

Sessions and Thorpe (2006) conducted a study to determine the catch potential and condition of shrimp and bycatch associated with commercial and RCGL shrimp pounds in southeastern North Carolina. The average shrimp catch rate was 4.5 lb/hour with a peak catch rate of 18.6 lb/hour. Sixteen finfish and six non-fish bycatch species were caught. Pinfish (66.4%) were the dominate fish species caught in terms of abundance, followed by menhaden (8.1%) and spot (5.3%). Commercially important finfish species (spot, croaker, pigfish, southern flounder and striped mullet) accounted for 8.1% of the total finfish bycatch by number. Blue crabs (93%) were the top non-fish by number, followed by shortfin squid (3%) and stone crabs (2.4%).

The overall finfish to shrimp ratio was 0.31:1 for commercial shrimp traps and 0.66: for RCGL shrimp traps. Overall finfish bycatch mortality was very low at 1.7% for commercial pounds and 0% for RCGL pounds.

The use of cast nets to harvest shrimp is a popular technique used by recreational fishermen in South Carolina and Georgia (Theiling 1988; Williams 1990), and more recently in North Carolina. Georgia also has a commercial shrimp cast netting fishery solely focused on harvesting shrimp for human consumption. Shrimp harvested by cast nets in North Carolina are typically used for bait; however a moderate percentage of the shrimp landed are thought to be consumed. Cast netting is used primarily to capture white shrimp, but may also be effective in capturing brown shrimp. In South Carolina a popular method of cast netting shrimp is to bait shrimp. In shrimp baiting, a series of poles are pushed into the bottom of shallow tidal waters. Bait balls, made from fish meal and mud, are placed at a known distance around the poles. Casting with multi- or mono-filament nets begins within minutes after baiting. In South Carolina, cast nets used in conjunction with bait balls must have a mesh size of ½ inch bar mesh (one inch stretch); there are no mesh size restrictions for shrimp landed without baiting. In Georgia, recreational and commercial cast net fishermen are restricted to a minimum mesh size of 5/8 inch bar mesh.

Currently, there is not a minimum mesh size for recreational shrimp cast nets in North Carolina. In 1992, DMF tested three different sized meshes (3/8", ½", 5/8") of cast nets in conjunction with bait balls to determine their ability to capture brown shrimp in primary and secondary nursery areas bordering Pamlico Sound (Mckenna and Clark 1993). The 5/8" bar net had the highest CPUE for brown shrimp and cast made over bait balls captured more shrimp; however, cast nets were found to be an ineffective means of harvest in this area. The Pamlico Sound has a low tidal range with circulation dominated by wind-driven currents. This lack of tidal influence could affect shrimp behavior in term of movement and feeding activity, thus making them less susceptible to baiting. The lack of suitable bait was also cited as a limiting factor. Most shrimp landed by cast nets in North Carolina are not baited. Recreational cast netting occurs in the shallow, peripheral waters of the estuaries and shallow tidal creeks. Fishing effort is typically the highest at night; however it has become more prevalent during the day in deeper areas. Cast netting for white shrimp occurs in the southern portion of North Carolina and in Core and Bogue sound. During years when white shrimp are abundant, cast netting has also become more popular in the creeks and bays throughout Dare, Hyde, Beaufort, and Pamlico counties; with limits (100 shrimp) being caught consistently (G. Judy, NCDMF. personal communication). In North Carolina, recreational fishermen using cast nets to land shrimp are limited to 48 quarts (heads on) or 30 quarts (heads off) in open waters and limited to 100 shrimp per person per day while fishing in a closed area (15A NCAC 03L .0105). Proposed changes to Rule 15A NCAC 03L .0105 replace the 100-count measurement of shrimp harvested with a cast net in closed areas to a two-quart measurement, to improve Marine Patrol Officers' safety when enforcing shrimp harvest limits. These changes have an intended effective date of June 1, 2013.

6.3.7.5 Catch Restrictions

Catch restrictions have been used by fisheries managers to maintain fish stocks, extend fishing seasons, allocate resources, and reduce bycatch. In North Carolina this method is being used to reduce the targeting of marketable finfish with shrimp trawls. From December 1 through February 28, it is unlawful to use trawl nets in internal waters to take more than 500 pounds of finfish and from March 1 through November 30 no more than 1,000 pounds of finfish may be taken (15A NCAC 3J .0104 (a) (1)). Additionally, in the Atlantic Ocean it is unlawful to possess finfish caught incidental to shrimp trawling from December 1 through March 31 unless the

weight of the combined catch of shrimp and crabs exceeds the weight of finfish, except that 300 pounds of kingfish may be taken south of Bogue Inlet (15A NCAC 3J .0202 (5 (a) (b))).

6.3.7.6 Harvest Seasons

Harvest seasons have been used to reduce bycatch by relegating fishing activity to times of maximum target species abundance, or by limiting activity during times of high bycatch. Currently shrimp trawling is permitted all year in North Carolina. If a specific species stock assessment indicated that measures need to be taken to reduce either the incidental or discarded catch in the shrimp trawl fishery of that species the following questions should be addressed:

- 1) How will seasons be determined?
 - a) Overall?
 - b) Area?

- 2) What criteria will be used to set seasons?
 - a) Based on historic average landings?
 - b) Maximum value?

- 3) Will allowances be made for variable conditions?
 - a) Water temperature?
 - b) Salinity?

The type of information presented in Tables 6.12 through 6.17 would provide information to answer the first two questions, while environmental data collected by the various resource agencies could be used to address the third question.

6.3.7.7 Time Restrictions

Trawl time restrictions can reduce bycatch of non-target species. In North Carolina it is unlawful to trawl for shrimp in the Atlantic Ocean off Brunswick County, 9:00 p.m. to 5:00 a.m. (15A NCAC 03J .0202 (8)). This management measure was implemented in large part to reduce the bycatch of finfish in this gear. Ingraham (2003) examined this question by conducting a study of shrimp and finfish catch rates (day vs. night) in state waters from Topsail Inlet to Little River Inlet. Data from the study showed that finfish bycatch was higher at night than during the day. Of the nine commercially important finfish species caught, southern flounder, spot, Atlantic croaker, and southern kingfish catch rates were significantly higher at night. The catch of shrimp did not vary significantly between nighttime and daytime trawling, although catches were slightly higher during the day. Limiting the number of days trawlers are allowed to fish could also limit bycatch without reducing landings. Johnson (2006) noted that twice as much shrimp were caught early in the five-day trawling week than later in the week in the estuarine shrimp trawl fishery in NC, suggesting that time restrictions could further improve the efficiency of the shrimp fishery.

6.3.7.8 Area Restrictions

Area restrictions for trawling have been used to deal with allocation, resource, habitat, and safety issues in North Carolina. During the late 1980s trawling was prohibited in Albemarle Sound and its tributaries [15A NCAC 3J .0104 (b) (3)]. This action was implemented to protect

the flounder gill net fishery in this area (allocation issue). Since 1978 over 124,000 acres of estuarine nursery areas have been closed to trawling to protect juvenile fish and crustaceans. MFC rule 15A NCAC 3N .0102 (a) defines Nursery Areas “as those areas in which for reasons such as food, cover, bottom type, salinity, temperature and other factors, young fish and crustaceans spend the major portion of the initial growing season.” There are approximately 77,000 acres of Primary Nurseries, 47,000 acres of Secondary Nursery areas, and 37,000 of special Secondary Nursery areas. Primary and Secondary Nursery areas are permanently closed to trawling, while Special Secondary Nursery areas can only be opened to trawling by proclamation from August 16 through May 15. In the mid-90s the sea grass beds along the Outer Banks were closed to trawling to protect this critical habitat. Over 78,000 acres of military danger zones and restricted areas are also closed to trawling for safety reasons. North Carolina has 2,220,000 acres of estuarine surface waters with approximately 1,000,000 acres (45%) closed to trawling.

6.3.7.9 Limited Entry

Limited entry methods of management restrict access to a fishery. Capping and/ or reducing fishing effort can protect the biological viability of a species and the economic integrity of the fishery. The species is protected by preventing overfishing and depletion of the stocks. The fishery is enhanced by reducing costs and increasing earnings, effectively increasing efficiency. Other benefits of limited entry programs include an incentive to conserve, more efficient management, bycatch minimization, and habitat protection. However, piecemeal implementation of limited entry programs can easily displace fishing effort from one fishery to create new problems in other areas and fisheries (Buck 1995). For bycatch reduction, limited entry systems are often used in conjunction with other management measures, such as quotas or trip limits to achieve management objectives.

7.0 PROTECTED RESOURCES

Protected species is a broad term that encompasses a host of species that are identified by federal or state protective statutes. The federal protective authorities are paramount and are the Endangered Species Act (ESA) and the Marine Mammal Protection Act (MMPA). Protected species in FMPs are generally discussed in relation to their implication to fisheries being prosecuted for the FMP species and that these fisheries may have an incidental take of protected species. The protected species topic herein intends to identify the principal fisheries, describe the various federal and state laws that deal with protected species, and discuss the ongoing management programs and implications of protected species interactions in the shrimp fishery.

7.1 PROTECTED RESOURCES LEGISLATION

7.1.1 Federal Endangered Species Act (ESA)

The ESA was enacted in 1973, “to provide a means whereby the ecosystems upon which endangered and threatened species depend may be conserved, (and) to provide a program for the conservation of such endangered species and threatened species.” The ESA is a comprehensive act with eighteen sections that cover many aspects of endangered species protection and management (STAC 2006).

The ESA defines a species as threatened when it is likely to become an endangered species within the foreseeable future. An endangered species is defined as any species which is in danger of extinction throughout all or a significant part of its range. A take is to harass, harm, pursue, hunt, shoot, wound, kill, trap, capture or collect, or to attempt to engage in any such conduct (STAC 2006). Candidate species are species that appear to warrant consideration for addition to the federal ESA list. They are sometimes referred to as “species of special concern”. These species receive no substantive or procedural protection under the ESA.

Section 10 of the ESA provides for exceptions to the take prohibitions in the form of permits. These permits can be for either an intentional take or for an incidental take. Intentional take permits are intended for scientific purposes or to enhance the propagation or survival of the affected species. Incidental Take Permits (ITP) are for activities that are otherwise lawful but are expected to incidentally take a listed species. Permit holders must develop and implement conservation plans that reduce and minimize the impacts of the take. When a Section 10 permit application is reviewed and deemed appropriate, a permit is granted to authorize a specified level of takes. Along with the specified take that is authorized, the permit includes reporting requirements, and often includes other conditions that must be met (tagging, handling guidelines, data analyses, conservation plans, observer coverage, etc.).

Section 7 of the ESA relates to interagency cooperation amongst federal agencies. There are two primary provisions to this section: (1) all federal agencies shall use their authorities towards the furtherance of the goals of the ESA; (2) and each federal agency must consult with the Secretary [in practice NMFS or US Fish and Wildlife Service (USFWS)] to insure that any action funded, authorized, or carried out by the agency is not likely to jeopardize the continued existence of a listed species or result in the destruction or adverse modification of its critical habitat. Although this section relates to federal agency cooperation, it can impact state projects through a federal nexus. If a project has federal authorization, funding, or other participation, it is subject to Section 7 consultation between the federal agency and NMFS or USFWS. NCDMF

has received biological opinions and incidental take statements in regards to Section 7 consultations on several federally funded division research projects.

Most of the species listed as endangered or threatened fall under federal jurisdiction either with the NMFS or the USFWS. The following is a list of endangered (E) or threatened (T), or federal species of concern (FSC) species that may occur in estuarine and ocean waters of North Carolina (NCDMF 2005):

Fish

- Smalltooth sawfish (*Pristis pectinata*) E
- Shortnose sturgeon (*Acipenser brevirostrum*) E
- Atlantic sturgeon (*Acipenser oxyrinchus*) E

Reptiles

- Green sea turtle (*Chelonia mydas*) T
- Kemp's ridley sea turtle (*Lepidochelys kempii*) E
- Hawksbill sea turtle (*Eretmochelys imbricate*) E
- Leatherback sea turtle (*Dermochelys coriacea*) E
- Loggerhead sea turtle (*Caretta caretta*) T
- Northern diamondback terrapin (*Malaclemys terrapin terrapin*) FSC in Dare, Pamlico, and Carteret counties in North Carolina

Mammals

- West Indian manatee (*Trichechus manatus*) E
- Fin whale (*Balaenoptera physalus*) E
- Humpback whale (*Megaptera novaeangliae*) E
- North Atlantic right whale (*Eubalaena glacialis*) E
- Sperm whale (*Physeter catodon*) E
- Sei whale (*Balaenoptera borealis*) E

Only federally endangered or threatened species are protected by federal law.

Based on a status review and all other available information on the Atlantic sturgeon (*Acipenser oxyrinchus*), NMFS designated four separate distinct population segments (DPS) as endangered and one DPS as threatened. The Carolina and South Atlantic DPSs, both prevalent in North Carolina, were listed as endangered under the ESA on April 6, 2012.

The American eel (*Anguilla rostrata*) is currently under status review for listing as threatened by the USFWS. NMFS is also reviewing the status of the scalloped hammerhead shark (*Sphyrna lewini*) to be listed as either threatened or endangered, and Alewife (*Alosa pseudoharengus*) and blueback herring (*Alosa aestivalis*) to be listed as threatened under the ESA.

7.1.2 Marine Mammal Protection Act (MMPA)

The Marine Mammal Protection Act of 1972 was enacted in response to increasing concerns by scientists and the public that significant declines in some species of marine mammals were caused by human activities. It established a national policy to prevent marine mammal species and population stocks from declining to a point where they ceased to be significant functioning elements of the ecosystem.

The Department of Commerce through the NMFS is charged with protecting whales, dolphins, porpoises, seals, and sea lions. Walrus, manatees, otters, and polar bears are protected by the Department of the Interior through the USFWS. The MMPA established a moratorium on the taking of marine mammals in U.S. waters. It defines “take” to mean “to hunt, harass, capture, or kill” any marine mammal or attempt to do so. Exceptions to the moratorium can be made through permitting actions for take incidental to commercial fishing and other non-fishing activities, for scientific research, and for public display at licensed institutions such as aquaria and science centers.

The MMPA requires NMFS to categorize each commercial fishery into one of three categories based upon the level of serious injury and mortality to marine mammals that occurs incidental to each fishery. Category I fisheries pose the greatest threat and Category III fisheries the least threat. The category in which a fishery is placed determines whether fishermen are subject to certain provisions of the MMPA, such as registration, observer coverage and take reduction plan (TRP) requirements. According to the 2011 List of Fisheries created by NOAA, the Atlantic southeastern shrimp trawl fishery is considered to be in Category II (occasional mortality or serious injury) due to interactions with the bottlenose dolphin (NOAA 2010).

7.1.3 North Carolina Endangered Species Act (Chapter 113 Article 25)

Listing of protected species from a state perspective lies with North Carolina Wildlife Resource Commission (NCWRC) (NC General Statutes - Chapter 113 Article 25). The NCWRC compiled state lists of animals deserving protection over 20 years ago based on guidance from Scientific Councils on mammals, birds, reptiles, amphibians, freshwater fishes, mollusks, and crustaceans. Endangered, Threatened, and Special Concern species of mammals, birds, reptiles, amphibians, freshwater fishes, freshwater and terrestrial mollusks, and crustaceans are protected by state law. Protection for crustaceans and certain venomous snakes was enacted in 2002. However, state law does not allow for protection of invertebrate groups other than mollusks and crustaceans.

Under the state Endangered Species Act the NCWRC has the following powers and duties:

- To adopt and publish an endangered species list, a threatened species list, and a list of species of special concern, as provided for in G.S. 113-334, identifying each entry by its scientific and common name.
- To reconsider and revise the lists from time to time in response to public proposals or as the Commission deems necessary.
- To coordinate development and implementation of conservation programs and plans for endangered and threatened species of wild animals and for species of special concern.
- To adopt and implement conservation programs for endangered, threatened, and special concern species and to limit, regulate, or prevent the taking, collection, or sale of protected animals.
- To conduct investigations to determine whether a wild animal should be on a protected animal list and to determine the requirements for conservation of protected wild animal species.

- To adopt and implement rules to limit, regulate, or prohibit the taking, possession, collection, transportation, purchase or sale of those species of wild animals in the classes Amphibia and Reptilia that do not meet the criteria for listing pursuant to G.S. 113-334 if the Commission determines that the species requires conservation measures in order to prevent the addition of the species to the protected animal lists pursuant to G.S. 113-334. This subdivision does not authorize the Commission to prohibit the taking of any species of the classes Amphibia and Reptilia solely to protect persons, property, or habitat; to prohibit possession by any person of four or fewer individual reptiles; or to prohibit possession by any person of 24 or fewer individual amphibians.

The NCWRC develops conservation plans for the recovery of protected wild animal species, using the procedures set out in Article 2A of Chapter 150B of the General Statutes. The North Carolina Natural Heritage Program inventories, catalogues, and supports conservation of the rarest and the most outstanding elements of the natural diversity of our state. These elements of natural diversity include those plants and animals which are so rare or the natural communities which are so significant that they merit special consideration as land-use decisions are made.

Species that appear on the 2010 Natural Heritage Program List of the Rare Animal Species of North Carolina that may interact with shrimp trawls, skimmer trawls and channel nets include the loggerhead sea turtle (T), leatherback sea turtle (E), hawksbill sea turtle (E), Kemp's ridley sea turtle (E), and green sea turtle (T).

7.2 SPECIES THAT MAY INTERACT WITH THE SHRIMP FISHERY

Of the federal and state protected species listed above, only bottlenose dolphins, and sea turtles interact with the shrimp fishery. Otter trawls and skimmer trawls are the predominant gear in the shrimp fishery. Both trawls are active gears that focus on the estuarine bottom, and are restricted to areas without submerged aquatic vegetation; interactions with protected species are plausible. Channel nets used less extensively in the shrimping fishery are a passive gear and use tide flow and current to fish. There is no information on interactions with protected species and channel nets.

7.2.3 Bottlenose Dolphin

The bottlenose dolphin (*Tursiops truncatus*) inhabits temperate and tropical waters throughout the world. According to the 2009 U.S. Atlantic and Gulf of Mexico Marine Mammal Stock Assessment (Waring 2009) nine bottlenose dolphin stocks have been identified in the nearshore waters of the Western North Atlantic. Two of these stocks are found in North Carolina estuaries and are identified as the Northern North Carolina Estuarine System Stock and the Southern North Carolina Estuarine System Stock. Bottlenose dolphins have been observed throughout the year in North Carolina estuarine waters but will migrate offshore when water temperatures fall below 10° C.

A marine mammal species is designated as depleted if it falls below its optimum sustainable population. The MMPA requires that a Take Reduction Team (TRT) be convened for the purpose of recommending measures for inclusion in a TRP to promote recovery of a depleted stock. The Bottlenose Dolphin Take Reduction Team (BDTRT) was convened in November 2001 and was made up of fishermen, managers, scientists, and environmental groups. The BDTRT focused on reducing serious injuries and deaths of coastal bottlenose dolphins incidental to several east coast fisheries including: the North Carolina inshore gill net, Southeast

Atlantic gill net, Southeastern U.S. shark gill net, U.S. Mid-Atlantic coastal gill net, Atlantic blue crab trap/pot, Mid-Atlantic haul/beach seine, North Carolina long haul seine, North Carolina roe mullet stop net, and Virginia pound net. In April 2006, NMFS published a [final rule](#) implementing the BNDTRP effective May 26, 2006 (FR Doc. 06-3909 Filed 4-25-06). Shrimp trawls were not included in the final rule.

Bottlenose dolphins are occasionally captured or entangled in various kinds of fishing gear including gill nets, seines, long-lines, crab pot lines, and shrimp trawls. The NOAA List of Fisheries classifies U.S. commercial fisheries into one of three Categories based on the level of incidental mortality or serious injury of marine mammals (NOAA 2010). Category I are fisheries with frequent incidental mortality or serious injury; Category II are fisheries where occasional incidental mortality or serious injury; and Category III are fisheries with a remote likelihood of/known incidental mortality or serious injury. Several trawl fisheries, including the southeastern shrimp trawl fishery, were elevated in 2010 from a Category III fishery to a Category II fishery in the List of Fisheries (LOF). This listing is based on interactions reported through observer reports, stranding data, and fisheries research data with multiple marine mammal stocks (<http://www.nmfs.noaa.gov/pr/interactions/lof/>) and is updated annually.

In NC there has been one known take in the lazy line of a relocation trawl and several strandings with evidence indicative of a trawl interaction. There have not been any interactions with skimmer trawls or channel nets. (Barbie Byrd, NMFS, personal communication, November 2011). No further information was provided by NMFS concerning NC dolphin interaction data.

Owners of vessels or gear engaging in a Category I or II fishery, are required under 50 CFR 229.4 to obtain a marine mammal authorization by registering with the Marine Mammal Authorization Program (MMAP). Upon receipt of a completed registration, NMFS will issue vessel or gear owners a decal to display on their vessels and an authorization certificate that the operator must possess while fishing. Fishers participating in a Category I or II fishery are required to accommodate an observer onboard your vessel(s) upon request (50 CFR 229.7) and are required to comply with any applicable take reduction plans. Currently, NMFS does not have a take reduction plan for the southeastern U.S Atlantic or the Gulf of Mexico Shrimp Trawl Fishery (<http://www.nmfs.noaa.gov/pr/interactions/lof/>).

7.2.4 Sea Turtles

Sea turtles are air-breathing reptiles with streamlined bodies and large flippers which inhabit tropical and subtropical ocean waters throughout the world. Of the seven species of sea turtle worldwide, five occur in North Carolina. They include the Kemp's ridley sea turtle (*Lepidochelys kempii*), hawksbill sea turtle (*Eretmochelys imbricate*), leatherback sea turtle (*Dermochelys coriacea*), green sea turtle (*Chelonia mydas*), and the loggerhead sea turtle (*Caretta caretta*). Although sea turtles live most of their lives in the ocean, adult females must return to land to lay their eggs on sandy beaches. They often migrate long distances between foraging grounds and nesting beaches. Kemp's ridley, green, and loggerhead sea turtles are known to move into North Carolina coastal waters as large juveniles to forage on crustaceans, mollusks, or grasses (STAC 2006). The loggerhead and green sea turtles are federally listed as threatened, while the others are listed as endangered.

Hawksbill turtles have been reported off the coast of North Carolina during the months of June, July, October and November. This species of turtle prefers shallow coastal water with depths not greater than 66 feet. Preferred habitat includes coral reefs, rocky bottoms, reefs, and coastal lagoons. Adult hawksbills primary food source are sponges, but they also eat urchins,

algae, barnacles, mollusks, jellyfish, and fish. Hawksbills exhibit a wide tolerance for nesting substrate type and nests are typically placed under vegetation. Nesting occurs principally in Puerto Rico and the U.S. Virgin Islands but does occur in the southeast coast of Florida and the Florida Keys. The largest threat to the hawksbill is the loss of coral reef habitat. The extent to which hawksbills are killed or debilitated after becoming entangled in marine debris has not been quantified, but it is believed to be a serious and growing problem. Hawksbills (predominantly juveniles) have been reported entangled in monofilament gill nets, fishing line, and synthetic rope. Hawksbills are incidentally taken by several commercial and recreational fisheries. Fisheries known or suspected to incidentally capture hawksbills include those using trawls, gill nets, traps, driftnets, hooks, beach seines, spear guns, and nooses (NMFS 1993b). There were no strandings reported of hawksbill sea turtles in North Carolina between 1991 and 1999, but there were nine between 2001 and 2010 (NCWRC/NMFS Sea Turtle Stranding and Salvage Network [STSSN] data).

The leatherback sea turtle is the largest turtle in the world and has a worldwide distribution in tropical and temperate waters. This species is found off the coast of North Carolina from April to October with occasional sightings into the winter. The main prey species of leatherbacks are jellyfish and tunicates and occur almost exclusively in ocean waters (STAC 2006). There is one record of a NC nesting site at Cape Lookout in 1966 (Lee and Socci 1989), and an additional nesting site was reported near Cape Hatteras in 2000. Leatherbacks become entangled fairly often in longlines, fish trap, buoy anchor lines, and other ropes and cables (NMFS 1992). Prescott (1988) implicated entanglement in lobster pot lines in 51 of 57 adult leatherback strandings in Cape Cod Bay, Massachusetts from 1977 to 1987. Between 1990 and 2000, there were 12 reported leatherback strandings in North Carolina, between 2001 and 2005 there were 75, and from 2006 through 2011, there have been 23 reported strandings (www.seaturtle.org).

The Kemp's ridley sea turtle occurs primarily in the Gulf of Mexico, but they also occur along the Atlantic coast as far north as New England. Juveniles occur year-round within the sounds, bays, and coastal waters of North Carolina. Adult Kemp's ridley turtles are primarily a bottom feeder; feeding on crabs, shrimp, urchins, starfish, jellyfish, clams, snails, and squid. Incidental take by shrimp trawls has been identified as the largest source of mortality with between 500 and 5,000 killed annually (NMFS 1993a). Manzella et al. (1988) estimated that 0.2% of the juvenile Kemp's ridleys killed by fishing gear were killed as a result of interaction with crab pots. In North Carolina 17% of the sea turtle strandings between 1990 and 2000 were Kemp's ridleys (WRC/NMFS STSSN; 1990-2000). From 2001 through 2011, there have been 785 strandings in North Carolina (www.seaturtle.org).

The green sea turtle has a circumglobal distribution in tropical and subtropical waters. In U.S. Atlantic waters, it occurs around the Virgin Islands and Puerto Rico and from Texas to Massachusetts. Green turtles are sighted in oceanic waters and within the sounds of North Carolina during the period from May through October. Due to their food preference for submerged aquatic vegetation, adult green turtles are normally found in lagoons, bays, and tidal inlets. No major nesting sites are located along the U.S. coastline; however, limited annual nesting occurs in Florida from April to July. From 1979 to 1989, there were two reported (1987, Baldwin Island and 1989, Cape Hatteras) and one confirmed (1979, Camp Lejeune) nesting sites in North Carolina. In 2009, there were three nests in North Carolina and 2010; there were 18 green turtle nests (NCWRC Sea Turtle Nest Monitoring System data). In 1992, NMFS finalized regulations to require the use of Turtle Excluder Devices (TEDs) in shrimp trawl fisheries. A significant threat to the green turtle continues to be fishing gear, primarily gill nets, but also trawls, traps and pots, and dredges. Green sea turtles have been recovered entangled

in trap lines with the trap in tow (NMFS 1991a). Strandings have drastically increased since 2008. From 1991 to 2000, green turtles accounted for 18% of the sea turtle strandings in North Carolina and between 2001 and 2010 they make up 32% of total strandings (WRC/NMFS STSSN).

The loggerhead sea turtle has a subtropical (and occasionally tropical) distribution, including continental shelves and estuaries along the margins of the Atlantic, Pacific, and Indian oceans. It is rare or absent far from mainland shores. The loggerhead turtle is the most common sea turtle in North Carolina (STAC 2006) and is present throughout the year, with peak densities occurring from June to September. The loggerhead turtle diet includes algae, seaweeds, horseshoe crabs, barnacles, various shellfish, sponges, jellyfish, squid, urchins, and fish. Nesting occurs along the U.S. Atlantic coast from New Jersey to Florida, however, the majority of nesting activity occurs from South Carolina to Florida. In North Carolina, nesting activity has been reported from April to September. The highest nesting densities are reported south of Cape Lookout. In 2010, there were 847 loggerhead turtle nests in North Carolina (WRC Sea Turtle Nest Monitoring System data). The primary threat to loggerhead turtle populations worldwide is incidental capture in fishing gear, primarily in longlines and gill nets, but also in trawls, traps and pots, and dredges. Loggerhead turtles account for over half of the sea turtle strandings in North Carolina (WRC/NMFS STSSN).

7.2.4.1 Sea Turtles and the Shrimp Fishery

Shrimp and flounder trawlers have been required to use TEDs since 1992. Since 2007, NOAA Fisheries has required fishing vessels that are identified through an annual determination process to take observers at NOAA Fisheries request. The NMFS prepared an Environmental Impact Statement (EIS) evaluating TEDs for use in skimmer trawls due to the non-compliance of the tow time requirements in the Gulf of Mexico. NMFS is also concerned about the increase in skimmer trawl vessel and gear size and potential impacts to sea turtles. Therefore, the NOAA Fisheries is reevaluating the efficacy of turtle conservation requirements associated with the skimmer trawl fishery. In addition, NMFS is concerned about compliance issues with TED requirements in the shrimp otter trawl fishery and have noted a variety of compliance issues ranging from lack of TED use, TEDs installed incorrectly, and TEDs sewn shut. Therefore NMFS is also considering additional management measures of the shrimp trawl fishery (NOAA 2011). During the required scoping meetings, NCDMF commented that there has been a 35% decline in skimmer trawl trips and pounds of shrimp landed by skimmer trawls were down 33%. Unlike the Gulf of Mexico skimmer trawl fleet, North Carolina has not seen an increase in vessel size. Observed increases in the Gulf gave the NMFS a reason to address the problem on non-compliance and impacts of larger boats in the Gulf of Mexico, not in North Carolina where 55-minute tow times are still sufficient (David Taylor, NCDMF, personal communication). NMFS held a public hearing on TED requirements in the skimmer trawl in June 2012. It is expected that the new regulation will be in place by March 2013.

The Sea Turtle Advisory Committee (STAC) was formed in 2003 by the North Carolina Marine Fisheries Commission (NCMFC) in response to continuing problems with sea turtle interactions in fisheries throughout the North Carolina coast. Their objective was to develop solutions for the reduction of sea turtle interactions in commercial and recreational (hook and line) fishing gear, while maintaining economically viable fisheries throughout the estuarine waters of North Carolina. Over a three year effort, the STAC identified and categorized different fishing gears. Shrimp trawls were identified as gears of primary concern with relation to sea turtle incidental catch throughout North Carolina. Skimmer trawls, butterfly nets and channel nets were

identified as gears of other concern, while gears of no concern used in the shrimp fishery were cast nets and dip nets.

Recommendations were provided to the NCMFC to implement observer coverage for multiple fisheries of either primary or other concern was made in order to gather information where it is limited. The STAC also supported continued efforts for gear modification and testing with the objective of reducing sea turtle interactions (STAC 2006).

Shrimp Trawls:

1. Determine and enforce TED compliance throughout North Carolina through the NC MFC creating a rule change or authorizing proclamation authority to the director of NCDMF to provide state authority to enforce TED compliance. As this is a federal regulation, initially an estimate of current compliance needs to be obtained. Following this, the NCDMF may opt to increase effort to ensure compliance with TED regulations.
2. Support turtle resuscitation education and TED education.
3. Add statewide observer coverage. The level of this coverage should have a minimum goal of 2% of the total effort by area. Coverage should increase (~10%) in areas where sea turtle interactions are occurring.

Butterfly Net, Channel Net, Skimmer Trawl:

1. Implement observer coverage. The level of this coverage should have a minimum goal of 2% of the total effort by area. Coverage should increase (~10%) in areas when/where sea turtle interactions are occurring.
2. Provide educational information on sea turtle resuscitation and reporting requirements for unharmed/injured /dead turtles.

7.2.4.2 NCDMF Programs

An agreement was established in 1979 with the WRC to exercise regulatory jurisdiction over any species of sea turtle, and their eggs and nests, consistent with designation of such species as endangered or threatened by the USFWS. In 1980, the NCMFC established a Sea Turtle Sanctuary off the coast of North Carolina to protect nesting beaches (NC Fisheries Rule – 15A NCAC 03R.0101). In 1983, proclamation authority was given to the director of NCDMF by NCMFC to close areas to protect endangered/threatened species (NC Fisheries Rule-15A NCAC 03I.0107). In 1989, an addition was made to the Marine Recreational Fisheries Statistics Survey (MRFSS) program to include a sea turtle sightings query on the survey form.

In the latter part of 2010, DMF reallocated funds to establish the Protected Resources Section within the division and obtained funding to support a statewide at-sea observer program for the gill net fishery. The new Protected Resources Section will be the lead for division actions involving protected species such as at-sea observer programs, marine mammal stranding responses and marine mammal take reduction teams, and other protected species issues that may arise (Dee Lupton, NCDMF personal communication).

Marine mammal stranding response along the central North Carolina coast, transitioned from North Carolina State University Center for Marine and Science Technology to the NCDMF in

October of 2010. This project is funded year to year from the John H. Prescott Marine Mammal Rescue Assistance Foundation, pending successful proposal review and acceptance. A full-time stranding coordinator was hired and stranding personnel have responded to numerous marine mammal strandings. North Carolina stranding response is divided into four areas: UNC Wilmington personnel respond to all strandings in the southern part of the state up to and including Camp LeJeune; NCDMF stranding personnel respond to strandings from Hammocks Beach State Park to Cape Lookout National Seashore and in Albemarle and Pamlico sounds; Cape Hatteras (CAHA) National Seashore stranding personnel respond to strandings in CAHA National Seashore, and North Carolina Department of Environment and Natural Resources (DENR) personnel respond to strandings from CAHA north to the VA border. Stranding personnel conduct outreach by giving public seminars at marine mammal meetings, local museums, Universities, and classrooms. Stranding personnel disseminate results and tissue samples from stranded animals to collaborating researchers and agencies.

The NCDMF observer program began in 1999 when the sea turtle stranding network noted significant increases in sea turtle strandings in the southeastern portion of Pamlico Sound. The purpose of these observations was to begin the process of characterizing effort, catch, and bycatch by area and season in various fisheries. In addition, this program was established to monitor fisheries for the potential of protected species bycatch. The data collected is used for fisheries management decisions, stock assessments, and conservation efforts for protected species. Currently, the observer program primarily focuses on large mesh gill nets but data are also being collected in small mesh gill nets and recreational hook and line. In addition sampling has just begun in long haul seines and channel nets. Data collections from observer trips includes: date, location, unit, time, season, gill net description (net length, number of net shots, mesh size, presence/absence of tie downs, vertical mesh height, hang ratio), soak time and water depth. Additionally, environmental parameters (wind, tide stage and water quality data) are collected when feasible. Total catches of target species are estimated and final disposition (kept or discarded) is recorded. Sea turtle interaction information includes species, condition, tag numbers, and final disposition. All interactions involving protected species are documented. All observers are required to adhere to these data collection parameters.

The NCDMF gear development program has provided observation data from shrimp trawls through some limited characterization work of shrimp trawlers. A study from 2009 was on the near-shore commercial shrimp trawl fishery off the southern shores of North Carolina from Carteret County to Brunswick County. This study collected relative effort and discard information on weakfish (*Cynoscion regalis*), spotted sea trout (*Cynoscion nebulosus*), spot (*Leiostomus xanthurus*), Atlantic croaker (*Micropogonias undulatus*), bluefish (*Pomatomus saltatrix*), Atlantic menhaden (*Brevoortia tyrannus*), southern flounder (*Paralichthys lethostigma*), and striped mullet (*Mugil cephalus*) as well as other species of federally and state managed species of finfish. There were three observed interactions with loggerhead sea turtles in this study. All three sea turtles were taken in the try net which are small trawls equipped with small doors, no TEDs nor BRDs, and is used to sample areas prior to setting the main trawls and to monitor the catch rates during tows. The try nets had tow times of approximately 10 minutes. All three sea turtles were released in good condition. There were no observed sea turtle interactions observed in the main nets.

Another characterization study of the shrimp trawl fishery was in Pamlico Sound in 2010 and also provided observation data. Similar information was collected regarding effort and discard of recreationally and commercially important finfish. There were no observed sea turtle interactions observed during this study.

In the fall of 2010, the MFC reestablished the STAC (Sea Turtle Advisory Committee) to address sea turtle bycatch. The duties of the reestablished STAC include but are not limited to: reviewing observer reports, devising means for fishermen to report turtle interactions, assisting with fishermen education, determining measures to reduce the incidental take of sea turtles, monitor observer program issues, and reviewing all future ITP provisions and take calculations prior to formal application to NMFS. The STAC will provide recommendations and guidance to the NCMFC and NCDMF in addressing protection of sea turtles in North Carolina.

Since the 1970s, the NCDMF has been proactive in developing ways to minimize impacts to threatened and endangered marine species. The NCDMF works closely with NMFS and other state and federal agencies to develop regulations that minimize impacts to protected species while trying to allow the prosecution of many economically important fisheries.

8.0 ECONOMIC STATUS

8.1 COMMERCIAL FISHERY

8.1.1 Harvesting sector

8.1.1.1 Ex-vessel value and price

The state's trip ticket program began in 1994 when it was mandated that all commercial landings be reported to DMF. Prior to this time, landings were reported through a sampling program. Reporting the ex-vessel value of the landings continues to remain optional. It is useful in economic analyses to tie the value of annual landings back to an established baseline to control for the effects of inflation. Changes in landings values from year to year can be more clearly understood after removing the influence of changing dollar values over time. To do so, nominal values are adjusted by the Consumer Price Index (CPI) in an attempt to remove the effects of inflation over time.

The annual nominal ex-vessel value of shrimp landings typically has been volatile with sizable changes between years. The lowest nominal value of the catch was \$3.5 million in 1972. The highest nominal value for shrimp landings was \$25.4 million in 2000. Relatively speaking, 1981 represented a 69% drop in the value of landings from 1980. However, the fishery rebounded in 1982 with a 210% increase in the nominal value of landings over 1981. The value of the fishery dropped by 53% in 2001 from the record high value observed in 2000. In 2002, the value increased 54% over the 2001 value, but it remained considerably lower than the 2000 value. The nominal value hit a 20 year low in 2005 (\$4.4 million), dropping 50% over the previous year's value; however, the fishery recovered to over \$19.2 million in 2008. The nominal ex-vessel value of landings in 2010 was \$10.7 million (Figure 8.1, Table 8.1).

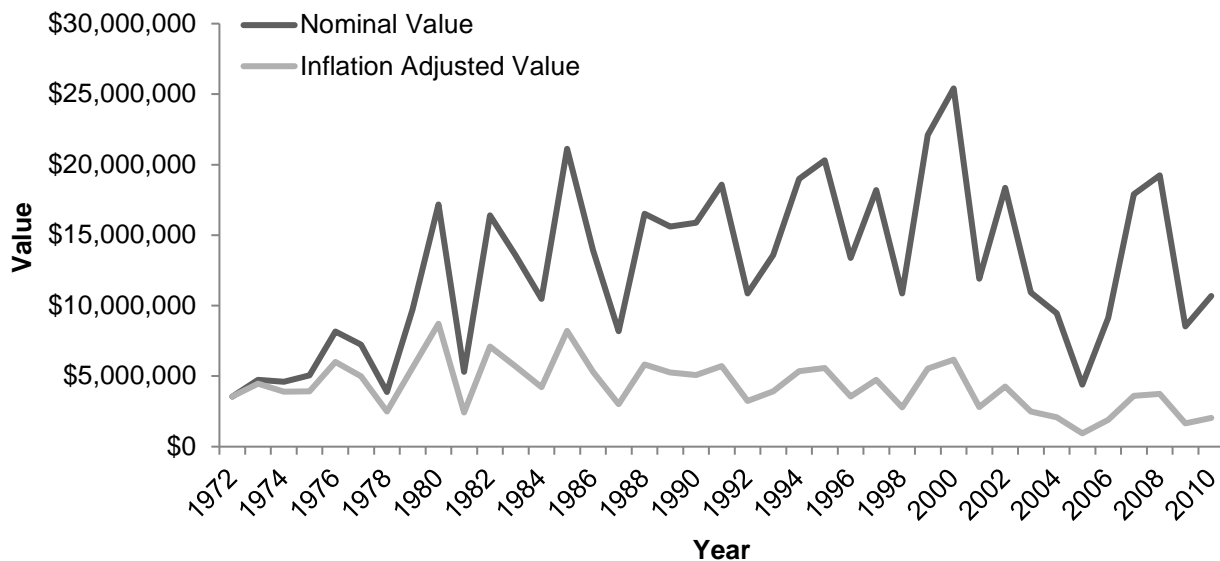


Figure 8.1. Value of shrimp landings in North Carolina, 1972 – 2010 (DMF Trip Ticket Program).

The CPI inflation-adjusted figures (deflated to the value of a dollar in 1972) typically show less volatility. Nonetheless, significant volatility from year to year can be seen in the landings values from 1978 to 1987. With a few exceptions, the total inflation adjusted value of landings hovered around the \$2 – \$8 million mark from 1972 until 2000. The inflation adjusted value of annual landings has been in an overall downward trend in recent years. The inflation adjusted value of landings in 2005 was less than \$1million, lower than any year in over 30 years. The inflation adjusted ex-vessel value of shrimp landings in 2010 was approximately \$2 million (Figure 8.1, Table 8.1).

Changes in annual values can largely be attributed to three major causes; the number of pounds landed, price per pound received by fishermen, and in recent years, the impacts of imports. The recent history of imports and their impact on the price of shrimp is further discussed in section 8.1.1.6 of this document.

The average nominal price per pound paid to the fisherman generally rose between 1972 and 1982 (Figure 8.2, Table 8.1), rising from a low of \$0.64 in 1972 to \$2.34 in 1982. From 1983 through 1994, the price per pound fluctuated between a high of \$2.61 in 1994 and a low of \$1.73 in 1991. From 1994 to 2000, the price per pound averaged just below \$2.50 per pound. However, since 2000, the nominal price per pound paid to fishermen exhibited a decreasing trend and dropped to a low of \$1.58 in 2009.

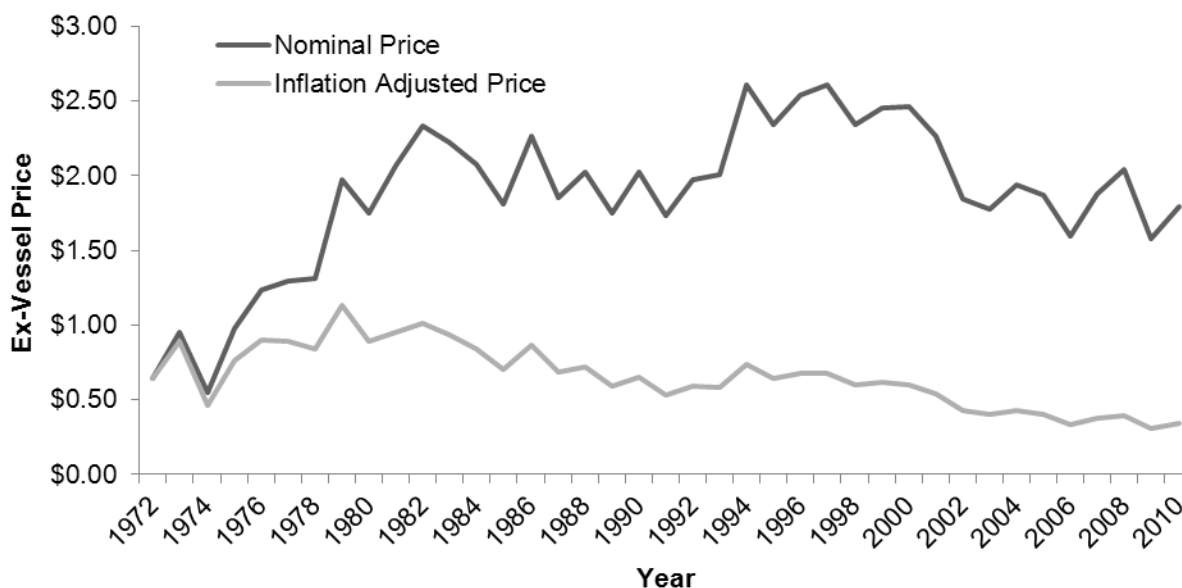


Figure 8.2. Average price per pound of shrimp landings in North Carolina, 1972 – 2010 (DMF Trip Ticket Program).

The trend in price per pound received by fishermen becomes clearer when one takes into account the impact of inflation. The inflation adjusted prices show that with the exception of 1979, the average inflation adjusted price of shrimp was under \$1.00 per pound until 1982. Since 1983 there has been a declining trend in the average price per pound. The lowest inflation adjusted price of \$0.31 in 2009 is 52% lower than the price received in 1972, and represents the lowest inflation adjusted price received per pound in over 30 years (Figure 8.2, Table 8.1).

Table 8.1 shows a summary of the data presented in section 8.1.1.1 indicating by year, the number of pounds of shrimp landed, nominal values, the inflation adjusted value, nominal price per pound, inflation adjusted price per pound, and the rate of change from one year to the next for all years in which data were available since 1972.

Table 8.1. Detail values of pounds landed, total value, inflation adjusted value, price per pound, and percent change from year to year for shrimp landed in North Carolina, 1972 – 2010 (DMF Trip Ticket Program).

Year	Pounds Landed	% Change in Pounds	Nominal Value	% Change in Nominal Value	Inflation Adjusted Value	% Change in Inflation Adjusted Value	Nominal Price per Pound	% Change in Nominal Price per Pound	Inflation Adjusted Price per Pound	% Change in Inflation Adjusted Price Per Pound
1972	5,563,261		\$3,549,492		\$3,549,492		\$0.64		\$0.64	
1973	5,003,417	-10%	\$4,738,223	33%	\$4,460,759	26%	\$0.95	48%	\$0.89	40%
1974	8,440,203	69%	\$4,606,363	-3%	\$3,905,598	-12%	\$0.55	-42%	\$0.46	-48%
1975	5,163,610	-39%	\$5,053,944	10%	\$3,926,670	1%	\$0.98	79%	\$0.76	64%
1976	6,642,713	29%	\$8,171,394	62%	\$6,002,887	53%	\$1.23	26%	\$0.90	19%
1977	5,600,329	-16%	\$7,239,080	-11%	\$4,993,293	-17%	\$1.29	5%	\$0.89	-1%
1978	2,960,762	-47%	\$3,883,836	-46%	\$2,489,944	-50%	\$1.31	1%	\$0.84	-6%
1979	4,941,240	67%	\$9,728,917	150%	\$5,601,498	125%	\$1.97	50%	\$1.13	35%
1980	9,823,490	99%	\$17,184,994	77%	\$8,717,630	56%	\$1.75	-11%	\$0.89	-22%
1981	2,557,426	-74%	\$5,295,209	-69%	\$2,434,981	-72%	\$2.07	18%	\$0.95	7%
1982	7,027,164	175%	\$16,411,472	210%	\$7,108,803	192%	\$2.34	13%	\$1.01	6%
1983	6,115,278	-13%	\$13,564,846	-17%	\$5,692,877	-20%	\$2.22	-5%	\$0.93	-8%
1984	5,046,163	-17%	\$10,482,761	-23%	\$4,217,319	-26%	\$2.08	-6%	\$0.84	-10%
1985	11,683,427	132%	\$21,130,303	102%	\$8,208,612	95%	\$1.81	-13%	\$0.70	-16%
1986	6,162,438	-47%	\$13,934,191	-34%	\$5,314,317	-35%	\$2.26	25%	\$0.86	23%
1987	4,416,636	-28%	\$8,178,180	-41%	\$3,009,225	-43%	\$1.85	-18%	\$0.68	-21%
1988	8,139,190	84%	\$16,509,108	102%	\$5,833,311	94%	\$2.03	10%	\$0.72	5%
1989	8,922,932	10%	\$15,620,436	-5%	\$5,265,599	-10%	\$1.75	-14%	\$0.59	-18%
1990	7,839,457	-12%	\$15,885,027	2%	\$5,080,292	-4%	\$2.03	16%	\$0.65	10%
1991	10,740,936	37%	\$18,586,613	17%	\$5,704,262	12%	\$1.73	-15%	\$0.53	-18%
1992	5,496,019	-49%	\$10,859,283	-42%	\$3,235,339	-43%	\$1.98	14%	\$0.59	11%

Table 8.1. (continued)

Year	Pounds Landed	% Change in Pounds	Nominal Value	% Change in Nominal Value	Inflation Adjusted Value	% Change in Inflation Adjusted Value	Nominal Price per Pound	% Change in Nominal Price per Pound	Inflation Adjusted Price per Pound	% Change in Inflation Adjusted Price Per Pound
1993	6,778,999	23%	\$13,590,604	25%	\$3,931,400	22%	\$2.00	1%	\$0.58	-1%
1994	7,292,489	8%	\$18,996,565	40%	\$5,358,005	36%	\$2.60	30%	\$0.73	27%
1995	8,669,100	19%	\$20,317,986	7%	\$5,572,781	4%	\$2.34	-10%	\$0.64	-13%
1996	5,271,273	-39%	\$13,373,962	-34%	\$3,562,980	-36%	\$2.54	8%	\$0.68	5%
1997	6,988,825	33%	\$18,204,849	36%	\$4,741,201	33%	\$2.60	3%	\$0.68	0%
1998	4,636,343	-34%	\$10,856,450	-40%	\$2,784,047	-41%	\$2.34	-10%	\$0.60	-11%
1999	9,004,535	94%	\$22,094,489	104%	\$5,543,515	99%	\$2.45	5%	\$0.62	3%
2000	10,334,915	15%	\$25,405,916	15%	\$6,167,057	11%	\$2.46	0%	\$0.60	-3%
2001	5,254,214	-49%	\$11,911,070	-53%	\$2,811,309	-54%	\$2.27	-8%	\$0.54	-10%
2002	9,969,026	90%	\$18,364,776	54%	\$4,267,080	52%	\$1.84	-19%	\$0.43	-20%
2003	6,167,371	-38%	\$10,939,078	-40%	\$2,485,073	-42%	\$1.77	-4%	\$0.40	-6%
2004	4,880,817	-21%	\$9,462,853	-13%	\$2,093,951	-16%	\$1.94	9%	\$0.43	6%
2005	2,357,516	-52%	\$4,409,124	-53%	\$943,683	-55%	\$1.87	-4%	\$0.40	-7%
2006	5,736,649	143%	\$9,141,435	107%	\$1,895,397	101%	\$1.59	-15%	\$0.33	-17%
2007	9,537,230	66%	\$17,905,334	96%	\$3,609,703	90%	\$1.88	18%	\$0.38	15%
2008	9,424,168	-1%	\$19,245,921	7%	\$3,736,499	4%	\$2.04	9%	\$0.40	5%
2009	5,407,708	-43%	\$8,527,714	-56%	\$1,661,524	-56%	\$1.58	-23%	\$0.31	-23%
2010	5,955,335	10%	\$10,691,399	25%	\$2,049,476	23%	\$1.80	14%	\$0.34	12%

8.1.1.2 Gear

From 1994 through 2010, 97% of all shrimp were caught using trawls. An additional 3% were caught using channel nets and less than 1% in other gears (Figure 8.3). Table 8.2 shows the number of pounds landed, the total value, and the price per pound for each of the gears listed in Figure 8.3 by year from 1994 – 2010.

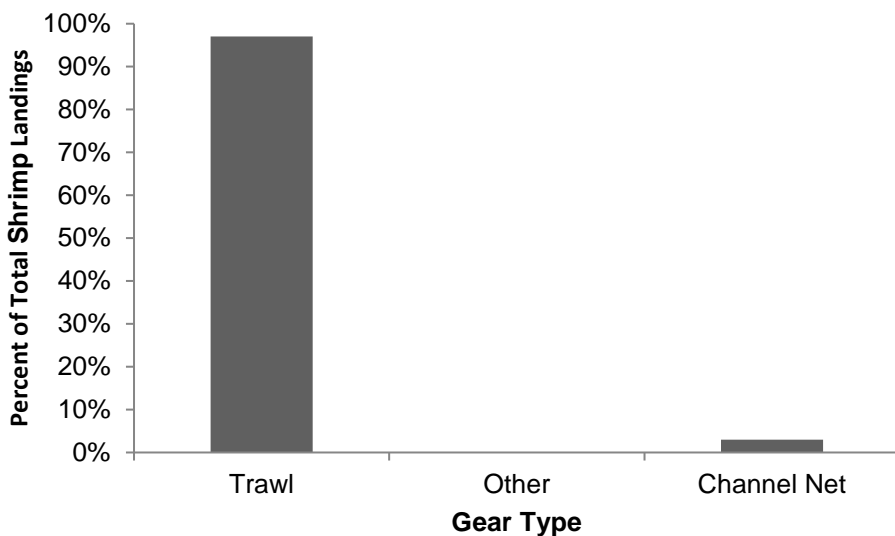


Figure 8.3. Percent of landings by gear used to harvest shrimp in all North Carolina waters, 1994 – 2010 (DMF Trip Ticket Program).

Trawls were the primary gears used to land shrimp in every year (Table 8.2). Trawls brought in the highest price per pound in most years. The price per pound for shrimp landed in trawls ranged from \$1.59 (2009) to \$2.62 (1994), averaging \$2.12 from 1994 to 2010. The price per pound for shrimp landed in channel nets ranged from \$1.08 (2009) to \$2.41 (1997), averaging \$1.81. The price per pound for shrimp landed in other gears ranged from \$1.38 (1999) to \$6.27 (2003), averaging \$2.84.

Table 8.2. Gear type, pounds, price per pound, and total value of shrimp landings by gear in all North Carolina waters, 1994 – 2010 (DMF Trip Ticket Program).

Year	Gear Type	Pounds	Nominal Value	Nominal Price per Pound
1994	Trawl	7,099,215	\$18,575,429	\$2.62
	Channel Net	186,029	\$403,636	\$2.17
	Other	7,245	\$17,499	\$2.42
1995	Trawl	8,361,435	\$19,688,121	\$2.35
	Channel Net	273,092	\$568,870	\$2.29
	Other	34,573	\$60,995	\$1.76
1996	Trawl	5,068,715	\$12,910,323	\$2.55
	Channel Net	199,915	\$457,195	\$2.08
	Other	2,643	\$6,444	\$2.44
1997	Trawl	6,795,437	\$17,739,453	\$2.61
	Channel Net	191,188	\$459,963	\$2.41
	Other	2,200	\$5,433	\$2.47
1998	Trawl	4,451,934	\$10,451,410	\$2.35
	Channel Net	181,917	\$399,731	\$2.20
	Other	2,493	\$5,309	\$2.13
1999	Trawl	8,712,050	\$21,511,886	\$2.47
	Channel Net	284,443	\$571,531	\$2.01
	Other	8,042	\$11,072	\$1.38
2000	Trawl	10,070,979	\$24,775,580	\$2.46
	Channel Net	260,321	\$621,181	\$2.39
	Other	3,615	\$9,156	\$2.53
2001	Trawl	5,066,909	\$11,510,270	\$2.27
	Channel Net	185,567	\$395,426	\$2.13
	Other	1,737	\$5,375	\$3.09
2002	Trawl	9,713,978	\$17,914,977	\$1.84
	Channel Net	250,656	\$436,803	\$1.74
	Other	4,391	\$12,997	\$2.96
2003	Trawl	5,909,728	\$10,508,015	\$1.78
	Channel Net	255,892	\$420,083	\$1.64
	Other	1,751	\$10,980	\$6.27
2004	Trawl	4,730,255	\$9,230,605	\$1.95
	Channel Net	149,933	\$228,586	\$1.52
	Other	628	\$3,662	\$5.83

Table 8.2 continued

Year	Gear Type	Pounds	Nominal Value	Nominal Price per Pound
2005	Trawl	2,223,994	\$4,216,906	\$1.90
	Channel Net	130,710	\$187,292	\$1.43
	Other	2,813	\$4,927	\$1.75
2006	Trawl	5,549,686	\$8,902,927	\$1.60
	Channel Net	181,102	\$227,972	\$1.26
	Other	5,861	\$10,535	\$1.80
2007	Trawl	9,367,837	\$17,625,282	\$1.88
	Channel Net	165,729	\$272,177	\$1.64
	Other	3,664	\$7,876	\$2.15
2008	Trawl	9,167,896	\$18,892,082	\$2.06
	Channel Net	253,530	\$336,822	\$1.33
	Other	2,742	\$17,026	\$6.21
2009	Trawl	5,221,528	\$8,323,544	\$1.59
	Channel Net	180,704	\$195,984	\$1.08
	Other	5,476	\$8,186	\$1.50
2010	Trawl	5,819,567	\$10,499,213	\$1.80
	Channel Net	129,865	\$182,808	\$1.41
	Other	5,903	\$9,378	\$1.59

8.1.1.3 Water bodies

The majority of inshore shrimp are landed from the Pamlico and Core sounds. In every year since 1994 with the exception of 1998 and 2005, the greatest amount of shrimp in terms of pounds and value came from the Pamlico Sound compared to all other trip ticket water bodies. On average from 1994 through 2010, 50% of all shrimp landed in North Carolina came from Pamlico Sound alone. Pamlico Sound and ocean landings south of Cape Hatteras each account for over \$1 million in landings each year.

Table 8.3 shows shrimp landings for all water bodies. Some waterbodies are listed but show no landings for a given year. This does not mean those waterbodies did not have landings, rather these landings were confidential due to the low number of fishermen reporting landings. Landings that were confidential were replaced with an asterisk (*). Also, the names of water bodies and how they are used has changed over time. For example, "Inland Waterway" was separated into "Inland Waterway – Brunswick" and "Inland Waterway – Onslow" in 2003. Ocean landings were separated into landings north and south of Cape Hatteras as well within state waters (0-3 miles) and federal waters (beyond 3 miles).

Table 8.3. Pounds and value of shrimp landed from North Carolina water bodies from 1994 – 2010 (DMF Trip Ticket Program).

Waterbody	1994		Waterbody	1995		Waterbody	1996	
	Pounds	Value		Pounds	Value		Pounds	Value
Bay River	20,051	\$54,588	Bay River	10,021	\$19,981	Bay River	6,052	\$14,227
Bogue Sound	23,344	\$49,666	Bogue Sound	34,345	\$65,670	Bogue Sound	45,689	\$92,839
Cape Fear River	149,791	\$302,735	Cape Fear River	114,261	\$186,101	Cape Fear River	80,380	\$189,547
Core Sound	863,245	\$1,833,609	Core Sound	1,069,213	\$2,272,343	Core Sound	738,052	\$1,689,450
Croatan Sound	7,701	\$17,963	Croatan Sound	13,768	\$36,115	Croatan Sound	6,590	\$18,233
Inland Waterway	50,936	\$105,136	Inland Waterway	110,410	\$191,049	Currituck Sound	*	*
Lockwood Folly	426	\$769	Lockwood Folly	477	\$747	Inland Waterway	84,630	\$171,418
Masonboro Sound	4,638	\$9,160	Masonboro Sound	1,952	\$3,007	Lockwood Folly	*	*
Neuse River	115,689	\$320,348	Neuse River	114,705	\$284,780	Masonboro Sound	5,973	\$12,693
New River	103,078	\$284,059	New River	274,212	\$689,719	Neuse River	111,098	\$311,191
Newport River	166,828	\$311,459	Newport River	275,058	\$386,857	New River	148,264	\$420,006
North River/Back Sound	127,327	\$257,580	North River/Back Sound	196,322	\$417,171	Newport River	125,092	\$270,421
Ocean 0-3 mi, N of Cape Hatt	*	*	Ocean 0-3 mi, N of Cape Hatt	55,686	\$168,765	North River/Back Sound	56,511	\$132,244
Ocean less than 3 miles	1,372,958	\$3,621,439	Ocean 0-3 mi, S of Cape Hatt	337,606	\$862,314	Ocean 0-3 mi, N of Cape Hatt	13,318	\$31,020
Ocean more than 3 miles	277,855	\$763,765	Ocean >3 mi, S of Cape Hatt	17,649	\$48,568	Ocean 0-3 mi, S of Cape Hatt	1,232,910	\$3,176,947
Pamlico River	46,107	\$129,203	Ocean less than 3 miles	1,478,122	\$3,190,104	Ocean >3 mi, N of Cape Hatt	17,361	\$47,795
Pamlico Sound	3,861,546	\$10,720,745	Ocean more than 3 miles	303,217	\$846,978	Ocean >3 mi, S of Cape Hatt	180,351	\$475,093
Roanoke Sound	14,776	\$30,690	Pamlico River	34,756	\$86,079	Ocean less than 3 miles	329,751	\$788,277
Shalotte River	1,807	\$3,550	Pamlico Sound	4,096,435	\$10,313,455	Ocean more than 3 miles	49,752	\$139,211
Stump Sound	8,553	\$21,719	Roanoke Sound	5,632	\$12,482	Pamlico River	23,078	\$64,409
Topsail Sound	29,485	\$71,714	Shalotte River	1,491	\$2,127	Pamlico Sound	1,934,399	\$5,147,444
White Oak River	44,995	\$82,782	Stump Sound	25,546	\$47,594	Pungo River	*	*
			Topsail Sound	59,202	\$139,389	Roanoke Sound	7,896	\$19,462
			White Oak River	39,013	\$46,591	Shalotte River	394	\$907
						Stump Sound	27,088	\$65,601
						Topsail Sound	21,898	\$47,878
						White Oak River	23,825	\$45,008

*Confidential data

Table 8.3 (continued).

	1997			1998			1999	
	Pounds	Value		Pounds	Value		Pounds	Value
Waterbody			Waterbody			Waterbody		
Bay River	16,409	\$40,241	Bay River	1,358	\$2,709	Bay River	27,913	\$69,034
Bogue Sound	17,009	\$33,188	Bogue Sound	41,849	\$70,974	Bogue Sound	48,220	\$94,783
Cape Fear River	138,424	\$273,933	Cape Fear River	82,592	\$150,208	Cape Fear River	118,742	\$214,347
Core Sound	636,805	\$1,423,124	Core Sound	547,488	\$991,584	Core Sound	884,330	\$1,598,475
Croatan Sound	12,539	\$32,250	Croatan Sound	1,389	\$3,541	Croatan Sound	3,793	\$8,370
Inland Waterway	66,675	\$132,363	Inland Waterway	54,768	\$103,877	Inland Waterway	66,506	\$118,763
Lockwood Folly	*	*	Lockwood Folly	*	*	Lockwood Folly	*	*
Masonboro Sound	5,715	\$10,681	Masonboro Sound	4,961	\$8,371	Masonboro Sound	2,266	\$3,359
Neuse River	164,538	\$441,246	Neuse River	83,765	\$177,286	Neuse River	216,933	\$485,133
New River	244,360	\$637,018	New River	259,274	\$661,359	New River	271,883	\$626,671
Newport River	213,818	\$424,734	Newport River	71,793	\$126,734	Newport River	307,504	\$456,164
North River/Back Sound	92,489	\$224,603	North River/Back Sound	27,391	\$53,066	North River/Back Sound	160,649	\$193,871
Ocean 0-3 mi, N of Cape Hatt	21,710	\$66,135	Ocean 0-3 mi, N of Cape Hatt	*	*	Ocean 0-3 mi, N of Cape Hatt	6,638	\$21,241
Ocean 0-3 mi, S of Cape Hatt	1,030,217	\$2,618,449	Ocean 0-3 mi, S of Cape Hatt	1,493,238	\$3,695,714	Ocean 0-3 mi, S of Cape Hatt	2,468,260	\$6,668,902
Ocean >3 mi, N of Cape Hatt	*	*	Ocean >3 mi, N of Cape Hatt	14,516	\$42,554	Ocean >3 mi, N of Cape Hatt	51,502	\$174,186
Ocean >3 mi, S of Cape Hatt	205,008	\$571,483	Ocean >3 mi, S of Cape Hatt	380,907	\$1,002,254	Ocean >3 mi, S of Cape Hatt	236,725	\$584,197
Ocean less than 3 miles	243,964	\$643,232	Ocean less than 3 miles	344,408	\$810,808	Ocean less than 3 miles	67,420	\$214,004
Ocean more than 3 miles	32,609	\$89,485	Ocean more than 3 miles	18,602	\$47,936	Ocean more than 3 miles	5,007	\$17,816
Pamlico River	39,793	\$116,916	Pamlico River	14,664	\$37,008	Pamlico River	43,794	\$120,732
Pamlico Sound	3,722,785	\$10,231,549	Pamlico Sound	1,115,961	\$2,720,014	Pamlico Sound	3,876,433	\$10,191,283
Pungo River	1,303	\$3,186	Roanoke Sound	188	\$432	Pungo River	*	*
Roanoke Sound	8,568	\$21,610	Shallotte River	*	*	Roanoke Sound	1,488	\$3,130
Shallotte River	2,413	\$4,423	Stump Sound	16,038	\$36,091	Shallotte River	423	\$1,067
Stump Sound	29,139	\$65,977	Topsail Sound	36,579	\$73,690	Stump Sound	20,522	\$38,276
Topsail Sound	22,508	\$54,235	White Oak River	23,582	\$37,858	Topsail Sound	72,561	\$134,762
White Oak River	12,986	\$24,579				White Oak River	37,984	\$36,346

*Confidential data

Table 8.3 (continued).

Waterbody	2000		Waterbody	2001		Waterbody	2002	
	Pounds	Value		Pounds	Value		Pounds	Value
Albemarle Sound	*	*	Bay River	5,935	\$13,385	Alligator River	*	*
Bay River	35,348	\$78,560	Bogue Sound	9,906	\$13,484	Bay River	14,070	\$19,787
Bogue Sound	23,875	\$38,291	Cape Fear River	17,850	\$51,779	Bogue Sound	31,389	\$55,013
Cape Fear River	46,058	\$79,380	Core Sound	431,489	\$840,078	Cape Fear River	82,868	\$109,384
Core Sound	464,916	\$901,327	Croatian Sound	*	*	Core Sound	783,852	\$1,235,756
Croatian Sound	40,989	\$96,578	Inland Waterway	51,538	\$91,228	Croatian Sound	10,010	\$18,063
Inland Waterway	79,462	\$148,373	Lockwood Folly	*	*	Inland Waterway	55,313	\$88,650
Lockwood Folly	*	*	Masonboro Sound	1,514	\$3,014	Inland Waterway (Onslow)	2,966	\$3,316
Masonboro Sound	4,212	\$6,594	Neuse River	19,942	\$43,989	Lockwood Folly	*	*
Neuse River	210,970	\$471,504	New River	189,084	\$430,819	Masonboro Sound	3,373	\$5,116
New River	483,739	\$1,350,697	Newport River	176,502	\$241,348	Neuse River	213,697	\$373,058
Newport River	240,583	\$304,680	North River/Back Sound	71,739	\$133,593	New River	428,783	\$871,912
North River/Back Sound	216,045	\$309,372	Ocean 0-3 mi, S of Cape Hatt	1,157,075	\$2,297,258	Newport River	292,696	\$289,219
Ocean 0-3 mi, N of Cape Hatt	36,319	\$98,898	Ocean >3 mi, N of Cape Hatt	*	*	North River/Back Sound	186,314	\$212,358
Ocean 0-3 mi, S of Cape Hatt	1,397,962	\$3,565,804	Ocean >3 mi, S of Cape Hatt	100,069	\$207,035	Ocean 0-3 mi, N of Cape Hatt	*	*
Ocean >3 mi, N of Cape Hatt	29,942	\$84,146	Pamlico River	20,203	\$43,506	Ocean 0-3 mi, S of Cape Hatt	1,288,291	\$2,438,720
Ocean >3 mi, S of Cape Hatt	133,048	\$349,195	Pamlico Sound	2,890,943	\$7,337,235	Ocean >3 mi, N of Cape Hatt	*	*
Pamlico River	44,710	\$109,896	Pasquotank River	*	*	Ocean >3 mi, S of Cape Hatt	60,109	\$137,491
Pamlico Sound	6,708,334	\$17,192,339	Pungo River	*	*	Pamlico River	102,459	\$176,545
Pungo River	6,926	\$17,492	Roanoke Sound	*	*	Pamlico Sound	6,147,806	\$11,977,356
Roanoke Sound	7,298	\$15,750	Shallotte River	6,123	\$11,175	Pungo River	7,870	\$14,036
Shallotte River	896	\$916	Stump Sound	11,795	\$26,157	Roanoke Sound	32,080	\$58,859
Stump Sound	21,888	\$45,115	Topsail Sound	21,888	\$35,865	Shallotte River	*	*
Topsail Sound	39,152	\$84,948	White Oak River	62,361	\$75,401	Stump Sound	48,099	\$84,230
White Oak River	62,164	\$55,872				Topsail Sound	14,383	\$22,975
						White Oak River	137,397	\$128,142

*Confidential data

Table 8.3 (continued).

Waterbody	2003		Waterbody	2004		Waterbody	2005	
	Pounds	Value		Pounds	Value		Pounds	Value
Bay River	2,010	\$3,220	Bay River	*	*	Bay River	1,915	\$4,151
Bogue Sound	127,781	\$155,164	Bogue Sound	18,624	\$31,116	Bogue Sound	12,729	\$21,281
Cape Fear River	101,424	\$162,463	Cape Fear River	32,730	\$37,576	Cape Fear River	46,241	\$66,025
Core Sound	821,174	\$1,390,897	Core Sound	252,813	\$432,071	Core Sound	317,370	\$478,582
Croatan Sound	*	*	Croatan Sound	6,856	\$13,185	Croatan Sound	*	*
Inland Waterway	47,487	\$68,150	Inland Waterway	14,381	\$16,956	Inland Waterway	13,018	\$17,853
Inland Waterway (Brunswick)	18,404	\$28,735	Inland Waterway (Brunswick)	8,633	\$14,820	Inland Waterway (Brunswick)	16,746	\$20,983
Inland Waterway (Onslow)	31,972	\$48,327	Inland Waterway (Onslow)	27,523	\$35,308	Inland Waterway (Onslow)	45,855	\$68,190
Lockwood Folly	*	*	Masonboro Sound	17,722	\$18,722	Masonboro Sound	4,745	\$5,675
Masonboro Sound	6,561	\$7,470	Neuse River	87,384	\$175,348	Neuse River	110,286	\$198,067
Neuse River	102,366	\$166,540	New River	174,901	\$307,111	New River	49,506	\$88,770
New River	230,381	\$454,157	Newport River	125,039	\$139,232	Newport River	70,030	\$95,927
Newport River	142,654	\$190,650	North River/Back Sound	126,873	\$189,306	North River/Back Sound	84,838	\$116,287
North River/Back Sound	117,353	\$175,658	Ocean 0-3 mi, N of Cape Hatt	1,753	\$3,486	Ocean 0-3 mi, S of Cape Hatt	910,709	\$1,835,281
Ocean 0-3 mi, N of Cape Hatt	*	*	Ocean 0-3 mi, S of Cape Hatt	1,569,215	\$2,885,008	Ocean >3 mi, S of Cape Hatt	58,395	\$101,993
Ocean 0-3 mi, S of Cape Hatt	2,008,508	\$3,363,342	Ocean >3 mi, S of Cape Hatt	199,207	\$286,687	Pamlico River	3,903	\$9,235
Ocean >3 mi, N of Cape Hatt	*	*	Pamlico River	6,546	\$18,035	Pamlico Sound	558,104	\$1,204,022
Ocean >3 mi, S of Cape Hatt	242,477	\$413,318	Pamlico Sound	2,104,690	\$4,744,780	Pungo River	*	*
Pamlico River	11,934	\$25,109	Roanoke Sound	6,646	\$11,952	Roanoke Sound	907	\$2,226
Pamlico Sound	2,023,826	\$4,112,575	Shallotte River	*	*	Shallotte River	*	*
Pungo River	*	*	Stump Sound	9,840	\$16,378	Stump Sound	17,202	\$26,420
Roanoke Sound	2,415	\$3,978	Topsail Sound	28,312	\$35,279	Topsail Sound	26,535	\$37,665
Shallotte River	4,333	\$6,063	White Oak River	60,283	\$49,103	White Oak River	6,655	\$8,276
Stump Sound	25,010	\$37,379						
Topsail Sound	43,141	\$69,252						
White Oak River	52,052	\$49,936						

*Confidential data

Table 8.3 (continued).

Waterbody	2006		Waterbody	2007		Waterbody	2008	
	Pounds	Value		Pounds	Value		Pounds	Value
Bay River	*	*	Bay River	858	\$1,655	Bay River	7,144	\$12,386
Bogue Sound	70,432	\$71,766	Bogue Sound	39,385	\$52,532	Bogue Sound	57,928	\$52,670
Cape Fear River	35,843	\$48,556	Cape Fear River	46,124	\$88,767	Cape Fear River	47,264	\$83,755
Core Sound	260,588	\$359,865	Core Sound	241,093	\$361,895	Core Sound	434,900	\$661,196
Croatan Sound	2,421	\$4,639	Croatan Sound	23,961	\$51,981	Croatan Sound	4,761	\$9,375
Inland Waterway (Brunswick)	8,380	\$11,268	Inland Waterway	*	*	Inland Waterway (Brunswick)	19,944	\$39,565
Inland Waterway (Onslow)	57,007	\$60,737	Inland Waterway (Brunswick)	11,512	\$12,372	Inland Waterway (Onslow)	29,588	\$51,941
Masonboro Sound	7,603	\$5,440	Inland Waterway (Onslow)	25,631	\$37,125	Masonboro Sound	*	*
Neuse River	125,952	\$204,414	Lockwood Folly	*	*	Neuse River	391,739	\$666,697
New River	164,411	\$207,266	Masonboro Sound	335	\$413	New River	101,554	\$230,990
Newport River	199,986	\$123,387	Neuse River	139,720	\$207,794	Newport River	118,998	\$101,344
North River/Back Sound	258,670	\$237,022	New River	151,743	\$217,145	North River/Back Sound	145,782	\$138,949
Ocean 0-3 mi, N of Cape Hatt	3,331	\$6,022	Newport River	170,636	\$113,937	Ocean 0-3 mi, N of Cape Hatt	*	*
Ocean 0-3 mi, S of Cape Hatt	1,843,020	\$3,076,473	North River/Back Sound	179,602	\$213,658	Ocean 0-3 mi, S of Cape Hatt	1,787,589	\$4,298,190
Ocean >3 mi, S of Cape Hatt	125,500	\$169,992	Ocean 0-3 mi, N of Cape Hatt	32,734	\$58,075	Ocean >3 mi, N of Cape Hatt	*	*
Pamlico River	3,648	\$6,357	Ocean 0-3 mi, S of Cape Hatt	1,557,680	\$3,201,450	Ocean >3 mi, S of Cape Hatt	183,968	\$496,726
Pamlico Sound	2,477,858	\$4,473,267	Ocean >3 mi, N of Cape Hatt	*	*	Pamlico River	21,779	\$47,761
Pungo River	*	*	Ocean >3 mi, S of Cape Hatt	49,978	\$62,205	Pamlico Sound	5,944,307	\$12,125,633
Roanoke Sound	642	\$1,328	Pamlico River	30,015	\$53,571	Roanoke Sound	2,189	\$3,488
Stump Sound	11,655	\$15,775	Pamlico Sound	6,761,768	\$13,061,121	Stump Sound	31,862	\$53,968
Topsail Sound	18,925	\$22,768	Roanoke Sound	6,059	\$14,006	Topsail Sound	5,435	\$7,306
White Oak River	58,950	\$31,449	Stump Sound	16,497	\$23,204	White Oak River	20,282	\$14,570
			Topsail Sound	10,657	\$12,965			
			White Oak River	24,277	\$23,386			

*Confidential data

Table 8.3 (continued).

Waterbody	2009		Waterbody	2010	
	Pounds	Value		Pounds	Value
Albemarle Sound	*	*	Bay River	2,405	\$4,482
Bay River	4,192	\$6,108	Bogue Sound	34,534	\$47,578
Bogue Sound	31,643	\$38,675	Cape Fear River	137,009	\$179,609
Cape Fear River	44,658	\$71,234	Core Sound	119,470	\$190,405
Core Sound	191,151	\$247,872	Croatan Sound	1,075	\$2,121
Croatan Sound	*	*	Inland Waterway (Brunswick)	30,935	\$36,596
Inland Waterway (Brunswick)	15,873	\$15,426	Inland Waterway (Onslow)	47,345	\$69,708
Inland Waterway (Onslow)	53,465	\$56,075	Masonboro Sound	5,918	\$7,631
Masonboro Sound	*	*	Neuse River	116,953	\$187,205
Neuse River	116,298	\$167,095	New River	144,919	\$222,679
New River	22,552	\$26,134	Newport River	91,966	\$101,949
Newport River	73,951	\$58,068	North River/Back Sound	55,370	\$76,309
North River/Back Sound	65,725	\$80,887	Ocean 0-3 mi, N of Cape Hatt	*	*
Ocean 0-3 mi, N of Cape Hatt	*	*	Ocean 0-3 mi, S of Cape Hatt	1,130,146	\$2,195,822
Ocean 0-3 mi, S of Cape Hatt	860,971	\$1,468,493	Ocean >3 mi, S of Cape Hatt	103,846	\$226,230
Ocean >3 mi, N of Cape Hatt	*	*	Pamlico River	12,813	\$24,691
Ocean >3 mi, S of Cape Hatt	56,211	\$103,912	Pamlico Sound	3,837,536	\$6,988,818
Pamlico River	18,710	\$28,514	Roanoke Sound	429	\$666
Pamlico Sound	3,686,102	\$5,942,139	Shalotte River	*	*
Roanoke Sound	2,607	\$4,134	Stump Sound	19,360	\$28,561
Stump Sound	20,612	\$23,188	Topsail Sound	27,903	\$39,445
Topsail Sound	24,652	\$21,512	White Oak River	15,457	\$16,694
White Oak River	36,720	\$29,610			

*Confidential data

8.1.1.4 Participants and trips

DMF began a new licensing system in 1999. This new system allows for easier identification of specific fishermen with their individual landings by species and the number of trips taken where a given species was landed. Table 8.4 shows the number of participants in the shrimp fishery by year and the ex-vessel value of their landings.

The number of fishermen who participate in the fishery seems to follow the abundance of shrimp or when fishermen are receiving a good price. This indicates that some fishermen are able to rely on other species or other work when shrimping is not as lucrative. The years 1999 and 2000 saw the greatest number of participants in the fishery at over 800, while 2005 had the least number of participants at 400.

On average, from 1999 through 2010, nearly half of all fishermen who caught shrimp had ex-vessel landings values of \$10,000 or less. The percentage of fishermen who landed ex-vessel values of between \$35,000 and \$50,000 remained fairly constant at about 4-7% of all participants. The percentage of fishermen who had ex-vessel landings values between \$50,001 and \$75,000 varied in a given year; however, the general trend was downward across the time frame.

Table 8.4. Number of participants in the shrimp fishery by value of landings and year in North Carolina, 1999 – 2010 (DMF Trip Ticket Program).

	Year											
	1999	2000	2001	2002	2003	2004	2005	2006	2007	2008	2009	2010
\$1-\$1,000	245	280	203	193	115	158	109	105	117	117	117	140
% within year	29%	30%	28%	24%	19%	27%	27%	24%	24%	23%	25%	29%
\$1,001-\$5,000	191	173	158	181	148	140	117	83	92	104	124	102
% within year	23%	18%	22%	23%	25%	24%	29%	19%	19%	20%	27%	21%
\$5,001-\$10,000	85	96	86	78	77	69	52	73	58	46	58	44
% within year	10%	10%	12%	10%	13%	12%	13%	17%	12%	9%	13%	9%
\$10,001-\$20,000	108	118	98	92	90	77	53	52	58	58	47	58
% within year	13%	13%	14%	12%	15%	13%	13%	12%	12%	11%	10%	12%
\$20,001-\$35,000	53	75	60	91	62	53	40	33	21	39	42	36
% within year	6%	8%	8%	11%	10%	9%	10%	8%	4%	8%	9%	7%
\$35,001-\$50,000	30	39	38	39	41	32	12	31	27	38	26	30
% within year	4%	4%	5%	5%	7%	5%	3%	7%	6%	7%	6%	6%
\$50,001-\$75,000	41	42	47	48	44	32	10	33	28	31	12	29
% within year	5%	4%	7%	6%	7%	5%	3%	8%	6%	6%	3%	6%
>\$75,000	80	113	32	76	22	23	7	30	81	82	33	45
% within year	10%	12%	4%	10%	4%	4%	2%	7%	17%	16%	7%	9%
Total Participants	833	936	722	798	599	584	400	440	482	515	459	484
Percent Change		12%	-23%	11%	-25%	-3%	-32%	10%	10%	7%	-11%	5%

Table 8.5 shows the number of fisherman and the number of trips they took in which they landed and sold shrimp for the years 1999 through 2010. From 1999 through 2010 an average of 12% of all participants only had one trip with shrimp landings. An average of 69% of all persons reporting shrimp landings had 20 or fewer trips in a given year. An average of 13% of all fishermen reported taking 41 or more trips per year. Again, abundance of shrimp, prices received for the catch, and weather events such as hurricanes greatly affect the number of trips a fisherman might make for shrimp.

Table 8.5. Number of participants and the number of trips taken that landed shrimp in North Carolina, 1999 – 2010 (DMF Trip Ticket Program).

	Year											
	1999	2000	2001	2002	2003	2004	2005	2006	2007	2008	2009	2010
1 Trip	114	125	93	78	57	62	46	45	66	67	48	64
% within year	14%	13%	13%	10%	10%	11%	12%	10%	14%	13%	10%	13%
2-10 Trips	281	313	251	271	182	199	166	161	151	197	171	197
% within year	34%	33%	35%	34%	30%	34%	42%	37%	31%	38%	37%	41%
11-20 Trips	187	178	160	163	124	113	76	94	97	123	120	107
% within year	22%	19%	22%	20%	21%	19%	19%	21%	20%	24%	26%	22%
21-30 Trips	92	125	81	96	67	84	43	57	70	47	48	40
% within year	11%	13%	11%	12%	11%	14%	11%	13%	15%	9%	10%	8%
31-40 Trips	45	59	38	51	47	38	30	29	36	28	22	26
% within year	5%	6%	5%	6%	8%	7%	8%	7%	7%	5%	5%	5%
41-50 Trips	30	39	28	35	35	26	13	21	20	22	18	17
% within year	4%	4%	4%	4%	6%	4%	3%	5%	4%	4%	4%	4%
51-60 Trips	25	24	19	20	26	21	12	12	15	10	16	13
% within year	3%	3%	3%	3%	4%	4%	3%	3%	3%	2%	3%	3%
61-70 Trips	17	25	18	18	20	13	3	4	11	8	5	8
% within year	2%	3%	2%	2%	3%	2%	0.80%	0.90%	2%	2%	1%	2%
71-80 Trips	13	13	10	23	16	9	1	5	5	6	4	2
% within year	2%	1%	1%	3%	3%	2%	0.30%	1.10%	1%	1.20%	0.90%	0.40%
81-90 Trips	13	17	7	14	11	7	4	4	2	3	2	3
% within year	2%	2%	1%	2%	2%	1%	1%	0.90%	0.40%	0.60%	0.40%	0.60%
91-100 Trips	6	7	9	10	6	4	4	2	1	3	1	2
% within year	0.70%	0.70%	1%	1%	1%	0.70%	1%	0.50%	0.20%	0.60%	0.20%	0.40%
> 100 Trips	10	11	8	19	8	8	2	6	8	1	4	5
% within year	1%	1%	1%	2%	1%	1%	0.50%	1%	2%	0.20%	0.90%	1%
Total	833	936	722	798	599	584	400	440	482	515	459	484

In North Carolina, licensed commercial fishermen are legally obligated to only sell their catch to licensed seafood dealers. Figure 8.4 shows the number of North Carolina seafood dealers who purchased shrimp from commercial fishermen each year from 1994 through 2010. There is a variation in the number of seafood dealers purchasing shrimp from year to year with a low of 208 in 2008 to a high of 284 in 2002. The annual differences are due largely to availability of local shrimp as well as availability and price of imported shrimp.

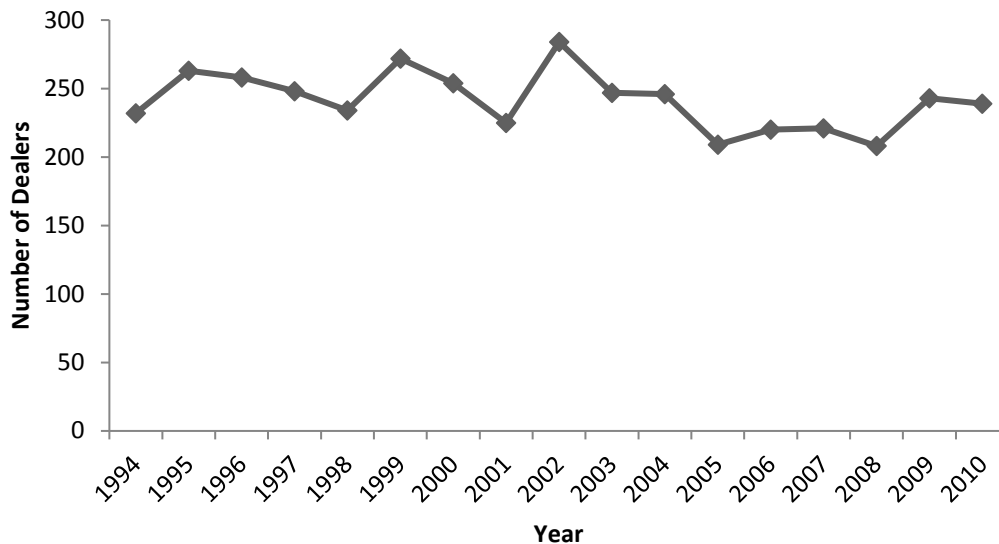


Figure 8.4. Number of seafood dealers who purchased shrimp from 1994 to 2010 (DMF Trip Ticket Program).

Table 8.6 shows the number of fish dealers who purchased specific amounts of shrimp in a given year. An average of 9% of dealers purchased fewer than 100 pounds of shrimp in a given year. About 35% of dealers purchased 1,000 or fewer pounds of shrimp a year. Approximately 23% of dealers purchased more than 20,000 pounds of shrimp from fishermen. Only 9% purchased more than 100,000 pounds of shrimp.

Table 8.6. Number of seafood dealer and pounds of shrimp purchased by North Carolina fish dealers from North Carolina fishermen, 1994 – 2010 (DMF Trip Ticket Program).

Pounds	Year																
	1994	1995	1996	1997	1998	1999	2000	2001	2002	2003	2004	2005	2006	2007	2008	2009	2010
100 Pounds or less	18	27	22	22	26	28	28	23	23	20	13	17	24	28	14	21	21
% within year	8%	10%	9%	9%	11%	10%	11%	10%	8%	8%	5%	8%	11%	13%	7%	9%	9%
101-500 Pounds	37	35	50	30	36	56	47	40	47	25	44	39	30	30	29	37	40
% within year	16%	13%	19%	12%	15%	21%	19%	18%	17%	10%	18%	19%	14%	14%	14%	15%	17%
501-1,000 Pounds	26	25	21	30	30	23	21	24	31	23	22	29	24	16	16	21	28
% within year	11%	10%	8%	12%	13%	8%	8%	11%	11%	9%	9%	14%	11%	7%	8%	9%	12%
1,001-2,000 Pounds	19	31	28	32	26	31	26	22	41	39	24	25	21	24	26	39	23
% within year	8%	12%	11%	13%	11%	11%	10%	10%	14%	16%	10%	12%	10%	11%	13%	16%	10%
2,001-5,000 Pounds	31	35	43	36	32	35	36	34	39	36	38	33	35	36	38	42	39
% within year	13%	13%	17%	15%	14%	13%	14%	15%	14%	15%	15%	16%	16%	16%	18%	17%	16%
5,001-10,000 Pounds	19	21	19	17	16	17	16	19	23	29	37	20	26	29	20	31	29
% within year	8%	8%	7%	7%	7%	6%	6%	8%	8%	12%	15%	10%	12%	13%	10%	13%	12%
10,001-20,000 Pounds	17	21	17	22	14	15	18	13	21	18	17	14	20	17	20	14	17
% within year	7%	8%	7%	9%	6%	6%	7%	6%	7%	7%	7%	7%	9%	8%	10%	6%	7%
20,001-35,000 Pounds	12	8	11	8	12	11	11	10	12	13	14	10	9	9	10	9	11
% within year	5%	3%	4%	3%	5%	4%	4%	4%	4%	5%	6%	5%	4%	4%	5%	4%	5%
35,001-50,000 Pounds	9	7	18	11	13	6	5	5	5	10	7	5	4	4	2	2	5
% within year	4%	3%	7%	4%	6%	2%	2%	2%	2%	4%	3%	2%	2%	2%	1%	1%	2%
50,001-75,000 Pounds	13	9	6	12	8	7	6	9	6	7	8	8	4	2	5	5	8
% within year	6%	3%	2%	5%	3%	3%	2%	4%	2%	3%	3%	4%	2%	1%	2%	2%	3%
75,001-100,000 Pounds	9	18	9	6	8	8	9	8	3	5	5	6	7	5	5	6	5
% within year	4%	7%	3%	2%	3%	3%	4%	4%	1%	2%	2%	3%	3%	2%	2%	2%	2%
100,001-150,000 Pounds	10	9	5	10	6	17	10	11	11	8	9	3	4	3	7	8	4
% within year	4%	3%	2%	4%	3%	6%	4%	5%	4%	3%	4%	1%	2%	1%	3%	3%	2%
150,001-200,000 Pounds	3	7	5	5	2	10	5	4	8	8	5	0	6	4	3	2	3
% within year	1%	3%	2%	2%	1%	4%	2%	2%	3%	3%	2%	0%	3%	2%	1%	1%	1%

Table 8.6. (continued).

Pounds	Year																
	1994	1995	1996	1997	1998	1999	2000	2001	2002	2003	2004	2005	2006	2007	2008	2009	2010
More than 200,000 Pounds	9	10	4	7	5	8	16	3	14	6	3	0	6	14	13	6	6
% within year	4%	4%	2%	3%	2%	3%	6%	1%	5%	2%	1%	0%	3%	6%	6%	2%	3%
Total	232	263	258	248	234	272	254	225	284	247	246	209	220	221	208	243	239
Percent change		13%	-2%	-4%	-6%	16%	-7%	-11%	26%	-13%	0%	-15%	5%	0%	-6%	17%	-2%

8.1.1.5 Processing

Some dealers will go so far as to head shrimp for customers, but a large portion of the commercial shrimp catch is sold heads-on. Shrimp that cannot be sold fresh are frozen. A few dealers sell shrimp to be processed into other consumable products such as frozen breaded shrimp; however, there are no known shrimp processors currently operating in North Carolina.

8.1.1.6 Marketing and distribution

Seafood dealers sell shrimp to other dealers, restaurateurs, retail outlets, and directly to the consumer. There is no specific information available as to how much North Carolina shrimp is sold through each of these venues.

According to the US Department of Commerce (2011) there were four pounds of shrimp consumed per capita by Americans in 2010. According to the U.S. Census Bureau, there were 9,535,483 residents of North Carolina in 2010.

Using these two statistics provides an estimate that approximately 38 million pounds of shrimp were consumed by North Carolina residents in 2010, over six times the total weight of shrimp caught from North Carolina waters. If all shrimp caught in North Carolina remained in the state, it would only supply one sixth of the state's consumption needs. There is a large reliance on shrimp imported into North Carolina from other states and foreign countries. Thus, it appears imports represent a double-edged sword. On the one hand, they have increased the supply, and also demand due to the downward pressure on price. On the other hand, the effect on price has greatly diminished the economic returns to domestic fishermen. One result is that some fishermen have looked for more land-based work. In other cases, wives have taken full time jobs to supplement their family's income (Maiolo 2004). In some cases fishermen are becoming dealers to sell their catches to niche markets, thereby obtaining higher prices.

Supply and demand largely determine the price per pound paid to shrimp fishermen. Farm raised imports, mostly from Asia and Latin America, have expanded to meet increasing demand and, indeed, appear to have fostered it. Following the poor domestic harvest years of the late seventies and early eighties, imports had increased from fairly modest levels to 341 million pounds in 1983, 500 million in 1989 and 1990, and 759 million pounds in 2000 (Maiolo 2004). The impact of imports has been especially hard on shrimp fishermen since 2001. In that year, price per pound dropped 24% over the previous year. In 2002, the price dropped an additional 32% over the 2001 price received by fishermen. A small gain was realized in 2003 when the price per pound increased by about 13% over the 2002 price. Nonetheless, with the exception of 2008, the price per pound has remained under \$2.00. The price per pound reduction received by fishermen since 2000 can largely be attributed to the impact of imports. In recent years, imports of shrimp have remained above 1 billion pounds per year, with approximately 1.6 billion pounds of shrimp imported into the US in 2010 (NOAA 2011).

Concerned about the rising tide of imports, a group of shrimp industry individuals from the Gulf and South Atlantic formed the Southern Shrimp Alliance (SSA), made up of the shrimp producing states from North Carolina through Texas. The SSA hired two firms: one to do research for possible trade actions, and the other for lobbying.

The SSA decided to file petitions with the Federal government alleging several countries had been dumping shrimp on the US market at below cost. SSA filed trade action against six countries, and the petition was filed on December 31, 2003. Preliminary anti-dumping duties were imposed by the US Department of Commerce in July of 2004. The duties ranged from 3.4% to 67.8% on companies from the countries of Brazil, Ecuador, India, and Thailand. Furthermore, The Commerce Department found that shrimp from China and Vietnam were dumped on US markets at a rate of up to 113% below cost (NCFA 2004).

Additionally, the lobbying efforts of SSA helped to persuade the United States Congress in 2003 to set aside \$35 million to offset the economic losses suffered by shrimp fishermen from southeastern states. North Carolina received \$4.9 million of the total. Of the total, \$4.1 million was sent directly to fishermen based on their trip ticket receipts from licensed dealers that reported landings during the 2002 calendar year. Six hundred and eighty-two checks were mailed out ranging from \$7 to \$64,206; the average amount of assistance per vessel was \$5,906. Approximately \$42,000 was used by DMF to cover the costs of administering the program. Another \$160,000 of unclaimed fisherman disaster assistance funds and unused administrative services funds were channeled to the SSA on behalf of NC shrimp fishermen for legal efforts used to convince the federal government to impose tariffs on countries convicted of illegally dumping shrimp onto US markets.

Approximately \$600,000 (13.3%) of the Federal shrimp economic assistance program of 2003 was given to the North Carolina Department of Agriculture (NCDA) to develop a three-year marketing program for marketing wild-caught North Carolina shrimp. The money was used to market North Carolina wild-caught shrimp in trade and consumer publications, billboards, statewide radio and television promotions, in-store consumer awareness, recipe cards, and trade show participation. However, no additional Federal aid has been given to the NCDA to market wild-caught shrimp since 2003. The NCDA continues to market North Carolina wild-caught shrimp through the "Freshness from North Carolina Waters" seafood promotion program in various consumer and wholesaler publications and radio promotional campaigns during shrimp season (J. Aydlett, NCDA. pers. com. 2012). There are also several local programs such as, Brunswick Catch, Ocracoke Fresh, Carteret Catch, and Outer Banks Catch that promote North Carolina caught shrimp and seafood.

According to the SSA, the benefits of trade relief have not been apparent to many in the industry. Although there is increased stability in the market and declining shrimp prices have slowed, the amount shrimpers receive for their catch continues to be low. The millions collected in anti-dumping duties has been distributed to the domestic industry have overwhelmingly benefited shrimp purchasers and not fishermen. Thus, despite the influx of substantial funds into the hands of purchasers of shrimp, what shrimpers receive for their catch has continued to decline.

8.1.1.7 Economic impact of commercial fishery

In 2010, commercial shrimp landings accounted for about 15% of all the total weight and 23% of the total value of commercial shellfish landed in North Carolina. When finfish are included, shrimp accounted for 8% of the total weight and 13% of the total value of commercial seafood landings in North Carolina. The expenditures and income within the commercial fishing industry in North Carolina produce ripple effects in the state's economy. Each dollar earned and spent within the industry generates additional economic impacts by stimulating further activity in other industries which fosters jobs, income, and economic output. These impacts are calculated using IMPLAN, an economic modeling software. This software uses an input-output model to

estimate economic impacts as dollars are spent and re-spent in the state economy. In 2010, the commercial shrimp fishery in North Carolina contributed, directly and indirectly, approximately \$17.7 million to the state's economy (Table 8.7). These estimates are limited and must be viewed as conservatively low, as they do not include the economic impacts of the wholesale (seafood dealers and distributors), retail, and foodservice sectors due to lack of specific economic data for those sectors in North Carolina.

Table 8.7. Economic impact of the commercial shrimp fishery in North Carolina, 2010.

Economic inputs	\$10,691,399
Additional economic activity	\$6,964,822
Additional jobs supported	56
Total economic impact	\$17,656,221

8.1.2 Recreational fishery economics

There are two survey programs in North Carolina that collect economic data from coastal recreational fishermen. The Marine Recreational Information Program (MRIP) collects data from anglers and includes ocean landings from the coast and inside waters from the Virginia state line to the South Carolina border. Additionally, the DMF conducts creel surveys of anglers in the Cape Fear, Neuse, Pamlico, Tar, and Pungo Rivers. In the past, the DMF also collected data from recreational fishermen who are licensed to use limited amounts of commercial gear through the Recreational Commercial Gear License (RCGL). However, the RCGL survey was discontinued in 2008 due to budget cuts. See the Recreational Section (6.2) for additional information.

8.1.2.1 Marine Recreational Information Program (MRIP)

MRIP captures catch and angler participation data for finfish only. No data from any shellfish species are collected. However, some anglers may catch limited amounts of shrimp for bait using a cast net. There are no data on the economic value of this practice. Additionally, there are several live shrimp bait dealers, as live shrimp have become a popular bait among spotted sea trout fishermen. This live bait market has grown considerably, as a result, over the past 10 years.

8.1.2.2 Recreational use of commercial gear (RCGL)

Along with the heavy participation of part time commercial fishermen in the shrimp industry, the recreational use of commercial gear has had a long and contentious history. Prior to the Fisheries Reform Act of 1997, there was a growing number of participants in both user categories resulting in increased competition in the shrimp fishery. In 2002, the DMF began interviewing recreational fishermen who had purchased a license that allows them to use limited amounts of commercial gear (RCGL). These fishermen were and still are prohibited from selling their catch as it is intended solely for personal use. The RCGL holder surveys did not specifically determine the final disposition of the shrimp landed by these anglers. However, it is presumed that they use the shrimp primarily for personal consumption. This survey program ended in 2008 due to loss of funding.

Table 8.8 gives an indication of the direct economic impact of the recreational shrimp fishery by RCGL fishermen in 2007. The data are separated by those who made overnight trips as opposed to those who made day trips. In the case of the shrimp trawl fishery, the majority of fishing does occur at night. A day trip is one in which a person left their home specifically for one fishing trip and then returned to their regular residence once the fishing activity was completed. An overnight trip is defined as one in which the fishermen spent a longer period of time away from home.

Table 8.8. Economic impact of RCGL fishing trips for shrimp in 2007 (DMF RCGL Survey).

	Overnight Trips	Day Trips
Avg. # of nights	3.98	
Avg. # of miles traveled	133.19	40.3
Avg. # of people on the trip	2.54	2.25
Avg. cost of lodging/night	\$45.78	
Avg. cost of food/trip	\$83.11	\$16.49
Avg. cost of ice/trip	\$10.34	\$4.93
Avg. cost of fuel & oil/trip	\$85.90	\$39.98

The economic figures are based on an expansion of the actual values reported by RCGL fishermen and are considered the best available estimates. The direct economic impacts described below are those that can be attributed only to shrimp landings by these fishermen. In some instances, the fishermen and the non-fishers who accompanied them, engaged in other, non-fishing activities. The total expenditures were adjusted based on the average proportion of people on the trip who actually engaged in fishing activity.

The expenditures shown in Table 8.8 relate to the overall proportion of shrimp landed. Other species were typically caught and kept along with the shrimp. The economic impact was based on the percent of shrimp in the total pounds of all species kept by the fishermen on any given trip where shrimp were landed. Shrimp accounted for 84% of the total catch on trips in which shrimp were landed. Expenditures by those who made overnight trips tended to be greater when compared to day trips because of the increased costs of lodging and meals. An average overnight trip lasted approximately 4 days and resulted in total expenditures of \$362.47 attributable to shrimp landings. Day trip RCGL anglers targeting shrimp had an average trip expenditure of \$61.40. RCGL anglers targeting shrimp took 2,096 trips in 2007. The total combined expenditures were approximately \$202,861. Lodging expenditures were left out of this estimate, as the sample size within the survey was too low (9 observations). The total combined economic impact of all RCGL trips for shrimp in 2007 was \$250,583.

8.1.2.3 Other Recreational Fisheries

Some people use cast nets to catch shrimp for personal consumption in addition to those who use cast nets to land shrimp for bait. Currently there are no data on these landings or their economic impacts, however there are ongoing attempts to survey recreational anglers who use cast nets.

9.0 SOCIOECONOMIC CHARACTERISTICS

9.1 SOCIAL IMPORTANCE OF THE FISHERY

9.1.1 Commercial fishermen

There are two primary sources of recent data or accounts available that help to explain the social importance of the commercial fishery. First is a book published on the shrimp industry in North Carolina, *Hard Times and a Nickel a Bucket: Struggle and survival in North Carolina's Shrimp Industry* (Maiolo 2004). Secondly, researchers at the DMF have been conducting in-depth socioeconomic interviews with commercial fishermen since 1999. More than 1,000 fishermen have been interviewed to date. In these nearly identical surveys, 175 fishermen within the most current dataset identified themselves as shrimp fishermen.

9.1.1.1 Historical importance

Elsewhere in this document is a history of the commercial shrimp fishery in North Carolina. The DMF surveys asked the fishermen for their opinion as to how historically important they think commercial fishing is to their community. On a scale of one to ten, with one being not at all important to ten being extremely important, the average rating across all 175 persons interviewed was 9.7, indicating almost universal agreement that fishing has been historically important to their community. When asked how much does their community support commercial fishing now (using the same 10-point scale), the rating was 8.1, indicating they largely feel supported.

9.1.1.2 Community reliance on the commercial fishery

North Carolina coastal communities rely significantly less on commercial fishing now than in the past (Maiolo 2004). This is the result of the development of the communities as multiple use zones, with retirement, light industry, recreation, and tourism becoming the dominant domains of the local economies. Fewer and fewer native born residents make a full time living as fishermen like those in previous generations. DMF studies found that among commercial shrimp fishermen, the average fisherman earned about 76% of his or her income from commercial fishing. More specifically the studies found that just over half (51%) were totally reliant on fishing for their incomes. This compares with data gathered in the late 1980s where nearly all full time fishermen were committed to fishing for nearly all (95%) of their income (Maiolo 2004).

The 175 shrimp fishermen in the DMF surveys came from 47 separate coastal communities. Table 9.1 shows the communities that had the greatest number of shrimp fishermen who participated in the survey. The largest number of fishermen in the surveys who fished for shrimp came from Sneads Ferry, followed by Beaufort, Supply, Atlantic, and Belhaven, all communities known to have sizable shrimp fleets.

Table 9.1. Most frequently cited communities where shrimp fishermen live (DMF Socioeconomics Program).

Community	Percent of Respondents
Sneads Ferry	11.60%
Beaufort	9.20%
Supply	9.20%
Atlantic	5.20%
Belhaven	4.60%
Wilmington	4.60%
Cedar Island	4.00%
Morehead City	3.50%
Wanchese	3.50%
Engelhard	3.50%
Harkers Island	3.50%
Sea Level	2.90%
Kill Devil Hills	2.30%
Marshallberg	2.30%
Newport	2.30%
Other	27.70%

Studies in the 1970s and 1980s revealed that shrimp fishermen engage in a variety of both land and water based activities. Fishing activities required moving from one target species to another as opportunities prevailed, even though shrimping involved most of the effort throughout the year (Maiolo 2004). DMF found that shrimp fishermen continue to engage in a variety of capture activities throughout the year. Like most of North Carolina's commercial fishermen, these fishermen tend to diversify the species they target, gears they use, and water bodies they fish. Shrimp constituted an average of 59% of the fishing income earned by these fishermen. Table 9.2 shows the preference for other species targeted and the average percent of fishing income earned by the 175 shrimp fishermen who participated in the surveys. Other species frequently targeted by these fishermen included blue crabs (*Callinectes sapidus*), clams (*Mercenaria mercenaria*), oysters (*Crassostrea virginica*), flounder (*Paralichthys spp.*), spot (*Leiostomus xanthurus*), and striped mullet (*Mugil cephalus*).

Table 9.2. Other prevalent species targeted by shrimp fishermen and average percent of fishing income made from non-target species (DMF Socioeconomics Program).

Species	Percent who land
Shrimp	100%
Blue Crabs	35%
Clams	29%
Oysters	29%
Flounder	28%

Table 9.2 (continued).

Species	Percent who land
Spot	24%
Striped Mullet	11%
Speckled Trout	10%
Croaker	8%
Scallops	5%
Whiting	4%
Bluefish	3%
Weakfish	3%
Striped Bass	3%

9.1.1.3 Perceived conflicts

There are largely two kinds of conflicts that have been measured, those between commercial fishermen and those between commercial fishermen and others who use the water. Conflicts between the users of the public resource are not uncommon, as no one individual owns the water, yet all citizens own the water and its resources. Conflicts tend to be reported more frequently as the demand for use of the resource increases.

Extensive competition, and often ill will between the full time fishermen, part time fishermen, and recreational fishermen, characterized the shrimp fishery according to research conducted in the seventies and eighties. At that time the competition was most intense in the estuaries in July, when shrimping was at its peak. The part timers and recreational users viewed ownership of the resource as much theirs as that of the full timers (Maiolo 2004).

Maiolo (2004) reported that because many commercial fishermen feel it is their inherent right to sell what they can catch, they frequently are in favor of regulatory actions that limit the activities of fishermen other than themselves. However, not all conflicts are resolved by relying on governmental regulatory agencies. In some areas of the state there is potential for conflicts between shrimp channel net fishermen and shrimp trawl fishermen. It is worth noting that off of Harkers Island in Carteret County, the channel net and trawl fishermen have a solution that works for all concerned. Channel netters stay far enough away from each other so that each is still able to land a reasonable catch. Channel netters carry lights that allow them to signal trawlers as to where they are working. In Sneads Ferry, fishermen commonly leave their net anchors out all season, often marked by cans. Although not mandated by outside regulatory authorities, actions such as these allow the channel netters and trawl fishermen to work in the same area and minimize conflicts within and between user groups (Maiolo 2004).

One of the purposes of the Fishery Reform Act was to address the intense and often uncontrolled competition and conflict between and among the user groups, and recent data indicate there has been some success in this area. The majority of the shrimp fishermen interviewed by DMF reported not having any conflicts at all within the past year (63%). The most common conflict reported was regarding state regulations (26%), followed by federal regulations (21%), and conflicts with other recreational (13%) and commercial (13%) fishermen (Figure 9.1). Several fishermen reported more than one type of conflict; therefore, the percentages do not add up to 100%.

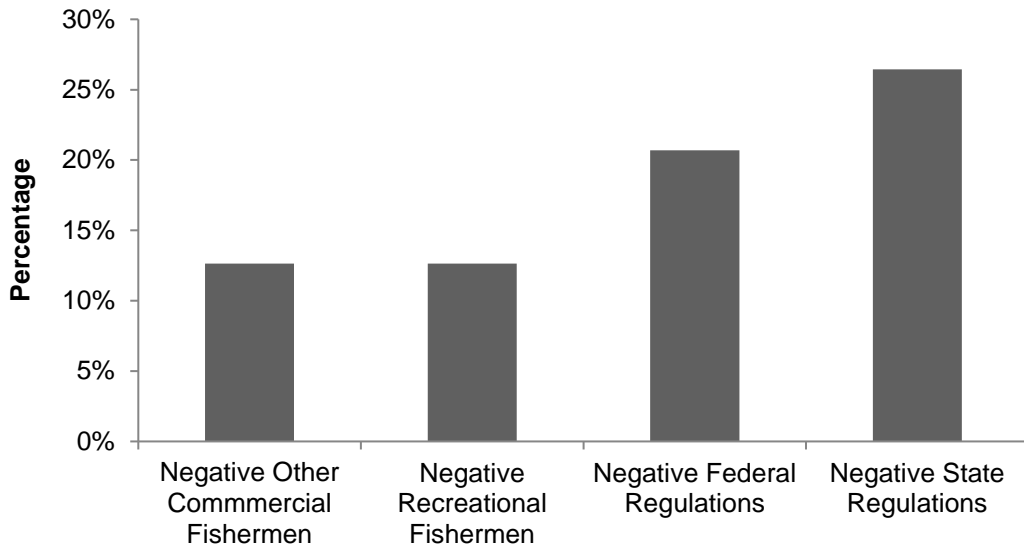


Figure 9.1. Reported conflicts of North Carolina Shrimp Fishermen (DMF Socioeconomics Program).

9.1.1.4 Perception of important issues

Shrimp fishermen interviewed by DMF were asked to state the business issues they found to be the most important. The most important issue to these fishermen was competition from imported seafood. Not surprising, these fishermen stated that low prices for seafood was a very important issue as well, followed closely by a feeling that state regulations were a major issue. Table 9.3 lists the 12 most commonly cited issues facing shrimp fishermen at the time of the survey. While the rising cost of fuel did not make this list, the rising cost of fuel has been cited as a major concern of commercial fishermen (all fisheries included) in past surveys. In 2007, “fuel price” was first added to the survey questionnaire as a possible issue of concern and was found to be the top concern of commercial fishermen in Core Sound (Crosson 2007b). Fuel prices were also found to be the top concern of commercial fishermen in 2008 and 2009 (Crosson 2009). The influence of rising fuel prices and cheap imported shrimp are major contributors to the decline in effort seen in the fishery since 2005.

Table 9.3. Fishing related issues considered most important to shrimp fishermen (DMF Socioeconomics Program).

Ranking	Issue
1	Imported seafood
2	Low prices for seafood

Table 9.3 (continued).

Ranking	Issue
3	State regulations
4	Weather
5	Federal regulations
6	Gear restrictions
7	Keeping up with rules and proclamations
8	Closed seasons
9	Bag limits
10	Quotas
11	Size limits
12	Overfishing

9.2 RECREATIONAL FISHERY

All data regarding the social importance of the fishery come from the last annual socioeconomic survey of RCGL fishermen conducted in 2007.

9.2.1 Historical importance

North Carolina has a long history of fishermen using commercial gear for recreational purposes. The RCGL license was put into effect in 1999 as a result of the Fisheries Reform Act of 1997. Prior to that, recreational fishermen who wished to use commercial gear purchased a commercial vessel license, but did not sell their catch. The RCGL fishermen who reported landing shrimp stated that they had been fishing commercial gear on average for 20 years. It is likely that using shrimp trawls for personal harvest has been occurring ever since commercial fishermen have been harvesting shrimp using trawls.

9.2.2 Community reliance on the recreational fishery

There are no data available to indicate the level of community reliance on the recreational shrimp fishery.

9.2.3 Perceived conflicts

Twenty eight percent of the RCGL fishermen felt that there was too much fishing gear in the water where they fish. An additional 19% weren't sure if there was too much gear in the areas where they fish. The remaining 53% felt that there wasn't too much gear in the water. Over 73% of all RCGL fishermen who land shrimp say they do not have any conflicts with commercial fishermen. Nearly 90% of them stated they do not have conflicts with recreational anglers.

9.2.4 Perception of important issues

RCGL fishermen were asked for their opinions about two issues they find to be important. Of those who land shrimp, 72% agreed with the statement that they ought to be allowed to use more commercial gear. An additional 6% disagreed indicating they felt they were allowed to use plenty of gear, while 22% indicated they were not sure whether they should be allowed to use more gear.

9.3 DEMOGRAPHIC CHARACTERISTICS

9.3.1 Commercial fishermen

Table 9.4 shows a summary of the demographic characteristics of the 175 shrimp fishermen interviewed by NCDMF. Nearly all of the shrimp fishermen were white males. They averaged 50 years old and had over 30 years fishing experience. The average shrimp fisherman was currently married and had at least a high school education. Approximately 29% of the fishermen had incomes of \$15,000 to \$30,001. Another 27% had total household incomes of \$30,001 to \$50,000.

Approximately 39% of the fishermen interviewed said they fished all year long. Of those who didn't fish all year, fishing activity was lowest from January through March. The peak fishing participation months for these fishermen were May through November. Fifty one percent of the fishermen indicated that fishing was their sole source of income. Of those who had other sources of income, the most frequently cited sources of additional income included carpentry, machinery mechanic, government, and retirement pensions.

Table 9.4. Demographic characteristics of commercial shrimp fishermen (DMF Socioeconomics Program).

Variable	Category Values	Average or Percent
Years Fishing		30.17 years
Age		50.46 years
Gender	Male	97%
	Female	3%
Race	White	96%
	Black	2.90%
	Hispanic	1.10%
Education Level	Less than HS	31.79%
	HS Grad	49.71%
	Some College	12.72%
	College Graduate	5.78%

Table 9.4. (continued).

Variable	Category Values	Average or Percent
Marital Status	Married	72.70%
	Divorced	15.10%
	Widowed	3.50%
	Never Married	6.40%
	Separated	2.30%
Total Household Income	Less than \$15,000	16.10%
	\$15,001 - \$30,000	28.70%
	\$30,001 - \$50,000	27.00%
	\$50,001 - \$75,000	14.90%
	More than \$75,000	6.32%
	Refused to answer	6.90%

9.3.2 Recreational fishermen

The average RCGL holder who targeted shrimp was 52.57 years old and 75% were born in North Carolina (Table 9.5). The vast majority were males. Most of these fishermen had at least some college education and had total household incomes of greater than \$30,000 per year. On average they had been using commercial gear for nearly 20 years.

Table 9.5. Demographic characteristics of RCGL holders who targeted shrimp in 2007. (DMF RCGL Survey Program).

Variable	Category Values	Average / Percent
Years of Experience Fishing		
Commercial Gear		19.8
Born in NC		75%
Age	<16 years	1%
	17 to 25	5%
	26 to 40	18%
	41 to 60	43%
	>60 years	33%
Marital Status	Married	72%
	Divorced	13%
	Widowed	5%
	Separated	2%
	Never Married	8%

Table 9.5 (continued).

Variable	Category Values	Average / Percent
Ethnic Group	Caucasian/White	98%
	Native American	2%
Gender	Male	94%
	Female	6%
Education	< High School	17%
	High School Diploma	25%
	Some College	33%
	College Diploma	25%
Total Household Income	< \$5,000	2%
	\$5,000 to \$15,000	6%
	\$15,001 to \$30,000	15%
	\$30,001 to \$50,000	24%
	\$50,001 to \$75,000	27%
	\$75,001 to \$100,000	15%
	> \$100,000	11%

9.4 DEFINITIONS

Commercial fishing – Fishing in which fish harvested, either in whole or in part, are intended to enter commerce or enter commerce through sale, barter or trade. Since 1994, a commercial fisherman in North Carolina is required to have a license issued by the North Carolina Division of Marine Fisheries (DMF) and is allowed only to sell to a licensed dealer.

Fishing trip – A period of time over which fishing occurs. The time spent fishing includes configuring, deploying, and retrieving gear, clearing animals from the gear, and storing, releasing or discarding catch. When watercraft are used, a fishing trip also includes the time spent traveling to and from fishing areas or locales and ends when the vessel offloads product at sea or returns to the shore. When fishing from shore or man-made structures, a fishing trip may include travel between different fishing sites within a 24-hour period.

Inflation-adjusted price and value – Inflation is a general upward price movement of goods and services in an economy, usually as measured by the Consumer Price Index (CPI). Ex-vessel prices and values can be adjusted (deflated) according to the CPI to remove the effects of inflation so that the value of a dollar remains the same across years. Inflation adjusted values allow for easier comparison and analysis of changes in values over time.

Nominal (Ex-Vessel) Value and Price- The total landed dollar amount of a species (or species landing condition and market category) in a given year. Example: 100 lbs. of shrimp at a PRICE of \$.50 per pound will have a VALUE of \$50 in the year the catch was landed. These values represent the amounts paid to a fisherman by a seafood dealer.

Recreational fishing – A recreational fishing trip is any trip for the purpose of recreation from which none of the catch is sold or bartered. This includes trips with effort but no catch. Fishermen who wish to use limited amounts of commercial fishing gear to harvest fish for personal consumption in joint and coastal waters under DMF jurisdiction are required to have a RCGL.

10.0 ENVIRONMENTAL FACTORS

10.1 HABITAT

Penaeid shrimp utilize a variety of estuarine and coastal ocean habitats as described in the life history section with variations in habitat preference due to location, season, and ontogenetic stage. Penaeid shrimp are found in most habitats identified by the North Carolina Coastal Habitat Protection Plan (CHPP) including: water column, wetlands, submerged aquatic vegetation (SAV), soft bottom, and shell bottom (Deaton et al. 2010). Each habitat is part of a larger habitat mosaic, which plays a vital role in the overall productivity and health of the coastal ecosystem. The CHPP focuses on the overall fish habitat and threats to the habitat while this FMP section describes habitat conditions, threats, or needs for the various life stages of penaeid shrimp. Although penaeid shrimp are found in all of these habitats, except for hard bottom, the usage varies by habitat. Additionally, these habitats provide the appropriate physicochemical and biological conditions necessary to maintain and enhance the penaeid shrimp population. The environmental preferences (salinity, temperature, oxygen, and substrate) were described in the Life History section. The slightly different preferences in bottom substrate and salinity affect their general position in the estuary and ocean. Each habitat provides ecological services that aid in maintaining and enhancing shrimp stock sustainability, and also influences the functioning of the ecosystem overall. Protecting the integrity of the entire system is therefore necessary to manage this species. Although ecosystem protection is of vital importance to penaeid shrimp, it may be difficult to detect a cause and effect relationship between habitat protection and enhancement and shrimp stock condition due to the large natural variation in environmental conditions in North Carolina, and the relatively short life cycle of penaeid shrimp.

The SAFMC designated inshore estuarine nursery areas, offshore marine habitats used for spawning and growth to maturity, and all connecting waterbodies as Essential Fish Habitat for penaeid shrimp (SAFMC 1998). Inshore nursery areas listed by SAFMC included wetlands, SAV, and subtidal and intertidal non-vegetated bottom (soft bottom). Designated Habitat Areas of Particular Concern (HAPC) for penaeid shrimp include all coastal inlets, all state designated nursery habitats used by shrimp, and state-identified overwintering areas. In North Carolina, specific HAPC includes SAV and estuarine shorelines. In areas lacking SAV, marsh with shell hash and mud bottoms and adjoining bottoms are of particular concern (SAFMC 1998).

10.1.1 Water column

Water column habitat is defined as “the water covering a submerged surface and its physical, chemical, and biological characteristics” (Deaton et al. 2010). Adult shrimp spawn offshore in ocean waters. Brown and pink shrimp spawn in deep water over the continental shelf, while white shrimp remain nearshore in relatively shallow water (SAFMC 1993). Adult shrimp are demersal oriented in all life stages, except as larvae and post-larvae. Larvae and post-larvae depend on ocean currents to be transported through inlets into estuarine nursery grounds. Inlets are critical bottlenecks through which shrimp and many other ocean-spawned larvae must pass to complete their life cycle (Hettler and Barker 1993). Inlets accessing Pamlico Sound are limited in number and therefore are particularly important to recruitment into Pamlico Sound and its tributaries. The time of spawning varies with species, with brown shrimp spawning earliest in winter and early spring, and white and pink shrimp spawning in late spring and early summer (Table 10.1). Shrimp are transported by water circulation throughout the estuary and back into the ocean. Water quality in estuarine waters affects the viability of shrimp populations.

Table 10.1 Spawning seasons for Penaeid shrimp species in North Carolina (Pattilo et al. 1997).

Species	Spawning season
Brown shrimp	Feb-Apr
Pink shrimp	Apr-Jul
White shrimp	May-Jul

10.1.2 Wetlands

Wetlands are defined as “areas that are inundated or saturated by an accumulation of surface or groundwater at a frequency and duration sufficient to support, and under normal circumstances do support, a prevalence of vegetation typically adapted for life in saturated soil conditions” (federal regulations [40 CFR 230.3(t)]; Environmental Management Commission (EMC) rules [15A NCAC 2B .0202(71)], and Deaton et al. 2010). Estuarine wetlands, which include salt and brackish marsh and estuarine shrub/scrub, generally occur along the edge of estuaries and sounds. Riverine wetlands, which include freshwater marshes, bottomlands, hardwood forest, and swamp forest, generally occur in low-salinity to fresh water along streams, creeks, and rivers. It is estimated that over 95% of commercially harvested finfish and invertebrates in the United States are wetland dependent, a strong indication of their high habitat value (Feierabend and Zelanzy 1987).

The combination of shallow water and thick vegetation provides excellent nursery and foraging habitat for juvenile shrimp and many other fish species (Graff and Middleton 2003). Shallow wetlands also provide refuge from large fish predators and a safe corridor for migration to other habitats within the system (Rozas and Odum 1987; Mitsch and Gosselink 1993). Riparian wetlands are also highly effective and well recognized for their ability to trap and filter pollutants from upland runoff, and store, spread, and slow stormwater runoff prior to entering surface waters (Mitsch and Gosselink 1993).

Primary production in salt/brackish marshes is converted into shrimp production in two ways. Wetland plants decay into detritus, which accumulates in the wetlands and adjacent soft bottom areas and is a food source for shrimp and other small organisms. Also, nutrients from the broken down organic matter support growth of benthic microalgae on, between, and near wetland vegetation (Peterson and Howarth 1987). Productivity in riverine forested wetlands in North Carolina is reported to be lower than in estuarine marsh (Brinson 1977). It is estimated that 45% of salt marsh production is exported to the estuarine system in the form of detritus, dissolved organic matter, and transient fish, including shrimp (Teal 1962).

Shrimp are considered critically linked to marsh edge habitat (SAFMC 1998; Clark et al. 2004). Studies in Texas estuaries have documented that juvenile brown shrimp and white shrimp were more abundant along the salt/brackish marsh edge than in shell bottom, SAV, soft bottom, or inner marsh (Minello 1999; Rozas and Zimmerman 2000). Turner (1977) found a positive relationship between commercial yields of penaeid shrimp and the area of intertidal vegetation present at multiple estuarine locations. This suggests that preserving existing coastal wetlands and restoring former wetlands, where possible, would be directly beneficial to shrimp populations and harvest.

Riparian wetlands covered 7% of the land in coastal river basins, and riverine forested wetlands were the most abundant type. The Cape Fear, Neuse, and Albemarle river basins have the largest acreage of riparian wetlands, primarily riverine wetlands. Pamlico, Core, and Bogue

sounds, and estuaries south of Bogue Sound, have the highest percentages of estuarine wetlands. The largest acreage of salt/brackish marsh is in the Pamlico Sound region.

Distribution, size, and abundance of shrimp are monitored in the juvenile fish sampling program (Program 120). The majority of shrimp that are collected in this program are in close proximity to shallow wetland systems. Brown shrimp are widely distributed throughout North Carolina's estuaries in both low and high salinity areas, and support relatively higher concentrations in the Neuse tributaries, Core Sound, Stump Sound, and Intracoastal Waterway in Brunswick County. White shrimp abundance is most concentrated in the Cape Fear River estuary, Brunswick County estuaries, New River, and tributaries along the western shoreline of Pamlico Sound, north of the Tar-Pamlico River. Pink shrimp occur in relatively lower concentrations along the western shoreline of Pamlico Sound, Bogue Sound, New River, lower Cape Fear River, and Intracoastal Waterway in Brunswick County. However, current DMF sampling locations do not target the primary nursery grounds of pink shrimp, and therefore, may not accurately represent juvenile pink shrimp distribution and abundance. In addition to Program 120 shrimp is sampled in program 510 for management purposes. Due to the way this data is collected it cannot be used for determining distribution or abundance indices but it can be use to determine when to open areas to trawling.

10.1.3 Soft bottom

Soft bottom habitat is defined as “unconsolidated, unvegetated sediment that occurs in freshwater, estuarine, and marine systems” (Deaton et al. 2010). Sediment composition varies with geomorphology and location within the system and may be a factor in juvenile shrimp distribution. Juvenile white shrimp prefer shallow muddy substrate. In contrast, juvenile brown shrimp prefer peat and muddy bottoms but also occur where the bottom is composed of sand, silt, clay, or shell fragments (SAFMC 1993). Although soft bottom habitat is defined as “unvegetated” and lacks visible structural habitat, the surface sediments support an abundance of microscopic plants (benthic microalgae) and numerous burrowing animals hidden below the surface.

Soft bottom plays a very important role in the ecology of estuarine ecosystems as a storage reservoir of nutrients, chemicals and microbes. Biogeochemical processing and recycling establishes a filter to trap and reprocess natural and human-induced nutrients and toxic substances or release them into the water column (Matoura and Woodward 1983), allowing chemicals to pass quickly or over several seasonal cycles through the estuary (Uncles et al. 1988). Soft bottom also provides a rich food base for juvenile and adult shrimp due to the numerous plants and animals living on and in the sediment (Peterson and Peterson 1979; Currin et al. 1995). At different life stages, shrimp feed on various organisms in bottom sediments, including microfauna such as protozoans, meiofauna, such as nematodes and copepods, and macrofauna such as amphipods, polychaetes, and other crustaceans (Peterson and Peterson 1979). Once shrimp enter ocean waters, they continue foraging on subtidal bottom, particularly on muddier bottom. Although there is little structure to hide behind, shrimp can find refuge from predators by remaining on very shallow flats that predators cannot access or by burrowing beneath soft bottom during the day, and actively foraging and moving at night (Peterson and Peterson 1979; Ross and Epperly 1985).

Soft bottom also plays a key role as a nursery area for shrimp. Primary nursery areas for juvenile brown, white, and to a lesser extent pink shrimp, include shallow soft bottom habitat, usually adjacent to wetlands (Noble and Monroe 1991). Most larval settlement occurs in the uppermost portion of shallow creek systems. Areas that have been documented to consistently

support large numbers of juvenile shrimp and other species have been designated by the MFC as Primary Nursery Areas (PNAs) (Figure 10.1a-d). For 1990-2010, data from DMF's ongoing juvenile fish monitoring program indicate that brown shrimp is one of the most abundant species found along the entire coast, along with spot, Atlantic croaker, pinfish, bay anchovy, blue crab, silver perch, and Atlantic menhaden. Brown shrimp were the fourth most abundant species in the northern region while white shrimp were nineteenth. In the southern portion of the coast, brown shrimp were the third most abundant and white shrimp the thirteenth most abundant species (DMF, unpub. data). During 1990-2010, a total of 184 species were collected from the northern juvenile sampling stations and 144 species was collected from the south juvenile sampling stations (DMF, unpub. data). Consequently, protection of these areas is a high priority for shrimp management, as well as other species.

The loss of structured habitats, such as SAV and shell bottom, over time, has most likely led to gains in the amount of soft bottom habitat, but it may be of lower quality in some areas if toxins have accumulated in the sediment. Activities that lead to the deepening, loss, or chemical contamination of shallow and intertidal habitat are the greatest threat to this habitat.

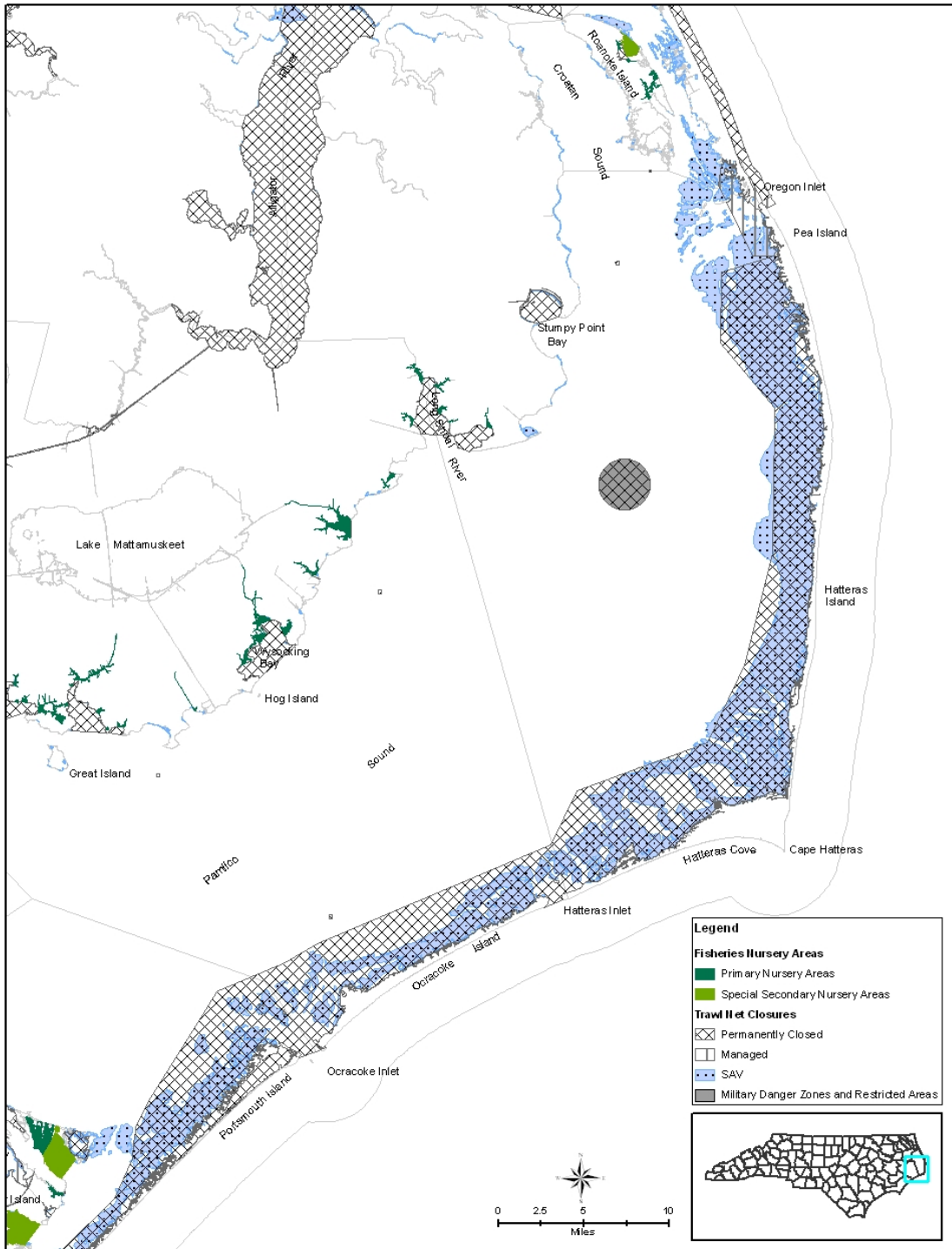


Figure 10.1a Shrimp nursery areas, including MFC designated nursery areas and SAV beds, in Pamlico Sound NC.

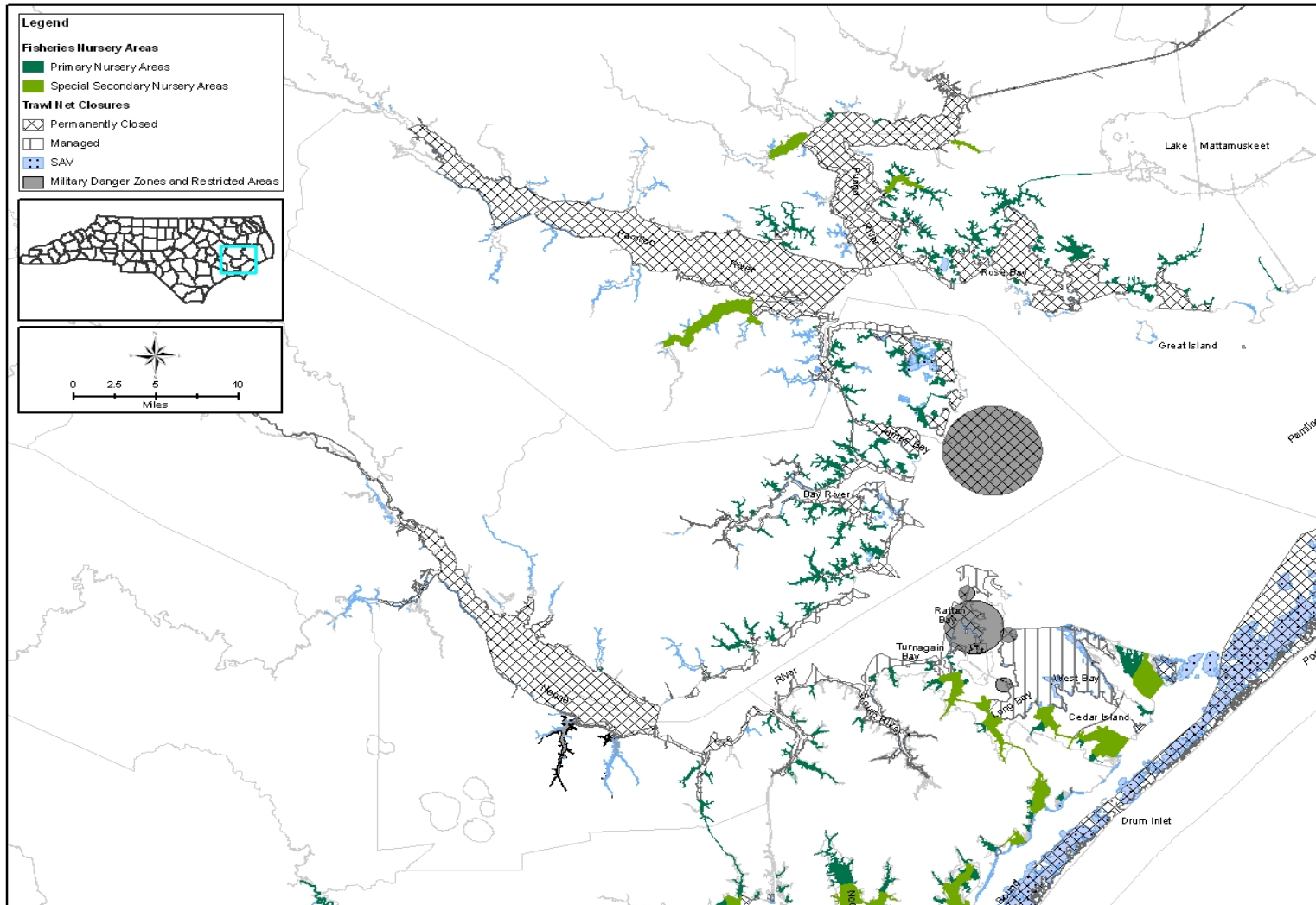


Figure 10.1b Shrimp nursery areas, including MFC designated nursery areas and SAV beds, for the Tar/Pamlico and Neuse Rivers.

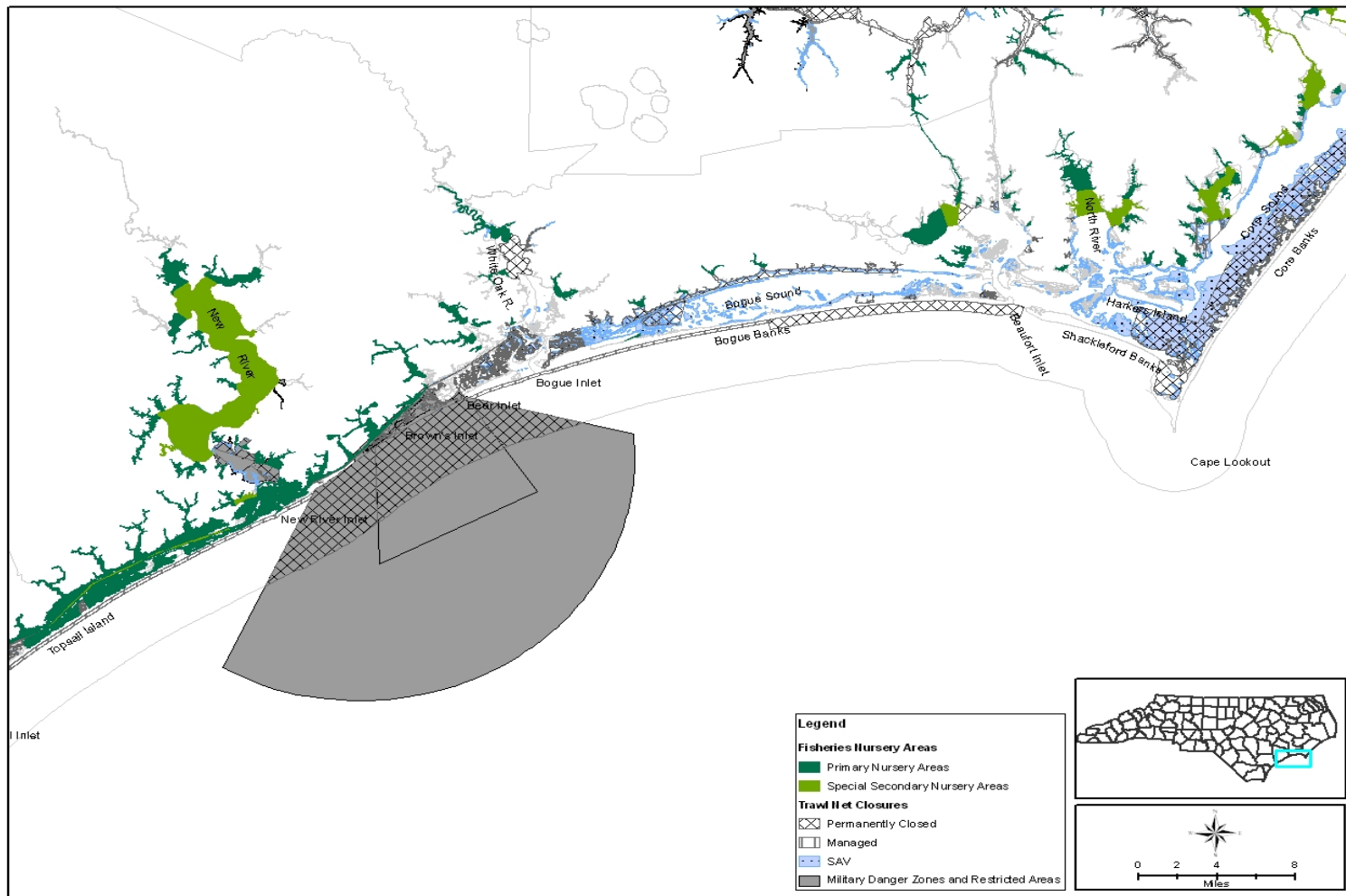


Figure 10.1c Shrimp nursery areas, including MFC designated nursery areas and SAV beds, for the Core Banks to Topsail Island.

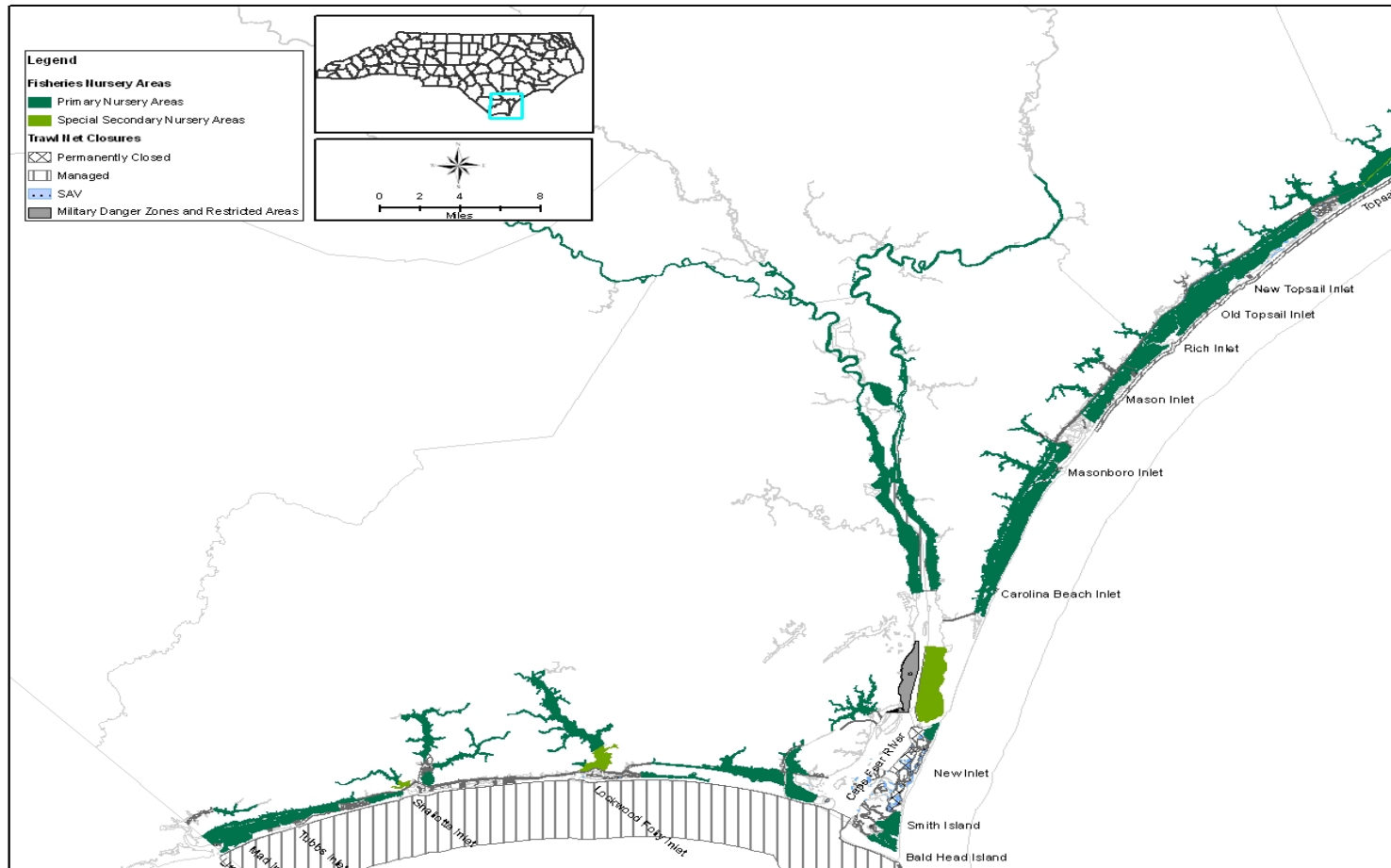


Figure 10.1d Shrimp nursery areas, including MFC designated nursery areas and SAV beds, for the Topsail Island to South Carolina.

10.1.4 Submerged Aquatic Vegetation (SAV)

Submerged aquatic vegetation (SAV) is a fish habitat dominated by one or more species of underwater vascular plants. The NCMFC define SAV habitat as submerged lands that:

- “(i) are vegetated with one or more species of submerged aquatic vegetation including bushy pondweed or southern naiad (*Najas guadalupensis*), coontail (*Ceratophyllum demersum*), eelgrass (*Zostera marina*), horned pondweed (*Zannichellia palustris*), naiads (*Najas* spp.), redhead grass (*Potamogeton perfoliatus*), sago pondweed (*Stuckenia pectinata*, formerly *Potamogeton pectinatus*), shoalgrass (*Halodule wrightii*), slender pondweed (*Potamogeton pusillus*), water stargrass (*Heteranthera dubia*), water starwort (*Callitriche heterophylla*), waterweeds (*Elodea* spp.), widgeongrass (*Ruppia maritima*) and wild celery (*Vallisneria americana*). These areas may be identified by the presence of above-ground leaves, below-ground rhizomes, or reproductive structures associated with one or more SAV species and include the sediment within these areas; or
- (ii) have been vegetated by one or more of the species identified in Sub-item (4)(i)(i) of this Rule within the past 10 annual growing seasons and that meet the average physical requirements of water depth (six feet or less), average light availability (secchi depth of one foot or more), and limited wave exposure that characterize the environment suitable for growth of SAV. The past presence of SAV may be demonstrated by aerial photography, SAV survey, map, or other documentation. An extension of the past 10 annual growing season criteria may be considered when average environmental conditions are altered by drought, rainfall, or storm force winds.” [2009 MFC rule 15A NCAC 03I .0101 (4)(i)].

Under NCMFC rules, SAV is a Critical Habitat Area [MFC rule 15A NCAC 03I .0100 (b)(20)].

SAV enhances the ecosystem by stabilizing and trapping sediment, reducing wave energy and cycling nutrients within the system (Thayer et al. 1984). The three-dimensional structure provides a surface for small plants and animals to attach to and provides a safe refuge and foraging area for a large number of juvenile fish and invertebrates (SAFMC 1998). Beds of SAV also produce large quantities of organic matter, which supports a complex food base for numerous fish and other organisms (Thayer et al. 1984). Similar to wetlands, the structure of SAV grass blades provides an excellent nursery area and enhances safe corridor between habitats, reducing predation (Micheli and Peterson 1999). While white shrimp may utilize freshwater SAV to some extent, brown and pink shrimp primarily utilize estuarine SAV because of salinity preferences.

Many important commercial and recreational fishery species use SAV as a nursery (Thayer et al. 1984). The blades of SAV provide protection and food for post-larvae and juvenile shrimp. Of the three penaeid shrimp species, SAV is particularly critical as a nursery area for pink shrimp (Murphey and Fonseca 1995). Juvenile pink shrimp abundance was greater in estuarine SAV beds compared to soft bottom, marsh edge, or shell bottom (Minello 1999). Brown shrimp also utilize SAV to some extent. Data from Texas estuaries suggest that brown shrimp show greater preference for SAV rather than marsh edge where both habitats occur (Clark et al. 2004). The configuration of a grass bed may also be a factor in juvenile and adult shrimp distribution (Murphey and Fonseca 1995). Additional sampling in SAV is needed to better assess the relationship of SAV condition and spatial changes to shrimp use of SAV habitat. Research is currently underway at UNC-IMS examining SAV, shellfish, and wetland utilization by fishes.

Several studies in North Carolina have shown that shrimp abundance was greater on SAV beds than on oyster beds (Ellis et al. 1996) or unvegetated soft bottom (Murphey and Fonseca 1995). These studies showed similar trends for other species as well. In Florida Bay, changes in animal abundances were compared between the 1980s and 1990s when significant loss of SAV occurred (Matheson et al. 1999). A decrease in SAV coverage appeared to result in a decrease in abundance of small fish and invertebrates that live within the seagrass canopy (such as shrimp and pipefish), while larger demersal predatory fish (such as toadfish and sharks) increased. Similarly, increases in SAV density were characterized by significant increases in crustaceans. In another study in Florida Bay, reductions in pink shrimp abundance were greater in seagrass die-off areas than in nearby undamaged or recovering areas (Roblee and DiDomenico 1992).

The presence of SAV may be the reason pink shrimp can overwinter in temperate North Carolina and thus supports North Carolina's spring pink shrimp harvest (T. Murphey, DMF, pers. com. 2012). Similarly, south Florida's seagrass and mangrove dominated estuaries also play a role as nursery areas for pink shrimp in both the Tortugas and Sanibel fisheries. In contrast, in South Carolina and Georgia, where no SAV is present, pink shrimp comprise a negligible portion of the shrimp landings (T. Murphey, DMF, pers. com. 2012).

From 1978-1993 the average pink shrimp landings comprised 27% of North Carolina's total shrimp landings, average pink shrimp landings from 1999-2010 declined to only 3% of total shrimp landing. Florida is also experiencing declines in its pink shrimp fishery as well. The reason for the decline in pink shrimp landings is thought to be due to higher fuel prices not allowing trawlers to perform more experimental trawls (A. Bianchi, NCDMF, pers. com. 2012) or colder winters may have decreased pink shrimp growth or increased mortality (T. Murphey, NCDMF, personal communication). The location of SAV beds in North Carolina is shown in Figure 10.1a-d, along with the MFC designated nursery areas.

10.1.5 Shell bottom

Shell bottom is defined in the CHPP as "estuarine intertidal or subtidal bottom composed of surface shell concentrations of living or dead oysters (*Crassostrea virginica*), hard clams (*Merceneria merceneria*), and other shellfish" (Deaton et al. 2010). In the 1990s, fisheries management agencies began to formally recognize shell bottom habitat as critical to fisheries production. The NCMFC, SAFMC, and ASMFC all recognize the importance of shell bottom.

Common terms used to describe shell bottom habitats in North Carolina are "oyster beds," "oyster rocks," "oyster reefs," "oyster bars," and "shell hash." Shell hash is a mixture of sand or mud with gravel and/or unconsolidated broken shell (clam, oyster, scallop, and/or other shellfish). Shell bottom is enhanced in some areas by the addition of cultch material. Cultch material (hard material to which oysters attach) can consist of oyster, clam, or scallop shells; gravel or marl; or other hard materials. Cultch exists naturally, as shell hash and oyster rocks. DMF's Shellfish Rehabilitation Program staff also plant cultch to enhance and restore estuarine shell bottom for oyster and hard clams.

Shell bottom is both intertidal and subtidal, and can consist of fringing or patch reefs (Coen et al. 1999). Intertidal oyster reefs in the central and southern estuarine systems may only be a few oysters thick. However, subtidal oyster mounds in Pamlico Sound may have been several meters tall (Lenihan and Peterson 1998). In North Carolina, oysters attach to and accumulate on existing oyster beds, other shell, outcropping of fossil shell beds, exposed *Spartina* roots, pilings, and rip-rap (DMF 2001). Intertidal oyster reefs in North Carolina may occur along the

edges and points of salt marsh, between salt marsh and seagrass beds, or as isolated reef features, away from other structure (Grabowski et al. 2000).

Shell bottom provides many important functions that enhance the health of the entire ecosystem for fishery and non-fishery species. Oysters filter sediment and pollutants from the water column, enhancing water quality and improving conditions for SAV growth (Coen and Luckenbach 1998). The hard multi-faceted shell structure aids in reducing wave energy, stabilizing sediment, and reducing shoreline erosion (Lowery and Paynter 2002). Oysters, like SAV and benthic microalgae, facilitate storage and cycling of nutrients. This process reduces the likelihood of coastal eutrophication and its detrimental effects on fish and fisheries. Oyster beds also increase shoreline complexity, modify circulation patterns, and enhance fish use of marsh edge habitat (Grabowski et al. 2000).

The complex three-dimensional structure of shell bottom provides protective cover for juvenile and adult shrimp. The shell structure also provides an area for small plant and invertebrate attachment, which shrimp may feed on or hide among (Meyer et al. 1996; Lenihan and Peterson 1998; Coen et al 1999). However, predatory finfish around the reefs feed, in part, on penaeid shrimp (Grabowski et al. 2000). Fringing shell bottom or shell hash also serves as a nearshore corridor between habitats such as salt marsh and SAV, which shrimp also utilize (Coen et al. 1999; Micheli and Peterson 1999).

Brown, white, and pink shrimp have been documented to utilize shell bottom habitat in South Carolina and Texas estuaries (Coen and Luckenbach 1998; Zimmerman et al. 1989), although shell bottom does not appear to be the preferred habitat, compared to salt marsh edge or SAV (Minello 1999). In North Carolina, some studies indicate use of oyster beds by pink, white, and brown shrimp (Meyer et al. 1996; Grabowski et al. 2000; Lenihan et al. 2001). Analysis of these studies in Peterson et al. (2003) concluded that pink, white, and brown shrimp were not recruitment or growth enhanced by the presence of shell bottom. Shervette and Gelwick (2008) observed higher numbers of white shrimp in oyster bottom than in non-vegetated bottom. In sounds and the lower portions of estuaries where SAV is not present, shell bottom may be more critical to penaeid shrimp. In addition, the ecosystem benefits provided by the habitat would still indirectly enhance shrimp populations.

Oysters are found along a majority of the North Carolina coast from extreme southeastern Albemarle Sound to the estuaries of the southern part of the state to the South Carolina border (DMF 2001). Oyster reefs occur at varying distances up North Carolina's estuaries, depending upon salinity, substrate, and flow regimes. In the wind-driven Pamlico Sound system north of Cape Lookout, oyster reefs consist overwhelmingly of subtidal beds. South of Cape Lookout, subtidal rocks also occur in the New, Newport, and White Oak rivers (DMF 2001). Extensive intertidal oyster rocks occur in North Carolina's southern estuaries, where the lunar tidal ranges are higher. Substantial shell hash is present in New River, eastern Bogue Sound, and along the edges of many streams and channels, such as portions of the Atlantic Intracoastal Waterway (IWW) in the southern coastal area. In the Albemarle-Pamlico estuary, oysters are concentrated in the lower portion of Pamlico Sound tributaries, along the western shore of Pamlico Sound, and to a lesser extent, behind the Outer Banks (Ross and Epperly 1986).

The current distribution of shell bottom is much less than what historically occurred (Newell 1988). Mechanical harvesting of oysters (oyster dredging) was the primary and initial cause of habitat loss (DMF 2001). Most shell bottom losses have been to subtidal beds in Pamlico Sound, where DMF has also found declines in oyster recruitment. Although mechanical harvesting of oysters has been greatly restricted, reefs have not recovered, possibly due to

stress from water quality degradation and increased occurrence of disease (Dermo, MSX) (DMF 2001). Oyster dredging removes oysters and reduces the vertical profile of oyster rocks, increasing the susceptibility of remaining shell bottom at that location to low DO and possible mortality (Lenihan and Peterson 1998; Lenihan et al. 1999). Although commercial oyster dredging has been greatly reduced, current activities continue to reduce and degrade a habitat that is utilized by shrimp. Hand harvest methods for oysters and clams can also be destructive, but on a much smaller scale. Other bottom disturbing fishing gears, such as trawls, prevent the re-establishment of oyster reefs within their historic range.

To offset some of these reductions, the NCDMF began an oyster sanctuary program in 1996. As of 2012, the DMF has established and developed 10 Oyster sanctuaries with a total 198 acres of permitted sanctuary bottom (P. Holmlund. NCDMF. personal communication). Certain bottom disturbing fishing gears such as trawls, long haul seines and swipe nets are prohibited within these sanctuaries. The harvest of shellfish by any means is also prohibited within these sanctuaries. These sanctuaries are located around Pamlico Sound and constructed of multiple, high profile mounds using mostly Class B Riprap (fossil stone) and the use of shell and seeded shell as part of the research needs. The Nature Conservancy (TNC), the National Marine Fisheries Service (NMFS) Hurricane grant 2001-2006, state appropriations through DMF, CRFL grants, and other mitigation sources provided funding. The DMF has also partnered with NCCF in several oyster restoration projects, including the large federal stimulus project. Oyster Sanctuaries are designated and delineated under North Carolina Marine Fisheries Rule 15A NCAC 03R .0117 and are protected from damaging harvest practices under rule 15A NCAC 03K .0209. The oyster sanctuary program should continue to be a high priority for funding.

Other causes of shell bottom losses include dredging for navigation channels or marina basins. These activities can physically remove or damage existing shell bottom or result in turbidity that clogs oyster gills or covers sediment completely. Hydrologic modifications in the Neuse and Pamlico rivers decreased salinity in the downstream portions of those rivers and resulted in a downstream displacement of oysters since the 1940s (Jones and Sholar 1981). While drainage for agriculture has changed little in recent years, drainage for urban/suburban development is increasing steadily.

10.1.6 Hard Bottom

Hard bottom habitat is defined in the CHPP as “exposed areas of rock or consolidated sediments, usually colonized by a thin veneer of live or dead biota, and generally located in the ocean rather than in the estuarine system” (Deaton et al. 2010). At this time there is no documented evidence of penaeid shrimp using hard bottom.

10.2 HABITAT CONCERNS

10.2.1 Wetland Loss

It is estimated that as much as 34-50% of North Carolina’s original wetland coverage has been lost, primarily due to ditching, channelization, and filling for agriculture and development (Dahl 1990; DWQ 2000). According to the North Carolina Division of Water Quality (DWQ 2000), approximately 88% of salt/brackish marsh, 81-88% of riverine forested wetlands, and 48% of pocosins remain. From the early 1800s to the early 1900s, ditching and draining for agriculture accounted for the majority of wetland losses (Heath 1975). From 1950 to the 1990s, conversion of wetlands to managed forest and agriculture accounted for 53% and 42%, respectively, with commercial and residential development activities responsible for the remaining 5% (Bales and

Newcomb 1996). Since 1990, losses from agriculture and forestry decreased, but losses from development increased. The primary threats to wetland habitat today are dredging, filling, and hydrological alterations associated with development. Although the rate of wetland loss has slowed, losses continue to occur. Mitigation for permitted losses and voluntary restoration efforts in some areas has partially offset some of the recent losses.

One activity that has a cumulative impact on wetlands is estuarine shoreline stabilization. Hardened estuarine shorelines cause gradual, long-term wetland loss by limiting sediment inputs needed for maintenance and expansion of wetlands, and by blocking landward migration as sea level rises. Garbisch et al. (1973) showed that marsh vegetation waterward of bulkheads experienced a 63% post-construction mortality due to stress from increased turbulence and scour resulting from vertical hardened structures. Scouring action at the toe of bulkheads also deepened the adjacent water, thus reducing or eliminating intertidal habitat. The added turbulence at the base of bulkheads and deepened water depth prevents vegetation from reestablishing after construction (Knutson 1977). Several studies have found that abundance of shrimp and other organisms adjacent to bulkheaded shorelines was much less than what occurred adjacent to unaltered naturally vegetated shorelines (80-300% less) (Mock 1966; Gilmore and Trent 1974; Peterson et al. 2000). The difference was attributed to lower abundance of organic detritus and small benthic invertebrates, deeper water, and less intertidal vegetation.

Ongoing initiatives such as wetland restoration, land acquisition and preservation, and agricultural cost-share BMPs (Best Management Practices) need to be enhanced. These initiatives should be made available through continued education about the use of alternatives to vertical bulkheads. These alternatives include marsh sills which prevent erosion by allowing wetlands to dissipate the energy and still provide ecosystem functions that are lost through other means of shoreline stabilization. There should also be additional initiatives implemented to protect and enhance wetland habitat. The many fishery and water quality functions provided by wetlands make their preservation and restoration along North Carolina's coast a high priority for protection of all coastal fish habitats.

10.2.2 Soft Bottom Impacts

Soft bottom habitat may be affected by marina and dock facilities through alteration of the shoreline configuration, circulation patterns, and subsequently, changes in bottom sediment characteristics (Wendt et al. 1990). Because benthic microalgae, an important component of primary production in soft bottom habitat, are light-dependent, bottom sediments in dredged marinas will have reduced light availability due to the deeper water depth and shading from docking structures. A study estimating macroalgae and microalgae productivity before and after construction of a marina in Long Island Sound found that microalgae production on soft bottom would decline by 48% post-construction and macroalgae production would decline by 17% (Ianuzzi et al. 1996). However, the authors concluded that some of this loss would be offset by additional microalgal production on hard structures in the marina. Operation of a marina can also affect productivity of the soft bottom community due to introduction of heavy metals, hydrocarbons, and bacteria (Chmura and Ross 1978; Marcus and Stokes 1985; Voudrias and Smith 1986). Heavy metals and hydrocarbons are toxic to many soft bottom dwelling invertebrates and benthic feeding fish (Weis and Weis 1989). Dissolved oxygen (DO) may become depleted or below optimum thresholds in dredged marina basins and channels. A North Carolina marina study found significantly lower DO concentrations (less than 5.0 mg/l) inside some marinas compared to samples from outside marinas (DEHNR 1990). Cumulatively,

docks may also negatively impact shrimp populations (Sanger and Holland 2002). Research is needed to better assess the impacts of multiple docks on shrimp and other species. In addition to impacting wetlands, estuarine shoreline stabilization can degrade soft bottom habitat by reducing or eliminating the intertidal zone, deepening shallow soft bottom habitat, or contaminating sediment from leaching of toxic preservatives from wood structures (Weis et al. 1998). Multiple studies have shown that the diversity and abundance of invertebrates and juvenile fish over soft bottom are reduced adjacent to bulkheaded areas (Mock 1966; Ellifrit et al. 1972; Gilmore and Trent 1974; O'Rear 1983; Byrne 1995; Peterson et al. 2000; Waters and Thomas 2001). Beach nourishment along ocean shorelines can alter the sediment composition of nearshore soft bottom to a condition less favorable for shrimp or result in a temporary reduction in food availability (Hackney et al. 1996). Local fishermen have noted a shift in shrimp distribution to waters further offshore at Carolina Beach and Wrightsville Beach, where storm damage reduction projects have been ongoing for many years. This change may be associated with a shift in sediment composition from muddy to sandy substrate.

While MFC rules are designed to minimize commercial fishing gear impacts to fisheries habitat, these restrictions primarily focus on restricting the use of highly destructive bottom disturbing gear from most structural habitats such as oyster or SAV beds. Soft bottom habitat, because of its low structure and dynamic nature, has historically been considered the most appropriate location to use bottom disturbing gear. Existing fishery rules that restrict bottom disturbing gears in soft bottom habitat include prohibition of trawls, dredges, and long haul seines in PNAs, [15A NCAC 3N .0104] and prohibition of trawls, or mechanical shellfish gear in crab spawning sanctuaries [15A NCAC 3L .0205] in the five northern-most inlets of North Carolina during the blue crab spawning season (March-August).

Fishing gears documented to have the greatest potential to damage or degrade soft bottom or other habitats are dredges, followed by trawls (DeAlteris et al. 1999; Collie et al. 2000). Bottom trawling is used more extensively than dredging on soft bottom habitat in both estuarine and coastal ocean waters. Shrimp trawling accounts for the majority of bottom trawling effort in North Carolina and was addressed in the 2006 Shrimp FMP. Management strategies in the 2006 Shrimp FMP that addressed both habitat impacts as well as bycatch concerns were area specific and included trawl size restrictions, a phase in period for otter trawls to be converted to skimmer trawls, designation of a special secondary nursery area, and the establishment of additional no trawling areas.

Various types of dredges used on soft bottom habitat in North Carolina cause similar bottom disturbance: crab dredges, oyster dredges, and hydraulic clam dredges. Because of the gears' teeth, crab and oyster dredges can dig deep into the sediment and cause extensive sediment disturbance. Mechanical methods for the taking of crabs are prohibited in designated Crab Spawning Sanctuaries from March through August. Although the amount of fishing effort is low, this gear is documented to cause significant damage (DeAlteris et al. 1999; Collie et al. 2000).

Hydraulic clam dredging, as well as clam "kicking", a specialized type of trawl, creates trenches and mounds of discarded material in soft bottom habitat, redistributing and resuspending sediment (Adkins et al. 1983). Water jets from the hydraulic dredge can penetrate 18 inches into bottom sediments, and uproot any biotic structure present (Godcharles 1971). Dredge tracks can remain present from a few days to more than one year, and recolonization by vegetation can take months to begin. Recruitment of clams and other benthic invertebrates does not appear to be affected by hydraulic dredging (Godcharles 1971). Because of the severe impacts to habitats, both hydraulic clam dredging and clam kicking are restricted to open sand and mud bottoms, usually deeper waters, including areas frequently dredged as

navigational channels. Overwintering pink or white shrimp could potentially be affected by this activity, although they usually overwinter in shallow vegetated areas. However, Freeman (1988) examined the effects of clam kicking on pink shrimp in Core Sound and found no significant differences in mean CPUE between an area opened to mechanical harvest and an area closed to mechanical harvest.

10.2.3 Submerged Aquatic Vegetation Impacts

The amount of SAV in North Carolina was estimated to be between 134,000 and 200,000 acres around 1990 (Orth et al. 1990; Ferguson and Wood 1994). However the current spatial distribution and acreage of SAV may be somewhat different since some areas that historically supported SAV were not mapped, and changes may have occurred since the original mapping. Along the Atlantic coast, North Carolina supports more SAV than any other state, except for Florida. The majority of SAV occurs in eastern Pamlico Sound and Core Sound in high salinity waters (Figure 9.1a-d). Because light is the primary limiting factor affecting its distribution, SAV is restricted to relatively shallow waters, usually less than 1 m in depth.

Historical accounts indicate that there have been large-scale losses of SAV in North Carolina's low salinity tributaries on the mainland side of Pamlico Sound and along much of the shoreline of western Albemarle Sound (North Carolina Sea Grant 1997; J. Hawkins, DMF, personal communication) while the high salinity grass beds to the east appear relatively stable (Ferguson and Wood 1994). Loss of low salinity SAV habitat could negatively affect white or brown shrimp. Impacts to high salinity SAV beds could be especially detrimental to pink shrimp. Protection, enhancement, and restoration of this habitat are high priorities for sustained shrimp populations.

The greatest threat to SAV is large-scale nutrient enrichment and sediment loading, which increases turbidity, reduces light penetration, and subsequently impacts SAV growth, survival, and productivity (Goldsborough and Kemp 1988; Kenworthy and Haunert 1991; Funderburk et al. 1991; Stevenson et al. 1993). Catastrophic losses of seagrass beds have been correlated with these water quality problems in other states in the past (Twilley et al. 1985; Orth et al. 1986; Durako 1994). Nutrient enrichment and/or increased sediment loads impact SAV growth, survival, and productivity by increasing chronic turbidity in the water column from suspended sediment or phytoplankton associated with algal blooms. Also, sediment, epiphytes, or drift algae can cover the surface of blades (Dennison et al. 1993; SAFMC 1998; Fonseca et al. 1998). Elevated nitrogen concentrations have also been shown to be toxic to eelgrass (Burkholder et al. 1992). In North Carolina, most of the low salinity areas that have experienced large reductions in SAV coverage (Tar-Pamlico River and Neuse River) are also designated Nutrient Sensitive Waters. Once SAV is lost, increased turbidity and sediment destabilization can result in accelerated shoreline erosion and make recolonization more difficult (Durako 1994; Fonseca 1996). Therefore prevention of any additional SAV loss through water quality maintenance and improvement is a high priority for shrimp management.

Increased sediment and nutrient loading in the water column can enter coastal waters from point source discharges, nonpoint stormwater runoff, or resuspension of bottom sediments. Specific sources that contribute to increased sediment loading include construction activities, unpaved roads, road construction, golf courses, uncontrolled urban runoff, mining, silviculture, row crop agriculture, and livestock operations (DWQ 2000). Urbanization can increase the flow and velocity of stormwater runoff, which in turn leads to increased stream bank erosion. Stream bank erosion is a significant source of sediment loading (DWQ 2000). Specific sources that contribute to increased nutrient loading include agricultural and urban runoff, wastewater

treatment plants, forestry activities, and atmospheric deposition. Nutrients in point source discharges are primarily from human waste and industrial processes. The primary contributors of nutrients from non-point sources are fertilizer and animal wastes (DWQ 2000).

In addition to effects from water quality degradation, SAV can be removed or damaged by water-based activities. Dredging for navigational channels, marinas, or infrastructure such as bridges, submarine pipelines, or cables can result in large, direct losses of SAV. Docks constructed over SAV can cause immediate loss during construction or gradual loss due to shading effects. Several studies in Florida have shown that SAV was significantly reduced or eliminated under and around docks that were less than 5.5 ft above mean high water or where light received was less than 14% of the surface light availability (Loflin 1995; Shafer 1999). In addition to direct damage from docks and marinas, indirect damage to SAV can result from boating activity associated with these structures. Shoals and other shallow bottoms supporting SAV may become scarred as boating activity to and from the docking areas increases. Boat wakes can destabilize and erode SAV beds, or resuspend sediment, reducing light penetration. As additional docks and marinas are constructed along the coast, the potential for boating-related damage increases.

North Carolina has implemented standards for dock construction to minimize impacts to SAV, including dock height above the water and minimum water depth. In North Carolina, the depth of water at the dock end is not considered in Coastal Resource Commission (CRC) rules. To minimize shading effects to wetland plants, CRC rules require a dock height of at least three feet (0.91 m) above the wetland substrate, and a pier width of no greater than six feet (1.83 m) [CRC rule 15A NCAC 07H.0208 (6)]. However, there is no requirement for height above the water surface. Results from Connell and Murphey (2004) indicate that current dock designs over SAV beds in North Carolina result in a reduction in SAV coverage and density. The DCM rules (15A NCAC 07H .1205) allow docks to be constructed over SAV where there is at least -2' normal water level (NWL). Dock criteria should be evaluated by CRC to determine if existing requirements are adequate for SAV survival and growth and what changes would be needed to allow adequate light beneath docks. The permit requirements for docks and piers may need to be changed accordingly.

Several bottom disturbing fishing gears have the potential to destroy or damage SAV. The DMF issued a report on shrimp and crab trawling impacts (DMF 1999). Also, the Fisheries Moratorium Steering Committee's Habitat Subcommittee identified specific habitat impacts from various commercial and recreational fishing gears used in North Carolina waters, and made recommendations to minimize such impacts (MSC 1996). The Fisheries Moratorium Steering Committee presented the summary of findings to the Joint Legislative Commission on Seafood and Aquaculture of the General Assembly. Fishing gear found to be potentially damaging to SAV is listed in Table 10.2.

Table 10.2 Fishing gears used in North Carolina identified as potentially damaging to submerged aquatic vegetation habitat. (Source: MSC 1996).

Severe damage	Moderate damage	Low damage or unsure
Oyster dredge	Crab trawl	Long haul seine
Crab dredge	Clam Tongs	Otter trawl
Hydraulic clam dredge		Clam hand rake
Clam trawl (kicking)		Bay scallop dredge (very little)
Bull rake		

Damage from fishing gear varies in severity. Hand gear, such as bull rakes and large oyster tongs can uproot SAV and cause substantial damage, but generally to smaller areas than mechanical gears (Thayer et al. 1984). Current MFC rules prohibit use of rakes more than twelve inches wide or weighing more than six pounds SAV [MFC rule 15A NCAC 03K.0304 (a) (2)]. Use of hand rakes and clamming by hand are allowed.

Mobile gear, such as long haul seines or bottom trawls, can shear or cut the blades of SAV, or uproot plants without major disruption of the sediment (ASMFC 2000). Shearing of above-ground plant biomass does not necessarily result in mortality of SAV, but productivity is reduced since energy is diverted to replace the damaged plant tissue, and the nursery and refuge functions are reduced in the absence of structure. Other fishing practices can cause severe disruption of the sediment and damage the roots of SAV. Gears that disturb the sediment and below-ground plant structures, like toothed dredges, heavy trawls, and boat propellers, may cause total loss of SAV in the affected area, requiring extensive time to recover (ASMFC 2000). SAV can also be buried by excessive sedimentation associated with trawling, dredging, and propeller wash. High turbidity from use of bottom-disturbing fishing gear can reduce water clarity, affecting SAV growth, productivity, and in some cases, survival (ASMFC 2000). Although some areas such as the soundside of the outerbanks have been closed to protect SAV, other areas should be periodically evaluated to determine if boundaries need to be adjusted to avoid SAV. At this time, most of the SAV is located in areas that have been designated as PNA, SNA, or SSNA, where there is some protection preventing trawling through SAV. For more information on PNA, SNA, or SSNA see section 11 Management of the Stock. The remaining areas that do not prevent trawling in SAV are in areas in proximity to Oregon Inlet (Figure 10.1a) and Bogue Sound (Figure 10.1b) where the depths may be shallow for trawling.

All toothed dredges can cause severe damage when pulled through SAV. Because oyster dredges, crab dredges, and hydraulic clam dredges severely impact bottom structure, there are strict limits on their use in North Carolina. Use of crab dredges is restricted to an area in northern Pamlico Sound southwest of Oregon Inlet [MFC rule 15A NCAC 03R.0109] that excludes SAV beds. Use of oyster dredges is currently restricted to parts of Pamlico Sound and its tributaries. The majority of high salinity SAV occurs in areas where mechanical methods for oyster harvesting are prohibited. Amendment I of the Oyster FMP addressed oyster dredging in the shallow bays of western Pamlico Sound where dredging is now only allowed in designated areas based on a water depth criteria of six feet or more. This management strategy provides protection to brackish and freshwater SAVs.

Clam kicking can also severely impact SAV since substrate is displaced by propeller backwash (Guthrie and Lewis 1982). Peterson and Howarth (1987) found that clam kicking significantly reduced plant biomass in eelgrass and shoalgrass beds. It is likely that SAV was damaged by kicking in the past since this technique has been used in North Carolina for over 60 years. Effort was high in areas known to support SAV (Carteret County), and kicking vessels tended to operate in shallow waters (Guthrie and Lewis 1982). Because of the severe disturbance to the bottom, clam kicking is restricted to sandy bottom in Core Sound, and Newport, North, New, and White Oak rivers from December to March. The fishery is managed intensively, with strong enforcement to prevent clam kicking outside the designated areas. Much of the designated mechanical clamming areas have SAV in close proximity to them, so vessels that fish illegally outside the open areas may severely impact SAV. Turbidity generated by clam kicking may also affect adjacent SAV beds. High salinity SAV species are more likely to be impacted by mechanical clamming practices due to the location of the fishery.

Bay scallop dredges, in contrast to oyster and crab dredges, cause less severe damage to SAV because they are smaller [not over 50 lb (22.68 kg)] and have no teeth. They are intended to glide along the substrate surface, taking bay scallops lying on the surface within SAV beds. Most damage observed by DMF staff has not been from the dredge, but from propeller scarring while pulling the dredge, particularly when the season opening coincides with low tide (T. Murphey, DMF, personal communication). Amendment I of the Bay Scallop FMP put in place an adaptive management strategy to determine harvest levels based on scallop abundance. All management triggers with the exception of the highest trigger allows hand harvest only. At the highest trigger, hand harvest is allowed at the beginning of the season (last Monday in January) with scallop dredging delayed until the first week in March. This strategy allows for removal of scallops in the shallow waters by hand harvesters first, followed by opening dredging later in the season to fish those scallops in waters too deep for hand harvest. In addition, opening day for harvest occurs on a high tide to allow dredgers to clean out any scallops in hand harvested areas. This management strategy minimizes damage to SAV from propeller scarring by dredging vessels (T. Murphey, DMF, personal communication).

Fishery restrictions already exist for most of the gears used in North Carolina that are potentially damaging to SAV. Additional law enforcement may be needed to enforce buffers around SAVs. In addition, the boundaries of areas where dredging or trawling is allowed should be evaluated and adjusted, if necessary, to adequately protect all SAV beds and provide a buffer of unvegetated area to reduce turbidity impacts. Because of the location and magnitude of fishing effort and SAV beds, it appears that trawling in Core and Bogue sounds has the greatest potential for significant fishing gear impacts on existing SAV beds.

10.3 WATER QUALITY

Adequate water quality is necessary to maintain the chemical properties of the water column that are needed by shrimp, as well as sustain SAV, shell bottom, and soft bottom habitats that support shrimp. Human activities that degrade water quality or alter water flow can negatively impact shrimp growth or survival. For example if salinity or dissolved oxygen (DO) concentrations are altered beyond the known preferences of shrimp, shrimp distribution or growth rates may be affected. Toxins can be assimilated into shrimp tissue and alter growth and reproduction. The common causes of water quality use support impairment in North Carolina's coastal river basins are excessive sediment loading and low DO (DWQ 2000). Hydrological modifications, low DO and toxin contamination are probably the greatest water quality concerns for penaeid shrimp.

10.3.1 Hydrological modifications

Hydrological modifications occur when streams and creeks are channelized (deepened and straightened), dredged, or ditched to improve drainage of adjacent lands or for navigation (North Carolina Sea Grant 1997), and often result in increased runoff. Runoff from agriculture, urban/suburban development, and transportation infrastructure carries sediment, nutrient, and toxic chemical pollutants (DWQ 2000). Sediment, the number one pollutant of waterways in the United States, clogs oyster gills and buries shells (Coen et al. 1999). Excess nutrients can fuel algal blooms and low DO events, and in turn, cause mortality of benthic organisms on deep, subtidal shell bottom (Lenihan and Peterson 1998). Heavy metals, petroleum products, pesticides, and other toxic chemicals in the runoff can kill sensitive oyster larvae (Wendt et al. 1990; Funderburk et al. 1991).

Channelized streams are often deeper, with more extreme flows, less woody debris and less variable depth than natural streams. These changes primarily affect smaller species and early life stages that use shallow stream margins, since these areas are reduced with channelization. Channelization potentially affects shrimp in several ways. By removing the meanders of the channel and increasing the slope of the shoreline, water velocities in the altered stream are higher and erosion of the shoreline and sediment loading increases. In many channelized streams, storm flows are confined primarily to the main channel rather than passing through wetlands and achieving some filtration of pollutants, deposition of sediment, and water storage. In addition, the natural woody vegetation along the sides of the stream is often removed in the process of channelization. Consequently, loading and movement of sediment and other nonpoint source pollutants are often greater in channelized sections than natural streams, which can have negative impacts on water quality and therefore fish habitat (EPA 2001). Nutrient concentrations, particularly for nitrogen and phosphorus, may increase with channelization. Elevated water velocities can also deter or prevent movement of adult and juvenile fish. In addition, spoil banks created by dredge disposal along the shoreline prevents shrimp from accessing adjacent wetlands.

Several studies have found that the size, number, and species diversity of fish in channelized streams are reduced and the fisheries associated with them are less productive than those associated with unchannelized reaches of streams (Tarplee et al. 1971; Hawkins 1980; Schoof 1980). Pate and Jones (1981) compared nursery areas that were altered and unaltered by channelization and found that brown shrimp, spot, croaker, southern flounder, and blue crab were more abundant in nursery habitats with no man-made drainage. They attributed this reduction in organisms to the unstable salinity conditions that occurred in areas adjacent to channelized systems following moderate to heavy rainfall (>1 inch/24 hr).

10.3.2 Low oxygen

Adequate supply of DO is critical to survival of benthic invertebrates and fish. Low-oxygen conditions (hypoxia) can occur naturally in a system from flushing of swamp waters, which characteristically have low DO, or from stratification of the water column due to wind, temperature, and salinity conditions. However, low-oxygen conditions can also be fueled by increased stormwater runoff carrying nutrients and oxygen-consuming wastes, which result in excessive oxygen demand in the water column or sediment. Algal blooms deplete the water column of DO as respiration from the dense concentrations of plants consumes oxygen at night (DWQ 2000). Dissolved oxygen can be further depleted as bacteria use oxygen to decompose the algae's organic material. Algal blooms may occur naturally in coastal waters or occur with greater frequency or intensity upon inputs of nutrients. Dissolved oxygen depletion in the water column occurs most often in summer. Warmer water holds less DO and increases microbial decomposition. In addition, warmer water, calm winds, and reduced freshwater inflow in the summer reduce mixing and aeration of water. The stratified bottom layer of water is prevented from receiving oxygenated surface waters and rapidly becomes depleted of oxygen. Shallow water estuaries with less frequent flushing often develop persistent stratification and bottom-water hypoxia that can last for weeks to months (Tenore 1972). Low oxygen events in coastal waters of the United States are becoming more frequent, larger in extent, and longer lasting due to increasing eutrophication (Cooper and Brush 1991; Breitberg 1992; Lenihan and Peterson 1998).

In freshwater streams, DWQ water quality (use support) data indicate low DO as a major cause of impairment in the Neuse River basin (132 mi), Chowan River basin (46 mi), Pasquotank River basin (40 mi), Roanoke River basin (24 mi), Tar-Pamlico River basin (13 mi), and White Oak

River basin (8 mi) (DWQ 2000). In estuarine waters, low DO was a major source of impairment in the Cape Fear (5,000 acres) and the Pasquotank river basins (1,125 acres). In the Neuse River, recent estimates suggest that up to 30-50% of the estuarine bottom during summer is unsuitable habitat due to hypoxia (Seldberg et al. 2001; Eby and Crowder 2002). Since shrimp live on the bottom in estuaries where hypoxia and anoxia (no oxygen) have been reported to occur, the species may be negatively affected by low oxygen events.

Brown shrimp and some other organisms are capable of detecting and avoiding waters with low oxygen concentrations (Wannamaker and Rice 2000). Where shrimp had access to water with 4 or 2 mg/l DO rather than 1 mg/l DO, shrimp strongly preferred and moved to the higher oxygenated waters. Migration of benthic organisms from hypoxic or anoxic waters can lead to high densities of organisms in oxygenated areas, increased competition, and increased predation by opportunistic predators (Eby and Crowder 2002; Seldberg et al. 2001). Although fish have the ability to migrate away from hypoxic areas and seek refuge in shallower oxygenated waters, wind-driven circulation can rapidly transport the hypoxic bottom-water into shallow waters, so that fish cannot escape (Paerl et al. 1998). Dissolved oxygen (DO) depletion has historically been the major factor driving fish kill activity in North Carolina. Low DO levels occur under a variety of conditions but are more common during the summer or following major storms and hurricanes. Consequently, in the wake of periods of hot weather and the arrival of Irene, low DO was the most frequently reported cause for fish kills during the 2011 season (DWQ 2011).

Although direct mortality does not appear to be a significant factor for shrimp, prolonged periods of hypoxia could stress and negatively impact penaeid shrimp and significantly alter the estuarine system. Studies on white shrimp found that growth rates of white shrimp were reduced in waters having less than 3.5 mg/l DO, feeding was affected in waters 2-3 mg/l DO, and oxygen uptake was reduced by 50-70% in 2 mg/l DO (Gray et al. 2002). When a benthic community is severely depleted by a low oxygen event, ecological successional patterns of the benthos are altered (Luettich et al. 1999). The various successional stages may affect or benefit different benthic feeders to differing extents. For example, early successional communities composed of very small, shallow-burrowing opportunists (capitellid worms) and meiofauna may favor small species, such as penaeid shrimp and larval and juvenile croaker and red drum, but not provide food for large adult fish species. Partially recovered benthic communities consisting of polychaetes and small juvenile clams could benefit demersal species like spot, croaker and blue crabs. A fully recovered community with deep burrowing polychaetes and large clams might benefit adult spot and hogchoker, but not shrimp (Luettich et al. 1999).

Hypoxia and anoxia can occur naturally, but can also be attributed, in part, to anthropogenic changes in the system, including excess nutrient and organic loading from waste discharges, nonpoint runoff, streambank erosion, and sedimentation (Schueler 1997). Oxygen depletion in the water column was positively correlated with accumulation of organic material in the sediments (Luettich et al. 1999). Several studies have indicated that the frequency, duration, and spatial extent of low oxygen events have increased over the years due to increasing eutrophication of coastal waters from human and animal waste discharges, greater fertilizer use, loss of wetlands, and increased atmospheric nitrogen deposition (Cooper and Brush 1991; Dyer and Orth 1994; Paerl et al. 1995; Buzzelli et al. 2002). More information is needed to fully understand consequences on the estuarine food web and to what extent anoxia affects the soft bottom community. Efforts are needed to reduce anthropogenic nutrient loading, particularly in systems that have a history of hypoxia and anoxia.

10.3.3 Toxins

While toxins can fluctuate between the sediment and water column, concentrations of toxic chemicals tend to accumulate in sediments at concentrations several orders of magnitude greater than in overlying waters (Kwon and Lee 2001). The bioavailability and transport of a chemical depends on the form of the chemical incorporated into the sediments, the feeding habits and condition of aquatic organisms, and the physical and chemical conditions of the environment. Toxic chemicals can become active in soft bottom sediment or overlying waters through several mechanisms, including resuspension from natural weather events or human activities, such as dredging and trawling.

Toxins in sediments or the water column can affect benthic invertebrates by inhibiting or altering reproduction or growth, or causing mortality in some situations (Weis and Weis 1989). Early life stages are most vulnerable to toxins (Funderburk et al. 1991). Because macroinvertebrate diversity significantly declines with increasing sediment contamination, food resources for benthic feeders, like shrimp, may be limited in highly contaminated areas (Weis et al. 1998; Brown et al. 2000; Dauer et al. 2000). While the survival of some aquatic organisms is affected by toxins, other organisms survive and bioaccumulate the chemicals to toxic levels, passing them along in the food chain. Multiple studies have shown clear connections between concentrations of toxins in sediments and those in benthic feeding fish and invertebrates (Kirby et al. 2001; Marburger et al. 2002). Heavy metal contamination of sediments has been documented to result in elevated trace metal concentrations in shrimp, striped mullet, oysters, and flounder (Kirby et al. 2001; Livingstone 2001).

There is some information available on the effect of certain toxic chemicals on different shrimp species. A study on the effect of copper, a common chemical associated with marinas, on a penaeid shrimp (*Metapenaeus dobsoni*) found that shrimp were tolerant to low concentrations of copper (0.05 mg Cu 1 super (-1)). However shrimp growth was significantly reduced when exposed to higher concentrations (0.15 mg Cu 1 super (-1)) (Manisseri and Menon 2001). Cellular damage to the hepatopancreas also occurred to shrimp exposed to 50-150 ppb Cu (Manisseri and Menon 1995). Another study examined mercury concentrations in both shrimp and blue crab, and found that blue crabs collected in the field with pink shrimp had higher mercury concentrations. The lower levels found in pink shrimp were attributed to shorter residence times in the contaminated area, differences in feeding habits, and the ability to excrete mercury somewhat faster (Evans et al. 2000).

Toxic chemicals come from localized point sources, as well as from diffuse nonpoint sources. Point sources include industrial and municipal waste discharges. Nonpoint sources of toxins include urban runoff containing household and yard chemicals, roadways, marinas and docks, boating activity, runoff from agriculture and forestry, industrial emissions, spills from industrial shipping, and dredge spoil disposal (Wilbur and Pentony 1999).

Because low concentrations of heavy metals in the water column can be easily incorporated into fine-grained sediment, chemicals can accumulate in the sediment to toxic levels and be resuspended into the water column (Riggs et al. 1991). Studies have shown that fine-grained sediments are the primary reservoir for heavy metals, particularly organic rich muds (ORM) (Riggs et al. 1991). Since ORM are the most extensive sediment type in North Carolina's estuaries, and since many primary nursery areas are composed of ORM, resuspension of contaminated ORM sediments in PNAs is of particular concern.

The extent of sediment contamination in North Carolina coastal waters is not well known. Sediment sampling is not conducted by the DWQ since there are no sediment standards in the state. Studies examining sediment contamination at sites in North Carolina soft bottom areas have found various levels of contamination. The EPA Environmental Monitoring and Assessment Program surveyed 165 sites within North Carolina's sounds and rivers during 1994-1997 to evaluate condition of bottom sediments (Hackney et al. 1998). Highest contamination levels occurred in low salinity areas with low flushing and high river discharge. Benthic populations were dominated by tolerant opportunistic species and benthic communities had low species richness. Laboratory bioassays showed that sediments from many sites were toxic to biological organisms. However, because of the low sample size, frequency of sampling, and the confounding effects of hypoxia in areas sampled, results from this study may not accurately assess the condition of North Carolina sediments (C. Currin, NOAA, personal communication).

Concentrations of heavy metals in the Neuse and Pamlico estuaries have been assessed (Riggs et al. 1989; Riggs et al. 1991). In the Neuse River, surface sediments contained elevated levels of several heavy metals, including zinc, copper, lead, and arsenic. Furthermore, 17 areas between New Bern and the mouth of the river were identified as "contaminated areas of concern". The contaminated sites were primarily attributed to permitted municipal and industrial treatment plant discharges. Marinas were also found to contribute substantial amounts of copper and variable amounts of zinc and lead. Nonpoint sources were more difficult to evaluate. In the Pamlico River, heavy metal contamination was less severe, although arsenic, cobalt, and titanium exceeded the levels found in the Neuse River. These studies suggest that sediment contamination in some estuarine areas especially those where both ORM and waste water discharges are present, may be significant and could affect fish populations and the base of their food chain. To better determine if contaminated sediment is a significant threat to shrimp habitat, the distribution and concentration of heavy metals and other toxic contaminants in freshwater and estuarine sediments need to be adequately assessed and areas of greatest concern need to be identified. Continued minimization of point and nonpoint sources of toxic contaminants is vital for protection of the entire ecosystem.

10.3.4 Tiger Shrimp

Tiger shrimp (*Penaeus monodon*), a non-native species of shrimp, have been observed in NC waters since 1988 when they were believed to have been released accidentally from an aquaculture facility in Bluffton, SC (Knott et al. 2012). Tiger shrimp have been observed from NC to TX. Although the impacts are not definitive at this time, tiger shrimp may pose a disease threat to native shrimp species. The NCDMF has been recording reported observations of tiger shrimp in NC waters since 2008. Whenever the public encounters what is believed to be a tiger shrimp it is reported to NCDMF and confirmed if possible. There have been a steady number of reports from the North Carolina ocean and estuarine waters throughout the coast since 2008 until 2011 when there was a large increase in the number of reports (Table 10.3). The reason for this increase is unclear, however the majority of those shrimp reported occurred in mostly southern shrimp catches after Hurricane Irene came through in August of 2011. This increase may be a result of local news stories after Hurricane Irene, or a potential spawning offshore community. The U.S. Geological Survey is investigating a potential community by collecting individuals and genetically testing them to determine the relationship (P. Fuller, USGS, personal communication 2012). The full impact of tiger shrimp in NC waters needs to be further investigated.

Table 10.3 Reported observations of tiger shrimp in NC since 2008.

Year	Yes ¹	No ²	Total Number of reported tiger shrimp
2008	12	4	16
2009	10	10	20
2010	1	4	5
2011	54	203	257

¹Confirmed by NCDMF and NC Coastal Federation staff.

²Reported tiger shrimp not confirmed may still be tiger shrimp.

10.4 HABITAT AND WATER QUALITY PROTECTION

10.4.1 MFC Authority

Presently, the MFC has authority to manage, restore, develop, cultivate, conserve, protect, and regulate marine and estuarine resources. Marine and estuarine resources are defined as “All fish [including marine mammals, shellfish, and crustaceans], except inland game fish, found in the Atlantic Ocean and in coastal fishing waters; all fisheries based upon such fish; all uncultivated or undomesticated plant and animal life, other than wildlife resources, inhabiting or dependent upon coastal fishing waters; and the entire ecology supporting such fish, fisheries, and plant and animal life” (G.S. 113-129).

Although MFC’s primary responsibilities are management of fisheries (seasons, size and bag limits, licensing, etc.), the MFC also has authority to comment on State permit applications that may have an effect on marine and estuarine resources or water quality, regulate placement of fishing gear, develop and improve mariculture, and regulate location and utilization of artificial reefs. MFC authority is found at G.S. 143B-289.51 and 289.52. The MFC and DMF should continue to comment on activities (state, federal, and local permits) that may impact estuarine water quality and work with permitting agencies to minimize impacts. Additionally, the MFC and DMF should solicit and support Fishery Resource Grant (FRG) and Coastal Recreational Fishing License Grant (CRFL) projects that may provide information necessary for protection, management, and restoration of water quality. Water quality standards should be based on the assimilative capacity of, and impacts to, the entire system. Several plans for water quality management have recommended strategies that need to be implemented to improve water quality. The MFC should continue to support management and research recommendations as outlined by the CHPP.

10.4.2 Authority of Other Agencies

Several divisions within the North Carolina Department of Environment and Natural Resources are responsible for providing technical and financial assistance, planning, permitting, certification, monitoring, and regulatory activities that have a direct or indirect impact on coastal water quality and habitat. The North Carolina Division of Coastal Management (DCM) is responsible for development permits along the estuarine shoreline in 20 coastal counties. Wetland development activity throughout North Carolina is permitted through the United States Army Corps of Engineers (COE) and the North Carolina Division of Water Quality (DWQ; 401-certification program). The DWQ permits and regulates discharges to surface waters, and

monitors water quality throughout the state. DWQ has established a water quality classification and standards program for “best usage” to promote protection of surface water supply watersheds, high quality waters, ecosystem functions, and the protection of unique and special pristine waters with outstanding resource values. Classifications, particularly for High Quality Waters (HQW), Outstanding Resource Waters (ORW), Nutrient Sensitive Waters (NSW) and Water Supply (WS) waters, outline protective management strategies aimed at controlling point and nonpoint source pollution. Various federal and state agencies, including DMF, evaluate projects proposed for permitting and provide comments and recommendations to the DCM, DWQ, and COE on potential habitat and water quality impacts. Various public agencies (state and federal) and private groups acquire and manage natural areas as parks, refuges, reserves, or protected lands, which helps to protect adjacent public trust estuarine water quality.

10.4.3 Nursery Area Protection

Existing rule definitions for fish habitat areas were revised by the Marine Fisheries Commission (MFC) in April 2009 in Marine Fisheries Commission Rule 15A NCAC 03I .0101 (4). The word “critical” was omitted since all fish habitats, under the ecosystem concept are critical to a properly functioning system as a whole. Regulatory protections exist for fish habitats areas such as primary nursery areas, secondary nursery areas, submerged aquatic vegetation, and shellfish producing areas.

Nursery areas are necessary for the early growth and development of virtually all of North Carolina’s important seafood species. Nursery areas need to be maintained, as much as possible, in their natural state, and the populations within them must be permitted to develop in a normal manner with as little interference from man as possible. In order to protect the integrity and resources of nursery areas, it is necessary to prohibit the use of bottom disturbing gears and severely restrict or prohibit excavation and/or filling activities.” The MFC and WRC first designated primary nursery areas in 1977 and 1990 respectively, based on field sampling. Approximately 162,000 acres of coastal fishing waters are currently designated by the MFC as Primary, Secondary and Special Secondary Nursery Areas.

There are specific protections for designated nursery areas included in the rules of three DENR commissions. For example, MFC Rule 15A NCAC 03N .0104 prohibits the use of trawls, dredges, long haul and swipe seines, and mechanical methods for oysters and clams in PNAs. Once an area has been designated as a PNA by the MFC, the area also comes under the protection of existing CRC rules (15A NCAC 07H .0208) and EMC rules [15A NCAC 02B .0301 (c)] that protect physical and water quality parameters of PNAs as a class. Various in-water work moratoria are also regularly required by state and federal agencies to protect sensitive habitat areas such as nursery and spawning areas from turbidity-related impacts. Due to the importance of that designation to DMF and the other agencies interested in protecting these nurseries, it is very important not to denigrate the integrity of the nursery area designation by naming areas that do not qualify under the rigorous biological sampling protocol and criteria established for nursery areas. .

The DMF conducted trawling and seine surveys in the early 1970s to inventory the state’s estuarine resources. The result of these surveys was the identification of estuarine areas that consistently supported populations of juvenile shrimp, crabs and finfish. Protection of these areas is imperative because they provide food, protection and proper environmental conditions (salinity and bottom type) for development and growth of young fish and crustaceans. Ninety percent of North Carolina’s commercially and recreationally important species are dependent on the estuary during some stage of their life cycle. The MFC adopted regulations in 1977 to

protect these estuarine areas known as nursery areas. Nursery areas are defined in Rule 15A NCAC 03I .0101(4)(f) as: “ Those areas in which for reasons such as food, cover, bottom type, salinity, temperature and other factors, young finfish and crustaceans spend the major portion of their initial growing season. Primary nursery areas are those areas in the estuarine system where initial post-larval development takes place. These are areas where populations are uniformly early juveniles. Secondary nursery areas are those areas in the estuarine system where later juvenile development takes place. Populations are composed of developing sub-adults of similar size which have migrated from an upstream primary nursery area to the secondary nursery area located in the middle portion of the estuarine system.”

The primary criteria for determining primary nursery areas are abundance of selected recreationally and commercially important species during recruitment periods, size composition, species diversity, bottom type and depth.

Abundance

Abundance of selected species is the primary criteria for selecting nursery areas. Selection of species for analysis is based on the area being considered, however, the species typically used in analysis are: brown shrimp, blue crab, spot, Atlantic croaker and southern flounder.

Size Composition

Another important characteristic of a nursery area is size of species in nursery area. Primary nursery areas are distinguished by the presence of finfish and crustacean populations that are uniformly very early juveniles. Size data are collected to determine the proportion of target species that are juveniles.

Species Diversity

The utilization of the site by various species is another indication of nursery area function. An index of species diversity summarizes community structure and takes into account, species richness as well as evenness of individuals among species.

Bottom Type

Bottom sediments in existing primary nursery areas are primarily coarse silt or clay with a high organic content. Most substrates are variously covered with detritus consisting of tree or shrub leaves, bark and branches, and dead marsh grasses. Numerous species of juvenile estuarine fishes in North Carolina are associated with this bottom type. Bottom type is categorized as mud, sand, or a combination of mud and sand.

Depth

Existing primary nursery areas generally have water depths of less than six feet. The most productive and valuable zone in many estuaries is the intertidal and shallow subtidal area.

The DMF's estuarine trawl sampling program (Program 120) provides data to identify nursery areas. It also provides a long-term database of annual juvenile recruitment of economically important species as provided by the core stations. This database has been used for designation of new nursery areas in the past and continues to be the main source of data and information used to designate future potential nursery areas.

Once a waterbody has been identified as a potential nursery area site, a sampling station for that area is established. Once that station has been established, it is sampled a minimum of three years. Comparison stations in approved PNAs located in close proximity to the proposed nursery area must also be established if they are not already a core station. Other PNAs

located in the same major waterbody are also included in the sampling. These PNA stations also must be sampled a minimum of three years, preferably on the same day and same tide.

Some areas that may be identified as a potential nursery area site will be unsuitable to trawling due to depth or underwater obstructions. Other gear types may need to be considered in order to properly compare those areas with nearby nursery areas. If this is the case, a gear is selected that can be used in both the potential nursery area and the comparison nursery areas. Once a sampling scheme has been determined, sampling continues for a minimum of three years.

Proposed PNA designations with supporting data are presented to the MFC. Comparisons of abundance and size are presented, along with environmental parameters including depth, sediment type, and salinity and compared to nearby designated PNAs. If the MFC approves the PNA to go to the advisory committees and the public for comment, it will then follow the normal rulemaking procedures to be designated.

Additional rules protecting PNAs were created under the authority of the Coastal Area Management Act (CAMA) of 1974. CAMA provided rules for coastal development, such as prohibiting dredging of channels, canals and boat basins in primary nursery areas. Construction of marinas that require dredging is also prohibited in PNAs. These restrictions are based on the quality of scientific analyses that goes into designation of nursery areas.

It is important to recognize the distinction between the generic term “nursery area” and the specific regulatory designations of “Nursery Area”. For example, Pamlico Sound maintains a diversity of habitat functions. Its abundance of young finfish as well as shrimp and crabs is well documented and therefore is often termed a nursery area. However, the regulatory designation of a nursery area is specific to the MFC’s intent of balancing competing public trust uses with the goal of habitat protection.

10.4.4 Coastal Habitat Protection Plan

The Fisheries Reform Act of 1997 (FRA 1997) mandated the Department of Environment and Natural Resources (DENR) to prepare a Coastal Habitat Protection Plan (CHPP -- G. S. 143B-279.8). The legislative goal for the CHPP is long-term enhancement of the coastal fisheries associated with coastal habitats and provides a framework for management actions to protect and restore habitats critical to North Carolina’s coastal fishery resources. The Coastal Resources Commission, Environmental Management Commission, and the Marine Fisheries Commission must each approve and implement the plan for it to be effective. These three Commissions have regulatory jurisdiction over the coastal resources, water, and marine fishery resources. The CHPP was initially approved in December 2004, updated in 2010 (Deaton et al. 2010), and implementation plans are developed every two years. Actions taken by all three commissions pertaining to the coastal area, including rule making, are to comply, “to the maximum extent practicable” with the plans. The CHPP will help to ensure consistent actions among these three commissions as well as their supporting Department of Environment and Natural Resources agencies and will be reviewed every five years.

The CHPP describes and documents the use of habitats by species supporting coastal fisheries, status of these habitats, and the impacts of human activities and natural events on those habitats. Habitats are categorized as wetlands, submerged aquatic vegetation (SAV), soft bottom, shell bottom, ocean hard bottom, and water column. The plan explains the environmental requirements, ecological value, status, and threats of the six fish habitats and

includes management recommendations to protect and enhance the entire coastal ecosystem. Much of the information provided in this section of the FMP came from the CHPP.

The CHPP recommends that some areas of fish habitat be designated as “Strategic Habitat Areas” (SHAs). Strategic Habitat Areas are defined as specific locations of individual fish habitat or systems of habitat that have been identified to provide critical habitat functions or that are particularly at risk due to imminent threats, vulnerability or rarity. While all fish habitats are necessary for sustaining viable fish populations, some areas may be especially important to fish viability and productivity. Protection of these areas would therefore be a high priority (Deaton et al. 2010). Habitat mapping and change over time is the foundation for SHA identification. DMF has an ongoing bottom mapping program, and other agencies and universities provide habitat distribution information as well. The process of identifying and designating SHAs was initiated in 2005. The coastal regions of NC have been divided into regions for the SHA process. SHAs for the Albemarle Sound and Northeast Coastal Ocean were completed in 2009 and the SHAs for the Pamlico Sound area and Central Coastal Ocean were completed in 2011. The remaining portions of NC should be completed within the next couple of years. SHAs should be identified and delineated that will enhance protection of penaeid shrimp. See Section 10 for recommended habitat and water quality actions.

Habitat protection, conservation, and restoration are essential to accomplish the goal and objectives of this plan. The FRA gives precedent to the CHPP and stipulates that habitat and water quality considerations in the fishery management plan be consistent with CHPP. Management actions recommended in this plan that are under MFC authority will be acted upon directly, while those management actions under other DENR authorities will be considered and acted upon through the CHPP implementation process and the appropriate agencies. Through that process, the MFC, Coastal Resources Commission (CRC), and Environmental Management Commission (EMC), and WRC should adopt rules to protect critical habitats for shrimp as outlined in the Coastal Habitat Protection Plan (CHPP). The DENR should develop a strategy to fully support the CHPPs process with additional staff and funding. The MFC and DMF should continue to comment on activities that may impact aquatic habitats and work with permitting agencies to minimize impacts and promote restoration and research. Research needs to be conducted to investigate the impacts of trawling on various habitats.

10.5 STATUS OF 2006 SHRIMP FMP ENVIRONMENTAL FACTORS RECOMMENDATION

Since the 2006 Shrimp FMP, habitat and water quality conditions appear to be the same or in some cases, somewhat better. The area of submerged aquatic vegetation coverage appears to be expanding in estuaries south of New River and in the lower salinity estuaries of the Neuse and Tar-Pamlico. The latter increase could be related to nutrient reduction efforts in those river basins, but may also be a result of several years of drought. Wetland acreage continues to decline from permitted losses and natural erosion associated with storms and rising sea level. Efforts have increased to restore more subtidal oyster beds in Pamlico Sound through DMF’s oyster sanctuary program and partnerships with non-profit organizations. Water quality degradation, in terms of aquatic life use support impairment, is greatest in freshwater streams in the Neuse and Cape Fear River basins and in estuarine creeks in the Neuse River basin. Fish kill events have declined in number but have been increasing in size.

In reviewing the 2006 Shrimp FMP habitat and water quality management recommendations, many have been implemented or are substantially underway. Many of these were also components of the CHPP implementation plan. They include:

Habitat

1. Coast-wide imagery of SAV was taken in 2007/2008 and has been mapped.
2. Identification and designation of Strategic Habitat Areas has been completed for the Albemarle and Pamlico Sounds along with their associated rivers.
3. Dredging of PNA, SAV, and shellfish habitat is avoided through DMF's permit review process.
4. CRC has revised dock rules to require review by resource agencies for General Permit dock applications located over SAV, shell bottom, or PNAs, and where water depth is less than 2 ft MLW to avoid boating related impacts.
5. Additional bottom disturbing gear restrictions have been implemented through the bay scallop and oyster fishery management plans to avoid damage to SAV and oysters.
6. Additional funding has supported expansion of oyster sanctuaries, development of a shell recycling program to supplement cultch planting, and acceleration of shell bottom mapping.
7. Ecosystem Enhancement Program is in the process of evaluating non-traditional but effective mitigation techniques for wetland, oyster, and SAV impacts, and improving the mitigation process.
8. Neuse and Tar-Pamlico NSW nutrient reduction measures have successfully reduced nutrient loading by more than their 30% reduction goals for point source dischargers and agriculture.
9. DWQ revised coastal stormwater rules that limit impervious surface and run-off in coastal areas.
10. Loss of additional riparian wetlands has been minimized through the permitting process, land acquisition, and land use planning.
11. Resource and regulatory agencies have been cooperating to promote alternative shoreline hardening measures. These measures include marsh sills.
12. The MFC has created an informational paper on the effects of contaminants. DMF has worked with partners to collect unused medicines as part of Operation Medicine Drop.

Water Quality

1. DMF staff continues to work with the permitting and commenting agencies to enhance protection of water quality. The MFC utilizes its permit commenting authority outlined in G.S. 143B-289.52 as needed.
2. DCM has created a clean marina program to promote environmentally friendly marinas.
3. Wetland buffers along coastal streams and rivers have been used to enhance wetlands and improve water quality.

10.5.1 Coastal Habitat Protection Plan Actions

There are many actions that natural resource managers can take to sustain and enhance habitat and water quality conditions for shrimp. High priority needs include:

- Preserving existing coastal wetlands and restoring wetlands
- Protecting PNAs from dredging and water quality degradation
- Protecting and enhancing SAV habitat
- Assessing sediment contamination in NC estuaries and effects on shrimp
- Reducing pollutant loading from point and non-point sources

These management needs are currently being addressed through several existing CHPP recommendations (Deaton et al. 2010) and implementation actions (DENR 2011) that were approved by the CHPP Steering Committee. Listed below are those CHPP recommendations

and implementation actions that could be beneficial for protecting and improving habitat and water quality issues affecting shrimp. Numbering refers to the CHPP recommendations. Implementation actions are denoted by (I) following the recommendation number.

- 2.1 Support Strategic Habitat Area assessments by:
 - a) Coordinating, completing, and maintaining baseline habitat mapping (including seagrass, shell bottom, shoreline, and other bottom types) using the most appropriate technology
 - b) Selective monitoring of the status of those habitats

Of specific importance for shrimp is:

- remapping and monitoring SAV in North Carolina to assess change in distribution
- assessing the distribution, concentration, and threat of heavy metals and other toxic contaminants in freshwater and estuarine sediments and identify the areas of greatest concern to focus water quality improvement efforts
- monitoring to determine if additional areas should be designated as Primary Nursery Areas due to their nursery importance to shrimp

2.2 Identify, designate, and protect Strategic Habitat Areas.

- 3.1 Expand habitat restoration in accordance with restoration plan goals, including:
 - a) Creation of subtidal oyster reef no-take sanctuaries
 - b) Re-establishment of riparian wetlands and stream hydrology
 - c) Restoration of SAV habitat and shallow soft bottom nurseries

Of specific importance for shrimp is protection and restoration of coastal wetlands and SAV.

- 3.3 Protect habitat from fishing gear effects through improved enforcement, establishment of protective buffers around habitats, modified rules, and further restriction of fishing gear where necessary.

Of specific importance for shrimp is periodic re-examination of areas where trawling, oyster dredging or mechanical harvest is currently allowed to determine if conflicts with habitat protection exist.

- 3.4 Protect estuarine and public trust shorelines and shallow water habitats by revising shoreline stabilization rules to include consideration of erosion rates and prefer alternatives to vertical shoreline stabilization measures that maintain shallow nursery habitat.

- 3.7 (I) Develop an interagency policy for marina siting to minimize impacts to ecologically important shallow habitats such as Primary Nursery Areas (PNA), Anadromous Fish Spawning Areas (AFSA), and SAV.

- 4.1 Reduce point source pollution discharges by:
 - a) Increasing inspections of wastewater treatment facilities, collection infrastructure, and disposal sites
 - b) Providing incentives for upgrading all types of discharge treatment systems

- c) Developing standards and treatment methods that minimize the threat of endocrine disrupting chemicals on aquatic life.
- 4.5 Improve strategies throughout the river basins to reduce non-point pollution and minimize cumulative losses of fish habitat through voluntary actions, assistance, and incentives, including:
- a) Improved methods to reduce pollution from construction sites, agriculture, and forestry
 - b) Increased on-site infiltration of stormwater
 - c) Encouraging and providing incentives for low-impact development
- 4.6 Improve strategies throughout the river basins to reduce non-point pollution and minimize cumulative losses of fish habitat through rule making, including:
- a) Increased use of effective vegetated buffers
 - b) Implementing and assessing coastal stormwater rules and modify if justified
 - c) Modified water quality standards that are adequate to support SAV habitat
- 4.8 Reduce non-point source pollution from large-scale animal operations

11.0 MANAGEMENT STRATEGIES

11.1 HISTORY OF SHRIMP MANAGEMENT

Shrimp management in North Carolina has evolved from early biological work done in the mid-1960s. At that time, studies were conducted on the behavior of our three species of shrimp (pink, brown and white), their growth rates, mortality and migration, habitat preferences, and salinity and temperature tolerances.

A major step in the evolution of management came in 1978 with the designation of PNA and SNAs. These are the shallow bays and tributaries with low salinities, muddy bottoms and detritus where the shrimp spend their post-larval and juvenile development. In these shallow waters, food is abundant, salinities and temperatures are optimal, and there are few predators. No trawling is allowed in PNAs and SNAs to allow the shrimp to grow to harvestable size with as little man-made disturbance as possible. A SSNA designation originated in the 1980s to protect the shrimp during the majority of the season and allow harvest toward the end of the season, when shrimp are of harvestable size and juvenile fish have migrated out of the bays. The Fisheries Director may, by proclamation, open any portion of SSNAs to shrimp or crab trawling from August 16 through May 14. Management rationale included minimizing waste by delaying the trawl opening date to reduce the finfish bycatch and to ensure catches of larger shrimp. North Carolina was the first state to require the use of BRDs in shrimp trawls and requires them to be installed in specific tailbag locations in order to reduce the incidental catch of juvenile finfish. The strategy of DMF has been to protect the sensitive nursery areas and critical habitats while working to reduce bycatch as much as possible (see section 6.3 Bycatch).

Other management measures that have been implemented include the 1 ½ inch minimum mesh size in shrimp trawls, no trawling areas in the Outer Banks sea grass beds, military restricted areas, and weekend closures in internal waters from 9:00 p.m. on Friday nights to 5:00 p.m. on Sunday nights, among others. The Director has proclamation authority to open and close waters within the estuaries and the Atlantic Ocean based on shrimp size and environmental conditions. This flexibility in opening and closing shrimping areas is a valuable management tool, but it makes managers subject to the lobbying efforts of the various user groups.

Shrimp management varies from the southern portion of the state to the northern part because of species behavior and differences among geographic areas as well as preferences of the user groups. In the Roanoke Island area, which is the northernmost range for NC shrimp, the management of SSNAs is based more on the protection of juvenile finfish than on the harvest of shrimp. Sampling is conducted to insure that the small fish have left the bays and, if shrimp are present, the area is opened. Abundant shrimp in the northern part of the state is such a rare occurrence that nearly any size is considered harvestable, and by August 16, they are usually of sufficient size.

Before the implementation of the 2006 Shrimp FMP, attempts were made to limit the frequent movement of shrimp lines by meeting with the fishermen, discussing the problems, and seeking answers acceptable to the majority, while offering reasonable protection for the small shrimp. For example, a meeting was held at Harkers Island in 1997 about a possible solution to North River shrimp line and by unanimous choice, a permanent line was agreed to and implemented. The line works well, unless there are tremendous numbers of shrimp or significant rainfall, which cause smaller ones to spill over into the open area. Still the shrimp are marketable and provide income to the fishermen, particularly the early summer pink shrimp.

Closing an area in mid-season may result in a “grand opening” later. Areas like Adams Creek, Newport or North River may have up to 200 boats, regardless of the abundance of shrimp. This large number of vessels operating in confined waterbodies results in dangerous navigational situations. Fish kills following shrimp openings in New River and Bay River in the past have brought attention to trawling impacts. The detrimental effects of these openings to the bottom and juvenile fish in the area make it very desirable to avoid them whenever possible. The implementation of the 2006 Shrimp FMP led to the development of other management strategies to protect habitat, reduce bycatch, minimize user conflict and bring consistency to the management of the shrimp fishery. The following sections outline these management strategies as developed in the 2006 plan. Details of the development of these strategies may be found in the appendices of the 2006 Shrimp FMP (NCDMF 2006).

11.2 SHRIMP MANAGEMENT BY SIZE

Shrimp grow at different rates depending on water temperature and salinity. As growth increases, shrimp migrate to deeper, saltier waters of the sound and eventually to the ocean. As shrimp migrate to the ocean, they enter areas that are open or may be opened by the DMF to the harvest of shrimp. Sampling is conducted by the DMF staff to determine if an area should be opened or closed, based primarily on size and count. Over time, target sizes for opening different waterbodies have evolved and allow for better flexibility of management for both recreational and commercial shrimping.

Although highly variable, the density of shrimp in the nursery areas during the spring as well as weather conditions in the critical spring nursery months determine the number and size of shrimp in the different waterbodies. Overcrowding and its associated competition for food and space cause the shrimp to migrate downstream earlier than normal with wind and rainfall compounding the problem. At times when this occurs, the event is over before a closure can take effect or the shrimp have crossed the line established by consensus, which the Division will honor.

Shrimp in the Southern District, with no extensive bays and sounds to grow and develop begin to migrate at a smaller size. The waters of Onslow, Pender, New Hanover, and Brunswick counties that are available for opening to trawling are typically located either in or landward of the Intracoastal Waterway (IWW), which runs the entire length of all four counties' coastlines. Portions of these narrow waters may remain closed during part of the shrimping season or not open at all, depending on the size of the shrimp observed in the DMFs samples. Target opening size in Brunswick and portions of New Hanover counties is 40-50 count (heads on). In Onslow and parts of Pender counties, sampling has shown that a 20-30 count target size can be achieved before migration occurs. Channels that connect the IWW with the Atlantic Ocean have been left open to allow some harvest of shrimp as they migrate from closed areas to the ocean. Trawling in these migration routes has become the subject of discussion among shrimpers as well as the public because of concerns about bycatch of other species as well as interference with navigation. One migration route that has been the subject of recent controversy is the channel leading to Blue Water Point Marina in Brunswick County.

The target size of shrimp in the majority of the Central District and Pamlico District is 26-30 or 27-35 count (per pound heads-on) although White Oak River shrimp tend to be smaller with a 45-50 count (heads-on) targeted size.

Consideration must be given to the entire range of users, from the 15' outboard in the shallow water sounds and river tributaries to the 85' ocean trawler. In most cases, 100 pounds of 45 count (heads-on) shrimp would be much more valuable if permitted to grow to 16-20s, even factoring in the mortality suffered in the meantime. Even this statement has its exception in the spring pink shrimp fishery in the North River area of Carteret County when 45 count shrimp bring up to \$2.50 per pound. Managing for 16-20 count shrimp would eliminate the majority of the shrimp fleet and leave the catch to larger trawlers in Pamlico Sound and the ocean and to some channel netters. The current management strategy is to allocate some of the public resource to all groups.

Unusual weather events or the occurrence of unusually high numbers of small shrimp may occasionally force closures of normally opened areas like a portion of Neuse River or in the ocean south of Cape Fear.

Target sizes for opening have evolved: 26-30 count from Pamlico Sound to White Oak River; 45-50 count in the White Oak River; 20-30 count in New River and parts of Pender County; and 40-50 count in Brunswick and parts of New Hanover counties. At the present time modal groups are used and some shrimp are larger and some smaller than our target. Openings based on these target sizes have addressed the variability within the state of boat sizes and size preferences of the user groups, geographical differences in the shrimp size at migration, weather events, and socio-economic conditions.

11.3 SHRIMP MANAGEMENT BY AREA

Historically, the DMF has used a number of criteria to determine if trawling should be allowed in estuarine waters. These criteria include habitat issues such as aquatic vegetation, water depth and bottom types; shrimp size and abundance; economic and social factors; user conflicts; and bycatch issues.

DMF has utilized rules and proclamations to manage trawling in ocean and internal coastal waters. The intention of these rules and proclamations has been to allow the harvest of shrimp and crabs in estuarine waters but prohibit directed finfish trawling. Openings and closings of specific areas are based primarily on the size of the shrimp.

The closure of nursery areas and the protection of sea grass beds through rules, and proclamations are designed to minimize the bottom-disturbing effects of trawling (see Section 10. Environmental Factors). Trawling is limited primarily to the large bodies of water, such as the rivers, sounds and ocean. Shoals, wrecks, obstructions, oyster rocks, and algal and bryozoan growth make some of this open water area inaccessible to trawls. There are also areas opened to shrimping that receive very little effort because shrimp abundance is low.

Shellfish management areas (SMAs) are another critical habitat where trawling is prohibited (15A NCAC 03N.0104 and 0105.03J.0103). While these regulations protect the substrate from physical damage by trawls, bottom-disturbing gear used adjacent to the SMAs impacts oyster reefs indirectly by re-suspending sediment. As sediment disperses away from the disturbance and settles to the bottom, it can bury oyster larvae, adults, or shell, deterring successful recruitment of larvae due to lack of an exposed hard substrate (Coen et al. 1999). Additionally, excessive sedimentation can also harm shellfish by clogging gills, increasing survival time of pathogenic bacteria, or increasing ingestion of non-food particles (SAMFC 1998).

DMF conducts regular sampling to monitor shrimp size and abundance and takes appropriate action based on the samples. Waters eligible to be opened to trawling may also be closed if the size of the shrimp is too small. Closures of this nature are primarily influenced by economics since small shrimp have little value and if there is no market, the resource is wasted. Affected areas include those where shrimp size changes predictably based on annual cycles and environmental conditions as well as those areas where the habitat has changed in response to physical changes such as inlet closures and shoaling. Waters have also been closed in order to reduce or eliminate conflicts with other users and traditional uses such as navigation. These would include closure of crab pot areas and navigation channels where shrimping activity has been problematic.

11.3.1 Shrimp Management in the Southern District

DMF has been managing the shrimp harvest since the early 1970s. In 1977, based on sampling conducted over a number of years the DMF designated nursery areas (both primary and secondary) throughout the State that were closed to all bottom disturbing gear, including shrimp trawls. Many of these nursery areas are in the southern part of the State and include those areas that are most biologically sensitive to trawling. Additional areas were closed in the 1980s in reaction to an increase in fishing effort. Time and area closures were the only tools available to deal with the increase in effort. The net result of all these closures is that approximately one-third of the waters in Onslow, Pender, New Hanover and Brunswick counties can be opened to shrimp trawling. However, portions of these waters may remain closed or not be open at all depending on the size of shrimp observed in DMF's samples. While this strategy helps protect these areas, it forces the fishery to operate in a smaller area thus increasing user conflicts.

The areas that can be opened to shrimping are typically located either in or landward of the IWW which runs the entire length of the Onslow, Pender, New Hanover and Brunswick counties coastline. The heads-on counts used to determine whether to open an area vary by area based on historical sampling which indicates at what size shrimp tend to migrate from different water bodies. In Brunswick and portions of New Hanover counties, where shrimp migrate at smaller sizes, DMF attempts to open on a 40-50 count shrimp. In Onslow and parts of Pender counties, sampling has shown that a 20-30 count can be attained before migration occurs. Channels that connect the IWW with the Atlantic Ocean are normally left open at all times to allow some harvest of shrimp as they migrate from closed areas to the ocean. Trawling in these migration routes has become the subject of discussion amongst shrimpers as well as the public because of concerns about bycatch as well as interference with navigation.

11.3.1.1 Brunswick County

The Brunswick County coastline stretches for approximately 33 miles and is bound by the Cape Fear River Inlet on the east end and by the Little River Inlet on the west end. Four barrier islands, all of which are densely developed, are separated by five inlets along the coastline.

The IWW in Brunswick County is managed based on the size and abundance of the shrimp taken in the DMF's samples. The area is usually open until the beginning of June when it is closed because of small brown shrimp. In most years, portions may be opened in late June or early July to allow harvest of brown shrimp and then closed in late July or early August when small white shrimp recruit to the area. Occasionally, small white shrimp may appear before the brown shrimp reach a harvestable size, thus delaying an opening until the whites are harvestable, usually in September but sometimes as late as November. Principle harvest areas

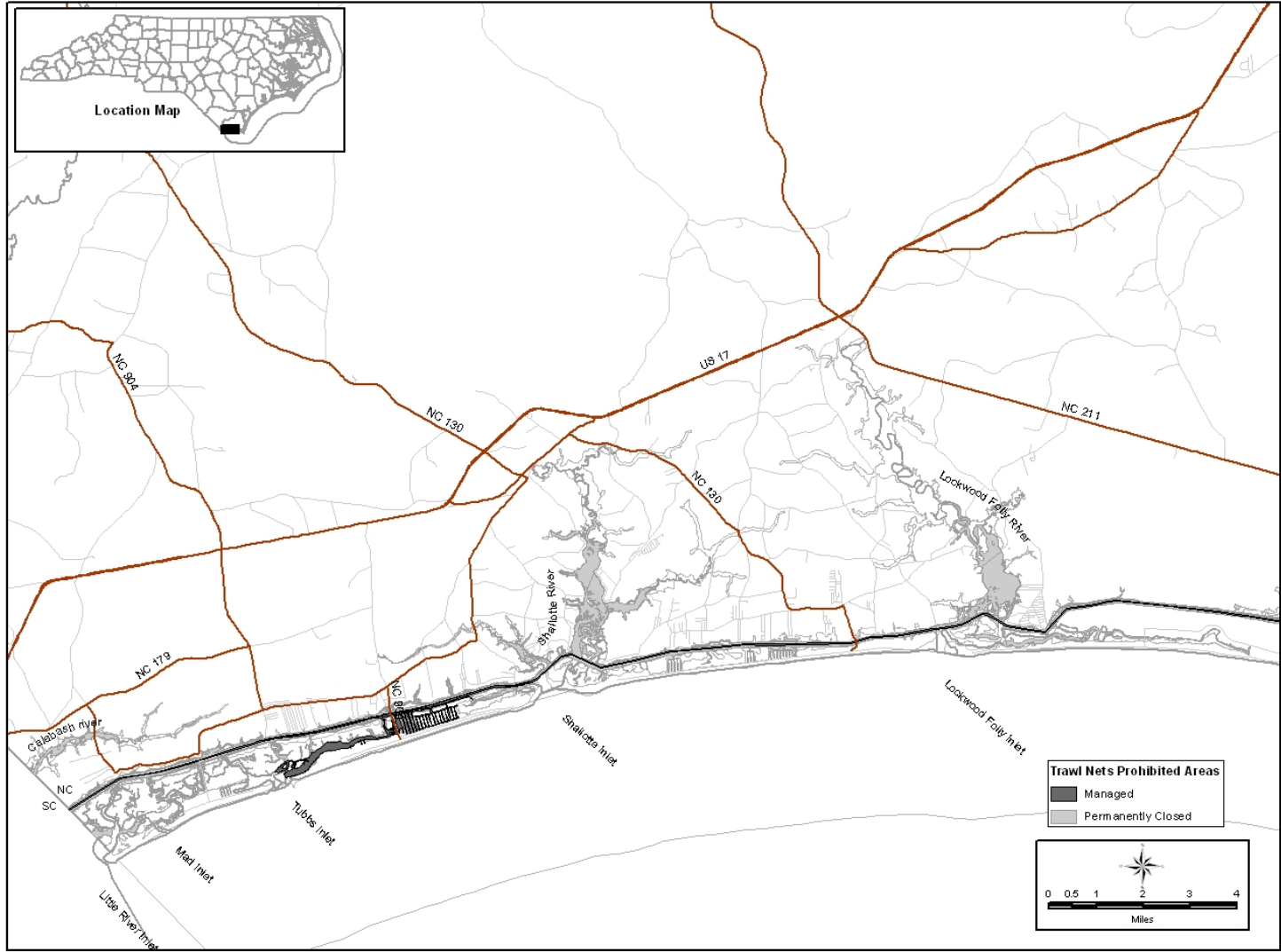


Figure 11.1 Map of shrimp management areas in Brunswick County.

are behind Oak Island, from the Holden Beach Bridge to Shallotte River and from the Ocean Isle beach bridge to the Sunset Beach Bridge (Figure 11.1).

The IWW channel from the Sunset Beach Bridge to the South Carolina State Line and the Calabash River are rarely opened to trawling because of the abundance of small shrimp. The area from Sunset Beach Bridge to Calabash River is usually opened toward the end of the season so that the shrimp won't be "lost" to South Carolina.

The channels that connect the IWW with the Atlantic Ocean usually remain open during the entire year to allow harvest of shrimp that are migrating to the ocean. In rare instances of very heavy rainfall, these channels may be closed. The areas include Elizabeth River, Dutchman Creek, Montgomery Slough, Jink's Creek and Bonaparte Creek. Trawling in Montgomery Slough and the Elizabeth River has become the subject of discussion amongst shrimpers as well as the public because of concerns about bycatch as well as interference with navigation. Eastern Channel, located behind Ocean Isle Beach, is a shallow channel (less than one meter at mean low tide) that connects the IWW at Marker 93 to Jink's Creek. These waters have not been opened to harvest in over 20 years.

The Shallotte River was opened and closed to shrimp trawling based on size and abundance until 1998. However, DMF sampling has shown that these shrimp rarely reach large sizes with the heads-on count remaining greater than 60 during most of the season. Consequently, the last time DMF opened Shallotte River was a span of time in 1998 between July 8 and September 9.

11.3.1.2 Cape Fear River Complex

The waters of the Cape Fear River, the Basin, Second Bay, Buzzard's Bay (the Bays) and Bald Head, Cape and Bay Creeks (the Creeks) are part of the Cape Fear estuarine system (Figure 11.2). Bottom types range from sand near the inlet and creek mouths to mud in some of the bays and channels near Snow's Cut. There are active clam and oyster fisheries in the bays, creeks and the river upstream to the Fort Fisher Ferry Terminal. These fisheries occur primarily by hand and in shallow water though there are tong and bull rake clam fisheries in the deeper areas. In some of the deeper areas of the Cape Fear, clam and shrimp fisheries co-exist. There are active crab pot and gillnet fisheries throughout the entire estuary. There are several Primary, Secondary and Special Secondary Nursery Areas located in the Cape Fear River.

The area in the Cape Fear that is open to shrimping is dredged on a regular basis for navigation purposes. The river is managed on the size of shrimp and various parts of the river are opened and closed based on the DMF's samples. The upstream line was placed at Snow's Cut for many years because of the abundance of small shrimp above this line. The line was moved upstream in 2003 based on larger shrimp being present at that location. The river has not been closed in recent years because when small shrimp were in the open areas the participants have chosen not to harvest them.

The bays south of Fort Fisher known as the Basin or First Bay, Second Bay and Buzzard's Bay have been managed in the past as a unit with openings and closings based on the DMF's samples. New Inlet drained these areas but closed after a series of hurricanes in the late 1990s and circulation is now through the Cape Fear. Since the inlet closed, DMF has observed a shift in the biological characteristics of these waters towards more of a nursery area. Consequently, the size of the shrimp tends to remain small in this area and have remained closed since 2002.

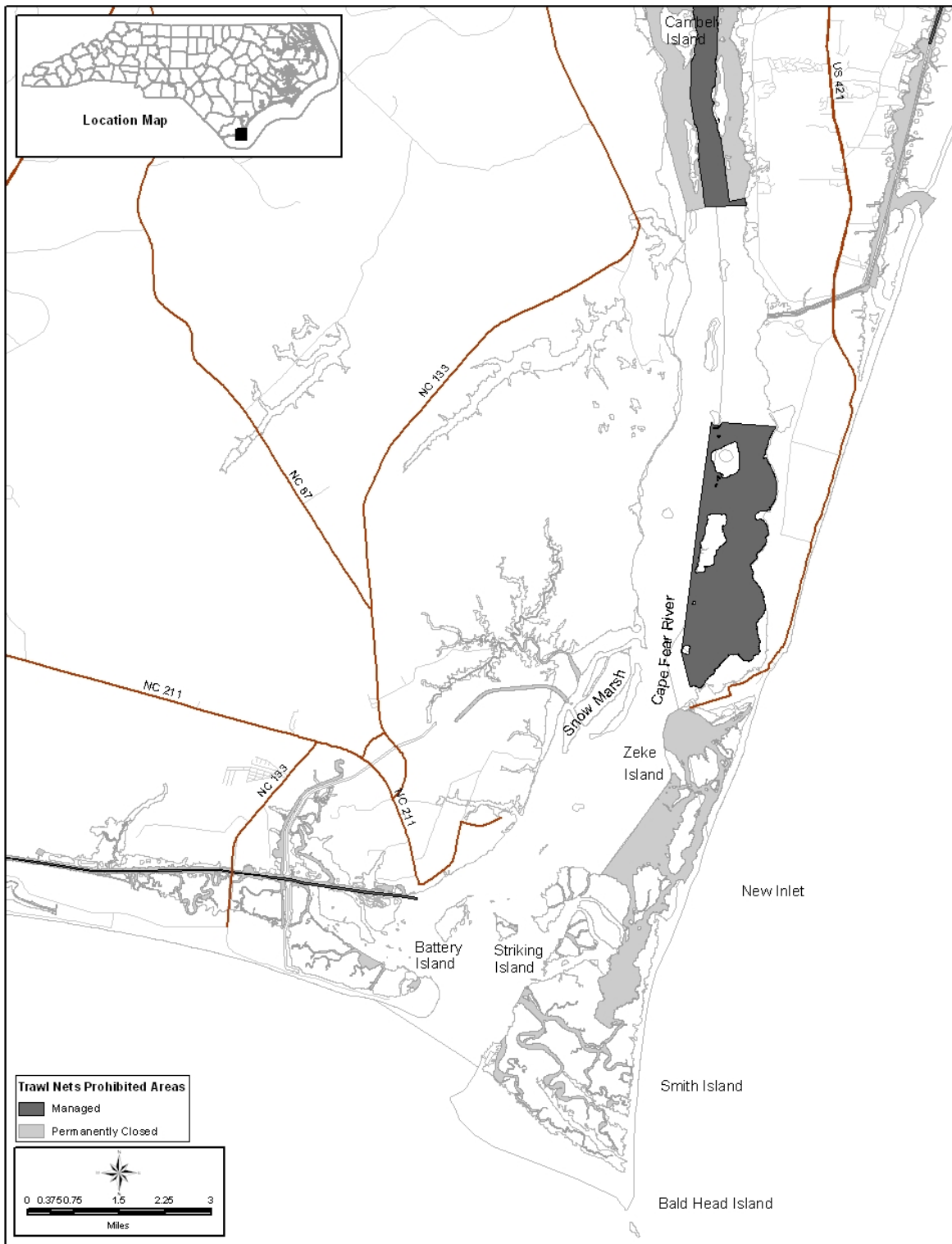


Figure 11.2 Map of shrimp management areas in the Cape Fear River Complex.

Historically, the Bald Head Creeks were usually opened in late June or early July based on the size of shrimp. Areas opened included the lower portions of the Creeks. However, following the implementation of the 2006 Shrimp FMP, no trawling areas were established in the bays south of Fort Fisher and Bald Head Creeks. The main river has remained open to shrimping with potential opening dates set by proclamation and determined by DMF sampling.

Trawling trips in the main part of the Cape Fear are usually day trips and fishery operations are performed primarily from small boats using otter trawls, although vessels up to 50 feet may work in the channels of the Cape Fear. The 2006 Shrimp FMP restricted the total headrope length for otter trawls to 90 feet in the Cape Fear River. There are no other mobile gears used but there has been some use of channel nets in the past.

11.3.1.3 Intracoastal Waterway and Sounds from Carolina Beach to Rich's Inlet

The estuarine waters of the IWW channel and adjacent sounds between Carolina Beach and Rich's Inlet stretch over 21 miles and include four inlets separating four barrier islands, three of which (Figure Eight, Wrightsville, Carolina Beach) are heavily developed (Figure 11.3). These waters are bordered on the south by the Carolina Beach Yacht Basin (CBYB) and to the north by Rich's Inlet. The largest inlet is Masonboro Inlet and it is located approximately in the center of these estuaries where it separates Wrightsville Beach from Masonboro Island.

Bottom types are primarily sand throughout the area with the exception of more soft muddy substrates in the sounds and portions of the IWW. Submerged aquatic vegetation (SAV) is limited to a few patches in the shallow sound areas. There are active oyster, clam, and crab fisheries throughout the area. These fisheries are prosecuted in the sounds and along the edges of the IWW. The waters contain a few shellfish leases and DMF maintains six SMAs from Hewlett's Creek north to Rich's Inlet. In addition, DMF and the Coastal Federation a non-governmental organization located in Newport, NC, have collaborated on construction of an oyster sanctuary in the mouth of Hewlett's Creek. Areas closed to the harvest of shellfish due to pollution are abundant and include all or portions of creeks on the mainland side of the IWW as well as most of the Wrightsville Beach area and buffers around numerous marinas.

Most all of these areas receive very minimum shrimping effort with little or no impact on shellfish resources. Exceptions are a section of the IWW in Myrtle Grove Sound (William's landing) and the CBYB. Additionally, some of the channels around Wrightsville Beach also receive shrimping effort at various times during a typical year. Both commercial and recreational shrimpers utilize these waters.

The William's Landing area has been difficult to manage because the shrimp often migrate before reaching larger sizes (30-40 count, heads-on) except in the fall. In some years, large concentrations of algae (*Grassilaria* and *Ulva spp.*) prevent the use of trawls until the shrimp grow to an acceptable count while in other years there has been harvest of small shrimp. The CBYB is opened and closed based on the size of shrimp present. Channels around Wrightsville Beach remain open to allow harvest of shrimp migrating to the ocean. Historically, the area of the IWW from the Wrightsville Beach drawbridge to Marker #105 at Green's Channel has always remained open to shrimping but received little effort from commercial or recreational fisherman. However, the IWW was closed to trawling from Marker #105 to the Wrightsville Beach drawbridge following the adoption of the 2006 Shrimp FMP. Actions were also taken to manage the IWW from Marker #139 to Marker #146 as a SSNA, opening by proclamation from August 16 through May 14. However due to the abundance of small shrimp and large concentrations of algae, this area is rarely opened during this time period.

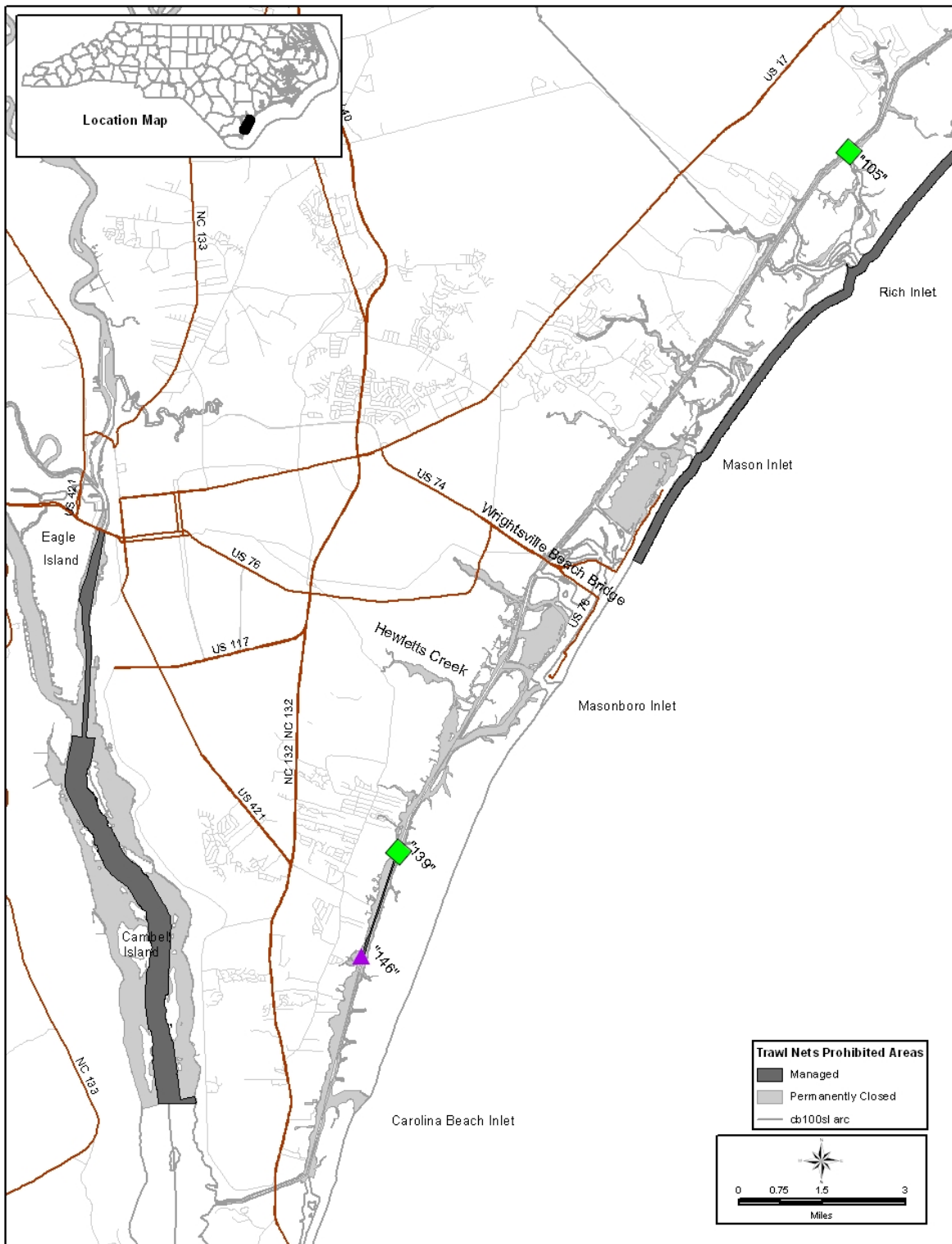


Figure 11.3 Map of shrimp management areas in the Intracoastal Waterway and sounds from Carolina Beach to Rich's Inlet.

11.3.1.4 Intracoastal Waterway and sounds from Rich's Inlet to New River

The estuarine waters of the IWW channel and the adjacent sounds and bays between Rich's Inlet and New River Inlet are managed as a single waterbody by the DMF (Figure 11.4). A section of this waterbody bounded by Marker #17 to the north and the Surf City swing bridge to the south is designated as SSNA. Historical data (since 1972) collected by DMF indicates these waters support large aggregations of commercially important finfish as well as shellfish and crustaceans.

Bottom types range from mud and muddy/sand in the IWW to mostly sand near the inlets. The shallow waters of Topsail Sound and some of the estuarine areas around New River Inlet contain patches of SAV.

There are active clam and oyster fisheries in the entire area. Hand harvest for oysters and clams take place in the shallow areas throughout these waters on both public bottom and leased areas, while mechanical harvest of clams is allowed in the IWW from New River to south of the Surf City bridge ("BC" Marker). DMF maintains Shellfish Management Areas throughout the area, all of which are located in waters closed to shrimping with mobile gears. DMF and the Coastal Federation have collaborated to begin construction of oyster sanctuaries in Stump Sound.

The typical management cycle for these waters is; the IWW north of Marker #17, the IWW south of the Surf City swing bridge and Banks Channel in Topsail Sound remain open during the entire year unless unusually high rainfall amounts or overcrowded nursery areas force large numbers of small shrimp into them prematurely. Waters in the SSNA, with the exception of the middle portion of the SSNA, are typically opened sometime after August 15. The middle portion of the SSNA from Marker #45 to the Highway 210-50 high-rise bridge usually remains closed until late in the season because of the abundance of small white shrimp.

The fishing is dominated by small boats that trawl, float net and skim in the main channel of the IWW and in a 100-foot strip on the side of the IWW that is open from Marker #49 to Marker #105. Channel nets are set outside of the marked channel from Marker #15 at New River to just south of the Surf City Bridge and in Topsail Sound. Banks Channel serves as a migration route for emigrating shrimp; gears used include trawls, skimmers and most recently shrimp traps and shrimp pounds.

11.3.1.5 New River

The DMF manages the New River based on nursery area classification (Figure 11.4). The waters upstream of the Highway 172 Bridge were designated by rule as a SSNA in 1996. The areas of the SSNA that are impacted by the opening include the river above the bridge up to the marked closure line running from Grey's Point to the opposite side of the river. Trawling in any of the tributary creeks is prohibited. The river consists mostly of shallow bays with the exception of the marked navigation channel. Bottom types range from sand and sand/mud to live shell bottom. The DMF actively manages seven SMAs in this portion of New River.

The use of otter trawls upstream of the Highway 172 Bridge was phased out in 2010 following the adoption of the 2006 Shrimp FMP. Those who wished to continue to harvest shrimp in the waters above the 172 Bridge were allowed a four year grace period to convert to skimmers.

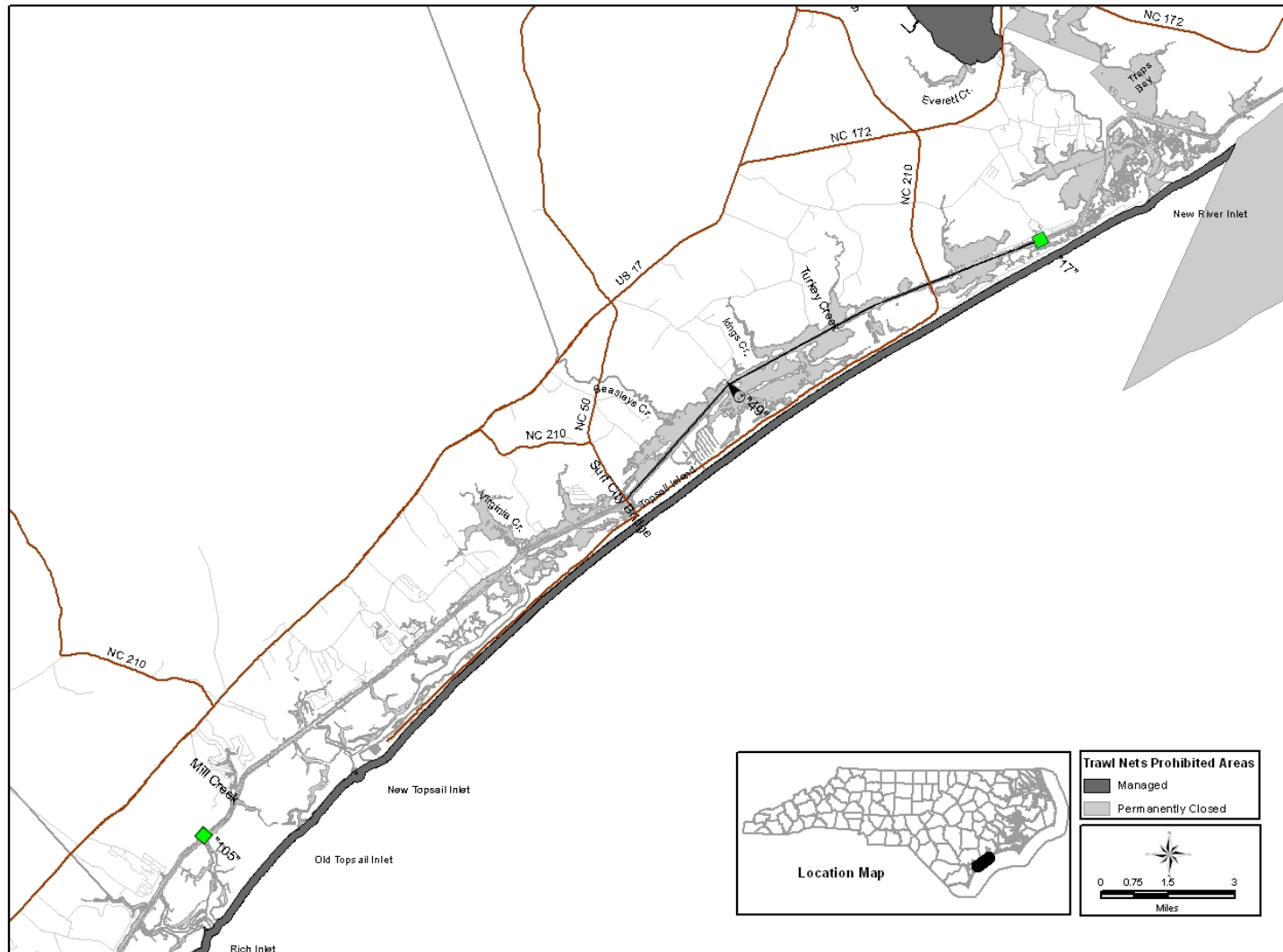


Figure 11.4 Map of shrimp management areas in the Intracoastal Waterway and sounds from Rich's Inlet to New River.

Subsequently, crab trawls were also phased out of this area as part of the 2006 Shrimp FMP. Prior to the 2006 Shrimp FMP, crab trawlers would often fish above the Highway 172 Bridge to target flounder more so than crab; however, stricter minimum size limits for flounder made it economically unfeasible for crab trawlers to harvest only crabs in this area. Currently, the waters upstream of the Highway 172 Bridge are only open to boats equipped with skimmer rigs. During the revision of this plan, it was requested by several crab trawlers to reconsider allowing trawlers to fish above the Highway 172 Bridge; however this management strategy will remain in place (see appendix 1).

The DMF typically issues a proclamation opening the waters above the Highway 172 Bridge around the middle portion of August. Once a proclamation has been issued, these waters remain open until May 14th. Initial sampling of core and optional stations in the recruitment or nursery areas starts in August and is completed prior to August 16th. The waters below the 172 Bridge are open to trawling year round; however, over the past few years there has been very little effort in this part of the river.

11.3.1.6 Chadwick Bay

Chadwick Bay is a small high salinity waterbody encompassing 841 acres located just south of the mouth of New River and adjacent to the IWW and the New River Inlet (Figure 11.4). The southern portion of the bay is classified as a Primary Nursery Area (PNA) characterized by shallow water depth (< 5 feet) and a sandy mud substrate with patches of SAV. Fullard Creek is the major tributary of Chadwick Bay and minor tributaries include Charles Creek and Bumps Creek. The upper portion of Fullard and all of Charles Creek and Bumps Creek are designated by DMF as PNAs. Although the lower portion of Fullard Creek is not currently classified as a nursery area, it is not opened to shrimping because of the abundance of juvenile finfish. Prior to April 1, 2011 the remainder of Chadwick Bay was opened by proclamation to shrimping when the shrimp reached a harvestable size (30-40 heads-on count).

In the past the DMF utilized two different strategies in managing Chadwick Bay. In years when brown shrimp were abundant and large, the bay was opened in July along with the White Oak River, Queen's Creek and Bear Creek. In other years when brown shrimp were less abundant, a Chadwick Bay shrimp opening on white shrimp may have occurred in August or September in conjunction with the openings in New River and/or Stump Sound. However, the 2006 Shrimp FMP requested that a trawl survey be initiated to determine if Chadwick Bay functioned as a SSNA. Based on the species diversity, habitat, and size of shrimps, crabs, and fishes caught in the bay during the survey, Chadwick Bay was found to function as a SSNA. Under its new classification, trawling is permitted by proclamation from August 16th to May 14th. By managing Chadwick Bay as a SSNA, the harvest of juvenile shrimp, finfish, and crustaceans in areas where they spend a major portion of their initial growing season will be reduced by eliminating any openings before August 16th. This management strategy allows for larger, more valuable shrimp to be harvested before they move out into open waters. Additionally, the potential negative effects of trawling on the shallow soft bottom habitat and SAVs of the bay is reduced by decreasing the time when trawling is permitted.

The Chadwick Bay shrimp fishery is primarily conducted with trawls, although, in recent years, the use of skimmers has increased in the commercial portion of the fishery. RCGL holders frequently shrimp in the bay, especially on opening days.

11.3.2 Shrimp Management in the Central District

Management of shrimping in the Central District takes place from the White Oak River on the Onslow/Carteret County line to Core Sound in Carteret County. The Central District also manages the south side of the Neuse River in Craven County. Areas that are open and closed to shrimping through proclamation include: the, West Bay/Long Bay, Thorofare Bay, several tributaries in Core Sound and Adams Creek, located on the south side of the Neuse River.

The DMF issues a proclamation during the first week of June showing shrimp lines for the beginning of the season. This proclamation establishes closures in, Jarrett Bay and the West Bay-Long Bay and Thorofare Bay areas. This proclamation also designates closures of the SSNAs located in Core Sound. The DMF conducts nighttime sampling in both the closed portion and the open portion of a waterbody with a small 20-foot otter trawl with ½ inch bar mesh in the body and ¼ inch bar mesh in the tailbag. Tow times are between 5 minutes and 20 minutes. Shrimp are counted and a subset of the sample is measured to determine sizes or counts. Salinities and water temperatures are also recorded. Target counts vary dependent on the waterbody and range from 26-30 count to 31-35 count (heads-on). In an area like the White Oak River, where shrimp do not grow very large, the count is around 45-55. Based on this sampling, lines may be moved by proclamation to protect small shrimp until they are large enough to harvest.

11.3.2.1 White Oak River

White Oak River is located on the Onslow/Carteret County line and has the town of Swansboro at its mouth (Figure 11.5). Due to the presence of oyster rocks and shoals, there are only a few places that are able to be trawled in the river. They are Hills Bay below Jones Island, the mouth of Pettiford Creek, the Turnstake, and Cahoon's Slough above Jones Island. Recreational shrimpers as well as a few commercial shrimpers use the White Oak River.

Before the 2006 Shrimp FMP, the river was closed at the Highway 24 Bridge with the issuance of the first shrimp proclamation in early June. Sampling for opening White Oak River generally began around the end of June because of the tendency for shrimp to migrate early. Historically, the DMF opened White Oak between July 10 and July 20 to the Gator Gap where the river widens near Bluff Point. Small shrimp were often forced across that line and the DMF tried alternative line locations with varying success that allow for shrimping in the lower portion of the river while protecting small brown and white shrimp upstream. Adjusting the line was difficult due to the amount of oyster rocks in the river. Shrimpers like to tow on the line, therefore placement of the line over oyster rock lead to habitat destruction of those rocks.

Issues that had to be considered in the previous management of this river besides shrimp size were weather conditions and lunar stage. Early northerly winds with a lot of rain or a hurricane can force the small shrimp to migrate before the normal opening dates. A full or new moon on top of that may also cause the DMF to open on a smaller count so they can be caught.

When the bridge was the closure line, there was no shrimp trawling allowed in White Oak River. If the shrimp move out before the river was opened, then the only fishermen who benefited were a few channel net fishermen and maybe ocean trawlers. Over the years options were considered to leave the river closed at all times to protect the oyster rocks, but that was inconsistent with permitting mechanical clam harvest up to the Turnstake and did not allow trawlers to catch the shrimp at all. Therefore a permanent line was established after the

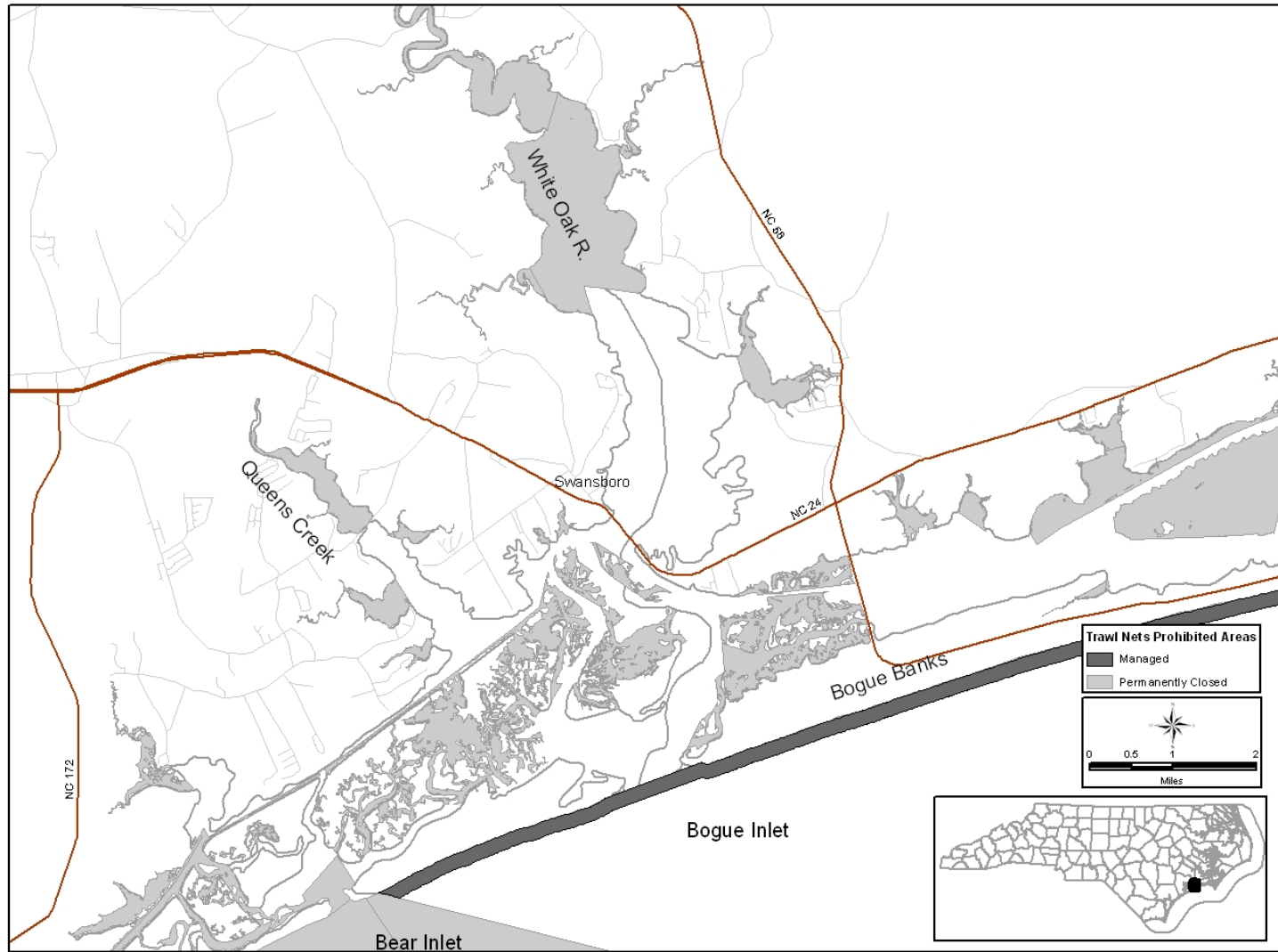


Figure 11.5 Shrimp management areas in the White Oak River and Bogue Sound.

adoption of the 2006 Shrimp FMP in the area of Cahoon Slough to Hancock Point..

11.3.2.2 Bogue Sound

Bogue Sound for the most part has permanent closure lines (Figure 11.5). The sound is closed to trawling on the north or mainland side of the IWW and in a portion of the western part of the sound. These areas remain closed because of the nature of the bottom. The area along the northern side of the IWW acts as a nursery area and also borders several primary nursery areas. SAVs with bay scallops are located in the closed portion of the western part of Bogue Sound. This SAV area was examined in 2008 for changes in SAV habitat per the 2007 Bay Scallop FMP. Minor changes to this line will be incorporated into the shrimp proclamation that is issued during the first week in June beginning in 2012. There have been requests made to open the western side of the IWW, particularly around Broad Creek. These requests usually come from skimmer trawl fishermen who have problems fishing in the waterway. The DMF has not opened this area because it functions as a nursery area for shrimp and other species.

11.3.2.3 Newport River

The Newport River is a relatively small estuary of about 63 square miles located north of Morehead City in Carteret County (Figure 11.6). Average depth is less than three feet with a maximum depth in natural channels of six feet and 40 feet in the dredged channels near the State Port. The western portion of the Newport River has bottoms composed of silts, clays and oyster rocks and the eastern part is composed of a firm sand bottom. There is a PNA and a SSNA located in the western portion as well.

Before the 2006 FMP, the Newport River had a long history of disagreements concerning the best location of a shrimping closure line. Lines used in the past were the Hardesty Farm line, the White Rock line (SSNA line) and the Turtle Rock line (PNA line). During this long period of conflict that peaked in the mid-1980s, the line would move several times during a season in response to requests by fishermen and the variation in shrimp size. By October of each year the river would open to the PNA line with the opening of the SSNA by proclamation. Shrimp harvest generally begins in June with the presence of brown shrimp and can continue into November and sometimes as late as December if white shrimp are abundant. The primary conflict had historically occurred in the fall, between two groups of fishermen. One group wanted the Hardesty Farm line established because shrimp that have migrated downstream to that line are a more marketable size and that line provided more towing room for their larger vessels. The other group of fishermen with smaller vessels preferred the White Rock line (SSNA) in order to access the shrimp before they moved down to the Hardesty Farm line. The White Rock line is located in shallow water, where the larger boats are unable to work because only a small portion of the White Rock line is deep enough for trawling.

Juvenile spot, croaker, brown shrimp, blue crab and southern flounder utilize the PNA and SSNA habitats in Newport River. Shellfish leases, DMF cultch plantings and natural oyster rock are also located in the SSNA. Through the 2006 Shrimp FMP, the Hardesty Farm line became a permanent line by rule; therefore protecting leases, cultch plantings and other oyster resources from being trawled over or covered in sediment. However with the implementation of the Hardesty farm line, the Fisheries Director no longer has the authority to open the Newport River SSNA.

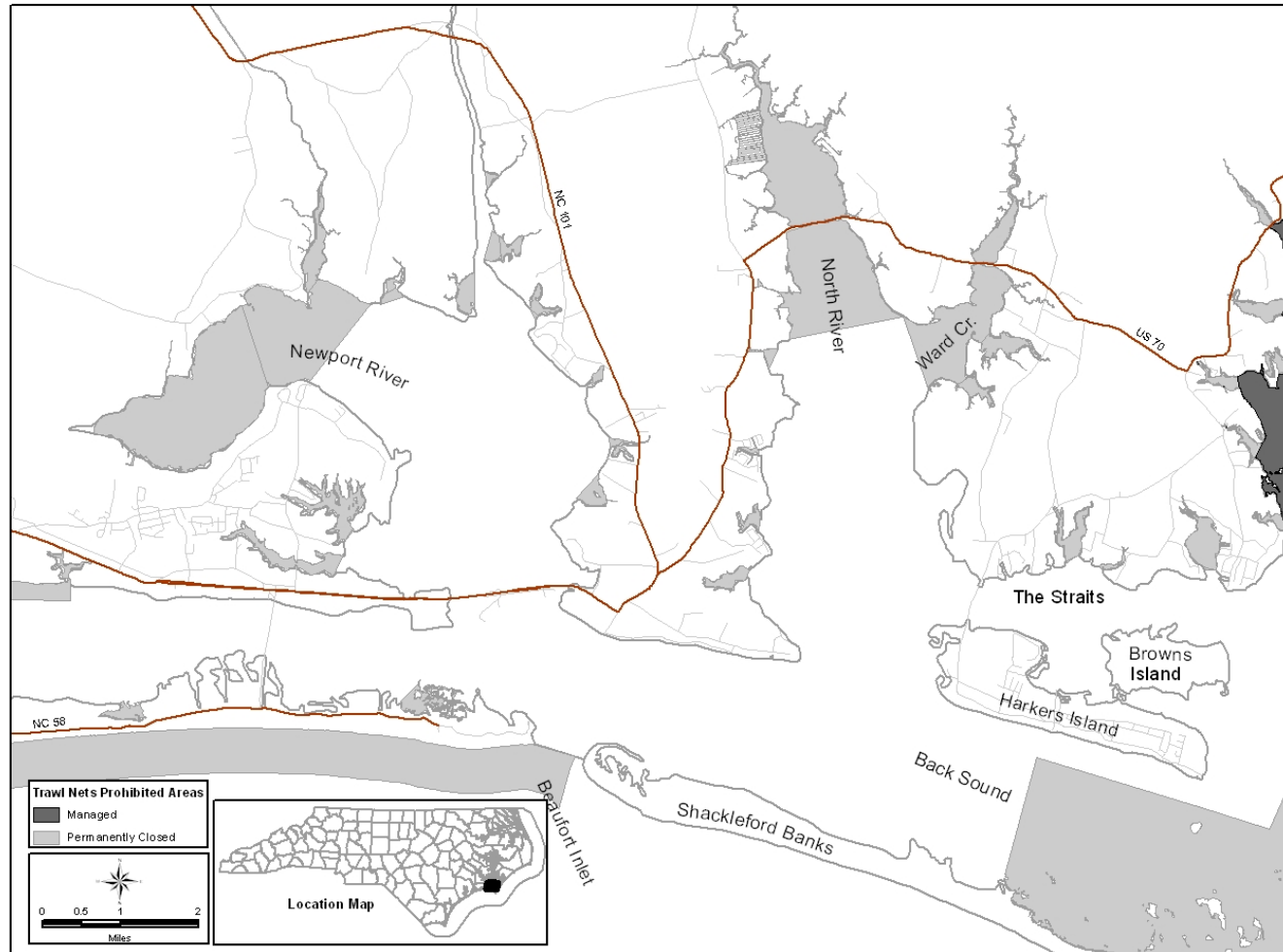


Figure 11.6 Map of the shrimp management areas in the Newport River, North River, Ward Creek, The Straits, and Back Sound.

The implementation of the line has been successful because it protects oyster habitats, leases and cultch plantings as well as small shrimp that move out of Harlowe Creek in the early summer and provides a buffer when the abundance of juvenile shrimp, heavy rainfall or strong northerly winds pushes the shrimp downstream of their normal location. During the revision of this plan, it was requested by several fishermen to reconsider management of Newport River shrimping lines; however this management strategy will remain in place (see appendix 1).

11.3.2.4 North River

North River also has a long and interesting shrimp line history. This river was managed with two lines for years. These were the Long Point line and the Oyster House line. Both lines were established to protect small brown shrimp in the early summer (Long Point line) and small white shrimp in the fall (Oyster House line). The point of contention with these lines was when to open to the Oyster House line. Concerns with opening the area too late included the shrimp moving on a northeast wind as well as on rain and/or full or new moon. In June of 1997 a public meeting was held to discuss permanent lines in North River. It was agreed to move the Wards Creek line downstream to the mouth of the creek and move the Long Point line upstream to the next point north (Figure 11.6). These lines offered deeper water, more shelter to work in a northeast wind and provided an adequate buffer for both brown and white shrimp. The locations of these lines do allow for small brown shrimp to be caught at the beginning of the season. The old line at Long Point has been used a couple of times since the implementation of the permanent line concept because of pressure to close by fishermen because of the small brown shrimp in the area. However once the proclamation was issued, there was pressure from fishermen to honor the new permanent line. Currently, the DMF continues to keep this line as a permanent closure line unless unusual conditions such as in 2003 where high amounts of rainfall displaced small shrimp into open areas causing the DMF to close all of North River as well as the Straits. Opening dates are determined by shrimp size based on DMF sampling.

11.3.2.5 Jarrett Bay

The DMF also manages Jarrett Bay under different strategies. Since 2001, Jarrett Bay is closed to the range markers in early June by proclamation and is opened to the chimney line in July. This is to protect small shrimp in the bay until they are big enough for harvest. In the past, the DMF has opened Jarrett Bay to the chimney line in June because of pressure from fishermen out of the Marshallberg area. These fishermen say this line is easier to tow and they can keep the shrimp from moving out of the bay. Only half of the range marker line can be towed and there is more algae outside of the bay creating a lot of fouling of nets. Jarrett Bay also has a special secondary nursery area that allows it to be opened to the bridge after August 15.

11.3.2.6 Core Sound

The banks side of Core Sound from Wainwright Island to a portion of Back Sound is a shallow sand bottom area with SAV and SAV habitat was protected from shrimp trawling and mechanical clam harvest by a mix of proclamations and rule. The implementation of the 2006 Shrimp FMP placed the entire banks side of Core Sound and the eastern portion of Back Sound into rule (Figure 11.7).

The tributaries of Core Sound on the mainland side are designated as SSNA. They include Jarrett Bay, Brett Bay, Nelson Bay, Thorofare Bay-Barry Bay and Cedar Island Bay. In the

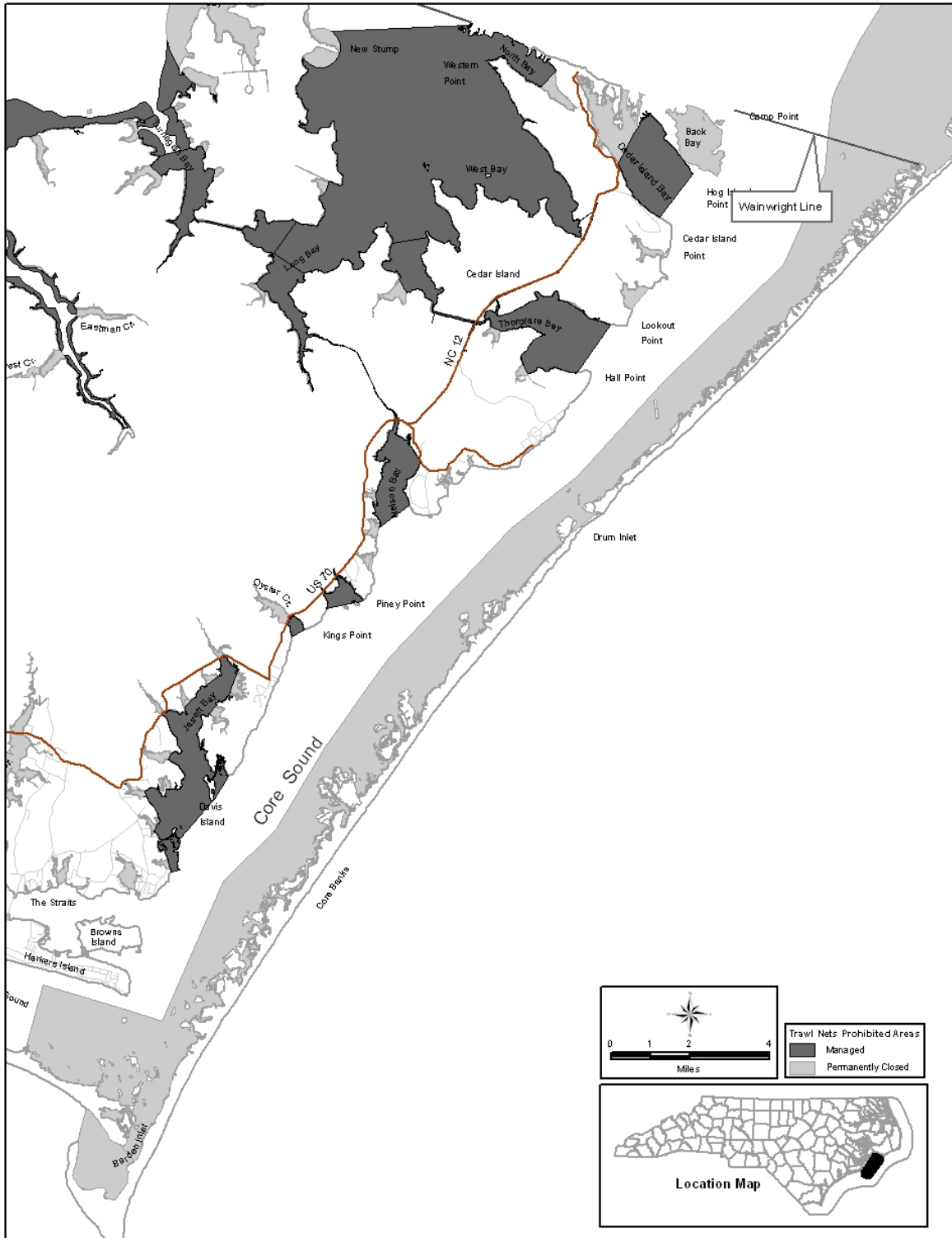


Figure 11.7 Map of shrimp management areas in Core Sound and its surround estuaries.

northwestern portion of Core Sound, bordering parts of the southern portion of the Pamlico Sound, Thorofare Bay, Long Bay-Ditch Bay and Turnagain Bay are also designated as SSNA. Prior to August 1, 2004 these SSNAs would be opened to trawling no earlier than October 15th because they were also trawl prohibited areas and coordinated whenever possible with the opening of the Newport River to diffuse effort. A rule change removing these areas from the Trawl Nets Prohibited Rule now allow these areas to be opened between August 16th and May 14th when shrimp reach a harvestable size and fish abundance is at relatively lower levels.

11.3.3 Shrimp Management in Pamlico District

Typically, as with the Central District, the annual shrimp management process begins when the DMF issues a proclamation during the first week of June that shows the location of shrimp closures lines that the season begins with. As sampling dictates, lines may be moved downstream by proclamation to protect small shrimp until they are large enough to harvest. The DMF uses a small 20 foot otter trawl with 3/4 inch mesh in the body and 1/4 inch mesh in the tailbag. This small trawl is used to determine the size structure of all the shrimp and fish in the waterbody, so that the impacts will be known. The target count size is in the neighborhood of 26-30 count or 31-35 count (heads-on). When sampling indicates that the majority of the shrimp in a closed area have reached this target size, the area is opened by proclamation.

In years when shrimp occur in great numbers, they compete for space and food and spill out into the open trawl areas because the closed nursery areas cannot contain them. Also, heavy rainfall and strong northerly winds during the month of June will cause the shrimp to move out of the closed areas seeking higher salinity. The DMF's response to finding the small shrimp in these open trawling areas has been to close them by proclamation to protect the shrimp until they reach harvestable size. This harvestable size has been the source of controversy for over twenty years.

Before implementation of the 2006 Shrimp FMP, the DMF was reluctant to close larger bodies of water like Neuse and Bay rivers or migration routes like Adams Creek. Occasionally, shrimp will be driven out of the creeks from Oriental to the mouth of the Neuse River, and from the tributaries of Bay River. When shrimp size dictated that these areas, particularly Neuse River, be closed, the closure line itself was an issue. Closing the entire river, or placing a line following channel markers running from offshore Oriental to Maw Point was used with mixed success. This enabled the larger boats to run along that line and catch small shrimp to the exclusion of the smaller boats. Smaller recreational boats were not able to work in more open and unsheltered waters and the harvestable shrimp size desired by recreational fishermen before opening is smaller than the size desired by commercial interests. For example, a 41-45 count shrimp may be more suitable to some and they want to see areas opened when that size is achieved.

"Grand openings" were also a problem with area closures. They result in a massive concentration of all types and sizes of boats in a very confined area like Adams Creek or Bay River. This increased finfish bycatch and discards because of the increased effort, increased conflict between vessels, and decreased the amount of shrimp available after the opening as opposed to a gradual migration out of a closed area over time when the shrimp themselves are ready to run. Opening times were sometimes at issue. A Sunday evening opening is convenient for Marine Patrol as far as marking the area. More odd times such as Monday at noon tended to diffuse the number of boats present at once for a "grand opening" as they gradually show up to fish that night.

An issue with the dynamic nature of the opening and closing of intensively managed areas was keeping the public informed. Immediately after an area was closed, calls by fishermen would begin, asking when the area would re-open. Proclamations require 48 hours notice and fishermen need more time than that to plan their activities.

11.3.3.1 Neuse River

The Neuse River is one of the state's larger rivers and separates Pamlico County to the north from Craven and Carteret counties to the south (Figure 11.8). The river is one mile wide at New Bern and five miles wide near its mouth, with depths ranging from 12 to 23 feet. Although shrimp and crab trawling are technically permitted from New Bern downstream to the Pamlico Sound (except when closed due to small shrimp size), shrimp are only found as far upstream as Slocum Creek. The majority of the Neuse tributaries are designated primary, secondary, or special secondary nursery areas. Shrimp generally grow in these nursery areas during the early spring and begin migrating out of them and into the river proper in July. Once in the river, they migrate around Cedar Island into Core Sound, or down Adams and Clubfoot creeks toward Beaufort Inlet to the ocean.

Before implementation of the 2006 Shrimp FMP, the management of the Neuse River had included opening the river in early June and leaving Adams Creek and West Bay opened. At that time, the river was opened to shrimp and crab trawling up to the joint-coastal line adjacent to New Bern and could be closed by proclamation due to the presence of small shrimp. In years when shrimp were scarce or of average abundance, the closure lines remained the same. When there were great numbers of juvenile shrimp in the tributaries or heavy rainfall in the critical weeks prior to reaching harvestable size, causing early movement, closures were implemented to protect the small shrimp until they reached harvestable size.

South River is currently left opened to trawling. It rarely contains shrimp, but is trawled regularly during the summer months for crabs. Most of Turnagain Bay is a SSNA, which opens with the other SSNAs in mid-October.

The line that protected small shrimp on the north side of the river ran along the channel markers from Dawson Creek to the mouth of Neuse River. This line was first used in 1999 and again in 2000 when overcrowding, weather, or both forced small shrimp out of the Oriental area creeks and complaints began about catching small shrimp. The line along the channel markers was difficult to enforce and often the same size shrimp were found on the open side of the line as in the closed area. Once closed, either at the channel markers or at the river's mouth, there was always a considerable difference of opinion among the public as to the appropriate opening size, with larger commercial boats wanting a larger count and RCGL fishermen being satisfied with 40 or 50 (heads-on) count. Based on DMF sampling, the river would open on approximately 30-35 count shrimp in mid-July. When the river, creeks and bays are opened, even though there is a conscious effort to open as many areas as possible together to distribute the fishermen, there is always the grand opening aspect to contend with. For example, as many as 200 boats have been present for past opening days in Adams Creek.

Several changes in the 2004 Blue Crab FMP update, effective September 1, 2005, had indirect benefits to the Neuse River shrimp fishery. The change in designated crab pot areas in most areas of the Neuse River from a distance offshore to the six-foot depth contour and prohibiting trawling within that contour from June through November greatly decreased shrimp trawling effort in the river, particularly by the smaller commercial vessels and the RCGL fishermen. The

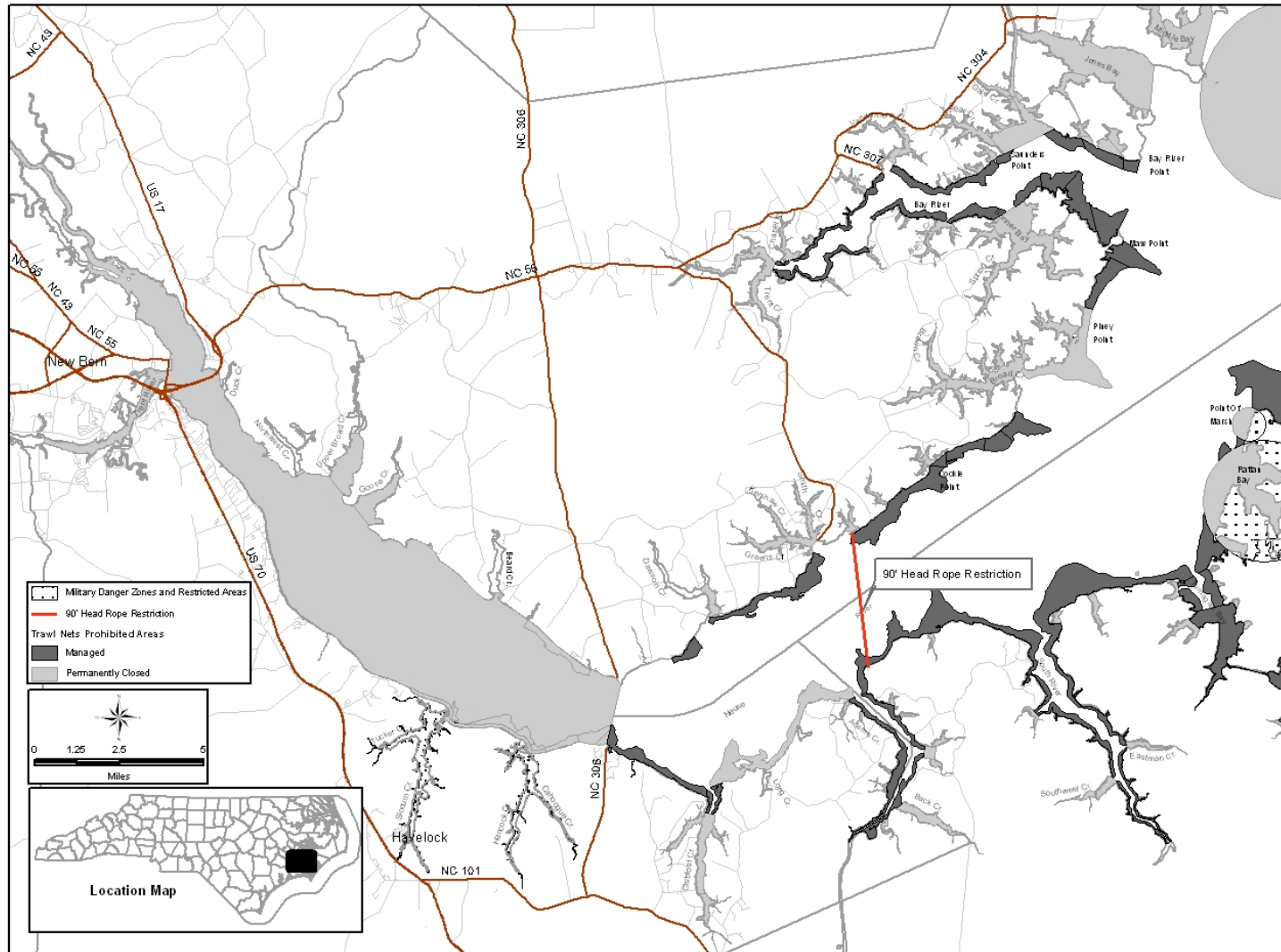


Figure 11.8 Map of the shrimp management areas in The Neuse River and its tributaries.

plan also set a minimum mesh size, four inch stretched mesh, for crab trawls in the western half of the Pamlico Sound and its tributaries, including Neuse River.

Management strategies in the Neuse were further modified in the 2006 Shrimp FMP restricting total headrope lengths to 90 feet upstream of the northeast line from Winthrop Point on the eastern shore of Adams Creek to Windmill Point at the entrance of Greens Creek at Oriental, effective July 1, 2006. The 2006 Shrimp FMP also established a no trawling line from Wilkinson Point to Cherry Point at the entrance of Pierce Creek. These management strategies were established to minimize juvenile southern flounder bycatch while still achieving the overall goal and objectives of the 2006 Shrimp FMP.

11.3.3.2 South Side of Neuse River

South River, Adams Creek and the outer portion of Clubfoot Creek typically stay open unless all of Neuse River closed (Figure 11.8). Adams Creek and Clubfoot are popular areas for the recreational shrimper to fish because they are small waterbodies with protection from bad weather. South River typically has very few shrimp but is a popular crab trawl area. The DMF tries not to close these areas because of concerns of grand openings. These result in a large number of small and large boats in a small waterbody. This concentration of effort on opening day increases finfish bycatch and discards, vessel conflict and decreases the amount of shrimp available after the opening.

11.3.3.3 Bay River

Bay River is a tributary of Pamlico Sound, located in Pamlico County, between the Pamlico and Neuse rivers (Figure 11.8). Trawling (shrimp and crab) is only allowed in the main stem of the river. All feeder creeks and bays are classified as either Nursery Areas (Primary or Secondary) or no trawl areas. A majority of the shrimp landed from Bay River are caught by shrimp trawls by vessels less than 40 feet in length, with a small percentage of the landings reported from skimmer trawls and channel nets. Other commercial fisheries in Bay River include crab pot, crab trawl, gill net, oyster, and long-haul.

Historically, Bay River may or may not have closed to protect small shrimp. Most closures typically occurred in mid to late June with openings in mid-July. However, following the adoption of the 2006 Shrimp FMP, actions were taken to modify openings and closures based on count size (31-35 count) and abundance. Actions were also taken in the 2006 Shrimp FMP restricting total headrope lengths to 90 feet upstream of the closure line. These management strategies were put in place to further minimize juvenile southern flounder bycatch while still achieving the overall goal and objectives of this FMP.

11.3.3.4 Pamlico River

The Pamlico River is a tributary of Pamlico Sound (Figure 11.9). Prior to the 2006 Shrimp FMP, trawling (shrimp and crab) was allowed in the main stem of the river. All feeder creeks and bays are classified as either Nursery Areas (Primary, Secondary, Special Secondary) or Inland waters all of which are closed to trawling. Overall this system is approximately 82,705 acres in size of which 76,516 acres (93%) are under DMF jurisdiction. The majority of the Pamlico tributaries are classified as Primary Nursery areas, Secondary Nursery areas, Special Secondary Nursery areas, or no trawl areas. Restrictions were put in place following the

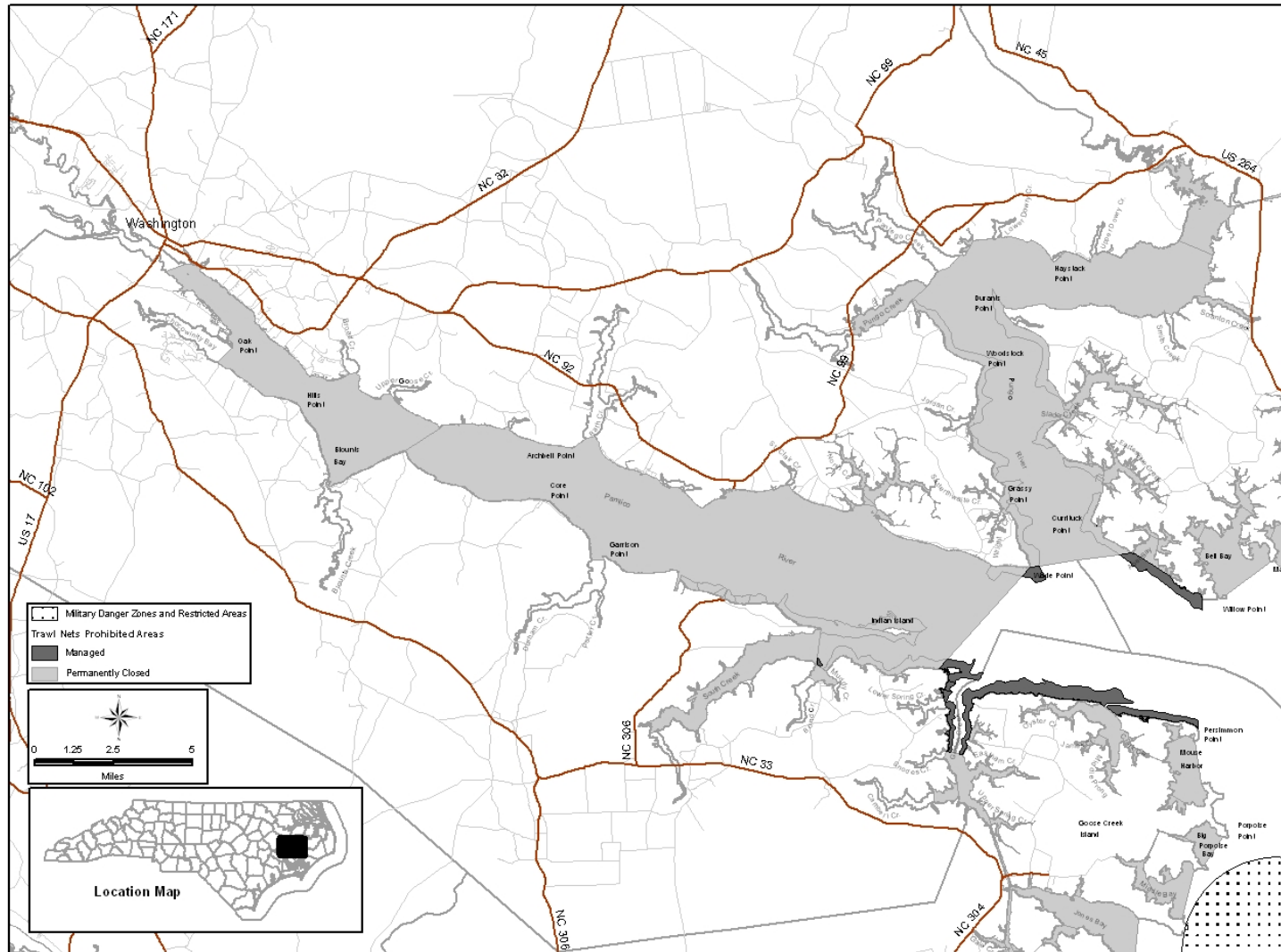


Figure 11.9 Map of shrimp management areas in the Pamlico and Pungo Rivers.

adoption of the 2006 Shrimp FMP making it unlawful to take shrimp with trawls with a combined head rope greater than 90 feet in the waters upstream of a line between Pamlico Point and Willow Point. Further actions were taken to close the waters to trawling upstream of a line between Wades Point and Goose Creek. These management strategies were also established to minimize juvenile southern flounder bycatch while still achieving the overall goal and objectives of the 2006 Shrimp FMP. Shrimp openings typically occur in June and may or may not close due to the presence of small shrimp. Over the last 16 years the Pamlico River has not been closed to shrimp trawling. Other commercial fisheries in the Pamlico River include crab pot, crab trawl, gill net, eel potting, pound netting, and long-haul.

11.3.3.5 Pungo River

The Pungo River is a tributary of Pamlico Sound (Figure 11.9). Overall, the Pungo River is approximately 32,741 acres in size. Before the implementation of the 2006 Shrimp FMP, trawling (shrimp and crab) was allowed in the main stem of the river. All feeder creeks are classified as either Nursery Areas (Primary, Secondary, Special Secondary) or Inland waters all of which are closed to trawling. Historically, the main stem of the river would open to trawling in June. However, with the adoption of the 2006 Shrimp FMP, actions were taken prohibiting the use of shrimp trawls upstream of a line from Wades Point to Abels Bay. Other commercial fisheries in the Pungo River include crab pot, crab trawl, gill net, eel potting, pound netting, and long-haul.

11.3.3.6 Pamlico Sound

Pamlico Sound system extends from Oregon Inlet south to Core Sound (Figure 11.10). Salinity varies from 25- 30 ppt near the three inlets to near zero in the upper tributaries. Two large river systems (Neuse and Tar-Pamlico) provide the major fresh water inputs. The average depth of the sound is 16 ft. Numerous small creeks and bays surround Pamlico Sound. The Sound is divided into two basins east and west of Bluff Shoal. Extensive low salinity *Juncus* marshes border the sound and many of the tributary bays and creeks. Significant SAV beds occur in the sound, with high salinity species (e.g., eel grass) along the shoals behind the Outer Banks in the east and low salinity species (e.g., widgeon grass, wild celery) along some of the western shores. There are diurnal tides of two to three feet near the three inlets, but virtually no lunar tides away from the inlet areas. However, wind tides exceeding two feet regularly occur during storms.

Trawling (shrimp and crab) is only allowed in the main portion of the sound. All feeder creeks and bays are classified as either Nursery Areas (Primary, Secondary) or no trawl areas all of which are closed to trawling. The Pamlico Sound has the potential to close and open when shrimp are of sufficient size. Over the last 16 years portions of western Pamlico Sound have been closed six times to shrimp trawling. Other commercial fisheries in Pamlico Sound include crab pot, crab trawl, crab dredging, oyster dredging, clam kicking, gill net, pound netting, and long-haul.

11.3.3 Shrimp Management in the Northern District

Species specific shrimp sampling programs do not exist in the Northern District since shrimp management is only necessary during banner shrimp years and since ongoing shrimp data are available within the DMF juvenile trawl program data base (Program 120). An exception is data

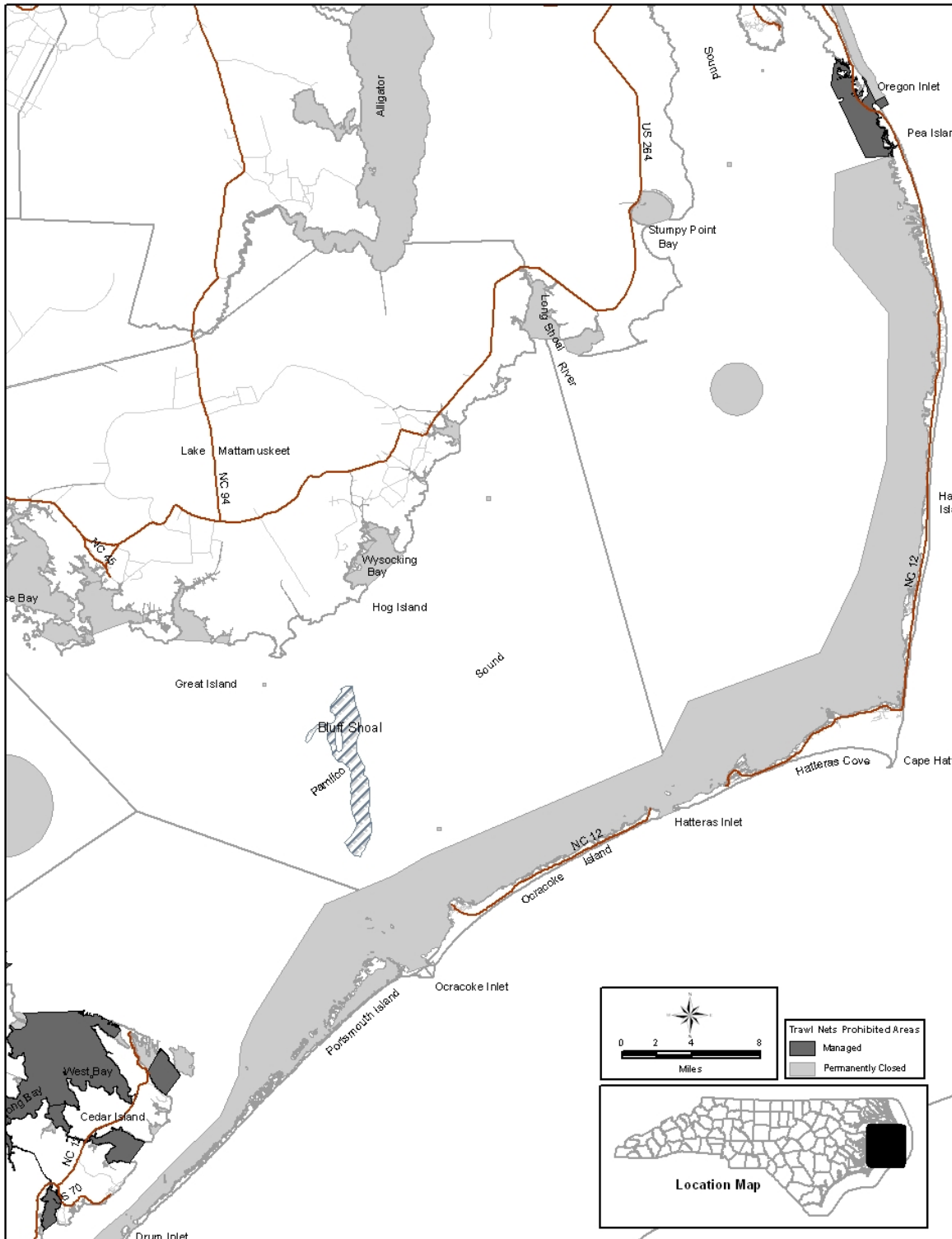


Figure 11.10 Map of shrimp management areas in the Pamlico Sound and its tributaries.

collected in Stumpy Point Bay. Juvenile brown shrimp stations within Stumpy Point Bay were sampled by the Pamlico District staff from 1975-1986. In order to maintain this historical data

base, the Manteo office continues to sample Stumpy Point Bay for juvenile brown shrimp recruitment from 1989-present. Brown shrimp samples are typically taken during the last week of May and the first week of June using a 10.5 ft trawl with 1/4" mesh in the body and 1/8" mesh in the cod end. Thereafter, brown shrimp data are collected in the juvenile trawl survey (Program 120) from which management decisions may be made based on shrimp size and abundance.

The low relative abundance of white and pink shrimp in the northern district requires minimal sampling effort except during times of extreme environmental conditions. In such cases, sampling efforts may be initiated on demand in order to provide the foundation for shrimp management decisions of the Division.

11.3.3.1 Croatan Sound

Croatan Sound is bound by Pamlico Sound to the south, extends along the west side of Roanoke Island, to Albemarle Sound to the North. This system is approximately 26,272 acres in size. Spencers Creek is the only nursery area located in Croatan Sound and is closed to trawling. Additionally, one hundred and thirty five acres are classified as inland areas and are also closed to trawling. The majority of the shrimp trawling in Croatan Sound occurs in deep holes and sloughs. The Croatan Sound has the potential to close and open when shrimp are of sufficient size. Other commercial fisheries in Croatan Sound include crab pot, crab trawl, gill net, and pound netting.

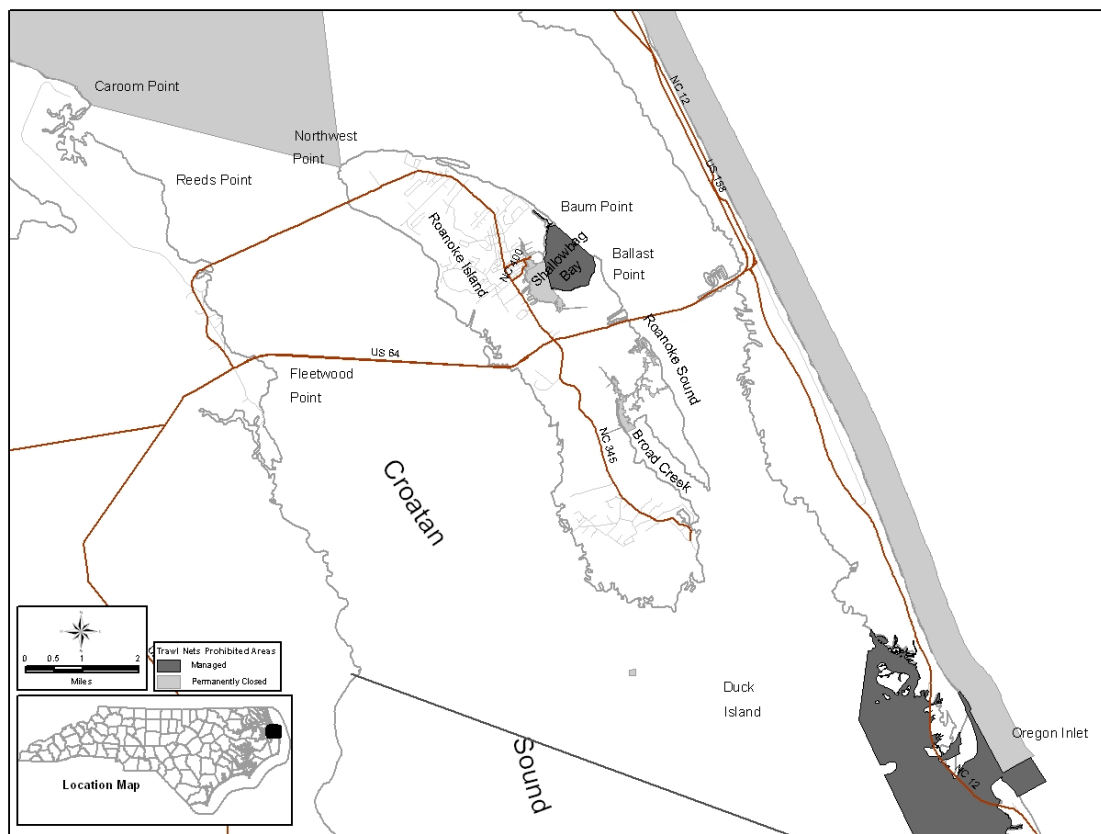


Figure 11.11 Map of shrimp management areas in the Croatan and Roanoke Sounds.

11.3.3.2 Roanoke Sound

The Roanoke Sound system extends from Oregon Inlet north, along the east side of Roanoke Island to Albemarle Sound. This system is approximately 21,168 acres in size. Trawling (shrimp and crab) is only allowed in the main portion of the sound. With the exception of Outer Broad Creek, all feeder creeks and bays are classified as either PNAs, SNAs, SSNAs or no trawl areas. The majority of the shrimp trawling in Roanoke Sound occurs in Roanoke channel, Outer Broad Creek, and the Wanchese Channel. The SSNAs of Outer Shallowbag Bay, and Kitty Hawk Bay-Buzzard Bay, are also popular, when open. The Roanoke Sound has the potential to close and open when shrimp are sufficient size. Other commercial fisheries in Roanoke Sound include crab pot, crab trawl, gill net, pound netting, fyke net and long-haul.

11.3.4 Atlantic Ocean

North Carolina's coastline on the Atlantic Ocean is comprised of barrier islands that stretch approximately 300 miles. Shoals extending perpendicular from shore accompany capes and inlets along North Carolina's coastal ocean. On average, 22% of shrimp landed in North Carolina are harvested from these nearshore (0-3 miles) ocean waters. Near-shore hardbottom areas, dense concentrations of marine algae, artificial reefs and shipwrecks limit the amount of trawlable bottom available to commercial fishers. On average, only 3% of shrimp landed in North Carolina are harvested from offshore (>3 miles) ocean waters.

Since shrimp that migrate from the estuaries are usually large, the DMF does not actively manage the ocean waters. However, in the past and exclusively off the Brunswick county coast, DMF has been requested by the fishermen to take a more active role in the management of the ocean shrimp fishery. These requests were precipitated as result of the heavy hurricane or tropical storm induced rains that have impacted southeastern North Carolina with regularity since the mid-1990s. Fresh water from these heavy rains dramatically reduces salinities in the estuaries causing the shrimp to prematurely migrate from the estuaries into the ocean. When this occurs, DMF generally closes the impacted ocean and estuarine waters to shrimp trawling. During the revision of this plan, it was requested that trawling be allowed within a closed area located off Bogue Banks. This area is closed from Beaufort Inlet to Salter Path, NC and extends one half mile off shore and was put in place due to conflict with beach users and pier users. It was requested that the line be moved to within one quarter mile of shore, however this management strategy will remain in place (see appendix 1).

11.4 SUMMARY OF MANAGEMENT ACTIONS

11.4.1 Rules (new, modifications, or technical changes)

No rule changes required.

11.4.2 Legislative Action (new, modifications, or technical changes)

No legislative action is required.

11.4.3 Actions by Other Agencies

Various sections of state government will need to implement these actions to accomplish the processes outlined below:

1. Support Strategic Habitat Area assessments

2. Remap and monitor SAV in North Carolina to assess change in distribution
3. Assess the distribution, concentration, and threat of heavy metals and other toxic contaminants in freshwater and estuarine sediments and identify the areas of greatest concern to focus water quality improvement efforts
4. Monitor to determine if additional areas should be designated as Primary Nursery Areas due to their nursery importance to shrimp
5. Identify, designate, and protect Strategic Habitat Areas.
6. Expand habitat restoration in accordance with restoration plan goals of coastal wetlands.
7. Protect habitat from trawling and mechanical harvest gear effects through improved enforcement, establishment of protective buffers around habitats, modified rules, and further restriction of fishing gear where necessary.
8. Protect estuarine and public trust shorelines and shallow water habitats by revising shoreline stabilization rules to include consideration of erosion rates and prefer alternatives to vertical shoreline stabilization measures that maintain shallow nursery habitat.
9. Develop an interagency policy for marina siting to minimize impacts to ecologically important shallow habitats such as Primary Nursery Areas, Anadromous Fish Spawning Areas, and SAV.
10. Reduce point source pollution discharges by:
 - a) Increasing inspections of wastewater treatment facilities, collection infrastructure, and disposal sites. Providing incentives for upgrading all types of discharge treatment systems
 - b) Developing standards and treatment methods that minimize the threat of endocrine disrupting chemicals on aquatic life.
11. Improve strategies throughout the river basins to reduce non-point pollution and minimize cumulative losses of fish habitat through voluntary actions, assistance, and incentives, including:
 - a) Improved methods to reduce pollution from construction sites, agriculture, and forestry
 - b) Increased on-site infiltration of storm water
 - c) Encouraging and providing incentives for low-impact development
12. Improve strategies throughout the river basins to reduce non-point pollution and minimize cumulative losses of fish habitat through rule making, including:
 - a) Increased use of effective vegetated buffers
 - b) Implementing and assessing coastal storm water rules and modify if justified
 - c) Modified water quality standards that are adequate to support SAV habitat

13. Reduce non-point source pollution from large-scale animal operations

11.4.4 Management Related Research Needs

High Priority

- Continue to conduct bycatch characterization work across all strata (for example: dominant species, season, areas, vessel type, number of nets/rigs, headrope length).
- Initiate/increase state monitoring and reporting on the extent of unutilized bycatch and fishing mortality on fish less than age-1 in the shrimp trawl fishery.
- Continue to develop and test methods to reduce bycatch in the commercial and recreational shrimp trawl fisheries.
- Obtain mortality (immediate and post-harvest) estimates of culled (active and passive) bycatch from gears used in the recreational and commercial shrimp fisheries.
- Continue to develop standard protocol for bycatch estimations.

Medium Priority

- Conduct research to quantify the number of protected species interactions with the shrimp fishery.
- Continue to develop and test methods to reduce interactions with protected species in the commercial and recreational shrimp trawl fisheries.
- Initiate sampling to investigate if additional areas currently open to shrimping need changes to their habitat designations
- Evaluate the effectiveness and efficiency of the current sampling protocol used to manage shrimp.

Low Priority

- Continue to support research to determine the status of protected species along the NC coast to better anticipate and prevent interactions (for example: migration patterns and habitat utilization).

11.4.5 Biological Research Needs

High Priority

- Continue to define and quantify the intensity, duration and spatial scale of trawling effort in NC estuaries.
- Determine species interactions and predator/prey relationships for prominent shrimp trawl bycatch.

- Determine how the resuspension of sediment, siltation, and non-point source pollution from adjacent land use practices impacts trends in shrimp abundance and habitat degradation.
- Determine the spatial and biological characteristics of submerged aquatic vegetation that maximize their ecological value to shrimp for restoration and conservation purposes.

Medium Priority

- Continue to map and quantify the habitat structure and sediment types in North Carolina estuaries.
- Continue to measure the effects of trawling on sediment size distribution and organic carbon content.

Low Priority

- Continue to investigate the impact of tiger shrimp in NC waters.
- Initiate research to determine the impacts of endocrine disrupting chemicals (EDCs) on the various life stages of shrimp.

11.4.6 Social and Economic Research Needs

Medium Priority

- Expand current social and economic surveys to specifically collect information on shrimp fishermen.
- Continue to determine the extent of recreational shrimp harvest that is occurring. This group primarily use cast nets to take shrimp either for bait or personal consumption.

11.4.7 Data Needs

High Priority

- Effort data needs to be collected to provide estimates based on actual time fished (or number of tows), rather than number of trips.
- Improve accuracy of self-reported license gear survey data, or investigate other means of accurately obtaining shrimp fleet characteristic.

11.4.8 Education

High Priority

- Encourage research and education to improve the understanding of new innovative BRDs and TEDs.
- Encourage research and education to improve the understanding and management of the shrimp resource as well as the fishery.

12.0 BYCATCH IN THE SHRIMP FISHERY AND MANAGEMENT OPTIONS

The DMF, at the direction of the MFC, presented the 2012 Shrimp FMP revision to the MFC Southern Regional AC, the MFC Northern Regional AC, the MFC Habitat and Water Quality AC and the MFC Shellfish/Crustacean AC and also took public comment at each of these committees. With the exception of the Southern AC, all of the committees voted to revise the Shrimp FMP. However, due to the overwhelming public comment concerning the issue of bycatch in the shrimp trawl fishery and the acknowledgement that bycatch is an issue in the shrimp fishery; the DMF changed its initial recommendation to the MFC from a revision to move forward with amending the Shrimp FMP. The MFC approved the plan amendment but limited the scope of the amendment to bycatch issues in the commercial and recreational fisheries.

A Shrimp FMP AC was formed in January 2013 and met over a period of eight months to become familiar with the content of the revision text in general and the bycatch issue specifically (see Section 6.3) and to review different bycatch management options. The division proposed a holistic approach to review the numerous options under consideration and directed the AC to assess the different management options through a series of evaluation matrices. Each evaluation matrix listed management options along with an initial list of potential impacts discussed by the Plan Development Team (PDT). Quantifying the potential biological gain to affected bycatch species populations was not possible with existing data; therefore it was important for the AC to consider reasonable and practicable management strategies to reduce bycatch while balancing the economic and social value of the shrimp fishery. The AC was directed to the following two FMP objectives during their deliberations:

- Minimize waste and enhance economic value of the shrimp resource by promoting more effective harvesting practices.
- Minimize harvest of non-target species of finfish, and crustaceans, and protected, threatened, and endangered species

The AC assessed bycatch reduction, economic impacts, social impacts, and inter-fishery impacts for each management option to the shrimp fishery. Enforcement and authority/administration was only assessed by the PDT. These evaluation matrices provided focused deliberations and provided a starting point for thorough and meaningful discussions in determining the best approaches for reducing bycatch in the shrimp trawl fishery. The AC was able to add options and remove options as well as change or rephrase the initial impacts as contemplated for each management option.

Twenty-nine different management options were brought forward to address eight different issues during monthly meetings from May through August 2013. Each of these issue papers follows in this Section 12, including both sets (AC and PDT) of evaluation matrices. The AC voted to remove four of those options from the evaluation process. After all options were evaluated, the members of the AC were sent an option selection package and asked to select what he or she considered to be the five best options to reduce bycatch. This enabled discussion to be focused on the best options and combinations of those options and to discuss the details needed to develop management recommendations. The AC deliberated and recommended actions for the MFC to consider (Section 12.10) to address bycatch in the shrimp fisheries.

The division also assessed management options in a similar manner. The PDT provided assessed matrices to the Management Review Team (MRT) who finalized each matrix for the DMF. Each PDT member also selected what he or she considered to be the best five options to reduce bycatch. The PDT then developed management recommendations which were then

sent to the MRT. The MRT reviewed and modified the PDT recommendations into the DMF recommendations listed in section 12.11.

12.1 TRAWLING IN THE NEW RIVER ABOVE THE HIGHWAY 172 BRIDGE

I. ISSUE

Request to reexamine the provision in the 2006 Shrimp Fishery Management Plan (FMP) which prohibits the use of otter trawls upstream of the Highway 172 Bridge over the New River.

II. ORIGINATION

Request by the Shrimp Advisory Committee (AC)

III. BACKGROUND

The use of otter trawls upstream of the Highway 172 Bridge was phased out in 2010 following the adoption of the 2006 Shrimp FMP. Those who wished to continue to harvest shrimp in the waters above the Highway 172 Bridge were allowed a four year grace period to convert to skimmers. Subsequently, crab trawls were also phased out of this area as part of the 2006 Shrimp FMP. Prior to the 2006 Shrimp FMP, crab trawlers would often fish above the Highway 172 Bridge to target flounder more so than crab; however, stricter minimum size limits for flounder made it economically unfeasible for crab trawlers to harvest only crabs in this area. In 2011, a request was made by the New River shrimp and crab trawlers to reexamine this provision. Following this request an issue paper was written for the 2011 Shrimp FMP revision. The findings of that issue paper revealed that skimmers were more effective at catching the target species than conventional otter trawls, otter trawl bycatch had been significantly reduced while the mean catch per trip (lb) for shrimp remained fairly high for the rest of the river, and the highest mean catch per trip (lb) for crab trawlers occurred in 2010 when trawlers were not allowed access to the New River Special Secondary Nursery Area (SSNA). The Plan Development Team's (PDT) recommendation was to continue to prohibit otter and crab trawlers in the New River SSNA. Currently, the waters upstream of the Highway 172 Bridge are only open to boats equipped with skimmer rigs.

The waters upstream of the Highway 172 Bridge (Figure 12.1) were designated by rule as a Special Secondary Nursery Area (SSNA) in 1996. The areas of the SSNA impacted by trawl openings include the river above the bridge up to the marked closure line running from Grey's Point to the opposite side of the river. Trawling in any of the tributary creeks is prohibited. The river consists mostly of shallow bays with the exception of the marked navigation channel. Bottom types range from sand and sand/mud to live shell bottom. The Division of Marine Fisheries (DMF) actively manages seven Shellfish Management Areas (SMAs) in this portion of New River.

Data from the DMF Trip Ticket Program were used to describe the commercial shrimp fishery in the New River from 1994 to 2011 (Tables 12.1-12.5). Landed bycatch by gear was calculated and ratios (in pounds) of marketable bycatch relative to shrimp catch were also calculated for the four main gears: channel nets, otter trawls, skimmer trawls, and various miscellaneous gears (cast nets, gill nets, etc.). Marketable bycatch from skimmers was consistently lower than with the other gears. Marketable bycatch landings in channel nets were also low, with the exception of 2000-2002 when significant amounts of blue crabs were landed in this fishery. In 2005, trip limits were put in place to restrict harvest of crabs in channel nets in the first Blue Crab FMP [15A NCAC O3J.0106 (h)]. During this three-year period, ratios of pounds of shrimp

per pound of marketable bycatch in the channel nets were 4:1, 2:1, and 3:1 respectively. These bycatch ratios apply only to the portion of bycatch retained and sold.

The number of trips made by the major shrimp gears indicates a decrease in effort for all gears from 1994 to 2011 (Figure 12.2). Prior to the 2006 Shrimp FMP, channel nets were fished in the waters above and below the Highway 172 Bridge. Currently, channel nets are only allowed to be set above the 172 Bridge Channel when the river opens to skimmers by proclamation. Effort has remained low since the 2006 FMP, with only a slight increase in the number of participants (19) and trips (322) occurring in 2010 (Table 12.1). However, overall effort has not increased since the 2010 otter trawl ban. An average of 31 participants made an average of 715 channel net trips prior to the otter trawl ban and an average of 16 participants made 264 trips following the ban. While channel net landings were down as a whole as compared to the average for the years prior to the ban, the mean catch per trip was up 32.9% following the ban on otter trawls (Figure 12.3).

The numbers of otter trawl trips and participants dropped significantly in the New River following the ban of trawls above the Highway 172 Bridge (Table 12.2). Prior to the ban an average of 411 trips was made by 79 participants from 1994 to 2009 and an average of 13 trips was made by eight participants from 2010 to 2011. Overall, there was 97.0% reduction in the number of trips and a 90.5% reduction in the number of participants. Otter trawl landings in the New River dropped 95.3% after the ban (Figure 12.4). Prior to the ban, an average of 58,034 lb of shrimp were landed by otter trawls; following the ban an average of 2,749 lb were landed below the bridge. On average 174 lb of shrimp was landed per trip from 1994 to 2009; however, following the ban the mean catch per trip increased 25.2% to 218 lb per trip during 2010-2011 (Figure 12.3). Sold bycatch was reduced by 96.2%, dropping from 4,231 lb to 161 lb annually.

Much of the skimmer trawl effort in the New River has occurred in the Special Secondary Nursery (SSNA) located above the Highway 172 Bridge. Immediately following the otter trawl ban in 2010 there was a slight increase in the number of skimmer trawl trips and participants; however, these increases were not seen in 2011 (Table 12.3). Prior to the ban an average of 35 participants made 309 skimmer trawl trips annually from 1994 to 2009. Following the otter trawl ban, 13 participants made 214 skimmer trawl trips. Much like the other fisheries, skimmer trawl landings have fluctuated in response to year class strength (Figure 12.4). Prior to the otter trawl ban, skimmer trawl landings averaged 66,331 lb annually. In 2010, during the first year of the ban, skimmers landed 102,032 lb and 18,729 lb in 2011. Despite the fact that skimmer trawl landings did not increase after the otter trawl ban, the mean catch per trip increased by 11.7% (Figure 12.3).

While the number of fishermen using miscellaneous gears such as cast nets, shrimp pounds and gill nets to land shrimp in the New River have been historically low, the number of participants and trips has not increased after the otter trawl ban (Table 12.4). Prior to the ban, an average of 1,660 lb of shrimp were landed annually by seven participants. Following the otter trawl ban the landings dropped substantially (landings confidential) and the mean catch per trip declined 57.7% compared to the years prior to the ban (Figure 12.3).

The number of trips made by crab trawls also indicates a decrease in effort from 1994 to 2011 (Table 12.5). Following the adoption of the 2006 Shrimp FMP, there were no reported trips from 2007 to 2009 (12.5). In 2010, 32 trips were made by nine participants below the 172 bridge, landing 23,383 lb of crab. In 2011, 23 trips were made by five participants landing 5,680 lb of crab. Average landings of crabs following the trawl ban have been reduced by 24.2% (Figure 12.6). Prior to the trawl ban above the Highway 172 Bridge, mean catch per trip ranged from 64 to 725 pounds from 1994 to 2006 (Figure 12.6). In 2010, an average of 731 lb of crab per trip

was landed below the Highway 172 Bridge and an average of 247 lb in 2011. Overall, 489 lb of crab were caught per trip following the ban, well above the 262 lb per trip average observed from 1994 to 2006 when trawls were allowed above the bridge. Following the ban, sold bycatch was reduced by 96.2%.

IV. AUTHORITY

§ 113-134. Rules.

§ 113-182. Regulation of fishing and fisheries

§ 143B-289.2. Marine Fisheries Commission – powers and duties.

V. DISCUSSION

As part of the 2006 Shrimp FMP, otter trawls were prohibited by proclamation upstream of the Highway 172 Bridge in the New River beginning in 2010. Subsequently, this also prohibited the use of crab trawls, eliminating a traditional Sneads Ferry fishery, prompting the remaining members of that fishery to question the prohibition. In response to this query, trip ticket harvest data was used to investigate if the prohibition of all trawls, including crab trawls, above the Highway 172 Bridge was successful. As part of the 2011 Shrimp FMP revision, the PDT recommended that the Division continue to prohibit the use of otter and crab trawls above the Highway 172 Bridge to minimize waste/bycatch and disturbance to the bottom (*status quo*). The area above the Highway 172 Bridge is still designated as a SSNA (Figure 12.1).

For all gears, shrimp landings and effort in the New River were reduced substantially during 2010-2011 (Tables 12.1-12.4). Trip ticket harvest data indicates that following the prohibition of otter trawls in the New River SSNA, average shrimp landings declined for channel nets, otter trawls, skimmer trawls, and miscellaneous gears (cast nets, gill nets, etc.) by 46.9%, 95.3%, 9%, and 95.6%, respectively. The average number of trips declined for these gears by 63.1%, 97.0%, 97.0%, and 89.9%, respectively. Statewide reductions in shrimp landings and effort were also observed for all gears during 2010-2011 (Tables 12.6-12.9). During this time period average statewide otter trawl landings declined 10.2% and effort (trips) declined 57.9%. Trip ticket data also indicated that the average statewide skimmer trawl landings declined by 58.4% and effort (trips) declined by 58.4% as compared to the pre-ban period (1994-2009). Also following the prohibition of otter trawls in the New River SSNA, average crab trawl landing declined in the New River by 24.2% and statewide by 82.6% (Tables 12.5 and 12.10). During the post-ban period effort (trips) declined by 66.6% in the New River crab trawl fishery; statewide the number of trips declined by 88.7%. It is important to note that not all of the reductions in landings and effort in New River are a result of the prohibition of otter and crab trawls above the Highway 172 Bridge. Declines in the average landings (shrimp, crab, sold bycatch) observed following the ban of trawling above the Highway 172 may be more of a result of environmental conditions and year-class strength. Economic hardships, increased supply of imports and rising fuel prices may have also contributed to the observed reductions in effort (participants, trips) and landings.

While landings declined for all gears targeting shrimp in the New River, the mean catch per trip (lb) increased with the exception of miscellaneous gears during 2010-2011 (Tables 12.1-12.4). The mean catch rate (lb/trip) of miscellaneous gear in the New River decreased 57.7% and increased only 3.9 % statewide (12.4 and 12.9). On average, the annual mean catch of shrimp per trip (lb) increased for otter trawls by 25.2% following the proclamation prohibiting their use above the Highway 172 Bridge in the New River. The mean catch rate (lb/trip) of skimmer trawls and channel nets in the New River increased by 11.7% and 32.9%, respectively. Statewide, the mean catch per trip (lb) of skimmer trawls declined by 12.3% and the mean catch

per trip (lb) of channel nets increased by 11.7% (12.6 and 12.8). By reducing otter trawl effort in the New River it appears that additional shrimp, once landed by otter trawls, may now be available to other gears, such as skimmer trawls and channel nets. However, increases in the mean catch per trip (lb) may also be a result of fishermen trying to circumvent rising operating costs by limiting the number of trips made until shrimp are more abundant or at a more marketable size. Since the prohibition of otter and crab trawls in the New River SSNA the mean catch per trip (lb) for crab trawls increased by 86.3% (Table 12.5). Crab trawls operating below the Highway 172 Bridge caught an average of 227 lb more crab per trip than when they were allowed in the SSNA. During this same time period (2010-2011), the statewide mean catch per trip (lb) for crab trawlers only increased 3.2% (Table 12.10). Much like the gains observed in the catch rates of the New River shrimp fishery, increases in the mean catch per trip (lb) of the crab trawlers may be the result of economic and environmental factors.

In addition to increased mean catch rates (lb/trip) for otter and crab trawls, sold bycatch has been reduced in the New River following the closure of the waters above the Highway 172 Bridge. In the years following the closure, sold bycatch from otter trawls decreased 96.2% in the New River (Table 12.2). This is slightly higher than the reductions observed statewide (-84.3%) during that same time period (Table 12.7). Sold bycatch from the New River crab trawl fishery also declined 96.2% following the closure (Table 12.5); markedly higher than 63.1% decline observed statewide (Table 12.10). As with the otter trawl fishery, reductions in the number of trips (-66.6%) and participants (-45.2%) most likely led to the observed reductions in sold bycatch in the New River crab trawl fishery. While overall reductions in bycatch (sold and discarded) cannot be quantified using trip ticket data, the declines in sold bycatch observed in the New River may suggest that overall bycatch has declined as effort has declined as a result of stricter regulations and higher operating cost.

Continuing to prohibit the use of all trawls, including crab trawls, above the Highway 172 Bridge protects the New River SSNA from bottom disturbing activities. Trip ticket data also indicates that since the closure, the mean catch rates (lb/trip) of otter and crab trawls have increased, as well as those of channel nets. Prohibiting otter and crab trawls above the Highway 172 Bridge appears to have been successful at reducing bycatch while maintaining catches of target species; however, additional data over a longer time series is needed to account for the influence of environmental conditions, year-class strength and abundance. Opening the waters to crab and shrimp trawls would only reverse the progress made in the 2006 Shrimp FMP.

VII. EVALUATION MATRICES

Advisory Committee Evaluation Matrix for Re-examination of Trawling in the New River Above the HWY 172 Bridge

Impacted Group	Shrimp Fishery			Other Fisheries	Agency		
Management Option	Bycatch Reduction Impact	Economic Impact	Social Impact	Inter-fishery Impact	Enforceability Impact	Authority/Administrative	Other Impacts
1. <i>Status quo</i>	Limits bycatch in the Special Secondary Nursery Area. Reduces waste/fish kills on opening day. Encourages the use of non-bottom-disturbing gears. +	Will not create shifts in effort to other fisheries +/-	Continues loss of traditional otter trawl fishery in Special Secondary Nursery Area. +/-	Commercial and recreational fishing will continue with no changes in gear use or conflict. Not evaluated	Same level of enforcement. Not evaluated	Continued proclamation authority. No rule change needed. Not evaluated	Benefit to existing Shellfish Management Areas. Not evaluated
2. Allow all trawlers in the New River SSNA	Increases bycatch in the Special Secondary Nursery Area -	Increases harvest on opening day. Possible increase in pay to shrimpers +?	Re-establishes traditional otter trawl fishery in Special Secondary Nursery Area (+). Public will view as a step back in management (-). +/-	May increase conflict between otter and skimmer trawlers, as well as other user groups. Not evaluated	Same level of enforcement. Not evaluated	Implemented by proclamation authority. Not evaluated	No benefit to existing Shellfish Management Areas. Not evaluated
3. Prohibit all trawlers and skimmers in the New River Special Secondary Nursery Areas AC elected to not consider this option	Eliminates all bycatch in the Special Secondary Nursery Area. Eliminates waste/fish kills on opening day. Encourages the use of other gears.	Eliminates traditional Sneads Ferry fisheries in Special Secondary Nursery Area. Loss of income for fishermen and fish houses. Additional income from other gears may be marginal due to limited bottom space and efficiency.	Loss of traditional shrimp fisheries in Special Secondary Nursery Area.	Reduced conflict between recreational and commercial fishermen. Potential to increase the catch of bycatch species in the Special Secondary Nursery Area by other fisheries. Potential to increase competition among channel netters (limited areas in SSNA).	Same level of enforcement	Implemented by proclamation authority. Eliminates sampling associated with opening and closing Special Secondary Nursery Area.	Benefit to existing Shellfish Management Areas.

DMF Evaluation Matrix for Re-examination of Trawling in the New River Above the HWY 172 Bridge

Impacted Group	Shrimp Fishery			Other Fisheries	Agency		
Management Option	Bycatch Reduction Impact	Economic Impact	Social Impact	Inter-fishery Impact	Enforceability Impact	Authority/Administrative	Other Impacts
1. <i>Status quo</i>	Limits bycatch in the SSNA. Reduces waste/fish kills on opening day. Encourages the use of non-bottom-disturbing gears. +	Will not create shifts in effort to other fisheries +	Continues loss of traditional otter trawl fishery in Special Secondary Nursery Area -	Commercial and recreational fishing will continue with no changes in gear use or conflict +	Same level of enforcement +	Continued proclamation authority. No rule change needed. +	Benefit to existing Shellfish Management Areas +
2. Allow all trawlers in the New River Special Secondary Nursery Area	Increases bycatch in the Special Secondary Nursery Area -	Increases harvest on opening day, potentially affecting market price. -	Re-establishes traditional otter trawl fishery in Special Secondary Nursery Area. May increase conflict between otter and skimmer trawlers. -	May increase conflict between otter and skimmer trawlers, as well as other user groups. -	Same level of enforcement +	Implemented by proclamation authority +	Potential increase of siltation on Shellfish Management Area -
3. Prohibit all trawlers and skimmers in the New River Special Secondary Nursery Area	Eliminates all bycatch in the Special Secondary Nursery Area. Eliminates waste/fish kills on opening day. Encourages the use of other gears. +	Eliminates traditional Sneads Ferry fisheries in SSNA. Loss of income for fishermen and fish houses. Additional income from other gears may be marginal due to limited bottom space and efficiency -	Loss of traditional shrimp fisheries in Special Secondary Nursery Area. -	Reduced conflict between recreational and commercial fishermen. Potential to increase the catch of bycatch species in the SSNA by other fisheries. Potential to increase competition among channel netters (limited areas in Special Secondary Nursery Area). +/-	Same level of enforcement +	Implemented by proclamation authority. Eliminates sampling associated with opening and closing SSNAs. +	Benefit to existing Shellfish Management Areas +

Table 12.1 Catch and effort data on shrimp and landed bycatch for channel nets in New River, 1994-2011 (courtesy of DMF trip ticket program).

Year	Participants	Trips	Shrimp (lb)	Sold bycatch(lb)	Mean catch per trip (lb)	Ratio of shrimp to sold bycatch
1994	37	544	47,556	747	87	64
1995	39	850	87,536	1,435	103	61
1996	36	585	62,590	1,894	107	33
1997	44	1,122	86,610	3,065	77	28
1998	29	856	80,714	428	94	189
1999	40	1,453	124,727	4,444	86	28
2000	45	1,380	163,109	38,998	118	4
2001	41	1,112	137,595	79,793	124	2
2002	38	1,257	163,831	61,907	130	3
2003	33	835	100,667	1,685	121	60
2004	32	570	59,799	4,370	105	14
2005	19	126	15,379	886	122	17
2006	18	206	57,011	240	277	238
2007	15	255	36,742	1,043	144	35
2008	14	168	40,892	750	243	55
2009	10	118	16,558	259	140	64
2010†	19	322	39,297	1,279	122	31
2011†	12	205	45,803	862	223	53
Pre-Ban Avg. (1994-2009)	31	715	80,082	12,621	130	56
Post-Ban Avg. (2010-2011)	16	264	42,550	1,070	173	42
% change Pre vs. Post-Ban Avg.	-49.4	-63.1	-46.9	-91.5	+32.9	-25.0

†Otter and crab trawls not allowed above Highway 172 Bridge in the New River

Table 12.2 Catch and effort data on shrimp and landed bycatch for otter trawls in New River, 1994-2011 (courtesy of DMF trip ticket program).

Year	Participants	Trips	Shrimp (lbs)	Sold bycatch(lbs)	Mean catch per trip (lbs)	Ratio of shrimp to sold bycatch
1994	120	807	53,787	7,115	67	8
1995	152	1,186	152,285	12,142	128	13
1996	96	508	42,113	3,941	83	11
1997	109	828	79,788	3,721	96	21
1998	109	569	109,034	4,875	192	22
1999	141	755	77,956	4,537	103	17
2000	157	614	163,640	7,479	267	22
2001	70	186	14,926	4,389	80	3
2002	76	445	91,652	4,710	206	19
2003	67	247	39,264	5,612	159	7
2004	62	174	32,618	4,085	187	8
2005	26	58	11,820	1,528	204	8
2006	21	88	26,029	666	296	39
2007	36	71	21,117	1,735	297	12
2008	19	36	11,499	1,127	319	10
2009	7	10	1,016	30	102	34
2010†	10	13	3,450	5	265	690
2011†	5	12	2,048	317	171	6
Pre-Ban Avg. (1994-2009)	79	411	58,034	4,231	174	16
Post-Ban Avg. (2010-2011)	8	13	2,749	161	218	348
% change Pre vs. Post-Ban Avg.	-90.5	-97.0	-95.3	-96.2	+25.2	+2,088.8

Table 12.3 Catch and effort data on shrimp and landed bycatch for skimmer trawls in New River, 1994-2011 (courtesy of DMF trip ticket program).

Year	Participants	Trips	Shrimp (lb)	Sold bycatch(lb)	Mean catch per trip (lb)	Ratio of shrimp to sold bycatch
1994	5	12	1,468	7	122	226
1995	25	85	21,554	0	254	0
1996	34	224	42,677	267	191	160
1997	41	341	75,029	188	220	400
1998	43	302	69,396	13	230	5,338
1999	49	449	68,813	222	153	310
2000	77	615	155,949	2,508	254	62
2001	44	306	36,043	1,879	118	19
2002	51	832	173,091	1,701	208	102
2003	55	564	89,780	1,356	159	66
2004	37	432	82,384	385	191	214
2005	24	155	21,714	307	140	71
2006	15	169	76,501	121	453	632
2007	27	265	93,094	152	351	611
2008	20	148	48,834	12	330	4,246
2009	9	42	4,973	3	118	1,658
2010†	16	297	102,032	330	344	309
2011†	10	130	18,729	401	144	47
Pre-Ban Avg. (1994-2009)	35	309	66,331	570	218	882
Post-Ban Avg. (2010-2011)	13	214	60,380	366	244	178
% change Pre vs. Post-Ban Avg.	-62.6	-30.9	-9.0	-35.9	+11.7	-79.8

†Otter and crab trawls not allowed above Highway 172 Bridge in the New River

Table 12.4 Catch and effort data on shrimp and landed bycatch for miscellaneous gear (cast nets, gill nets, etc.) in New River, 1994-2011 (courtesy of DMF trip ticket program).
*Data confidential due to less than three participants reporting landings.

Year	Participants	Trips	Shrimp (lb)	Sold bycatch (lb)	Mean catch per trip (lb)	Ratio of shrimp to sold bycatch
1994	*	*	*	*	*	*
1995	24	162	12,837	11,043	79	1
1996	12	20	884	1,528	44	1
1997	11	53	2,934	4,394	55	1
1998	3	6	130	442	22	<1
1999	5	10	387	553	39	1
2000	11	18	1,041	827	58	1
2001	7	9	519	819	58	1
2002	5	5	209	184	42	1
2003	5	16	670	27	42	25
2004	6	5	100	710	20	<1
2005	4	4	594	1,039	149	1
2006	10	64	4,870	349	76	14
2007	6	16	790	2,100	49	<1
2008	3	6	329	631	55	1
2009	*	*	*	*	*	*
2010†	3	3	140	104	47	1
2011†	*	*	*	*	*	*

Table 12.4 continued.

Year	Participants	Trips	Shrimp (lb)	Sold bycatch (lb)	Mean catch per trip (lb)	Ratio of shrimp to sold bycatch
Pre-Ban Avg. (1994-2009)	7	25	1,660	1,568	58	3
Post-Ban Avg. (2010-2011)	2	3	72	52	24	1
% change Pre vs. Post-Ban Avg.	-72.2	-89.9	-95.6	-96.7	-57.7	-77.4

†Otter and crab trawls not allowed above Highway 172 Bridge in the New River

Table 12.5 Catch and effort data on crab and landed bycatch for crab trawls in New River, 1994-2010 (courtesy of DMF trip ticket program). *Data confidential due to less than three participants reporting landings.

Year	Participants	Trips	Crab (lb)	Sold bycatch (lb)	Mean catch per trip (lb)	Ratio of crab to sold bycatch
1994	7	35	10,848	492	310	22
1995	15	94	33,616	3,512	358	10
1996	14	47	8,284	519	176	16
1997	14	187	33,196	2,777	178	12
1998	10	62	3,988	373	64	11
1999	12	32	23,214	489	725	48
2000	11	42	17,643	555	420	32
2001	16	103	17,476	446	170	39
2002	13	77	12,190	183	158	67
2003	15	101	18,732	459	185	41
2004	23	159	41,192	863	259	48
2005	14	125	28,060	113	224	248
2006	*	*	*	*	*	*
2007	-	-	-	-	-	-
2008	-	-	-	-	-	-
2009	-	-	-	-	-	-
2010†	9	32	23,383	61	731	386
2011†	5	23	5,680	3	247	1893
Pre-Ban Avg. (1994-2009)	13	82	19,181	833	262	47
Post-Ban Avg. (2010-2011)	7	28	14,532	32	489	1,140
% change Pre vs. Post-Ban Avg.	-45.2	-66.6	-24.2	-96.2	+86.3	+2,332.2

†Otter and crab trawls not allowed above Highway 172 Bridge in the New River

Table 12.6 Statewide catch and effort data on shrimp and landed bycatch for channel nets, 1994-2011 (courtesy of DMF trip ticket program).

Year	Participants	Trips	Shrimp (lb)	Sold bycatch (lb)	Mean catch per trip (lb)	Ratio of shrimp sold to bycatch
1994	148	2,109	185,585	2,350	88.0	79
1995	176	2,279	272,892	3,701	119.7	74
1996	126	1,473	198,653	3,585	134.9	55
1997	136	2,088	191,188	6,404	91.6	30
1998	113	1,864	181,915	3,043	97.6	60
1999	120	2,589	284,257	17,187	109.8	17
2000	122	2,167	260,321	41,280	120.1	6

Table 12.6 continued.

Year	Participants	Trips	Shrimp (lb)	Sold bycatch (lb)	Mean catch per trip (lb)	Ratio of shrimp sold to bycatch
2001	97	1,623	185,277	80,288	114.2	2
2002	88	1,865	250,656	62,513	134.4	4
2003	86	1,697	255,892	3,523	150.8	73
2004	83	1,351	149,933	5,553	111.0	27
2005	57	864	130,710	2,138	151.3	61
2006	60	896	181,102	2,131	202.1	85
2007	67	954	165,729	7,521	173.7	22
2008	66	1,101	253,530	7,903	230.3	32
2009	60	1,084	180,704	4,199	166.7	43
2010†	57	1,063	129,865	3,303	122.2	39
2011†	40	531	97,908	2,433	184.4	40
Pre-Ban Avg. (1994-2009)	100	1,625	208,022	15,832	137	42
Post-Ban Avg. (2010-2011)	49	797	113,887	2,868	153	40
% change Pre vs. Post-Ban Avg.	-51.7	-51.0	-45.3	-81.9	+11.7	-5.0

†Otter and crab trawls not allowed above Highway 172 Bridge in the New River

Table 12.7 Statewide catch and effort data on shrimp and landed bycatch for otter trawls 1994-2011 (courtesy of DMF trip ticket program).

Year	Participants	Trips	Shrimp (lb)	Sold bycatch (lb)	Mean catch per trip (lb)	Ratio of shrimp sold to bycatch
1994	845	14,583	5,240,153	666,665	359.3	8
1995	888	15,481	5,729,152	478,805	370.1	12
1996	705	11,007	3,055,860	428,639	277.6	7
1997	722	12,702	4,911,799	448,060	386.7	11
1998	513	8,297	2,019,600	577,421	243.4	3
1999	667	10,817	5,275,158	392,835	487.7	13
2000	793	10,521	7,847,702	299,773	745.9	26
2001	553	7,734	3,493,218	235,398	451.7	15
2002	639	10,030	7,511,154	270,553	748.9	28
2003	439	6,682	3,179,629	315,436	475.8	10
2004	421	5,358	2,581,743	217,756	481.8	12
2005	272	2,890	1,078,088	67,411	373.0	16
2006	297	3,252	2,891,435	84,524	889.1	34
2007	338	4,464	7,123,976	138,746	1,595.9	51
2008	364	4,204	6,764,108	161,531	1,609.0	42
2009	340	3,890	4,049,599	123,416	1,041.0	33
2010†	355	3,943	4,280,703	68,106	1,085.6	63
2011†	301	3,003	3,889,637	27,984	1,295.3	139
Pre-Ban Avg (1994-2009)	550	8,245	4,547,023	306,685	659	20
Post-Ban Avg (2010-2011)	328	3,473	4,085,170	48,045	1,190	101
% change Pre vs. Post-Ban Avg.	-40.3	-57.9	-10.2	-84.3	+80.8	+401.8

†Otter and crab trawls not allowed above Highway 172 Bridge in the New River

Table 12.8 Statewide catch and effort data on shrimp and landed bycatch for skimmer trawls 1994-2011 (courtesy of DMF trip ticket program).

Year	Participants	Trips	Shrimp (lb)	Sold bycatch(lb)	Mean catch per trip (lb)	Ratio of shrimp sold to bycatch
1994	79	1,118	203,866	678	182.3	301
1995	128	1,563	424,181	1,636	271.4	259
1996	102	1,179	188,666	4,824	160.0	39
1997	143	2,203	339,056	1,828	153.9	186
1998	92	1,058	179,387	786	169.6	228
1999	155	2,080	599,465	1,666	288.2	360
2000	180	2,429	624,010	3,671	256.9	170
2001	135	1,765	314,994	5,262	178.5	60
2002	158	3,565	831,511	3,919	233.2	212
2003	130	2,535	475,582	8,004	187.6	59
2004	101	2,097	377,173	1,537	179.9	245
2005	72	1,101	176,928	719	160.7	246
2006	87	1,344	686,475	436	510.8	1576
2007	84	1,556	586,700	2,891	377.1	203
2008	92	935	365,331	234	390.7	1558
2009	60	807	181,458	189	224.9	960
2010†	64	1,095	284,972	381	260.2	748
2011†	31	327	55,576	404	170.0	138
Pre-Ban Avg. (1994-2009)	112	1,708	409,674	2,392	245	416
Post-Ban Avg. (2010-2011)	48	711	170,274	392	215	443
% change Pre vs. Post-Ban Avg.	-57.7	-58.4	-58.4	-83.6	-12.3	+6.4

†Otter and crab trawls not allowed above Highway 172 Bridge in the New River

Table 12.9 Statewide catch and effort data on shrimp and landed bycatch for miscellaneous gear (cast nets, gill nets, etc.), 1994-2011 (courtesy of DMF trip ticket program).

Year	Participants	Trips	Shrimp (lb)	Sold bycatch(lb)	Mean catch per trip (lb)	Ratio of shrimp sold to bycatch
1994	49	185	10,719	53,426	57.9	<1
1995	106	557	50,594	55,855	90.8	1
1996	39	186	4,766	22,234	25.6	<1
1997	51	241	6,247	17,448	25.9	<1
1998	37	167	3,576	31,368	21.4	<1
1999	37	144	9,999	48,305	69.4	<1
2000	63	171	5,611	21,818	32.8	<1
2001	40	213	3,511	14,937	16.5	<1
2002	52	233	5,053	17,030	21.7	<1
2003	25	148	1,826	15,496	12.3	<1
2004	19	154	1,792	5,308	11.6	<1
2005	16	118	2,687	3,297	22.8	1
2006	21	111	5,785	3,110	52.1	2
2007	23	62	3,473	8,646	56.0	<1
2008	20	65	2,653	4,764	40.8	1
2009	14	152	5,468	2,137	36.0	3

Table 12.9 continued.

Year	Participants	Trips	Shrimp (lb)	Sold bycatch(lb)	Mean catch per trip (lb)	Ratio of shrimp sold to bycatch
2010†	17	136	5,984	2,186	44.0	3
2011†	17	163	5,404	5,598	33.2	1
Pre-Ban Avg (1994-2009)	38	182	7,735	20,324	37	1
Post-Ban Avg (2010-2011)	17	150	5,694	3,892	39	2
% change Pre vs. Post-Ban Avg.	-55.6	-17.7	-26.4	-80.9	3.9	213.9

†Otter and crab trawls not allowed above Highway 172 Bridge in the New River

Table 12.10 Statewide catch and effort data on crab and landed bycatch for crab trawls, 1994-2011 (courtesy of DMF trip ticket program).

Year	Participants	Trips	Crab (lb)	Sold bycatch(lb)	Mean catch per trip (lb)	Ratio of crab sold to bycatch
1994	239	3,394	1,858,304	153,728	547.5	12
1995	213	1,918	1,045,927	98,997	545.3	11
1996	285	4,051	3,075,373	150,693	759.2	20
1997	293	4,595	3,268,736	152,629	711.4	21
1998	258	5,303	3,065,385	161,243	578.0	19
1999	200	3,246	1,799,454	126,029	554.4	14
2000	167	2,051	922,254	105,831	449.7	9
2001	194	2,332	984,162	107,758	422.0	9
2002	126	958	1,113,491	78,914	1,162.3	14
2003	131	1,605	1,252,366	135,128	780.3	9
2004	170	1,670	886,719	90,318	531.0	10
2005	94	1,027	378,714	47,897	368.8	8
2006	34	243	129,312	19,650	532.1	7
2007	27	115	25,839	6,352	224.7	4
2008	42	278	1,555,327	49,946	5,594.7	31
2009	57	436	911,907	79,812	2,091.5	11
2010†	51	261	286,359	18,693	1,097.2	15
2011†	39	210	199,181	53,462	948.5	4
Pre-Ban Avg (1994-2009)	158	2,076	1,392,079	97,808	991	13
Post-Ban Avg (2010-2011)	45	236	242,770	36,077	1,023	10
% change Pre vs. Post-Ban Avg.	-71.5	-88.7	-82.6	-63.1	+3.2	-27.4

†Otter and crab trawls not allowed above Highway 172 Bridge in the New River

New River Trawl Areas

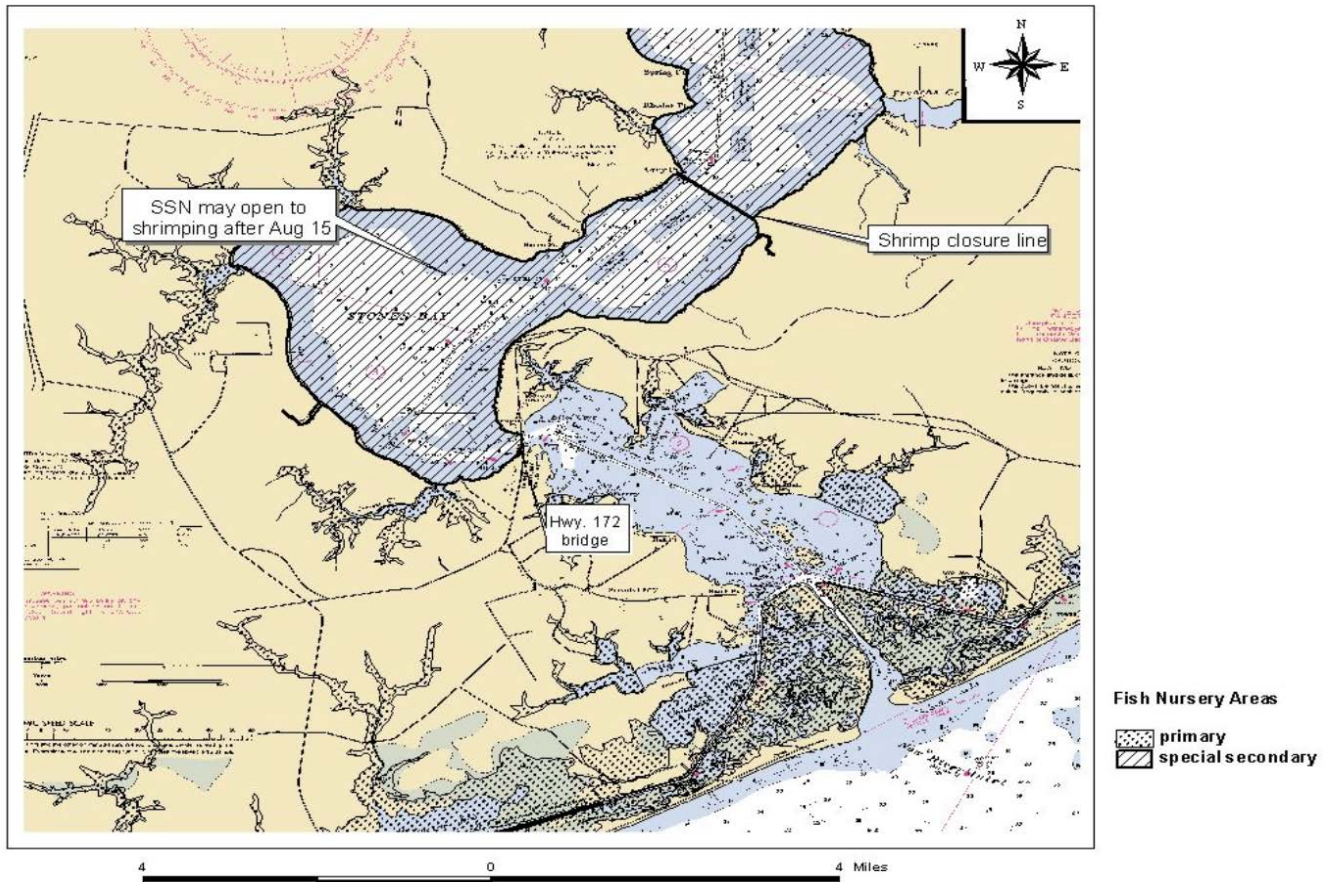


Figure 12.1 Map of the New River showing the areas for the PNAs and SSNA as well as the other trawl closure line.

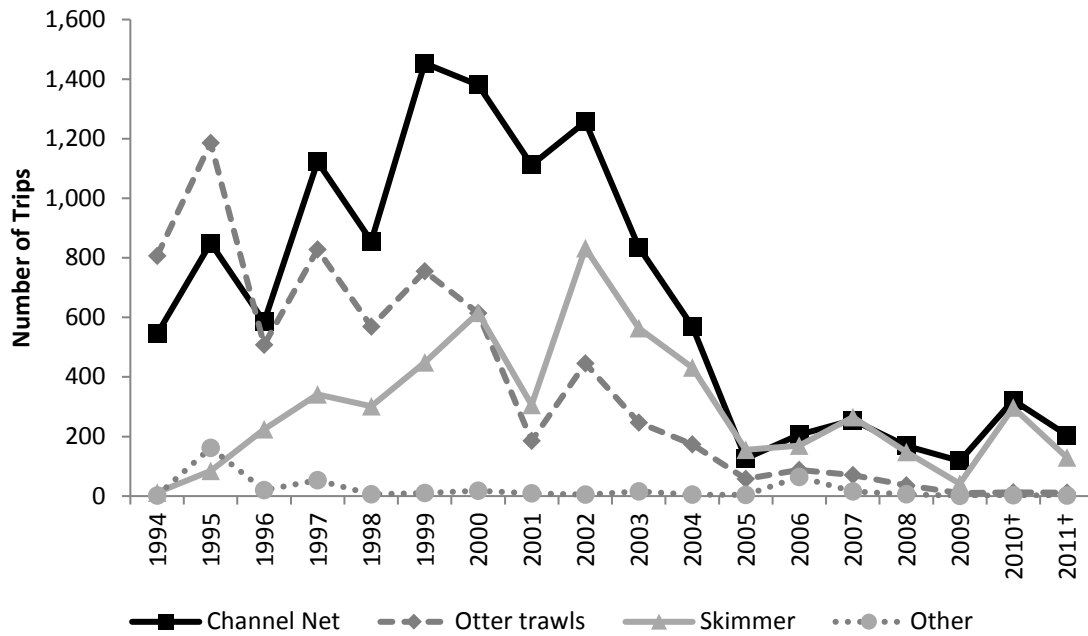


Figure 12.2 Shrimp trips by gear in New River, 1994-2011. †Otter and crab trawls not allowed above Highway 172 Bridge in the New River.

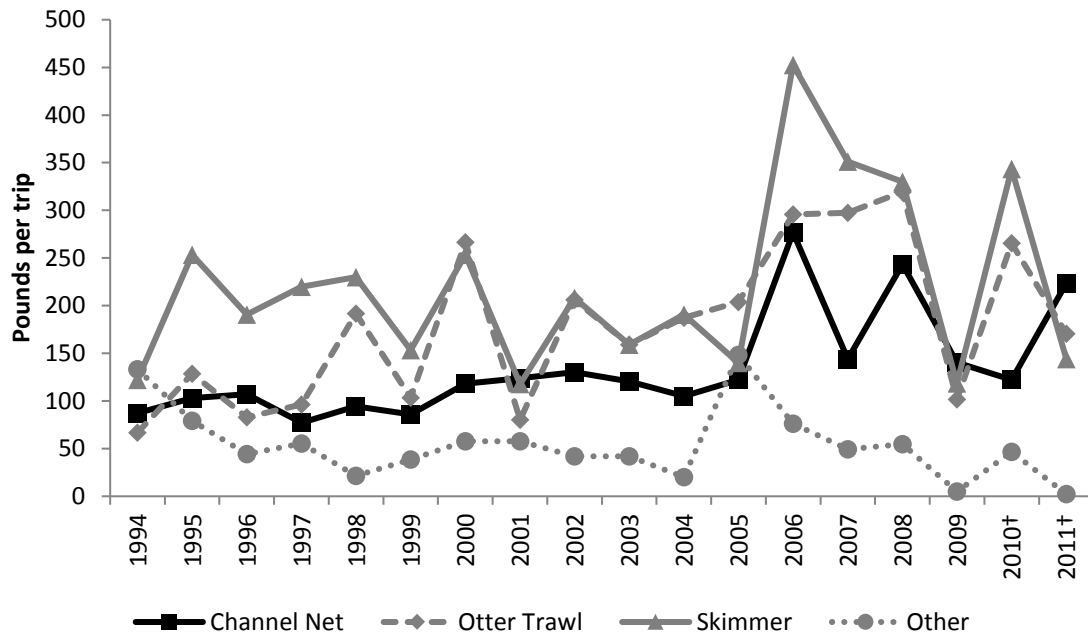


Figure 12.3 Mean catch of shrimp in New River, 1994-2011. †Otter and crab trawls not allowed above Highway 172 Bridge in the New River.

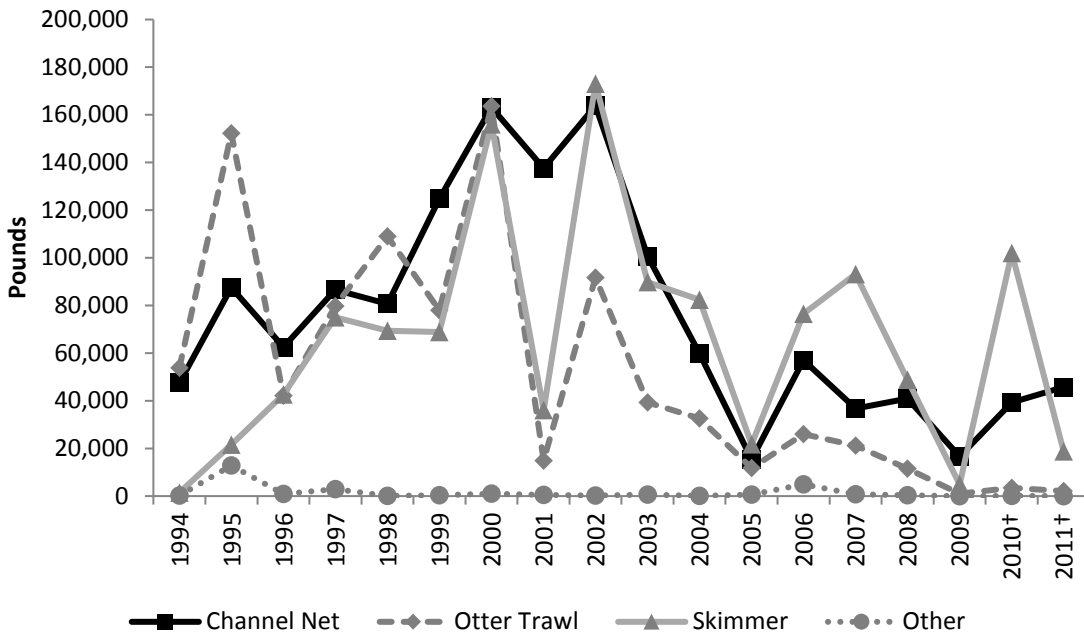


Figure 12.4 Total catch of shrimp in pounds by gear in the New River, 1994-2011. †Otter and crab trawls not allowed above Highway 172 Bridge in the New River.

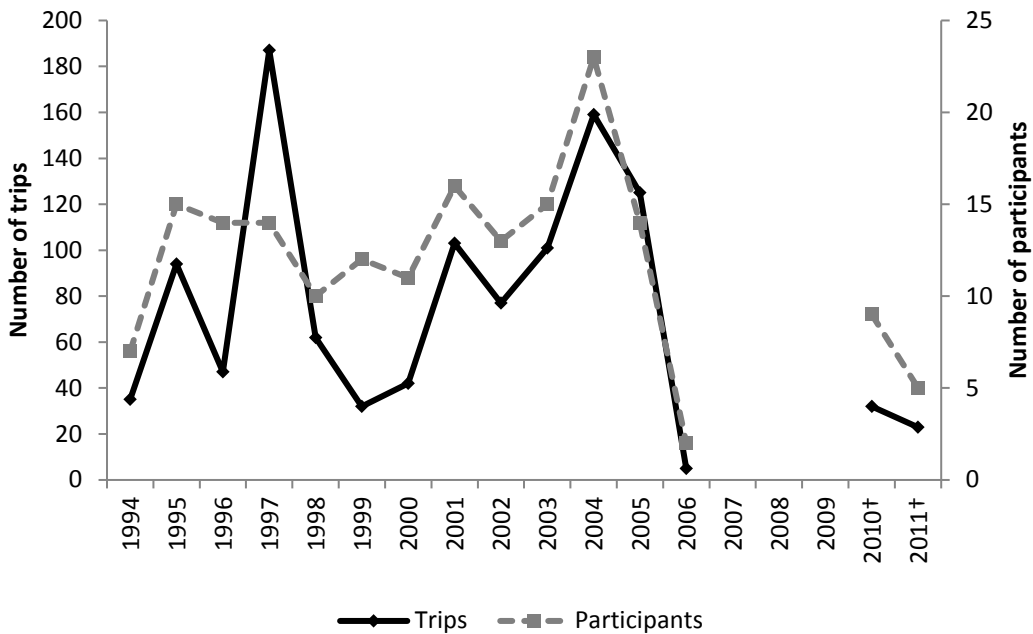


Figure 12.5 Number of trips and participants in the New River crab trawl fishery, 1994-2010. †Otter and crab trawls not allowed above Highway 172 Bridge in the New River.

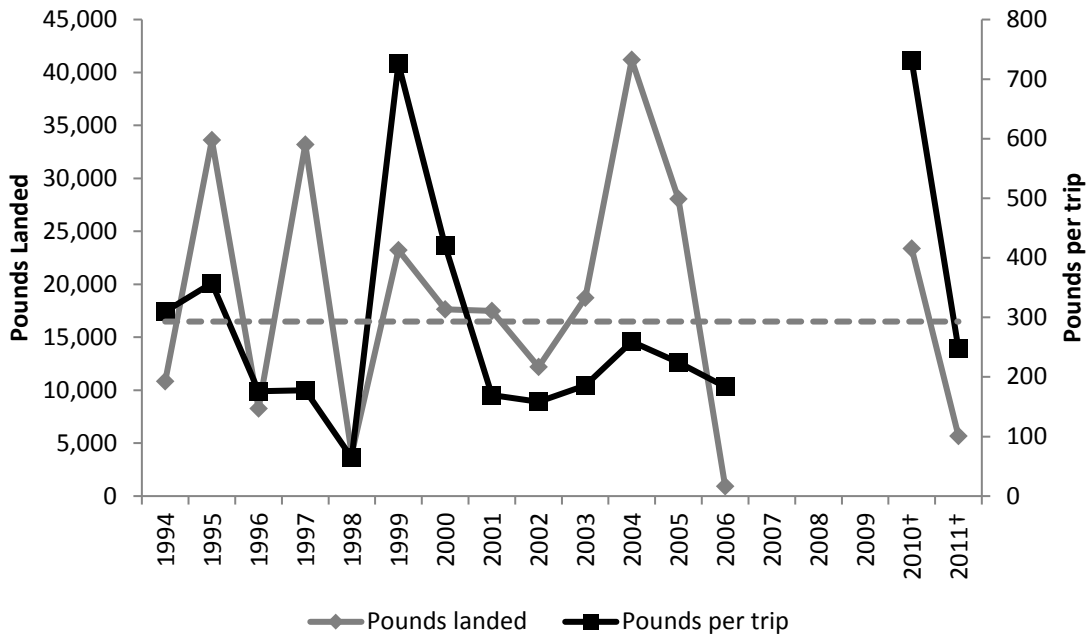


Figure 12.6 Pounds of crab landed and number of pounds of crab landed per trip in the New River crab trawl fishery, 1994-2010. Dotted line represents the average pounds per trip landed from 1994-2010. †Otter and crab trawls not allowed above Highway 172 Bridge in the New River.

12.2 EVALUATION OF THE SKIMMER TRAWL AND OTHER GEARS USED FOR SHRIMPING IN NORTH CAROLINA

I. ISSUE

The exploration of the skimmer trawl along with other gears to harvest shrimp and reduce bycatch in estuarine waters

II. ORIGINATION

The Marine Fisheries Commission, the public and Division staff

III. BACKGROUND

The management of shrimp occurs by district (Figure 12.7). The majority of estuarine shrimping occurs in the Pamlico Sound (81%) which is co-managed by the Pamlico District and Northern District. The Central District and Southern District make up 11% and 4% respectively. The Pamlico and Northern Districts make up approximately 4% of total estuarine shrimp landings excluding Pamlico Sound.

Effort has decreased over time in otter trawls from a high of 15,482 trips in 1995 to a low of 3,004 trips in 2011. Skimmer trawl effort peaked in 2002 at 3,565 trips but has since decreased to 327 trips in 2011 (Table 12.11). Channel nets show a similar decrease from 2,589 trips in 1999 to a low for 531 trips in 2011. Compared to the overall number of otter trawl trips, skimmer trawls, channel nets, cast net and pound net trip numbers are low (Table 12.11). This is

probably due to the overall effectiveness of otter trawls compared to the limited effectiveness of these other gears, based on where they are able to be fished. There was a slight increase in the number of cast net and pound net trips occurring from 2007 through 2011 (Table 12.11). The average number of otter trawl trips is five times the average number of trips made with skimmer trawls with average catch per unit effort (CPUE) 583 lb of shrimp per trip. CPUE for skimmer trawls is 240 lb of shrimp per trip while CPUE for channel nets is 129 lb per trip (Table 12.11). There is generally low effort in the use of cast nets and shrimp pound nets. Pound net data availability is limited because of confidentiality, due to less than three dealers reporting landings (Table 12.11).

The shrimp fishery is the second most valuable fishery in North Carolina. The otter trawl portion of the shrimp fishery annually contributes an average of \$9,776,788 dockside value to the economy with an average value per trip of \$1,267. Skimmer trawls and channel nets also make large annual contributions to the fishery with values of \$566,512 and \$359,367 respectively (Table 12.1). The value per trip is considerably lower for skimmer trawls (\$355) and channel nets (\$234) than otter trawls (Table 12.1). This may be attributed to differences in the amount of gear fished by each type of vessel or overall gear effectiveness.

Participation in the estuarine shrimp fishery has decreased in the otter trawl, skimmer trawl and channel net fisheries. Cast net and shrimp pound net participation has been variable over time with no apparent trends. Otter trawl participation was highest with 888 participants in the fishery in 1995. The fishery has experienced low participation for the last several years with a 66% decline to 301 participants in 2011. Skimmer trawl participation was highest in 2000 with 180 participants but similar to otter trawls, has dropped 83% to 31 participants in 2011. Channel nets have also shown a steady decline in participation dropping 77% from 176 participants in 1995 to 40 participants in 2011.

Factors to be considered when evaluating the effectiveness of skimmer trawls are targeted shrimp species, seasons, water depths, clear bottom, tidal current and tidal range and economic potential. Skimmer trawls are most effective on white shrimp in shallow water depths over bottom clear of structure so that the rigid frames do not foul on the bottom.

The effectiveness of other gears such as channel nets, cast nets and shrimp pounds is determined by what shrimp species is being targeted, seasons, water depths, bottom type, tidal current and tidal range and economic potential. Similar to skimmer trawls, channel nets require specific areas to fish based on bottom contours and water depth. Channel nets are fished in the evening, during a falling tide, in areas that are so specific, they are named by the fishermen. Effective water depths range from 12 to 20 feet deep and tend to be located in deep holes where tidal flow is strong enough to hold the net open.

Cast netting for shrimp has been a popular method to catch bait for hook and line fishing, and in more recent years, for food. In addition, fishermen have the ability to use cast nets in areas closed to shrimping, such as nursery areas, areas closed due to small shrimp and areas closed due to habitat concerns. The limit for cast netting shrimp will be changed to two quarts June 1, 2013 to enable law enforcement to more safely and efficiently enforce this rule. Cast netting requires the skill to effectively throw a round cast into the water and works best when the cast netter is near marsh edge, along a river, off a dock, bridge or boat, over clear non-structured bottom. Although cast netting generally targets white shrimp, brown shrimp may also be harvested with cast nets.

Shrimp pounds require high tidal flow and concentrations of shrimp moving toward channels and inlets. These are best for brown shrimp in shallow water at night; however, they are not as effective for white shrimp that move in deeper water. Shrimp pounds appear to be more functional in Topsail Sound compared to other regions because of the high tidal current and soft bottom habitat (Session and Thorpe 2006).

Southern District

The shrimp fishery within the estuarine waters of the Southern District makes up a large number of small boats fishing in the Intracoastal Waterway, New River and Cape Fear River. Otter trawl effort has declined over time with a maximum of 3,330 trips in 1995 and the lowest number of trips (599) taken in 2006 (Table 12.12). A management strategy that was put in place through the 2006 Shrimp Fishery Management Plan in New River limits otter trawls to the waters below the Highway 172 Bridge, only allowing skimmer trawls to work the waters above the bridge. As a result of this management strategy, marketable bycatch from otter trawls has declined and otter trawl effort has been reduced. While it has only been two years since otter trawls were phased out, preliminary data indicates this has been a viable management strategy; potential lower bycatch, lowering discard mortality and reducing bottom disturbing activities while maintaining the catches of shrimp.

Skimmer trawls are typically fished in shallow waters, no deeper than 15 feet and are used to target white shrimp. In the Southern District, skimmer trawls work the IWW in Onslow and Pender counties up and into New River, Bear Creek and Queens Creek (Figure 12.8 - Figure 12.11). There is very little, if any, effort in New Hanover and Brunswick counties due to the tidal range and bottom contour. Overall, 21% of skimmer trawl landings come from the Southern District from 1994-2011. Skimmer trawl trip number has been variable through the time series and effort in the fishery is most likely based on the year to year availability of white shrimp. The highest number of trips were made in 2002 (1,073 trips) and the lowest number occurred in 1994 (13 trips) (Table 12.12). Recreational Commercial Gear License (RCGL) trawl trips in the southern area decreased from 1,100 in 2002 to 500 in 2008 (otter trawls and skimmer trawls were not differentiated).

Effort in the Southern District for channel nets is highest in New River with fishing also occurring in the IWW, Topsail and Stump Sound (Table 12.12). The majority of cast netting occurs in the IWW with some effort occurring in the Cape Fear River and Lockwood Folly targeting white shrimp in the late summer and early fall. Channel net effort has decreased to a low of 282 trips in 2011 since 1999 when 1,967 trips were recorded (Table 12.12). Cast net trips and landings have remained variable ranging from zero trips made in 2006 to 122 trips made in 2002. Based on a 2012 recreational cast net survey, 37% of recreational cast netters fished in the Southern District. While overall landings from shrimp pounds are low, effort is increasing, especially in the Southern District where tidal flow is probably a little more consistent for its use. However, data are considered confidential. No data were collected on shrimp pounds during RCGL surveys.

Central District

The shrimp fishery in the Central District occurs in Core Sound, North River, Newport River, Bogue Sound and White Oak River. In the Central District, shrimp fishermen tend to fish both otter and skimmer trawls. Fishermen will start out the shrimp season using otter trawls in the spring to target pink shrimp and in the summer to target brown shrimp. The fishermen will then switch over to skimmer trawls in the fall to fish for white shrimp. They may switch back to using otter trawls in the late fall to catch those shrimp that are migrating through deeper channels as

they make a seaward migration. Otter trawl activity has steadily declined since 1995 where 7,150 trips were made to a low of 173 in 2011. Similar to the Southern District, Central District skimmer trawl effort has been variable over time with a high of 2,391 trips in 2002 and a low of 105 trips in 2011 (Table 12.13). Skimmer trawl activity occurs in White Oak River, part of the IWW in Bogue Sound and on the banks side between Hoop Hole Creek and Salter Path. Newport River, North River, and areas around Harkers Island are also popular areas for skimmer trawls (Figure 12.11 - Figure 12.13). The mainland side of Core Sound and its tributaries are also worked by skimmer trawls. Similar to the Southern District, RCGL trawl trips decreased from 1,000 trips in 2002 to 130 trips in 2008.

In the Central District the majority of channel nets are fished in Newport River, North River, and Core Sound (Table 12.3). Channel net effort has been stable for most of the time series; however the highest effort occurred during 1994 with 1,296 trips made. Channel net effort in 2010 and 2011 showed a decline from 476 trips to 249 trips in 2011 (Table 12.13). Most cast netting occurs in the White Oak River, Newport River and North River with variable effort. Forty-seven percent of recreational cast netters surveyed in 2012 were in the Central District of which 26.5% of those were in Bogue Sound. Based on Trip Ticket data, there has been no shrimp pound effort or landings since 1997 (Table 12.13).

Pamlico District

In the Pamlico District, the majority of the fishing effort is from otter trawls in the rivers. Though effort has declined in this district, the declines do not appear to be as steep as in the Southern and Central Districts (Table 12.14). The highest effort was in 1997 with 966 trips and lowest effort occurring in 2009 with 224 trips (Table 12.14). Skimmer trawl activity is low and variable, but effort has increased over time in areas in the Neuse River along the shore between Dawson Creek and the town of Oriental and in Adams Creek (Figure 12.13). The RCGL survey shows that most recreational trawling occurred in the Pamlico District and effort remained steady throughout the time period. An average of 1,600 trips was made from 2002 to 2008.

Channel nets and shrimp pounds are used very little in the Pamlico District and in recent years there have been no reported landings from these gears. In the Pamlico District, the predominant tidal currents and range are driven by the wind compared to the Southern and Central Districts where tides are more lunar driven, thus explaining the limited use of this gear in these areas (Table 12.14). Very little cast netting is done in the Pamlico District with 0% of recreational cast netters surveyed in 2012.

Northern District and Pamlico Sound

The otter trawl is the predominant gear used in the Northern District as well as in Pamlico Sound (Table 12.15 and Table 12.16). Otter trawl effort has decreased in the Pamlico Sound, with only 1,452 trips occurring in 2011, down from peak effort of 4,117 trips during this time series (Table 12.16). There appears to be some use of skimmer trawls within Pamlico Sound along the mainland side from Wysocking Bay to Stumpy Point Bay when shrimp abundances are high (Figure 12.14). RCGL data indicates lower but somewhat steady trip numbers in the Northern District; decreasing from 742 trips in 2002 to 337 trips in 2008.

There is sporadic but limited use of channel nets and cast nets in Pamlico Sound. Only 1.5% of the cast netters surveyed fished in the northern district. In recent years, no shrimp pounds have been fished in Pamlico Sound. On average 12 skimmer trawl trips were made from 1994 to 2011. The Pamlico Sound can be too rough and is generally too deep for skimmer trawls,

therefore making the otter trawl the most efficient gear to be used in Pamlico Sound (Table 12.16).

IV. AUTHORITY

§ 113-134. Rules.

§ 113-173. Recreational Commercial Gear License.

§ 113-182. Regulation of fishing and fisheries.

§ 143B-289.2. Marine Fisheries Commission – powers and duties.

V. DISCUSSION

The majority (89%) of the estuarine shrimp harvest in North Carolina comes from otter trawls. However, major concerns of otter trawls is the capture and discard of various amounts of other non-target species and discard mortality associated with otter trawls. Other concerns include any impacts that may have an influence on the amount of resources available to recreational and commercial fishing. Commercially and recreationally valuable finfish species such as southern flounder, weakfish, spot, and Atlantic croaker are of special concern to fishermen in North Carolina.

McKenna and Clark (1991) explored ways to reduce bycatch in the shrimp fishery through the development and testing of shrimp pot designs and the feasibility of using cast nets to harvest brown shrimp in the Pamlico Sound complex. They found that the limiting factors of shrimp pot development and use of cast nets was shrimp behavior and the lack of suitable bait.

There are also areas (15A NCAC 03R .0106) closed to trawling because of the presence of juvenile finfish and shrimp and habitat concerns but may be conducive to passive type gears and cast nets at certain times of the year. Because of these concerns, this paper explores the use of gears other than otter trawls to harvest shrimp and the bycatch that occurs in these gears. The more popular gears used include skimmer trawls, channel nets, cast nets, and shrimp pounds. These other gears combined make up approximately 11% of the average total estuarine shrimp landings from 1994 to 2011 compared to 89% from the otter trawl.

Otter Trawl

An otter trawl net is dragged along the bottom behind a towing vessel. The mouth of the net is held open by two large "doors" which are attached to either side of the net. The net is dragged behind the boat or on either side of a vessel attached to outriggers. Once the cod end of the net is filled or hauled for a certain time, it is hauled back aboard the vessel where the catch is spilled from the cod end and the net redeployed.

Commercial shrimp trawling in North Carolina began in 1916 in the Southport area. The practice spread throughout the rest of North Carolina over the next couple of decades. Following World War II, there was a considerable increase in effort. Technological advances in the shrimp industry have increased the catching efficiency of larger boats. In the 1940s and early 1950s, a 45-60 foot vessel pulled a single trawl with a head rope length of 60-65 feet. Due to improvements in engine design, the same sized vessel, using four-barreled rigs, can now pull four nets with a combined head rope length of 120-160 feet. Four-barreled rigs allow fishermen to pull two nets from each outrigger.

Skimmer Trawl

A skimmer trawl consists of two nets, mounted on both sides of a vessel on a rigid frame and pushed through the water column. Skimmer trawls were introduced in North Carolina by two Carteret County fishermen who had read about them in a 1989 National Fishermen magazine. They approached North Carolina State University Sea Grant Program to investigate the effectiveness of skimmer trawls in North Carolina waters. Following the request, a series of Sea Grant papers were later published (Coale et al. 1994; Rudershausen and Weeks 1999, Hines et al. 1999). The Rudershausen and Weeks (1999) study examined the mechanical efficiency of experimental skimmer trawl frames constructed of different materials and the Hines et al. (1999) study examined the catch composition of high (12 ft) and low profile (3 ft) skimmer trawls.

Coale et al. (1994) compared shrimp catch and bycatch between a skimmer trawl and a four-seamed balloon otter trawl fishing in close proximity in Straits Channel and North River in Carteret County from June through August of 1991. The skimmer trawl was found to be very effective for catching white shrimp while the otter trawl was more effective at catching brown shrimp. On average, the skimmer trawl caught less bycatch (mean, 0.47 kg/min) than the otter trawl (mean, 0.66 kg/min). It is important to note that the otter trawl tested in this study was not equipped with a turtle excluder device (TED) or a bycatch reduction device (BRD); BRDs were not required in North Carolina until 1992. Bycatch was thought to be reduced as a result of the skimmer's tailbag being fished more frequently. The tailbag of a skimmer can be dumped while the gear continues to fish, thus reducing culling times per tow allowing more fish to be returned to the water alive. Based on live well experiments, 12 finfish species exhibited lower mortality when caught by the skimmer trawl.

Scott-Denton et al. (2006) also concluded that bycatch rates in skimmer trawls are lower compared with historical and current estimates of bycatch associated with otter trawls in Louisiana. In their study, the discard to landing ratio was much lower for skimmer gear (0.63:1) compared to that of the otter trawls in the Gulf of Mexico (4.56:1; Harrington et al. 2005). While bycatch associated with skimmers appears to be lower as a whole compared to otter trawls, Hines et al. (1999) found that low profile net (3 ft) was not effective in reducing bycatch as compared to the high profile net (12 ft) and actually was less effective at capturing brown shrimp.

The benefits of the skimmer trawl include the reduction of finfish bycatch, less bottom disturbance, less fuel consumption, more effective fishing time, and less culling time (Coale et al. 1994; Rudershausen and Weeks 1999; Scott-Denton 2006). The down side of skimmer trawls is that while they are more efficient at catching white shrimp as compared to an otter trawl, they are less efficient at catching brown and pink shrimp (Coale et al. 1994). The white shrimp season can be very short in duration (6 to 8 weeks) and only occurs in the summer and early fall. Skimmer trawls are less likely to be used during a poor white shrimp season which is dependent on prevailing winter water temperatures. The bottom where skimmer trawls work must be free of obstructions due to the rigidity of the gear mouth opening. The vertical height of the skimmer frame also limits the depth by which it can fish; typically working best in shallow water less than 10 to 12 ft deep. Hines et al. (1999) noted that deeper depths substantially increased steering problems due to drag. In contrast, otter trawls are more versatile allowing fishermen to follow shrimp to deeper waters or channels (Hines et al. 1999).

Channel Nets

Channel nets are stationary nets that fish the surface and middle depths on an outgoing tide. They resemble a trawl anchored and staked to the bottom to keep it open. Channel nets offer the advantages of less fuel consumption although there is very little information about bycatch in the channel net. Channel net caught shrimp are considered by the public as a higher quality shrimp. Since these shrimp are migrating out of the estuaries when caught, they tend to be harder shelled, cleaner and bigger than trawled shrimp. Channel nets are set at night on an ebb tide with mouth oriented toward the direction of the oncoming current. The tailbag of the channel net is emptied into a skiff every 15 to 30 minutes. The net is retrieved from the water before the tide changes to prevent it from being turned inside out. There are a limited number of areas that channel nets can be set, with the majority of the effort concentrated in the estuarine waters from Beaufort Inlet to Rich's Inlet. Channel nets must be set near inlets where the current is strong and shrimp have concentrated to move out to sea. Channel nets account for 5% of the average annual shrimp landings.

Cast Nets

The cast net is another type of gear used to harvest shrimp. It consists of a circular net weighted around the perimeter that is thrown out over the shrimp. The weighted edges of the cast net sink to the bottom enveloping the shrimp which is then pulled into the catcher by a line attached to the top of the net. The cast net is most successful on white shrimp in the fall as they school in large concentrations and leave the creeks and tributaries and head for the sounds and, eventually, the ocean. A few pink and brown shrimp are captured around the marshes and shallows during the summer. Throwing from boats or bridges over creeks is productive when they are migrating.

There are little data on catch rates and shrimp size in cast nets. Whitaker et al. (1991) examined catch rates and size of white shrimp caught with cast nets of different mesh sizes over bait. They looked at 3/8 inch, 1/2 inch and 5/8 inch mesh sizes in the Ashley River in South Carolina at night. Overall catch rates of all mesh sizes combined were 37 shrimp per cast with 3/8 inch mesh averaging 55 shrimp per cast, 1/2 inch averaging 36 shrimp per cast and 5/8 inch averaging 21 shrimp per cast. Heads on count estimates were 71, 59, and 41 for 3/8, 1/2, and 5/8 inch mesh respectively. Bycatch from all three mesh sizes were low and included blue crab, catfish, mullet, silver perch, menhaden and brief squid. This study resulted in a recommendation for a minimum mesh size of 1/2 inch mesh cast net for the South Carolina shrimp baiting fishery.

McKenna and Clark (1993) tested the feasibility of using cast nets to harvest brown shrimp in primary and secondary nursery areas bordering Pamlico Sound. They evaluated three different sized meshes of cast nets (3/8 inch, 1/2 inch, and 5/8 inch) over bait balls made of menhaden meal and mud. No shrimp were captured, although there were high densities of shrimp in the area. They modified the sampling methodology by adding a heavier weighted 1/2 inch mesh cast net over bait and also included additional bait types such as canned dog and cat food, bricks soaked in menhaden oil and areas of no bait. They sampled at sunrise, sunset, in the middle of the day and during the night. Nineteen brown shrimp and one white shrimp were captured in 139 throws. The 5/8 mesh net had the highest CPUE for brown shrimp at 0.44 shrimp/cast and over bait balls at 0.18 brown shrimp/cast. Bycatch was low and included Atlantic menhaden, silver perch, blue crab, spot, southern flounder, Atlantic croaker and southern kingfish. They concluded that a lack of tidal influence could affect shrimp behavior in terms of movement and feeding activity and the lack of suitable bait.

Shrimp Pounds

Although not a significant contributor to shrimp landings, shrimp pounds have recently been developed and employed in the taking of brown shrimp. Shrimp pounds are semi-permanent or non-permanent static pounds with a V-shaped lead that directs a shrimp to a funnel connected to a box-shaped pound in shallow waters of the Intracoastal Waterway (IWW) and beach areas in the evenings. One of the leads extends to the shoreline and the other extends out towards a channel or deeper water. Shrimp enter the nets at night as they migrate. The larger shrimp are penned in the pound while the smaller ones are allowed to pass through. These shrimp pounds are used in the southern region of North Carolina and have been around since the mid 1990s. There is minimal disturbance to bottom habitat, and low finfish bycatch. Shrimp and bycatch remain mobile within the pounds thus increasing survivability of finfish bycatch. Sessions and Thorpe (2006) reported average catch rates of shrimp to be 4.5 lb//hour with larger shrimp occurring in June and July. Finfish bycatch consisted of 16 species and were caught between June and November. Catch rates for finfish bycatch averaged 0.1 lb//hour. The average finfish to shrimp ratio was 0.31:1. Pinfish were the most abundant finfish caught making up 66% of the total bycatch by number; menhaden and spot made up 8% and 5% respectively. Spot, croaker, pigfish, southern flounder and striped mullet cumulatively accounted for 8.5% of the total bycatch. Blue crab, shortfin squid, and stone crab were the top ranked invertebrate bycatch (Sessions and Thorpe 2006).

Mortality rates were low with a total of 98% of the finfish species released alive and 95% released alive in good condition. Only menhaden (17%) and one filefish experienced mortality within the gear. Other finfish that were released in fair or poor condition included menhaden, pinfish, white perch, and spot.

Brown and Price (2006) investigated a shrimp pound consisting of two stacked pots and two leads to determine its potential as a recreational gear. Average catch rates of shrimp were 2.7 lb of shrimp and 0.24 lb of bycatch on flood tide while average catch rates on an ebbing tide was 2.3 lb of shrimp and 0.11 lb of bycatch. Brown shrimp made up the majority of the shrimp catch at 96% and 99% of total weight from flood tide sets and ebb tide sets, respectively. Bycatch consisted of blue crabs and pinfish. Only one spot suffered mortality throughout this study. Moon phase, current speed, salinity, and temperature were found to effect catch per unit effort. Shrimp pounds are easy to set up and operate, inexpensive, and easily transported as compared to trawls. However, the pounds only work in certain habitats and are most successful when set during a flood tide with one wing against a bulkhead or marsh shoreline. Results from this study led to the development of shrimp pounds as a Recreational Commercial Gear License (RCGL) gear and another choice for the RCGL holder because of low bycatch and low impacts to the habitat as compared to the otter trawl. Currently, recreational shrimp pounds must be attended, properly marked, and set a minimum of 100 yards from another RCGL shrimp pound or 300 yards from a permitted commercial shrimp pound.

The estuarine otter trawl fishery is the most effective way to harvest shrimp in North Carolina and makes the shrimp fishery the second most valuable fishery in the state behind the blue crab fishery. Skimmer trawls, when used in specific areas during white shrimp season have been shown to be effective in catching commercial quantities of shrimp with less bycatch. However skimmer trawls are limited by water depth and bottom type, and almost exclusively operate in the late summer/early fall white shrimp fishery. Currently skimmer trawls are being fished in the areas they are most effective. Further skimmer trawl characterization studies are also needed.

Other gears specific to harvesting shrimp may have less bycatch than the otter trawl, but are less effective at catching commercially viable market quantities of shrimp. Each gear requires a specific environmental condition to operate efficiently such as depth, bottom profile, and/or current or tidal flow requirements. The seasonality of brown and white shrimp is also important to consider when and where other gears can be used. All of the gears discussed are currently being fished in areas where they are most effective. The use of cast nets in areas otherwise closed to shrimping could be considered based on shrimp availability and size; still allowing fishermen access to the resource while limiting bycatch.

VII. EVALUATION MATRICES

Advisory Committee Evaluation of Skimmers and Other Gears for Shrimping in North Carolina

Impacted Group	Shrimp Fishery			Other Fisheries	Agency		
Management Option	Bycatch Reduction Impact	Economic Impact	Social Impact	Inter-fishery Impact	Enforceability	Authority/ Administrative	Other Impacts
1. <i>Status quo</i>	Continues the existing amount of bycatch and bycatch mortality in the shrimp fishery. Effort reduction has resulted in reduced bycatch and will continue. Gear is more effective, even if effort is reduced +/-	Will not create shifts in effort to other fisheries. Maintains present market value of fishery. +/-	Allows flexibility of use of gears in the fishery. +	Commercial and recreational fishing will continue with no changes in gear use or conflict. not evaluated	Same level of enforcement. not evaluated	Continued proclamation authority. No rule change needed. not evaluated	Allows for further characterization and bycatch reduction studies to fill data gaps prior to new regulations. not evaluated
2. Designate skimmer trawl areas/seasons. Consider an August-November skimmer trawl season in Newport River, North River, Jarrett Bay, Phase in skimmer trawls	Likely decrease in the amount of bycatch in specific areas and during specific seasons. Areas where gear can be used are limited due to physical characteristics of area. +	More profitable at certain times in certain areas. Cost of re-rigging (-). Greater efficiency (+) Greater areas for skimmer trawls (+) Loss of marketable bycatch (-) ++/- -	May reduce the seasonal availability of local brown and pink shrimp. -	Likely to increase conflict among commercial fishermen. Effort shifts may impact other fisheries in same area. Potential to increase other fisheries' catches of adult bycatch species. not evaluated	Need determination of enforceable boundaries for skimmer areas. No definition of "skimmer" in rule. not evaluated	Implemented by proclamation authority or rule change. Development of criteria for designating skimmer-only areas needed. Extensive mapping of boundaries by seasons needed. not evaluated	Potential to decrease impact from other trawls. not evaluated
3. Designate channel nets, pound nets, and cast nets areas/seasons	Likely decrease in the amount of bycatch in specific areas and during specific seasons. Areas where gear can be used are limited due to physical characteristics of area. +	May reduce flexibility in landings and value of landings in specific areas and during specific seasons (channel nets cannot be set Dec-March 1). Loss of marketable bycatch. Cost of additional gear. Reallocation of resource to another user group. Based on user group, could be a + or a - . Economic impact-everyone gets a piece of the pie. +/-	May increase conflict within each fishery. May reduce the seasonal availability of local shrimp. Increased gear may restrict waterway. Pound nets eliminate areas other gear can be fished. -	May increase conflict among commercial fishermen. Effort shifts may impact other fisheries in same area. Potential to increase other fisheries' catches of adult bycatch species. not evaluated	Need determination of enforceable boundaries for each gear and area. Pound nets must be permitted and have public comment period. not evaluated	Development of designation criteria needed. Extensive mapping of boundaries by gear and seasons needed. not evaluated	Potential to decrease impact from other trawls. not evaluated

Advisory Committee Evaluation of Skimmers and Other Gears for Shrimping in North Carolina

Impacted Group	Shrimp Fishery			Other Fisheries	Agency		
Management Option	Bycatch Reduction Impact	Economic Impact	Social Impact	Inter-fishery Impact	Enforceability	Authority/ Administrative	Other Impacts
4.Allow limited quantities of shrimp to be harvested with cast nets in closed areas except for nursery areas Consider 4 quarts as an option	Unlikely to reduce bycatch because of very low bycatch in cast nets. <p align="center">+</p>	Possible additional source of income as a bait fishery. Expands the ability to cast net to more consumers. <p align="center">+</p>	May increase animosity (-). May open up areas for recreational and commercial users (+). <p align="center">+/-</p>	May increase conflict between recreational and commercial fishermen. Encourages increased disturbance in sensitive areas (e.g., SAV). <p align="center">not evaluated</p>	Need determination of enforceable boundaries for cast net areas. Increased enforcement for harvest limits. <p align="center">not evaluated</p>	Implemented by proclamation authority and rule change. Development of criteria for designating cast net only areas needed. Extensive mapping of boundaries by gear and seasons needed. <p align="center">not evaluated</p>	
5.Eliminate Recreational Commercial Gear License otter trawls Added by AC but not evaluated							

DMF Evaluation of Skimmers and Other Gears for Shrimping in North Carolina

Impacted Group	Shrimp Fishery			Other Fisheries	Agency		
Management Option	Bycatch Reduction Impact	Economic Impact	Social Impact	Inter-fishery Impact	Enforceability	Authority/ Administrative	Other Impacts
1. <i>Status quo</i>	Continues the existing amount of bycatch and bycatch mortality in the shrimp fishery +/-	Will not create shifts in effort to other fisheries. Maintains present market value of fishery. +	Allows flexibility of use of gears in the fishery. +	Commercial and recreational fishing will continue with no changes in gear use or conflict +/-	Same level of enforcement +	Continued proclamation authority. No rule change needed. +	Allows for further characterization and bycatch reduction studies to fill data gaps prior to new regulations. +
2. Designate skimmer trawl areas/seasons	Likely decrease in the amount of bycatch in specific areas and during specific seasons. Areas where gear can be used are limited due to physical characteristics of area. +	May reduce flexibility, landings and value of landings in specific areas and during specific seasons. Loss of marketable bycatch. May see otter trawl effort shift to other areas. Cost of re-rigging. -	Likely to increase conflict between skimmer and otter trawlers. May reduce the seasonal availability of local brown and pink shrimp. -	Likely to increase conflict among commercial fishermen. Effort shifts may impact other fisheries in same area. Potential to increase other fisheries' catches of adult bycatch species. -	Need determination of enforceable boundaries for skimmer areas. No definition of "skimmer" in rule. -	Implemented by proclamation authority or rule change. Development of criteria for designating skimmer-only areas needed. Extensive mapping of boundaries by seasons needed. -	Potential to decrease habitat impact from otter trawls. +
3. Designate channel nets, pound nets, and cast nets areas/seasons	Likely decrease in the amount of bycatch in specific areas and during specific seasons. Areas where gear can be used are limited due to physical characteristics of area +	May reduce flexibility in landings and value of landings in specific areas and during specific seasons (channel nets cannot be set Dec-March 1). Loss of marketable bycatch. Cost of additional gear. -	May increase conflict within each fishery. May reduce the seasonal availability of local shrimp. Increased gear may restrict waterway. Pound nets eliminate areas other gear can be fished. -	May increase conflict among commercial fishermen. Effort shifts may impact other fisheries in same area. Potential to increase other fisheries' catches of adult bycatch species. -	Need determination of enforceable boundaries for each gear and area. Pound nets must be permitted and have public comment period. -	Development of designation criteria needed. Extensive mapping of boundaries by gear and seasons needed. -	Potential to decrease habitat impact from otter trawls. +
4. Allow limited quantities of shrimp to be harvested with cast nets in closed areas except for nursery areas	Unlikely to reduce bycatch because of very low bycatch in cast nets -	Possible additional source of income as a bait fishery. Potential harvest of small shrimp before reaching marketable size. +/-	May increase animosity with non-cast net fishermen. May open up areas for recreational and commercial users. -	May increase conflict between recreational and commercial fishermen. Encourages increased disturbance in sensitive areas (e.g., SAV). -	Same level of enforcement +	Implemented by proclamation authority and rule change. Development of criteria for designating cast net only areas needed. Extensive mapping of boundaries by gear and seasons needed. -	

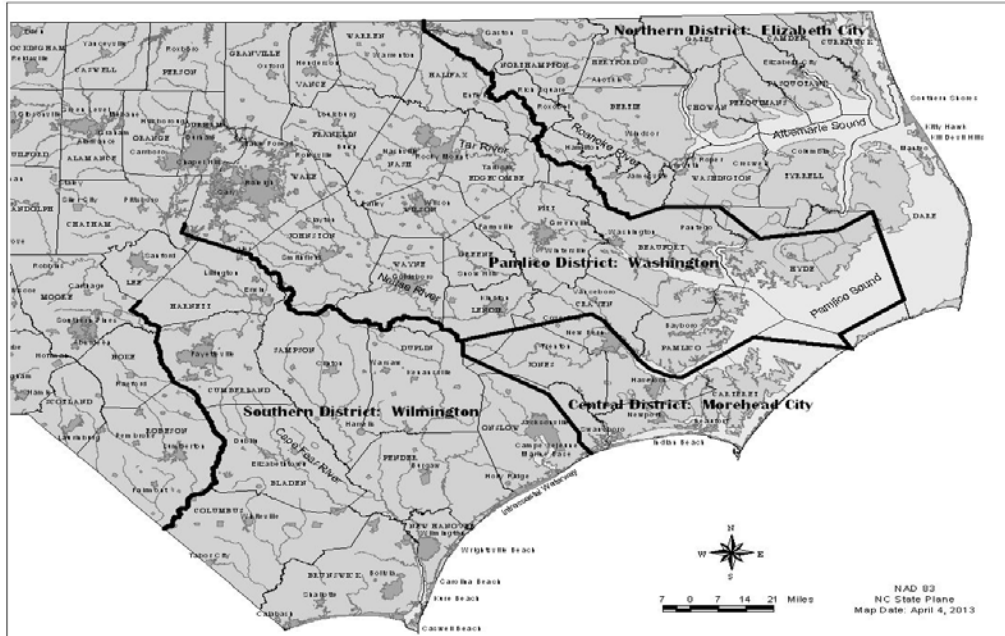


Figure 12.7 NCDMF Fishery Management Districts

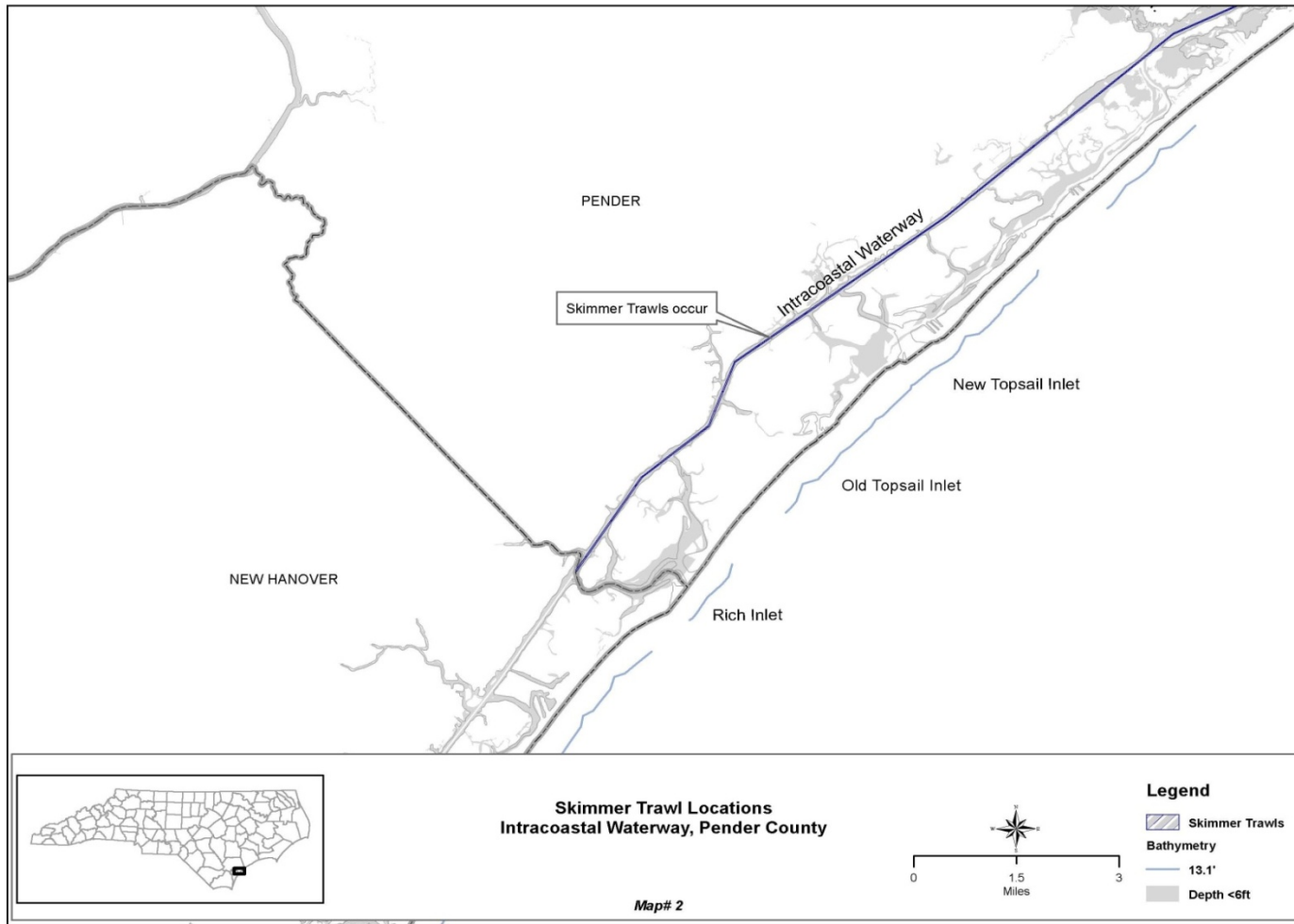


Figure 12.8 Skimmer Trawl Locations in Pender County.

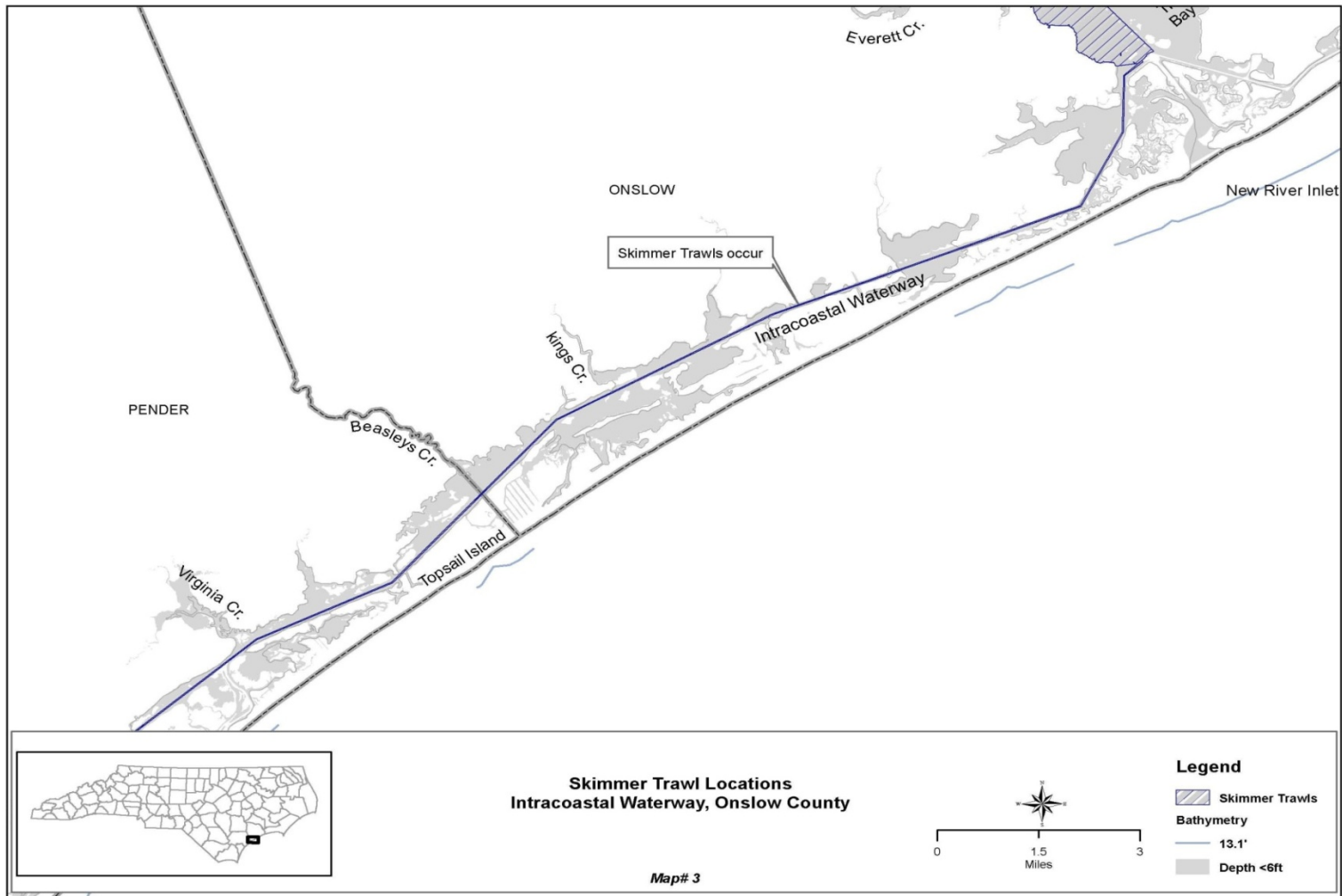


Figure 12.9 Skimmer Trawl Locations in Onslow County.

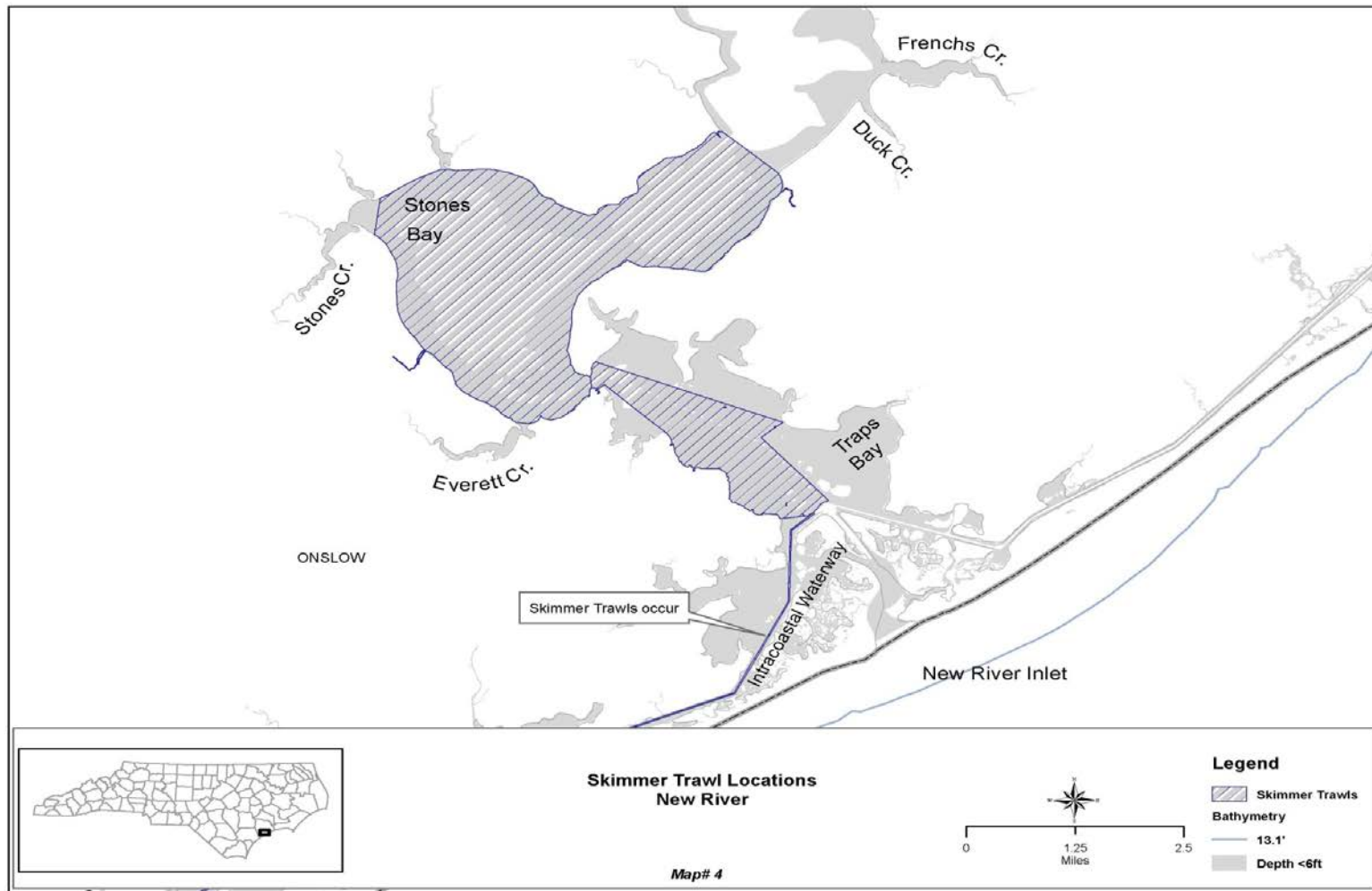


Figure 12.10 Skimmer Trawl Locations in New River.

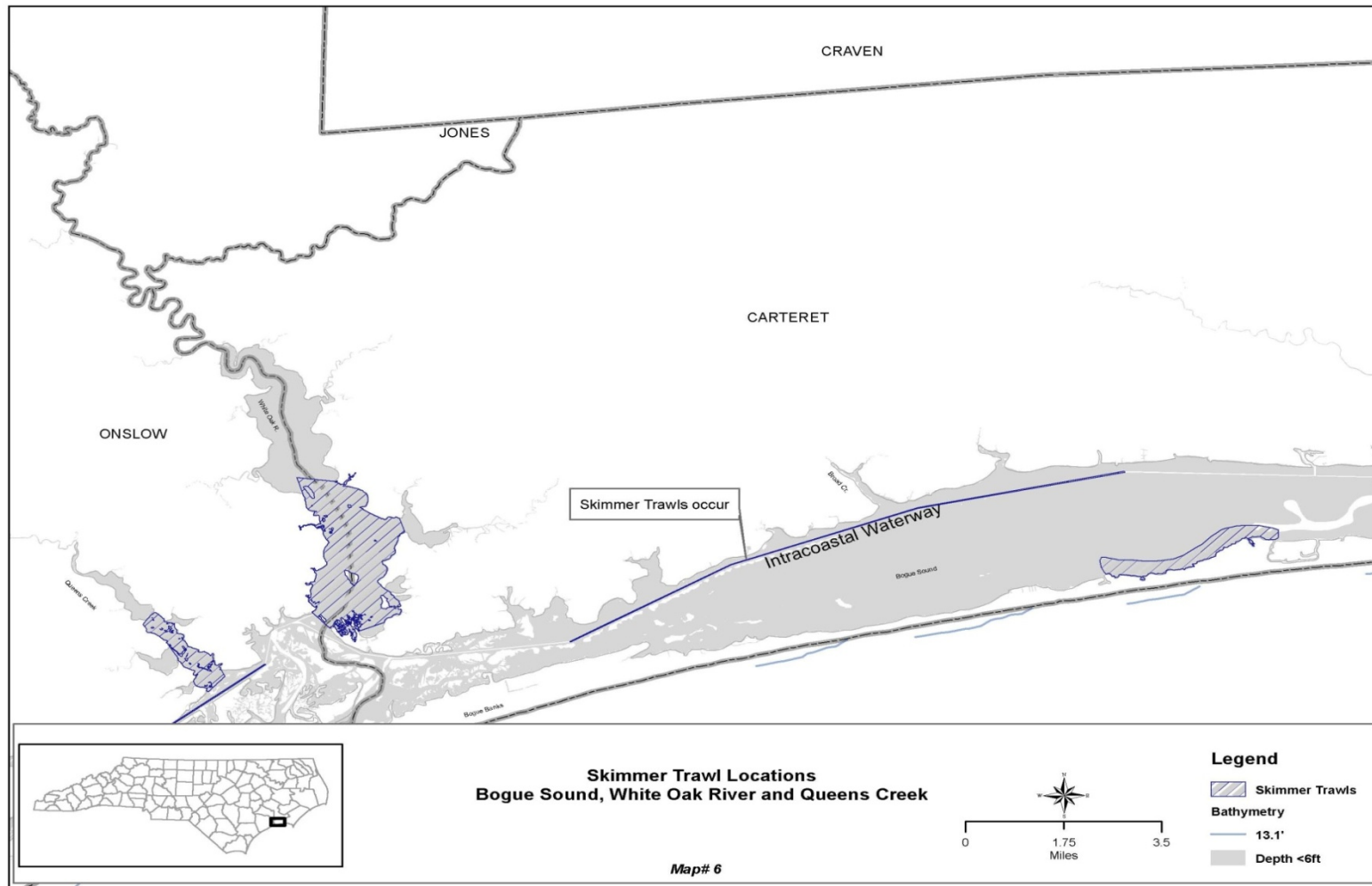


Figure 12.11 Skimmer Trawl Locations in Bogue Sound, White Oak River and Queens Creek.

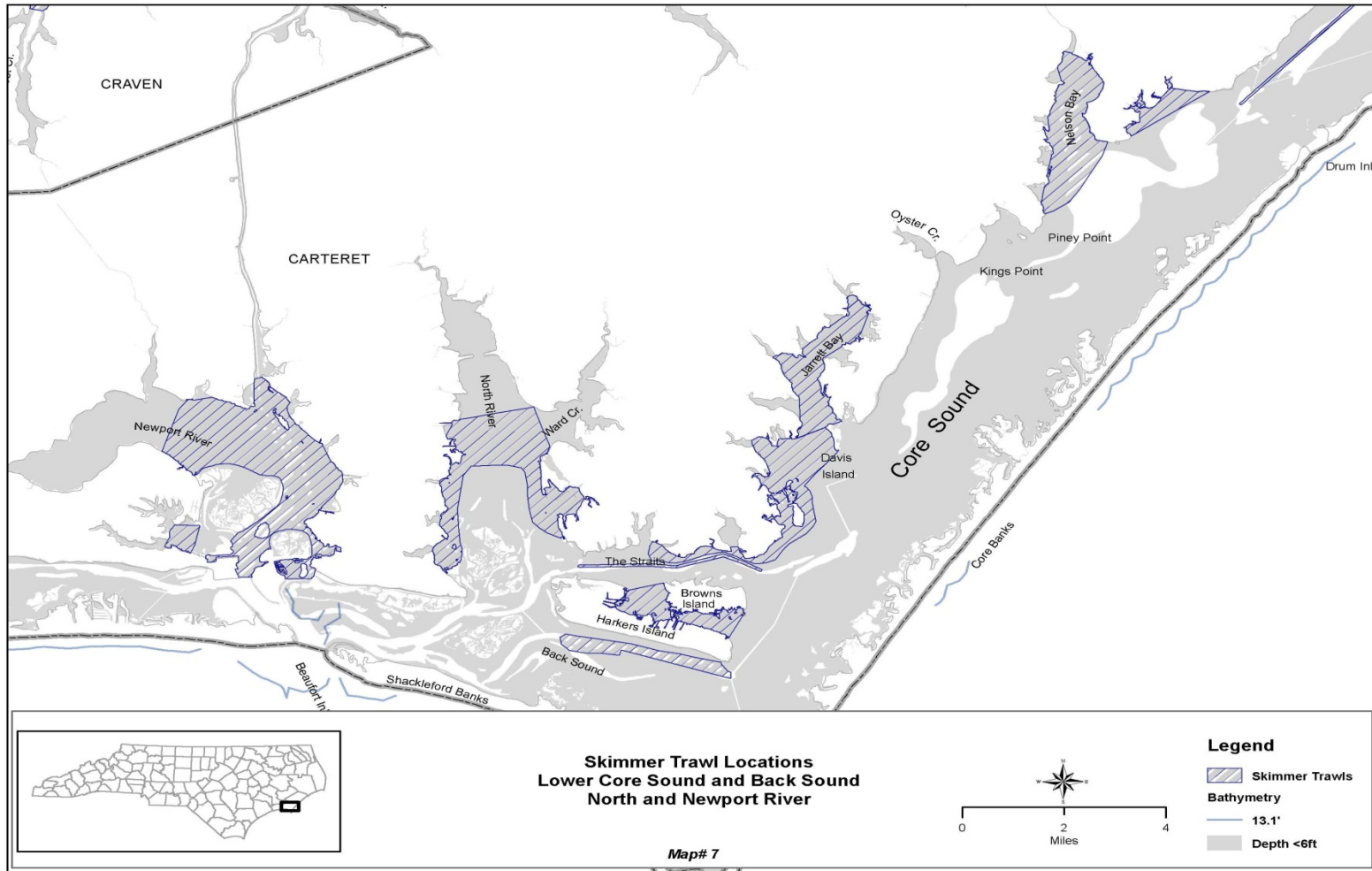


Figure 12.12 Skimmer Trawl Locations in Newport River, North River, Back Sound and Lower Core Sound.

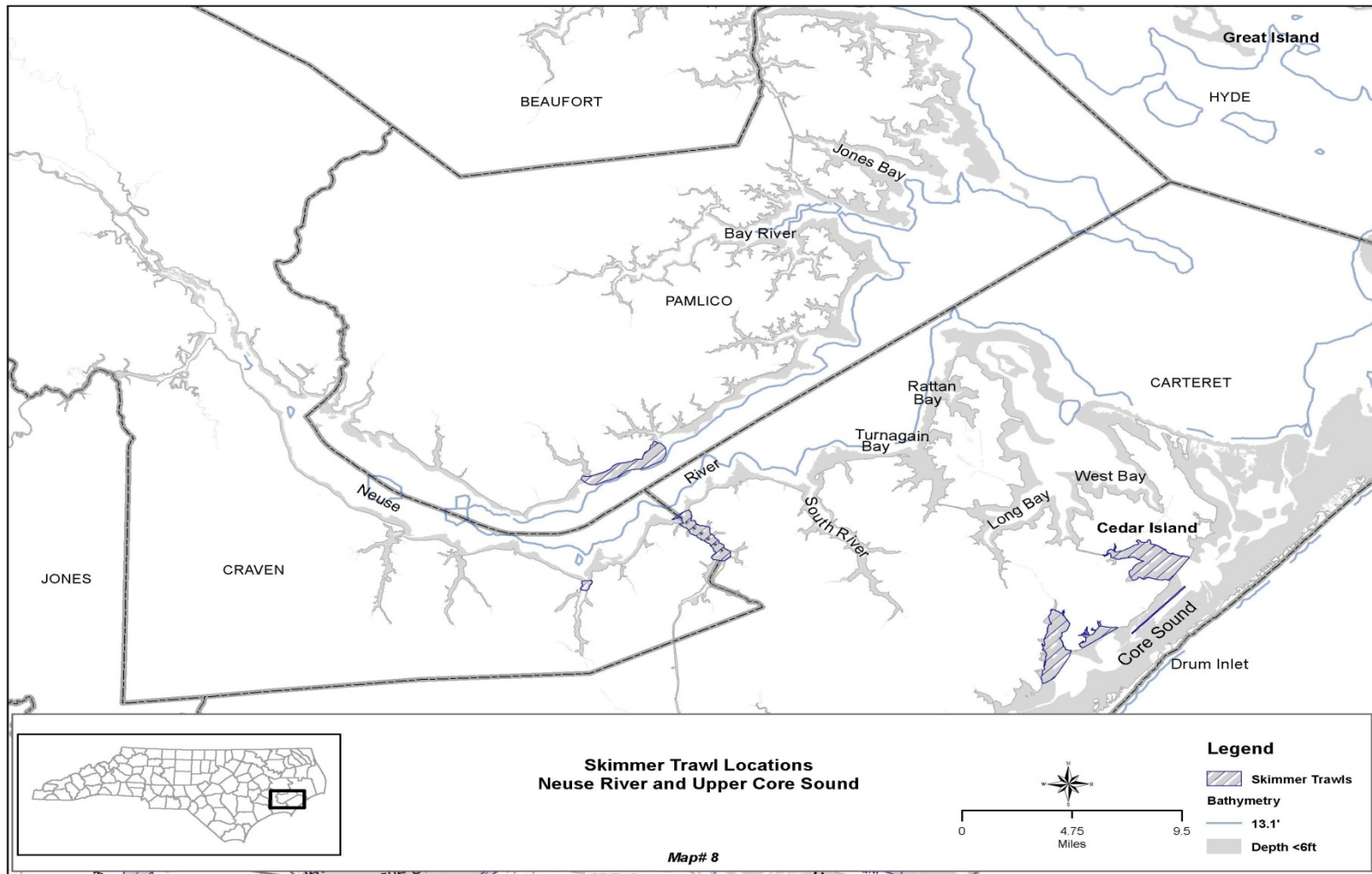


Figure 12.13 Skimmer Trawl Locations in Neuse River and Upper Core Sound.

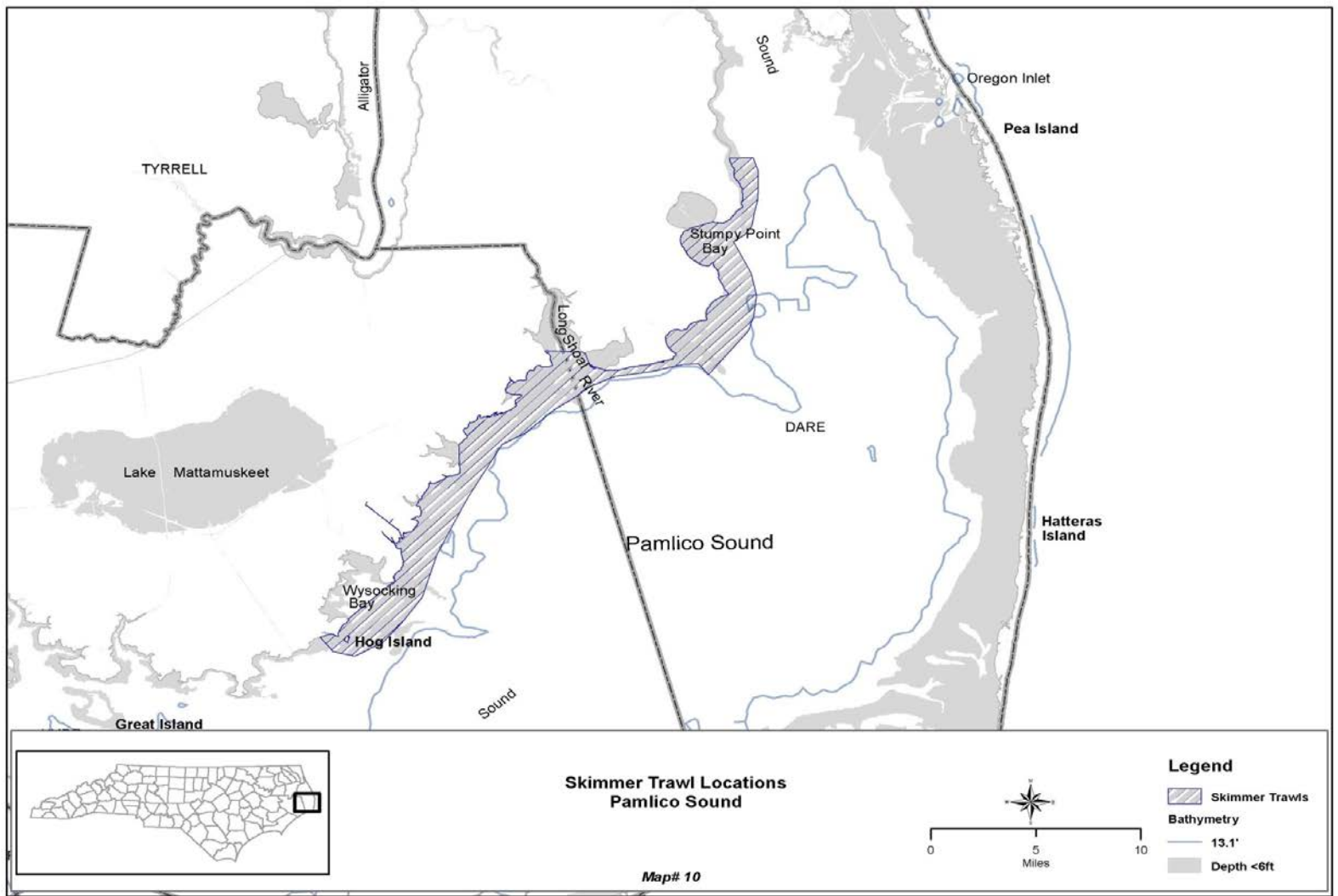


Figure 12.14 Skimmer Trawl Locations in Pamlico Sound.

Table 12.11 Number and average pounds, trips, and value in shrimp trawls, skimmer trawls, channel nets, cast nets and pound nets in state estuarine waters, 1994-2011.

Year	Shrimp Trawl			Skimmer Trawl			Channel Net			Cast Net			Shrimp Pound		
	Pounds	Trips	Value	Pounds	Trips	Value	Pounds	Trips	Value	Pounds	Trips	Value	Pounds	Trips	Value
1994	5,240,153	14,585	\$13,797,757	203,866	1,118	\$382,118	185,585	2,109	\$402,539	236	15	\$566	0	0	\$0
1995	5,729,152	15,482	\$13,759,068	424,181	1,563	\$760,945	272,892	2,279	\$568,260	1,266	36	\$2,645	1,680	13	\$4,226
1996	3,055,860	11,008	\$7,809,425	188,666	1,179	\$439,670	198,653	1,473	\$454,963	637	51	\$1,769	**	**	**
1997	4,911,799	12,702	\$12,958,128	339,056	2,203	\$763,231	191,188	2,088	\$459,963	70	36	\$380	**	**	**
1998	2,019,600	8,297	\$4,473,965	179,387	1,058	\$375,854	181,915	1,864	\$399,726	620	50	\$1,587	0	0	\$0
1999	5,275,158	10,817	\$12,928,539	599,465	2,080	\$899,582	284,257	2,589	\$571,077	4,936	63	\$5,600	0	0	\$0
2000	7,847,702	10,521	\$19,585,614	624,010	2,429	\$1,087,923	260,321	2,168	\$621,181	928	71	\$2,582	0	0	\$0
2001	3,493,218	7,734	\$8,506,491	314,994	1,765	\$497,427	185,277	1,623	\$394,717	289	140	\$2,316	0	0	\$0
2002	7,511,154	10,030	\$14,159,626	831,511	3,565	\$1,136,668	250,656	1,865	\$436,803	386	161	\$5,131	**	**	**
2003	3,179,629	6,682	\$6,011,535	475,582	2,535	\$714,348	255,892	1,697	\$420,083	271	105	\$7,822	0	0	\$0
2004	2,581,743	5,358	\$5,523,421	377,173	2,097	\$529,413	149,933	1,351	\$228,586	142	115	\$2,334	0	0	
2005	1,078,088	2,890	\$2,016,414	176,928	1,101	\$263,381	130,710	865	\$187,292	116	82	\$1,087	**	**	**
2006	2,891,435	3,255	\$5,059,891	686,475	1,344	\$590,720	181,102	897	\$227,972	41	20	\$635	637	9	\$907
2007	7,123,976	4,465	\$13,595,395	586,700	1,556	\$672,596	165,729	954	\$272,177	740	11	\$1,398	**	**	**
2008	6,764,108	4,206	\$13,516,404	365,331	935	\$432,017	253,530	1,101	\$336,822	531	16	\$1,184	**	**	**
2009	4,049,599	3,890	\$6,452,588	181,458	807	\$173,889	180,704	1,084	\$195,984	218	65	\$1,837	**	**	**
2010	4,280,703	3,946	\$7,649,074	284,972	1,095	\$384,020	129,865	1,063	\$182,808	126	37	\$1,321	**	**	**
2011	3,889,637	3,004	\$8,178,854	55,576	327	\$93,420	97,908	531	\$107,651	231	64	\$3,187	**	**	**
Average	4,495,706	7,715	\$9,776,788	383,074	1,598	\$566,512	197,562	1,533	\$359,367	655	63	\$2,410	257	2	\$642
lb/trip	583			240			129			10			105		
value/trip	\$1,267			\$355			\$234			\$38			\$263		

Table 12.12 Number of pounds and trips in shrimp trawls, skimmer trawls, channel nets, cast nets and pound nets in the Southern District*, 1994-2011.

Year	Otter Trawl		Skimmer Trawl		Channel Net		Cast Net		Shrimp Pound	
	Pounds	Trips	Pounds	Trips	Pounds	Trips	Pounds	Trips	Pounds	Trips
1994	278,655	3,031	1,493	13	66,714	812	194	4	0	0
1995	422,595	3,330	21,812	88	124,951	1,160	943	21	**	**
1996	226,007	2,334	43,398	231	97,579	781	83	33	0	0
1997	315,710	2,683	77,508	370	112,073	1,374	56	33	0	0
1998	261,126	2,032	77,837	368	114,942	1,161	578	46	0	0
1999	274,212	2,132	84,770	558	188,513	1,967	4,252	58	0	0
2000	299,827	1,878	173,429	727	199,071	1,697	905	67	0	0
2001	90,356	1,197	48,532	414	158,568	1,340	125	114	0	0
2002	237,973	1,603	210,461	1,073	188,847	1,461	129	122	**	**
2003	227,572	1,492	123,395	821	156,717	1,132	112	67	0	0
2004	124,393	903	100,636	574	89,094	844	39	39	0	0
2005	108,779	745	45,773	288	64,263	451	84	53	**	**
2006	96,497	599	99,271	264	102,498	383	0	0	**	**
2007	104,801	785	101,744	323	54,615	420	**	**	**	**
2008	105,572	830	54,910	183	73,126	403	323	10	**	**
2009	91,048	945	25,180	135	61,509	421	**	**	**	**
2010	213,305	1,358	123,349	376	71,148	586	62	25	**	**
2011	111,845	909	22,270	145	69,090	282	127	59	**	**

*Cape Fear, Inland IWW, Inland IWW Brunswick, Inland IWW Onslow, Lockwood Folly, Masonboro Sound, New River, Shallotte River, Stump Sound, Topsail Sound

** Confidential

Table 12.13 Number of pounds and trips in shrimp trawls, skimmer trawls, channel nets, cast nets and pound nets in the Central District*, 1994-2011.

Year	Otter Trawl		Skimmer Trawl		Channel Net		Cast Net		Shrimp Pound	
	Pounds	Trips	Pounds	Trips	Pounds	Trips	Pounds	Trips	Pounds	Trips
1994	902,950	6,989	197,467	1,098	118,507	1,296	42	11	0	0
1995	1,051,793	7,150	399,169	1,456	144,641	1,113	133	9	914	8
1996	744,692	5,939	142,843	920	98,885	651	554	18	**	**
1997	642,743	5,624	251,558	1,756	77,654	710	**	**	**	**
1998	542,580	4,531	101,550	690	66,973	703	**	**	0	0
1999	837,823	4,795	502,839	1,491	95,509	621	654	4	0	0
2000	515,230	3,395	431,102	1,610	61,021	469	**	**	0	0
2001	459,414	3,448	265,594	1,340	26,709	283	162	25	0	0
2002	762,620	3,734	606,769	2,391	61,810	404	257	39	0	0
2003	813,464	3,510	348,207	1,688	99,175	565	160	38	0	0
2004	260,366	1,778	262,269	1,464	60,839	507	103	76	0	0
2005	296,469	1,313	128,569	795	66,319	413	32	29	0	0
2006	213,278	879	556,690	970	78,535	513	37	19	0	0
2007	184,556	774	358,624	1,029	111,114	534	0	0	0	0
2008	344,098	672	253,178	619	180,404	698	**	**	0	0
2009	148,416	763	131,497	608	119,195	663	80	29	0	0
2010	111,363	559	146,517	644	58,693	476	61	11	0	0
2011	35,417	173	15,415	105	28,818	249	15	4	0	0

*Bogue Sound, Core Sound, Newport River, North River/Back Sound, White Oak River

** Confidential

Table 12.14 Number of pounds and trips in shrimp trawls, skimmer trawls, channel nets, cast nets and pound nets in the Pamlico District*, 1994-2011.

Year	Otter Trawl		Skimmer Trawl		Channel Net		Cast Net		Shrimp Pound	
	Pounds	Trips	Pounds	Trips	Pounds	Trips	Pounds	Trips	Pounds	Trips
1994	177,999	734	3,794	3	0	0	0	0	0	0
1995	152,274	706	3,200	19	801	5	**	**	704	4
1996	136,442	498	2,425	28	2,189	41	0	0	0	0
1997	215,821	966	5,849	57	**	**	0	0	0	0
1998	99,774	443	0	0	0	0	0	0	0	0
1999	285,904	649	8,513	30	**	**	**	**	0	0
2000	280,918	674	17,009	83	**	**	0	0	0	0
2001	51,999	284	867	11	0	0	**	**	0	0
2002	324,068	658	13,807	100	0	0	0	0	0	0
2003	112,105	367	3,980	26	0	0	0	0	0	0
2004	83,030	511	11,425	53	0	0	0	0	0	0
2005	113,982	336	2,586	18	0	0	0	0	0	0
2006	116,879	271	14,545	66	0	0	**	**	0	0
2007	139,692	286	30,795	116	0	0	72	4	0	0
2008	372,697	616	47,833	120	0	0	**	**	0	0
2009	121,901	224	17,254	58	0	0	**	**	0	0
2010	117,346	380	14,771	73	**	**	**	**	0	0
2011	104,863	448	17,191	73	0	0	**	**	0	0

*Bay River, Neuse River, Pamlico River, Pungo River

**Confidential

Table 12.15 Number of pounds and trips in shrimp trawls, skimmer trawls, channel nets, cast nets and pound nets in the Northern District*, 1994-2011.

Year	Otter Trawl		Skimmer Trawl		Channel Net		Cast Net		Shrimp Pound	
	Pounds	Trips	Pounds	Trips	Pounds	Trips	Pounds	Trips	Pounds	Trips
1994	21,251	330	0	0	0	0	0	0	0	0
1995	19,230	179	0	0	0	0	0	0	0	0
1996	14,323	287	0	0	0	0	0	0	0	0
1997	20,339	323	0	0	0	0	0	0	0	0
1998	1,540	30	0	0	0	0	0	0	0	0
1999	5,128	132	0	0	0	0	0	0	0	0
2000	47,281	588	0	0	0	0	0	0	0	0
2001	845	21	0	0	0	0	0	0	0	0
2002	40,557	472	0	0	0	0	0	0	0	0
2003	2,747	43	0	0	0	0	0	0	0	0
2004	13,149	229	0	0	0	0	0	0	0	0
2005	881	28	0	0	0	0	0	0	0	0
2006	3,063	43	0	0	0	0	0	0	0	0
2007	28,998	88	0	0	0	0	**	**	0	0
2008	6,904	82	0	0	0	0	**	**	0	0
2009	10,746	99	**	**	0	0	0	0	0	0
2010	1,488	26	0	0	0	0	0	0	0	0
2011	2,051	22	0	0	0	0	0	0	0	0

*Albemarle Sound, Alligator River, Croatan Sound, Currituck Sound, Pasquotank River, Roanoke Sound

**Confidential

Table 12.16 Number of pounds and trips in shrimp trawls, skimmer trawls, channel nets, cast nets and pound nets in Pamlico Sound, 1994-2011.

Year	Otter Trawl		Skimmer Trawl		Channel Net		Cast Net		Shrimp Pound	
	Pounds	Trips	Pounds	Trips	Pounds	Trips	Pounds	Trips	Pounds	Trips
1994	3,859,298	3,501	1,112	4	**	**	0	0	0	0
1995	4,083,261	4,117	0	0	**	**	44	5	0	0
1996	1,934,396	1,950	0	0	0	0	0	0	0	0
1997	3,717,187	3,106	4,141	20	**	**	**	**	0	0
1998	1,114,581	1,261	0	0	0	0	0	0	0	0
1999	3,872,092	3,109	**	**	0	0	0	0	0	0
2000	6,704,446	3,986	2,470	9	**	**	0	0	0	0
2001	2,890,604	2,784	0	0	0	0	0	0	0	0
2002	6,145,936	3,563	**	**	0	0	0	0	0	0
2003	2,023,741	1,270	0	0	0	0	0	0	0	0
2004	2,100,805	1,937	2,843	6	0	0	0	0	0	0
2005	557,977	468	0	0	**	**	0	0	0	0
2006	2,461,717	1,463	15,970	44	**	**	0	0	**	**
2007	6,665,929	2,532	95,538	88	0	0	300	3	0	0
2008	5,934,836	2,006	9,410	13	0	0	**	**	0	0
2009	3,677,487	1,859	7,514	5	0	0	**	**	0	0
2010	3,837,201	1,623	**	**	0	0	0	0	0	0
2011	3,635,461	1,452	699	4	0	0	**	**	0	0

** Confidential

12.3 RESEARCH RESULTS – THE USE OF TURTLE EXCLUDER DEVICES (TEDS) IN COMMERCIAL SKIMMER TRAWL OPERATIONS

ISSUE

Results from testing the use of a Turtle Excluder Device (TED) in commercial skimmer trawl fisheries.

ORIGINATION

The North Carolina Marine Fisheries Commission voted to amend the Shrimp Fishery Management Plan for the purpose of examining ways to address finfish bycatch in North Carolina shrimp fisheries. While TEDs are used in shrimp otter trawl fisheries to exclude protected species bycatch, they also reduce unwanted finfish bycatch. This paper will present findings of TED testing in commercial skimmer trawl fisheries to date.

BACKGROUND

Skimmer trawl operations consist of two rigid “L” shaped frames attached to each side of the vessel forward of the midline with nets attached along the two sides of the frame (Figure 12.15). The frames are lowered into the water perpendicular to the gunwale of the vessel with the outer portion of the frame, which is affixed with a skid, resting on the sea floor. The lead line of the trawl is attached to the skid on the outer portion of the frame and a bullet weight along the inner portion, which spreads the net horizontally and vertically. A tickler chain shorter than the lead line is attached at the same locations as the lead line. The nets are pushed through the water, and at certain intervals, the “lazylines” or “easy lines”, which are attached just ahead of the tail bags, are retrieved and the catch is dumped on deck for culling while the mouth of the net continues to fish. Frames, bullet weights, and lazylines are all typically retrieved with winches.

Skimmer trawls are used in North Carolina, Florida, Alabama, Mississippi, and Louisiana. Skimmer trawls operate in shallow water bodies (< 12 ft) as the nets hang from frames on each side of the vessel and are pushed through the water column. Skimmer trawls can also operate in greater depths (~20 ft) in some areas in Louisiana, but this is not typical and concentrated in areas with a high tidal volume. In North Carolina, skimmer trawls became prevalent in the early 1990s as technology was transferred from Louisiana fishermen (Hines et al. 1999). Skimmer vessels in North Carolina are typically 30 ft long with crews of one or two fishermen, and operate in estuarine waters in late summer/fall (August – October) when white shrimp (*Litopenaeus setiferus*) are most prevalent. Some fishermen may also target brown shrimp (*Penaeus aztecus*) in the early summer when concentrations are high, but this is not common practice. During the 2011 fishing season, only 327 skimmer trawl trips were reported to the North Carolina Division of Marine Fisheries (NCDMF) trip ticket database. These trips landed about 55,550 lb of shrimp representing less than 2% of the total commercial shrimp landings throughout the state in 2011 (NCDMF Trip Ticket Database 2012).

Turtle Excluder Devices (TEDs) have been required throughout the southeast Atlantic and Gulf of Mexico otter trawl shrimp fisheries since the early 1990s. Skimmer trawls have remained exempt from TED requirements in lieu of tow time restrictions (55 min and 75 min, seasonally), except in Florida, where state management requires the use of approved TEDs in skimmer trawls. However, tow times may often be exceeded, which poses a threat to endangered or threatened species (Scott-Denton et al. 2007). To examine the effectiveness of TED use in skimmer trawl fisheries, the National Marine Fisheries Service (NMFS) – Harvesting Systems

Unit has been conducting comparative testing in skimmer trawls since 2008 in MS, AL, LA, and NC. The purpose of this research has been to test and develop a TED configuration that will minimize shrimp loss and function effectively for commercial fishermen should TED use in skimmer trawls be made a requirement.

Prior to the third year of testing, a mass sea turtle stranding event occurred along the MS coastline in the late spring 2010, which prompted a draft emergency rule to require TEDs in skimmer trawls for the southeastern Atlantic. However, the rule was not enacted because of the Deepwater Horizon oil spill in the Gulf of Mexico and the subsequent closure of commercial fishing activities in this area. Coincidentally, the commercial shrimp fishery had opened in the area adjacent to the strandings just prior to the stranding event.

On June 24, 2011, NMFS published a notice of intent to prepare an Environmental Impact Statement and hold scoping meetings to address incidental bycatch and mortality of sea turtles in the southeastern shrimp fishery (76 FR 37050). One management option presented at the scoping meetings was the implementation of TEDs in commercial skimmer trawls. Since that time, public hearings have been held throughout the southeast and Gulf of Mexico to obtain public comments on proposed skimmer trawl TED regulations.

During the summer and fall 2012, NMFS obtained multiple observations aboard commercial skimmer trawl vessels in the Gulf of Mexico. Sea turtle interactions ($n = 24$) were observed during many of these trips, and it was determined that 58% of these captures were small individuals that could potentially pass through the approved maximum 4 inch bar spacing on TED grids. Due to the size of the sea turtles captured and frequency of interactions, the proposed rule to require TEDs in skimmer trawl operations was withdrawn in November 2012. Further characterization work throughout the Gulf of Mexico and North Carolina is scheduled for 2013. In addition, the Harvesting Systems Unit is currently seeking funding to conduct reduced bar spacing TED testing in skimmer trawls.

Methodology

Skimmer trawl TED testing was conducted aboard contracted commercial fishing vessels with a TED installed on one side of the vessel in a twin trawl operation while the other side has served as a control net. Tows were limited to a 55 minute maximum for all testing. Prior to TED testing, several tows were conducted to assess potential side bias and conduct any necessary gear tuning. To reduce side bias, TEDs were switched between each side of the vessel on a daily basis.

NMFS Observers (Galveston, TX) manned and recorded data on all trips. For each tow, observers recorded the total catch and total shrimp weight for both the port and starboard nets. Sample baskets were selected from each trawl and examined for species composition and weights. Weights and counts of all marketable shrimp from the sample basket were recorded. The remainder of the sub-sample was separated and weighed by species group: finfish, non-shrimp crustaceans, invertebrates other than crustaceans, and debris. Other select species (e.g., skates, rays, sharks) were also separated, counted and weighed.

The catch was analyzed by catch categories of total catch, shrimp catch, and bycatch to determine reduction rates as measured by weight of catch (kg) with the use of a TED. Reduction rates were also calculated for some select species and species groups of finfish (teleost fish), crustaceans (non-shrimp), invertebrates, and debris when sample sizes of each

group were sufficient. It is important to note that finfish species were not sampled individually for these studies.

The objectives of these studies were to: quantify the difference in shrimp catch associated with TED use in skimmer trawls; quantify reductions in bycatch (species groups) associated with TED use in skimmer trawls; identify handling problems or specialized handling techniques required when using TEDs in skimmer trawls; and determine optimal TED configurations by area.

Research Results

2008 – Mississippi and Alabama Skimmer Trawl TED Testing

In 2008, two vessels conducted testing in MS and AL (Figure 12.16). The two TED configurations tested in 2008 consisted of a large (50") and mid-size (40") grid. Both TEDs were installed in a top-opening configuration and were fitted with double-cover flaps. Total catch was significantly reduced with means ranging from a 14% to 51% reduction on both vessels (Table 12.17). Bycatch (all species groups combined) was reduced significantly and ranged from 16% to 55%. Shrimp reductions ranged from 4% to 8% (Table 12.17).

Significant reductions with the use of a TED were observed on both vessels in 2008 for teleost fish ranging from 10% to 47% (Table 12.18). Rays were also reduced significantly in this testing on both vessels with ray reduction rates ranging from 80% to 84%. Crustaceans and invertebrate (non-shrimp) reductions were not found to be significantly reduced on either vessel (Table 12.18).

2009 - Mississippi and Alabama Skimmer Trawl TED Testing

In 2009, testing was also conducted in MS and AL with two contracted commercial vessels (Figure 12.17). Both TED configurations used during this study were top-opening, mid-sized (40") grid TEDs with double cover escape openings. Percent reductions were only significant on one vessel for total catch and bycatch categories (Table 12.19). Mean total catch reductions ranged from 3% to 19%, while bycatch was reduced on average from 3% to 25% (Table 12.19). Shrimp reductions ranged from 1% to 3%, but these were not statistically significant values (Table 12.19).

Species group reductions (crustaceans, invertebrates, teleost fish, and rays) were not found to be significant barring the teleost fish group on one vessel (Table 12.20), where teleost fish were significantly reduced by a mean of 32% (Table 12.20). Reductions in crustaceans, invertebrates, and rays were not found to be significant with the two vessels tested in 2009 (Table 12.20).

2010 - North Carolina Skimmer Trawl TED Testing

Six contracted skimmer trawl vessels from three separate areas of North Carolina estuaries were contracted to conduct comparative TED testing (Figure 12.18). Four different TED configurations were tested during this portion of the study; top-opening double cover (TODC), bottom-opening double cover (BODC), top-opening single cover (TOSC) and bottom-opening single cover (BOSC). All inshore single flap openings stretched to 44 inches and all grids were "Super Shooter" style TEDs.

All six vessels in the 2010 skimmer TED testing in NC showed significant reductions in the total catch, and bycatch groups (Table 12.21). Reductions in total catch for TED equipped nets ranged from a mean of 18% to more than 32% (Table 12.21). Bycatch reductions ranged from 23% to 43%. Statistically significant shrimp reductions were observed for TED equipped trawls on two vessels and ranged from a mean of 9% to 11% on these two vessels. Average shrimp loss was less on the other four vessels ranging from an increase of 1% to a 7% shrimp loss, but these reductions were not significant (Table 12.21).

Four species groups (crustaceans, invertebrates, teleost fish, and rays) were analyzed for reduction rates in the 2010 NC study (Table 12.22). Significant reductions in teleost fish and rays were generally observed on all six vessels. Teleost fish reductions with the use of TEDs ranged from a mean of 10% to more than 27% (Table 12.22). Significant reduction in rays by weight ranged from a mean of 55% to 98% (Table 12.22). Crustacean and invertebrate reductions were more variable on the six vessels in the 2010 study relative to teleost fish and ray groups (Table 12.22).

2011 – North Carolina Skimmer Trawl TED Testing

Three commercial skimmer trawl vessels were contracted to conduct the 2011 comparative TED and usability testing on traditional fishing grounds in the inshore waters of North Carolina (Figure 12.19). Testing in NC during 2011 used TEDs on each side of the skimmer trawl operation with one TED serving as a control. This was done only in 2011 to address fishermen concerns over potential drag that a TED on one side of the vessel may be creating, and was also designed to potentially identify an optimal TED configuration for the fishery in this area. In the 2010 NC study, the TODC TED configuration showed an approximate 11% shrimp loss, but these results were statistically significant and this TED was chosen as the control for the 2011 study. The 2011 testing in NC compared the TODC (control) to three other experimental TED configurations; BODC, TOSC, and BOSC.

Total catch, bycatch, and shrimp reduction rates for the three TEDs tested in the 2011 NC study (BOSC, TOSC, and BODC) relative to the control TED (TODC) showed varied results (Table 12.23). Increases in total catch, bycatch and shrimp were observed with the use of both the BOSC and TOSC TED configuration. Total catch was increased by 9% and 11% with the BOSC and TOSC, respectively (Table 12.23). Bycatch rates ranged from an increase of 6% to 13% with the use of the BOSC and TOSC, respectively. Shrimp catch rates ranged from an increase of nearly 26% with the use of the BOSC, while an increase of less than 1% was observed with the use of the TOSC (TOSC). For these two TED configurations, reduction rates of total catch, bycatch and shrimp were only significant for shrimp ($p = 0.0007$) with the BOSC TED. This significant increase in shrimp may indicate that the bottom opening single cover flap was not functioning properly on this vessel. This increased catch may also have been further confounded by the relatively low catch numbers per tow (mean ~ 2.0 kg/tow) observed throughout testing. For the BODC, reductions rates relative to the control TED in both total catch (5%) and bycatch (8%) were observed. Shrimp catch rates were increased by 2% with the use of the BODC (Table 12.23). For total catch, bycatch, and shrimp groups, reductions rates were all non-significant barring the shrimp increases observed with the use of the BOSC.

Four species groups (crustaceans, debris, invertebrates and teleost fish) were analyzed for each of the three experimental TED types in the 2011 NC study (Table 12.24). Mean crustacean reductions ranged from 4% to 16% between the experimental TED configurations and the control TED, and were only significant ($p = 0.04$) with the use of the TOSC configuration. Invertebrates were reduced (mean = 11%, $p = 0.41$) with the use of the BODC,

but increased percentages were observed in the both the BOSC ($p = 0.19$) and TOSC ($p = 0.01$) relative to the control TED. Mean debris was reduced by 43% ($p = 0.06$) and 46% ($p = 0.0009$) for the BOSC and BODC, respectively. With the use of the TOSC, mean debris was increased (21%, $p = 0.30$) relative to the control TED. Teleost fish bycatch was reduced on average by 4% ($p = 0.25$) and 10% ($p = 0.09$) in the BODC and TOSC, respectively. However teleost fish bycatch increased in the BOSC by approximately 8% ($p = 0.09$) relative to the control (Table 12.24).

2012 – North Carolina Skimmer Trawl TED Testing

Two commercial skimmer trawl vessels were contracted to conduct comparative function and usability TED testing in the inshore waters of North Carolina including Queen's Creek, North River, and Core Sound (Figure 12.20 and Figure 12.21). The TED used for this study was a prototype ('D-Shaped'; smaller (33" x 33" grid), and lighter) TED. This configuration was constructed and tested in response to fishermen concerns that larger (oval) grids used in skimmer trawl operations may decrease fuel efficiency and/or have the tendency to drag the bottom in relatively shallow water fishing grounds. Two TED configurations were tested with the prototype D-shaped grid including a TODC and a BODC.

Total catch was reduced up to 26% on average with the use of either the TODC or the BODC TED configuration (Table 12.25, Figure 12.22). Reductions of total catch ranged from 14% (BODC) up to 35% (TODC), and these reductions rates were highly significant ($p = 0.0000$). Bycatch reductions with the use of a TED showed similar results and ranged from a mean of 25% (BODC) to 37% (TODC), (Table 12.25, Figure 12.22). These reductions ranged from a low of 13% to a high of 52%, and all values were significant ($p = 0.0000$).

Shrimp catches were reduced by 7% to 10% on average with the use of this TED. Shrimp reductions ranged from 2% to 17% for the BODC and TODC TED configurations, respectively. Reductions with the use of the BODC TED configuration were lower (7%) compared to the TODC TED configuration which showed a reduction of 10%. All shrimp reductions were significant ($p < 0.05$), (Table 12.25, Figure 12.22).

Four primary species groups (crustaceans, debris, invertebrates, and teleost fish) were analyzed on Vessel 1 - (Top Opening Double Cover) TED configuration, while rays and sharks were also collected during operations on Vessel 2 - (Bottom Opening Double Cover) TED configuration installed in one side (Table 12.26, Figure 12.23).

Mean percent (kg) reductions were observed with both TED types for all species groups barring an increase in the amount of debris with the use of the BODC. Mean reduction percentages were significant ($p < 0.0001$) for crustaceans and teleost fish with the use of both TED types. Teleost fish reductions ranged from 11% to 57% with a mean reduction of 37% with the TODC TED, and a mean reduction of 22% with the BODC.

Significant reductions ($p = 0.047$) in the mean percentage of invertebrates were observed with the use of the TODC TED, while a 100% reduction ($n = 7$, $p = 0.0015$) in rays were observed in Vessel 2 with the BODC (Table 10, Figure 9). Sharks ($n = 17$) were reduced by 77% on average, but these values were not statistically significant (Table 12.26, Figure 12.23).

2011 and 2012 Louisiana Skimmer Trawl TED Testing

Four commercial skimmer vessels were contracted in 2011 and four were contracted in 2012 to conduct comparative TED testing with naked nets. Smaller and lighter D-shaped TEDs were used for all testing. In 2011, TOSC, BOSC, and TODC TED configurations were tested. All single cover TEDs consisted of 44-inch inshore TED openings. Results of 2011 testing indicated that top opening TEDs out performed bottom opening configurations with regard to shrimp retention (Figure 12.24). Bycatch, composed primarily of floating vegetation, caused severe clogging problems in bottom opening TEDs, while top opening TEDs readily excluded the vegetation. Clogging of bottom opening TEDs resulted in a significant shrimp loss that averaged greater than 21% (Figure 12.24). In contrast, use of the TOSC configuration resulted in a non-significant 1.7% average shrimp gain over a naked net. The TODC performed even better resulting in a non-significant 4.8% gain in shrimp catch (Figure 12.24). Average bycatch reduction, which includes vegetative debris, for the three configurations ranged from an average of 13.8% for the TODC TED to 40.9% for the BOSC TED (Figure 12.24). One green sea turtle was captured in a naked net during testing in 2011 and was released alive.

During 2012, only TODC TED configurations were tested against naked nets. Data are currently being analyzed but preliminary results indicate results similar to those observed during 2011 testing. Three Kemp's ridley sea turtles were captured in naked nets during 2012 testing and all were released alive.

Skimmer Trawl Characterizations – Louisiana

In 2004 and 2005, NMFS initiated observer coverage on a voluntary basis in commercial skimmer trawl operations throughout the coastal waters of Louisiana for the purpose of estimating target and bycatch rates by area and season (Scott-Denton et al., 2007). A total of 307 tows were sampled in this characterization study with vessels (n = 3) operating in 1.3 fathoms of water on average. Extrapolated catch estimates were dominated by kept penaeid shrimp (66%), while fish species represented 19%; discarded penaeid shrimp comprised approximately 6% of the catches, and debris and crustaceans combined represented about 10% of the catches. None of the vessels observed were equipped with Bycatch Reduction Devices (BRDs) or TEDs. No sea turtles were observed during these observations in 2004 and 2005.

Further observations in the skimmer trawl fishery were obtained in 2012 as mandatory observer coverage was established in Louisiana due to concern for potential interactions with threatened or endangered species. The objectives of this characterization were to document interactions with protected or endangered species and to quantify target and bycatch species (Pulver et al. 2012). A total of 796 tows were sampled during this time with vessels (n = 26) operating in 1.6 fathom depths on average. Extrapolated catch estimates from 274 nets, were dominated by finfish (47%), while penaeid shrimp represented 45% of the catch. Crustaceans, debris, invertebrates and discarded shrimp comprised approximately 10% of the catch. About 47% of the vessels observed in this study had BRDs installed in their nets, while 5% of the boats were equipped with TEDs. Twenty-four sea turtles were captured on these trips and all released alive.

I. AUTHORITY

§ 113-134. Rules.

§ 113-182. Regulation of fishing and fisheries.

§ 143B-289.2. Marine Fisheries Commission – powers and duties.

DISCUSSION

Comparative TED testing has been conducted in MS, AL, NC and LA between 2008 and 2012 (Price and Gearhart, 2011; Price and Gearhart *In press*). These studies assessed the functionality of TEDs through comparisons between nets with TEDs and naked nets (no TED). Results from the 2008 to 2010 studies indicated that standard 40" x 33" bent bar grid (super-shooter-style) TEDs perform well in shallow water skimmer trawl operations with minimal shrimp loss (~5%) and significant reductions in total bycatch (~25%). In addition, industry feedback identified several usability deficiencies that were addressed through operational and rigging solutions. Some of the problems identified were: TED twisting, TED chaffing, and bag lifting problems. Vessels used for testing all had slightly different rigging configurations, which is common throughout this diverse fishery. This required slightly different solutions for each problem identified depending on the vessel configuration. However, all of the problems that arose were solved through either adding floatation or chaffing gear or adjusting lifting points on the tailbag. Even though the TEDs worked well, a common request among all users was a request for a smaller, lighter frame. This prompted testing of a smaller D-shaped configuration during the following seasons.

In 2011, and 2012 testing was conducted in NC and LA with the use of a prototype 'D-shaped' TED. This TED was a smaller (33" x 33" grid), and lighter TED than previously tested. This design was much lighter than traditional oval grids and enabled fishing in shallow water with minimal chaffing due to the flat bottom of the D-shaped grid vs. the rounded bottom of the oval grids. The TED was also easier to handle aboard smaller vessels which are found throughout the industry. The TED also performed well during the initial 2011 LA trials with fishermen providing positive feedback about the ease of use over the oval TEDs.

In addition to usability improvements, the D-shaped TEDs also performed better than the oval TEDs in many cases. During LA testing, slight increases in shrimp catch were observed for top opening TEDs. However, bottom opening TEDs in LA performed poorly due to the composition of the bycatch which included lots of floating vegetative debris. This was not the case in NC, where bottom opening TEDs outperformed top opening TEDs. These results illustrate how TED performance can vary widely from location to location depending on local conditions and catch composition. What works well in one location may perform poorly in another, which shows how important it is to conduct testing under differing conditions to identify the best possible TED configurations for each area and situation.

Following 2012 testing, a proposed rule to require TEDs in skimmers was withdrawn, but it is likely that a rule requiring TEDs in these operations is forthcoming in the near future. Currently, NMFS is evaluating reduced bar spacing on TED grids to discern the potential for decreasing smaller (sized) sea turtle interactions or captures. This work will begin with the annual TED testing in Panama City, FL in June 2013. In addition, NMFS is trying to secure funding to conduct TED testing with reduced bar spacing in LA and NC in the late summer and early fall 2013. Collectively, TED testing to date has identified functional TED types and configurations that can work in skimmer trawl operations under various conditions. While some shrimp loss was identified in these studies, further testing is necessary to refine these estimates. In each of

these studies, TED use also resulted in significant reductions of finfish bycatch. Based on testing to date, the use of TEDs in skimmer trawls appears to be a viable management option for reducing sea turtle bycatch without significantly impacting shrimp catch.

II. EVALUATION MATRIX

AC Evaluation of Research Results – The Use of Turtle Excluder Devices (TEDs) in Commercial Skimmer Trawl Operations

Impacted Group	Shrimp Fishery			Other Fisheries	Agency		
Management Option	Bycatch Reduction Impact	Economic Impact	Social Impact	Inter-fishery Impact	Enforceability	Authority/ Administrative	Other Impacts
1. <i>Status quo</i>	No change to current bycatch in skimmer trawl fishery. N	No added expense of reconfiguring gear to incorporate a TED. N	Allows skimmer trawl operators option of using a TED. +	Commercial and recreational fishing will continue with no changes in gear use or conflict. N	Same level of enforcement. N	No proclamation or rule change needed. N	Allows for ongoing characterization and TED testing. +
2. Require TEDs in skimmer trawl operations in North Carolina	Potential to reduce protected species and other bycatch in the skimmer trawl fishery. +	Cost increase to acquire and maintain TEDs. Potential shrimp loss with TED use in skimmer trawls. Increased cost with state/federal rule differences. Increase in cost for redesigning rigs. -	Change from historical skimmer fishery. Provides for general public support of increased sea turtle protection. +	Gear change would have no impact between commercial and recreational fishermen. Gear change remains the same for Recreational Commercial Gear License holders N	Require increased training/patrols. -	Will require rule change (03L.0103). State rule could be more restrictive than current federal regulations. -	May precede potential federal rule and require industry to reconfigure gear multiple times. Consider turtle sizes in NC relative to TED bar spacing. -

DMF Evaluation of Research Results – The Use of Turtle Excluder Devices (TEDs) in Commercial Skimmer Trawl Operations							
Impacted Group	Shrimp Fishery			Other Fisheries	Agency		
Management Option	Bycatch Reduction Impact	Economic Impact	Social Impact	Inter-fishery Impact	Enforceability	Authority/ Administrative	Other Impacts
1. <i>Status quo</i>	No change to current bycatch in skimmer trawl fishery. -	No added expense of reconfiguring gear to incorporate a TED. +	Allows skimmer trawl operators option of using a TED. +	Commercial and recreational fishing will continue with no changes in gear use or conflict. N	Same level of enforcement. N	No proclamation or rule change needed. N	Allows for ongoing characterization and TED testing. +
2. Require TEDs in skimmer trawl operations in North Carolina	Potential to reduce protected species and other bycatch in the skimmer trawl fishery. +	Cost increase to acquire and maintain TEDs. Potential shrimp loss with TED use in skimmer trawls. Increased cost with state/federal rule differences. -	Change from historical skimmer fishery (-). Provides for general public support of increased sea turtle protection (+). +/-	Gear change would have no impact between commercial and recreational fishermen. N	Require increased training/patrols. -	Will require rule change (03L.0103). State rule could be more restrictive than current federal regulations. N	May precede potential federal rule and require industry to reconfigure gear multiple times. -

Table 12.17 Summary statistics, results of paired t tests, percent differences and corresponding 95% confidence intervals for total catch (bycatch + shrimp catch), bycatch, and shrimp catch (kg) by vessel for 2008 skimmer trawl TED testing conducted in MS and AL.

Vessel	TED Type	Species Group	Control Net			Exp Net (TED)			Reduction (wt.)			p-value
			N	Mean	SD	N	Mean	SD	L 95% CI	% Diff	U 95% CI	
1	Top Opening	Total Catch	31	194.02	59.93	31	166.04	57.22	8.22	14.42	20.63	< 0.0001
	Double Cover	Bycatch	31	174.94	57.89	31	147.82	55.81	8.65	15.50	22.36	< 0.0001
		Shrimp	32	19.14	8.34	32	18.33	7.49	- 0.11	4.24	8.59	0.0200
2	Top Opening	Total Catch	28	87.20	41.42	28	42.76	17.15	35.30	50.96	66.61	< 0.0001
	Double Cover	Bycatch	28	79.56	41.92	28	35.76	17.49	37.49	55.05	72.61	< 0.0001
		Shrimp	30	7.81	2.13	30	7.15	2.07	4.29	8.37	12.45	0.0001

Table 12.18 Summary statistics, results of paired t tests, percent differences and corresponding 95% confidence intervals for groups (crustaceans, invertebrates, teleost fish, and rays) (kg) by vessel for 2008 skimmer trawl TED testing conducted in MS and AL.

Vessel	TED Type	Species Group	Control Net			Exp. Net (TED)			Reduction (Wt.)			p-value
			N	Mean	SD	N	Mean	SD	L 95% CI	% Diff	U 95% CI	
1	Top Opening Double Cover	Crustac	4	0.08	0.12	4	0.14	0.17	-919.26	- 80.65	757.97	0.339
		Inverte	31	1.09	1.25	31	1.26	1.27	- 64.90	- 15.70	33.50	0.241
		Teleost fish	31	130.83	43.35	31	118.26	52.82	1.46	9.61	17.76	0.017
		Rays	18	27.68	35.31	18	5.34	3.97	17.25	80.70	144.15	0.008
2	Top Opening Double Cover	Crustac	28	0.56	1.64	28	0.19	0.17	- 49.35	65.26	179.88	0.129
		Inverte	28	0.36	0.54	28	0.23	0.20	- 21.10	36.30	93.69	0.109
		Teleost fish	28	49.80	23.35	28	26.33	13.06	32.18	47.13	62.07	< 0.0001
		Rays	27	22.45	27.02	27	3.56	7.90	38.02	84.13	130.25	< 0.0001

Table 12.19 Summary statistics, results of paired t tests, percent differences and corresponding 95% confidence intervals for total catch (bycatch + shrimp catch), bycatch, and shrimp catch (kg) by vessel for 2009 skimmer trawl TED testing conducted in MS and AL.

Vessel	TED Type	Species Group	Control Net			Exp. Net (TED)			Reduction (wt.)			p-value
			N	Mean	SD	N	Mean	SD	L 95% CI	% Diff	U 95% CI	
1	Top Opening Double Cover	Total Catch	36	17.88	11.15	36	14.52	9.17	8.94	18.78	28.62	< 0.001
		Bycatch	36	12.91	9.64	36	9.60	7.27	11.97	25.68	39.39	< 0.001
		Shrimp	36	4.97	3.38	36	4.93	3.61	- 6.48	0.87	8.22	0.407
2	Top Opening Double Cover	Total Catch	39	26.22	10.91	39	25.47	10.58	- 2.26	2.85	7.96	0.134
		Bycatch	39	20.93	10.93	39	20.35	10.37	- 3.38	2.80	8.97	0.183
		Shrimp	39	5.29	3.61	39	5.12	3.54	- 2.85	3.08	9.02	0.150

Table 12.20 Summary statistics, results of paired t tests, percent differences and corresponding 95% confidence intervals for groups (crustaceans, invertebrates, teleost fish, and rays) (kg) by vessel for 2009 skimmer trawl TED testing conducted in MS and AL.

Vessel	TED TYPE	Species Group	Control Net			Exp. Net (TED)			Reduction (Wt.)			p-value
			N	Mean	SD	N	Mean	SD	L 95% CI	% Diff.	U 95% CI	
1	Top Opening Double Cover	Crustac	35	0.07	0.08	35	0.06	0.07	- 15.97	20.84	57.64	0.143
		Inverte	35	2.72	2.58	35	2.69	2.98	- 15.76	1.25	18.25	0.442
		Teleost fish	35	10.00	8.35	35	6.78	5.32	14.49	32.18	49.87	< 0.001
		Rays
2	Top Opening Double Cover	Crustac	38	0.07	0.06	38	0.06	0.06	- 8.96	18.70	46.36	0.108
		Inverte	38	1.96	3.18	38	1.99	3.18	- 19.74	- 1.13	17.49	0.064
		Teleost fish	39	18.26	9.52	39	17.72	8.81	- 3.11	2.92	8.94	0.166
		Rays	25	0.75	0.95	25	0.95	2.11	-194.92	- 26.59	141.74	0.348

Table 12.21 Summary statistics, results of paired t tests, percent differences and corresponding 95% confidence intervals for total catch (bycatch + shrimp catch), bycatch, and shrimp catch (kg) by vessel for 2010 skimmer trawl TED testing conducted in NC.

Vessel	TED Type	Species Group	Control Net			Exp. Net (TED)			Reduction (wt.)			p-value
			N	Mean	SD	N	Mean	SD	L 95% CI	% Diff	U 95% CI	
1	Top Opening Dble Cover	Total Catch	64	32.43	24.25	64	21.99	10.81	14.28	32.19	50.10	<0.001
		Bycatch	64	25.36	23.25	64	15.68	9.60	15.92	38.16	60.40	<0.001
		Shrimp	64	7.07	4.07	64	6.31	4.33	4.81	10.75	16.68	<0.001
2	Btm Opening Dble Cover	Total Catch	52	13.55	7.14	52	10.93	5.27	9.21	19.34	29.46	<0.001
		Bycatch	52	6.95	3.81	52	4.91	2.94	15.53	29.39	43.25	<0.001
		Shrimp	52	6.60	5.53	52	6.03	4.35	- 0.51	8.76	18.04	0.021
3	Top Opening Single Cover	Total Catch	60	21.44	14.95	60	17.09	9.51	6.38	20.25	34.13	0.002
		Bycatch	60	13.25	14.02	60	9.44	7.35	6.58	28.74	50.90	0.004
		Shrimp	60	8.33	5.01	60	7.78	4.85	- 2.34	6.52	15.39	0.418
4	Btm Opening Dble Cover	Total Catch	61	17.40	11.27	61	14.12	10.31	9.79	18.82	27.85	<0.001
		Bycatch	60	12.92	10.58	60	9.89	9.32	11.44	23.48	35.51	<0.001
		Shrimp	60	4.57	3.77	60	4.42	3.96	- 3.90	3.19	10.28	0.192
5	Btm Opening Single Cover	Total Catch	64	20.75	11.42	64	17.01	9.06	7.56	18.00	28.45	<0.001
		Bycatch	64	12.81	10.82	64	8.98	7.01	13.00	29.96	46.91	<0.001
		Shrimp	64	7.93	6.02	64	8.04	6.29	- 6.10	- 1.30	3.49	0.291
6	Top Opening Dble Cover	Total Catch	45	13.04	7.69	45	8.86	4.42	17.90	32.05	46.21	<0.001
		Bycatch	45	9.63	5.95	45	5.46	2.54	25.86	43.33	60.79	<0.001
		Shrimp	42	3.66	3.32	42	3.65	3.20	- 5.49	0.22	5.94	0.469

Table 12.22 Summary statistics, results of paired t tests, percent differences and corresponding 95% confidence intervals for groups (crustaceans, invertebrates, teleost fish, and rays) (kg) by vessel for 2010 skimmer trawl TED testing conducted in NC.

Vessel	TED Type	Species Group	Control Net			Exp. Net (TED)			Reduction (Wt.)				
			N	Mean	SD	N	Mean	SD	L 95% CI	% Diff.	U 95% CI	p-value	
1	Top Opening Dble Cover	Crustac	64	0.99	0.58	64	0.84	0.70	-	0.32	15.64	31.61	0.041
		Inverte	36	0.88	1.38	36	0.67	1.17	-	0.67	23.44	47.56	0.009
		Teleost fish	64	19.49	11.66	64	14.13	9.37	-	15.01	27.50	40.00	<0.001
		Rays	33	8.03	27.09	33	0.31	0.75	-	23.49	96.11	215.71	0.056
2	Btm Opening Dble Cover	Crustac	51	0.52	0.42	51	0.37	0.25	-	4.73	28.60	52.48	0.014
		Inverte	43	0.74	1.63	43	0.54	1.13	-	23.46	27.49	78.44	0.135
		Teleost fish	52	4.69	2.69	52	3.52	2.01	-	12.19	25.02	37.85	< 0.001
		Rays	36	1.18	1.74	36	0.53	0.97	-	2.10	55.00	107.91	0.036
3	Top Opening Single Flap	Crustac	60	0.78	0.56	60	0.73	0.49	-	12.74	6.06	24.85	0.265
		Inverte	37	0.11	0.18	37	0.10	0.18	-	67.17	8.81	84.79	0.412
		Teleost fish	60	8.77	8.21	60	7.88	6.92	-	1.90	10.10	22.10	0.044
		Rays	43	4.03	10.71	43	0.84	1.06	-	2.64	79.17	160.98	0.030
4	Btm Opening Dble Cover	Crustac	59	0.61	0.53	59	0.65	0.68	-	35.82	- 5.75	24.31	0.346
		Inverte		0.39	0.51		0.30	0.32	-	24.53	23.71	71.94	0.177
		Teleost fish	61	9.90	8.73	61	8.12	7.95	-	7.38	17.98	28.58	<0.001
		Rays	41	1.64	2.26	41	0.99	1.45	-	7.73	39.75	87.24	0.069
5	Btm Opening Single Flap	Crustac	62	0.66	0.64	62	0.50	0.46	-	5.39	24.64	43.89	0.007
		Inverte	22	0.08	0.24	22	0.09	0.23	-	110.66	- 23.21	64.24	0.262
		Teleost fish	64	9.22	7.75	64	7.63	5.93	-	5.37	17.28	29.18	0.001
		Rays	41	2.82	6.30	41	0.90	1.46	-	3.29	68.27	139.84	0.037
6	Top Opening Dble Cover	Crustac	28	0.04	0.05	28	0.02	0.06	-	45.11	33.66	112.44	0.241
		Inverte	-
		Teleost fish	45	6.04	3.23	45	5.36	2.48	-	0.74	11.17	23.07	0.034
		Rays	29	5.50	5.15	29	0.11	0.41	-	62.38	98.04	133.70	< 0.001

Table 12.23 Summary statistics, results of paired t tests, percent differences and corresponding 95% confidence intervals for total catch, bycatch, and shrimp catch (kg) for each experimental TED type in the 2011 NC skimmer trawl TED testing.

Vessel	Exp TED Type *	Species Group	N	Control Net		Exp Net		Reduction (wt.)			p-value
				Mean	SD	Mean	SD	L 95% CI	% Diff	U 95% CI	
1	BOSC	Total Catch	50	10.91	7.27	11.85	6.47	-20.43	- 8.64	3.14	0.0683
		Bycatch	50	9.31	7.01	9.84	6.25	-17.58	- 5.69	6.19	0.1672
		Shrimp	50	1.60	0.87	2.01	1.16	-45.13	-25.81	- 6.50	0.0007
2	TOSC	Total Catch	44	11.36	6.74	12.60	9.95	-40.95	-10.92	19.12	0.2157
		Bycatch	44	9.33	6.20	10.56	9.36	-49.26	-13.22	22.82	0.2099
		Shrimp	44	2.04	1.08	2.04	1.18	- 9.10	- 0.35	8.41	0.4683
3	BODC	Total Catch	45	21.45	8.00	20.31	10.29	- 3.17	5.33	13.82	0.1186
		Bycatch	45	15.88	6.32	14.65	8.51	- 1.63	7.74	17.12	0.0660
		Shrimp	45	5.58	3.41	5.66	3.86	-11.59	- 1.55	8.49	0.3766

* Control TEDs for all three vessels were TODC (Top Opening Double Cover)

Table 12.24 Summary statistics, results of paired t tests, power analyses, percent differences (kg) and corresponding 95% confidence intervals for groups (crustaceans, debris, invertebrates, teleost fish) for each experimental TED type in the 2011 NC skimmer trawl TED testing.

Vessel	Exp TED Type *	Species Group	N	Control Net		Exp Net		Reduction (wt.)			p-value
				Mean	SD	Mean	SD	L 95% CI	% Diff	U 95% CI	
1	BOSC	Crustac	49	1.27	0.91	1.22	0.90	- 9.77	4.32	18.41	0.2741
		Debris	45	0.50	1.31	0.28	0.51	- 21.63	43.01	107.64	0.0637
		Inverts	43	0.27	0.43	0.34	0.39	- 84.72	- 23.81	37.11	0.1924
		Teleost fish	50	7.30	5.69	7.90	5.37	- 20.87	- 8.18	4.52	0.0932
2	TOSC	Crustac	44	1.56	0.92	1.31	0.68	- 1.78	15.66	33.10	0.0442
		Debris	43	2.14	4.24	2.64	5.30	-129.53	- 23.45	82.63	0.3048
		Inverts	43	1.13	1.63	2.62	4.55	-403.13	-132.70	137.73	0.0095
		Teleost fish	44	4.47	3.28	4.01	2.73	- 4.60	10.24	25.09	0.0874
3	BODC	Crustac	45	1.96	0.87	1.75	0.97	- 2.58	10.52	23.63	0.0678
		Debris	43	1.08	1.17	0.58	0.59	16.79	46.19	75.58	0.0009
		Inverts	21	0.09	0.17	0.08	0.11	- 82.53	10.71	103.96	0.4092
		Teleost fish	45	12.66	6.29	12.16	8.35	- 7.14	3.97	15.08	0.2472

* Control TEDs for all three vessels were TODC (Top Opening Double Cover)

Table 12.25 Summary statistics, results of paired t tests, percent differences and corresponding 95% confidence intervals for total catch, bycatch, and shrimp catch (kg) for each experimental TED type in the 2012 NC skimmer trawl TED testing.

Vessel	Exp TED Type *	Species Group	Control Net			Exp. Net (TED)			Reduction (wt.)			p-value
			N	Mean	SD	N	Mean	SD	L 95% CI	% Diff	U 95% CI	
1	TODC	Total Catch	45	17.49	8.92	45	13.01	7.03	16.60	25.59	34.58	0.0000
		Bycatch	45	10.00	8.20	45	6.27	7.08	22.68	37.28	51.89	0.0000
		Shrimp	45	7.49	3.62	45	6.74	2.74	2.60	9.99	17.39	0.0032
2	BODC	Total Catch	56	34.90	16.59	56	27.62	13.33	14.14	20.85	27.56	0.0000
		Bycatch	57	23.34	14.45	57	17.54	9.15	13.41	24.83	36.26	0.0000
		Shrimp	57	10.95	6.53	57	10.17	6.14	1.73	7.08	12.43	0.0045

Table 12.26 Summary statistics, results of paired t tests, power analyses, percent differences (kg) and corresponding 95% confidence intervals for groups (crustaceans, invertebrates, fish, debris, rays and sharks) for each experimental TED type in the 2012 NC skimmer trawl TED testing.

Vessel	Exp TED Type	Species Group	N	Control Net		Experimental Net		Reduction (wt.)			p-value
				Mean	SD	Mean	SD	L 95% CI	% Diff	U 95% CI	
Vessel 1	TODC	Crustac	47	1.05	0.52	0.73	0.50	18.19	30.76	43.33	0.0000
		Debris	47	0.91	0.94	0.71	0.88	- 15.75	22.03	59.81	0.1472
		Inverts	44	1.50	2.50	0.83	1.05	- 5.87	44.78	95.43	0.0465
		Teleost fish	47	6.40	7.62	4.01	6.77	18.07	37.38	56.69	0.0000
		Crustac	57	1.38	0.91	1.10	0.84	5.63	19.92	34.20	0.0055
Vessel 2	BODC	Debris	46	0.06	0.11	0.10	0.22	-233.32	- 68.59	96.13	0.0826
		Inverts	54	0.10	0.13	0.08	0.07	- 6.95	26.50	59.95	0.0640
		Teleost fish	57	21.03	12.08	16.48	9.60	10.99	21.65	32.30	0.0001
		Rays	7	13.10	7.23	0.00	0.00	48.98	100.00	151.02	0.0015
		Sharks	17	1.47	3.95	0.33	0.35	- 61.24	77.32	215.87	0.1318

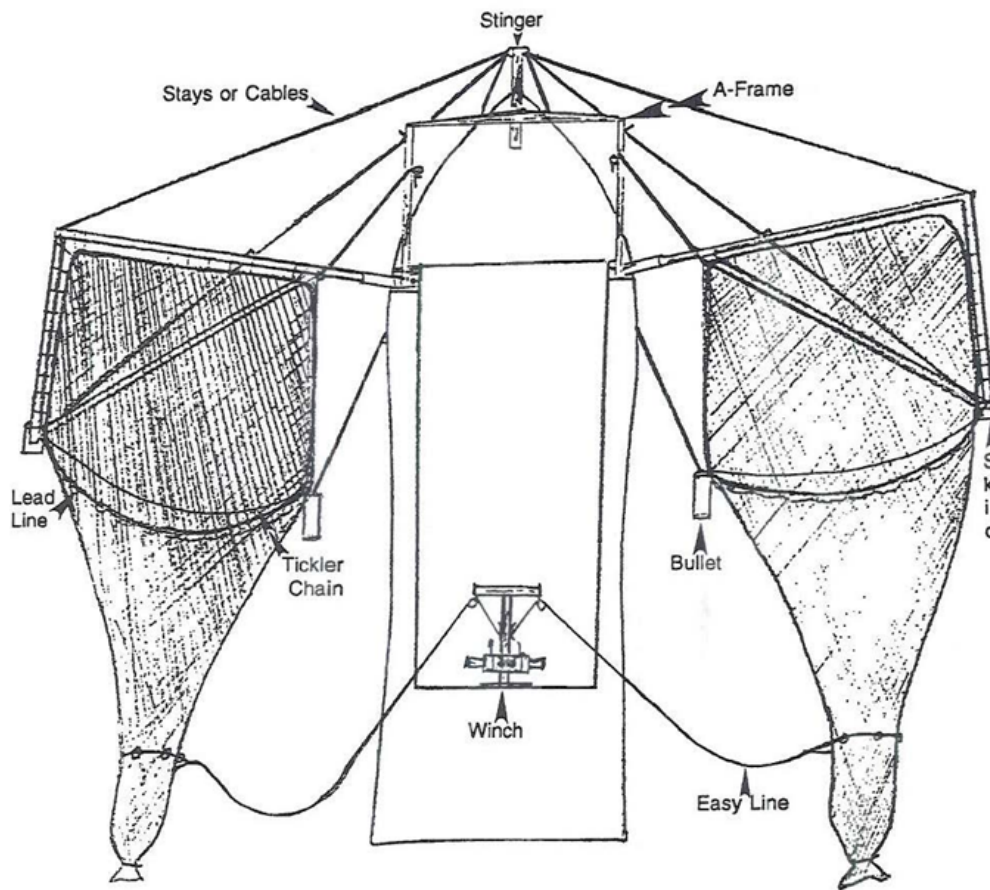


Figure 12.15 Diagram of typical skimmer trawl operation (Source: Hein and Meier 1995).

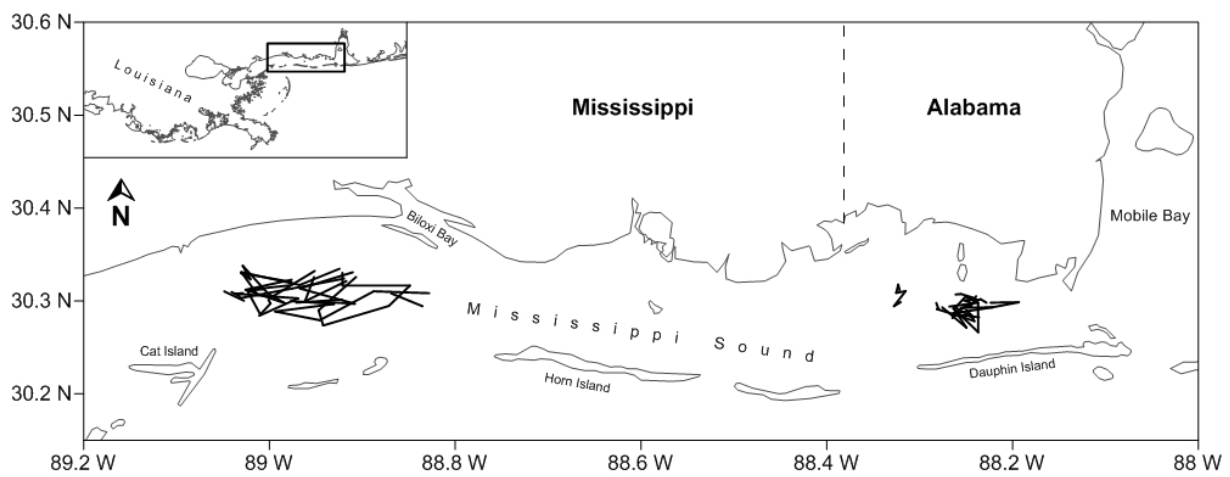


Figure 12.16 Skimmer trawl TED testing locations during 2008 in Mississippi and Alabama.

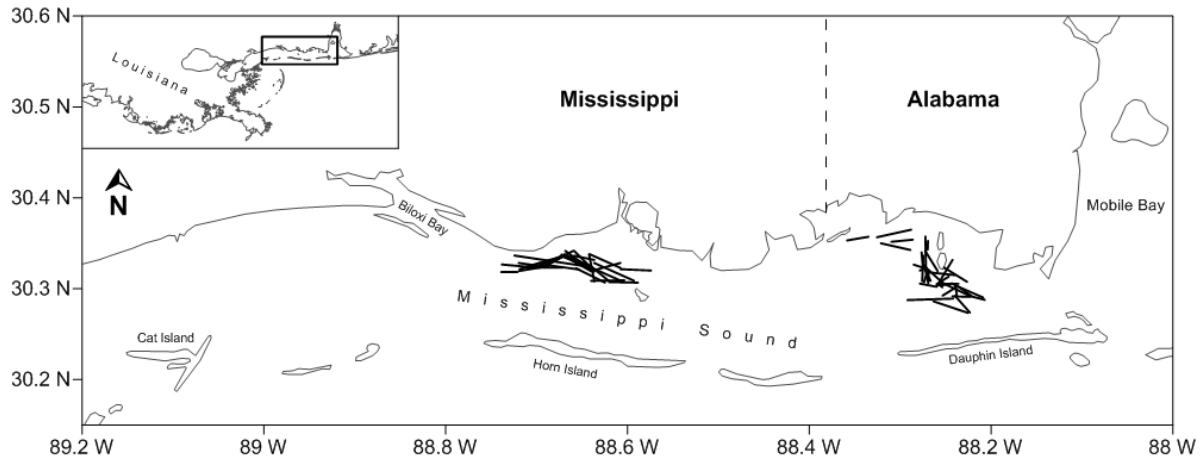


Figure 12.17 Skimmer trawl TED testing locations during 2009 in Mississippi and Alabama.

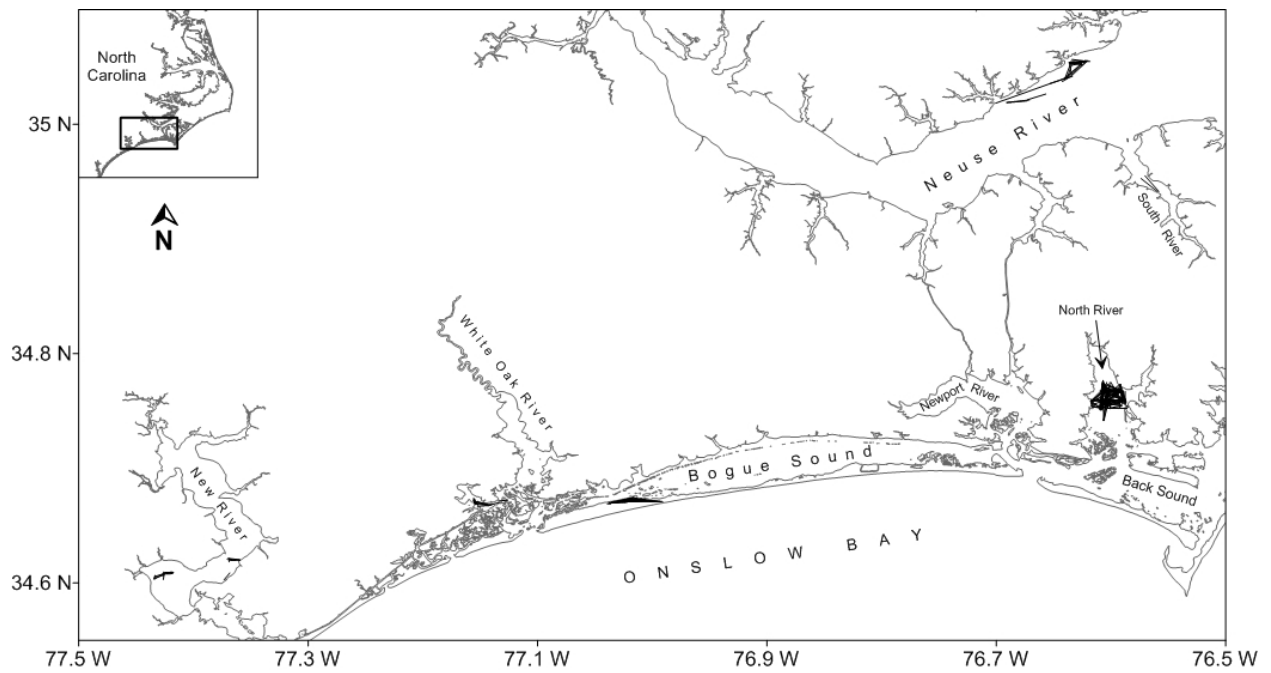


Figure 12.18 Skimmer trawl TED testing locations in 2010 in North Carolina.

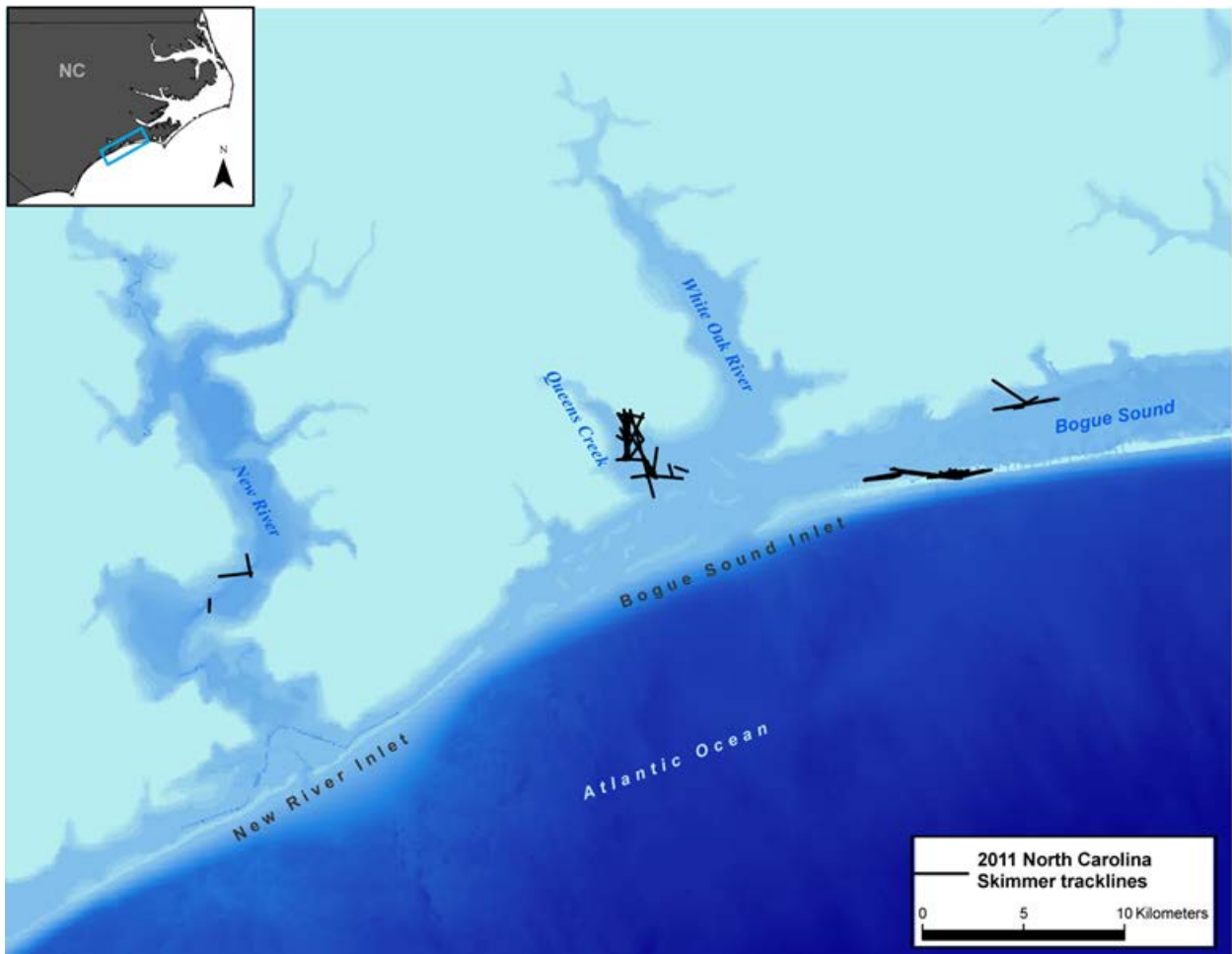


Figure 12.19 Skimmer trawl track lines in the 2011 NC skimmer trawl TED testing.

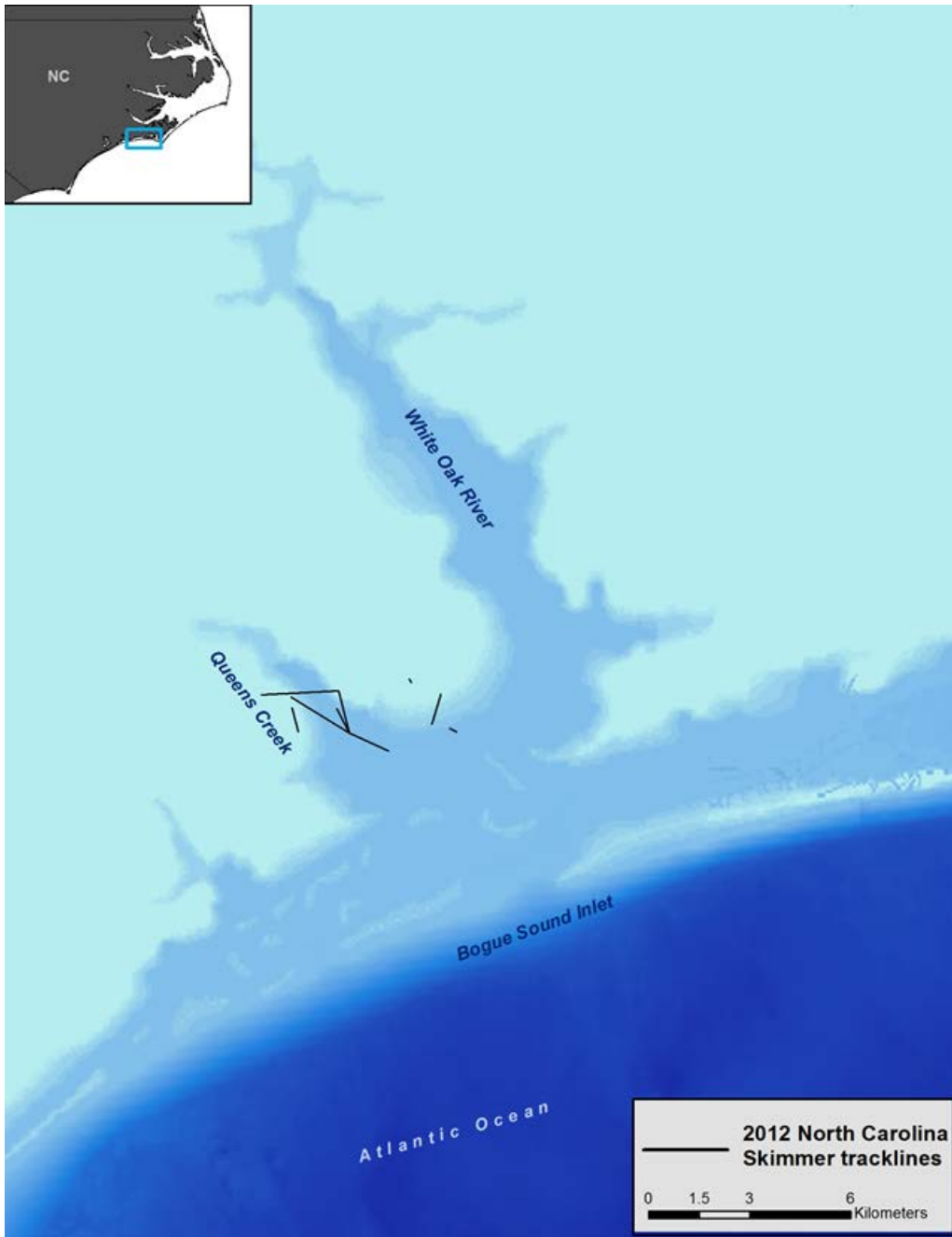


Figure 12.20 Trawl locations for Vessel 1 (TODC TED configuration) in the 2012 NC Skimmer Trawl TED testing.

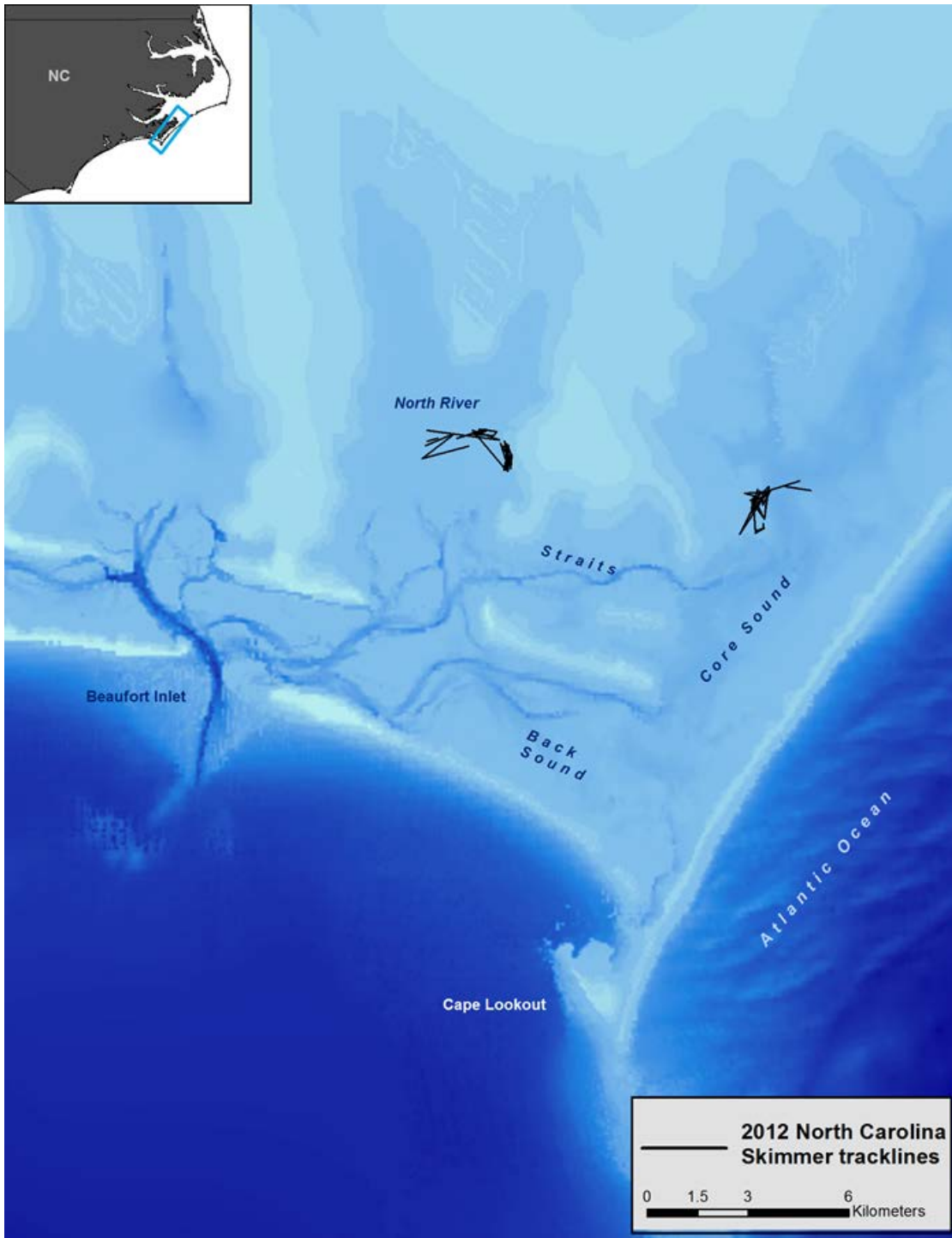


Figure 12.21 Trawl locations for Vessel 2 (BODC TED configuration) in the 2012 NC Skimmer Trawl TED testing.

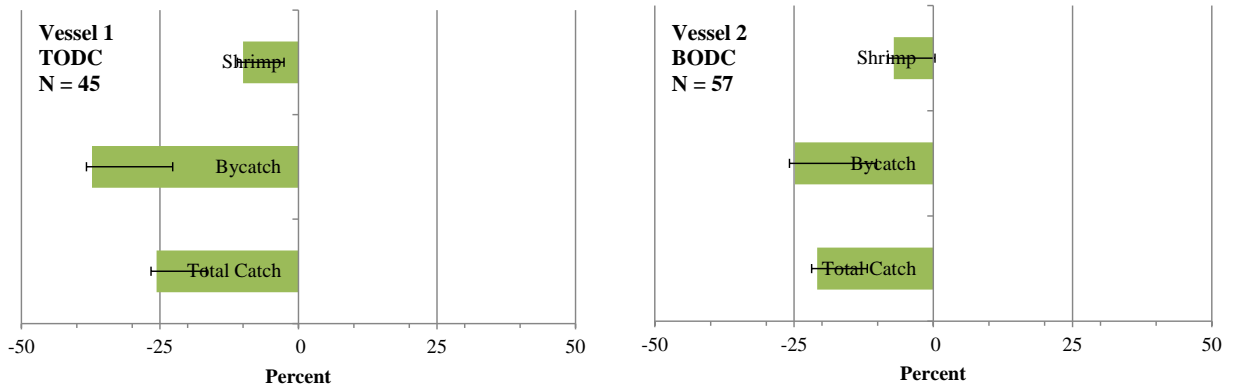


Figure 12.22 Percent difference for total catch, bycatch, and shrimp (kg) for each experimental TED type (TODC and BODC) in the 2012 NC skimmer trawl TED testing.

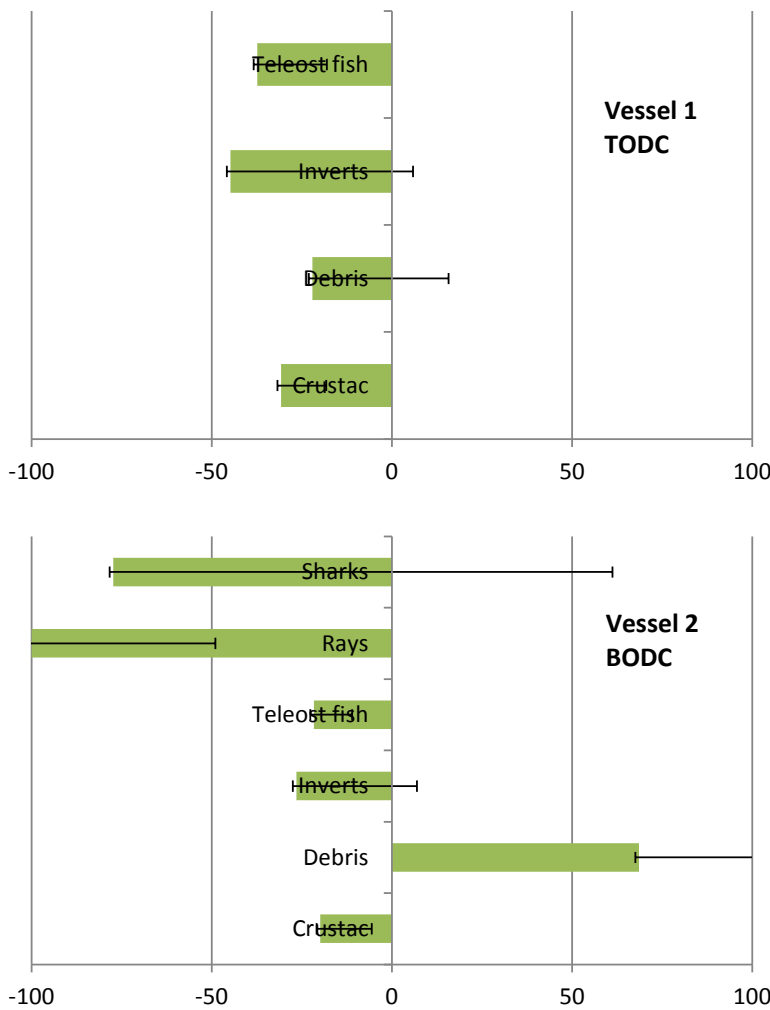


Figure 12.23 Percent difference for species groups by each experimental TED type (TODC and BODC) in the 2012 NC skimmer trawl TED testing.

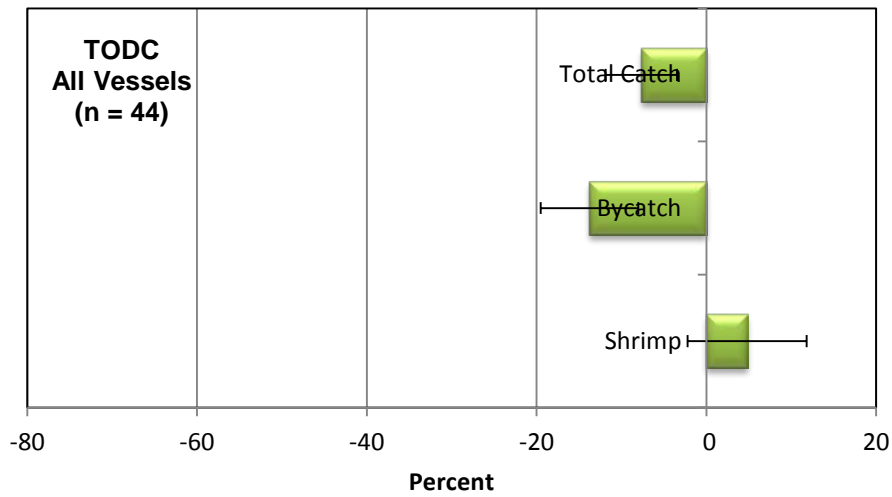
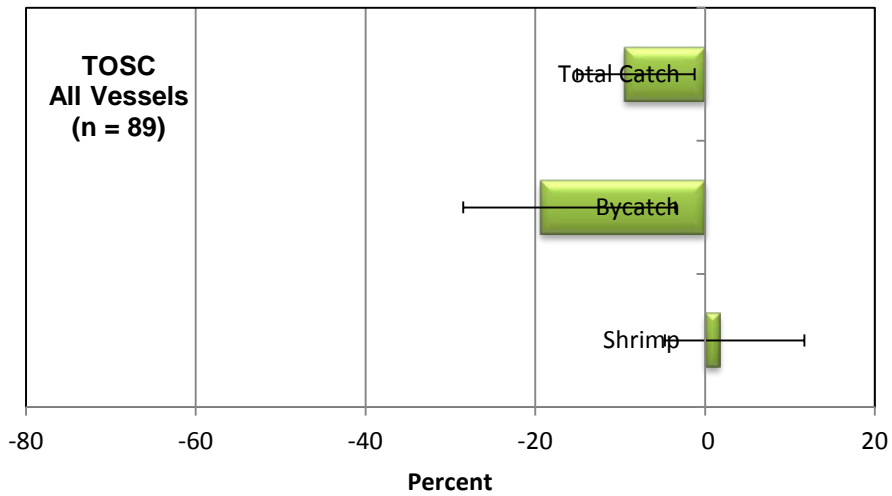
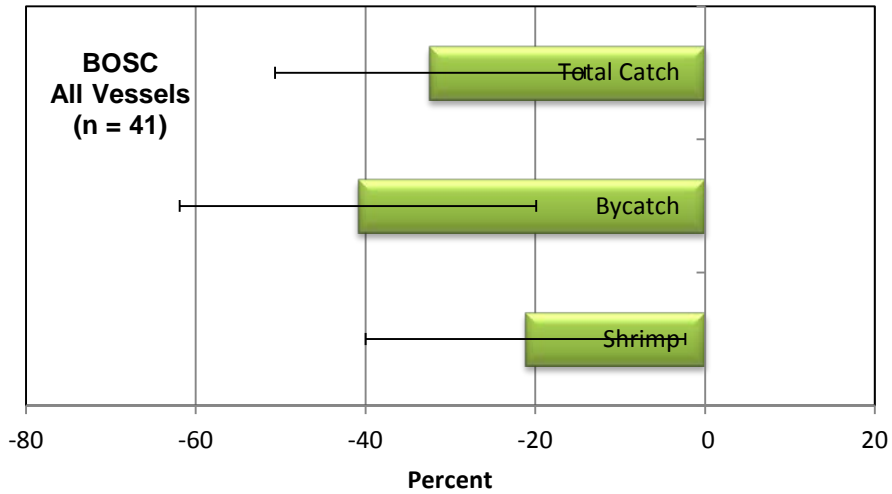


Figure 12.24 Percent difference for species groups by each experimental TED type (TOSC, BOSC, and TODC) in the 2011 LA skimmer trawl TED testing.

12.4 CONSIDERATION FOR A COMMERCIAL LIVE BAIT SHRIMP FISHERY IN NORTH CAROLINA

I. ISSUE

The exploration of the option of establishing a commercial live bait shrimp fishery in North Carolina

II. ORIGINATION

MFC Southern Regional Advisory Committee and the public

III. BACKGROUND

Management of the shrimp fishery in North Carolina is based on regional management and shrimp size. Regional management allows flexibility within areas and waterbodies because of regional differences. There are several criteria that are used to determine opening areas to shrimping and shrimp trawling including habitat, economic and social factors, user conflicts, bycatch issues and shrimp size. Shrimp grow at different rates depending on water temperature and salinity. As growth increases, shrimp migrate to deeper and saltier waters, and eventually move out to the ocean. Presently, the division manages shrimp based on count size, or number of shrimp per pound. For example, thirty-count means that for one pound of shrimp, there are 30 shrimp in that pound. Shrimp count size ranges from 80+ count shrimp to 10-15 count shrimp depending on the area.

Because North Carolina shrimp management is based on larger shrimp compared to the small bait size shrimp (60-80 count), waters will close if sampling indicates that there are small shrimp in the area. This then prohibits the harvest of those small shrimp for live bait by recreational and commercial harvest. However, when areas are closed, recreational and commercial fishermen are allowed to harvest two quarts per person with a cast net. Creating a live bait shrimp fishery in North Carolina may provide another economic opportunity for shrimpers and increase the value of smaller shrimp thus improving the overall value of the fishery.

At the Southern Advisory Committee in September 2012, a shrimper requested that committee consider a regulatory process for bait shrimping. The division's management for large shrimp causes the area where he shrimps to close due to the presence of small shrimp which he is targeting. He requested access to small shrimp over the weekends and access to areas that are closed by proclamation because of small shrimp.

Bycatch does occur in the smaller bait trawls but at net bycatch mortality is generally likely low due to short tow times, and culling times. However as temperatures increase, mortality usually increases as well.

IV. AUTHORITY

§ 113-134. Rules.

§ 113-182. Regulation of fishing and fisheries

§ 143B-289.2. Marine Fisheries Commission – powers and duties.

V. DISCUSSION

Live shrimp are popular bait for recreational fishermen targeting spotted sea trout and red drum as well as other popular recreational finfish. Currently, North Carolina does not manage shrimping for bait and fishermen harvesting shrimp as live bait must comply with current rules and proclamations that are in place for shrimp harvested for consumption. The number of pounds of live bait shrimp is recorded in the trip ticket program, as “numbers” and “dozens”. The number of pounds of live bait is low, ranging from 129 lb in 1994 to 2,074 lb in 2008 but is increasing over time along with the number of dealers reporting and the number of trips (Table 12.27). Value for this fishery is high compared to food shrimp with value increasing over time (Table 12.27). Value per pound has been, on average, between \$10.00 and \$15.00 a pound with an increase in 2011 at \$27.00 a pound. There is a steady number of fishermen participating in the fishery with over half the catches made from shrimp trawls (65%) followed by cast nets (12%), skimmer trawls (10%), and channel nets (5%). Seventy-two percent of the live bait shrimp landings come from the Cape Fear River, the Intracoastal Waterway, Stump and Topsail sounds. The division is unable to account for shrimp sold as dead bait because there are no data collected on the disposition of shrimp landings. All other states in the south Atlantic and Gulf manage for shrimp bait harvest.

Table 12.27 Number of Pounds of Live Bait Shrimp (dozens, numbers) 1994 through 2011.

Year	Number of Pounds	Number of Dealers	Number of Trips	Number of Participants	Value
1994	129	5	69	4	\$1,163
1995	204	11	85	8	\$1,834
1996	242	10	118	12	\$3,657
1997	249	8	130	10	\$2,627
1998	175	14	126	16	\$1,908
1999	418	11	60	10	\$1,252
2000	469	12	88	10	\$6,684
2001	266	8	150	11	\$4,338
2002	805	11	222	16	\$12,976
2003	1,027	12	201	17	\$25,758
2004	1,154	10	218	14	\$19,210
2005	921	14	178	15	\$7,843
2006	1,349	13	142	14	\$30,132
2007	909	14	134	14	\$14,009
2008	2,074	11	133	10	\$34,572
2009	1,652	15	249	14	\$22,942
2010	1,710	16	250	14	\$30,994
2011	1,923	17	279	10	\$52,673

South Carolina

A commercial trawler can sell shrimp for both bait and consumption with a land and sell license. Cast netters are restricted to 48 quarts and are limited 12 dozen shrimp dead or live

from December 16 to April 30. Dead Shrimp can only be sold by cast netters if they are caught in legal trawling areas (with all necessary licenses). These regulations were established to prohibit the sale of shrimp caught by shrimp baiting and “deep holing” where fishermen cast net shrimp without bait (Larry DeLancey, personal communication). Bait dealers who are harvest live shrimp to be sold as bait must have a bait dealer license, live bait tanks aboard the harvesting vessel with a compatible aeration system. They may not have any dead shrimp on board. Bait dealers must also be certified as a *bona fide* bait dealer and must have that certification in hand while harvesting live shrimp for bait.

Georgia

Commercial bait shrimping is open year round. Those that fish for shrimp for live bait to be sold and/or engage in the sale of shrimp for live or dead bait must possess a bait dealer license and personal commercial fishing license. Commercial bait fishermen may pull trawl nets up to 20 feet headrope length constructed of mesh smaller than one inch or greater than one and three-eighths inches when stretched. No bycatch reduction devices or turtle excluder devices are required in bait trawls. Harvest limits are no more than 50 quarts of shrimp at any one time with less than 10 percent dead. Fishing at night is not allowed. The Georgia Department of Natural Resources established bait zones in areas of rivers and creeks that are open for bait shrimp fishing. Fishing boats must maintain bait-holding facilities on the vessel.

Florida

Bait shrimping is allowed with roller trawls only with the exception of the Northeast Region where one trawl is allowed with 5/8 inch mesh in the body and 1/2 inch in the cod end. There are also live well requirements with vessels mandated to be equipped with tanks containing a minimum of 16 cubic feet of continuously aerated saline water during harvest and transport.

Alabama

Commercial bait shrimpers are allowed one trawl not to exceed 50 ft headrope length in open shrimp areas and one trawl not to exceed 16 ft headrope length in areas closed to commercial shrimping or in exclusive bait areas. Anyone engaged in taking, catching, transporting, or selling live bait and transporting dead bait must be in possession of a live saltwater bait dealer’s license. Exclusive bait areas are special areas opened each day from 4:00 a.m. to 10:00 p.m. Seasonal bait areas are those areas open to commercial and recreational taking of live bait when adjacent waters are closed. There are live well requirements. There is a maximum tow time of 20 minutes and harvest is limited to two standard shrimp baskets of live or dead shrimp.

Mississippi

Commercial bait shrimping is open year-round. Fishermen are allowed one trawl with no more than 25 ft headrope length, however there are some water bodies that have restrictions down to 16 ft headrope length. There is a tow time restriction of 25 minutes for bait trawls. Size limits are 100 count shrimp or lower and only daytime fishing is allowed. Fishermen can possess no more than 30 lb of dead shrimp. Major bays are closed but live bait may be taken in some bays. Mississippi requires a license for live bait catcher boats; these boats must be equipped with shaded holding tanks with aeration and water circulation.

Louisiana

Bait shrimp may be harvested at any time. During the closed shrimp season, bait shrimp can be harvested with cast nets less than 8.5 feet in radius, hand operated dip nets with a diameter not to exceed 3 feet, bait traps and bait seines less than 30 ft with a maximum mesh size of $\frac{1}{4}$ inch bar mesh that are manually operated on foot. A special bait dealer's permit is required to take live bait shrimp during the closed season beginning May 1 and between the spring and fall inshore shrimp season.

Texas

Texas requires a bait shrimp boat to be licensed and must operate only under commercial bait shrimp regulations. They may only fish in places authorized for bait shrimp and sell only to a bait shrimp dealer or sportsman. Bait shrimpers can possess only one trawl net with no more than a 54 ft headrope length. Bait shrimping is open year round with a 200 lb limit. From November to August, 50% of the shrimp must be alive and all heads must be attached August through November.

VII. EVALUATION MATRIX

AC Evaluation Matrix for Consideration for a Commercial Live Bait Shrimp Fishery in North Carolina

Impacted Group	Shrimp Fishery			Other Fisheries	Agency		Other Impacts
	Management Option	Bycatch Reduction Impact	Economic Impact	Social Impact	Inter-fishery Impact	Enforceability	
1. <i>Status quo</i>	Continues the existing amount of bycatch and bycatch mortality in the shrimp fishery. N	No change in market value of bait shrimp. N	Continues inflexibility for fishermen fishing for bait because management is for larger shrimp. -	Supplies hook and line fishermen with bait. N	Same level of enforcement. N	No rule change needed. N	Harvest of 2 quarts of shrimp with a cast nets in closed areas is allowed. Other means of catching shrimp 7 days a week exist. +/ N
2. Establish a permitted commercial live bait shrimp fishery with weekend access and access to areas closed by proclamation because of shrimp size.	Will increase the amount of bycatch in the shrimp fishery. Weekend access and areas closed to proclamation due to shrimp size (-) -	May increase economic value of smaller live shrimp used for bait. Possible cost to purchase a permit. Increase revenue to state. +	Will create conflict between food shrimp fishermen and bait shrimp fishermen. Increase in competition. Public may view as a step back in management. -	Supplies hook and line fishermen with bait. Increases accessibility to bait. +	May increase enforcement duties by increasing permit checks and inspections. Not evaluated	Will require the creation of a new permit with general and specific conditions by rule to establish a live bait shrimp fishery. Undermines current management by size in the Shrimp FMP. Not evaluated	Will require establishment of bait shrimping criteria to establish a fishery. Negates the weekend resting period. Not evaluated
3. <u>Establish a permitted commercial live bait shrimp fishery with weekend access.</u> This option added by the AC.	Will increase the amount of bycatch in the shrimp fishery. Not enough bycatch to cause an impact (N). Increase in effort could cause more bycatch (-) N/-	<u>May increase economic value of smaller live shrimp used for bait. Possible cost to purchase a permit. Increase revenue to state.</u> +	<u>Will create conflict between food shrimp fishermen and bait shrimp fishermen. Increase in competition. Public may view as a step back in management.</u> -	<u>Supplies hook and line fishermen with bait. Increases accessibility to bait</u> +	<u>May increase enforcement duties by increasing permit checks and inspections.</u> Not evaluated	<u>Will require the creation of a new permit with general and specific conditions by rule to establish a live bait shrimp fishery. Undermines current management by size in the Shrimp FMP.</u> Not evaluated	<u>Will require establishment of bait shrimping criteria to establish a fishery. Negates the weekend resting period.</u> Not evaluated

DMF Evaluation Matrix for Consideration for a Commercial Live Bait Shrimp Fishery in North Carolina

Impacted Group	Shrimp Fishery			Other Fisheries	Agency		Other Impacts
	Bycatch Reduction Impact	Economic Impact	Social Impact	Inter-fishery Impact	Enforceability	Authority/ Administrative	
1. <i>Status quo</i>	Continues the existing amount of bycatch and bycatch mortality in the shrimp fishery. -	No change in value of bait shrimp. N	Continues inflexibility for fishermen fishing for bait because management is for larger shrimp. -	Supplies hook and line fishermen with bait. +	Same level of enforcement. +	No rule change needed. +	Harvest of 2 quarts of shrimp with a cast nets in closed areas is allowed. Other means of catching shrimp 7 days a week exist. +
2. Establish a permitted commercial live bait shrimp fishery with weekend access and access to areas closed by proclamation because of shrimp size.	Will increase the amount of bycatch in the shrimp fishery. -	May increase economic value of smaller live shrimp used for bait. Possible cost to purchase a permit. +/-	Will create conflict between food shrimp fishermen and bait shrimp fishermen. Increase in competition. Public may view as a step back in management. -	Supplies hook and line fishermen with bait. +	May increase enforcement duties by increasing permit checks and inspections. -	Will require the creation of a new permit with general and specific conditions by rule to establish a live bait shrimp fishery. Undermines current management by size in the Shrimp FMP. -	Will require establishment of bait shrimping criteria to establish a fishery. Negates the weekend resting period. -

12.5 GEAR MODIFICATIONS IN NORTH CAROLINA SHRIMP TRAWLS TO REDUCE FINFISH BYCATCH

I. ISSUE

Reduce finfish bycatch in the North Carolina shrimp trawl fishery through gear modifications and Bycatch Reduction Devices (BRDs).

II. ORIGINATION

The public and Division staff (the Shrimp Fisheries Management Plan (FMP)) Plan Development Team (PDT), Advisory Committee (AC), and the North Carolina Marine Fisheries Commission (MFC).

III. BACKGROUND

Bycatch associated with the commercial shrimp trawl fishery remains a controversial and complex issue. There are few studies that attempt to quantify the impact of shrimp trawling on finfish populations primarily because the magnitude of discards is largely unknown. Even with the lack of data necessary to evaluate the impact of shrimp trawl bycatch, a good argument can be made that there is at minimal a resource management issue because finfish bycatch in shrimp trawls is so perceived as a problem by many in the public (Murray et al. 1992).

Policies at both the state and federal level have been adopted as conservation and management measures to minimize bycatch and bycatch mortality and incorporate that goal into management considerations (DMF 2006). At the federal level the gear technology certified by the Council for use in the penaeid shrimp fishery attempts to balance biological, ecological, and economic trades-offs by reducing finfish bycatch while minimizing shrimp loss. Amendment 6 to the South Atlantic Fishery Management Council (SAFMC) Shrimp FMP reviewed the status of the five species of greatest concern in the South Atlantic (weakfish, king mackerel, Spanish mackerel, Atlantic croaker and spot) and concluded that there is no evidence to indicate that the mortality of finfish caused by the shrimp trawl fleet (with TEDs implemented) is having a significant adverse effect on finfish stocks. This practicability analysis concluded that current management measures minimize bycatch and bycatch mortality to the extent practicable in the penaeid shrimp fishery.

A Bycatch Reduction Device (BRD) is any device, trawl modification, or a combination of devices in a shrimp trawl which reduces finfish and other bycatch (NOAA 2008). Extensive research on hundreds of BRDs and gear modifications has been conducted on both the state and federal levels in pursuit of these goals (Price, personal communication).

Summary of State BRD Testing

During the 1980s the NCDMF and National Marine Fisheries Service (NMFS) conducted studies on shrimp retention rates for various Turtle Excluder Devices (TEDs) (1985 – 1986 DMF unpublished data, and 1988 – 1989 NMFS unpublished data), and started work on identifying means to reduce finfish bycatch in the shrimp trawl fishery (Pearce et al. 1988; Holland 1988).

DMF began working both independently, using its own research vessel and other resources and in cooperation with industry to test various BRDs and gear modifications in 1992. Tests have been conducted in multiple waterbodies and seasons to attempt to encompass varying

environmental conditions. The goal of the testing was to find devices that maximized finfish reduction, minimized shrimp loss and met the requirements of Amendments of the Atlantic States Marine Fisheries Commission (ASMFC) Weakfish FMP (1985-1986 DMF unpublished data; McKenna 1993; Pearce et al. 1988; Brown 2010a).

Based on results obtained during development work DMF required all shrimp trawlers working in state waters to equip their nets with functional fish excluders in 1992, becoming the first state to do so. Amendment 2 of the ASMFC Weakfish FMP required all South Atlantic states (NC-FL) to implement management measures to achieve a 40% reduction by number in bycatch of weakfish in the shrimp trawl fisheries by 1996 (ASMFC 1996).

Although BRD testing has continued sporadically in North Carolina, no new devices have been identified that meet the weakfish reduction requirements. Currently the DMF allows five BRDs for use in state waters (SH-3-2012). Both federal and state certified BRDs are summarized in the attachment.

Florida Fish Excluders (FFEs) are the primary BRD employed in North Carolina state waters (NCDMF 2006; Brown 2009; and Brown 2010b). The 2006 FMP stated that over 80% of commercial and close to 100% of recreational shrimpers use the FFE. This high rate of use can be attributed to the fact that this is the only device that is certified for use in both NC state waters and the Exclusive Economic Zone (EEZ). However, the NCDMF specifications for the FFE are different than the federal specifications.

Its effectiveness in reducing weakfish and other fish species is a function of the size of the opening and placement. A minimum opening of 5 ½" X 6 ½" is required for the reduction of weakfish at the mandated level (DMF 2006). Placement in the tailbag is a function of the distance the gear is placed from the tailbag tie-off and general location in the net (top, side, or bottom). The distance from the tailbag tie-off is expressed as a ratio: BRD length/tailbag length where BRD length is equal to the distance from the tailbag tie-off to the opening of the FFE, and tailbag length is the length of the tailbag from the tie-off rings to the beginning of the tailbag (excluding any extension). To obtain a 40% value in weakfish reduction this ratio cannot exceed 0.68 (NCDMF 2006). Data collected during the development of FFEs indicated that maximum reduction of weakfish was obtained when the FFE was placed 15 meshes to the side of the tailbag (NCDMF 2006). While no data was collected, several fishermen did some preliminary testing of using two FFEs, but saw no benefit to bycatch reduction as compared to using one FFE (Mckenna 1993).

The "Sea Eagle" Fish Excluder showed 5% reduction in shrimp, 58% reduction in weakfish, 53% reduction in spot, 57% reduction in Atlantic croaker, and 54% overall finfish reduction (NCDMF 2006; Mckenna 1993).

The Large Mesh and Extended Funnel BRDs showed 2% reduction in shrimp by weight, 71% reduction in spot, 63% reduction in Atlantic croaker, 50% reduction in weakfish and an over 55% reduction in finfish (Mckenna 1993).

BRD Certification Procedures (See Attachment)

States are responsible for certifying BRDs for use in state waters. Procedures for certifying BRDs vary from state to state. Georgia is the only state that specifically addresses the use of federally certified BRDs in state waters by reference:

“Note: Any BRD certified by NMFS is allowable in Georgia waters. BRDs currently certified for use in federal waters are also described in Amendment 2 to the SAFMC Shrimp Management Plan” (Georgia 2012).

NMFS requires BRDs in shrimp trawl nets working in the federal waters of the Gulf of Mexico and within the Exclusive Economic Zone of the South Atlantic regions (50CFR Part 622 Appendix D).

In 2004 the preferred alternative for the certification of new BRD's in the Final Amendment 6 (2005) to the Fishery Management Plan (FMP) for the Shrimp Fishery of the South Atlantic Region recommended that for a new BRD to be certified, it must be statistically shown that the device can reduce the total weight of finfish by at least 30%. This created an inconsistency between the SAFMC Shrimp FMP and the ASMFC Weakfish FMP. Addendum III to Amendment 4 of the ASMFC weakfish plan changed BRD requirements to be consistent with Amendment 6 of the SAFMC Shrimp FMP by changing previous requirements from the 40% reduction in weakfish by number to 30% by weight for finfish. This allowed more flexible testing of BRDs, and allowed the South Atlantic Council to achieve an ecosystem approach in fisheries management. This new requirement allows the potential for new BRDs to be developed that have greater bycatch reduction rates than those currently in use.

Gear Modifications

One available management measure to reduce bycatch are gear modification requirements. Research should be directed at webbing/net design for bycatch reduction in trawls (NOAA 2006). The control of net selectivity is a preferred management tool in lieu of other more stringent regulations such as temporal and spatial closures, quotas, or limited entry. Most fishing gears are designed to provide some degree of passive discarding. To understand gear modifications that could potentially reduce unwanted bycatch, one must first understand the gear (Figure 12.25). Many net parameters have been tested to increase net performance (Harrington et al. 1988) and some modifications to these same parameters may provide bycatch reduction.

Potential gear modifications requirements that could reduce bycatch include: trawl door modifications (e.g., beam trawls, wing trawl system); net design (e.g., toplless trawls, Figure 12.26); modifications to tickler chains or footrope; mesh size, twine size/type; bycatch reduction devices (BRDs), sorting grids (e.g., nordmore grate, vonin flexi-grid); or turtle excluder device (TED) modifications to further reduce bycatch. Gear testing conducted by the DMF in 1986 on the effects of light vs. heavy footrope chains on 20 foot trawls showed that bycatch of flounder, and crabs was higher in a heavily chained net while there was no difference in shrimp catches (NCDMF 2006). Gear modifications that are easy to deploy, reduce bycatch, and maintain shrimp catch are more acceptable to the fishing industry than area or seasonal closures (Murray et al. 1992). Industry involvement in the development of these devices will most likely result in better designs and increased acceptance.

OTTER TRAWL COMPONENTS

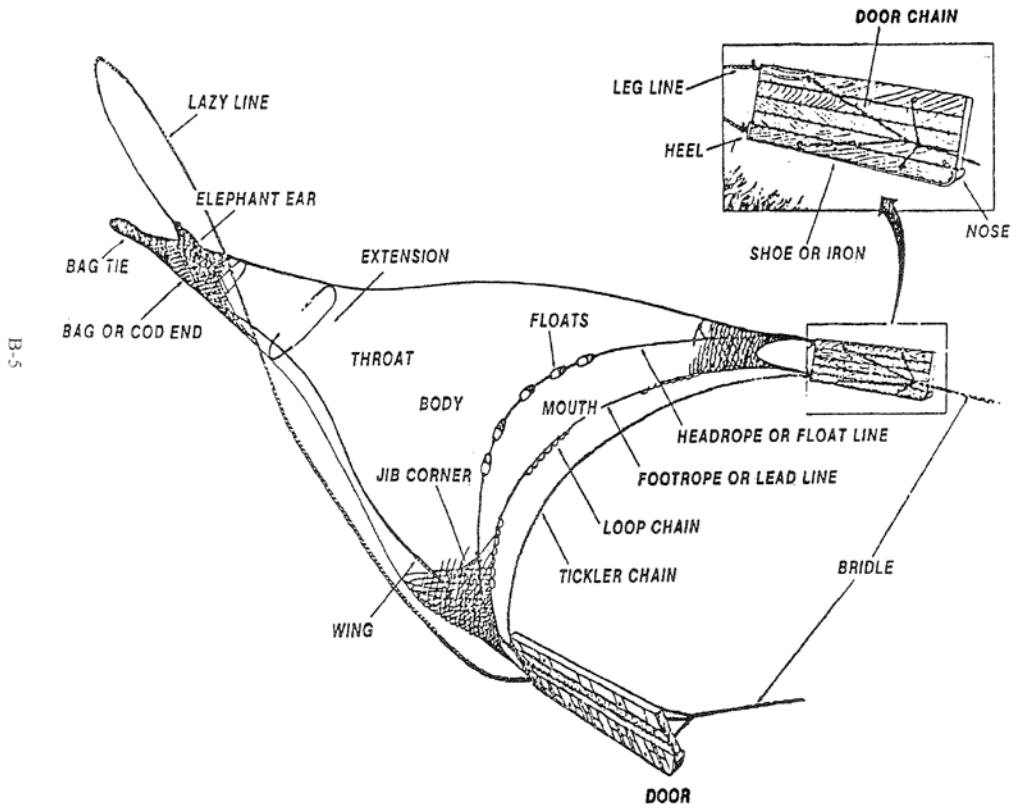


Figure 12.25 Diagram of typical otter trawl (NOAA 2008).

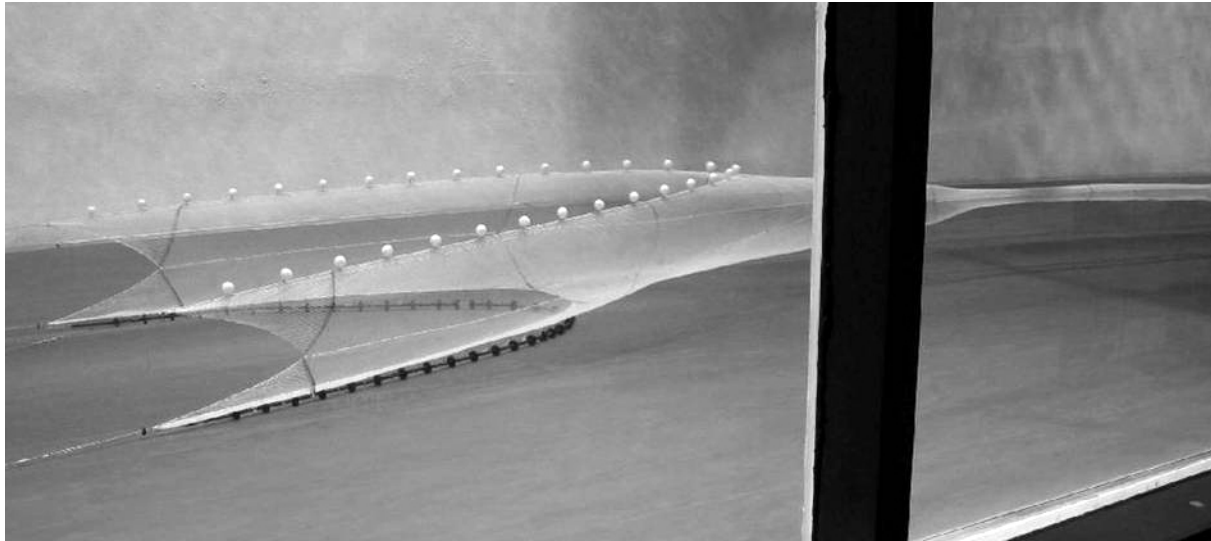


Figure 12.26 Topless trawl (Northeast Fisheries Science Center)

Tailbag Mesh Size

Currently, it is unlawful to take shrimp with trawl nets with stretch mesh lengths less than 1 ½ inches in North Carolina (15A NCAC 03L .0103).

Mesh size is often mandated by regulation to prevent the harvest of small sized animals. Trawl minimum mesh size regulations are the principal method used to regulate fishing mortality on fish stocks (Smolowitz 1983). The underlying principle of mesh size regulations is that undersized fish will escape from the tailbag, survive, and become part of the future spawning biomass. Studies on the survival of fish escaping from tailbags (Main and Sangster 1988) support the use of minimum mesh sizes as a means of reducing fishing mortality on juvenile fish. The possibility remains that not all fish that escape from the tailbag survive, resulting in some level of unobserved mortality. This unobserved mortality is a difficult issue for both managers and scientists because if it occurs, the actual reduction in bycatch and mortality is lessened. Furthermore, since gear escapees cannot be counted by conventional fishery observer programs, they cannot be monitored or included in stock assessment calculations. Chopin and Arimoto (1995) suggest that escapee mortality should be considered if gear-based measures are used as a primary management tool.

In 1949, the first studies on methods to reduce juvenile finfish bycatch in Pamlico Sound, North Carolina examined three mesh sizes of tailbags (2, 2 ¼, and 2 ½ inch). Spot were reduced 12%, 43%, and 50% in the 2, 2 ¼, and 2 ½ inch nets, respectively. Reduction rates for Atlantic croaker were 25%, 59%, and 38%. Shrimp reduction rates were 6%, 15%, and 9% in the 2, 2 ¼, and 2 ½ inch nets respectively (Roelofs 1950).

During July 1991, NCDMF conducted some preliminary tests on the culling efficiency of 2 tailbag sizes (2 inch stretch mesh and 1 5/8 inch stretch mesh) vs. a standard 1 ½ inch stretch mesh net. Five tows were made with each gear type and tow time was standardized to 1 hour. The 2 inch stretch mesh net reduced total finfish weight by 37%, spot weight by 46%, Atlantic

croaker by 22%, and shrimp weight increased by 7%. The 1 5/8 inch stretch mesh net fished similar to the 1 1/2 inch stretch mesh net and there was no apparent difference between the catches of the test and control net. However, not enough tows were made with either gear to test for significance.

NCDMF tested 5 experimental otter trawls in the Neuse River and Pamlico Sound, North Carolina from July 2008 to June 2009. One of those tests compared a standard 1 1/2 inch stretch mesh tail bag to a 1 3/4 inch stretch mesh tailbag. A total of 30 tows were made during this test, with tow times standardized to 1 hour. The total catch of shrimp by weight was virtually identical in both nets while total finfish weight was reduced by 32% in the 1 3/4 inch stretch mesh net. Atlantic croaker was reduced by 16% and spot was reduced by 50% by weight (Brown 2010a).

TEDs with reduced bar spacing

Federal regulations require all shrimp otter trawls to be equipped with TEDs and require the vertical bars in the TED to be no more than 4 inches apart (CFR 223.207(a)(4)). NCDMF adopts the federal regulations for TEDs by reference.

Some observations indicate that TEDs with bars spaced less than 4 inches were also successful at excluding other mega-fauna such as sharks, rays, and large fish. Two studies have investigated the effectiveness of using reduced bar spacing in TEDs as a BRD (Broome et al. 2011; Hataway 2010).

Hataway (2010) compared bycatch and shrimp rates of nets equipped with a TED with 2 inch bar spacing vs. a TED with 4 inch bar spacing on a commercial shrimp trawler. The study was conducted in the inshore waters of Mississippi and Louisiana from Horn Island, MS to Breton Sound, LA. The gear was tested in March, April, July, August, September, and October 2010. A total of 65 tows with a mean tow time of 2 hours and 12 minutes were conducted. Results indicate that the net equipped with a 2 inch (bar spacing) TED, reduced shrimp catch by nearly 9%, Atlantic croaker by 33%, and total finfish by nearly 50% (Hataway 2010).

Broome compared nets equipped with a TED with 2 inch bar spacing vs. a TED with 4 inch bar spacing in the near shore waters of North Carolina from Carolina Beach Inlet to Lockwood Folly Inlet. The gear was tested from September to December 2010. A total of 43 tows were conducted. This study concluded that the TED with the 2 inch reduced grid spacing is an effective way to reduce bycatch with minimal shrimp loss (Broome 2011).

T90 Tailbags and Skylight Panels

T90 refers to sections of nets or entire tailbags that are hung on the square, meaning that as the net is hung vertically the meshes will form squares. T90 tailbags and skylight panels use meshes hung on the square as BRDs. The square meshes do not collapse when being towed as do standard tailbags hung on the diamond. The open square meshes reduce drag on the net, and thus increases fuel efficiency and allows low water pressure areas, both of which allow for increased finfish escapement.

In 2000, the NCDMF conducted tests comparing a standard 1 1/2 inch stretch mesh tailbag hung on the diamond to a 1 1/2 inch stretch mesh T90 (hung on the square). The tests showed a significant reduction (51%) in the catch of young of the year weakfish in the T90 tailbag (NCDMF 2006).

DMF tested 5 experimental otter trawls in the Neuse River and Pamlico Sound, North Carolina from July 2008 to June 2009. Two of those tests compared a standard 1 ½ inch stretch mesh tail bag (hung on the diamond) to a 1 ¾ inch stretch mesh T90 tailbag (hung on the square) and a 2 inch stretch mesh T90 tailbag (hung on the square). A total of 30 tows were made during each test, with tow times standardized to 1 hour. Reductions in total weight of shrimp were 22% in the 1 ¾ inch stretch mesh T90 tailbag and 13% in the 2 inch stretch mesh T90 tailbag, however neither of these reductions were statistically significant. The reductions in total weight of bycatch in both T90 tailbags were statistically significant. Total finfish reduction was 61% and 57% in the 1 ¾ inch stretch mesh T90 tailbag and the 2 inch stretch mesh T90 tailbag, respectively. Atlantic croaker bycatch was reduced by 76% and 69% in the 1 ¾ inch T90 and 2 inch T90 tailbags. Spot was reduced by 77% and 82% in the 1 ¾ inch T90 and 2 inch T90 tailbags. Weakfish bycatch was reduced by 46% and 2% in the 1 ¾ inch T90 and 2 inch T90 tailbags (Brown 2010a).

Industry Involvement

In cooperation with personnel from the North Carolina Sea Grant, an industry gear advisory committee was established in 1989. The advisory committee was comprised of commercial and recreational fishermen, net makers, seafood dealers, and resource managers. The purpose of this committee was to act as consultants throughout the design and testing phase of a gear development project to reduce bycatch in the North Carolina trawl fisheries (Mckenna et al. 1992). The committee suggested two finfish excluding techniques: skylight panels and large mesh tailbags. Skylights were examined in a NCDMF pilot study in the summer of 1990 and two sizes of tailbags were examined during the summer of 1991.

Because of the regional importance of reducing bycatch in the shrimp trawl fishery, government agencies, private industry, and the Sea Grant College Programs, NMFS collaborated in extensive testing of trawl gear to assess optimal design and performance. Fishermen and net makers donated time and materials, NMFS divers were used to assess the gear underwater, and in the field. From this testing, a new class of trawl was developed, the tongue trawl (Harrington et al. 1988).

Industry involvement in the development of TEDs was crucial to their success. Lessons learned in the initial development of TEDs can be applied in the development of BRDs. Concerns of the environmental community were not seriously considered until the concerned groups became polarized. Much of the initial research was done without involvement and input from the industry. This lack of widespread involvement from the commercial industry resulted in fewer ideas for gear innovations and greater opposition to the program. Additionally, this resulted in site-specific problems associated with the gear not being discovered until the program was fully implemented (Murray et al. 1992).

IV. AUTHORITY

§ 113-134. Rules.

§ 113-182. Regulation of fishing and fisheries

§ 143B-289.2. Marine Fisheries Commission – powers and duties.

V. DISCUSSION

BRD Certification Procedures

State

Issues relating to modifying the current NCDMF BRD Certification Procedures, relate primarily to weakfish. In 1991 Amendment 1 to the Weakfish Fishery Management Plan (FMP) was adopted. This amendment recommended that South Atlantic states implement programs to reduce bycatch mortality of weakfish in their shrimp trawl fisheries by 40% by January 1, 1994.

Addendum III to Amendment 4 of the ASMFC weakfish plan was passed to make the weakfish plan consistent with SAFMC Shrimp Amendment 6 with regard to BRDs. Without modification to Weakfish Amendment 4, new BRDs certified for use in federal waters (using the 30% finfish definition) would not be certified for use in state waters. The weakfish plan which requires BRDs in state waters will still dictate how DMF can certify BRDs for use in state waters. North Carolina must abide by SAFMC's and ASMFC's requirements for BRD certification. In short, NMFS certification will have to be obtained for any future BRDs we approve for use in state waters (L. Paramore, personal communication).

Federal

The disconnect between the state and federally certified BRDs causes issues with shrimpers and net makers trying to comply with both sets of rules since many shrimpers fish in both state and federal waters. Allowing all federally certified BRDs to be used in North Carolina state waters would alleviate this.

DMF could by reference adopt for use in state waters any federally certified BRDs. This is done for TEDs. However, NC Marine Patrol does not support regulations that are by reference. It poses issues with officer and fishermen knowledge of the regulations, enforcement and upholding referenced regulations in a court of law (H. Knudsen, personal communication).

If it is decided to allow federally certified BRDs for use in state waters, all approved BRDs and descriptions would need to be included in the proclamation. Before updating the proclamation, DMF will have to verify which BRDs are federally certified and the requirements for use and installation in the net.

Another issue with adopting federally certified BRDs is that it is unlikely any significant reduction in bycatch would occur. The vast majority of shrimpers in North Carolina use the Florida Fish Excluder (Brown 2009; Brown 2010; NCDMF 2006). Most net makers and fishermen would likely just adapt their current FFE to federal regulations. One positive is that there would be little or no cost to do so for fishermen. There are reports of fishermen optimizing FFEs for shrimp retention reducing its effectiveness (NOAA 2004).

Gear Modifications

From the doors to the tailbag, various gear modifications can be made to potentially reduce bycatch. Nets are typically designed to keep finfish from escaping; in this case we want them to escape. Modifications to gear designed to reduce finfish bycatch and retain shrimp must take into consideration the various behaviors and characteristics of bycatch and target species. Differences in the biology and behavior of round fish, flatfish, and the three commercial shrimp species are often related to environmental influences such as tides, wind, and bottom type. Different net types have been developed to capitalize on the different behaviors of shrimp

species. Brown and pink shrimp are typically more active at night and are found in closer association with the bottom than white shrimp. When targeting pink and brown shrimp, fishermen are more concerned with the spread of the net rather than net height. Net height becomes more important when targeting white shrimp (Harrington et al. 1988).

Development of BRDs must be tested in many areas and over several seasons, since there is considerable variation in conditions both spatially and temporally. It is important to understand that the development of BRDs is a long process, and is dependent on a number of factors. The first step is to design and build the necessary modifications to the gear. Test prototypes and make adjustments until satisfied with the gear to be tested. To meet federal requirements of certifying BRDs it often takes 150 tows. That does not include calibration of the test and control nets or any tows made during initial testing. Often after testing a gear modification for bycatch reduction, alterations to the initial design are needed. Averaging three to five tows a day (practicing normal fishing operations); it would take 30 to 50 days of testing. If multiple industry boats were involved, each boat's contribution would be reduced. The boats would also be allowed to sell any marketable catch, further reducing the burden. That burden may be further mitigated on larger boats (four-barrel rigs) which would have three standard nets to the one test net with potential shrimp loss. It is possible to make a significant number of tows and realize the gear is not effective in reducing bycatch or has poor shrimp retention.

There is no one gear design or modification that will work in every situation. What works during the summer brown shrimp fishery may not be effective in the fall white shrimp fishery. The goal of gear researchers is to give the industry additional tools and techniques to use under various real life field situations.

A consideration with any state regulations concerning gear modifications is the limitation on certain environmental rules imposed by North Carolina General Statutes. Both the Department of Environment and Natural Resources (DENR) and the Marine Fisheries Commission (MFC) may not adopt a rule for the protection of the environment or natural resources that imposes a more restrictive standard, limitation, or requirement than those imposed by federal law or rule. There are exceptions to this statute, but currently none of those are met (G.S. 150B-19.3). The division is seeking clarification on the applicability of the statute to this issue.

The various gear modifications for current consideration as bycatch reduction devices discussed below are promising but all are in the early stages of testing. The division cannot recommend any of these be required until sufficient field test have been conducted.

Tailbag Mesh Size

Currently the minimum mesh size of trawl nets used to target shrimp in North Carolina is 1 ½ inch stretch mesh (15A NCAC 03L.0103). Increasing the minimum mesh size could decrease the amount of bycatch caught. Many shrimpers already use 1 ¾ inch stretch mesh (or larger) tailbags. However, there may be some shrimpers who target smaller shrimp due to market demands that would be adversely affected by regulations increasing the minimum mesh size allowed.

An individual tailbag costs approximately \$150-\$200. Shrimpers use between one and four of these per operation, depending on the rig type. Most shrimpers use two different net types throughout the season (two-seamed and tongue nets), and some fishermen may use additional net types. Shrimpers can change tailbags between net types, but most have dedicated tailbags for each net type. This could lead to some shrimpers needing eight to 12 new tailbags to meet

any new regulation of minimum mesh size. The impact of this cost could be minimized by allowing the industry a year or two to implement as gear typically requires replacement every few years.

TEDs with reduced bar spacing

In addition to reducing the incidental takes of sea turtles TEDs can also function as BRDs. Studies such as Hataway's (2010) and Broome's (2011) have shown minimal shrimp loss and significant finfish reduction using TEDs with reduced bar spacing. While the gear has been tested in the inshore waters of Mississippi and Louisiana and the near shore waters of North Carolina, it has not been tested in the inshore waters of North Carolina. NCDMF has applied for a Bycatch Reduction Engineering Program (BREP) grant that will test TEDs with both 2 inch and 3-inch spaced bars against a standard 4 inch spaced bar TED. Results from this study, if awarded will be available in late 2014.

The reduced bar spacing is effective in eliminating large sharks and rays, reducing risks of injury to deck hands. The gear is also effective at reducing jellyfish and is often referred to as "jelly ball shooters". Potential benefits of the reduced bar spaced TEDs include potential fuel savings by reducing unwanted bycatch in the tailbag, shorter culling times resulting from less bycatch, and a higher quality shrimp.

The industry has concerns with the effectiveness of this gear in the inshore waters of North Carolina. The concern relates to the weight of the TEDs causing the net to dig into the bottom (Mikey Daniels, personal communication). This concern could potentially be mitigated through additional floats on the TED or constructing TEDs out of lighter weight materials, but testing of this gear in the inshore waters of North Carolina is needed to determine that. Another concern is that the reduced bar spacing could result in the gear clogging up in areas and times of high grass and/or debris concentrations (Broome et al. 2011). There would likely be a reduction in marketable finfish from this gear.

The cost of a TED is approximately \$350. Shrimpers use between one and four of these per operation, depending on the type of rig per net type. Most shrimpers use two different net types throughout the season (two-seamed and tongue nets), and some fishermen may use additional net types. Shrimpers can change TEDs between net types, but most have dedicated TEDs for each net type. This could lead to some shrimpers needing eight to 12 new TEDs to meet any new regulation of TED bar spacing. The impact of this cost could be minimized by allowing the industry a year or two to implement as gear typically has to be replaced every few years.

A final consideration with any state regulations concerning TEDs is that currently, NCDMF adopts by reference federally certified TEDs and NCDMF's rules concerning TEDs cannot be stricter than the federal rules (G.S. 150B-19.3). Any state modification to the existing TED regulations would require a rule change (15A NCAC 03L.0103 (g)).

T90 Tailbags and Skylight Panels

T90 tailbags as well as other applications of square mesh panels (e.g., skylight panels) have been shown to be effective in reducing finfish bycatch in shrimp trawls and other trawl fisheries (Brown 2010a; Courtney et al. 2007). The meshes in T90 tailbags remain open allowing escapement of unwanted finfish, and are particularly good at allowing small fish to escape (Walker et al. 2010). The reduction in unwanted bycatch also allows the net to spread more than a full tailbag. The T90 tailbag is less likely to wobble than a standard tailbag, reducing

damage to targeted catch and allows the net to fish more efficiently (Figure 12.27). The open meshes allow water to flow through and reduce drag, increasing fuel efficiency (Knuckey et al. 2008). In contrast to other BRDs, the catch accumulates in the square mesh (T90) tailbag allowing small fish and other animals to escape after swimming a much smaller distance (Courtney et al. 2007).

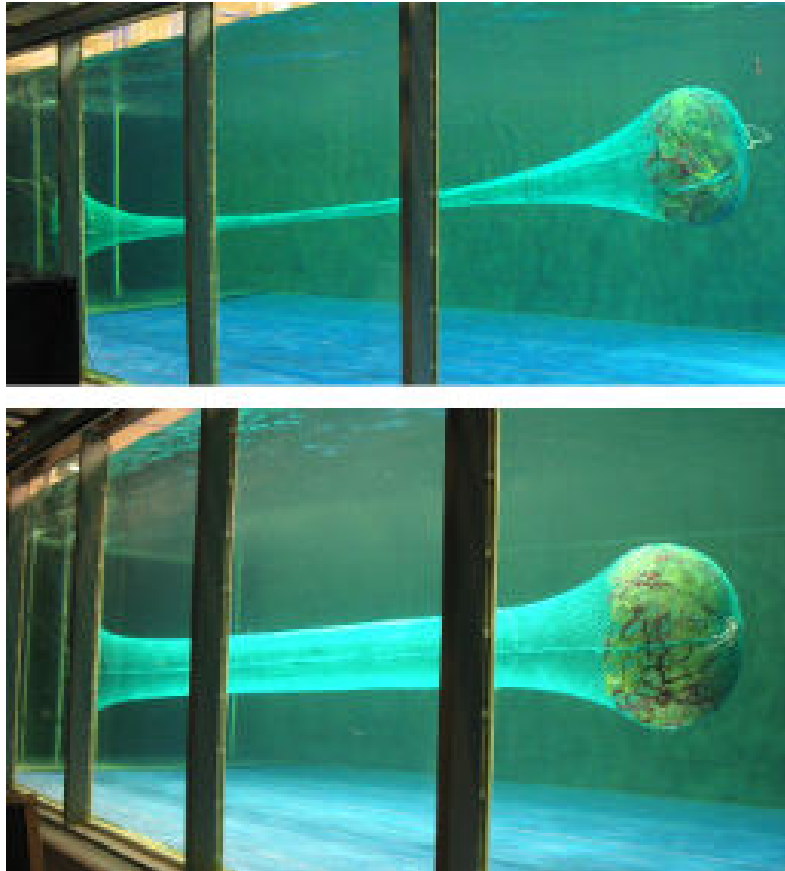


Figure 12.27 Standard trawl (top) and T90 trawl (bottom) (Knuckey et al. 2008).

Due to the way the tailbags are cut, square mesh tailbags produce more waste of webbing and are somewhat more difficult to hang than the traditional tailbag hung on the diamond. T90 tailbags would likely be 50% higher in cost than a traditional tailbag. Initial costs to transition to T90 tailbags could be mitigated by allowing the industry a year or two to come into compliance with any new regulations.

Tests conducted on two variations of this gear in North Carolina showed no statistically significant loss of shrimp (Brown 2010a). The reduction in shrimp that was observed was at least in part a reduction of small shrimp that are often culled anyway. Also, any reduction in shrimp catch could likely be made up due to the efficiency of the gear. There is reduced drag and because the tailbag is not being filled with unwanted bycatch, longer tows or bigger nets are possible.

Another concern with this gear is finfish “gilling” or “marshing” themselves in the open meshes. This was not observed during testing in 2008 and 2009 (Brown 2010a). There is concern from the industry that T90 tailbags will lose a lot of shrimp catch when the tailbag is very full. With reduced bycatch, the tailbag is not as likely to become full. This can also be mitigated with

reduced tow times, which would likely lower mortality of bycatch that is caught. There is some reluctance to use T90 tailbags because some fishermen believe that they are more likely to tear or the knots slip compared to the diamond-mesh netting when under strain (Walker et al. 2010). This emphasizes the need for continued studies, as even the age and wear of gear can affect its effectiveness.

T90 selector panels and T90 lengtheners have also shown potential as gear modifications that can potentially reduce bycatch (Walker et al. 2010). The state and industry should encourage the research and development of this gear modification. There are currently two such modifications being tested by the industry. A T90 ring (Figure 12.28) in two variations is being tested by Mikey Daniels (personal communication).



Figure 12.28 T90 extension constructed by Mikey Daniels.

Industry Involvement (Form an Industry Work Group/Further Research)

Industry involvement in the development of effective BRDs and gear modifications is vital. The fishermen are the ones who best understand how nets work, modifications that may help reduce bycatch while retaining shrimp, and ways to keep the BRDs practical and not cumbersome to use. Industry involvement in the development of effective TEDs was crucial to their success, both in terms of their effectiveness and of their acceptance. When the industry is involved in the development of gear modifications to reduce bycatch, they not only bring their expertise of nets but have ownership of the solution, which aids in the acceptance of new gear regulations. The industry is more likely to get behind new technologies or methodologies if they feel they have had a role and a financial stake in its development (NOAA 2006). Cooperative research programs between investigators and the industry are becoming more common.

Fishery managers should actively seek out industry involvement in identifying, developing, evaluating, and implementing BRDs and modifications to gear. This cooperation aids in information and knowledge transfer within the industry and government organizations. The development of an Industry Work Group that brings together net makers, fishermen, scientists, and other stakeholders could aid in the development of more effective BRDs and fishing

methods or practices. The team would act as consultants throughout the research, design, and testing phases of a gear and fishing method development project to reduce bycatch in the North Carolina shrimp trawl fishery. A similar team has been used by NCDMF in the past (Mckenna et al. 1992). Through such a group, NCDMF and the industry could promote, recognize, and encourage fishermen who make significant contributions to the effort to reduce bycatch.

Beyond the Industry Work Group, industry involvement could be useful in the development and testing of BRDs. Funding is often a limiting factor for gear development programs. The NCDMF has very limited resources to conduct BRD development testing. NCDMF has and will continue to seek outside funding to conduct this type of research, but the need for these outside sources of funding could be mitigated with industry involvement in the process. If industry stakeholders agreed to provide vessels, gear to test (NCDMF does have limited gear that could be used), and crew members to assist NCDMF staff with sampling, the burden on NCDMF's resources would be reduced to personnel and travel cost (which are still limited). The more members of industry involved the fewer burdens on each individual.

VII. EVALUATION MATRIX

AC Evaluation of Gear Modifications in Shrimp Trawls to Reduce Finfish Bycatch in North Carolina

Impacted Group	Shrimp Fishery			Other Fisheries	Agency		Other Impacts
	Management Option	Bycatch Reduction Impact	Economic Impact	Social Impact	Inter-fishery Impact	Enforceability	
1. <i>Status quo</i>	Continues the existing amount of bycatch and bycatch mortality in the shrimp fishery. -	No change in value of shrimp fishery. N	Allows flexibility of use of BRDs currently certified through the state but not the use of federally certified BRDs in the fishery. -	Commercial and recreational fishing will continue with no changes in gear use or conflict. N	Same level of enforcement. Not evaluated	No rule change required. Not evaluated	Allows for further characterization and bycatch reduction studies prior to new regulations. Not evaluated
2. Update and certify BRDs through the state BRD certification process	May result in decreased bycatch in the shrimp fishery through development of more effective BRDs in the future. No reduction in bycatch in the short term future. +	None in short term. May result in less fuel consumption, less culling time, bigger shrimp and more shrimp in the long term. Increase in gear cost. +/-	No change in short term. Allows flexibility of fishermen use of state certified BRDs but not the use of federally certified BRDs in the fishery. May gain public and industry support. -	Commercial and recreational fishing will continue with no changes in conflict. N	Minor increase in enforcement duties by increasing number/types of BRDs to enforce. Not evaluated	Can be accomplished by proclamation authority. Not evaluated	Is a lengthy process and would tie up division's resources. There are issues with weakfish criterion. Not evaluated
3. Allow federally certified BRDs	Most fishermen would likely adopt federal fisheye and would significantly reduce bycatch. +	May result in less fuel consumption, less culling time if switch to more efficient BRDs. Initial cost for changing BRDs. +/-	Allows flexibility of fishermen to use state and/or federally certified BRDs. May gain public and industry support. +	Commercial and recreational fishing will continue with no changes in conflict. N	Will increase enforcement duties by increasing the numbers/types of BRDs to enforce. Will require training of officer on new federal regulations allowed on fisheye and others. Not evaluated	Can be accomplished by proclamation authority. DMF would have to update proclamation periodically as federal specifications change. Not evaluated	May be issues with ASMFC concerning weakfish. Negates area specific testing by NCDMF to optimize fisheye for weakfish reduction. Not evaluated
4. Increase minimum tailbag mesh size	Potential decrease in bycatch. +	Impacts fishermen targeting small shrimp and bait fishery. Some cost to fishermen, can be mitigated over time. Potential reduction in catch. -	May gain public support. Industry view may be mixed. N	May cause conflict with those currently using smaller mesh. -	Same level of enforcement. Not evaluated	Will require a rule change. (03L. 0103(a)(1)) Not evaluated	There is a need for additional research. Not evaluated

AC Evaluation of Gear Modifications in Shrimp Trawls to Reduce Finfish Bycatch in North Carolina

Impacted Group	Shrimp Fishery			Other Fisheries	Agency		
Management Option	Bycatch Reduction Impact	Economic Impact	Social Impact	Inter-fishery Impact	Enforceability	Authority/ Administrative	Other Impacts
5.Require T90 Tailbags and/or skylight panel	Potential decrease in bycatch. +	Major cost to fishermen. Potential reduction in catch. Need replacing more often -	May gain public support. Industry view may be mixed. N	Commercial and recreational fishing will continue with no changes in conflict. N	Same level of enforcement with some additional training. Not evaluated	Will require a rule change. (03I .0101(3)(n)). Not evaluated	Is not currently federally certified or state certified. There is a need for additional research. Not evaluated
6.Require reduced bar spaced TEDs	Potential decrease in bycatch. +	Some cost to some fishermen based on bar spacing. Potential reduction in catch. Most expensive TED. -	May gain public support. Industry view may be mixed. N	Commercial and recreational fishing will continue with no changes in conflict. If RCGL required to have TEDs, may cause conflict. -	Same level of enforcement with some additional training. Not evaluated	Will require rule change (03L.0103(g)). State rule could be more restrictive than current federal regulations. Not evaluated	There is a need for additional research. Not evaluated
7. Initiate industry testing of BRDs and gear modifications and implement regulations based on findings	Potential decrease in bycatch through development of more effective BRDs and fishing methods in the future. +	Potential impact to fishermen in the long term due to costs associated with modifications and BRD requirements. -	Increased cooperation between stakeholders. Potential to encourage development. +	No initial change. Potential impacts dependent on findings. N	Same level of enforcement with potential of additional training. Not evaluated	Potential for rule changes. Not evaluated	Without a secure source of funding, progress could be minimal. Not evaluated
8.Convene Stakeholder Work Group	Potential decrease in bycatch through development of more effective BRDs and fishing methods in the future. +	Potential impact to fishermen in the long term due to costs associated with modifications and BRD requirements. -	Increased cooperation between stakeholders. Potential to encourage development. +	Commercial and recreational fishing will continue with no changes in conflict. +	No initial change. Could potentially impact future regulations. Not evaluated	Support structure of group not yet identified. Not evaluated	Opportunity to develop ongoing partnerships based on scope of the group. Not evaluated

DMF Evaluation of Gear Modifications in Shrimp Trawls to Reduce Finfish Bycatch in North Carolina

Impacted Group	Shrimp Fishery			Other Fisheries	Agency		
Management Option	Bycatch Reduction Impact	Economic Impact	Social Impact	Inter-fishery Impact	Enforceability	Authority/Administrative	Other Impacts
1. <i>Status quo</i>	Continues the existing amount of bycatch and bycatch mortality in the shrimp fishery. -	No change in value of shrimp fishery. N	Allows flexibility of use of BRDs currently certified through the state but not the use of federally certified BRDs in the fishery. -	Commercial and recreational fishing will continue with no changes in gear use or conflict. N	Same level of enforcement. N	No rule change required. +	Allows for further characterization and bycatch reduction studies prior to new regulations. +
2. Update and certify BRDs through the state BRD certification process	May result in decreased bycatch in the shrimp fishery through development of more effective BRDs in the future, if fishermen embrace the use of more effective BRDs. No reduction in bycatch in the short term future. +	None in short term. May result in less fuel consumption, less culling time, bigger shrimp and more shrimp in the long term. +	No change in short term. Allows flexibility of fishermen use of state certified BRDs but not the use of federally certified BRDs in the fishery. May gain public and industry support. +	Commercial and recreational fishing will continue with no changes in conflict. N	Minor increase in enforcement duties by increasing number/types of BRDs to enforce. N	Can be accomplished by proclamation authority. +	Is a lengthy process and would tie up division's resources. There are issues with weakfish criterion. -
3. Allow federally certified BRDs	Most fishermen would likely adopt federal fisheye and would not significantly reduce bycatch. May reduce bycatch if fishermen switch to more efficient BRDs. +/-	Little to no cost for fishermen, particularly those staying with fisheye. May result in less fuel consumption, less culling time if switch to more efficient BRDs. Initial cost for changing BRDs. +/-	Allows flexibility of fishermen to use state and/or federally certified BRDs. May gain public and industry support. +	Commercial and recreational fishing will continue with no changes in conflict. N	Will increase enforcement duties by increasing the numbers/types of BRDs to enforce. Will require training of officer on new federal regulations allowed on fisheye and others. -	Can be accomplished by proclamation authority. DMF would have to update proclamation periodically as federal specifications change. N	May be issues with ASMFC concerning weakfish. Negates area specific testing by NCDMF to optimize fisheye for weakfish reduction. -
4. Increase minimum tailbag mesh size	Potential decrease in bycatch. +	Impacts fishermen targeting small shrimp. Some cost to fishermen, can be mitigated over time. Potential reduction in catch. -	May gain public support. Industry view may be mixed. +/-	May cause conflict with those currently using smaller mesh. -	Same level of enforcement. +	Will require a rule change. (03L. 0103(a)(1)) -	There is a need for additional research. -

DMF Evaluation of Gear Modifications in Shrimp Trawls to Reduce Finfish Bycatch in North Carolina

Impacted Group	Shrimp Fishery			Other Fisheries	Agency		
Management Option	Bycatch Reduction Impact	Economic Impact	Social Impact	Inter-fishery Impact	Enforceability	Authority/ Administrative	Other Impacts
5.Require T90 Tailbags and/or skylight panel	Potential decrease in bycatch. +	Some cost to fishermen, can be mitigated over time. Potential reduction in catch. /may result in less fuel consumption +/-	May gain public support. Industry view may be mixed. +/-	Commercial and recreational fishing will continue with no changes in conflict. N	Same level of enforcement with some additional training. N	Will require a rule change. (03I .0101(3)(n)). How is it measured now? -	Is not currently federally certified or state certified. There is a need for additional research. -
6.Require reduced bar spaced TEDs	Potential decrease in bycatch. +	Some cost to fishermen, can be mitigated over time. Potential reduction in catch. -	May gain public support. Industry view may be mixed. +/-	Commercial and recreational fishing will continue with no changes in conflict. N	Same level of enforcement with some additional training. N	Will require rule change (03L.0103(g))). State rule could be more restrictive than current federal regulations. -	There is a need for additional research. -
7. Initiate industry testing of BRDs and gear modifications and implement regulations based on findings	Potential decrease in bycatch through development of more effective BRDs and fishing methods in the future +	Potential impact to fishermen in the long term due to costs associated with modifications and BRD requirements -	Increased cooperation between stakeholders. Potential to encourage development. +	No initial change. Potential impacts dependent on findings. N	Same level of enforcement with potential of additional training. N	Potential for rule changes. SEC Permit structure in place. +/-	Without a secure source of funding, progress could be minimal. -
8.Convvene Bycatch Reduction Workgroup	Potential decrease in bycatch through development of more effective BRDs and fishing methods in the future. +	Potential impact to fishermen in the long term due to costs associated with modifications and BRD requirements. -	Increased cooperation between stakeholders. Potential to encourage development. +	Commercial and recreational fishing will continue with no changes in conflict. N	No initial change. Could potentially impact future regulations. N	Support structure of group not yet identified. -	Opportunity to develop ongoing partnerships based on scope of the group. +

ATTACHMENT

Summary of BRD Certification Procedures

State

The DMF developed BRD certification procedures in the 1990s and Proclamation SH-3-2012 has a special provision that allows persons to test BRD designs.

The following summarizes the current DMF BRD certification procedures (DMF procedures):

The fisherman must submit a design that to DMF for initial evaluation by a gear review panel. This panel is made up of one net maker, a Sea Grant representative, and the DMF gear biologist. If the design is approved, the fisherman will be issued a permit valid for two weeks to test the device. After the two week trial, the fisherman can request a two week extension for additional tuning and testing, request DMF staff to accompany them for final testing, or inform DMF that the device was ineffective.

Certification testing must meet minimum requirements for methodology including net calibration, and the presence of an observer for and data collection. Nets must be switched between sides after every day. At least 30 tows are required for final certification. When the fisherman requests that DMF personnel accompany him/her for final BRD certification then the fisherman is responsible for all costs (except DMF time), and must help in sampling the catches.

For a new BRD to be certified by the DMF it must reduce the bycatch of weakfish by 50% by numbers, reduce total finfish bycatch weight by 45%, and show minimal shrimp loss. For the device to be certified in the EEZ the device must also show a 40% reduction in the number of Spanish mackerel. The data collected will be reviewed by the gear review panel, and their recommendation will be forwarded to the Director of the DMF. If approved by the Director, the recommendations will be forwarded to the ASMFC Weakfish Management Board for their approval. If the ASMFC approves the BRD a new proclamation will be issued allowing the use of the new gear.

Federal

The procedures for federal certification of BRDs are similar to that of DMF, with some notable differences (NOAA 2008).

Fishermen may need to test BRDs for use in state waters with state officials, but for the data collected in such evaluations to be considered by National Oceanic and Atmospheric Administration (NOAA) Fisheries Service for certifications, the operations plan and data collection procedures must meet criteria found in NOAA's Bycatch Reduction Device Testing Manual (NOAA 2008).

A BRD candidate must apply for a Letter of Authorization (LOA), which includes a brief statement of the purpose and goal of activity, diagrams and descriptions of the gear to be tested, and an operations plan describing the scope, duration, methods, and locations of the test. Pre-certification tests can be conducted to assess the preliminary effectiveness of a prototype. No observer is required during pre-certification. For certification testing, testing must meet minimum requirements of methods, calibration of nets, data collection conducted by an observer. A minimum sample size of 30 tows is required for statistical analysis, using

appropriate statistical procedures such as Bayesian analyses (NOAA 2008). However in practice, the standards for certification often take between 100-150 tows (Hataway, pers comm). It is the responsibility of the applicant to ensure that a qualified observer is on board during certification tests.

To be certified for use in the southeastern shrimp fisheries, data collected under a standardized sampling procedure must demonstrate a 30% reduction in finfish biomass (Federal Register 50 CFR Part 622). It should be noted that this criterion was recently changed; previously there was a requirement to reduce red snapper by 50% and Spanish mackerel by 40%, but citing difficulties in obtaining significant results on specific species that may be seen in very low abundances, these criterion were removed (Hataway, pers comm).

The BRD candidate must also meet to the following conditions to be certified:

1. There is at least a 50-percent probability that the true reduction rate of the BRD candidate meets the bycatch reduction criterion.
2. There is no more than a 10-percent probability that the true reduction rate of the BRD candidate is more than 5 percentage points less than the bycatch reduction criterion.

There is also a provisional certification (allowing further tuning and testing) that is effective for 2 years and is based on the following condition:

1. There is at least a 50-percent probability that the true reduction rate is no more than 5 percentage points less than the bycatch reduction criterion.

Certified BRDs

State

The DMF currently allows the following BRDs to be used in state waters (SH-3-2012):

- Florida Fish Excluders (FFE) can be either diamond shaped measuring at least 5 ½ inches X 6 ½ inches or 6 inches X 6 inches (inside measurement) or oval shaped measuring 9 inches by 5 inches and must be positioned no more than 19 meshes from the top centerline of the tailbag and located no more that 65% up from the tailbag tie-off rings
- Eight inch PVC “Sea Eagle” Fish Excluder is a circular excluder constructed of PVC positioned no more than 15 meshes from the top centerline and no more than 38% up from the tailbag tie-off.
- Large Mesh and Extended Funnel BRDs: These devices consist of a funnel of small mesh netting within a cylinder of large mesh netting, held open by one semi-rigid hoop.
 - General ten inch and eight inch large mesh and extended mesh funnel BRD
 - Eight inch and ten inch inshore large mesh and extended funnel BRD
- Large Mesh Funnel Excluder (LMFE): This device consists of a funnel of small mesh netting within a cylinder of larger mesh netting, held open by two semi-rigid hoops.

A single test trawl (try net), channel nets, float nets, fixed nets, and butterfly nets are exempted from required BRDs.

Federal

BRDs currently certified for use in the federal waters of the Gulf of Mexico and within the Exclusive Economic Zone (EEZ) of the South Atlantic regions (50CFR Part 622 Appendix D) include:

- **Extended Funnel:** The extended funnel BRD consists of an extension with large mesh webbing in the center and small mesh webbing on each end held open by a semi-rigid hoop. A funnel of small mesh webbing is placed inside the extension to form a passage for shrimp to the cod end. It also creates an area of reduced water flow to allow for fish escapement through the large mesh. One side of the funnel is extended vertically to form a lead panel and area of reduced water flow. There are two sizes of extended funnels BRDs, a standard size and an inshore size for small trawls.
- **Expanded Mesh.** The expanded mesh BRD is constructed and installed exactly the same as the standard size extended funnel BRD, except that one side of the funnel is not extended to form a lead panel.
- **Fisheye.** The fisheye BRD is a cone-shaped rigid frame constructed from aluminum or steel rod of at least ¼ inch diameter, which is inserted into the cod end to form an escape opening. Minimum escape opening of 5 inches. In gulf EEZ it must be installed top center no further forward than 9 feet from the cod end drawstring (tie-off rings), in South Atlantic EEZ must be installed top center no further forward than 11 feet from the tie-off rings.
- **The Gulf fisheye BRD** is a cone-shaped rigid frame constructed from aluminum or steel rod of at least ¼ inch diameter, which is inserted into the top center of the cod end, and is, offset not more than 15 meshes perpendicular to the top center of the cod end to form an escape opening.
- **The Jones-Davis BRD** is similar to the expanded mesh and the extended funnel BRDs except that the fish escape openings are windows cut around the funnel rather than large mesh sections. In addition, a webbing cone fish deflector is installed behind the funnel.
- **Modified Jones-Davis BRD** is a variation to the alternative funnel construction method of the Jones-Davis BRD except the funnel is assembled by using depth-stretched and heat-set polyethylene webbing instead of the flaps formed from the extension webbing. In addition, no hoops are used to hold the BRD open.
- **Cone Fish Deflector Composite Panel BRD** is a variation to the alternative funnel construction method of the Jones-Davis BRD, except the funnel is assembled by using depth-stretched and heat-set polyethylene webbing with square mesh panels on the inside instead of the flaps formed from the extension webbing. In addition, no hoops are used to hold the BRD open.
- **Square Mesh Panel (SMP) Composite Panel** is a panel of square mesh webbing placed in the top of the cod end to provide finfish escape openings.

12.6 EFFORT MANAGEMENT FOR BYCATCH REDUCTION IN THE NORTH CAROLINA SHRIMP TRAWL FISHERY

I. ISSUE

An examination of using time and seasonal restrictions in the shrimp trawl fishery to reduce bycatch in coastal fishing waters

II. ORIGINATION

The public and Division staff

III. BACKGROUND

A primary component of the management in the 2006 Shrimp Fishery Management Plan is the management of the shrimp fishery by waterbody and by size. Typically, creeks and tributaries of the larger rivers and sounds are closed at the beginning of the year to protect small shrimp and finfish and are opened up during July when they are larger and more valuable. However in the Southern District, areas such as the Intracoastal Waterway (IWW) may remain open until June when small brown shrimp arrive. Special Secondary Nursery Areas (SSNA) open in August and October (Core Sound) when shrimp are larger and the majority of small finfish have migrated out. There are four existing time restrictions used in current shrimp management. There is the weekend closure to shrimp trawling except in the ocean, a nighttime closure to trawling in the ocean off Brunswick County, a nighttime closure to trawling in New River when it is opened between August 16 and November 30, and finally, SSNAs can only be opened to shrimp trawling from August 16 to May 14 each year.

Although shrimp effort varies annually with the abundance of shrimp, overall effort in the estuarine shrimp fishery has steadily declined in recent years in terms of number of trips and number of participants (Table 12.28 and Table 12.29). Otter trawl effort has decreased over time from a high of 15,482 trips in 1995 to a low of 3,004 trips in 2011. Skimmer trawl effort peaked in 2002 at 3,565 trips but has since decreased to 327 trips in 2011. Channel nets show a similar decrease from 2,589 trips in 1999 to a low of 531 trips in 2011. Participation in the estuarine shrimp fishery has decreased in the otter trawl, skimmer trawl and channel net fisheries. Cast net and shrimp pound net participation has been variable over time with no apparent trends. With the exception of one year, shrimp pound information is confidential (less than three dealers reporting). Otter trawl participation was the highest with 888 participants in the fishery in 1995. The fishery has experienced low participation for the last several years with a 66% decline to 301 participants in 2011. Skimmer trawl participation was the highest in 2000 with 180 participants but similar to otter trawls it has dropped 83% to 31 participants in 2011. Channel nets have also shown a steady decline in participation dropping 77% from 176 participants in 1995 to 40 participants in 2011.

Table 12.28 Number and average pounds, trips, and value in otter trawls, skimmer trawls, channel nets, cast nets and pound nets in state estuarine waters, 1994-2011.

Year	Otter Trawl			Skimmer Trawl			Channel Net			Cast Net			Shrimp Pound		
	Pounds	Trips	Value	Pounds	Trips	Value	Pounds	Trips	Value	Pounds	Trips	Value	Pounds	Trips	Value
1994	5,240,153	14,585	\$13,797,757	203,866	1,118	\$382,118	185,585	2,109	\$402,539	236	15	\$566	0	0	\$0
1995	5,729,152	15,482	\$13,759,068	424,181	1,563	\$760,945	272,892	2,279	\$568,260	1,266	36	\$2,645	1,680	13	\$4,226
1996	3,055,860	11,008	\$7,809,425	188,666	1,179	\$439,670	198,653	1,473	\$454,963	637	51	\$1,769	**	**	**
1997	4,911,799	12,702	\$12,958,128	339,056	2,203	\$763,231	191,188	2,088	\$459,963	70	36	\$380	**	**	**
1998	2,019,600	8,297	\$4,473,965	179,387	1,058	\$375,854	181,915	1,864	\$399,726	620	50	\$1,587	0	0	\$0
1999	5,275,158	10,817	\$12,928,539	599,465	2,080	\$899,582	284,257	2,589	\$571,077	4,936	63	\$5,600	0	0	\$0
2000	7,847,702	10,521	\$19,585,614	624,010	2,429	\$1,087,923	260,321	2,168	\$621,181	928	71	\$2,582	0	0	\$0
2001	3,493,218	7,734	\$8,506,491	314,994	1,765	\$497,427	185,277	1,623	\$394,717	289	140	\$2,316	0	0	\$0
2002	7,511,154	10,030	\$14,159,626	831,511	3,565	\$1,136,668	250,656	1,865	\$436,803	386	161	\$5,131	**	**	**
2003	3,179,629	6,682	\$6,011,535	475,582	2,535	\$714,348	255,892	1,697	\$420,083	271	105	\$7,822	0	0	\$0
2004	2,581,743	5,358	\$5,523,421	377,173	2,097	\$529,413	149,933	1,351	\$228,586	142	115	\$2,334	0	0	
2005	1,078,088	2,890	\$2,016,414	176,928	1,101	\$263,381	130,710	865	\$187,292	116	82	\$1,087	**	**	**
2006	2,891,435	3,255	\$5,059,891	686,475	1,344	\$590,720	181,102	897	\$227,972	41	20	\$635	637	9	\$907
2007	7,123,976	4,465	\$13,595,395	586,700	1,556	\$672,596	165,729	954	\$272,177	740	11	\$1,398	**	**	**
2008	6,764,108	4,206	\$13,516,404	365,331	935	\$432,017	253,530	1,101	\$336,822	531	16	\$1,184	**	**	**
2009	4,049,599	3,890	\$6,452,588	181,458	807	\$173,889	180,704	1,084	\$195,984	218	65	\$1,837	**	**	**
2010	4,280,703	3,946	\$7,649,074	284,972	1,095	\$384,020	129,865	1,063	\$182,808	126	37	\$1,321	**	**	**
2011	3,889,637	3,004	\$8,178,854	55,576	327	\$93,420	97,908	531	\$107,651	231	64	\$3,187	**	**	**
Average	4,495,706	7,715	\$9,776,788	383,074	1,598	\$566,512	197,562	1,533	\$359,367	655	63	\$2,410	257	2	\$642

**Confidential

Table 12.29 Number and pounds, trips, and participants in otter trawls, skimmer trawls, channel nets, cast nets in state estuarine waters, 1994-2011.

Year	Otter Trawl			Skimmer Trawl			Channel Net			Cast Net		
	Pounds	Trips	Participants	Pounds	Trips	Participants	Pounds	Trips	Participants	Pounds	Trips	Participants
1994	5,240,153	14,585	845	203,866	1,118	79	185,585	2,109	148	236	15	4
1995	5,729,152	15,482	888	424,181	1,563	128	272,892	2,279	176	1,266	36	14
1996	3,055,860	11,008	705	188,666	1,179	102	198,653	1,473	126	637	51	7
1997	4,911,799	12,702	722	339,056	2,203	143	191,188	2,088	136	70	36	6
1998	2,019,600	8,297	513	179,387	1,058	92	181,915	1,864	113	620	50	8
1999	5,275,158	10,817	667	599,465	2,080	155	284,257	2,589	120	4,936	63	8
2000	7,847,702	10,521	793	624,010	2,429	180	260,321	2,168	122	928	71	12
2001	3,493,218	7,734	553	314,994	1,765	135	185,277	1,623	97	289	140	11
2002	7,511,154	10,030	639	831,511	3,565	158	250,656	1,865	88	386	161	13
2003	3,179,629	6,682	439	475,582	2,535	130	255,892	1,697	86	271	105	12
2004	2,581,743	5,358	421	377,173	2,097	101	149,933	1,351	83	142	115	6
2005	1,078,088	2,890	272	176,928	1,101	72	130,710	865	57	116	82	5
2006	2,891,435	3,255	297	686,475	1,344	87	181,102	897	60	41	20	5
2007	7,123,976	4,465	338	586,700	1,556	84	165,729	954	67	740	11	9
2008	6,764,108	4,206	364	365,331	935	92	253,530	1,101	66	531	16	9
2009	4,049,599	3,890	340	181,458	807	60	180,704	1,084	60	218	65	7
2010	4,280,703	3,946	355	284,972	1,095	64	129,865	1,063	57	126	37	9
2011	3,889,637	3,004	301	55,576	327	31	97,908	531	40	231	64	10

High fuel prices and cheaper imports will most likely continue to keep new entrants out of the shrimp trawl fishery and it is not likely to grow significantly in the foreseeable future.

This same downward trend in effort is also seen in the ocean fishery, where the Exclusive Economic Zone (EEZ) off North Carolina is under the management of the South Atlantic Fisheries Management Council (SAFMC). In recent years, low shrimp prices, rising fuel costs, competition with imported products, and the recent hurricanes in the Gulf of Mexico have all impacted the shrimp fleets. Fishing effort has been reduced by as much as 50% for offshore waters of the Gulf of Mexico (GMFMC 2007) and by about 40% in the South Atlantic (NMFS 2012a). During AC discussion on the following options it will be necessary to distinguish if measures need to include ocean waters. For consistency with SAFMC measures the North Carolina coastal fishing waters less than 3 miles from shore have mirrored federal restrictions for the most part.

In considering ways to reduce bycatch, using time and seasonal restrictions for reducing effort in the shrimp trawl fishery is discussed herein. This issue paper will discuss seasonal closures like closing trawling an additional day of the week or from December or January through May, day/night closures, and restricting tow times for example.

IV. AUTHORITY

§ 113-134. Rules.

§ 113-182. Regulation of fishing and fisheries.

V. DISCUSSION

Seasonal Closure

One possible method of reducing bycatch of non-target species is to further restrict the amount of time that shrimp trawling is allowed. As previously stated, the two primary time restrictions in existence regarding the shrimp fishery are that shrimp trawls are not allowed from 9:00 p.m. on Fridays to 5:00 p.m. on Sundays and SSNAs can only be opened from August 16 to May 14 each year. Closure of additional time periods to shrimp trawling may reduce bycatch by reducing the amount of time that shrimping effort occurs.

An option to consider would be a shrimp trawl closure of several months to occur when shrimp landings were insignificant and juvenile fish were abundant. This would reduce the trawl effort when shrimp landings and value were not optimal.

Although all months could be considered for seasonal closure, as an example, the period of December through May could be closed to shrimp trawling to reduce the catches of juvenile finfish when the target shrimp were not as available. In some years, white shrimp may still be present in December and in warmer springs, pink shrimp may be available in May, but this would be a way to reduce effort. Little shrimp trawl activity occurs in internal coastal waters during December through April. In May, Pamlico, Core and Bogue sounds as well as Newport and North River fishermen begin trawling as pink shrimp that have overwintered make their way to the inlets and the ocean. Closures during June through November are not consistent with maximizing economic value of shrimp since these are the months when this annual crop is available and the most efficient way to harvest them is with otter and skimmer trawls.

Along with the regional differences in shrimp harvest times, there is seasonal variability in the availability of the three different shrimp species. Table 12.30 illustrates the variation in seasonal landings of the three shrimp species and unclassified shrimp by month from 2001 through 2011 (eleven year sum) in inside waters. Table 12.31 depicts average monthly trawl landings and effort in different waterbody groupings. Pink shrimp that have overwintered in sea grass beds may begin to migrate toward the ocean inlets in April and May as water temperatures rise. Extremely cold winters can reduce the pink shrimp crop significantly. The pink shrimp are mostly gone by July and brown shrimp are dominant from July to October. White shrimp appear in the southern part of the state in May or June as adults that have overwintered. They are present in the central waterbodies and Pamlico Sound in late summer through late fall, depending on cooling water temperatures. This seasonal availability means for example, that a closure in April and May would negatively impact the Pamlico, Core and Bogue sounds as well as the Newport and North River area, when pink shrimp are migrating to sea.

Table 12.30 Average pounds of shrimp landed in North Carolina's inside waters per month by species, 2001-2011.

Month	Brown Shrimp		Pink Shrimp		White Shrimp		Unclassified	
	Pounds	Percent	Pounds	Percent	Pounds	Percent	Pounds	Percent
January			16	4.02	345	84.44	47	11.54
February	10	27.94	25	70.89	0	1.16	-	-
March	30	1.51	1,385	70.07	557	28.18	5	0.23
April	146	0.86	13,070	76.64	3,809	22.33	29	0.17
May	4,018	7.91	45,386	89.33	921	1.81	482	0.95
June	168,585	66.01	84,211	32.97	530	0.21	2,083	0.82
July	1,522,408	94.45	39,584	2.46	5,288	0.33	44,664	2.77
August	1,112,668	88.10	1,556	0.12	121,105	9.59	27,650	2.19
September	255,364	40.29	844	0.13	372,954	58.85	4,617	0.73
October	67,734	11.79	2,050	0.36	500,650	87.18	3,854	0.67
November	11,348	4.94	1,723	0.75	215,762	94.00	711	0.31
December	262	1.81	40	0.28	14,098	97.22	101	0.70

Seasons in other states are based on the economic considerations of the availability of species of shrimp (mostly white shrimp). South Carolina allows trawling on their white shrimp crop from May through December in general trawl areas (nearshore ocean) and from September to December 15 downstream of channel net areas.

Georgia's white shrimp season opens as early as May 15 and can run as late as February. Florida, which manages by region, has a closed season from June through October and certain counties close in April and May. Alabama opens and closes its seasons by regulation. Mississippi opens in May or June and closes December 31 north of the WW and closes April 30 south of the IWW. Louisiana has a May through July inshore season and an August through December inshore season. Finally, Texas has a May through July season for early morning shrimping, an August through November season for daylight shrimping and a February through April season for nighttime only shrimping.

If a seasonal closure was implemented, conflicts could increase among trawlers who can switch gear and existing channel netters and shrimp pound operators since the productive sites for this

gear are already taken and additional fishermen moving in would be problematic. A statewide season opening day of June 1 could result in a “grand opening” event in certain waterbodies with many boats vying for limited space along the closure lines.

Additional Day of Week Closure

Adding another day of the week to the present closed trawling period is another time related bycatch reduction measure to consider. Shrimp trawling is closed from 9:00 p.m. on Fridays to 5:00 p.m. on Sundays in internal coastal waters. Friday could be considered as an additional day to be closed. The closure could be from 9:00 p.m. on Thursdays to 5:00 p.m. on Sundays.

The present Friday through Sunday evening closure evolved from a February 1984 petition from fishermen to close Core Sound from 8:00 a.m. Saturday to 6:00 a.m. Monday by proclamation. Although some fishermen and dealers complained that they needed shrimp for the Monday morning market and there was a fear of effort shifting to adjacent open areas, there was some support for a Sunday night closure. A proposal to close from Saturday morning through Monday morning by rule failed. Fishermen continued to request a weekend closure by proclamation and this was tried in July, 1984. Core Sound, North River, South River, Turnagain Bay, Rataan, Cedar, Long and West bays, Newport River and Adams Creek were closed from July 15 through December 31, 1984 and this was continued from that time on in some fashion. In 1993 the weekend closure was adjusted to begin one hour after sunset on Fridays and end one hour before sunset on Sundays. A 1993 effort by the Marine Fisheries Commission to extend the closure through Monday morning failed to go forward. Actual times (9 p.m. and 5:00 p.m.) were implemented in 2004 to avoid confusion with varying times found on sunrise/sunset tables.

Although an additional day added to the weekend closure, be it Friday or Monday, would reduce shrimp trawling effort, it is not possible to quantify the reduction in bycatch. A uniform number of shrimp are not caught each available trawling day so an additional closed day would not reduce bycatch proportionally. Regardless of the days of the week closed, it has been observed that the best catches of shrimp are on the night of the opening after that “rest period”. Johnson (2006) noted that twice as much shrimp were caught early in the five-day trawling week than later in the week in the coastal shrimp trawl fishery in NC, suggesting that time restrictions could further improve the efficiency of the shrimp fishery. An additional weekend closure day would be an option that would reduce effort, however reducing the number of days from five to four does not take into account days already lost to wind and weather, unfavorable tide and moon phases, etc. that may further impact shrimp catches. An additional day added to the weekend closure would reduce trawling effort by Recreational Commercial Gear License holders and part-time fishermen who shrimp trawl mainly around the weekends.

Day/Night Closures

Another way to reduce the amount of time shrimp trawling is allowed and perhaps reduce bycatch is to close areas during the daytime or nighttime hours. The habits of North Carolina’s three shrimp species determine when they are fished for now. In the central part of the state, brown and pink shrimp usually burrow into the substrate during the day and trawling for them usually occurs at night. Occasionally trawling for brown shrimp can occur during the daytime when waters are murky. These trips usually last one night or one day. White shrimp are found up in the water column and fishing for them occurs mainly at night. Larger trawlers in Pamlico Sound with the capacity to store ice usually stay out four or five days and tow day and night. Shrimp from the larger trawlers are usually landed on Thursdays and Fridays.

In 1997, many Sneads Ferry trawler fishermen requested opening the New River to daytime shrimp trawling only. This was not based on any biological information. Many of the local shrimpers preferred to go during the daytime and wanted to keep trawlers from neighboring areas out of there at night. Marine Fisheries Commission Rule 15A NCAC 03J .0208, effective in 1998, makes it unlawful to use trawl nets upstream of the Highway 172 bridge over New River from 9:00 p.m. through 5:00 a.m. when opened by proclamation from August 16 through November 30.

In North Carolina it is unlawful to trawl for shrimp in the Atlantic Ocean off Brunswick County from 9:00 P.M. to 5:00 A.M. each day [15A NCAC 03J .202 (8)]. This management measure was implemented in large part to reduce the bycatch of finfish in this gear. Ingraham (2003) examined this question by conducting a study of shrimp and finfish catch rates (day vs. night) in state waters from Topsail Inlet to Little River Inlet. Data from the study showed that finfish bycatch was higher at night than during the day. Of the nine commercially important finfish species caught, southern flounder, spot, Atlantic croaker, and southern kingfish catch rates were significantly higher at night. The catch of shrimp did not vary significantly between nighttime and daytime trawling, although catches were slightly higher during the day. South Carolina shrimp trawling has been closed at night since the 1970s, but that was enacted to keep North Carolina fishermen from catching brown shrimp at night because South Carolina fishermen wanted to work during the day, not for any biological reason (L. DeLancey, SC DNR, personal communication).

Table 12.31 Average landings and effort by month of all shrimp species by waterbody* from otter and skimmer trawls combined), 2002-2011.

Month	Pamlico Sound		Western Rivers		Central Sounds		Southern		Ocean <3 miles	
	Trips	Pounds	Trips	Pounds	Trips	Pounds	Trips	Pounds	Trips	Pounds
January	1	341	-	-	-	-	-	-	28	35,844
February	0.2	11	-	-	-	-	0.2	19	18	32,622
March	0.4	19	-	-	-	-	14	1,305	10	11,349
April	5	1,579	1	132	1	132	102	10,944	29	5,096
May	19	14,614	5	841	5	841	253	33,904	103	53,249
June	84	116,739	89	34,216	89	34,216	386	93,122	170	138,253
July	611	1,393,375	194	85,330	194	85,330	494	130,019	350	247,899
August	615	1,056,351	122	33,984	122	33,984	529	144,646	278	131,156
September	264	430,894	52	14,612	52	14,612	409	125,427	324	217,701
October	251	496,953	14	6,659	14	6,659	208	45,164	463	342,944
November	88	205,238	2	2,035	2	2,035	51	13,061	294	241,485
December	9	12,334	0.1	3	0.1	3	2	168	67	79,160

*Waterbody Groupings:

Pamlico Sound

Western Rivers include Neuse, Bay, Pamlico and Pungo rivers

Central Sounds include Core and Bogue sounds, Newport, North and White Oak rivers

Southern includes all waters south of White Oak River

Ocean < 3 miles

Tow Times

One more way to consider reduction of effort in relation to time involves restricting tow times. A tow time limit of 45 minutes has been mentioned by the public. Although theoretically and commonsense-wise, it would appear that reducing tow times would reduce bycatch, in reality that does not necessarily occur. Reduced tow times would likely reduce bycatch mortality. Fish aggregations as well as shrimp aggregations are not uniformly distributed and each tow is different depending on depth, tide stage, moon phase bottom type and many other factors. Carothers and Chittendon (1985) found a significant linear relationship between catch and tow duration (i.e., the longer you tow, the more you catch). Their experiments tested tows of 5, 10, 15, 20, 25 and 30 minutes duration.

A tow time requirement would be very difficult to enforce without constant Marine Patrol oversight or costly Vessel Monitoring Systems. Tow times in the ocean were enforced from 1996 through 2005 under a now-expired Incidental Take Permit from National Marine Fisheries Service issued to trawlers from Browns Inlet to Rich Inlet due to the presence of grass (brown algae). This involved constant monitoring and observers and was very difficult to enforce. The timing of tows began when the otter trawl doors were lowered into the water and ended when they exited the water. Skimmer trawl tows could not be timed in that way since they are towed continuously and the tailbags are pulled in and emptied. Additional tows could be made to make up for the "lost effort" of limited tow times. Tow times have been suggested and may be effective in reducing bycatch mortality in individual tows. Recoupment of trawl times could be made up with additional tows.

VII. EVALUATION MATRICES

AC Evaluation of Effort Management for Bycatch Reduction in the North Carolina Shrimp Trawl Fishery

Impacted Group	Shrimp Fishery			Other Fisheries	Agency		Other Impacts
	Management Option	Bycatch Reduction Impact	Economic Impact	Social Impact	Inter-fishery Impact	Enforceability	
1. <i>Status quo</i>	No change in existing about of bycatch. -	No additional loss or gain in revenue. N	No change in fishing practices. N	Commercial and recreational trawling will continue with no changes in season or conflicts. N	Same level of enforcement. Not evaluated	No proclamation or rule change needed. Not evaluated	
2. Implement seasonal closure (i.e. December or January through May) AC voted to not consider this option. Failed 4-4.	Bycatch from shrimp trawls eliminated during the months of closure. +	Loss of income due to reduced shrimp catch. -	May create effort shifts. May cause potential conflict between user groups. -	Trawlers who switch gears may conflict with present users of that gear. -	May increase enforcement efforts patrolling closed areas. Not evaluated	Implemented by proclamation authority or rule change if preferred. Not evaluated	
3. Add an additional day to the weekend closure in internal coastal waters	Some reduction in bycatch for an additional day per week. +	Trawlers may lose one additional day of income. May recoup, but loss of another day per week may be detrimental with lost trips due to weather, breakdowns, etc. Channel netters and offshore trawlers would favor this as it allows more shrimp to reach them. -	Increased effort to recoup lost day could create conflict between trawlers and other user groups. -	No impact with other fisheries. N	Same amount of enforcement on opening nights. Not evaluated	Rule change required. Not evaluated	

AC Evaluation of Effort Management for Bycatch Reduction in the North Carolina Shrimp Trawl Fishery

Impacted Group	Shrimp Fishery			Other Fisheries	Agency		
Management Option	Bycatch Reduction Impact	Economic Impact	Social Impact	Inter-fishery Impact	Enforceability	Authority/ Administrative	Other Impacts
4. Close shrimp trawling at night in internal coastal waters.	Possible reduction in bycatch in certain areas. +	Potential loss of income due to reduced shrimp catch. Channel netters and offshore trawlers would favor this as it allows more shrimp to reach them. -	Loss of traditional fishery. Potential to increase conflict. -	Effort shifts to other fisheries may occur. -	Night patrol will need to be increased. Not evaluated	Implemented by proclamation authority or rule change if preferred. Not evaluated	Loss or gains could be species specific. Not evaluated
5. Implement a tow time limit in internal coastal waters. AC voted to not consider this option. Passed 6-2.	No impact on bycatch due to variable shrimp and fish distribution and the ability to recoup with additional tows. May reduce bycatch mortality.	No impact on harvest or income. Difficult to quantify due to variability.	Numerous complaints of violations are likely.	No impact.	Difficult to enforce and time the tows.	Implemented by proclamation authority or rule change if preferred.	

DMF Evaluation of Effort Management for Bycatch Reduction in the North Carolina Shrimp Trawl Fishery

Impacted Group	Shrimp Fishery			Other Fisheries	Agency		Other Impacts
	Management Option	Bycatch Reduction Impact	Economic Impact	Social Impact	Inter-fishery Impact	Enforceability	
1. <i>Status quo</i>	No change in existing bycatch. -	No additional loss or gain in revenue. N	No change in fishing practices. N	Commercial and recreational trawling will continue with no changes in season or conflicts. N	Same level of enforcement. N	No proclamation or rule change needed. +	.
2. Implement seasonal closure (i.e. December or January through May)	Bycatch from shrimp trawls eliminated during the time of closure. The magnitude of bycatch reduction depends on time selected. +	Loss of income due to reduced shrimp catch. -	May create effort shifts. May cause potential conflict between user groups. -	Trawlers who switch gears may conflict with present users of that gear. -	May increase enforcement efforts patrolling closed areas. -	Implemented by proclamation authority or rule change. -	
3. Add an additional day to the weekend closure in internal coastal waters	Reduces bycatch for an additional day per week. +	Trawlers may lose one additional day of income. May recoup, but loss of another day per week may be detrimental with lost trips due to weather, breakdowns, etc. Channel netters and offshore trawlers would favor this as it allows more shrimp to reach them. +/-	Increased effort to recoup lost day could create conflict between trawlers and other user groups. -	No impact with other fisheries. N	Same amount of enforcement on opening nights. N	Rule change required. -	

DMF Evaluation of Effort Management for Bycatch Reduction in the North Carolina Shrimp Trawl Fishery

Impacted Group	Shrimp Fishery			Other Fisheries	Agency		
Management Option	Bycatch Reduction Impact	Economic Impact	Social Impact	Inter-fishery Impact	Enforceability	Authority/Administrative	Other Impacts
4. Close shrimp trawling at night in internal coastal waters.	Possible reduction in bycatch in certain areas. Increase of bycatch mortality due to increase in air temperature +/-	Potential loss of income due to reduced shrimp catch. Channel netters and offshore trawlers would favor this as it allows more shrimp to reach them. +/-	Loss of traditional fishery. Potential to increase daytime shrimping conflict. -	Effort shifts to other fisheries may occur. -	Night patrol will need to be increased. -	Implemented by proclamation authority or rule change. -	Loss or gains could be shrimp and bycatch species specific. N
5. Implement a tow time limit in internal coastal waters	May reduce bycatch mortality. Minimal impact on bycatch due to variable shrimp and fish distribution and the ability to recoup with additional tows. + /-	Loss fishing time due to increase in number of haulbacks. This results in lost income. Difficult to quantify due to variability. -	Numerous complaints of violations are likely. Operator frustration due to decrease in efficiency. -	No Impact. N	Difficult to enforce and time the tows. Increase in number of responses to complaints on tow times -	Implemented by proclamation authority or rule change if preferred. -	

12.7 CHARACTERIZATION OF THE NORTH CAROLINA COMMERCIAL SHRIMP TRAWL FLEET

I. ISSUE

Characterize the otter and skimmer trawl fleet in the North Carolina shrimp fishery and determine the impacts of any potential restrictions on headrope length, vessel size, or number of nets towed.

II. ORIGINATION

Request by the public, Coastal Conservative Association North Carolina (CCA NC), Coastal Fisheries Reform Group (CFRG), Marine Fisheries Commission (MFC), Shrimp Advisory Committee (AC)

III. BACKGROUND

The North Carolina shrimp fleet consists of vessels of various sizes and configurations. Roughly 92% of North Carolina's shrimp is harvested using otter trawls (NCDMF 2012). Otter trawls derived their name from the two trawl doors (otter doors/boards) that attach to the bridle that are hydro-dynamically designed to hold the wings of the net open (Jennings et al. 2001). As the net is pulled along the bottom, the otter boards plane in opposite directions holding the net open. The webbing or the "body" of the net is usually constructed of nylon or polyethylene mesh and is also held open by a series of buoys attached to a "headrope" and weighted "footrope". "Tickler chains" are attached between the otter doors in front of the footrope to agitate the bottom, spooking shrimp into the net. Larger nets may also be rigged with rollers on the footrope preventing it from digging into muddy bottoms (NMFS 2012). The footrope can also be fitted with "rockhoppers" made out of rubber bobbins that allow the trawl to bounce over obstructions (Jennings et al. 2001). While the configuration of otter trawls may vary from state-to-state, all otter trawls consist of a pair of otter doors, headrope, footrope, tickler chain, and mesh body with wings that funnel shrimp in to a "cod end" or "tail bag" (Figure 12.29).

There are a number of otter trawl designs used in the southeastern shrimp fishery which include, the flat trawl, two-seam trawl, four-seam trawl, and tongue or "mongoose" (Watson et al. 1984; NMFS 2012). Optimum fishing configuration of trawls may be changed to reduce the bycatch of jellyfish, sponges, bottom trash, and finfish (Watson 1984). Trawls may also be rigged for different substrates and target species. In North Carolina, conventional two-seam otter trawls are used for bottom-hugging pink and brown shrimp, while four seam and tongue trawls with adjustable headropes are used for white shrimp which have the ability to jump over two-seam trawls when disturbed (NCDMF 2012; NMFS 2012). While otter trawl design and construction may vary, headrope length is commonly used to define a single otter trawl's horizontal spread or size. However, footrope length may also be used to determine the horizontal spread of tongue nets that have adjustable headropes. In North Carolina, the size of a trawl is based on its headrope length. Headrope length is defined as the support structure for the mesh or webbing of a trawl that is nearest to the water surface when in use. Headrope length is measured from the outer most mesh knot at one end of the headrope following along the line to the outer most mesh knot at the opposite end of the headrope [15A NCAC 03I .0101(i)].

When otter trawls were first brought to North Carolina in the early 1920s, 15 to 20 ft skiffs powered by small gasoline engines were used to pull a single rig otter trawl (one net) with

headropes ranging in size from 25 to 50 ft. By the 1940s and 1950s, larger 40 to 60 ft diesel-powered vessels began pulling larger nets with headropes ranging in size of 60 to 65 ft (Maiolo et al. 1980; Maiolo 2004). As vessels became larger and more powerful, trawlers began using “double-barrel” and “four-barreled” rigs allowing a vessel to pull multiple smaller trawl nets (40-50 ft) with combined headrope lengths measuring up to 200 ft (NCDMF 2012; NMFS 2012). The use of smaller nets creates less drag, making vessels more fuel efficient. Watson (1984) notes that four-barrel trawls are able to sweep a larger total area per gallon of fuel than do double-barrel rigs. Additional benefits of double and four-barreled also include: (1) increased catch per unit of effort, (2) fewer handling problems with the smaller nets, (3) lower initial gear costs, (4) reduced costs associated with damage or loss of nets, and (5) greater crew safety (NMFS 2012).

The size of gear allowed in North Carolina’s shrimp fishery has been the subject of debate particularly with respect to trawls. Prior to the 2006 Shrimp FMP, there were size limits on channel nets and on recreational shrimp trawls (26 ft headrope length) used by recreational commercial gear license (RCGL) holders, but no restriction on the size of trawls used in the commercial shrimp fishery. At the time, many fishermen felt that there should be a maximum limit placed on the size of trawls particularly in some of the smaller water bodies. They cited it was unfair to allow larger vessels into these areas especially on opening days when many boats would crowd into an area. It was thought that the larger vessels took most of the shrimp, rendering areas unproductive for several days, and then left to fish in more open waters unworkable by the smaller vessels. In addition to fairness, management actions were put into place to reduce bycatch and decreased the affect of trawling on the habitat. Currently, it is unlawful to use shrimp trawls that have a combined headrope greater than 90 ft in the internal coastal waters of North Carolina, except in the Pamlico Sound and mouths of the Pamlico and Neuse rivers [15A NCAC 03L .0103(c)].

Otter Trawl Headrope/Footrope Regulations in Other States

Many states have enacted various regulations limiting maximum headrope length and trawl configuration (Table 12.32). Estuarine trawling is prohibited in much of South Carolina, however in designated areas fishermen may use shrimp trawls with a combined footrope length no greater than 220 ft and “try” nets or test nets cannot have a footrope length greater than 16 ft (SC 50-5770). In South Carolina, a majority of the fishermen use tongue nets with adjustable headrope to target white shrimp, thus the footrope is used to measure horizontal spread. In Georgia it is unlawful to fish for shrimp for human consumption with trawls having a total footrope length greater than 220 ft (OCGA 27-4-133). Georgia commercial and recreational bait shrimpers are further restricted to trawls with maximum footrope lengths of 20 ft and 10 ft, respectively. Georgia state law also prohibits trawlers targeting shrimp for human consumption from the 60 bait zones located in the middle and upper estuaries as well the sounds and its sounds are closed to trawling for shrimp taken for consumption. Florida’s net ban in 1994 limited the use of all nets over 500 square feet of mesh and reduced Florida’s shrimp fishery to a bait shrimp fishery; however, trawling for shrimp for human consumption still occurs on a small scale. In the nearshore and inshore waters of Florida where otter trawls are allowed, fishermen are limited to a single net with a headrope no greater than 10 ft. Two trawls may be used in certain nearshore and inshore regions of Florida, however combined headrope length cannot exceed 20 ft. Outside of these waters trawlers may use up to a single net with headrope no greater than 20 ft (FL 68B-31.009).

The Gulf States also have limited maximum headrope length and the number of nets fishermen are allowed to use. In Alabama, commercial vessels operating in Mobile Bay and its sounds are

limited to two trawls with a maximum combined headrope length of 50 ft. In the offshore waters of Alabama there is no restriction on trawl size or number of rigs. Alabama commercial and recreational bait trawlers are restricted to a single trawl with a maximum headrope length of 16 ft. In Mississippi, commercial shrimp trawlers operating in the internal waters are allowed to use a single trawl with a maximum headrope length of 50 ft or two 25 ft trawls. Recreational fishermen in Mississippi are limited to a 16 ft maximum headrope length. Much like Mississippi, commercial vessels fishing in the inshore waters of Louisiana are limited to a single net with a headrope of 50 ft or two nets with headropes not exceeding 25 ft each. However, in Breton and Chandeleur Sounds vessels may use two nets with a headrope of 65 ft (130 ft combined). Vessels fishing in Louisiana's territorial waters (from beach to 3 miles offshore) may use trawls with up to 130 ft of headrope and in the federal waters (EEZ) vessels may use up to four nets of any size. Recreational fishermen in Louisiana are limited to a single net with a maximum headrope length of 25 ft. Much like Florida, Texas implements its headrope and trawl configurations by region, season, and intended use (bait vs. consumption). However, the maximum allowable headrope length is also determined by door length in Texas; trawls with headrope lengths measuring 40 ft must have a door 3 to 4 ft in length and nets measuring 54 ft must have a door 10 ft or larger. In major bays of Texas commercial fishermen targeting penaeid shrimp may use a single net with a headrope measuring 40 to 54 ft during the Spring Open Season (May 15-July 15). During the Fall Open Season (Aug. 15-Nov. 30) they may use a single net with a headrope not exceeding 95 ft. During the Winter Open Season (Feb.1-April 15) Texas fishermen working south of the Colorado River are limited to a single net with a headrope measuring 40 to 54 ft. Commercial bait fishermen are also limited to a single net with a headrope measuring 40 to 54 ft; however, bait fishermen are allowed to use smaller mesh sizes and are required to meet additional requirements and trip limits. Commercial vessels operating in Texas inside 3 nautical miles may use two trawls with headrope lengths ranging from 71 to 89 ft based on door size. Vessels operating 3 to 9 nautical miles offshore are not limited by number of nets they can pull or headrope length.

Skimmer Trawl Headrope Regulations

While headrope length is most commonly associated with otter trawls, headrope length can also be used to describe the length of the support structure that the mesh or webbing attaches to that is nearest the surface of the water. Thus, the headrope length of most skimmer trawls is dictated by the length of the skimmer trawl frame. Most skimmer trawls consist of two frames mounted to each side of the vessel, net (mounted to each frame), sled, weighted shoes, tickler chain, and an "easy line" (Figure 12.30). When deployed, the nets are aligned perpendicularly to the vessel and held in place by two or more stays or cables that run to the bow (NMFS 2012). The weighted sleds or "bullets" also help to maintain the nets position in the water column, while the weighted skids or "shoes" allow the frame to ride along the bottom, rising and falling with the bottom contour. Shrimp are spooked into the net by the tickler chain as it agitates the bottom; the tickler chain is attached in front of the lead line or footrope. The easy or "lazy" line is attached to the skimmer trawl tailbag and allows the tailbag to be retrieved without stopping the vessel (Coale et al. 1994).

Very few states have specific regulations for skimmer trawl configuration in regards to net length and design. Mississippi's skimmer trawl regulations mirror their otter trawl regulations, limiting vessels to two nets with a 25 ft headrope on each diagonal arm (not to exceed a combined headrope length of 50 ft). In Florida, skimmers must be equipped with rollers and vessels are limited to two unconnected trawls with upper and lower horizontal beams that do not exceed 16 ft in length each. In most states where skimmer trawl net and frame lengths are not specified, headrope length is defined to include the length of supporting structure that is the nearest to the

surface of the water. In the internal coastal waters of North Carolina, skimmer trawls nets cannot exceed a combined headrope length of 90 ft, except in the Pamlico Sound and parts of the Pamlico and Neuse Rivers [15A NCAC 03L .0103(c)].

Characterization of North Carolina Trawler Configuration

Using data from the Commercial Fishing Vessel Registration (CFVR) license, North Carolina Trip Ticket Program (NCTTP), DMF characterization studies (Brown 2009, 2010a, 2010b) and phone surveys, headrope length data were compiled to characterize the North Carolina shrimp trawl fleet during 2010 and 2011. A CFVR is required if a vessel is going to be used in a commercial fishing operation. When fishermen apply or renew their CFVR to obtain their vessel ID or "P" number they are asked a series of survey questions pertaining to vessel length, type of gear, number of nets, headrope length, as well as other vessel specifications. Data from the NCTTP were analyzed to identify the vessels that operated in the commercial shrimp trawl fishery in 2010 and 2011. Once the vessels were identified, their respective survey data obtained from the CFVR was then extracted from the DMF License database. Some vessels entered the shrimp trawl fishery after they obtained their CFVR license. To obtain the gear characteristics for these vessels, NCTTP port agents conducted phone surveys of the vessel owners. The phone surveys and characterization studies were used to further verify the CFVR data. Using each vessel's ID and landings data from the NCTTP, total shrimp landings (all three species combined) were calculated by gear, area, total headrope length (ft), number of nets, and vessel length (ft). In viewing the tables and figures keep in mind while this is the best available data, it still has several limitations: 1) gear data from the CFVR is for their predominant gear and variation in the use of different size or number of nets and rigs is not captured, and 2) in a similar manner only one predominant waterbody can be recorded on paper trip ticket forms. It should also be noted that estimated reductions calculated using vessel and headrope length frequency distributions can be influenced by bin size (10 ft increments); thus averages and modes listed in Table 12.33 calculated on a finer scale (1ft increments) may not correspond directly to the bin modes shown in the figures .

Pamlico Sound

The number of vessels using otter trawls in Pamlico Sound declined 4% from 220 in 2010 to 201 in 2011 (Table 12.33). Average vessel length ranged from 49 to 53 ft, while the most frequently occurring (mode) vessel length was 36 ft. Vessels 30 ft or less made up 13% of the fleet in 2010 and 21% in 2011, while boats larger than 90 ft or greater made up 6% in 2010 and 5% in 2011 (Figure 12.31). On average these vessels made 1,656 trips in 2010 and 1,502 trips in 2011. Average shrimp landings ranged from 2,317 lb/trip in 2010 to 2,419 lb/trip in 2011. The majority of the vessels operating in Pamlico Sound during 2010 and 2011 used double and four-barrel rigs. Vessels using double-barrel rigs made up 32% of the fleet in 2010 and 35% in 2011, those using four-barrel rigs made up 54% in 2010 and 46% in 2011. Boats using single rigs made up 14% in 2010 and 18% in 2011. The average total headrope length ranged from 117 ft in 2011 to 128 ft in 2010. The most frequently observed total headrope length was 180 ft in 2010 and 70 ft in 2011. However, the vast majority of the fleet used nets with headropes larger than 70 ft. Total headropes lengths measured 70 ft or greater made up 83% of the observations in 2010 and 77% in 2011 (Figure 12.32).

Very few fishermen used skimmer trawls in the Pamlico Sound during 2010 and 2011 (Table 12.33). Only two vessels were observed in 2010 and four in 2011. Average vessel length ranged from 24 to 34 ft. In 2011, three out of the four vessels observed were over 40 ft (Figure 12.33). Since only two vessels used skimmer rigs in the Pamlico Sound in 2010 their landings

data is confidential and cannot be shown. In 2011, four vessels made four trips landing an average of 175 lb/trip. All skimmers operating in the Pamlico Sound were double rigged. The average total headrope length ranged from 20 ft in 2010 to 46 ft in 2011. Total headrope lengths measuring 50 ft or greater were not observed in 2010, however they made up 50% of rigs in 2011 (Figure 12.34).

Neuse, Pamlico and Bay Rivers

In the Neuse, Pamlico, and Bay Rivers, 58 vessels made 377 trips, landing an average of 305 lb/trip of shrimp in 2010 (Table 12.33). In 2011, 49 vessels made 446 trips, landing an average of 235 lb/ trip. Average vessel length ranged from 30 ft to 31 ft. The most frequently observed vessel length observed in 2010 was 20 ft, dropping slightly in 2011 to 19 ft. Vessels 40 ft or less made up approximately 85% of the fleet during both years (Figure 12.35). Double-barrel rigs were predominately used in 2010 (57%) and 2011 (51%). Vessels using single rigs made up 38% of the fleet in 2010 and 43% in 2011. Less than 10% of the vessels used four-barreled rigs during 2010 and 2011. The average total headrope length ranged from 52 ft in 2011 to 55 ft in 2010. The most frequently observed total headrope length was 80 ft in 2010 and 30 ft in 2011. Vessels using total headrope lengths that were 90 ft or less made up 95% of observations in 2010 and 92% in 2011 (Figure 12.36).

Skimmer trawls landed on average 202 lb/trip in 2010 and 235 lb/trip in 2011. The number of vessels using skimmer trawls in the Neuse, Pamlico, and Bay Rivers ranged from 4 to 7 (Table 12.33). Average vessel length ranged from 22 to 28 ft. In 2010, the most frequently observed vessel length was 25 ft. In 2011, 71% of the vessels were approximately 30 ft in length and in 2010 all vessels were between 20 and 30 ft (Figure 12.37). All vessels were double rigged with total average headrope lengths and ranged from 21 to 27 ft. In 2010, the most commonly observed headrope length was 28 ft. In 2011 the number of vessels using total headropes length between 20 and 30 ft were equally distributed; however in 2010, 86% of the headropes were 30 ft or less (Figure 12.38).

Bogue and Core Sounds, Newport and North Rivers

The number of vessels using otter trawls in central internal waters of the state (Bogue Sound, Core Sound, Newport River, and North River) ranged from 43 to 67 (Table 12.33). In 2010, 553 trips landed an average of 199 lb/trip. While the number of trips fell almost 70% to 166 trips the landings increased slightly to 208 lb/trip in 2011. Average vessel length ranged from 28 to 29 ft. The most frequently occurring vessel length ranged from 21 to 22 ft. In 2011, there was a slight increase in the number of 30 ft vessels as well as 50 ft vessels (Figure 12.39). The number of vessels using single rigs increased from 45% in 2010 to 49% in 2011. Vessels using double-barrel rigs fell slightly in 2010 from 52% to 51% in 2011. Overall, very few boats used four-barrel rigs in this part of the state. Average total headrope lengths ranged from 46 to 47 ft. However, vessels using total headrope lengths that were 20 ft or less made up approximately 42% observations during both years (Figure 12.40). The most commonly observed total headrope length was 15 ft during both years.

In 2010, CFVR data indicated that there were 37 skimmers in central region internal water of the state; this number fell to 12 in 2011 (Table 12.33). Vessel length ranged from 28 to 29 ft. The most commonly reported vessel length was 25 ft in 2010 and 28 ft in 2011. No boats larger than 50 ft were observed (Figure 12.41). As with the other parts of the state, all skimmer rigs consisted of two rigs (Table 12.33). Total average headrope length was 29 ft in 2010 and increased slightly in 2011 to 32 ft. The most commonly reported head rope was 20 ft in 2010

and 24 ft in 2011. Total headrope lengths measuring 40 ft or greater made up on average 27% to 33% fleet gear in 2010 and 2011, respectfully (Figure 12.42). On average these vessels landed an average of 218 lb/trip of shrimp in 2010, average landings declined in 2011 to 154 lb/trip.

Southern Region

In 2010, 103 vessels landed an average of 155 lb/trip of shrimp using otter trawls in the Intracoastal Waterway (IWW) to the South Carolina state line and the New and Cape Fear Rivers (Table 12.33). Otter trawl landings fell roughly 32% in this part of the state in 2011. Average vessel length ranged from 22 to 23 ft during 2010 and 2011. The most commonly reported vessel length was 17 ft in 2010 and 19 ft in 2011. While vessels ranging in length of 40 to 70 ft made up only 8% of the fleet in 2010 and 14% in 2011 (Figure 12.43), it's important to note that the data used to characterize the fleet is based on its CFVR data and trip ticket landings and doesn't take into account area restrictions. Regulations limiting headropes and the inability to safely navigate the narrow waterway of areas such as the southern portion of the state restrict larger vessels. Vessels with total headrope lengths measuring 40 ft or less made up 83% of the fleet in 2010 and 77% of the fleet in 2011 (Figure 12.44).

In 2010, 26 vessels reported using skimmer rigs in the southern region; this number declined to 17 in 2011 (Table 12.33). Out of the 439 trips made in 2010, an average of 313 lb/trip of shrimp were landed. In 2011, 149 lb/trip of shrimp was landed. The average vessel length reported ranged from 30 to 33 ft. The most commonly observed vessel length reported ranged from 17 ft in 2010 to 38 ft in 2011. Skimmer vessels ranging in length of 40 to 50 ft made up 42% of the fleet in 2010 and 52% in 2011 (Figure 12.45). As with the other parts of the state all vessels used double rigs. Average total headrope lengths ranged in size from 40 to 42 ft, with a mode of 48 ft. Vessels with total headrope lengths measuring between 50 and 70 ft made up 39% of the fleet in 2010 and 53% in 2011 (Figure 12.46).

Atlantic Ocean

The number of vessels using otter trawls in the Atlantic Ocean declined 21% from 116 in 2010 to 92 in 2011 (Table 12.33). The average vessel length was 51 ft and the most commonly reported vessel size was 55 ft during 2010 and 2011. However, vessels between 60 and 90 ft made up roughly 50% of the fleet during both years and the number of 60 and 80 ft vessel both increased in 2011 (Figure 12.47). The majority of the vessels operating in the ocean used four-barrel rigs, with roughly 47% of the fleet using them. Double-barrel rigs were the second most commonly used configuration, with 33% using them in 2010 and 28% using them in 2011. An average of 120 ft of total headrope was used during 2010 and 2011. The most commonly observed total headrope value was 160 ft in 2010 and 200 ft in 2011. Vessels using total headropes less than 120 ft accounted for 44% of the fleet in 2010 and 46% in 2011 (Figure 12.48). Overall, vessels using otter trawls in the Atlantic Ocean landed an average of 772 lb/trip of shrimp in 2010 and 819 lb/trip in 2011. No landings were reported for skimmer trawls in the Atlantic Ocean during 2010 and 2011.

IV. AUTHORITY

- § 113-134. RULES
- § 113-173. RECREATIONAL COMMERCIAL GEAR LICENSE
- § 113-182. REGULATION OF FISHING AND FISHERIES
- § 143B-289.52. MARINE FISHERIES COMMISSION – POWERS AND DUTIES

V. DISCUSSION

In 2011, DMF sent out a press release and held several public meetings as part of the 5-year review of the Shrimp FMP. At those meetings and through public comment, several requests were made to limit inshore trawls to a headrope length of 50 ft. This request was later echoed by Coastal Conservation Association North Carolina (CCA NC) and its members following the DMF's initial plan to revise the FMP. Shortly after the formation of the Shrimp Advisory Committee (AC), a letter was sent from the Coastal Fisheries Reform Group (CFRG) requesting that all trawl nets in North Carolina's inshore coastal waters be limited to a single net with a maximum headrope size of 35 ft.

North Carolina's headrope regulations were put in place following the 2006 Shrimp FMP as a means to allocate the resource fairly amongst vessels of all sizes, reduce bycatch, and to limit the effects of trawling in prescribed areas. In other states, headrope limitations have also been used to reduce conflict and effort, specifically the fishing power of larger boats. While there has been no definitive data indicating there is more overall bycatch associated with larger trawlers, the general public perceives that larger vessels pulling double-barrel and four-barrel rigs are capable of removing more non-target species. Double-barrel and four-barrel rigs are capable of sweeping larger areas; however, the fishing power, efficiency and selectivity of the gear rely on more than just the length of its headrope. The measurement of a net's gape, measured by the horizontal spread and vertical distance between the headrope and footrope, affects not only the nets efficiency, but its ability to reduce unwanted bycatch (Watson et al. 1984). Just as there is no ideal trawl design or configuration for harvesting every species of shrimp in all substrates, there is no ideal design that excludes both demersal and pelagic species of fish (Watson et al. 1984; Harrington et al. 1985). While double and four-barrel rigs are capable of sweeping more area, making demersal species more vulnerable to the gear, the reduced vertical height of multiple smaller nets may reduce the bycatch of more pelagic species (S. Nichols, NMFS. pers. com. 1995). The use of smaller nets associated with double and four-barrel rigs may also allow larger fish to escape during haul back due to the shortened body length of the net; these reductions may be minimal for vessels pulling tongue trawls with adjustable headropes.

Using the distribution of vessels lengths reported in the CFVR and trip ticket data linked by a vessel's ID, reductions in effort were calculated for 2010 and 2011. While these data provide insight on the potential effects of regulations limiting vessel size, number of rigs and total headrope length, estimates of bycatch reduction cannot be calculated. Implementing a maximum vessel size would reduce the fleet size in North Carolina's internal waters. Overall, the average length of shrimp trawlers operating in the internal waters of North Carolina ranged from 22 to 53 ft and varied by water body and year (Table 12.33). Establishing a maximum vessel size would be difficult and the total reduction in fleet size may be minimal in certain areas. If vessels size was limited to 50 ft in internal coastal waters of North Carolina, 44% to 52% of the vessels operating in the Pamlico Sound would no longer be allowed to fish. In the southern portion of the state reductions in fleet size would range from 2% to 4% and 5% to 6% in the Neuse, Pamlico, and Bay Rivers (Figure 12.34 and Figure 12.41). Limiting the size of vessels using skimmer trawls to 50 ft or less would not reduce the fleet size based on the 2010 and 2011 data (Figures 4, 8, 10, 12, and 14). Not only would it be difficult to determine the appropriate vessel size for each region of the state, but enforcement would be extremely difficult and would most likely cause shifts in effort. While current regulations limit the use of 90 ft headropes in the internal waters of North Carolina, there is not a direct limit on the size of vessels. However, larger vessels were typically found to have larger total headrope lengths (Figure 12.49). North Carolina General Statue 143B-289.52 (a)(1)a. provides the MFC with the

authority to “authorize, license, regulate, prohibit, prescribe, or restrict all forms of marine and estuarine resources in coastal fishing waters with respect to: time, place, character, or dimensions of any methods or equipment that may be employed in taking fish.” The Division is verifying whether a vessel would be included in the meaning of equipment in this statute.

Similar considerations apply when examining regulations limiting the total number of rigs or otter trawls a vessel may use. Eliminating the use of four-barrel rigs may reduce the fleet size by as much as 54% in the Pamlico Sound, while only reducing effort by as much as 6% in the Neuse, Pamlico, and Bay Rivers (assuming vessels do not re-rig) (Table 12.33). Restricting the use of double-barrel rigs in the Neuse, Pamlico, and Bay Rivers would have more impact, reducing the fleet size by as much as 57%. In the southern portion of the state, only 11% to 16% of the vessels reported using double and four-barrel rigs. In many parts of the state vessels using double and four-barrel rigs are limited to waters that allow the use of total headropes 90 ft or greater. Thus, potential reductions based on the number of rigs are confounded not only by regulations, but also by CFVR data that does not account for variation in fishing methods and gear quantities across different areas. Restricting the use of four-barrel rigs would only be effective at reducing the fleet size in the Pamlico Sound. Overall, restricting the total headrope length of otter trawls would essentially restrict the total number of rigs as well as vessel size in most parts of the state. Limiting skimmer trawls to single rigs, would not only eliminate the majority of North Carolina’s skimmer fleet, but would reduce the vessel’s ability to navigate.

The distribution of total headrope length (10 ft bins) was used to estimate the effect of reducing the maximum headrope length in the internal coastal waters of North Carolina. Establishing a 50 ft otter trawl total headrope limit would reduce the fleet gear by as much as 60% statewide during 2010 and 2011. However, this reduction would be even greater in the Pamlico Sound; reducing the fleet gear by 84% in 2010 and 79% in 2011 (Figure 12.33). In the Neuse, Pamlico, and Bay Rivers, estimated reductions would have been 48% in 2010 and 39% in 2011 (Figure 7). During both 2010 and 2011, the number of vessels with total headrope length greater than 50 ft would be reduced roughly 46% in the aggregate waters of Bogue and Core Sounds, Newport and North Rivers (Figure 11). The reductions in the southern portion of the state would be minimal for otter trawls at 9% in 2010 and 15% (Figure 12.43). However, a 50 ft headrope limit would reduce the fleet gear of skimmer vessels in the southern portion of the state by as much as 19% in 2010 and 24% in 2011 (Figure 12.45). In the Pamlico Sound, there were no skimmers observed with total headrope lengths over 50 ft in 2010 and in 2011 only two of four skimmer trawls observed had headropes larger than 50 ft (Figure 12.33). No skimmer trawls reported using total headropes larger than 50 ft in Neuse, Pamlico, and Bay River during both years of the survey (Figure 12.36).

Implementing a 35 ft maximum headrope length in the internal coastal waters of North Carolina would severely reduce the fleet size and the fishing power of the otter trawl fishery. As with a 50 ft maximum headrope length, the Pamlico Sound otter trawl fishery would see the greatest reductions at 92% in 2010 and 88% in 2011 (Figure 12.31). In the adjacent waters of the Neuse, Pamlico, and Bay Rivers estimated reductions for otter trawls would range from 61% in 2011 to 67% in 2010 (Figure 12.34). Roughly half of vessels using otter trawls in the central (Bogue and Core Sounds, Newport and North Rivers) and southern portions of the state would no longer be able to operate using their gear configurations as reported in 2010 and 2011 (Figure 12.39 and Figure 12.43). Vessels using skimmer rigs in the southern portion of the state would also see severe reductions ranging from 69% and 82% (Figure 12.45). Skimmers in the central portion of the state were estimated to have the second highest reductions at 27% in 2010 and 33% in 2011 (Figure 12.41). No vessels reported having had a total headrope greater than 35 ft in the Neuse, Pamlico and Bay Rivers in 2011 and only one vessel (14%) was observed in 2011, thus

estimated reductions would be minimal (Figure 12.37). There were also no skimmer vessels using headropes greater than 35 ft in the Pamlico Sound in 2010 and in 2011 there were only two vessels that would not be able to operate using their reported gear configuration (Figure 12.33). It is important to note that estimated reductions based on total headrope length and vessel size may be an overestimate as a result of bin size (10 ft increments). The estimated reductions presented in this paper do not represent reductions in fishing effort; they are merely a snap shot of the potential reductions in the fleet size and gear based on the vessel and gear configurations observed in 2010 and 2011. Hence, these reductions may not accurately reflect the current make-up of the fishery or the years prior to 2010.

Regardless of vessel size, shrimp trawl design has evolved to improve the efficiency of the gear to capture shrimp and maximize area swept. Regulations limiting total headrope length will reduce the efficiency of both large and small vessels using nets with headropes larger than 35 ft. Thus, overall effort will likely be reduced due to a loss of fishing power and as fishermen leave the fishery because it is no longer economically feasible to continue. Not only will the current gear configuration used by many fishermen be obsolete, but operating costs will likely exceed the value of their catch. Shifts in effort may also occur putting more pressure on already overburdened fishing locations, leading to increased conflict and minimal reductions in bycatch. Fishermen attempting to compensate for lost catches as result of being forced to use less efficient gear may actually make more or longer tows, generating more bycatch per pound of shrimp landed. Reductions in bycatch may also be minimal if crews of larger vessels begin operating multiple smaller vessels, not only increasing effort (participants and trips) but the total headrope size of the fleet as a whole. There is also the potential for shifts in the species and size makeup of the bycatch. If larger vessels are forced out of the internal coastal waters into the ocean due to regulations that reduce total headrope length, more pressure may be put on the winter ocean spawners (spot, croaker, and flounder). While reducing headrope length has the potential to reduce bycatch associated with inshore trawling (Watson et al. 1984), the issue is extremely complex making it difficult to quantify its total impact on the fishery beyond reduction in effort; social, economic, and historical factors must also be examined. Unfortunately, all of the necessary data do not exist to adequately quantify the full extent that such regulations could have on levels of bycatch reduction and on the shrimp trawl fishery and its associated industries. Even after all the data are presented, there still will not be clear guidance concerning the issue. The essential decision will be the unquantified potential gain in some natural resources versus the losses to a major economically important fishery.

VII. EVALUATION MATRIX

AC Evaluation of Characterization of the North Carolina Commercial Shrimp Trawl Fleet

Impacted Group	Shrimp Fishery			Other Fisheries	Agency		
Management Option	Bycatch Reduction Impact	Economic Impact	Social Impact	Inter-fishery Impact	Enforceability	Authority/Administrative	Other Impacts
1. <i>Status quo</i>	Continues the existing amount of bycatch and bycatch mortality in the shrimp fishery. Continued reduction in effort may result in overall bycatch reduction in the fleet. -	Will not create shifts in effort to other fisheries. Maintains present market value of fishery. N	Allows flexibility of fishermen to continue to fish in their normal areas using their normal gears. N	Commercial and recreational fishing will continue with no changes in gear use or conflict. Potential recreational angling could remain stagnant if status quo continues. +/-	Same level of enforcement. Not Evaluated	No change in rule. Not Evaluated	Not Evaluated
2. Reduce maximum headrope length all internal coastal waters for commercial and recreational fisheries. AC added "for commercial and recreational fisheries".	May reduce bycatch from vessels using larger headropes. Reductions may be minimal as effort changes. Size and species makeup of bycatch may shift as effort changes. +/-	Overall loss in gear efficiency will likely result in a decrease in landings and income. Increases operating costs and reduces efficiencies for many shrimp fishing operations due to: 1) New gear purchase or reconfiguration 2) Increase in fuel cost 3) Increase travel time to non-restricted areas 4) Increase number of haul backs -	Prior efforts (time and money) expended to improve gear efficiencies lost. May reduce the availability of NC caught shrimp. May be favorably viewed by general public, while industry frustrated with additional restrictions. Remaining vessels may have less competition. +/-	May create conflicts with other commercial and recreational fishermen due to changes in effort. May improve recreational fishing. +/-	Increase in enforcement duties. Not Evaluated	Will require rule change. Not Evaluated	Not Evaluated

AC Evaluation of Characterization of the North Carolina Commercial Shrimp Trawl Fleet (August 15,2013)

Impacted Group	Shrimp Fishery			Other Fisheries	Agency		
Management Option	Bycatch Reduction Impact	Economic Impact	Social Impact	Inter-fishery Impact	Enforceability	Authority/ Administrative	Other Impacts
<p>3. Implement a maximum number of rigs (i.e., double and four-barrel) in the internal coastal waters</p>	<p>May reduce bycatch from vessels using larger headropes. Reductions may be minimal as effort shifts. Size and species of bycatch makeup may shift as effort shifts.</p> <p align="center">+/-</p>	<p>Overall loss in gear efficiency will likely result in a decrease in landings and income. Increases operating costs and reduces efficiencies for many shrimp fishing operations due to:</p> <ol style="list-style-type: none"> 1) New gear purchase or reconfiguration 2) Increase in fuel cost 3) Increase travel time to non-restricted areas 4) Increase number of haul backs <p align="center">-</p>	<p>May reduce the availability of NC caught shrimp. May be favorably viewed by general public, while industry frustrated with additional restrictions. Remaining vessels may have less competition.</p> <p align="center">+/-</p>	<p>May create conflicts with other commercial and recreational fishermen due to changes in effort. May improve recreational fishing</p> <p align="center">+/-</p>	<p>Increase in enforcement duties.</p> <p align="center">Not Evaluated</p>	<p>Will require rule change.</p> <p align="center">Not Evaluated</p>	<p align="center">Not Evaluated</p>
<p>4. Implement a maximum vessel size in the internal coastal waters</p> <p>AC elected to not consider this option</p>	<p>Eliminates bycatch from larger vessels. Reductions may be minimal as effort changes. Size and species of bycatch makeup may shift as effort changes.</p>	<p>Increased operating cost as larger vessels are forced to travel further to fishing grounds. May create effort shifts into other fisheries. May result in reduced overall landings and income of fishermen and industry.</p>	<p>Reduces the availability of NC caught shrimp. Favorably viewed by general public, while industry frustrated with additional restrictions. Remaining vessels may have less competition.</p>	<p>May create conflicts with other commercial and recreational fishermen due to changes in effort.</p>	<p>Increase in enforcement duties.</p>	<p>Will require rule change. Authority to limit vessel size is unclear.</p>	

DMF Evaluation of Characterization of the North Carolina Commercial Shrimp Trawl Fleet (8/19/2013)

Impacted Group	Shrimp Fishery			Other Fisheries	Agency		
Management Option	Bycatch Reduction Impact	Economic Impact	Social Impact	Inter-fishery Impact	Enforceability	Authority/ Administrative	Other Impacts
1. <i>Status quo</i>	Continues the existing amount of bycatch and bycatch mortality in the shrimp fishery. -	Will not create shifts in effort to other fisheries. Maintains present market value of fishery. N	Allows flexibility of fishermen to continue to fish in their normal areas using their normal gears. N	Commercial and recreational fishing will continue with no changes in gear use or conflict. N	Same level of enforcement. N	No change in rule. N	
2. Reduce maximum headrope length in all internal coastal waters for commercial and recreational fisheries.	May reduce bycatch from vessels using larger headropes. Reductions may be minimal as effort changes. Size and species makeup of bycatch may shift as effort changes. +/-	Overall loss in gear efficiency will likely result in a decrease in landings and income. Increases operating costs and reduces efficiencies for many shrimp fishing operations due to: 1) New gear purchase or reconfiguration 2) Increase in fuel cost 3) Increase travel time to non-restricted areas 4) Increase number of haul backs -	Prior efforts (time and money) expended to improve gear efficiencies lost. May reduce the availability of NC caught shrimp. May be favorably viewed by general public, while industry frustrated with additional restrictions. Remaining vessels may have less competition. +/-	May create conflicts with other commercial and recreational fishermen due to changes in effort. -	Increase in enforcement duties. -	Will require rule change. -	

DMF Evaluation of Characterization of the North Carolina Commercial Shrimp Trawl Fleet (8/19/2013)

Impacted Group	Shrimp Fishery			Other Fisheries	Agency		
Management Option	Bycatch Reduction Impact	Economic Impact	Social Impact	Inter-fishery Impact	Enforceability	Authority/ Administrative	Other Impacts
3. Implement a maximum number of rigs (i.e., double and four-barrel) in the internal coastal waters	<p>May reduce bycatch from vessels using larger headropes. Reductions may be minimal as effort shifts. Size and species of bycatch makeup may shift as effort shifts.</p> <p align="center">+/-</p>	<p>Overall loss in gear efficiency will likely result in a decrease in landings and income. Increases operating costs and reduces efficiencies for many shrimp fishing operations due to:</p> <ol style="list-style-type: none"> 1) New gear purchase or reconfiguration 2) Increase in fuel cost 3) Increase travel time to non-restricted areas 4) Increase number of haul backs <p align="center">-</p>	<p>Prior efforts (time and money) expended to improve gear efficiencies lost. May reduce the availability of NC caught shrimp. May be favorably viewed by general public, while industry frustrated with additional restrictions. Remaining vessels may have less competition.</p> <p align="center">+/-</p>	<p>May create conflicts with other commercial and recreational fishermen due to changes in effort.</p> <p align="center">-</p>	<p>Increase in enforcement duties.</p> <p align="center">-</p>	<p>Will require rule change.</p> <p align="center">-</p>	
4. Implement a maximum vessel size in the internal coastal waters	<p>May reduce bycatch from larger vessels. Reductions may be minimal as effort changes. Size and species of bycatch makeup may shift as effort changes.</p> <p align="center">+/-</p>	<p>Increased operating cost as larger vessels are forced to travel further to fishing grounds. May create effort shifts into other fisheries. May result in reduced overall landings and income of fishermen and industry.</p> <p align="center">-</p>	<p>Reduces the availability of NC caught shrimp. Favorably viewed by general public, while industry frustrated with additional restrictions. Remaining vessels may have less competition.</p> <p align="center">+/-</p>	<p>May create conflicts with other commercial and recreational fishermen due to changes in effort.</p> <p align="center">-</p>	<p>Increase in enforcement duties.</p> <p align="center">-</p>	<p>Will require rule change. Authority to limit vessel size is unclear.</p> <p align="center">-</p>	

Table 12.32 Maximum commercial, bait, and recreational shrimp trawl configurations by state.

State	Commercial		Bait		Recreational		Additional Restrictions****
	Length (ft)	# of Nets	Length (ft)	# of Nets	Length (ft)	# of Nets	
North Carolina	90 [†]	unlimited	90 [†]	unlimited	26	1	Area [†] , Proclamation Authority SSNA
South Carolina	16* (try net), 220*						Season, area, time of day
Georgia	16* (try net), 220*		20*	1	10*	1	Closed Mar. 1-May 14, area closures
Florida (internal)	10	1 or 2 (10 ft nets)	10	1	16**	1	Body not to exceed 500 square feet
Florida (ocean)	20	1	20	1			Body not to exceed 500 square feet
Alabama (internal)	10 (try net), 50	2	16	1	16	1	Season, area (bait)
Alabama (offshore)	unlimited	unlimited					
Mississippi	50	1 or 2 (25 ft)			16	1	Season, area, door size
Louisiana (internal)	16 (try net), 50, 130 ^{††}	1 or 2 (25 ft), 2 (65 ft) ^{††}			25	1	Season, area, tow times (try nets)
Louisiana (3 mi offshore)	16 (try net), 130	unlimited			25	1	
Louisiana (EEZ)	unlimited	4			25	1	No night time by area
Texas (Bays - Spring)	21 (try net), 40-54 ^{***}	1	12 (try net), 40-54	1	20	1	Season (May 15 - July 15), area, door size
Texas (Bays - Fall)	21 (try net), 95	1	12 (try net), 40-54	1	20	1	Season (Aug. 15 - Nov. 30, area, door size
Texas (Bays - Winter)	21 (try net), 40-54 ^{***}	1	12 (try net), 40-54	1	20	1	Season (Feb.1 - April 15), area, door size
Texas (<3 mi offshore)	71-89 ^{***}	2					Season, time by area , door size
Texas (3-9 mi offshore)	unlimited	unlimited					Season, time by area (3-5 mi, no nights)

[†] It is unlawful to take shrimp with trawls which have a combined headrope of greater than 90 feet in internal coastal waters except:

(1) Pamlico Sound;

(2) Pamlico River downstream of a line from a point 35° 18.5882'N – 76° 28.9625'W at Pamlico Point; running northerly to a point 35° 22.3741'N - 6°28.6905'W at Willow Point;

(3) Neuse River northeast of a line from a point 34° 58.2000'N – 76° 40.5167'W at Winthrop Point on the eastern shore of the entrance to Adam's Creek running northerly to a point 35° 01.0744' N – 76°42.1550' W at Windmill Point at the entrance of Greens Creek at Oriental.

^{††} Breton and Chandeleur Sounds, Louisiana

* Footrope length

** Horizontal frame of skimmer (Florida further specifies use of roller in specific areas)

*** Maximum headrope length is specific to door length (ft); other trawls must have doors at least 3 ft long from the leading tip to trailing edge of door

**** In addition to no trawling in nursery areas, maximum mesh size restrictions (commercial and recreational), TED and BRD requirements (varies by state).

Table 12.33 North Carolina vessel and shrimp trawl configuration by area and year, 2010-2011.

Year	Trawl Type	Area Fished	Total Shrimp lb	Trips #	Average Shrimp (lb/trip)	Vessels #	Vessel Length		Total Headrope Length (all rigs)		Single Rig		Double-Barrel Rig		Four-Barrel Rig	
							Average ft	Mode ft	Average ft	Mode ft	#	%	#	%	#	%
2010	Otter	Pamlico Sound†	3,837,201	1,656	2,317	220	53	36	128	180	31	14%	71	32%	118	54%
2011	Otter	Pamlico Sound†	3,633,502	1,502	2,419	201	49	36	117	70	37	18%	71	35%	93	46%
2010	Otter	Neuse, Pamlico, Bay Rivers†	114,871	377	305	58	31	20	55	80	22	38%	33	57%	3	5%
2011	Otter	Neuse, Pamlico, Bay Rivers†	104,743	446	235	49	30	19	52	30	21	43%	25	51%	3	6%
2010	Otter	Bogue/Core/ Newport/North River	110,046	553	199	67	29	22	47	15	30	45%	35	52%	2	3%
2011	Otter	Bogue/Core/ Newport/North River	34,584	166	208	43	28	21	46	15	21	49%	22	51%	0	0%
2010	Otter	Southern	216,110	1,394	155	103	22	17	38	35	92	89%	7	7%	4	4%
2011	Otter	Southern	114,799	945	121	65	23	19	39	30	55	85%	9	14%	1	2%
2010	Otter	Ocean	1,253,754	1,623	772	116	51	55	120	160	23	20%	38	33%	55	47%
2011	Otter	Ocean	1,091,810	1,333	819	92	51	55	120	200	22	24%	26	28%	44	48%
2010	Skimmer	Pamlico Sound†	*	*	*	2	24	-	20	-	0	0%	2	100%	0	0.0%
2011	Skimmer	Pamlico Sound†	699	4	175	4	34	34	46	-	0	0%	4	100%	0	0.0%
2010	Skimmer	Neuse, Pamlico, Bay Rivers†	14,771	73	202	7	28	25	27	28	0	0%	7	100%	0	0.0%
2011	Skimmer	Neuse, Pamlico, Bay Rivers†	17,191	73	235	4	22	-	21	-	0	0%	4	100%	0	0.0%
2010	Skimmer	Bogue/Core/ Newport/North River	132,458	607	218	37	28	25	29	20	0	0%	37	100%	0	0.0%
2011	Skimmer	Bogue/Core/ Newport/North River	14,470	94	154	12	29	28	32	24	0	0%	12	100%	0	0.0%
2010	Skimmer	Southern	137,408	439	313	26	30	17	40	48	0	0%	26	100%	0	0.0%
2011	Skimmer	Southern	23,215	156	149	17	33	38	42	48	0	0%	17	100%	0	0.0%

* Confidential, 3 or less participants, vessels, or dealers

† It is unlawful to take shrimp with trawls which have a combined headrope of greater than 90 feet in internal coastal waters except:

(1) Pamlico Sound;

(2) Pamlico River downstream of a line from a point 35° 18.5882'N – 76° 28.9625'W at Pamlico Point; running northerly to a point 35° 22.3741'N - 6°28.6905'W at Willow Point;

(3) Neuse River northeast of a line from a point 34° 58.2000'N – 76° 40.5167'W at Winthrop Point on the eastern shore of the entrance to Adam's Creek running northerly to a point 35° 01.0744' N – 76°42.1550' W at Windmill Point at the entrance of Greens Creek at Oriental.

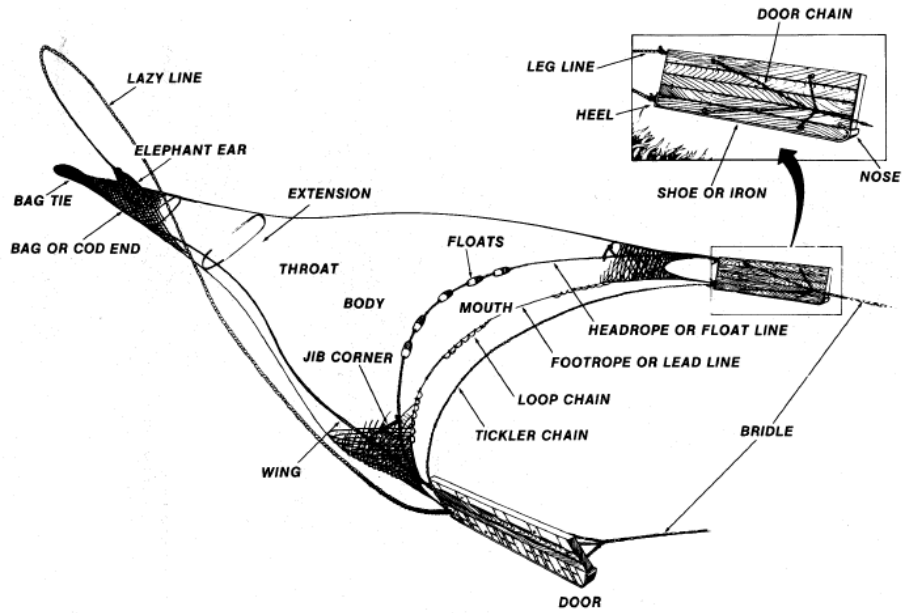


Figure 12.29 Schematic of an otter trawl and its components (from NMFS 2012).

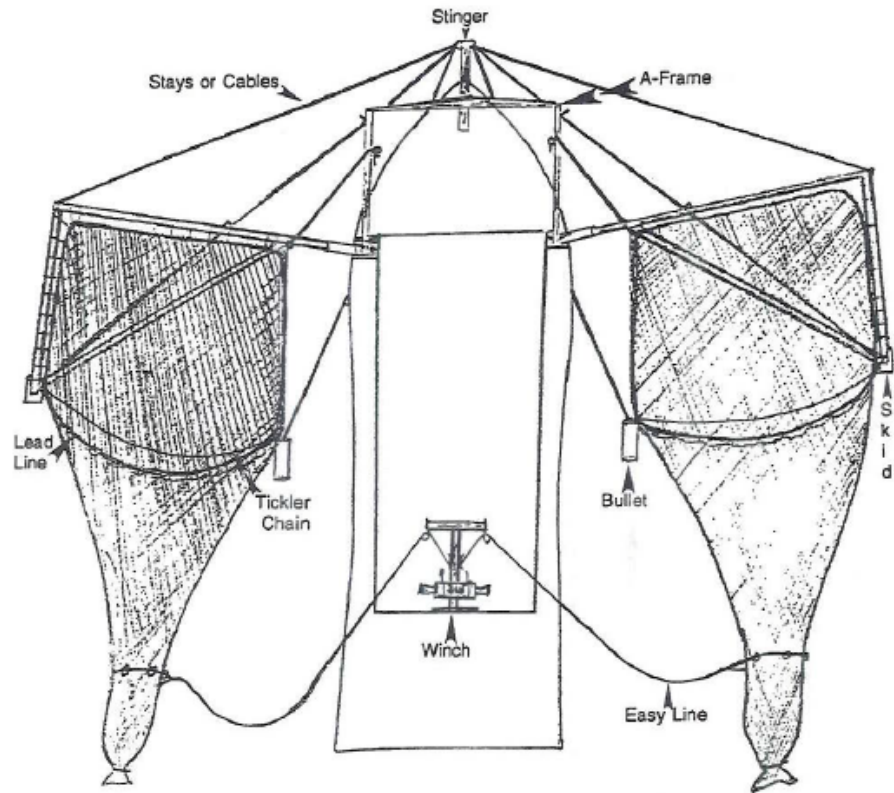


Figure 12.30 Schematic of a skimmer trawl and its components (from NMFS 2012).

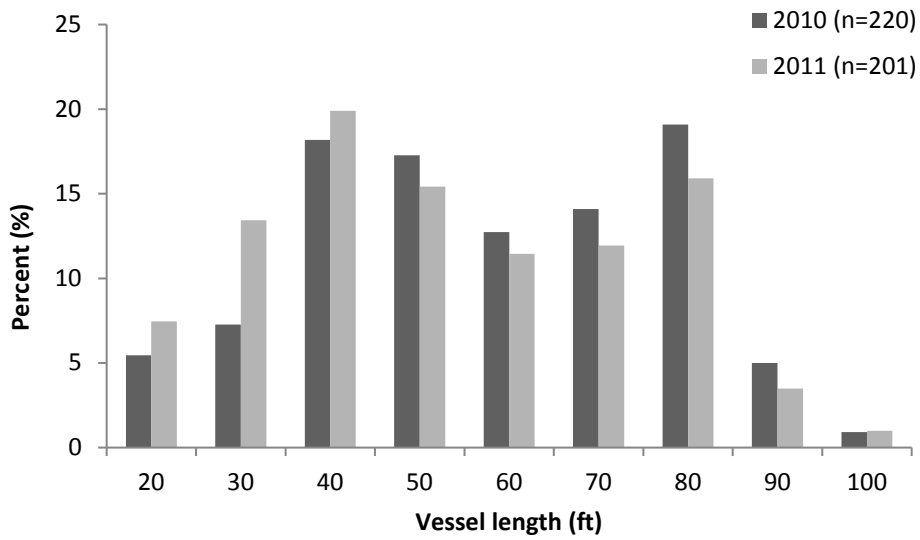


Figure 12.3 Length frequency distribution of vessels using otter trawls in the Pamlico Sound, 2010-11.

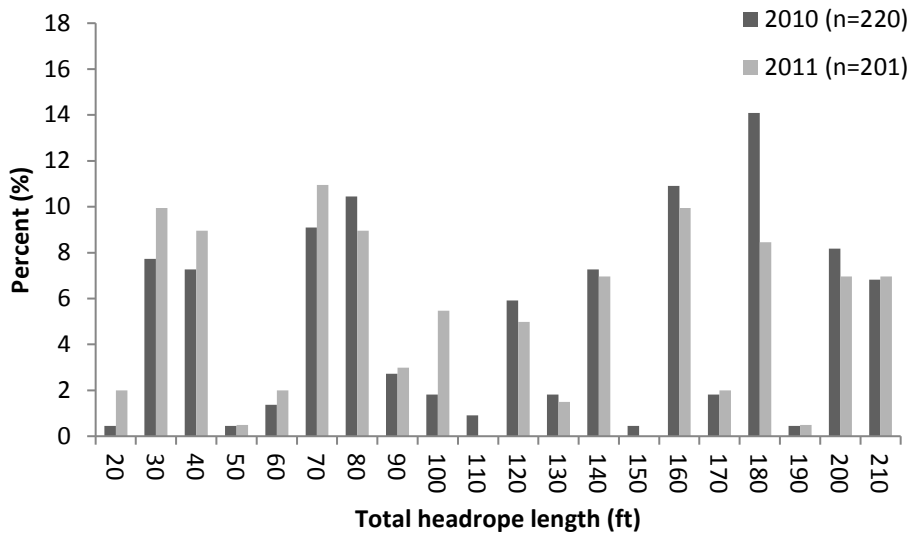


Figure 12.32 Length frequency distribution of total headrope length (ft) of otter trawls in the Pamlico Sound, 2010-11.

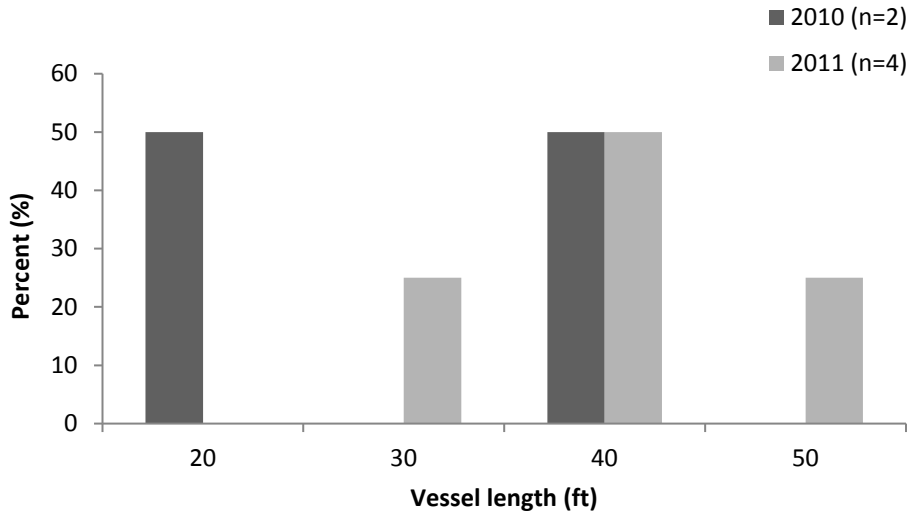


Figure 12.33 Length frequency distribution of vessels (ft) using skimmer trawls in the Pamlico Sound, 2010-11.

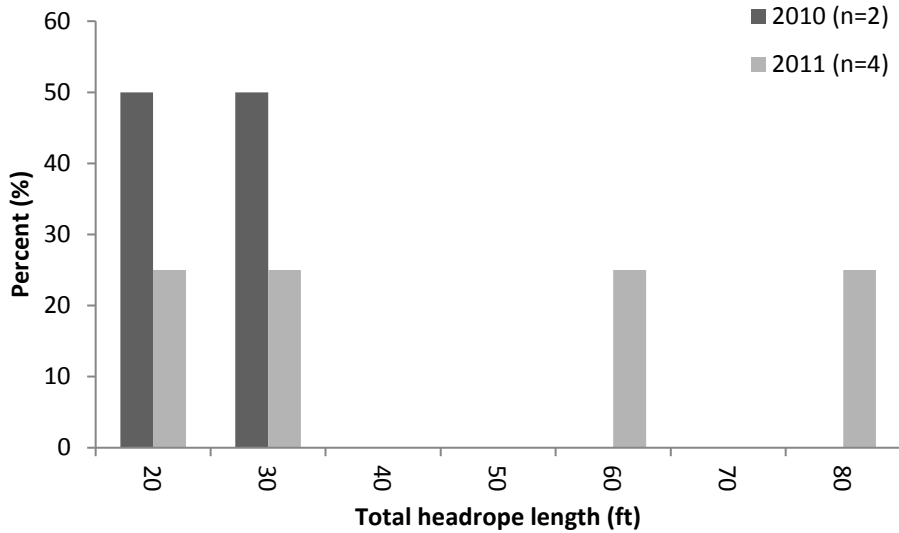


Figure 12.34 Length frequency distribution of total headrope length (ft) of skimmer trawls in the Pamlico Sound, 2010-11.

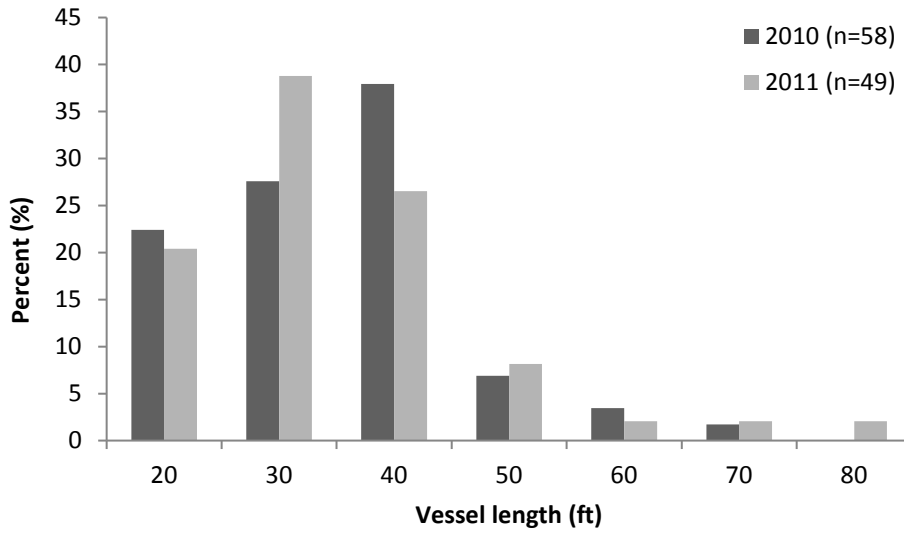


Figure 12.35 Length frequency distribution of vessels (ft) using otter trawls in the Neuse, Pamlico and Bay Rivers, 2010-11.

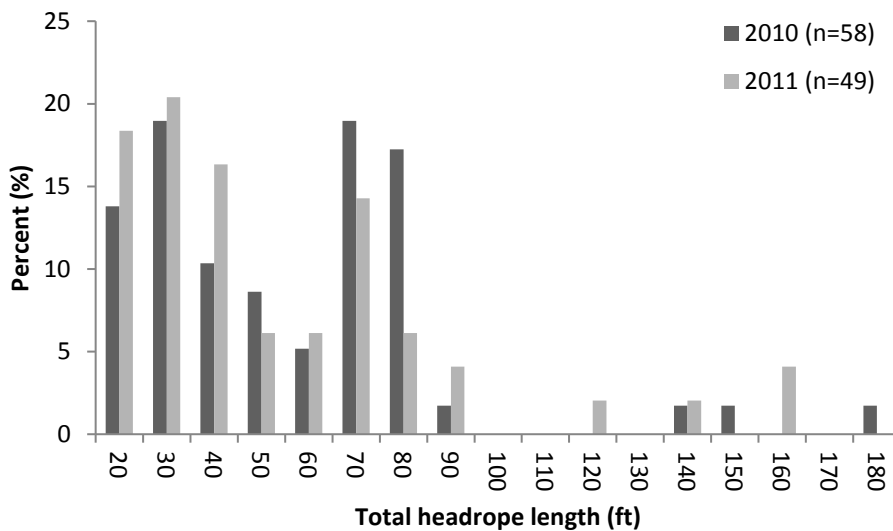


Figure 12.36 Length frequency distribution of total headrope length (ft) of otter trawls in the Neuse, Pamlico and Bay Rivers, 2010-11.

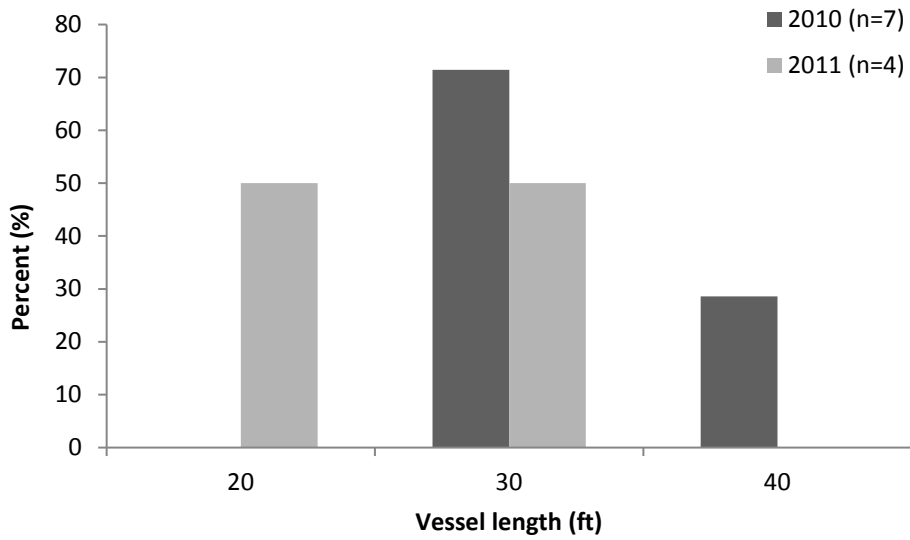


Figure 12.37 Length frequency distribution of vessels (ft) using skimmer trawls in the Neuse, Pamlico and Bay Rivers, 2010-11.

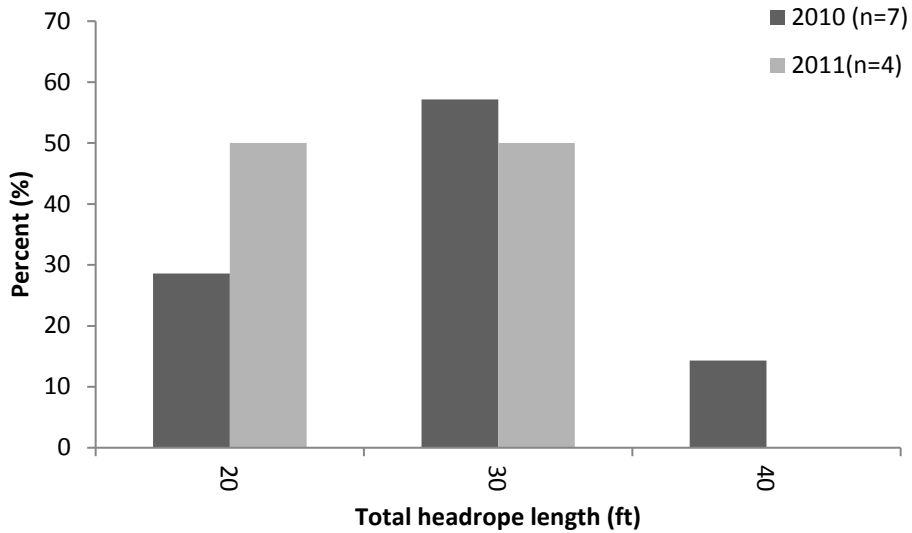


Figure 12.38 Length frequency distribution of total headrope length (ft) of skimmer trawls in the Neuse, Pamlico and Bay Rivers, 2010-11.

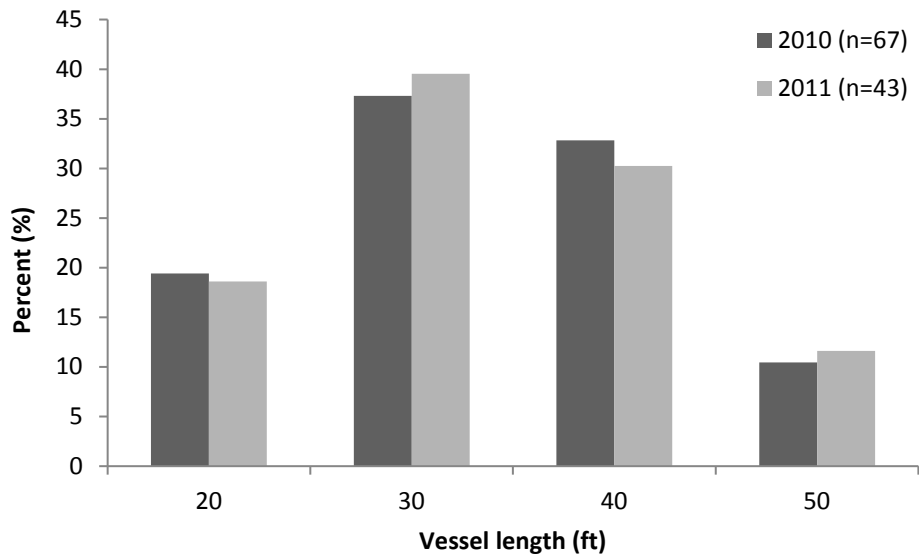


Figure 12.39 Length frequency distribution of vessels (ft) using otter trawls in the Bogue and Core Sounds as well as the Newport and North Rivers, 2010-11.

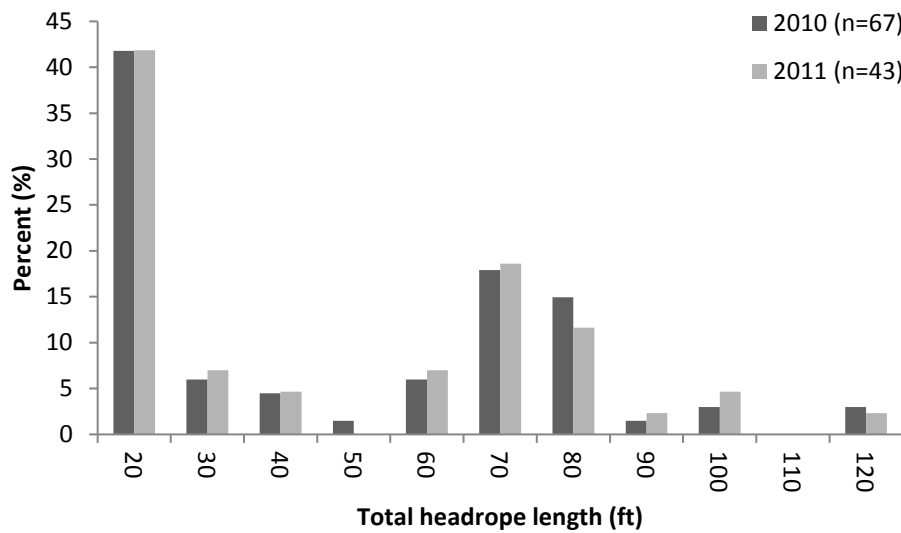


Figure 12.40 Length frequency distribution of total headrope length (ft) of otter trawls in the Bogue and Core Sounds as well as the Newport and North Rivers, 2010-11.

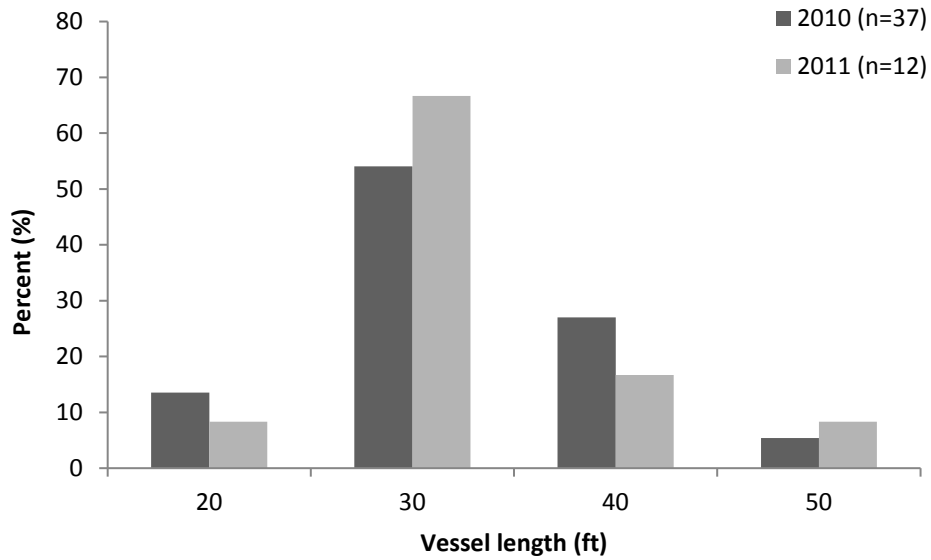


Figure 12.41 Length frequency distribution of vessels (ft) using skimmer trawls in the Bogue and Core Sounds as well as the Newport and North Rivers, 2010-11.

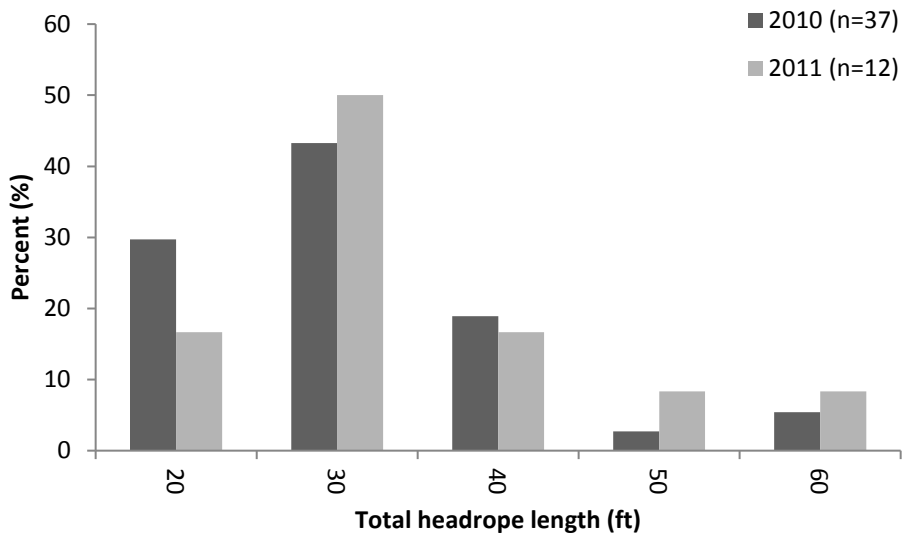


Figure 12.42 Length frequency distribution of total headrope length (ft) of skimmer trawls in the Bogue and Core Sounds as well as the Newport and North Rivers, 2010-11.

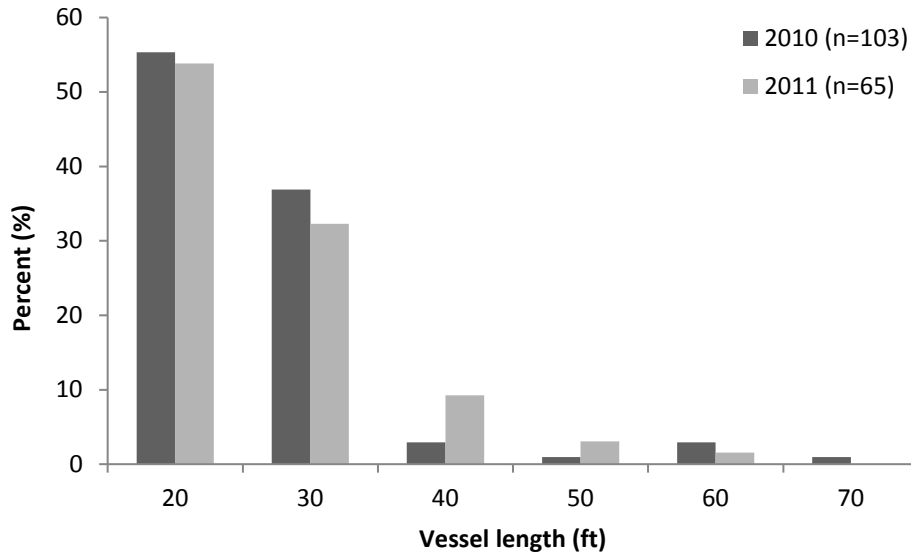


Figure 12.43 Length frequency distribution of vessels (ft) using otter trawls in the southern region of the state (New River, Cape Fear River, IWW to SC state line), 2010-11.

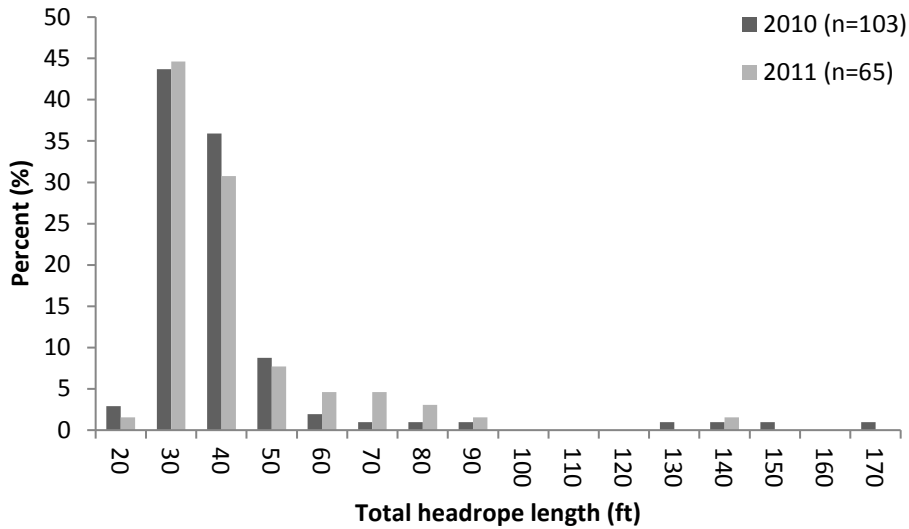


Figure 12.44 Length frequency distribution of total headrope length (ft) of otter trawls in the southern region of the state (New River, Cape Fear River, IWW to SC state line), 2010-11.

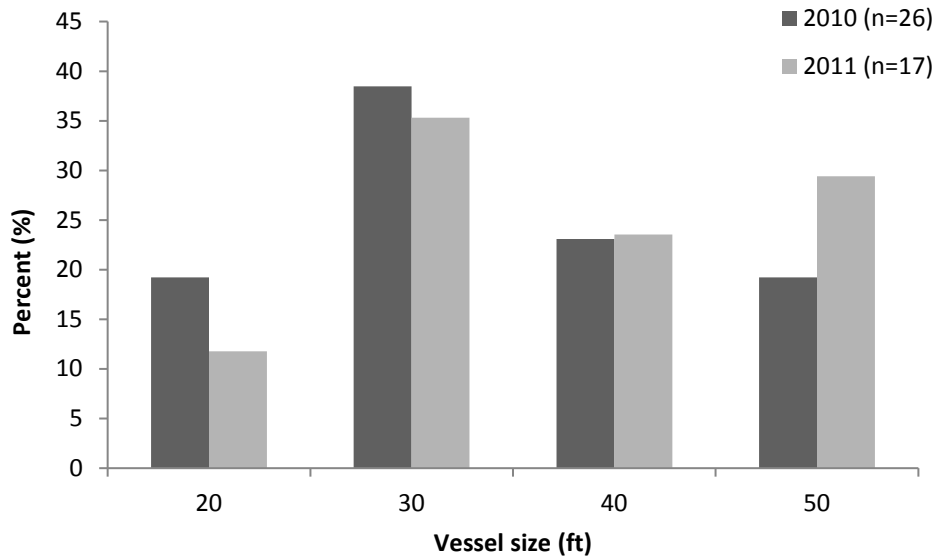


Figure 12.45 Length frequency distribution of vessels (ft) using skimmer trawls in the southern region of the state (New River, Cape Fear River, IWW to SC state line), 2010-11.

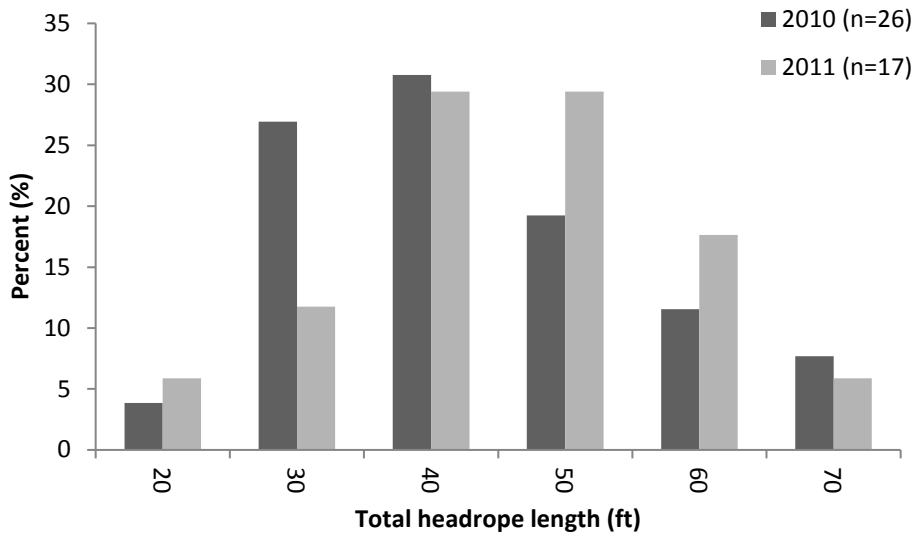


Figure 12.46 Length frequency distribution of total headrope length (ft) of skimmer trawls in the southern region of the state (New River, Cape Fear River, IWW to SC state line), 2010-11.

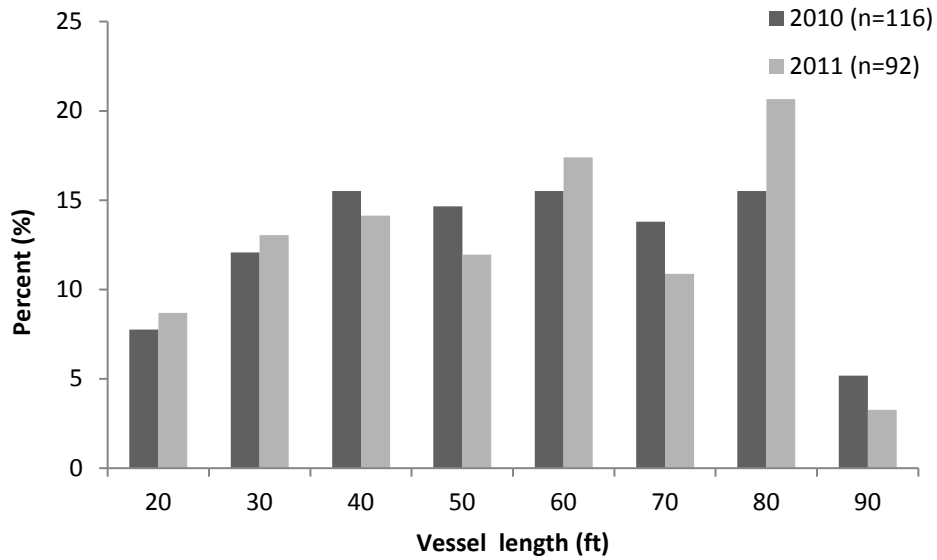


Figure 12.47 Length frequency distribution of vessels (ft) using otter trawls in the Atlantic Ocean, 2010-11.

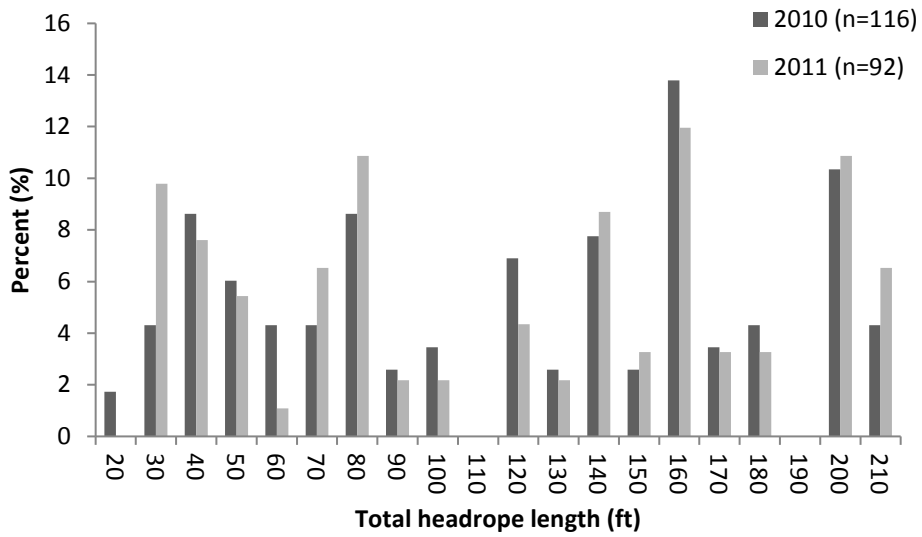


Figure 12.48 Length frequency distribution of total headrope length (ft) of otter trawls in the Atlantic Ocean, 2010-11.

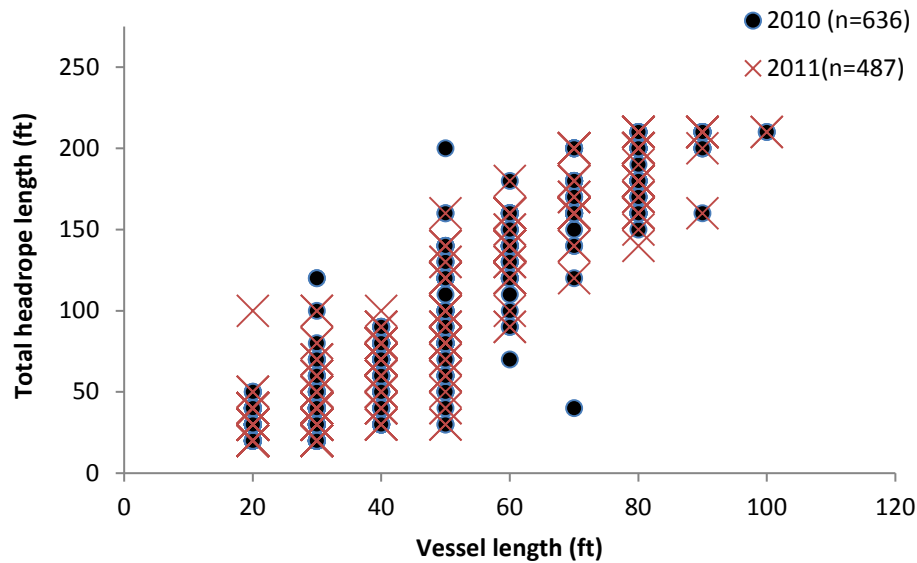


Figure 12.49 Scatter plot of vessel length (ft) and total headrope length (ft) of the North Carolina shrimp trawler fleet (all water bodies included), 2010-11.

12.8 AREA RESTRICTIONS TO REDUCE SHRIMP TRAWL BYCATCH IN NORTH CAROLINA'S INTERNAL COASTAL WATERS

I. ISSUE

The consideration of closing waterbodies to shrimp trawl gear in North Carolina

II. ORIGINATION

The Division of Marine Fisheries (DMF) Shrimp Plan Development Team (PDT) and the public

III. BACKGROUND

The estuarine system in North Carolina is the largest of any state along the Atlantic coast. Its coast is framed by a chain of low-lying barrier islands, from Virginia to Cape Fear River and makes up a diverse aquatic system of estuarine rivers, creeks, large sounds, and inlets totaling over 2.2 million acres of estuarine waters (Deaton et al. 2010; DMF unpublished data). The northern portion of these natural barrier islands are called the Outer Banks and separates the Albemarle-Pamlico sound complex from the coastal ocean. Along the southern coast, southwest of the Cape Fear River, the Intracoastal Waterway (IWW) creates an artificial extension of these barrier Islands. The topography of the three major capes (Cape Hatteras, Cape Lookout, and Cape Fear) has a major influence on adjacent ocean circulation. North Carolina is located at the convergence of two major ocean currents: the warm, north flowing Gulf Stream Current and the cool south-flowing Labrador Current that creates a mix of both northern and southern fish species in North Carolina waters. The convergence of currents and the diversity and abundance of habitat and species occurring in North Carolina's estuaries makes its coastal fisheries among the most productive in the United States.

Pamlico Sound is considered an extremely important area for both commercial and recreational fishing. It makes up approximately 56% of North Carolina's total coastal waters and contributes

23% of total commercial landings from state waters and 15% of recreational landings (DMF 2011; DMF unpublished data). Blue crab, brown and white shrimp, flounder and striped mullet are the top species commercially landed. Spotted seatrout, southern flounder, bluefish, spot and sheepshead were the most common recreational species caught and discarded in 2011 (DMF unpublished data). The extensive riverine and estuarine wetland communities, shallow nursery areas, diversity of habitats and salinity regimes provide for the disproportionately high productivity of the sound. Habitat features include extensive submerged aquatic vegetation (SAV) beds along the Outer Banks and along the rivers, intertidal and subtidal oysters and primary nursery areas. Pamlico Sound is a focal point for the shrimp, crab, and oyster fisheries as well as for other fisheries, both commercial and recreational, targeting southern flounder, spotted seatrout and red drum. All of these characteristics combined make this system important ecologically, economically and socially to the citizens of North Carolina.

The estuarine otter trawl fishery is the most efficient way to harvest shrimp in North Carolina and makes the shrimp fishery the second most valuable commercial fishery in the state behind the blue crab fishery (1994-2011 average shrimp dockside value \$9.8 million). The majority (89%) of the estuarine shrimp harvest in North Carolina comes from otter trawls. However, major concerns of otter trawls are the capture of non-target species and mortality associated with discarded fish. The amount of dead discards in the fishery may have an influence on the amount of resources available to recreational and commercial fishing. Economically valuable finfish species such as Atlantic croaker, southern flounder, spot, and weakfish are of special concern to all fishermen in North Carolina.

However, as noted in Section 6.3.5 of the draft Shrimp Revision, the resource conservation issues for these latter three species are for species that are covered in the North Carolina Interjurisdictional (IJ) FMP that selectively adopts management measures contained in approved federal council or ASMFC FMPs by reference as minimum standards. So, even with the stated goal of this shrimp amendment to 'minimize harvest of non-target species of finfish and crustaceans and protected, threatened, and endangered species, the extent and benefit of actions to be considered must be viewed in this broader ASMFC coast wide context.

Since 1978 almost one million acres of estuarine waters have been closed to trawling through fishery nursery area designations (primary and secondary nursery areas), military danger zones and restricted areas, and trawl net prohibited areas. This is approximately 45 percent of the estuarine waters. Another 65,000 acres of estuarine waters are closed some time during the year, either due to shrimp size management or areas classified as special secondary nursery areas (SSNA).

IV. AUTHORITY

§ 113-134. Rules.

§ 113-182. Regulation of fishing and fisheries

V. DISCUSSION

Prohibiting Shrimp Trawl Nets in Internal Coastal Waters

Area restrictions for trawling have been used to address allocation, resource protection, habitat protection and safety issues. The 2006 Shrimp Fishery Management Plan evaluated area restrictions as an option to reduce bycatch. During development of the 2006 FMP, area prohibitions were implemented and included closures in the IWW in the Wrightsville Beach area,

in the bays south of Fort Fisher and Bald Head Creeks, White Oak River above Hancock Point, the SSNA in Newport River, the banks side between Drum Inlet to Wainwright Island, Neuse River above Wilkinson Point, Pamlico River above Pamlico Point, and Pungo River above Wades Point. Approximately 92,000 acres of water were closed through implementation of the 2006 plan.

The value of shrimp trawl landings from estuarine waters have ranged from over \$14,000,000 in 2002 to around \$2,000,000 in 2005 and makes up between 75% and 80% of all shrimp landings in North Carolina (Table 12.34). Participation in the estuarine fishery has dropped approximately 66% since 1995 with effort in number of trips dropping approximately 81% since 1995 (Table 12.34).

Table 12.34 Number of pounds, trips, value and participation in the estuarine shrimp trawl fishery.

Estuarine Shrimp Trawl Fishery				
Year	Pounds	Participants	Trips	Value
1994	5,240,153	845	14,585	\$13,797,757
1995	5,729,152	888	15,482	\$13,759,068
1996	3,055,860	705	11,008	\$7,809,425
1997	4,911,799	722	12,702	\$12,958,128
1998	2,019,600	513	8,297	\$4,473,965
1999	5,275,158	667	10,817	\$12,928,539
2000	7,847,702	793	10,521	\$19,585,614
2001	3,493,218	553	7,734	\$8,506,491
2002	7,511,154	639	10,030	\$14,159,626
2003	3,179,629	439	6,682	\$6,011,535
2004	2,581,743	421	5,358	\$5,523,421
2005	1,078,088	272	2,890	\$2,016,414
2006	2,891,435	297	3,255	\$5,059,891
2007	7,123,976	338	4,465	\$13,595,395
2008	6,764,108	364	4,206	\$13,516,404
2009	4,049,599	340	3,890	\$6,452,588
2010	4,280,703	355	3,946	\$7,649,074
2011	3,889,637	301	3,004	\$8,178,854

While the declining value of shrimp, increasing market share of imported shrimp, regulatory changes and increased fuel prices have contributed to the decline in effort, prohibiting estuarine shrimp trawling would be detrimental to North Carolina's shrimp fishery. The closure of estuarine waters would result in the loss of the economic value to dealers, harvesters, and support industries through decreased revenue and income. In addition, less local North Carolina shrimp would be available to the public causing a higher dependence on shrimp landed from out of state and on those shrimp imported from other countries.

Prohibiting Shrimp Trawl Nets in Pamlico Sound and Adjacent Tributaries

Trawling in the Pamlico Sound has been controversial because of bycatch and discard of valuable juvenile and adult finfish. Pamlico Sound landings from shrimp trawls average 81% of internal coastal shrimp trawl landings since 1994. The amount of bycatch varies greatly from fisherman to fisherman, trip to trip and even tow to tow. Factors that influence bycatch include water temperature, water clarity, fishing location, amount of bycatch, tow time and gear configuration. Brown (2010) conducted a short term characterization study of the shrimp trawl fishery in the Pamlico Sound. During this six month study, conducted from July to December 2009, shrimp made up 23% of the total catch by weight. This study represents a 6-month snapshot in time of the Pamlico Sound shrimp fishery making this study temporally limited to that one summer and one fall season.

Atlantic croaker accounted for approximately 33% of the catch by weight, with spot and weakfish accounting for 13% and 6%, respectively. The majority of Atlantic croaker and spot were harvested in the summer months in the double seamed and four seamed trawls which are used to target brown shrimp. Other commercially and recreationally important species observed include southern, summer and gulf flounders species representing 1% of the catch by weight, as well as kingfishes and spotted sea trout representing 0.8% and 0.02%, respectively. Atlantic croaker had the largest amount of unmarketable discards by weight with all being discarded. Spot made up the second largest component of the unmarketable bycatch, 99% of the spot landed were discarded. All of the weakfish caught were undersized; length frequency distributions of discarded weakfish ranged from 70 mm to 150 mm. Weakfish represented the largest regulatory discards by weight for all net types.

The DMF has conducted a stratified-random trawl survey in the Pamlico Sound uninterrupted for twenty-five years. Sampling began in 1987 and was conducted over two weeks during the months of March, June, September, and December from 1987 to 1989. In 1990, sampling occurred over two weeks during the months of March, June, and September. From 1991 to present, the Pamlico Sound Survey has been conducted during the middle two weeks in June and September. From 1990-present, the sample area covers all of Pamlico Sound and its bays, Croatan Sound up to the Highway 64 Bridge, the Pamlico River up to Blounts Bay, the Pungo River up to Smith Creek, and the Neuse River up to Upper Broad Creek (DMF 2012).

The primary objective of this survey is to provide a multi-species long-term index of abundance for juvenile fish in Pamlico Sound and its coastal rivers. Data are used to calculate abundance indices for several recreationally and commercially significant species in Pamlico Sound, including: Atlantic croaker, spot, and weakfish and are produced annually. These juvenile abundance indices (JAI) estimates have been used in both state and federal stock assessments and management plans. This survey also provides data to evaluate other potential critical habitat areas in Pamlico Sound (DMF 2012).

Table 12.35 Weighted CPUE, standard error (SE), total number collected (n), mean size (mm), and size range for select species during 2011 in the Pamlico Sound Survey (DMF 2012).

Common Name	Month	CPUE	SE	n	Mean Size (mm)	SE	Min (mm)	Max (mm)
spot	Jun	552.0	66.3	30,396	106.4	0.6	58	188
	Sep	278.2	38.9	17,822	133.2	0.4	93	231
	All	415.1	40.4	48,218	116.3	0.4	58	231
Atlantic croaker	Jun	177.5	25.4	10,769	131.0	0.9	52	237
	Sep	118.8	15.6	5,581	169.1	0.3	145	200
	All	148.1	15.7	16,350	144.0	0.7	52	237
weakfish	Jun	37.9	11.4	1,908	197.7	1.3	52	288
	Sep	35.8	11.2	1,808	149.0	1.4	57	290
	All	36.9	7.9	3,716	174.0	1.2	52	290

In 2011, spot was the most abundant target species with an annual weighted CPUE of 415.1 individuals per sample (Table 12.35). Lengths ranged from 58-231 mm FL with a mean size of 116.3 mm FL. Atlantic croaker was the second most abundant target species with an annual weighted CPUE of 148.1 individuals per sample (Table 12.35). Lengths ranged from 52-237 mm TL with a mean size of 131.0 mm TL. Weakfish was the fourth most abundant target species behind brown shrimp with an annual weighted CPUE of 36.9 individuals per sample (Table 122). Lengths ranged from 52-290 mm TL with a mean length of 174.0 mm TL (DMF 2012.35).

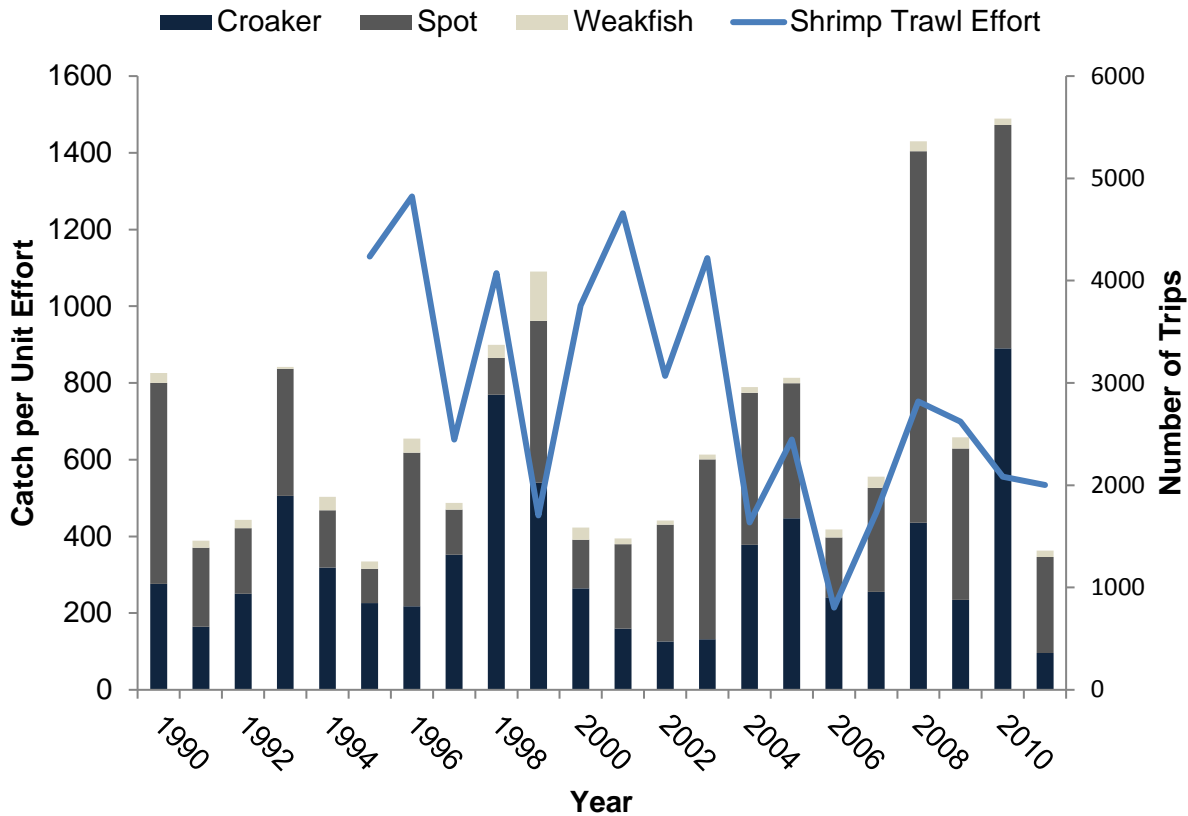


Figure 12.50 Weighted CPUE of Atlantic croaker, spot, and weakfish from the NCDMF Pamlico Sound Survey and number of shrimp trawl trips (effort lagged 1 year) in Pamlico Sound and Neuse, Pamlico and Pungo rivers (DMF 2012).

Abundances of Atlantic croaker and spot are variable with all three species showing overall increases in CPUEs from 1991 to 2010 and dropping again in 2011 (Figure 12.50). Shrimping effort in Pamlico Sound has decreased by 65% since 1995 (Figure 12.50). Regression analysis indicates that there are no significant relationships of decreasing commercial trawling effort with CPUE of Atlantic croaker ($r^2=0.04$; $p=0.46$), spot ($r^2=0.02$; $p=0.63$) and weakfish ($r^2=0.03$; $p=0.50$), suggesting that other factors may influence juvenile abundances of these three finfish in Pamlico Sound. However, the number of trips used here is the number of trip tickets recorded by the Trip Ticket Program and does not take into account the number of tows, the number of trawls used, the amount of headrope, or the number of days fished per trip ticket.

The identification and designation of Strategic Habitat Areas (SHA) for marine and coastal fishery species is a critical component in the implementation of the North Carolina's approved Coastal Habitat Protection Plan (CHPP). SHAs are defined in the CHPP as specific locations of individual fish habitat or systems of habitats that have been identified to provide exceptional habitat functions or that are particularly at risk due to imminent threats, vulnerability, or rarity (Deaton et al. 2010). The nomination process is meant to identify a possible subset of high quality areas that will maintain the diversity of habitats, species and ecological functions found within the overall ecosystem (Deaton et al. 2010). The Pamlico Sound Region or Region 2 was examined for SHA identification and nomination through a scientifically based process using biological data and a consensus based approach of a regional expert panel beginning in early

2010 and was completed in 2011 (DMF 2011). During this process, fish abundance data from DMF's Pamlico Sound Survey, described above and covering the Pamlico Sound, and the Neuse, Pamlico and Pungo rivers were included as a data layer in the analysis. Based on a series of statistical analysis, two groups of species were used as the basis of creating a data layer of fish abundances. One group included spot, croaker, pinfish, pigfish, hogchoker, southern flounder, harvestfish, weakfish, blue crab, silver perch, and white shrimp, while the other group included fringed flounder, planehead filefish, mantis shrimp, spadefish, southern kingfish, striped anchovy, lesser blue crab, bay whiff, summer flounder, inshore lizardfish, pink shrimp and brown shrimp. The fish and habitat data were used as targets in a site selection Software program to select a subset of areas containing a diversity of high quality biological features (DMF 2011).

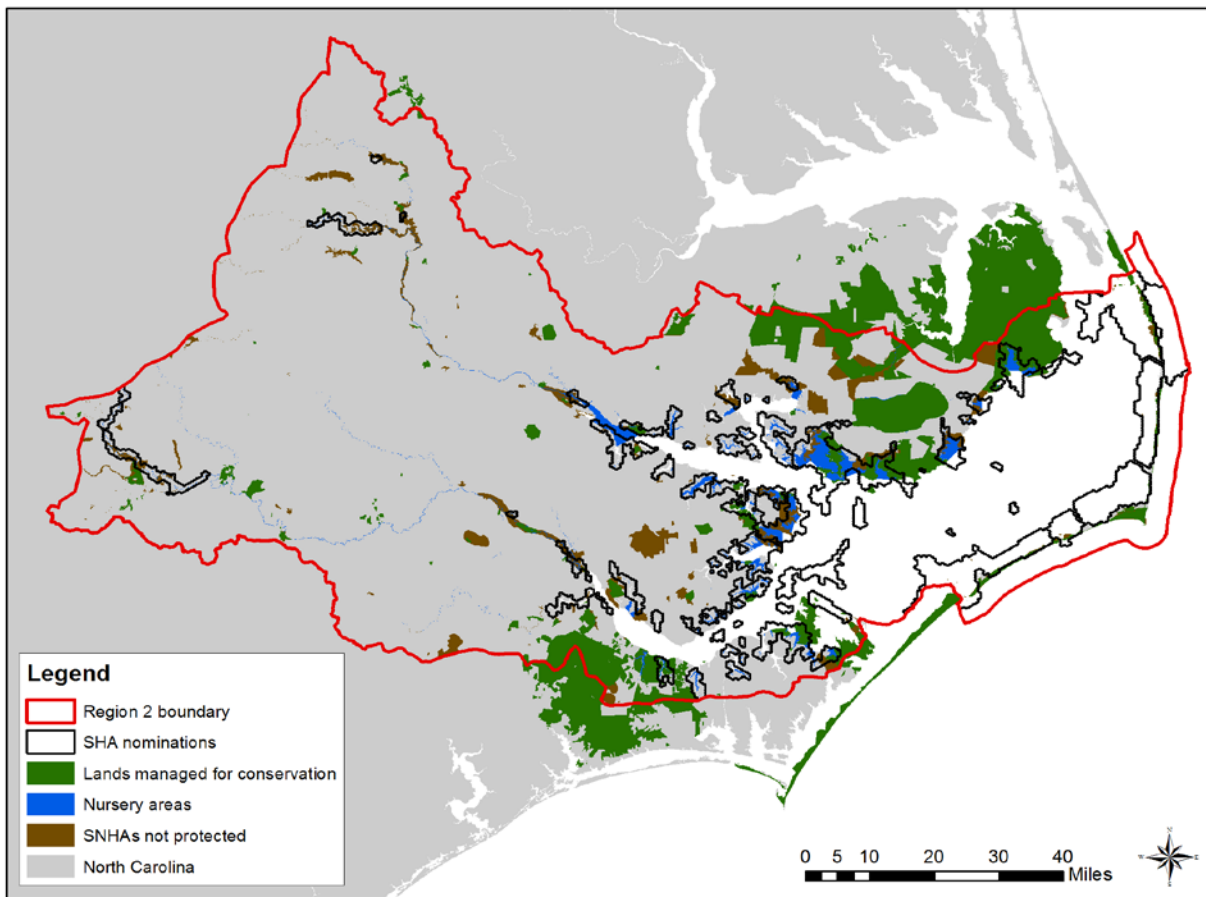


Figure 12.51 Strategic Habitat Area nominations and existing protected areas (DMF 2011)

Figure 12.51 illustrates those areas that have been nominated. The majority of the nominated areas occur along the edge of the sound including or adjacent to existing Primary and Secondary Nursery Areas, and the mouths of the rivers. These areas were selected because of their proximity to documented oyster habitat and/or their relatively high abundance of fish, based on the DMF data. Also with the inclusion of all designated PNA as a resource target, the model was influenced to provide connectivity with these PNA targets. The selected SHAs located in the center of Pamlico Sound consisted of soft bottom in waters greater than six feet in

depth that had relatively higher fish abundance, and trawling was the only documented alteration. Those SHAs located toward the mouths of the Pamlico and Neuse Rivers had subtidal oysters and SAV with bottom disturbing gear listed as the major alteration (DMF 2011).

The relatively greater amount of area selected as SHAs along the perimeter of the sound was due to the greater diversity of shallow productive habitats in those locations that support juvenile fish. These areas were also considered at greater risk from nearby activities that affect water quality such as development, marinas, and wetland ditching. In contrast, the center of Pamlico Sound had lower habitat diversity and fewer documented threats. These results indicate that the edges of Pamlico Sound, where benthic habitats and juvenile fish are more concentrated, may merit further protection from bottom disturbing fishing gear than the center of Pamlico Sound.

Prohibiting Shrimp Trawl Nets in Special Secondary Nursery Areas

Nursery Areas are fish habitat areas that for reasons such as food cover bottom type, salinity, temperature and other factors, young finfish and crustaceans spend the major portion of their initial growing season (15A NCAC 03I .0101(4)(f)). SNAs are those areas in the estuarine system where later juvenile development takes place. Populations are composed of developing sub-adults of similar size which have migrated from an upstream primary nursery area of the secondary nursery area located in the middle portion of the estuarine system. There are specific gear protections for designated PNAs such as the prohibition of the use of trawls, dredges, long haul, swipe seines, and mechanical methods for oysters and clams and the prohibition of trawls in SNAs.

Special Secondary Nursery Areas are SNAs where trawling may be allowed by the director through proclamation authority from August 16 through May 14 (Table 12.36). This enables fishermen to catch any shrimp late in the season that have not migrated out into the larger estuaries. There are approximately 37,400 acres of SSNAs located in Roanoke Sound, Pamlico and Pungo rivers, West Bay, Core Sound, North River, Newport River, New River, Chadwick Bay, IWW in Onslow/Pender County, Cape Fear River, Lockwood Folly River and Saucepan Creek in the Shallotte River. Of these areas, SSNAs in the Pamlico and Pungo rivers have not been open since 1990 (Table 12.36). Other areas in Pamlico and Pungo Rivers were reclassified as permanent secondary nursery areas because of having never been opened (Table 12.36). The North River SSNA was permanently closed in 1997 and Newport River SSNA was permanently closed through the 2006 Shrimp FMP. Both of these closures were due to the constant movement of lines. Permanent lines were established to eliminate this. Cape Fear, Lockwood Folly and Saucepan Creek SSNA also have not opened for many years.

In the 2006 FMP, it was recommended that Chadwick Bay be investigated to determine if it functioned as a secondary nursery area. Through DMF sampling, it was determined Chadwick Bay was a SSNA and closed by rule from May 15th through August 15th in April 2011.

Prohibiting shrimp trawls in SSNAs would eliminate bycatch in those areas and allow further protection of those juvenile finfish and shrimp using those areas before migration out into the sounds and ocean.

Table 12.36 Current and past designated special secondary nursery areas.

Current Rule ID 03R .0105	Description	Year Designated (reclassified)	Latest Year Opened	Proc Ref.	Comment
1 (a)	Outer Shallowbag Bay	2004	2013	SH-1-2013	Opened for peeler crab trawling. Will likely open August 18 for shrimp trawling
1 (b)	Kitty Hawk/Buzzard Bay	2004	2013	SH-1-2013	Opened for peeler crab trawling
2 (a)	Pungo Creek	1989	1990	SH-22-90	
2 (b)	Scranton Creek	1989	1990	SH-22-90	
2 (c)	Slade Creek	1989	1990	SH-22-90	
2 (d)	South Creek	1989	1990	SH-22-90	
2 (e)	Bond Creek	1989	1990	SH-22-90	
3 (a)	West Thorofare Bay	1986	2012	SH-15-2012	
3 (b)	Long Bay	1986	2012	SH-15-2012	
3 (c)	Turnagain Bay	1991	2012	SH-15-2012	
4 (a)	Cedar Island Bay	1986	2012	SH-15-2012	
4 (b)	Thorofare Bay	1986	2012	SH-15-2012	
4 (c)	Nelson Bay	1986	2012	SH-15-2012	
4 (d)	Brett Bay	1986	2012	SH-15-2012	
4 (e)	Jarrett Bay	1986	2012	SH-15-2012	
5 (a)	North River	1986	1997	SH-11-97	Closed through public negotiation
5 (b)	Ward Creek	1986	1997	SH-11-97	Closed through public negotiation
6	Newport River	1991	2006	SH-5-2006	Closed 2006 FMP
7	New River	1994	2012	SH-8-2012	
8	Chadwick Bay	2011	2012	SH-8-2012	Recommended in the 2006 FMP to investigate if functioned as a SSNA
9	IWW	1994	2012	SH-16-2012	
10	Cape Fear	1986	1987?	None?	
11	Lockwood Folly River	1986	1987?	None?	
12	Saucepan Creek	1986	1987?	None?	
03R .0104 3(c)	Upper Pamlico River	1989 (2004)	None	None	Reclassified to SNA
03R .0104 3(a)	Upper Pungo River	1989 (2004)	None	None	Reclassified to SNA
03R .0104 4(d)	Upper Broad Creek	1989 (2004)	None	None	Reclassified to SNA
03R .0104 4(e)	Goose Creek	1989 (2004)	None	None	Reclassified to SNA

Prohibiting Shrimp Trawl Nets in Brunswick County

The Brunswick County coastline stretches for approximately 33 miles and is bound by the Cape Fear River Inlet on the east end and by the Little River Inlet on the west end. Four barrier islands, all of which are densely developed are separated by five inlets along the coastline. The IWW channel from Sunset Beach Bridge to the South Carolina state line, including Eastern Channel, lower Calabash River and Shallotte River are frequently closed to trawling because of the abundance of small shrimp (Figure 12.52). The Shallotte River has been closed to shrimping since 1998, because shrimp rarely reach a large enough size to open and tend to remain at a 60-count (heads on) or greater size (Figure 12.52). The Division recommended that this area be permanently closed by rule during the development of the 2006 Shrimp FMP because of the abundance of small shrimp, but the Advisory Committee recommended *status quo* with the resulting management strategy being *status quo* (DMF 2006). Eastern Channel (Gause Creek), lower Calabash River, and Shallotte River have not been opened in recent years.

Logothetis and McCuiston (2006) described and quantified bycatch in the southern region of North Carolina, including the IWW in Brunswick County from April through November in 2004 and 2005. Bycatch generally were composed of juvenile to sub-adult fish with bycatch rates highest in April and May. Salinities were also found to affect bycatch rates with bycatch increasing with increasing salinity. The bycatch ratio reported was 0.68 in Brunswick County, meaning for every 1.0 lb of shrimp caught, there was 0.68 lb of bycatch caught. Although bycatch does not appear to be high, based on this ratio, the continuing occurrence of small shrimp in these areas warrants the consideration of making this area a permanent closure.

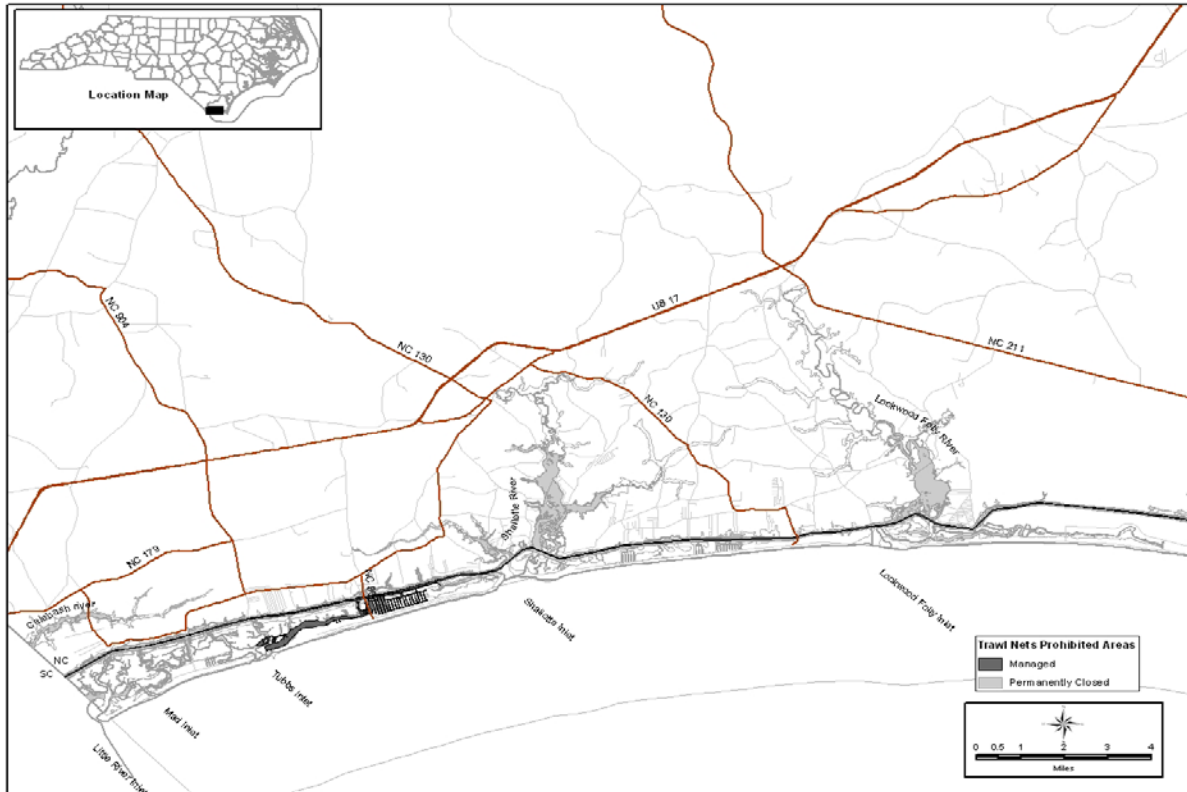


Figure 12.52 Brunswick County Shrimp Management Areas.

VII. EVALUATION MATRIX

AC Evaluation of Area Restrictions to Reduce Shrimp Trawl Bycatch in North Carolina's Internal Coastal Waters

Impacted Group	Shrimp Fishery			Other Fisheries	Agency		Other Impacts
	Management Option	Bycatch Reduction Impact	Economic Impact	Social Impact	Inter-fishery Impact	Enforceability	
1. <i>Status quo.</i>	Continues the existing amount of bycatch and bycatch mortality in the shrimp fishery. Continued reduction in effort may result in overall bycatch reduction in the fleet. N	Will not create shifts in effort to other fisheries. Maintains present market value of fishery. N	Allows flexibility of fishermen to continue to fish in their normal areas using their normal gears. N	Commercial and recreational fishing will continue with no changes in gear use or conflict. N	Same level of enforcement. Not Evaluated	No change in rule. Not Evaluated	Not Evaluated
2. Prohibit all shrimp trawling in all internal coastal waters.	Eliminates bycatch from shrimp trawls and skimmer trawls in all Internal Coastal waters. +	Severe reduction of the second most commercially valuable fishery in the state. Will likely create effort shifts into other fisheries. Will likely create economic losses to coastal fishing communities as well as shrimp fishermen, dealers, and related industries. -	Loss of a historical fishery. May be perceived by some of the public as a step forward in improved bycatch reduction. Will likely be perceived by the commercial public as unjust management. Greatly reduces the availability of NC caught shrimp. -	Will likely create conflicts with other commercial and recreational fishermen due to shift in effort. May improve recreational fishing for croaker, spot, and weakfish. +/-	Initial increased level of enforcement. Not Evaluated	Will require a rule change. Not Evaluated	Not Evaluated
3. Prohibit all shrimp trawling in Pamlico Sound and tributaries.	Eliminates bycatch from shrimp trawls and skimmer trawls in Pamlico Sound. +	Loss of a valuable commercial fishery. Will likely create effort shifts. Will likely create economic losses to coastal fishing communities as well as shrimp fishermen, dealers, and related industries. -	Loss of a historical fishery. Perceived by some of the public as a step forward in improved bycatch reduction. Will likely be perceived by the commercial public as unjust management. Greatly reduces the availability of NC caught shrimp. -	Will likely create conflicts with other commercial and recreational fishermen due to shift in effort. May or may not improve recreational fishing for croaker, spot, and weakfish. +/-	Initial increased level of enforcement. Not Evaluated	Will require a rule change. Not Evaluated	Not Evaluated

AC Evaluation of Area Restrictions to Reduce Shrimp Trawl Bycatch in North Carolina's Internal Coastal Waters

Impacted Group	Shrimp Fishery			Other Fisheries	Agency		Other Impacts
	Management Option	Bycatch Reduction Impact	Economic Impact	Social Impact	Inter-fishery Impact	Enforceability	
4. Prohibit all shrimp trawling in portions of Pamlico Sound to allow a buffer from sensitive habitats.	Eliminates bycatch from shrimp trawls and skimmer trawls along edge of PNAs and SNA in Pamlico Sound.	Possible loss of some income to smaller boats. Shrimp crop will filter out possibly resulting in larger shrimp.	May gain public support. Industry view may be mixed.	May or may not improve recreational fishing for croaker, spot, and weakfish.	Closure lines may be difficult to enforce.	May be implemented through proclamation.	
	+	+/-	N	+/-	Not Evaluated	Not Evaluated	Not Evaluated
5. Prohibit all shrimp trawling in Special Secondary Nursery Areas.	Eliminates bycatch from shrimp trawls and skimmer trawls in Special Secondary Nursery Areas.	Loss of income in latter part of season. Shrimp crop will filter out resulting in larger shrimp.	May gain public support. Industry view may be mixed. Eliminates grand openings.	Will likely create conflicts with other commercial fishermen due to shift in effort. May or may not improve recreational fishing for croaker, spot, and weakfish.	Initial increased level of enforcement.	Will require a rule change.	
<i>Decreasing the duration that SSNAs are open may be another option. See Effort paper issue paper</i>	+	+/-	+/-	+/-	Not Evaluated	Not Evaluated	Not Evaluated
6. Prohibit shrimp trawling in the IWW channel from Sunset Beach Bridge to the South Carolina state line, including Eastern Channel, lower Calabash River and Shallotte River.	Minimal decrease in bycatch. No waste of small shrimp.	Some loss of income to fishermen.	Minimal impact.	May or may not improve recreational fishing for croaker, spot, and weakfish.	Increased level of enforcement.	Will require a rule change.	
	+	-	N	+	Not Evaluated	Not Evaluated	Not Evaluated

DMF Evaluation of Area Restrictions to Reduce Shrimp Trawl Bycatch in North Carolina's Internal Coastal Waters

Impacted Group	Impacted Group			Impacted Group	Impacted Group		Impacted Group
Management Option	Management Option	Management Option	Management Option	Management Option	Management Option	Management Option	Management Option
1. <i>Status quo.</i>	Continues the existing amount of bycatch and bycatch mortality in the shrimp fishery. -	Will not create shifts in effort to other fisheries. Maintains present market value of fishery. N	Allows flexibility of fishermen to continue to fish in their normal areas using their normal gears. N	Commercial and recreational fishing will continue with no changes in gear use or conflict. N	Same level of enforcement. N	No change in rule. N	
2. Prohibit all shrimp trawling in all internal coastal waters.	Eliminates bycatch from shrimp trawls and skimmer trawls in all Internal Coastal waters +	Severe reduction of the second most commercially valuable fishery in the state. Will likely create effort shifts into other fisheries. Will likely create economic losses to coastal fishing communities as well as shrimp fishermen, dealers, and related industries. -	Loss of a historical fishery. May be perceived by some of the public as a step forward in improved bycatch reduction. Will likely be perceived by the commercial public as unjust management. Greatly reduces the availability of NC caught shrimp. -	Will likely create conflicts with other commercial and recreational fishermen due to shift in effort. -	Initial increased level of enforcement. -	Will require a rule change. -	
3. Prohibit all shrimp trawling in Pamlico Sound and tributaries.	Eliminates bycatch from shrimp trawls and skimmer trawls in Pamlico Sound. +	Loss of a valuable commercial fishery. Will likely create effort shifts. Will likely create economic losses to coastal fishing communities as well as shrimp fishermen, dealers, and related industries. -	Loss of a historical fishery. Perceived by some of the public as a step forward in improved bycatch reduction. Will likely be perceived by the commercial public as unjust management. Greatly reduces the availability of NC caught shrimp -	Will likely create conflicts with other commercial and recreational fishermen due to shift in effort. -	Initial increased level of enforcement. -	Will require a rule change. -	

DMF Evaluation of Area Restrictions to Reduce Shrimp Trawl Bycatch in North Carolina's Internal Coastal Waters

Impacted Group	Impacted Group			Impacted Group	Impacted Group		Impacted Group
Management Option	Management Option	Management Option	Management Option	Management Option	Management Option	Management Option	Management Option
4. Prohibit all shrimp trawling in portions of Pamlico Sound to allow a buffer from sensitive habitats.	Eliminates bycatch from shrimp trawls and skimmer trawls along edge of PNAs and SNA in Pamlico Sound. +	Possible loss of some income. Shrimp crop will filter out possibly resulting in larger shrimp. -/+	May gain public support. Industry view may be mixed. +	May reduce conflict . +	Closure lines may be difficult to enforce. -	May be implemented through proclamation. +	
5. Prohibit all shrimp trawling in Special Secondary Nursery Areas. <i>Decreasing the duration that SSNAs are open may be another option. See Effort paper issue paper</i>	Eliminates bycatch from shrimp trawls and skimmer trawls in Special Secondary Nursery Areas. +	Loss of income in latter part of season. Shrimp crop will filter out resulting in longer season and larger shrimp. -/+	May gain public support. Industry view may be mixed. Eliminates grand openings. +	Will likely create conflicts with other commercial and recreational fishermen due to shift in effort. -	Initial increased level of enforcement. -	Will require a rule change. -	.
6. Prohibit shrimp trawling in the IWW channel from Sunset Beach Bridge to the South Carolina state line, including Eastern Channel, lower Calabash River and Shallotte River.	Minimal decrease in bycatch. No waste of small shrimp. +	Some loss of income to fishermen. -	Minimal impact. -	No impact. N	Increased level of enforcement. -	Will require a rule change. -	

12.9 REMOVAL OF THE SHRIMP TRAWL FROM THE RECREATIONAL COMMERCIAL GEAR LICENSE

I. ISSUE

The consideration of eliminating the shrimp trawl as an authorized gear from the Recreational Commercial Gear License

II. ORIGINATION

The Shrimp Fishery Management Plan Advisory Committee at its May 15, 2013 meeting.

III. BACKGROUND

On August 14, 1997, the Fisheries Reform Act (FRA) was signed into law. One aspect of this law was the creation of the Recreational Commercial Gear License (RCGL). According to the Fisheries Moratorium Steering Committee (MSC), a group that provided the recommendations for the FRA, the purpose of creating this license was to: (1) allow individuals and families who have traditionally accessed the State's public trust fishery with commercial gear to supply themselves with fresh seafood; (2) limit the effort that may be expended by this class of fishermen both individually and as a group; and (3) implement the principle that all persons who harvest state public trust resources pay for that privilege by investing in coastal fisheries conservation and management (Moratorium Steering Committee, 1996). A statutory sunset clause in the FRA was put in place to test the RCGL concept, as well as other license types and would have expired if unsuccessful. DMF began selling this license July 1, 1999.

RCGL allows recreational fishermen to use limited amounts of commercial gear to harvest seafood for their personal consumption including a shrimp trawl with a maximum headrope length of 26 feet. Seafood harvested under this license cannot be sold. RCGL holders are limited to the same bag and size limits as Coastal Recreational Fishing License (CRFL) holders. The 2006 Shrimp Fishery Management Plan (FMP) added two new allowable RCGL gears, one shrimp pound and a 26 foot skimmer trawl. The FMP also limited all recreational harvesters, including RCGL holders to 48 quarts of head-on (32 quarts of head-off) shrimp per day, greatly reducing the harvest in some areas. If there are two valid license holders on board a vessel, then the shrimp possession limit may be doubled. The MFC also passed a rule allowing mechanical retrieval of the gear as long as a Turtle Excluder Device was properly installed in the trawl; prior to the FMP, shrimp trawls could only be retrieved by hand.

Many of the species taken by recreational users of commercial gear are included in fisheries management plans. Until 2002, the influence that RCGL holders may have on these species was unknown. Two surveys were used to collect information from RCGL holders; a socioeconomic survey, conducted in 2001, 2004, and 2007, and catch and effort surveys conducted monthly from 2002 through 2008. Both of these surveys were terminated in 2008 due to budget constraints.

IV. AUTHORITY

§ 113-134. Rules.

§ 113-173. Recreational Commercial Gear License.

§ 113-182. Regulation of fishing and fisheries.

IV. DISCUSSION

With the exception of 2002, the number of RCGLs sold on a fiscal basis has declined each year from 2000 through 2011 (Table 12.37); with a 29% decline overall. The largest single year decline occurred in 2011 (12%) followed by 2001 (8%). In 2009 and 2010 there was an average of 3.35% increase in sales. Twenty-five counties consistently comprise approximately 85% of the total number of RCGLs purchased each year.

Table 12.37 Number of license sales of Recreational Commercial Gear Licenses, 2002 through 2011 (fiscal year, July 1 through June 30).

Fiscal Year	Number of RCGLs Sold	Percent Change from Previous Sales Year
2000	6,740	
2001	6,202	-8.0
2002	6,300	1.6
2003	6,157	-2.3
2004	5,868	-4.7
2005	5,653	-3.7
2006	5,368	-5.0
2007	5,134	-4.4
2008	5,113	-0.4
2009	5,280	3.3
2010	5,458	3.4
2011	4,802	-12.0

Typical RCGL holders were married Caucasian males with an average age of 56. Findings from license sales statistics and the three socioeconomic surveys conducted in 2001, 2004, and 2007 indicated that coastal counties, in particular, southern coastal counties, substantially contributed to the overall number of RCGL holders.

The top three gears used by RCGL holders fishing in all regions of the coast were crab pot, small mesh gill net, and large mesh gill net. Shrimp trawls were the fourth most common gear used in the Pamlico, Southern, and Central Regions while fish pots were the fourth most common gear used in the Northern Region. On average the highest number of trips using shrimp trawls from 2002 to 2008 occurred in the Pamlico region, followed by the southern region, the central region, and the northern region (Table 12.38). In the Pamlico region, the number of trips ranged from 1,127 (2005) to 2,384 (2002), averaging 1,642 per year from 2002 to 2008. In the southern region, the number of trips ranged from 355 (2007) to 1,123 (2002), averaging 586 trips per year. An average of 413 trips a year were made in the central region, ranging from 132 (2008) to 1,070 (2002). In the Northern region, the number of trips ranged from 50 (2006) to 911 (2004). Overall, the highest number of trips made by RCGL holders using shrimp trawls was observed in 2002; the lowest was observed in 2007.

RCGL holders harvested an average of 52,352 pound of shrimp a year from 2002 to 2008 (Table 12.39). The highest landings occurred in 2002 (101,766 lb), followed by 2008 (54,359 lb) and 2003 (50,961 lb). RCGL holders harvested an average of 16.8 pounds of shrimp per trip from 2002 to 2008 (Table 3). The highest number of pounds of shrimp per trip was observed in 2009 (22.3 lb/trip), followed by 2006 (20.3 lb/trip) and 2002 (19.1 lb/trip).

Table 12.38 Number of trips by shrimp trawl by region, 2002-2008.

Year	Region				Total
	Southern	Central	Pamlico	Northern	
2002	1,123	1,070	2,384	742	5,319
2003	711	246	1,448	348	2,753
2004	392	318	2,122	911	3,743
2005	553	365	1,127	387	2,432
2006	471	464	1,441	50	2,426
2007	355	295	1,510	69	2,229
2008	500	132	1,464	337	2,433
Mean	586	413	1,642	406	3,048

Table 12.39 Harvest (lb) and pounds per trip of shrimp by RCGL gear from 2002-2008.

Year	Pounds	Pounds/trip
2002	101,766	19.1
2003	50,961	18.5
2004	43,698	9.3
2005	32,542	13.4
2006	49,362	20.3
2007	33,778	15.2
2008	54,359	22.3
Mean	52,352	16.8

When compared to North Carolina's commercial shrimp harvest statistics from the NC Trip Ticket Program the average yearly RCGL harvest contributes a little over 1.0% to the overall harvest of shrimp, but contribute 37% of the shrimp trawl effort in number of trips (Table 12.40).

Table 12.40 Commercial estuarine shrimp trawl harvest and Recreational Commercial shrimp trawl harvest, 2002-2008.

Year	Estuarine Commercial		RCGL	
	Pounds	Trips	Pounds	Trips
2002	7,511,154	10,030	101,766	5,319
2003	3,179,629	6,682	50,961	2,753
2004	2,581,743	5,358	43,698	3,743
2005	1,078,088	2,890	32,542	2,432
2006	2,891,435	3,255	49,362	2,426
2007	7,123,976	4,465	33,778	2,229
2008	6,764,108	4,206	54,359	2,433
Mean	4,447,162	5,269	52,352	3,048

However, it should be noted that the vast majority of the RCGL trips are single day trips, while commercial trip duration is quite variable depending on the location fished. Overall commercial trip duration has consistently averaged slightly more than 2 days across all areas.

Limited discard information is available for blue crab, Atlantic croaker, spot, flounder and shrimp which was consistently reported by those RCGL surveyed (Table 12.41). Several other species including Atlantic menhaden, pigfish, white perch, American shad, speckled trout, Spanish mackerel, sharks and rays reported too sporadically for an estimate.

Table 12.41 Recreational Commercial trawl discard numbers and trips, 2002-2008.

Year	Blue Crab		Atlantic Croaker		Spot		Flounder		Shrimp	
	Trips	Discarded	Trips	Discarded	Trips	Discarded	Trips	Discarded	Trips	Discarded
2002	3,301	96,404	560	26,197	322	9,949	2,011	9,949	5,050	1,397
2003	1,723	34,819	530	17,100	571	4,868	1,000	4,868	2,737	6,273
2004	2,583	39,480	781	21,438	611	12,896	996	12,896	3,655	4,313
2005	1,685	36,602	398	11,959	235	1,631	396	1,631	2,437	1,102
2006	1,448	11,875	582	34,605	476	18,339	605	18,339	2,352	13,028
2007	917	8,394	296	7,362	289	3,149	372	3,149	2,048	4,939
2008	1,172	29,301	256	8,161	270	8,013	540	8,013	2,252	6,165

Resource or conflict issues related to the RCGL since its implementation have been minimal. There have been instances, as with all gear, where the user was not acting responsibly. Reports to the DMF have ranged from shrimpers harvesting over the legal limit, improperly marked gear, and the illegal sale of RCGL harvested shrimp.

VII. EVALUATION MATRIX

AC Evaluation of Removal of the shrimp trawl from the recreational commercial gear license

Impacted Group	Shrimp Fishery			Other Fisheries	Agency		Other Impacts
	Management Option	Bycatch Reduction Impact	Economic Impact	Social Impact	Inter-fishery Impact	Enforceability	
<p>1. <i>Status quo</i></p> <p>(As evaluated in skimmer trawls and other gear paper on May 15, 2013)</p>	<p>Continues the existing amount of bycatch and bycatch mortality in the shrimp fishery. Effort reduction has resulted in reduced bycatch and will continue. Gear is more effective, even if effort is reduced.</p> <p align="center">+/-</p>	<p>Will not create shifts in effort to other fisheries. Maintains present market value of fishery.</p> <p align="center">+/-</p>	<p>Allows flexibility of use of gears in the fishery.</p> <p align="center">+</p>	<p>Commercial and recreational fishing will continue with no changes in gear use or conflict.</p> <p align="center">Not evaluated</p>	<p>Same level of enforcement.</p> <p align="center">Not evaluated</p>	<p>Continued proclamation authority. No rule change needed.</p> <p align="center">Not evaluated</p>	<p>Allows for further characterization and bycatch reduction studies to fill data gaps prior to new regulations.</p> <p align="center">Not evaluated</p>
<p>2. Eliminate otter trawls as an authorized gear of the Recreational Commercial Gear License</p> <p>AC Voted to not evaluate after presentation</p>	<p>Minimal impact to the existing amount of bycatch because of smaller percentage of fishery.</p>	<p>Loss of a food source thereby possibly increasing food expense. Value and function of gear purchased for RCGL shrimp fishery will be lost.</p>	<p>Removes ability of recreational fishermen to efficiently harvest larger quantities of shrimp for personal consumption.</p>	<p>May cause shift into other RCGL gear users.</p>	<p>Same level of enforcement.</p>	<p>Rule change required. Loss of license fees but possible increase in Standard Commercial Fishing License fees.</p>	

DMF Evaluation of Removal of the shrimp trawl from the recreational commercial gear license

Impacted Group	Shrimp Fishery			Other Fisheries	Agency		Other Impacts
	Management Option	Bycatch Reduction Impact	Economic Impact	Social Impact	Inter-fishery Impact	Enforceability	
<p>1. <i>Status quo</i></p> <p>(As evaluated in skimmer trawls and other gear paper on May 15, 2013)</p>	<p>Continues the existing amount of bycatch and bycatch mortality in the shrimp fishery. Effort reduction has resulted in reduced bycatch and will continue. Gear is more effective, even if effort is reduced.</p> <p align="center">+/-</p>	<p>Will not create shifts in effort to other fisheries. Maintains present market value of fishery.</p> <p align="center">+/-</p>	<p>Allows flexibility of use of gears in the fishery.</p> <p align="center">+</p>	<p>Commercial and recreational fishing will continue with no changes in gear use or conflict.</p> <p align="center">Not evaluated</p>	<p>Same level of enforcement.</p> <p align="center">Not evaluated</p>	<p>Continued proclamation authority. No rule change needed.</p> <p align="center">Not evaluated</p>	<p>Allows for further characterization and bycatch reduction studies to fill data gaps prior to new regulations.</p> <p align="center">Not evaluated</p>
<p>2. Eliminate otter trawls as an authorized gear of the Recreational Commercial Gear License</p>	<p>Minimal impact to the existing amount of bycatch because of smaller percentage of fishery.</p> <p align="center">+</p>	<p>Loss of a food source thereby possibly increasing food expense. Value and function of gear purchased for RCGL shrimp fishery will be lost.</p> <p align="center">-</p>	<p>Removes ability of recreational fishermen to efficiently harvest larger quantities of shrimp for personal consumption.</p> <p align="center">-</p>	<p>May cause shift into other RCGL gear users.</p> <p align="center">N</p>	<p>Same level of enforcement. .</p> <p align="center">N</p>	<p>Rule change required. Loss of license fees but possible increase in Standard Commercial Fishing License fees</p> <p align="center">-</p>	

12.10 BYCATCH MANAGMENT RECOMMENDATIONS

12.10.1 Trawling in the New River above the Highway 172 Bridge

Marine Fisheries Commission Preferred Management Strategy

Status quo (Continue to prohibit otter trawls in the New River special secondary nursery area above the Highway 172 Bridge)

Advisory Committee Recommendation

Allow skimmer and otter shrimp trawling in the New River special secondary nursery area (above the Highway 172 Bridge).

Division Recommendation

Status quo (Continue to prohibit otter trawls in the New River special secondary nursery area above the Highway 172 Bridge)

12.10.2 Evaluation of the skimmer trawl and other gears used for shrimping in North Carolina

Marine Fisheries Commission Preferred Management Strategies

Allow hand cast netting of shrimp in all closed areas and increase the limit to four quarts, with heads on per person.

Status quo on a license requirement to fish a cast net for shrimp

Advisory Committee and Division Recommendation

Allow hand cast netting of shrimp in all closed areas and increase the limit to four quarts, with heads on per person. **Division added “heads on”.**

Advisory Committee Recommendation

Require a fishing license from DMF to fish a cast net.

Division Recommendation

Status quo on a license requirement to fish a cast net for shrimp

12.10.3 The use of TEDs in commercial skimmer trawl operations

Marine Fisheries Commission Preferred Management Strategy

Upon federal adoption of TEDs in skimmer trawls, the division will support the federal requirement.

Advisory Committee Recommendation

Status quo

Division Recommendation

Upon federal adoption of TEDs in skimmer trawls, the division will support the federal requirement (Rule 15A NCAC 03L .0103 (g) allows for state enforcement).

12.10.4 Consideration of a commercial live bait shrimp fishery in North Carolina

Marine Fisheries Commission Preferred Management Strategy

Establish a permitted live shrimp bait fishery and for DMF to craft the guidelines and permit fees after reviewing permitted operations in other states, and to allow live bait fishermen with a permit to fish until 12 p.m. (noon) on Saturday.

Advisory Committee Recommendation

Establish a permitted live shrimp bait fishery and for DMF to craft the guidelines and permit fees after reviewing permitted operations in other states.

Division Recommendation

Status quo (continue to manage the live shrimp bait fishery the same as food shrimp fishery).

12.10.5 Gear Modifications in North Carolina shrimp trawls to reduce finfish bycatch

Marine Fisheries Commission Preferred Management Strategies

Allow any federally certified BRD in all internal and offshore waters of North Carolina.

Update the scientific testing protocol for the state's BRD certification program.

Convene a stakeholder group to initiate industry testing of minimum tail bag mesh size, T-90 panels, skylight panels, and reduced bar spacing in TEDs to reduce bycatch to the extent practicable with 40% target reduction.

- Upon securing funding, testing in the ocean and internal waters will consist of three years of data using test nets compared to a control net with a Florida fish eye, a federally approved TED, and a 1.5-inch mesh tailbag.
- Results should minimize shrimp loss and maximize reduction of bycatch of finfish. Promising configurations will be brought back to the MFC for consideration for mandatory use.
- This stakeholder group may be partnered with DMF and Sea Grant.
- Members should consist of fishermen, net/gear manufacturers and scientist/gear specialists.

Require either a T-90 panel/ square mesh tailbag or other applications of square mesh panels (e.g., skylight panel), reduced bar spacing in a TED, or another federal or state certified BRD in addition to existing TED and BRD requirements in all skimmer and otter trawls.

Advisory Committee Recommendations

Allow any federally certified BRD in all NC internal and offshore waters.

Update and certify bycatch reduction devices through the state bycatch reduction program.

Convene an ongoing stakeholder workgroup charged with suggesting new trawl gear or trawl gear modification.

Initiate industry testing of new or modified bycatch reduction devices and gear modifications under the supervision of the DMF. After testing and collection of scientific data, regulations should be implemented to require or allow such devices or modifications to be used in NC internal and offshore waters.

Test a three-inch bar-spaced turtle excluder device to see if it can be certified as a bycatch reduction device.

Allow the shrimp industry a two year period to test bycatch reduction devices.

Division Recommendations

Allow any federally certified BRD in all NC internal and offshore waters.

Update the scientific testing protocol for the state BRD certification program.

Convene a stakeholder group to initiate industry testing of minimum tail bag mesh size, T-90 panels, skylight panels, and reduced bar spacing in TEDs to reduce bycatch to the extent practicable.

- Upon securing funding, testing in the ocean and internal waters will consist of three years of data using test nets compared to a control net with a Florida Fish Eye, a federally approved TED, and a one and a half inch tailbag.
- Results should minimize shrimp loss and maximize reduction of bycatch of finfish. Promising configurations will be brought back to the MFC for consideration for mandatory use.
- This stakeholder group may be partnered with DMF and Sea Grant.
- Members could consist of fishermen, net/gear manufacturers and scientist/gear specialists.

Require either a T-90 panel/ square mesh tailbag or other applications of square mesh panel (e.g., skylight panel), reduced bar spacing in a TED, or another federal or state certified BRD in addition to existing TED and BRD requirements in all skimmer and otter trawls.

Marine Fisheries Commission Recommendation **At November 2013 MFC meeting, requested this recommendation be reviewed by public, regional and standing committees.*

**Convene a stakeholder group to initiate a three year study to test minimum tail bag mesh size, T-90 (square mesh) panels, skylight panels, reduced bar spacing in TEDs and any other new methods of reducing unwanted finfish bycatch to achieve a minimum of a 40 percent reduction of finfish by weight.*

- Compare these to a control net with a Florida fish eye, a federally approved TED, and a one and half inch mesh tail bag.
- The stakeholder group should partner with DMF and Sea Grant to help secure funding for the study.
- If the 40 percent target reduction by weight in finfish is not achieved, further restrictions will be placed on the shrimp trawl industry to achieve the 40 percent reduction.
- Additional restrictions on the shrimp trawl industry will be reviewed and discussed at that time.

12.10.6 Effort Management for bycatch reduction in the North Carolina shrimp trawl fishery

Marine Fisheries Commission Preferred Management Strategy

Status quo on effort management (no changes in season, weekend or nighttime fishing)

Advisory Committee Recommendation

Status quo (no changes in season, weekend or nighttime fishing)

Division Recommendation

Status quo (no changes in season, weekend or nighttime fishing)

12.10.7 Characterization of the North Carolina commercial shrimp trawl fleet

Marine Fisheries Commission Preferred Management Strategy

In order to put a cap on fleet capacity as a management tool, establish a maximum combined headrope length of 220 feet in all internal coastal waters where there are no existing maximum combined headrope requirements (i.e., 90 foot requirement) with a two-year phase out period.

Advisory Committee Recommendation

Status quo (no additional maximum combined headrope requirements)

Division Recommendation

In order to put a cap on fleet capacity as a management tool, establish a maximum combined headrope length of 220 feet in all internal coastal waters where there are no existing maximum combined headrope requirements (i.e., 90 foot requirement).

12.10.8 Area restrictions to reduce shrimp trawl bycatch in North Carolina's internal coastal waters

Marine Fisheries Commission Preferred Management Strategies

Prohibit shrimp trawling in the IWW channel from the Sunset Beach Bridge to the SC state line, including Eastern Channel, lower Calabash River and Shallotte River.

Recommend the MFC Habitat and Water Quality Advisory Committee to consider changing the designation of special secondary nursery areas that have not been opened to trawling since 1991 to permanent secondary nursery areas.

Advisory Committee and Division Recommendation

Prohibit shrimp trawling in the IWW channel from the Sunset Beach Bridge to the SC line, including Eastern Channel, lower Calabash River and Shallotte River.

Division Recommendation

Recommend the MFC Habitat and Water Quality Advisory Committee to consider changing the designation of special secondary nursery areas that have not been opened to trawling since 1991 to permanent secondary nursery areas. Based on the outcome of AC input, rule changes may follow under the authority of the Shrimp FMP.

12.11 PROPOSED RULES

12.11.1 Trawling in the New River above the Highway 172 Bridge

This rule modification prohibits the use of otter trawls above the Highway 172 Bridge in Onslow County by moving restrictions from proclamation into rule to continue reducing bycatch and protecting the New River Special Secondary Nursery Area.

15A NCAC 03J .0208 NEW RIVER

(a) It is unlawful to use trawl nets except skimmer trawls upstream of the Highway 172 Bridge over New River.

(b) It is unlawful to use ~~trawl nets~~ skimmer trawls upstream of the Highway 172 Bridge over New River from 9:00 P.M. through 5:00 A.M. when opened by proclamation from August 16 through November 30.

History Note: Authority G.S. 113-134; 113-182; 143B-289.52;
Eff. August 1, 1998;
Amended Eff. May 1, 2015, August 1, 2004.

12.11.2 Evaluation of the Skimmer Trawl and other gears used for shrimping in North Carolina

This rule modification allows cast-netting of shrimp in all areas otherwise closed to shrimping and increases the harvest limit.

15A NCAC 03L .0105 RECREATIONAL SHRIMP LIMITS

It is unlawful to:

- (1) Possess from areas open to the harvest of shrimp more than 48 quarts, heads on or 30 quarts, heads off, of shrimp per person per day or if a vessel is used, per vessel per day for recreational purposes except as provided in 15A NCAC 03O .0303 (e) and (f).

- ~~(2) Take or possess shrimp from areas closed to the taking of shrimp except two quarts of shrimp per person per day may be taken while fishing in a closed area with a cast net.~~
- (2) Take or possess more than four quarts, heads on or two and one-half quarts, heads off, of shrimp per person per day with a cast net from areas closed to the taking of shrimp in accordance with 15A NCAC 03L .0101.

History Note: Authority G.S. 113-134; 113-182; 143B-289.52;
Eff. April 1, 2009;
Amended Eff. May 1, 2015; June 1, 2013.

12.11.3 Gear Modifications in the North Carolina Shrimp Trawl to Reduce Finfish Bycatch

This rule modification changes the definition of mesh length so that it can be applied to diamond-mesh nets as well as square-mesh nets. This change is in support of the management strategy to require one additional bycatch reduction device in all skimmer and otter trawls, which can include a diamond-mesh "T-90" panel.

15A NCAC 03I .0101 DEFINITIONS

All definitions set out in G.S. 113, Subchapter IV and the following additional terms apply to this Chapter:

- (1) Enforcement and management terms:
- (a) Commercial Quota. Total quantity of fish allocated for harvest by commercial fishing operations.
 - (b) Educational Institution. A college, university or community college accredited by an accrediting agency recognized by the U.S. Department of Education.
 - (c) Internal Coastal Waters or Internal Waters. All coastal fishing waters except the Atlantic Ocean.
 - (d) Length of finfish.
 - (i) Curved fork length. A length determined by measuring along a line, tracing the contour of the body from the tip of the upper jaw to the middle of the fork in the caudal (tail) fin.
 - (ii) Fork length. A length determined by measuring along a straight line the distance from the tip of the snout with the mouth closed to the middle of the fork in the caudal (tail) fin, except that fork length for billfish is measured from the tip of the lower jaw to the middle of the fork of the caudal (tail) fin.
 - (iii) Pectoral fin curved fork length. A length of a beheaded fish from the dorsal insertion of the pectoral fin to the fork of the tail measured along the contour of the body in a line that runs along the top of the pectoral fin and the top of the caudal keel.
 - (iv) Total length. A length determined by measuring along a straight line the distance from the tip of the snout with the mouth closed to the tip of the compressed caudal (tail) fin.
 - (e) Recreational Possession Limit. Restrictions on size, quantity, season, time period, area, means, and methods where take or possession is for a recreational purpose.
 - (f) Recreational Quota. Total quantity of fish allocated for harvest for a recreational purpose.
 - (g) Regular Closed Oyster Season. March 31 through October 15, unless amended by the Fisheries Director through proclamation authority.
 - (h) Seed Oyster Management Area. An open harvest area that, by reason of poor growth characteristics, predation rates, overcrowding or other factors, experiences poor utilization of oyster populations for direct harvest and sale to licensed dealers and is designated by the Marine Fisheries Commission as a source of seed for public and private oyster culture.
- (2) Fishing Activities:

- (a) Aquaculture operation. An operation that produces artificially propagated stocks of marine or estuarine resources or obtains such stocks from permitted sources for the purpose of rearing in a controlled environment. A controlled environment provides and maintains throughout the rearing process one or more of the following:
 - (i) food,
 - (ii) predator protection,
 - (iii) salinity,
 - (iv) temperature controls, or
 - (v) water circulation,
 utilizing technology not found in the natural environment.
 - (b) Attended. Being in a vessel, in the water or on the shore and immediately available to work the gear and within 100 yards of any gear in use by that person at all times. Attended does not include being in a building or structure.
 - (c) Blue Crab Shedding. The process whereby a blue crab emerges soft from its former hard exoskeleton. A shedding operation is any operation that holds peeler crabs in a controlled environment. A controlled environment provides and maintains throughout the shedding process one or more of the following:
 - (i) food,
 - (ii) predator protection,
 - (iii) salinity,
 - (iv) temperature controls, or
 - (v) water circulation,
 utilizing technology not found in the natural environment. A shedding operation does not include transporting pink or red-line peeler crabs to a permitted shedding operation.
 - (d) Depuration. Purification or the removal of adulteration from live oysters, clams, and mussels by any natural or artificially controlled means.
 - (e) Long Haul Operations. Fishing a seine towed between two boats.
 - (f) Peeler Crab. A blue crab that has a soft shell developing under a hard shell and having a white, pink, or red-line or rim on the outer edge of the back fin or flipper.
 - (g) Possess. Any actual or constructive holding whether under claim of ownership or not.
 - (h) Recreational Purpose. A fishing activity that is not a commercial fishing operation as defined in G.S. 113-168.
 - (i) Shellfish marketing from leases and franchises. The harvest of oysters, clams, scallops, mussels, from privately held shellfish bottoms and lawful sale of those shellfish to the public at large or to a licensed shellfish dealer.
 - (j) Shellfish planting effort on leases and franchises. The process of obtaining authorized cultch materials, seed shellfish, and polluted shellfish stocks and the placement of those materials on privately held shellfish bottoms for increased shellfish production.
 - (k) Shellfish production on leases and franchises:
 - (i) The culture of oysters, clams, scallops, and mussels, on shellfish leases and franchises from a sublegal harvest size to a marketable size.
 - (ii) The transplanting (relay) of oysters, clams, scallops and mussels from areas closed due to pollution to shellfish leases and franchises in open waters and the natural cleansing of those shellfish.
 - (l) Swipe Net Operations. Fishing a seine towed by one boat.
 - (m) Transport. Ship, carry, or cause to be carried or moved by public or private carrier by land, sea, or air.
 - (n) Use. Employ, set, operate, or permit to be operated or employed.
- (3) Gear:
- (a) Bunt Net. The last encircling net of a long haul or swipe net operation constructed of small mesh webbing. The bunt net is used to form a pen or pound from which the catch is dipped or bailed.
 - (b) Channel Net. A net used to take shrimp which is anchored or attached to the bottom at both ends or with one end anchored or attached to the bottom and the other end attached to a boat.

- (c) Commercial Fishing Equipment or Gear. All fishing equipment used in coastal fishing waters except:
- (i) Cast nets;
 - (ii) Collapsible crab traps, a trap used for taking crabs with the largest open dimension no larger than 18 inches and that by design is collapsed at all times when in the water, except when it is being retrieved from or lowered to the bottom;
 - (iii) Dip nets or scoops having a handle not more than eight feet in length and a hoop or frame to which the net is attached not exceeding 60 inches along the perimeter;
 - (iv) Gigs or other pointed implements which are propelled by hand, whether or not the implement remains in the hand;
 - (v) Hand operated rakes no more than 12 inches wide and weighing no more than six pounds and hand operated tongs;
 - (vi) Hook-and-line and bait-and-line equipment other than multiple-hook or multiple-bait trotline;
 - (vii) Landing nets used to assist in taking fish when the initial and primary method of taking is by the use of hook and line;
 - (viii) Minnow traps when no more than two are in use;
 - (ix) Seines less than 30 feet in length;
 - (x) Spears, Hawaiian slings or similar devices, which propel pointed implements by mechanical means, including elastic tubing or bands, pressurized gas or similar means.
- (d) Corkline. The support structure a net is attached to that is nearest to the water surface when in use. Corkline length is measured from the outer most mesh knot at one end of the corkline following along the line to the outer most mesh knot at the opposite end of the corkline.
- (e) Dredge. A device towed by engine power consisting of a frame, tooth bar or smooth bar, and catchbag used in the harvest of oysters, clams, crabs, scallops, or conchs.
- (f) Fixed or stationary net. A net anchored or staked to the bottom, or some structure attached to the bottom, at both ends of the net.
- (g) Fyke Net. An entrapment net supported by a series of internal or external hoops or frames, with one or more lead or leaders that guide fish to the net mouth. The net has one or more internal funnel-shaped openings with tapered ends directed inward from the mouth, through which fish enter the enclosure. The portion of the net designed to hold or trap fish is completely enclosed in mesh or webbing, except for the openings for fish passage into or out of the net (funnel area).
- (h) Gill Net. A net set vertically in the water to capture fish by entanglement by the gills in its mesh as a result of net design, construction, mesh size, webbing diameter or method in which it is used.
- (i) Headrope. The support structure for the mesh or webbing of a trawl that is nearest to the water surface when in use. Headrope length is measured from the outer most mesh knot at one end of the headrope following along the line to the outer most mesh knot at the opposite end of the headrope.
- (j) Hoop Net. An entrapment net supported by a series of internal or external hoops or frames. The net has one or more internal funnel-shaped openings with tapered ends directed inward from the mouth, through which fish enter the enclosure. The portion of the net designed to hold or trap the fish is completely enclosed in mesh or webbing, except for the openings for fish passage into or out of the net (funnel area).
- (k) Lead. A mesh or webbing structure consisting of nylon, monofilament, plastic, wire or similar material set vertically in the water, held in place by stakes or anchors to guide fish into an enclosure. Lead length is measured from the outer most end of the lead along the top or bottom line, whichever is longer, to the opposite end of the lead.
- (l) Mechanical methods for clamming. Dredges, hydraulic clam dredges, stick rakes and other rakes when towed by engine power, patent tongs, kicking with propellers or deflector plates with or without trawls, and any other method that utilizes mechanical means to harvest clams.

- (m) Mechanical methods for oystering. Dredges, patent tongs, stick rakes and other rakes when towed by engine power and any other method that utilizes mechanical means to harvest oysters.
 - (n) Mesh Length. The ~~diagonal~~ distance from the inside of one knot to the outside of the ~~other~~ opposite knot, when the net is stretched ~~hand-tight~~ hand-tight in a manner that closes the mesh opening.
 - (o) Pound Net Set. A fish trap consisting of a holding pen, one or more enclosures, lead or leaders, and stakes or anchors used to support the trap. The lead(s), enclosures, and holding pen are not conical, nor are they supported by hoops or frames.
 - (p) Purse Gill Nets. Any gill net used to encircle fish when the net is closed by the use of a purse line through rings located along the top or bottom line or elsewhere on such net.
 - (q) Seine. A net set vertically in the water and pulled by hand or power to capture fish by encirclement and confining fish within itself or against another net, the shore or bank as a result of net design, construction, mesh size, webbing diameter, or method in which it is used.
- (4) Fish habitat areas. The estuarine and marine areas that support juvenile and adult populations of fish species, as well as forage species utilized in the food chain. Fish habitats as used in this definition, are vital for portions of the entire life cycle, including the early growth and development of fish species. Fish habitats in all coastal fishing waters, as determined through marine and estuarine survey sampling, include:
- (a) Anadromous fish nursery areas. Those areas in the riverine and estuarine systems utilized by post-larval and later juvenile anadromous fish.
 - (b) Anadromous fish spawning areas. Those areas where evidence of spawning of anadromous fish has been documented in Division sampling records through direct observation of spawning, capture of running ripe females, or capture of eggs or early larvae.
 - (c) Coral:
 - (i) Fire corals and hydrocorals (Class Hydrozoa);
 - (ii) Stony corals and black corals (Class Anthozoa, Subclass Scleractinia); or
 - (iii) Octocorals; Gorgonian corals (Class Anthozoa, Subclass Octocorallia), which include sea fans (*Gorgonia* sp.), sea whips (*Leptogorgia* sp. and *Lophogorgia* sp.), and sea pansies (*Renilla* sp.).
 - (d) Intertidal Oyster Bed. A formation, regardless of size or shape, formed of shell and live oysters of varying density.
 - (e) Live rock. Living marine organisms or an assemblage thereof attached to a hard substrate, excluding mollusk shells, but including dead coral or rock. Living marine organisms associated with hard bottoms, banks, reefs, and live rock include:
 - (i) Coralline algae (Division Rhodophyta);
 - (ii) *Acetabularia* sp., mermaid's fan and cups (*Udotea* sp.), watercress (*Halimeda* sp.), green feather, green grape algae (*Caulerpa* sp.) (Division Chlorophyta);
 - (iii) *Sargassum* sp., *Dictyopteris* sp., *Zonaria* sp. (Division Phaeophyta);
 - (iv) Sponges (Phylum Porifera);
 - (v) Hard and soft corals, sea anemones (Phylum Cnidaria), including fire corals (Class Hydrozoa), and Gorgonians, whip corals, sea pansies, anemones, *Solenastrea* (Class Anthozoa);
 - (vi) Bryozoans (Phylum Bryozoa);
 - (vii) Tube worms (Phylum Annelida), fan worms (*Sabellidae*); feather duster and Christmas treeworms (*Serpulidae*), and sand castle worms (*Sabellaridae*);
 - (viii) Mussel banks (Phylum Mollusca: Gastropoda); and
 - (ix) Acorn barnacles (Arthropoda: Crustacea: *Semibalanus* sp.).
 - (f) Nursery areas. Those areas in which for reasons such as food, cover, bottom type, salinity, temperature and other factors, young finfish and crustaceans spend the major portion of their initial growing season. Primary nursery areas are those areas in the estuarine system where initial post-larval development takes place. These are areas where populations are uniformly early juveniles. Secondary nursery areas are those areas

in the estuarine system where later juvenile development takes place. Populations are composed of developing sub-adults of similar size which have migrated from an upstream primary nursery area to the secondary nursery area located in the middle portion of the estuarine system.

- (g) Shellfish producing habitats. Those areas in which shellfish, such as clams, oysters, scallops, mussels, and whelks, whether historically or currently, reproduce and survive because of such favorable conditions as bottom type, salinity, currents, cover, and cultch. Included are those shellfish producing areas closed to shellfish harvest due to pollution.
- (h) Strategic Habitat Areas. Locations of individual fish habitats or systems of habitats that provide exceptional habitat functions or that are particularly at risk due to imminent threats, vulnerability, or rarity.
- (i) Submerged aquatic vegetation (SAV) habitat. Submerged lands that:
 - (i) are vegetated with one or more species of submerged aquatic vegetation including bushy pondweed or southern naiad (*Najas guadalupensis*), coontail (*Ceratophyllum demersum*), eelgrass (*Zostera marina*), horned pondweed (*Zannichellia palustris*), naiads (*Najas* spp.), redhead grass (*Potamogeton perfoliatus*), sago pondweed (*Stuckenia pectinata*, formerly *Potamogeton pectinatus*), shoalgrass (*Halodule wrightii*), slender pondweed (*Potamogeton pusillus*), water stargrass (*Heteranthera dubia*), water starwort (*Callitriche heterophylla*), waterweeds (*Elodea* spp.), widgeongrass (*Ruppia maritima*) and wild celery (*Vallisneria americana*). These areas may be identified by the presence of above-ground leaves, below-ground rhizomes, or reproductive structures associated with one or more SAV species and include the sediment within these areas; or
 - (ii) have been vegetated by one or more of the species identified in Sub-item (4)(i)(i) of this Rule within the past 10 annual growing seasons and that meet the average physical requirements of water depth (six feet or less), average light availability (secchi depth of one foot or more), and limited wave exposure that characterize the environment suitable for growth of SAV. The past presence of SAV may be demonstrated by aerial photography, SAV survey, map, or other documentation. An extension of the past 10 annual growing seasons criteria may be considered when average environmental conditions are altered by drought, rainfall, or storm force winds.

This habitat occurs in both subtidal and intertidal zones and may occur in isolated patches or cover extensive areas. In defining SAV habitat, the Marine Fisheries Commission recognizes the Aquatic Weed Control Act of 1991 (G.S. 113A-220 et. seq.) and does not intend the submerged aquatic vegetation definition, or rules 15A NCAC 03K .0304, .0404 and 03I .0101, to apply to or conflict with the non-development control activities authorized by that Act.

- (5) Licenses, permits, leases and franchises, and record keeping:
 - (a) Assignment. Temporary transferal to another person of privileges under a license for which assignment is permitted. The person assigning the license delegates the privileges permitted under the license to be exercised by the assignee, but retains the power to revoke the assignment at any time, is still the responsible party for the license.
 - (b) Designee. Any person who is under the direct control of the permittee or who is employed by or under contract to the permittee for the purposes authorized by the permit.
 - (c) For Hire Vessel. As defined by G.S. 113-174 when the vessel is fishing in state waters or when the vessel originates from or returns to a North Carolina port.
 - (d) Holder. A person who has been lawfully issued in their name a license, permit, franchise, lease, or assignment.
 - (e) Land:
 - (i) For commercial fishing operations, when fish reach the shore or a structure connected to the shore.

- (ii) For purposes of trip tickets, when fish reach a licensed seafood dealer, or where the fisherman is the dealer, when the fish reaches the shore or a structure connected to the shore.
- (iii) For recreational fishing operations, when fish are retained in possession by the fisherman.
- (f) Licensee. Any person holding a valid license from the Department to take or deal in marine fisheries resources.
- (g) Master. Captain of a vessel or one who commands and has control, authority, or power over a vessel.
- (h) New fish dealer. Any fish dealer making application for a fish dealer license who did not possess a valid dealer license for the previous license year in that name or ocean pier license in that name on June 30, 1999. For purposes of license issuance, adding new categories to an existing fish dealers license does not constitute a new dealer.
- (i) North Carolina Trip Ticket. Paper forms provided by the Division, and electronic data files generated from software provided by the Division, for the reporting of fisheries statistics, which include quantity, method and location of harvest.
- (j) Office of the Division. Physical locations of the Division conducting license and permit transactions in Wilmington, Washington, Morehead City, Columbia, Roanoke Island and Elizabeth City, North Carolina. Other businesses or entities designated by the Secretary to issue Recreational Commercial Gear Licenses or Coastal Recreational Fishing Licenses are not considered Offices of the Division.
- (k) Responsible party. Person who coordinates, supervises or otherwise directs operations of a business entity, such as a corporate officer or executive level supervisor of business operations and the person responsible for use of the issued license in compliance with applicable statutes and rules.
- (l) Tournament Organizer. The person who coordinates, supervises or otherwise directs a recreational fishing tournament and is the holder of the Recreational Fishing Tournament License.
- (m) Transaction. Act of doing business such that fish are sold, offered for sale, exchanged, bartered, distributed or landed.
- (n) Transfer. Permanent transferal to another person of privileges under a license for which transfer is permitted. The person transferring the license retains no rights or interest under the license transferred.

History Note: Authority G.S. 113-134; 113-174; 143B-289.52; Eff. January 1, 1991; Amended Eff. March 1, 1995; March 1, 1994; October 1, 1993; July 1, 1993; Recodified from 15A NCAC 03I .0001 Eff. December 17, 1996; Amended Eff. April 1, 1999; August 1, 1998; April 1, 1997; Temporary Amendment Eff. May 1, 2000; August 1, 1999; July 1, 1999; Amended Eff. August 1, 2000; Temporary Amendment Eff. August 1, 2000; Amended Eff. May 1, 2015; April 1, 2011; April 1, 2009; October 1, 2008; December 1, 2007; December 1, 2006; September 1, 2005; April 1, 2003; April 1, 2001.

12.11.4 Characterization of the North Carolina Commercial Shrimp Trawl Fleet

This rule modification establishes a maximum combined headrope length of 220 feet in all internal coastal waters where there are no existing maximum combined headrope requirements; a phase-out period is provided until January 1, 2017.

15A NCAC 03L .0103 PROHIBITED NETS, MESH SIZES-LENGTHS AND AREAS

- (a) It is unlawful to take shrimp with nets with mesh lengths less than the following:
 - (1) Trawl net - one and one-half inches;

- (2) Fixed nets, channel nets, float nets, butterfly nets, and hand seines - one and one-fourth inches; and
- (3) Cast net - no restriction.
- (b) It is unlawful to take shrimp with a net constructed in such a manner as to contain an inner or outer liner of any mesh ~~size-length~~. Net material used as chafing gear shall be no less than four inches mesh length except that chafing gear with smaller mesh may be used only on the bottom one-half of the tailbag. Such chafing gear shall not be tied in a manner that forms an additional tailbag.
- (c) It is unlawful to take shrimp with trawls which have a combined headrope of greater than 90 feet in ~~internal coastal waters except~~ Internal Coastal Waters in the following areas:
- (1) ~~Pamlico Sound;~~ North of the 35° 46.3000' N latitude line;
- (2) ~~Core Sound south of a line beginning at a point 34° 59.7942' N - 76° 14.6514' W on Camp Point; running easterly to a point 34° 58.7853' N - 76° 09.8922' W on Core Banks; to the South Carolina State Line;~~
- ~~(2)(3)~~ Pamlico River downstream-upstream of a line from a point 35° 18.5882' N - 76° 28.9625' W at Pamlico Point; running northerly to a point 35° 22.3741' N - 76° 28.6905' W at Willow Point; and
- ~~(3)(4)~~ Neuse River northeast-southwest of a line from a point 34° 58.2000' N - 76° 40.5167' W at Winthrop Point on the eastern shore of the entrance to ~~Adam's Creek~~ Adams Creek; running northerly to a point 35° 01.0744' N - 76° 42.1550' W at Windmill Point at the entrance of Greens Creek at Oriental.
- (d) Effective January 1, 2017 it is unlawful to take shrimp with trawls which have a combined headrope of greater than 220 feet in Internal Coastal Waters in the following areas:
- (1) Pamlico Sound south of the 35° 46.3000' N latitude line and north of a line beginning at a point 34° 59.7942' N - 76° 14.6514' W on Camp Point; running easterly to a point 34° 58.7853' N - 76° 09.8922' W on Core Banks;
- (2) Pamlico River downstream of a line from a point 35° 18.5882' N - 76° 28.9625' W at Pamlico Point; running northerly to a point 35° 22.3741' N - 76° 28.6905' W at Willow Point; and
- (3) Neuse River northeast of a line from a point 34° 58.2000' N - 76° 40.5167' W at Winthrop Point on the eastern shore of the entrance to Adams Creek; running northerly to a point 35° 01.0744' N - 76° 42.1550' W at Windmill Point at the entrance of Greens Creek at Oriental.
- ~~(e)~~ (e) It is unlawful to use a shrimp trawl in the areas described in 15A NCAC 03R .0114.
- ~~(f)~~ (f) It is unlawful to use channel nets except as provided in 15A NCAC 03J .0106.
- ~~(g)~~ (g) It is unlawful to use shrimp pots except as provided in 15A NCAC 03J .0301.
- ~~(h)~~ (h) It is unlawful to use a shrimp trawl that does not conform with the federal rule requirements for Turtle Excluder Devices (TED) as specified in 50 CFR Part 222.102 Definitions, 50 CFR Part 223.205 (a) and Part 223.206 (d) Gear Requirements for Trawlers, and 50 CFR Part 223.207 Approved TEDs. Copies of these rules are available via the Code of Federal Regulations posted on the Internet at <http://www.gpoaccess.gov/cfr/index.html> and at the Division of Marine Fisheries, P.O. Box 769, Morehead City, North Carolina 28557 at no cost.

*History Note: Authority G.S. 113-134; 113-182; 143B-289.52;
Eff. January 1, 1991;
Amended Eff. May 1, 2015; April 1, 2009; July 1, 2006.*

12.11.5 Area Restrictions to Reduce Shrimp Trawl Bycatch in North Carolina's Internal Coastal Waters

This rule modification prohibits shrimp trawling in the Intracoastal Waterway channel from the Sunset Beach Bridge to the South Carolina state line, including Shallotte River, Eastern Channel and lower Calabash River to protect small shrimp.

15A NCAC 03R .0114 SHRIMP TRAWL PROHIBITED AREAS

The shrimp trawl prohibited areas referenced in ~~15A NCAC 03L .0103(d)~~ 15A NCAC 03L .0103(e) are delineated in the following coastal water areas:

- (1) Pungo River - all waters upstream of a line from a point 35° 23.3166' N - 76° 34.4833' W at Wades Point; running ~~westerly~~ easterly to a point 35° 23.6463' N - 76° 31.0003' W on the north shore of the entrance to Abels Bay.

- (2) Pamlico River - all waters upstream of a line from a point 35° 20.5108' N - 76° 37.7218' W on the western shore of the entrance to Goose Creek; running northeasterly to a point 35° 23.3166' N - 76° 34.4833' W at Wades Point.
- (3) Neuse River - all waters upstream of a line from a point 34° 56.3658' N - 76° 48.7110' W at Cherry Point; running northerly to a point 34° 57.9116' N - 76° 48.2240' W at ~~Wilkinson~~ Wilkinson Point.
- (4) Shallotte River - all waters upstream of a line beginning at a point 33° 54.8285' N - 78° 22.3657' W on the west side of Shallotte River; running southeasterly to a point 33° 54.6276' N - 78° 21.7882' W on the east side of the river.
- (5) Eastern Channel - all waters of Eastern Channel east and north of a line beginning at a point 33° 52.6734' N - 78° 28.7339' W at Jinks Creek; running southerly to a point 33° 52.5942' N - 78° 28.6759' W at Tubbs Inlet; and south and west of a line beginning at a point 33° 53.6266' N - 78° 26.6262' W; running easterly to a point 33° 53.6501' N - 78° 26.5635' W.
- (6) Sunset Beach - all waters of the IWW west of a line beginning at a point 33° 52.9247' N - 78° 30.7041' W on the north end of the Highway 1172 Bridge; running southerly to a point 33° 52.8417' N - 78° 30.6490' W at the south end of the bridge.
- (7) Calabash River - all waters west of a line beginning at a point 33° 53.4368' N - 78° 32.9720' W on the north end of the Highway 1164 Bridge; running southerly to a point 33° 53.3534' N - 78° 32.9720' W at the south end of the bridge.

History Note: Authority G.S. 113-134; 113-182; 143B-289.52;
 Eff. July 1, 2006.
Amended Eff. May 1, 2015

12.11.6 Additional Rule Change to Address Clarity and Consistency

This rule modification clarifies the Fisheries Director's proclamation authority for shrimp harvest restrictions by making the rule consistent with other rules containing proclamation authority.

15A NCAC 03L .0101 SEASON~~SHRIMP HARVEST RESTRICTIONS~~

(a) It is unlawful to take shrimp with nets until the Fisheries Director, by proclamation, opens the season~~season~~ in various waters. Proclamations may specify any hours of day or night or both and any other conditions appropriate to management of the fishery. If sampling indicates primarily undersized shrimp or juveniles of any other species of major economic importance, the Fisheries Director may close such waters to shrimping and prohibit the use of nets for any purpose except cast nets as provided in 15A NCAC 3L .0102. Prominent landmarks or other permanent type markers shall be considered when establishing closure lines even if such lines extend beyond the area of concern.

(b) The Fisheries Director may, by proclamation, impose any or all of the following restrictions on the taking of shrimp:

- (1) specify time;
- (2) specify area;
- (3) specify means and methods;
- (4) specify season;
- (5) specify size; and
- (6) specify quantity.

History Note: Authority G.S. 113-134; 113-182; ~~113-224~~; 113-221.1; 143B-289.52;
 Eff. January 1, 1991.
Amended Eff. May 1, 2015

13.0 LITERATURE CITED

- Adkins, B. E., R.M. Harbo, and N. Bourne. 1983. An evaluation and management considerations of the use of a hydraulic clam harvester on intertidal clam populations in British Columbia. Canadian Manuscript Reports Fisheries Aquatic Science 1716: 38.
- Alverson, D. L. and S. E. Hughes, 1996. Bycatch: from emotion to effective natural resource management. Reviews in Fish Biology and Fisheries 6: 443–462.
- Alverson, D.L., M.H. Freeberg, S.A. Murawski and J.G. Pope. 1994. A global assessment of fisheries bycatch and discards. FAO Fisheries Technical Paper. No. 339, Rome, FAO. 233p.
- ASMFC (Atlantic States Marine Fisheries Commission). 1994. Acronyms, abbreviations, and technical terms used in ASMFC fishery management programs. Special Report No. 33 of the Atlantic States Marine Fisheries Commission, Washington D.C. 22p.
- ASMFC (Atlantic States Marine Fisheries Commission) 1996a. Fishery management plan and addendum 1 for scup. ASMFC FMR No. 26. Atlantic States Marine Fisheries Commission, Washington D.C.
- ASMFC (Atlantic States Marine Fisheries Commission) 1996b. Fishery management plan for black sea bass. ASMFC FMR No.28. Atlantic States Marine Fisheries Commission, Washington D.C.
- ASMFC (Atlantic States Marine Fisheries Commission) 1996c. Amendment 3 to the interstate fishery management plan for weakfish. ASMFC FMR No. 27. Atlantic States Marine Fisheries Commission, Washington D.C.
- ASMFC (Atlantic States Marine Fisheries Commission). 2000. Evaluating fishing gear impacts to submerged aquatic vegetation and determining mitigation strategies. ASFMC Habitat Management Series 5. 38p.
- ASMFC (Atlantic States Marine Fisheries Commission). 2003. Atlantic Croaker 2003 Stock Assessment Report. Atlantic States Marine Fisheries Commission. Washington, D.C. 151p.
- ASMFC (Atlantic States Marine Fisheries Commission). 2004. Atlantic Croaker 2004 Stock Assessment Supplement. Atlantic States Marine Fisheries Commission. Washington, D.C. 188p.
- ASMFC (Atlantic States Marine Fisheries Commission). 2009. Weakfish 2009 Stock Assessment Report. Atlantic States Marine Fisheries Commission. Washington, D.C. 396p.
- ASMFC (Atlantic States Marine Fisheries Commission) 2011a. 2010 Review of the Atlantic States Marine Fisheries Commission Fishery Management Plan for Spot (*Leiostomus xanthurus*) 2009 Fishing Year. Atlantic States Marine Fisheries Commission. Washington DC. 15p

- ASMFC (Atlantic States Marine Fisheries Commission). 2011b. Omnibus Amendment to the Interstate Fishery Management Plans For Spanish Mackerel, Spot, and Spotted Seatrout. Atlantic States Marine Fisheries Commission. Washington, D.C. 161p.
- Bales, J. D. and D.J. Newcomb. 1996. North Carolina wetland resources. p. 297-302 *in* R.M. Hirsch (dir). National Water Summary on Wetland Resources. U.S. Geological Survey, Atlanta, GA, USGS Water-Supply Paper 2425.
- Bellido, J. M., Santos, M.B., Pennino, M.G. Valeiras X., and G. J. Pierce. 2011. Fishery discards and bycatch: solutions for an ecosystem approach to fisheries management? *Hydrobiologia* 670: 317-333.
- Bielsa, L.M., W.H. Murdich, and R.F. Labisky. 1983. Species profiles: life histories and environment requirements of coastal fish and invertebrates (south Florida) – pink shrimp. U.S. Fish and Wildlife Service FWS/OBS-82/11.17. U.S. Army Corps of Engineers, TR EL-82-4. 21 pp.
- Brinson, M. M. 1977. Decomposition and nutrient exchange in litter in an alluvial swamp forest. *Ecology* 58: 601-609.
- Broome, J.D., Anderson, J.W., and D. W. Anderson. 2011. By-catch volume reduction through turtle excluder device (TED) reduced grid spacing. North Carolina Sea Grant Project # 10-FEG-03. 37p.
- Brown, K.B. 2006. Evaluation of Experimental Shrimp Pots from Carteret County to Brunswick County, North Carolina Completion report for NOAA award no. NA 05 NMF 4741003 North Carolina Department of Environment and Natural Resources, Division of Marine Fisheries, 19p.
- Brown, K.B. 2009. Characterization of the near-shore commercial shrimp trawl fishery from Carteret County to Brunswick County, North Carolina Completion report for NOAA award no. NA05NMF4741003 North Carolina Department of Environment and Natural Resources, Division of Marine Fisheries, 29p.
- Brown, K.B. 2010a. Compare catch rates of shrimp and bycatch of other species in standard (control) and modified (experimental) otter trawls in the Neuse River and Pamlico Sound, North Carolina Completion report for NOAA award no. NA08NMF474076 North Carolina Department of Environment and Natural Resources, Division of Marine Fisheries, 22p.
- Brown, K.B. 2010b. Characterization of the inshore commercial shrimp trawl fishery in Pamlico Sound and its tributaries, North Carolina Completion report for NOAA award no. NA05NMF4741003 North Carolina Department of Environment and Natural Resources, Division of Marine Fisheries, 28p.
- Brown, S. S., G.R. Gaston, C.F. Rakocinski, and R.W. Heard. 2000. Effects of sediment contaminants and environmental gradients on macrobenthic community trophic structure in Gulf of Mexico estuaries. *Estuaries* 23(3): 411-424.
- Browder, J.A., Zein-Eldin, Z., Criales, M.M., Robblee, M.B. Wong, S., Jackson, T.L. Johnson, D., 2002. Dynamics of pink shrimp (*Farfantepenaeus durarum*) recruitment potential in relation to salinity and temperature in Florida Bay. *Estuaries* 25: 1355-1371.

- Burkholder, J. M., K.M. Mason, and H.B. Glasgow Jr. 1992b. Water-column nitrate enrichment promotes decline of eelgrass *Zostera marina*: Evidence from seasonal mesocosm experiments. *Marine Ecology Progress Series* 81(2): 163-178.
- Buzzelli, C. P., R.A. Luetlich Jr., S.P. Powers, C.H. Peterson, J.E. McNinch, J.L. Pinckney, and H.W. Pearl. 2002. Estimating the spatial extent of bottom water hypoxia and habitat degradation in a shallow estuary. *Marine Ecology Progress Series* 230: 103-112.
- Byrne, D. M. 1995. The effect of bulkheads on estuarine fauna: a comparison of littoral fish and macroinvertebrate assemblages at bulkheaded and non-bulkheaded shorelines in a Barnegat Bay Lagoon. *Second Annual Marine Estuarine Shallow Water Science and Management Conference*: 53-56.
- Caillouet, C.W. Jr., R.A. Hart, J.M. Nance. 2008. Growth overfishing in the brown shrimp fishery of Texas, Louisiana, and adjoining Gulf of Mexico EEZ. *Fisheries Research* 92: 289-302.
- Carothers, P.E. and Chittendon, M.E., Jr. 1985. Relationships between trawl catch and tow duration for penaid shrimp. *Transactions of the American Fisheries Society* 114: 851-856.
- Carr, W.E. and C.A. Adams. 1973. Food Habits of juvenile marine fishes occupying seagrass beds in the estuarine zone near Crystal River, Florida. *Transactions of the American Fisheries Society* 102: 511-540.
- Cheuvront, B. 2002. A Social and Economic Analysis of Commercial Fisheries of Core Sound, North Carolina. North Carolina Department of Environment and Natural Resources, Division of Marine Fisheries, Morehead City, NC. (NOAA Award No. NA16FG1220-1).
- Cheuvront, B. 2003. A Social and Economic Analysis of Commercial Fisheries in North Carolina: Beaufort Inlet to the South Carolina State Line. North Carolina Department of Environment and Natural Resources, Division of Marine Fisheries, Morehead City, NC. (NC Technical Assistance to the South Atlantic Fisheries Management Council, Task 5: NEPA Related Activities, Contract No. SA-03-03-NC).
- Chopin, F.S. and T. Arimoto. 1995. The condition of fish escaping from fishing gears-a review. *Fisheries Research* 21:315-327.
- Chmura, G. L. and N.W. Ross. 1978. Environmental impacts of marinas and their boats. Rhode Island Sea Grant, Narragansett, RI, P675; RIU-T-78-005.
- Coale, J. S., R. A. Rulifson, J. D. Murray, and R. Hines. 1994. Comparisons of shrimp catch and bycatch between a skimmer trawl and an otter trawl in the North Carolina inshore shrimp fishery. *North American Journal of Fisheries Management* 14:751-768.
- Coen, L. D. and M.W. Luckenbach. 1998. Developing success criteria and goals for evaluating shellfish habitat restoration: ecological function or resource exploitation? *Goal Setting and Success Criteria for Habitat Restoration Conference*, January 13-15. Abstract only.
- Coen, L. E., M.W. Luckenbach, and D.L. Breitburg. 1999. The role of oyster reefs as essential fish habitat: a review of current knowledge and some new perspectives. p. 438-454 *in* L.R. Benaka (ed.). *Fish habitat: Essential fish habitat and rehabilitation*. American Fisheries Society, Bethesda, MD, Symposium 22, 459p.

- Coen, L. E., M.W. Luckenbach, and D.L. Breitburg. 1999. The role of oyster reefs as essential fish habitat: a review of current knowledge and some new perspectives. p. 438-454 *in* L.R. Benaka (editor). Fish habitat: Essential fish habitat and rehabilitation. American Fisheries Society, Bethesda, MD, Symposium 22, 459p.
- Collie, J. S., S.J. Hall, M.J. Kaiser, and I.R. Poiners. 2000. A quantitative analysis of fishing impacts on shelf-sea benthos. *Journal of Animal Ecology* 69: 785-798.
- Connell, B. and T. Murphey. 2004. A preliminary evaluation on the effects of dock shading on density and coverage of shoal grass (*Halodule wrightii*). DMF, Unpublished report.
- Cooper, S. R. and G.S. Brush. 1991. A 2500 year history of anoxia and eutrophication in the Chesapeake Bay. *Science* 254: 992-1001.
- Courtney A., J Haddy, M. Campbell, D. Roy, M. Tonks, S. Gaddes, K. Chilcott, M. O'Neil, I. Brown, M. McLennan, J. Jebreen, C. van der Geest, C. Rose, S. Kistle, C. Turnbull, P. Kyne, M. Bennet, and J. Taylor. 2007. Bycatch weight, composition and preliminary estimates of the impact of bycatch reduction devices in Queensland's trawl fishery. Queensland Department of Primary Industries and Fisheries. Department of Anatomy and Developmental Biology, University of Queensland. Australia Maritime College. Project no. 2000/170.
- Crosson, Scott .2007a. A Social and Economic Analysis of Commercial Fisheries in North Carolina: Albemarle and Pamlico Sounds. NC Department of Environment and Natural Resources, Division of Marine Fisheries, Morehead City, NC. (NOAA Award No. NA16FW1543), 25p.
- Crosson, Scott 2007b. A Social and Economic Analysis of Commercial Fisheries in North Carolina: Core Sound. NC Department of Environment and Natural Resources, Division of Marine Fisheries, Morehead City, NC. (NOAA Award No. NA16FW1543), 32p.
- Crosson, S. 2009. A Social and Economic Analysis of Commercial Fisheries in North Carolina. NC Department of Environment and Natural Resources, Division of Marine Fisheries, Morehead City, NC. (NOAA Award No. NA05NMF4741003), 26p.
- Crowder, L. B. and S. A. Murawski. 1998. Fisheries bycatch: Implication for management. *Fisheries* 24(6): 8-17.
- Currin, C. A., S.Y. Newell, and H.W. Paerl. 1995. The role of standing dead *Spartina alterniflora* and benthic microalgae in salt marsh food webs: considerations based on multiple stable isotope analysis. *Marine Ecology Progress Series* 121: 99-116.
- Dahl, T. E. 1990. Wetlands - losses in the United States, 1780's to 1980's. U.S. Fish and Wildlife Service, Washington, D.C., Report to Congress, 13p.
- Dauer, D. M., J.A. Ranasinghe, and S.B. Weisberg. 2000. Relationships between benthic community condition, water quality, sediment quality, nutrient loads, and land use patterns in Chesapeake Bay. *Estuaries* 23(1): 80-96.
- Davies, R. W. D., S. J. Cripps, A. Nickson & G. Porter, 2009. Defining and estimating global marine fisheries bycatch. *Marine Policy* 33: 661-672.

- DeAlteris, J., L. Skrobe, and C. Lipsky. 1999. The significance of seabed disturbance by mobile fishing gear relative to natural processes: A case study in Narragansett Bay, Rhode Island. *American Fisheries Symposium* 22: 14.
- Deaton, A.S., W.S. Chappell, K.Hart, J. O'Neal, B. Boutin. 2010. North Carolina Coastal Habitat Protection Plan. North Carolina Department of Environment and Natural Resources. Division of Marine Fisheries, NC. 639 pp.
- Deehr, R.A. 2012. Measuring the ecosystem impacts of commercial shrimp trawling and other fishing gear in Core Sound, North Carolina using ecological network analysis. Dissertation. East Carolina University, Coastal Resources Management Program. 410pp.
- DEHNR (NC Department of Environment Health and Natural Resources). 1990. North Carolina coastal marinas: water quality assessment. Department of Environment Health and Natural Resources, Raleigh, NC, 90-01, 69p.
- DeLancey, L.B., Jenkins, J.E., Maddox M. B., Whitaker J. D., Wenner E.L. 2005. Field observations on white shrimp, *Litopenaeus setiferus*, during spring spawning season in South Carolina, U.S.A., 1980-2003. *Journal of Crustacean Biology* 25: 212-218.
- Dennison, W. C., R.J. Orth, K.A. Moore, J.C. Stevenson, V. Carter, S. Kollar, P.W. Bergstrom, and R. Batiuk. 1993. Assessing water quality with submerged aquatic vegetation. *Bioscience* 43: 86-94.
- Diamond S.L. 2003. Estimation of bycatch in shrimp trawl fisheries: a comparison of estimation methods using field data and simulated data. *Fishery Bulletin* 101 (Supplement 3), 484–500.
- Diamond-Tissue, S. L. 1999. Characterization and estimation of shrimp trawl bycatch in North Carolina waters. Doctorate dissertation, North Carolina State University, Department of Zoology, Raleigh, NC 27695. 54 p.
- Diamond-Tissue, S.L. 1999b. The population effects of shrimp trawl bycatch on Atlantic croaker. Phd. Dissertation(draft). North Carolina State University, Department of Zoology, Raleigh, NC 27695. 58p.
- Durako, M. J. 1994. Seagrass die-off in Florida Bay (USA): changes in shoot demographic characteristics and population dynamics in *Thalassia testudinum*. *Marine Ecology Progress Series* 110: 59-66.
- DWQ (North Carolina Division of Water Quality). 2000. A citizen's guide to water quality management in North Carolina. DENR, Div. Water Quality, Planning Branch, Raleigh, NC, 156p.
- DWQ (North Carolina Division of Water Quality). 2011. Annual report of fish kill events. Department of Natural Resources, Raleigh, NC, 19p.
- Dyer, K. R. and R.J. Orth. 1994. Changes in fluxes in estuaries: implications from science to management. Olsen and Olsen, Fredenburg, Denmark.

- Eby and Crowder. 2002. Hypoxia-based habitat compression in the Neuse River Estuary: context-dependent shifts in behavioral avoidance thresholds. *Canadian Journal of Fisheries and Aquatic Sciences* 59(6): 952-965.
- Ellifrit, N. J., M.S. Uoshinaka, and D.W. Coon. 1972. Some observations of clam distribution at four sites on the Hook Canal, Washington. *Proceedings of the National Shellfish Association* 63: 7.
- Ellis, W. 1995. The intertidal distribution of the daggerblade grass shrimp: effects of vegetation assessed using bottomless liftnet samples. Twenty-third Benthic Ecology Meeting.
- EPA (U.S. Environmental Protection Agency). 2001. Hydromodification chapter factsheet. United States Environmental Protection Agency. Available: <http://www.epa.gov/OWOW/NPS/MMGI/hydro.html> (December 2001).
- Epperly, S. P. and S. W. Ross. 1986. Characterization of the North Carolina Pamlico-Albemarle estuarine complex. National Marine Fisheries Service - Southeast Fisheries Center, Beaufort, NC, NMFS-SEFC-175, 55p.
- Evans, D. W., R.D. Kathman, and W.W. Walker. 2000. Trophic accumulation and depuration of mercury by blue crabs (*Callinectes sapidus*) and pink shrimp (*Penaeus duorarum*). *Marine Environmental Research* 49(5): 419-434.
- Feierabend, S. J. and J.M. Zelazny. 1987. Status report on our nation's wetlands. National Wildlife Federation, Washington, D.C., 50p.
- Ferguson, R. L. and L.L. Wood. 1994. Rooted vascular aquatic beds in the Albemarle-Pamlico estuarine system. NMFS, NOAA, Beaufort, NC, Project No. 94-02, 103 p.
- Fonseca, M. S. 1996. The role of seagrasses in nearshore sedimentary processes: a review. p. 261-286 *in* C. Roman and K. Nordstrom (editors). *Estuarine Shores: Hydrological, Geomorphological and Ecological Interactions*. Blackwell, Boston, MA.
- Fonseca, M. S., W. J. Kenworthy, and G. W. Thayer. 1998. Guidelines for the conservation and restoration of seagrasses in the United States and adjacent waters. NOAA Coastal Ocean Office, Silver Springs, Md., NOAA Coastal Ocean Program Decision Analysis Series No. 12, 222p.
- Funderburk, S. L., J.A. Mihursky, S.J. Jordan, and D. Riley. 1991. Habitat requirements for Chesapeake Bay living resources. Habitat Objectives Workgroup, Living Resources Subcommittee and Chesapeake Research Consortium with assistance from Maryland Department of Natural Resources, Solomons, MD.
- Garbisch, E. W., P.B. Woller, W.J. Bostian, and R.J. McCallum. 1973. Biotic techniques for shore stabilization. p. 405-407 *in* L.E. Cronin (editor). *Estuarine Research*. Academic Press Inc., New York, NY, II.
- Garcia, A. 1989. White shrimp (*Penaeus setiferus*) recruitment overfishing. *Marine and Freshwater research*. 47:59-65.
- Georgia. 2012. Rules and Regulations of the State of Georgia.

- Gibson, M.R. 1994. Alternative estimates of weakfish bycatch in shrimp trawl fisheries in the south Atlantic using shrimp effort and relative weakfish abundance data. Report to the Atlantic States Marine Fisheries Commission.
- Gilmore, G. and Trent X. 1974. Abundance of benthic macroinvertebrates in natural and altered estuarine areas. NMFS, NOAA Technical Report NMFS SSRF - 677.
- GMFMC (Gulf of Mexico Fishery Management Council). 2007. Amendment 27 To The Reef Fish Fishery Management Plan and Amendment 14 to the Shrimp Fishery Management Plan with a Supplemental Environmental Impact Statement, Regulatory Impact Review, and Regulatory Flexibility Act Analysis. Gulf of Mexico Fishery Management Council. June 2007.
- Godcharles, M. F. 1971. A study of the effects of a commercial hydraulic clam dredge on benthic communities in estuarine areas. Florida Department of Natural Resources, St. Petersburg, FL, 51p.
- Goldsborough, W. J. and W.M. Kemp. 1988. Light responses of submersed macrophytes: implication for survival in turbid waters. *Ecology* 69: 1775-1786.
- Grabowski, J. H., D. Pettipas, M.A. Dolan, A.R. Hughes, and D.L. Kimbro. 2000. The economic and biological value of restored oyster reef habitat to the nursery function of the estuary. NC Sea Grant, Morehead City, NC, FRG # 97-EP-6, 29p.
- Graff, L. and J. Middleton. 2003. Wetlands and fish: catch the link. NOAA, National Marine Fisheries Service, Silver Springs, MD, 48p.
- Gray, J. S., R. S. Wu, and Y.Y. Or. 2002. Effects of hypoxia and organic enrichment on the coastal marine environment. *Marine Ecology Progress Series* 238: 249-279.
- Guthrie, J. F. and C. W. Lewis. 1982. The clam-kicking fishery of North Carolina. *Marine Fisheries Review* 44(1): 16-21.
- Hackney, C. T., J. Grimley, M. Posey, T. Alphin, and J. Hyland. 1998. Sediment contamination in North Carolina's estuaries. Center for Marine Science Research, UNC-W, Wilmington, NC, Publication #198, 59p.
- Hackney, C. T., M.H. Posey, S.W. Ross, and A.R. Norris. 1996. A review and synthesis of data on surf zone fishes and invertebrates in the South Atlantic Bight and the potential impacts from beach renourishment. Prepared for Wilmington District, US Army Corps of Engineers. UNC-Wilmington, Wilmington, NC, 111 p.
- Hall, M.A., D.L. Alverson, and K.I. Metuzals. 2000. By-catch: problems and solutions. *Marine Pollution Bulletin*. 41(1-6):204-219.
- Harrington, J. M., R. A. Myers, and A. A. Rosenberg. 2005. Wasted fishery resources: Discarded by-catch in the USA. *Fish Fish*. 6:350-361.
- Harrington, D., J. Watson, L. Parker, J. Rivers, and C. Taylor. 1988. Shrimp Trawl Design and Performance. Marine Extension Bulletin Number 12. Athens, GA: University of Georgia, Georgia Seagrass College Program.

- Hataway, D. 2010. Data Summary for 2" Bar Spacing TEDs compared to 4" Bar Spacing TEDs. Bycatch Reduction Engineering Project.
- Hines, K. L., R. A. Rulifson, and J. D. Murray. 1999. Performance of low-profile skimmer trawls in the inshore shrimp fishery of North Carolina. *North American Journal of Fisheries Management*. 19:569–580.
- Hawkins, J. H. 1980. Investigations of anadromous fishes of the Neuse River, North Carolina. DMF, Morehead City, NC, Special Science Report No. 34, 111p.
- Hettler, W. F. J. and D.L. Barker. 1993. Distribution and abundance of larval fish at two North Carolina inlets. *Estuarine, Coastal, and Shelf Sciences* 37: 161-179.
- Holland, B. F., Jr. 1988. Evaluation of Certified Trawl Efficiency Devices (TEDS) in North Carolina's Nearshore Ocean. N. C. Department of Natural Resources and Community Development, Division of Marine Fisheries, Completion Report, Project 2-439-R, 38 pp.
- Ianuzzi, T. J., M.P. Weinstein, K.G. Sellner, and J.C. Barrett. 1996. Habitat disturbance and marina development: An assessment of ecological effects. I. Changes in primary production due to dredging and marina construction. *Estuaries* 19(2A): 257-271.
- IMPLAN PRO version 2.0 (2000). Stillwater, MN: Minnesota IMPLAN Group.
- Ingraham, B. 2003. Night Vs. Day Bycatch Comparison for Shrimp Trawling in the Southern District of North Carolina. North Carolina Fisheries Resource Grant. FRG-98-FEG-46.
- Jackson, J. B. C., M. Kirby, W.H. Berger, K.A. Bjorndal, L.W. Botsford, B.J. Bourque, R.H. Bradbury, R. Cooke, J. Erlandson, J.A. Estes, T.P. Hughes, S. Kidwell, C.B. Lange, H.S. Lenihan, J.M. Pandolfi, C.H. Peterson, R.S. Steneck, M.J. Tegner, and R.R. Warner. 2001. Historical overfishing and the recent collapse of coastal ecosystems. *Science* 293: 629-638.
- Jennings S., M.J. Kaiser and J.D. Reynolds. 2001. *Marine Fisheries Ecology*.
- Johnson, G. A. 2003. The role of trawl discards in sustaining blue crab populations. North Carolina Fisheries Resource Grant. FRG-99-EP-07.
- Johnson, S.K. 1978. Handbook of Shrimp Diseases. Sea Grant College Program. TAMU-SG-75-603. Texas A&M University, College Station. 23p.
- Jones, R. A. and T.M. Sholar. 1981. The effects of freshwater discharge on estuarine nursery areas of Pamlico Sound. NC Division of Marine Fisheries, Morehead City, NC, Project CEIP 79-11, 60p.
- Kennedy, F.S. and D.G. Barber. 1981. Spawning and recruitment of pink shrimp, *Penaeus duorarum*, off Eastern Florida. *Journal of Crustacean Biology*. 1:474-485.
- Kelleher, K., 2005. Discards in the world's marine fisheries. An update. FAO Fisheries Technical Paper No. 470. FAO, Rome: 131 p.
- Kenworthy, W. J. and D.E. Haurert. 1991. The light requirements of seagrasses: proceedings of a workshop to examine the capability of water quality criteria, standards and

- monitoring progress to protect seagrasses. National Oceanic and Atmospheric Administration, Beaufort, NC, Tech. Memo. NMFS-SEFC-287, 181p.
- Kirby, J., W. Maher, and F. Krikowa. 2001. Selenium, cadmium, copper, and zinc concentrations in sediments and mullet (*Mugil cephalus*) from the southern basin of Lake Macquarie, NSW Australia. Archives of environmental contamination and toxicology 40(2): 246-256.
- Knott, D.M., P. L. Fuller, A. J. Benson, and M.E. Neilson. 2012. *Penaeus monodon*. USGS Nonindigenous Aquatic Species Database, Gainesville, FL. U.S. Geological Survey. Available: <http://nas.er.usgs.gov/queries/factsheet.aspx?SpeciesID=1209> (May 2011).
- Knuckey, I., R. Hudson, M. Koopman, S. Skoljarev, and J. Moore. 2008. Trials of T-90 mesh configuration in the Great Australian Bight Trawl Fishery. Australian Government. Fisheries Research and Development Corporation. FRDC Project 2007/063).
- Knutson, P. L. 1977. Planting guidelines for marsh development and bank stabilization. US Army Corps of Engineering Research Center, Fort Belvoir, Va.
- Kwon, Y. and C. Lee. 2001. Ecological risk assessment of sediment in wastewater discharging area by means of metal speciation. Microchemical Journal 70: 255-264.
- Larson, S.C, M.J. Van Den Avyle, E.L. Boseman, Jr. 1989. Species profiles: life histories and environment requirements of coastal fish and invertebrates (South Atlantic) – brown shrimp. U.S. Fish and Wildlife Service FWS/OBS-82/11.90. U.S. Army Corps of Engineers, TR EL-82-4. 14p.
- Lathman, F. F. 1951. Evidence of fish loss due to shrimping in Pamlico Sound. Committee Report to Atlantic States Marine Fisheries Commission, November 1, 1951. Appendix B, 4p.
- Lenihan, H. S. and C.H. Peterson. 1998. How habitat degradation through fishery disturbance enhances impacts of hypoxia on oyster reefs. Ecological Applications 8(1): 128-140.
- Lenihan, H. S., C.H. Peterson, J.E. Byers, J.H. Grabowski, and G.W. Thayer. 2001. Cascading of habitat degradation: oyster reefs invaded by refugee fishes escaping stress. Ecological Applications 11(3): 764-782.
- Lenihan, H. S. and F. Micheli. 2000. Biological effects of shellfish harvesting on oyster reefs: resolving a fishery conflict by ecological experimentation. Fishery Bulletin 98: 86-95.
- Lenihan, H. S., F. Micheli, S.W. Shelton, and C.H. Peterson. 1999. The influence of multiple environmental stressors on susceptibility to parasites: an experimental determination with oysters. Limnology and Oceanography 44: 910-924.
- Livingstone, D. R. 2001. Contaminant-stimulated reactive oxygen species production and oxidative damage in aquatic organisms. Marine Pollution Bulletin 42(8): 656-666.
- Loflin, R. K. 1995. The effects of docks on seagrass beds in the Charlotte Harbor estuary. Florida Scientist 58(2): 198-205.

- Logothetis, E. and D McCuiston. 2006. An assessment of the bycatch generated in the inside commercial shrimp fishery in southeastern North Carolina, 2004 & 2005. North Carolina Sea Grant Fisheries Resource Grant Program, Project #05-EP-04. 87 pp.
- Lowery, J. and K.T. Paynter. 2002. The importance of molluscan shell substrate. National Marine Fisheries Service, Unpublished report. 17p.
- Luetlich, R. A., J.E. McNinch, J.L. Pinckney, M.J. Alperin, C.S. Martens, H.W. Paerl, C.H. Peterson, and J.T. Wells. 1999. Neuse River estuary modeling and monitoring project, final report: Monitoring phase. Water Resources Research Institute, Raleigh, NC, 190p.
- Main, J., and G. Sangster. 1988. Scale damage and survival of young gadoid fish escaping from the codend of a demersal trawl. In: Proceedings of a workshop on "Trawl Net Selectivity and the Survival of Fish escaping from codends." University of Rhode Island Graduate School of Oceanography, May 16-17, 1988. Narragansett, Rhode Island. National Sea Grant Depository Publication #RIUW-88-002.
- Maiolo, J.R. 1981. "Historical Development of the Shrimp Fishery. In The Sociocultural Context and Occupational and Marketing Structures of the North Carolina Shrimp Fishery. Second Year Report to the NUC Sea Grant, Vol. 1.
- Maiolo, J.R. 2004. Hard Times and a Nickel a Bucket: Struggle and survival in North Carolina's shrimp industry. Chapel Hill, NC: Chapel Hill Press.
- Maiolo, J.R., J. Bort, W. Still, M. Fisch, R. Faisan. 1980. Historical development of the shrimp fishery (The sociocultural context and occupational and marketing structure of the North Carolina shrimp fishery. Greenville, NC: East Carolina University.
- Mangel, M. 1993. Effects of high seas driftnet fisheries on the Northern right whale dolphin *Lissodelphis borealis*. Ecological Applications. 3(2), 221-229.
- Manisseri, M. K. and N.R. Menon. 1995. Copper-induced damage to the hepatopancreas of the penaeid shrimp *Metapenaeus dobsoni* - an ultrastructural study. Diseases of Aquatic Organisms 22(1): 51-57.
- Manisseri, M. K. and N.R. Menon. 2001. Effect of sublethal copper on growth efficiency of the shrimp, *Metapenaeus dobsoni*. Journal of the Marine Biological Association of India 43(1-2): 81-90.
- Marburger, J. E., W.E. Johnson, T.S. Gross, D.R. Douglas, and J. Di. 2002. Residual organochlorine pesticides in soils and fish from wetland restoration areas in central Florida. Wetlands 22(4): 705-711.
- Marcus, J. M. and T.P. Stokes. 1985. Polynuclear aromatic hydrocarbons in oyster tissue around three coastal marinas. Bulletin of Environmental Contamination and Toxicology 35: 835-844.
- Matheson, R. E. Jr., D.K. Camp, S.M. Sogard, and K.A. Bjorgo. 1999. Changes in seagrass-associated fish and crustacean communities on Florida Bay mud banks: the effects of recent ecosystem changes? Estuaries 22(2B): 534-551.

- Matoura, R. F. C. and E.M.C. Woodward. 1983. Conservative behavior of riverine dissolved organic carbon in the Severn estuary: chemical and geochemical implications. *Geochimica Cosmochimica Acta* 47: 1293-1309.
- McCoy, E.G. 1968. Movement, growth and mortality of brown shrimp (*Penaeus aztecus*) marked and released in Swanquarter Bay, Pamlico Sound North Carolina. North Carolina Department of Conservation and Development, Division of Commercial and Sports Fisheries, Special Scientific Report No. 15, 26p.
- McCoy, E.G. 1972. Dynamics of North Carolina Commercial Shrimp Populations. North Carolina Department of Natural and Economic Resources, Division of Commercial and Sports Fisheries, Special Scientific Report No. 21, 53p.
- McCoy, E.G. and J.T. Brown. 1967. Migration and Growth of Commercial Penaeid Shrimps in North Carolina. Ann. Rep., Spec. Sci. Rep. 11, North Carolina Department of Conservation and Development, Division of Commercial and Sports Fisheries, 29 p.
- McKenna, S. and A.H. Clark. 1993. An examination of alternative fishing devices for the estuarine shrimp and crab trawl fisheries. Final Report to the Albemarle/Pamlico Estuarine Study, Project No. 93-11, 34p.
- McKenna, S. and J.T. Camp. 1992. An examination of the blue crab fishery in the Pamlico River estuary. Final Report to the Albemarle/Pamlico Estuarine Study, Project No. 92-08, 101p.
- McKenna, S. A. and J. P. Monaghan, Jr. 1993. Gear development to reduce bycatch in the North Carolina trawl fisheries. Completion Report for Cooperative Agreement No. NA90AA-SK052 to Gulf and South Atlantic Fisheries Development Foundation, Contract No. 43-01, North Carolina Department of Environment, Health, and Natural Resources, Division of Marine Fisheries.
- McKenna, S. A., G. Judy, C. P. Lewis, and J. Schoolfield. 1996. Evaluation of trawl efficiency device/bycatch reduction device in estuarine and nearshore waters of North Carolina. Completion Report NOAA, No. NA 47FF0016, North Carolina Department of Environment, Health, and Natural Resources, Division of Marine Fisheries, 37p.
- Meyer, D. L., E.C. Townsend, and P.L. Murphey. 1996. Final report for the project evaluation of restored wetlands and enhancement methods for existing restorations. National Oceanic and Atmospheric Administration, Office of Habitat Conservation Restoration Center, Silver Springs, MD.
- Micheli, F. M. and C. H. Peterson. 1999. Estuarine vegetated habitats as corridors for predator movement. *Conservation Biology* 13(4): 869-881.
- Minello, T. J. 1999. Nekton densities in shallow estuarine habitats of Texas and Louisiana and the identification of Essential Fish Habitat. p. 43-75 *in* Benaka, L. R. ed. *Fish Habitat: Essential Fish Habitat and Rehabilitation*. American Fisheries Society, Bethesda, Maryland, 459p.
- Minello, T.J. and R.J. Zimmerman. 1983. Fish predation on juvenile brown shrimp, *Penaeus aztecus* Ives: The effect of simulated *Spartina* structure on predation rates. *Journal of Experimental Marine Biology and Ecology* 72: 211-231.

- Minello, T.J., R.J. Zimmerman, E.X. Martinez .1989. Mortality of young brown shrimp, *Penaeus aztecus*, in estuarine nurseries. Transactions of American Fisheries Society 118: 693–708.
- Mitsch, W. J. and J.G. Gosselink. 1993. Wetlands, Second Edition. Van Nostrand Reinhold, New York, NY, Second Edition, 772p.
- Mock, C. R. 1966. Natural and altered estuarine habitats of penaeid shrimp. Proceedings Gulf Caribbean Fish Institute 19th Annual Session: 86-98.
- MSC (Moratorium Steering Committee). 1996. Final report of the Moratorium Steering Committee to the Joint Legislative Commission on Seafood and Aquaculture of the North Carolina General Assembly. N.C. Sea Grant College Program, Raleigh, NC, NC-SG-96-11, 155p.
- Muncy, R.J. 1984. Species profiles: life histories and environment requirements of coastal fish and invertebrates (south Atlantic) – white shrimp. U.S. Fish and Wildlife Service FWS/OBS-82/11.27. U.S. Army Corps of Engineers, TR EL-82-4, 19p.
- Murawski, S.A. 1995. Biological implications of bycatch. In Proceedings of the East Coast Bycatch Conference, April 7-8, 1995, p. 31-39.
- Murphey, P. L. and M. S. Fonseca. 1995. Role of high and low energy seagrass beds as nursery areas for *Penaeus duorarum* in North Carolina. Marine Ecology Progress Series 121: 91-98.
- Murray, J. D., J. J. Bahen, and R. A. Rulifson. 1991. Management Considerations for By-Catch in the North Carolina and Southeast Shrimp Fishery. Fisheries 17(1): 21-26.
- Murray, J. D., J. L. Gearhart, R. A. Rulifson, and C. W. Wescott. 1995. Introduction of large mesh webbing in the belly and wings of traditional shrimp trawls to reduce bycatch in inshore waters. Saltonstall-Kennedy Final Report, Project NA37FD008801, February 1995, 75p.
- Nance, J. M. (Editor). 1998. Report to Congress. Southeastern United States Shrimp Trawl Bycatch Program, 154p.
- Nance, J.M., C.W. Cailouet Jr., R.A. Hart. Size-composition of annual landings in the white shrimp, *Litopenaeus setiferus*, fishery of the Northern Gulf of Mexico, 1960-2006: Its trend and relationships with other fishery-dependent variables. Marine Fisheries Review. 72: 1-13.
- Newell, R. I. E. 1988. Ecological changes in the Chesapeake Bay: are they the result of overharvesting the American oyster? p. 536-546 in M.P. Lynch and E.C. Krome (eds.). Understanding the estuary: advances in Chesapeake Bay research. Chesapeake Bay Research Consortium, Baltimore, MD, Publication 129.
- NCDMF. North Carolina Division of Marine Fisheries Bycatch Reduction Device Certification Procedures.

- NCDMF (North Carolina Division of Marine Fisheries). 1991. Shrimp and crab trawling in North Carolina's estuarine waters. North Carolina Department of Environment and Natural Resources, Division of Marine Fisheries, 154p.
- NCDMF (North Carolina Division of Marine Fisheries). 1999. Shrimp and crab trawling in North Carolina's estuarine waters. DENR, Morehead City, NC, Report to NC Marine Fisheries Commission, 121p.
- NCDMF (North Carolina Division of Marine Fisheries). 2001. North Carolina oyster fishery management plan. N.C. Department of Environment and Natural Resources, Division of Marine Fisheries, 225p.
- NCDMF (North Carolina Division of Marine Fisheries). 2005. North Carolina southern flounder fishery management plan. North Carolina Department of Environment and Natural Resources, Division of Marine Fisheries, 335p.
- NCDMF (North Carolina Division of Marine Fisheries). 2006. North Carolina Fishery Management Plan for Shrimp. North Carolina Department of Environment and Natural Resources, Division of Marine Fisheries.
- NCDMF (North Carolina Division of Marine Fisheries). 2011. Strategic Habitat Area Nominations for Pamlico Sound System, North Carolina (Region 2) Final. North Carolina Department of Environment and Natural Resources. Division of Marine Fisheries, NC. 128 pp
- NCDMF (North Carolina Division of Marine Fisheries). 2012. North Carolina Fishery Management Plan for Shrimp Revision. North Carolina Department of Environment and Natural Resources, Division of Marine Fisheries.
- NCDMF (North Carolina Division of Marine Fisheries). 2012. Pamlico Sound Independent assessment. North Carolina Department of Environment and Natural Resources. Division of Marine Fisheries, NC. Grant NC-F-70128 pp.
- NCFA (North Carolina Fisheries Association). 2004. Press Release. Commerce finds four more countries dumped shrimp in U.S. Market. Available: <http://www.ncfish.org/article.asp?id=123> (July 2004).
- NMFS (National Marine Fisheries Service). 1995. Cooperative research program addressing finfish bycatch in the Gulf of Mexico and South Atlantic shrimp fisheries. NMFS Southeast Regional Office, St. Petersburg, Florida, 67p.
- NMFS and USFWS (National Marine Fisheries Service and U.S. Fish and Wildlife Service). 1991a. Recovery Plan for U.S. Population of Atlantic Green Turtle. National Marine Fisheries Service, Washington D.C., 52p.
- NMFS and USFWS (National Marine Fisheries Service and U.S. Fish and Wildlife Service). 1991b. Recovery Plan for U.S. Population of Loggerhead Turtle. National Marine Fisheries Service, Washington D.C., 64p.
- NMFS and USFWS (National Marine Fisheries Service and U.S. Fish and Wildlife Service). 1992. Recovery Plan for Leatherback Turtles in the U.S. Caribbean, Atlantic, and Gulf of Mexico. National Marine Fisheries Service, Washington, D.C., 65p.

- NMFS and USFWS (National Marine Fisheries Service and U.S. Fish and Wildlife Service). 1993a. Recovery Plan for the Kemp's Ridley Sea Turtle. National Marine Fisheries Service, St. Petersburg, Florida, 40p.
- NMFS and USFWS (National Marine Fisheries Service and U.S. Fish and Wildlife Service). 1993b. Recovery Plan for Hawksbill Turtles in the U.S. Caribbean Sea, Atlantic Ocean, and Gulf of Mexico. National Marine Fisheries Service, St. Petersburg, Florida, 52p.
- NOAA. 2004. Status of Bycatch Reduction Device (BRD) Performance and Research in North-Central and Western Gulf of Mexico. United States Department of Commerce. National Oceanic and Atmospheric Administration. National Marine Fisheries Service. Southeast Fisheries Science Center. Mississippi Laboratories. Pascagoula, Mississippi.
- National Oceanographic and Atmospheric Administration (NOAA). 2006. Bycatch in the South Atlantic, Gulf of Mexico, and Caribbean. Southeast Bycatch Workshop Proceedings May 16-18, 2006.
- NOAA. 2008. Bycatch Reduction Device Testing Manual. National Marine Fisheries Service. Southeast Regional Office. St. Petersburg, Florida
- NOAA (National Oceanic and Atmospheric Administration). 2010. List of Fisheries for 2011. Federal Register 75:215 (8 November 2010): 68468-68504.
- NOAA (National Oceanic and Atmospheric Administration). 2011. Fisheries Products. NOAA Fisheries: Office of Science and Technology. Available: http://www.st.nmfs.noaa.gov/st1/fus/fus10/07_supply2010.pdf (May 2012).
- National Marine Fisheries Service (NMFS). 2012a. Reinitiation of Endangered Species Act Section 7 Consultation on the Continued Implementation of the Sea Turtle Conservation Regulations, as Proposed to Be Amended, and the Continued Authorization of the Southeast U.S. Shrimp Fisheries in Federal Waters under the Magnuson-Stevens Act. Biological Opinion. May 8, 2012.
- NMFS (National Marine Fisheries Service). 2012. ESA Section 7 consultation on the continued implementation of the sea turtle conservation regulations, as proposed to be amended, and the continued authorization of the southeast U.S. shrimp fisheries in federal waters under the Magnuson-Stevens Act. Biological Opinion.
- Noble, E. B. and R.J. Monroe. 1991. Classification of Pamlico Sound Nursery Areas: Recommendations for Critical Habitat Criteria. North Carolina Department of Environment, Health, and Natural Resources, Morehead City, NC, A/P Project No. 89-09, 70p.
- North Carolina Sea Grant. 1997. Coastal water quality. NC State University, Raleigh, NC, UNC-SG-97-04, 72p.
- North Carolina State Demographics (2012). North Carolina Office of State Budget and Management. Available: <http://demog.state.nc.us>
- Orbach, M. K. and J. C. Johnson 1988. Transformation of Fishing Communities: A public policy perspective. In Marine Resource Utilization: A conference on social science issues. Proceedings of the Mississippi-Alabama Sea Grant Consortium, Mobile, Alabama.

- O'Rear, C. W. 1983. A study of river herring spawning and water quality in Chowan River. NC Department of Natural Resources and Community Development, DMF, Raleigh, NC, Complete Report, Project AFC-17, 31p.
- Orth, R. J., J. Simons, J. Capelli, V. Carter, L. Hindman, S. Hodges, K. Moore, and N. Rybicki. 1986. Distribution of submerged aquatic vegetation in the Chesapeake Bay and tributaries - 1985. US EPA, Washington, DC, Final report.
- Orth, R. J., K.A. Moore, and J.F. Nowak. 1990. Monitoring seagrass distribution and abundance patterns: A case study from the Chesapeake Bay. *in* US Fish and Wildlife Service. Federal coastal wetland mapping. U.S. Fish and Wildlife Service, Biological Report 90(18): 111-123.
- Paerl, H. W., J. Pinckney, J. Fear, and B. Peierls. 1998. Ecosystem response to internal watershed organic matter loading: Consequences for hypoxia in the eutrophying Neuse River Estuary, North Carolina. *Marine Ecological Progress Series* 166: 17-25.
- Paerl, H. W., M.M. Mallin, C.A. Donahue, M. Go, and B.L. Peierls. 1995. Nitrogen loading sources and eutrophication of the Neuse River, North Carolina: direct and indirect roles of atmospheric deposition. UNC - Chapel Hill, Water Resources Research Institute, Chapel Hill, NC, Publication 291.
- Pate, P. P. Jr. and R. Jones. 1981. Effects of upland drainage on estuarine nursery areas of Pamlico Sound, North Carolina. UNC Sea Grant, Raleigh, NC, Pub. No. UNC-SG-WP-10, 24p.
- Pattilo, M. E., D. M. N. T.E. Czapla, and M.E. Monaco. 1997. Distribution and abundance of fishes and invertebrates in Gulf of Mexico estuaries. Volume II: Species life history summaries. NOAA/NOS Strategic Environmental Assessment Division, Silver Springs, MD, ELMR Rep. No. 11. 377p.
- Pearce, K.B., D.W. Moyer, and S.K. Strasser. 1988. Evaluation of trawl excluder devices in the Pamlico Sound shrimp fishery. Albemarle-Pamlico Estuarine Study Rep. No.88-07. 46p.
- Peterson, B. J. and R.W. Howarth. 1987. Sulfur, carbon, and nitrogen isotopes used to trace organic matter flow in the salt-marsh estuaries of Sapelo Island, Georgia. *Limnology and Oceanography* 32(6): 1195-1213.
- Peterson, C. H., H.C. Summerson, and S.R. Fegley. 1987. Ecological consequences of mechanical harvesting of clams. *Fisheries Bulletin* 85(2): 281-298.
- Peterson, C. H., J.H. Grabowski, and S.P. Powers. 2003. Quantitative enhancement of fish production by oyster reef habitat: restoration valuation. *Marine Ecology Progress Series* 264: 249-264.
- Peterson, C. H. and N.M. Peterson. 1979. The ecology of intertidal flats of North Carolina: A community profile. U.S. Fish and Wildlife Service, OBS-79/39, 73 p.
- Peterson, M. S., B.H. Comyns, J.R. Hendon, P.J. Bond, and G.A. Duff. 2000. Habitat use by early life-stages of fishes and crustaceans along a changing estuarine landscape:

- difference between natural and altered shoreline sites. *Wetland, Ecology, and Management* 8(2-3): 209-219.
- Peuser, R. 1996. Estimates of finfish bycatch in the south Atlantic shrimp fishery. Final report Southeastern Area Monitoring and Assessment Program SEAMAP-south Atlantic Committee, Shrimp Bycatch Work Group, 62p.
- Price, A.B. and J.L. Gearhart. 2011. Evaluations of turtle excluder device (TED) performance in the U.S. southeast Atlantic and Gulf of Mexico skimmer trawl fisheries. NOAA technical Memorandum NMFS-SEFSC-615, 15p.
- Pulver, J. R., E. Scott-Denton and J.A. Williams. 2012. Characterization of the U.S. Gulf of Mexico skimmer trawl fishery based on observer coverage. NOAA Technical Memorandum NMFS-SEFSC-636, 27 p.
- Purvis, C.E., and E.G. McCoy. 1972. Overwintering Pink Shrimp (*Penaeus duorarum*) in Core and Pamlico Sounds, N.C. North Carolina Department of Natural and Economic Resources, Division of Commercial and Sports Fisheries, Special Scientific Report No. 21, 53p.
- Riggs, S. R., E.R. Powers, J. T. Bray, P.M. Stout, C. Hamilton, D. Ames, R. Moore, J. Watson, S. Lucas, and M. Williamson. 1989. Heavy metal pollutants in organic rich muds of the Pamlico River estuarine system: their concentration, distribution, and effects upon benthic environments and water quality: Albemarle-Pamlico Estuarine Study. Project No. 89-06. US EPA and NC DNRCD, Raleigh, NC, 108p.
- Riggs, S. R., J.T. Bray, E.R. Powers, C. Hamilton, D. Ames, D. Yeates, K. Owens, S. Lucas, J. Watson, and M. Williamson. 1991. Heavy metal pollutants in organic-rich muds of the Neuse River Estuary: their concentration and distribution. Albemarle-Pamlico Estuarine Study Report. Project no. 90-07. DENR, Raleigh, 168p.
- Roblee, M. B. and W.J. DiDomenico. 1992. Seagrass die-off in Florida Bay, Everglades National Park. *Park Science* 11: 21-23.
- Roelofs, E. W. 1950. Observations of the capture of small fish by the shrimp trawls. Annual Report, Institute of Fisheries Research UNC, Morehead City, NC: 111-115.
- Ross, S. W. and S.P. Epperly. 1985. Chapter 10: Utilization of shallow estuarine nursery areas by fishes in Pamlico Sound and adjacent tributaries, North Carolina. p. 207-232 *in* A. Yanez-Arancibia (ed.). *Fish Community Ecology in Estuaries and Coastal Lagoons: Towards and Ecosystem Integration*. DR (R) UNAM Press, Mexico, 654p.
- Rozaz, L.P., and T.J. Minello. 2011. Variation in penaeid shrimp growth rates along an estuarine salinity gradient: implications for managing river diversions. *Journal of Experimental Marine Biology and Ecology* 397: 196-207.
- Rozas, L. P. and R.J. Zimmerman. 2000. Small-scale patterns of nekton use among marsh and adjacent shallow nonvegetated areas of the Galveston bay estuary, Texas (USA). *Marine Ecology Progress Series*. 193: 217-239.

- Rozas, L. P. and W.E. Odum. 1987. The role of submerged aquatic vegetation in influencing the abundance of nekton on contiguous tidal freshwater marshes. *Journal of Experimental Marine Biology and Ecology* 114(2-3): 289-300.
- Rudershausen, P. J., and J. F. Weeks. 1999. Mechanical efficiency of experimental skimmer trawl frames. North Carolina Sea, Project#. 99-FEG-31, 24 p.
- SAFMC (South Atlantic Fishery Management Council). 1993. Fishery management plan for the shrimp fishery of the South Atlantic region including a final environmental impact statement and regulatory impact review. SAFMC, Charleston, SC, 184 pp. + appendices.
- SAFMC (South Atlantic Fishery Management Council). 1998. Final habitat plan for the South Atlantic region: Essential Fish Habitat requirements for fishery management plans of the South Atlantic Fishery Management Council. SAFMC, Charleston, SC.
- Sanger, D. M. and A.F. Holland. 2002. Evaluation of the impacts of dock structures on South Carolina estuarine environments. SC Department of Natural Resources, Marine Resources Research Institute, Charleston, SC, Tech. Rep. No. 99, 82p.
- Saoud, P., and D. A. Davis. 2003. Salinity tolerance of brown shrimp *Farfantepenaeus azetecus* as it relates to postlarval and juvenile survival, distribution, and growth in estuaries. *Estuaries* 26: 970-974.
- Schoof, R. 1980. Environmental impact of channel modification. *Water Resources Bulletin* 16(4): 697-701.
- Schueler, T. R. 1997. Impact of suspended and deposited sediment. *Watershed Protection Techniques* 2(3): 443-444.
- Scott-Denton, E., P. Cryer, J. Gockett, M. Harrelson, K. Jones, J. Nance, J. Pulver, R. Smith, and J.A. Williams. 2006. Skimmer Trawl Fishery Catch Evaluations in Coastal Louisiana, 2004 and 2005. *Marine Fisheries Review* 2006, Vol 68 (1-4): 30 - 35.
- Scientific Council on Amphibians and Reptiles. 2011. Reevaluation of Status Listings for Jeopardized Amphibians and Reptiles in North Carolina. Submitted to the Nongame Wildlife Advisory Committee of the North Carolina Wildlife Resources Commission.
- Seldberg, C. D., L.A. Eby, and L.B. Crowder. 2001. Hypoxia in the Neuse River Estuary: Responses of blue crabs and crabbers. *North American Journal of Fisheries Management* 21(2): 358-366.
- Sessions, K. and T. Thorpe. 2006. Catch potential and condition of shrimp and by-catch associated with a new commercial shrimp set design and new RCGL shrimp set design. North Carolina Sea Grant Project # 05-FEG-12. 48p.
- Shafer, D. J. 1999. The effects of dock shading on the seagrass *Halodule wrightii* in Perdido Bay, Alabama. *Estuaries* 22(4): 936-943.

- Shervette, V.R. and F. Gelwick. 2008. Relative nursery function of oyster, vegetate marsh edge, and nonvegetated bottom habitats for juvenile white shrimp (*Litopenaeus setiferus*). *Wetlands Ecology Mangement* 16: 405-419.
- Simpson, D.G. 1990. A study of Marine Recreational Fisheries in Connecticut. Federal Aid in Sport Fish Restoration Project F-54-R, Job 8 Final Report. Connecticut Department of Energy and Environmental Protection, Bureau of Fisheries and Wildlife, Division of Marine Fisheries, 3p.
- Smith, E.M. and P.T. Howell. 1987. The effects of bottom trawling on American lobster, *Homarus americanus*, in Long Island Sound. *Fisheries Bulletin* 85(4): 737-744.
- Smolowitz, R. 1983. Mesh size and the New England groundfishery-applications and implications. NOAA Tech Report. NMFS SSRF-771.
- STAC (Sea Turtle Advisory Committee). 2006. Sea turtle interactions with North Carolina fisheries review and recommendations to the North Carolina Marine Fisheries Commission. North Carolina Department of Natural Resources, Division of Marine Fisheries, 72p.
- St. Amant, L.S., and J.G. Broom, and T.B. Ford. 1965. Studies of the brown shrimp, *Penaeus aztecus*, in Barataria Bay, Louisiana. 1965. *Bulletin of Marine Science of the Gulf and Caribbean*. 18: 1-16.
- Steele, P. 2002. Stock assessment profile for the penaeid shrimp fisheries of the southeastern United States and Gulf of Mexico. Report to the Florida Marine Fisheries Commission. 227p.
- Stevenson, J. C., L.W. Staver, and K.W. Staver. 1993. Water quality associated with survival of submerged aquatic vegetation along an estuarine gradient. *Estuaries* 16(346-361).
- Takade-Heumacher, H. and C. Batsavage. 2009. Stock status of North Carolina southern flounder (*Paralichthys lethostigma*). North Carolina Department of Environment and Natural Resources, Division of Marine Fisheries, Morehead City, NC. 93 p.
- Tarplee, W. H. Jr., D.E. Louder, and A.J. Weber. 1971. Evaluation of the effects of channelization on fish populations in North Carolina's coastal plain streams. North Carolina Wildlife Resources Commission, Raleigh, NC.
- Teal, J. 1962. Energy flow in salt marsh macrophyte production: a review. *Ecology* 43: 614-624.
- Tenore, K. R. 1972. Macrobenthos of the Pamlico River estuary, North Carolina. *Ecological Monographs* 42: 51-69.
- Thayer, G. W., W.J. Kenworthy, and M.S. Fonseca. 1984. The ecology of eelgrass meadows of the Atlantic coast: a community profile. U.S. Fish and Wildlife Service, FWS/OBS-84/02, 147p.
- Theiling, D. 1988. Assessment of participation and resource impact of shrimp baiting in coastal South Carolina during 1987. S.C. Marine Research Center Technical Report No. 69. 41p.

- Turner, R. E. 1977. Intertidal vegetation and commercial yields of Penaeid shrimp. Transactions of the American Fisheries Society 106(5): 411-416.
- Twilley, R. R., W.M. Kemp, K.W. Staver, J.C. Stevenson, and W.R. Boynton. 1985. Nutrient enrichment of estuarine submersed vascular plant communities. 1. Algal growth and effects on production of plants and associated communities. Marine Ecology Progress Series 23: 179-191.
- Uncles, R. J., J.A. Stephens, and T.Y. Woodrow. 1988. Seasonal cycling of estuarine sediment and contaminant transport. Estuaries 11: 108-116.
- U.S. Department of Commerce. 2003. Fisheries of the United States, 2002. Current Fishery Statistics No. 2002. National Oceanic and Atmospheric Administration, National Marine Fisheries Service.
- Vaughan, D.S. 1994. Incorporation of shrimp trawl bycatch in the assessment of Atlantic weakfish stock, 1982-1992. Report to ASMFC weakfish Technical Committee, National Marine Fisheries Service, Beaufort, N.C. Lab.
- Vaughan, D.S., and J.M. Nance. 1998. Estimates of bycatch of mackerel and cobia in U.S. south Atlantic shrimp trawls. Report to Gulf of Mexico and South Atlantic Fishery Management Councils, 25 pp.
- Vaughan, D.S., R.J. Seagraves and K. West. 1991. An assessment of the status of the Atlantic weakfish stock, 1982-1988. Special Report No. 21. Atlantic States Marine Fisheries Commission.
- Voudrias, E. A. and C.L. Smith. 1986. Hydrocarbon pollution from marinas in estuarine sediments. Estuarine Coastal Shelf Sciences 22: 271-284.
- Walker T., J. Newman, and I. Knuckley. 2010. Promoting industry uptake of gear modifications to reduce bycatch in the South East trawl fishery. Australian Government: Fisheries Research and Development Corporations. Project no. 2001/006.
- Wannamaker, C. M. and J.A. Rice. 2000. Effects of hypoxia on movements and behavior of selected estuarine organisms from the southeastern United States. Journal of Experimental Marine Biology and Ecology 249: 145-163.
- Wassenberg, T.J. and B.J. Hill. 1989. The effect of trawling and subsequent handling on the survival rates of the by-catch of Prawn trawlers in Moreton Bay, Australia. Fisheries Research 7: 99-110.
- Waters, C. T. and C.D. Thomas. 2001. Shoreline hardening effects on associated fish assemblages in five North Carolina coastal rivers. North Carolina Wildlife Resources Commission, Raleigh, NC, 20p.
- Watson, J. W. 1984. *Configurations and relative efficiencies of shrimp trawls employed in southeastern United States waters*. US Department of Commerce, National Oceanic and Atmospheric Administration, National Marine Fisheries Service.

- Weis, J. S. and P. Weis. 1989. Effects of environmental pollutants on early fish development. *Aquatic Sciences* 1(1): 45-55.
- Weis, J. S., P. Weis, and T. Proctor. 1998. The extent of benthic impacts of CCA-treated wood structures in Atlantic coast estuaries. *Archives of Environmental Contamination and Toxicology* 34(4): 313-322.
- Wendt, P. H., R.F. Van Dolah, M.Y. Bobo, and J.J. Manzi. 1990. Effects of marina proximity on certain aspects of the biology of oysters and other benthic macrofauna in a South Carolina estuary. South Carolina Wildlife and Marine Resources Department, Charleston, SC, South Carolina Marine Resources Center Tech. Rep. No. 74, 49p.
- Whitaker, D. J., J.E. Jenkins and L.B. DeLancey. (1991). Catch rates and size of white shrimp caught by cast net with different mesh sizes. South Carolina Marine Research Center Technical Report No. 77. 18 p.
- Wilbur, A. R. and M.W. Pentony. 1999. Human-induced nonfishing threats to essential fish habitat in the New England region. p. 299-321 *in* L.R. Benaka (ed.). *Fish Habitat: Essential Fish Habitat and Rehabilitation*. American Fishery Society, Silver Springs, MD, Symposium 22, 459p.
- Williams, A.B. 1965. Marine decapods crustaceans of the Carolinas. U.S. Fish and Wildlife Service Fisheries Bulletin 65:1-298.
- Williams, B. 1990. A survey of shrimp cast netters in Georgia during 1989. Georgia Department of Natural Resources. Coastal Resources Division. Project NA90AA-H-SK042.
- Wolff, M. 1972. A study of the North Carolina scrap fishery. North Carolina Department of Natural and Environmental Resources, Division of Commercial and Sport Fisheries, Special Scientific Report No. 20, 27p.
- Zimmerman, R. T., T. Minello, and M. Gastiglione. 1989. Oyster reef as habitat for estuarine macrofauna. National Oceanic and Atmospheric Administration, Springfield, VA, NOAA Technical Memorandum NMFS-SEFC-249.

14.0 APPENDICES

14.1 APPENDIX1 – AMENDMENT 1 RULES – PUBLIC COMMENT

SOUTHERN ENVIRONMENTAL LAW CENTER

Telephone 919-967-1450

601 WEST ROSEMARY STREET, SUITE 220
CHAPEL HILL, NC 27516-2356

Facsimile 919-929-9421

December 1, 2014

VIA EMAIL

Ms. Catherine Blum
Rulemaking Coordinator, N.C. Division of Marine Fisheries
N.C. Department of Environment and Natural Resources
P.O. Box 769
Morehead City, NC 28557
Catherine.blum@ncdenr.gov

Re: Comments on the proposed rules implementing Amendment 1 to the North Carolina Shrimp Fishery Management Plan

Dear Ms. Blum,

The Southern Environmental Law Center (“SELC”) submits these comments on the Marine Fisheries Commission (“MFC”) proposed rules implementing Amendment 1 to the North Carolina Shrimp Fishery Management Plan (“Amendment 1”) on behalf of the North Carolina Wildlife Federation (“NCWF”).

NCWF is a statewide, nonprofit conservation organization established in 1945 and dedicated to the sound, scientific management of North Carolina’s fish, wildlife, and habitat resources. NCWF is the state affiliate of the National Wildlife Federation and has offices in Charlotte and Raleigh plus thirteen chapters, thirty eight affiliates and thousands of members across the state. NCWF believes that North Carolina’s marine resources are a public trust resource, and as such must be protected and sustained for use and enjoyment by all citizens. NCWF holds firmly to the position that North Carolina must change its approaches to the protection, management, and conservation of its marine resources.

NCWF urges the MFC to adopt regulations implementing Amendment 1 that put in place meaningful protections for the millions of juvenile finfish that are caught and discarded every year in North Carolina’s shrimp trawl fishery, while allowing a sustainable shrimp harvest and ensuring the conservation of important marine species. NCWF is concerned that Amendment 1 and its proposed implementing regulations do not go far enough in establishing adequate protections for juvenile finfish or their habitat from destructive trawl nets used to harvest shrimp in our state’s inshore waters. NCWF’s specific objections are described in detail below.

Charlottesville • Chapel Hill • Atlanta • Asheville • Birmingham • Charleston • Nashville • Richmond • Washington, DC

100% recycled paper

The Problem: Substantial Bycatch in North Carolina's Shrimp Trawl Fishery

In 2012, North Carolina commercial fisherman harvested over six million pounds of pink, brown, and white shrimp using large trawl nets in inshore waters.¹ For every pound of shrimp harvested in the state, approximately four pounds of juvenile finfish, including spot, Atlantic croaker, and weakfish and other organisms were caught by trawl nets and discarded into the state waters.² In 2012, nearly twenty four million pounds of juvenile finfish and other organisms were caught by trawl nets and thrown back overboard.³ These juvenile finfish and other organisms constitute bycatch, defined by the Atlantic States Marine Fisheries Commission as “unintended or non-targeted catch of a particular species or size.”⁴

North Carolina's inshore waters are important spawning and nursery grounds for many finfish, including juvenile Atlantic croaker, spot, and weakfish.⁵ Primary, secondary, and special

¹ See *Fish Dealer Report: 2012*, N.C. DIV. MARINE FISHERIES (April 2013), at 1, available at http://portal.ncdenr.org/c/document_library/get_file?uuid=7b19d0c1-1a7a-44f4-97bd-9aefc038c5e3&groupId=38337 (reporting that N.C. commercial fisherman landed 6.1 million pounds of shrimp in 2012, which amounted to a 19 percent increase over 2011 landings). See also *Unintended Consequences*, N.C. WILDLIFE FED'N JOURNAL (Spring 2014), at 2.

² The majority of shrimp harvested in North Carolina waters are harvested in the Pamlico Sound. In 2009, in the Pamlico Sound, pink, white, and brown shrimp represented only 23 percent of shrimp trawl net catch, while Atlantic croaker, spot, and weakfish accounted for 33 percent, 13 percent, and 6 percent of the catch, respectively. See Kevin Brown, *Characterization of the inshore commercial shrimp trawl fishery in Pamlico Sound and its tributaries, North Carolina: Documentation and Reduction of Bycatch in North Carolina Fisheries*, NAT'L OCEANIC AND ATMOSPHERIC ADMIN. (June 2010) at 26 [hereinafter *2010 NC Bycatch Study*] (outlining the findings of the study of bycatch in the Pamlico Sound, which accounted for 68 percent of the total harvest of shrimp in North Carolina in 2009). In North Carolina waters between Carteret County and the South Carolina line, shrimp accounted for only 21 percent of the catch for all shrimp trawls studied, while Atlantic croaker, spot, and weakfish accounted for 25 percent, 7 percent, and 2 percent of the catch, respectively. See Kevin Brown, *Characterization of the inshore commercial shrimp trawl fishery from Carteret County to Brunswick County, North Carolina: Documentation and Reduction of Bycatch in North Carolina Fisheries*, NAT'L OCEANIC AND ATMOSPHERIC ADMIN. (April 2009) at 27 [hereinafter *2009 NC Bycatch Study*]. See also *Unintended Consequences*, *supra* note 1, at 2 (estimating that 4.5 pounds of bycatch are caught in trawl nets for every pound of shrimp caught in N.C. inshore waters).

³ Based on 2012 harvest numbers cited above, see *Fish Dealer Report: 2012*, *supra* note 1, and bycatch estimates, see, e.g., *2010 NC Bycatch Study*, *supra* note 2, nearly twenty four million pounds of bycatch were caught and discarded in 2012. See also *Unintended Consequences*, *supra* note 1, at 4 (estimating twenty eight million pounds of bycatch were caught in 2012).

⁴ *Special Report No. 78: Summer Flounder Bycatch Regulatory Discards Workshop*, ATLANTIC STATES MARINE FISHERIES COMM'N (July 2003), at 5, available at <http://www.asmfc.org/uploads/file/sr78SummerFlounderBycatchRegulatoryDiscardsReport.pdf>

⁵ See *Atlantic Croaker*, ATLANTIC STATES MARINE FISHERIES COMM'N, <http://www.asmfc.org/species/atlantic-croaker> (last visited Nov. 25, 2014) (noting that Atlantic croaker “spawn in warm pelagic waters during the fall and winter months, and the larvae and juveniles settle in estuaries to mature”); *Atlantic Croaker – 2014*, N.C. DIV. MARINE FISHERIES, <http://portal.ncdenr.org/web/mf08-atlantic-croaker-ssr-2014> (last visited Nov. 25, 2014) (indicating that Atlantic croaker spawning season peaks in October in N.C. waters). See also *Weakfish (Gray Trout) – 2014*, N.C. DIV. MARINE FISHERIES, <http://portal.ncdenr.org/web/mf33-weakfish-ssr-2014> (last visited Nov. 25, 2014) (indicating that the weakfish is “dependent on estuarine habitat as critical nursery areas”). See also *Spot – 2014*, N.C. DIV. MARINE FISHERIES, <http://portal.ncdenr.org/web/mf30-spot-ssr-2014> (last visited Nov. 25, 2014) (discussing the migration of juvenile spot to the “upper reaches of the estuaries” and of adult spot between the estuarine and near-shore ocean).

secondary nursery areas are fragile estuarine and marine areas supporting juvenile finfish and shrimp. Trawling in these areas results in a substantial level of bycatch, and has a damaging impact on juvenile finfish populations in state waters. The North Carolina Division of Marine Fisheries (“DMF”) has listed the Atlantic croaker as “concerned,” spot as “concerned,” and weakfish as “depleted” in its annual Stock Status Report.⁶ These species are important sources of food and forage, and are often target catch for commercial and recreational fishermen.⁷ The MFC acknowledges that bycatch is a substantial problem in the state shrimp trawl fishery, and committed its 2014 revision of the shrimp FMP to examining and adopting strategies to mitigate bycatch in the state’s shrimp trawl fishery.⁸

Available Tools to Reduce Bycatch: North Carolina Fishery Management Plans

The MFC is required to adopt fishery management plans for “all commercially or recreationally significant species or fisheries” in the state with the stated goal of “ensur[ing] long-term viability” of such species.⁹ Fishery management plans must include “conservation and management measures that will provide . . . [for] the protection of marine ecosystems, and that will produce a sustainable harvest.”¹⁰ The development of these plans requires input from advisory committees consisting of commercial fishermen, recreational fishermen, and scientists with expertise in fishery management.¹¹ Fishery management plans must be reviewed every five years.¹² The fishery management plan itself is not binding; the MFC must adopt rules to implement the plan in accordance with the North Carolina Administrative Procedures Act.¹³ Additionally, the Fisheries Director has the authority to issue proclamations on a range of issues relating to fisheries management; compliance with proclamations is mandatory.¹⁴ In these plans and through proclamations, the MFC may regulate fishing times, areas open to fishing, fishing gear, seasons, size limits, allowable quantities of fish harvested and possessed by fishermen.¹⁵

⁶ See *Stock Status Report: 2014*, N.C. DIV. OF MARINE FISHERIES, <http://portal.ncdemr.org/web/mf/2014-stock-status-report> (last visited Nov. 18, 2014).

⁷ See, e.g., *Atlantic Croaker*, *supra* note 5 (indicating that commercial and recreational fisherman seek out Atlantic croaker and that recreational landings of this species have increased over time). See also *Atlantic Croaker*, CHESAPEAKE BAY PROGRAM, http://www.chesapeakebay.net/fieldguide/critter/atlantic_croaker (last visited Nov. 25, 2014) (noting that the Atlantic croaker’s predators include bluefish and striped bass).

⁸ Existing protections against bycatch include minimal gear restrictions, limited areas closed to trawling, and minimal reporting requirements. See, e.g., 15A N.C. ADMIN. CODE 03L.0103 (2014) (limiting the type of gear used in trawling), 03R.0114 (2014) (prohibiting shrimp trawling in certain areas).

⁹ N.C. GEN. STAT. § 113-182.1 (2014).

¹⁰ N.C. GEN. STAT. § 113-182.1(b)(3).

¹¹ *Id.* at (c).

¹² *Id.* at (d).

¹³ *Id.* at (f).

¹⁴ See 15A N.C. ADMIN. CODE 03H.0103 (2014) (“It is unlawful to violate the provisions of any proclamation issued by the authority of the Marine Fisheries Commission Rule. . . variable conditions triggering the use of the Fisheries Director’s proclamation authority may include any of the following . . . (2) biological impacts; (3) environmental conditions; (4) compliance with Fishery Management Plans . . . [and] (6) bycatch issues.”).

¹⁵ N.C. GEN. STAT. §§ 113-182 (a)-(b) (2014).

The original shrimp fishery management plan was adopted in April 2006 (“2006 shrimp FMP”), and was up for review under the five-year review requirement in 2011.¹⁶ Based on public concern regarding the substantial level of bycatch in the state’s shrimp trawl fishery, the MFC limited the scope of the revision of the 2006 shrimp FMP to bycatch issues.¹⁷ In so doing, the MFC articulated numerous objectives in revising the 2006 shrimp FMP, including “minimiz[ing] waste . . . minimiz[ing] the harvest of non-target species of finfish . . . and promot[ing] the protection restoration and enhancement of habitats and environmental quality necessary for enhancing the shrimp resource.”¹⁸ MFC’s six regional committees met to review the 2006 shrimp FMP, MFC regulations, and existing MFC proclamations to propose recommendations for updates to the 2006 shrimp FMP and its implementing rules. After a one-year review of the 2006 shrimp FMP, the MFC proposed Amendment 1 and several proposed amendments to existing rules that implement Amendment 1 on which NCWF provides comments today.

Inadequate Solutions: Proposed Rules Implementing Amendment 1 to the Shrimp Fishery Management Plan

The MFC has proposed amendments to numerous rules implementing Amendment 1 to the 2006 shrimp FMP.¹⁹ While NCWF supports several amendments to the rules proposed by the Commission, the MFC has fallen short of proposing adequate requirements and restrictions on allowable gear, bycatch reduction devices, and areas open to trawling.

The MFC proposes an excessive phase-in period for new restrictions on the maximum combined length of trawl nets used to harvest shrimp in state waters.²⁰ NCWF strongly opposes these amendments, and encourages MFC to adopt a much shorter phase-in period for the required combined headrope length and a shorter allowable maximum combined headrope length on shrimp trawls. Notably, the MFC focused its multi-year review and revision of the 2006 shrimp FMP exclusively on adopting strategies to reduce bycatch. Delaying the adoption of gear restrictions for an additional two years is unacceptable. While NCWF has advocated for a reduced maximum headrope length and supports the Commission’s efforts to impose a restriction in areas where no restriction exists, the MFC’s proposed restriction and the timeframe within which the restriction will be imposed are inadequate to address substantial bycatch resulting from large shrimp trawl nets.

MFC’s proposed rule allows an unreasonably long phase-in period for compliance with the limit on headrope length; the proposed rule requires all shrimp trawlers to comply with the

¹⁶ See *North Carolina Shrimp Fishery Management Plan*, N.C. DIV. OF MARINE FISHERIES (April 2006), available at http://portal.ncdenr.org/c/document_library/get_file?uuid=7dc55c67-c6df-4a39-9ffc-32471c055c23&groupId=38337 [hereinafter *2006 Shrimp FMP*].

¹⁷ *North Carolina Shrimp Fishery Management Plan, Draft Amendment 1*, N.C. DIV. OF MARINE FISHERIES (February 2014), at 20, available at http://portal.ncdenr.org/c/document_library/get_file?uuid=a7825b9a-14ae-4e0b-8795-bfb16fd6ed2a&groupId=38337 [hereinafter *Amendment 1*].

¹⁸ *Id.*

¹⁹ See 29:07 N.C. Reg. 735-738 (Oct. 1, 2014).

²⁰ 29:07 N.C. Reg. 735-738 (Oct. 1, 2014) (proposing an amendment to 15A N.C. ADMIN. CODE 03L.0103).

220 foot limit by January 1, 2017.²¹ Under current regulatory conditions, almost twenty four million pounds of bycatch, including juvenile finfish, are caught and discarded in inshore waters each year.²² With no meaningful restrictions in place for another two years, the level of bycatch caught and discarded will amount to almost fifty million pounds.²³ This is unacceptable. The North Carolina General Assembly entrusted the protection and conservation of the state's marine resources to the MFC, and the General Assembly specifically requires that the fishery management plans adopted and implemented by MFC include conservation and management measures that provide for the "protection of marine ecosystems and that will produce a sustainable harvest."²⁴ Allowing fishermen to continue to use trawl nets unabated for two more years is in direct conflict with these legislative requirements. NCWF proposes that all fishermen be required to comply with MFC's proposed restriction on combined headrope length by July 1, 2015. This timeframe provides fishermen with advance notice of the rule change and adequate time to comply with the new requirements.

In addition to the timeline for phase-in, the MFC's proposal is also substantively inadequate. The excessive maximum headrope length allowed under the proposed rules will continue to result in substantial bycatch in the state's shrimp trawl fishery. A combined headrope length of 220 feet allows for the continued use of large trawl nets that are responsible for habitat destruction and significant bycatch. NCWF advocated for a combined maximum headrope length of 110 feet in its January 2014 letter to the Commission. After further review and research, NCWF now recommends that the MFC adopt a ninety foot combined maximum headrope length on all shrimp trawl nets. As NCWF noted in their comments on Amendment 1, not only do large trawl nets result in substantial bycatch, these nets also limit trawling activities by small shrimping operations. Reducing the combined maximum headrope length to ninety feet would benefit all shrimpers in the state while protecting juvenile finfish and other organisms caught in large trawl nets.²⁵ Further, the MFC proposes a ninety foot combined headrope length for internal waters in designated areas.²⁶ A consistent limitation on the combined maximum headrope length in all inshore waters will provide clarity for fishermen and result in more efficient fishing practices in state waters. Additionally, a consistent limitation on combined headrope length supports a shorter phase-in period for compliance with the MFC's proposed rules.

²¹ *Id.* at 736, 748 (proposing an amendment to 15A N.C. ADMIN. CODE 03L.0103(d)).

²² See text and notes accompanying *supra* notes 2-3.

²³ See 2010 NC Bycatch Study, *supra* note 2, at 26 (estimating that approximately one-quarter of catch in trawl nets is targeted shrimp, while the remaining approximately 75 percent of the catch is non-targeted bycatch). If these statistics are applied the total shrimp harvest numbers in 2012, see *Fish Dealer Report: 2012* *supra* note 1, the bycatch estimated over the two year phase-in period amounts to approximately 50 million pounds of bycatch.

²⁴ N.C. GEN. STAT. §§ 113-131, 182.1(b)(3).

²⁵ Other states with significant shrimp fisheries have established combined headrope length limits well below the 220 feet proposed by MFC. For example, the maximum combined headrope length for shrimp trawls allowed in Mississippi waters is 100 feet. See 21-1 MISS. CODE. R. § 15:05 (restricting individual trawl net sizes in different coastal areas to twelve, twenty five, and fifty feet and placing limitations on the size of trawl doors). In Alabama, recreational shrimp trawl nets cannot exceed sixteen feet (only one net per boat) and commercial trawl nets cannot exceed a combined fifty feet in length (limit of two nets per boat). See ALA. ADMIN CODE. R. 220-3-.01(8) (2014).

²⁶ See 29-07 N.C. Reg. at 748 (proposing an amendment to 15 15A N.C. ADMIN. CODE 03L.0103(c)).

Additionally, the MFC proposes to amend the definition of “mesh length” so that the definition may be applied to square- and diamond-mesh nets.²⁷ The description of this rule change suggests that this proposed amendment supports “a management strategy to require one additional bycatch reduction device in all skimmer and otter trawls.”²⁸ NCWF notes that the proposed rules themselves do not require the use of an additional bycatch reduction device (“BRD”). In fact, no North Carolina statute, regulation, or proposed regulation requires the use of BRDs by shrimp trawlers in inshore waters other than turtle excluder devices (“TEDs”).²⁹ NCWF encourages the MFC to amend its rules to require all fishermen to use a BRD when trawling in state waters. The Fisheries Director may, but is not required to, issue a proclamation mandating the use of BRDs to reduce the number of finfish caught by shrimp trawl nets.³⁰ The Fisheries Director must have the consent of the MFC to issue such a proclamation; the MFC meets only four times each year.³¹ The current Fisheries Director Dr. Louis B. Daniel, III, issued a proclamation requiring one of three BRDs beginning June 1, 2012.³² While proclamations issued by the Fisheries Director are binding on all fishermen fishing in North Carolina waters,³³ and NCWF is pleased that the current Fisheries Director has issued such a proclamation, a rule requiring BRDs would put in place a permanent and consistent requirement for the use of BRDs and signal to fishermen MFC’s commitment to reducing bycatch in the state’s shrimp trawl fishery.

In Amendment 1, the DMF suggests that adopting certain gear restrictions and requirements for BRDs may violate state law prohibiting the adoption of a state regulation that is more strict than any existing federal regulation.³⁴ This provision of state law may not be applicable to state fishery management plans because federal law likely does not apply in this context. Even if federal law does apply, however, federal regulations require the use of BRDs on shrimp trawls. The Magnuson-Stevens Act (“MSA”) governs fishery management plans for fishery resources in the federal exclusive economic zone (“EEZ”) and in certain areas beyond the EEZ.³⁵ The MSA requires that conservation and management measures adopted through fishery management plans developed under the Act “minimize bycatch and to the extent bycatch cannot be avoided, minimize the mortality of such bycatch.”³⁶ Federal regulations implementing the MSA require the use of bycatch reduction devices for shrimp fisheries operating in the South

²⁷ See 29-07 N.C. Reg. at 735, 741 (proposing an amendment to 15A N.C. ADMIN. CODE 03I.0101(3)(n)).

²⁸ *Id.* at 735.

²⁹ 15A N.C. ADMIN. CODE 03L.0103(g) (2014).

³⁰ 15 N.C. ADMIN. CODE 3J.0104(d) (2014).

³¹ See N.C. GEN. STAT. § 153B-289.56(a) (2014) (requiring the Commission to meet at least once each quarter). See also 15A N.C. ADMIN. CODE 03J.0104(d) (requiring that the Fisheries Director get consent from the Commission to issue proclamations).

³² See *Proclamation Re: Shrimp Trawling N.C. Bycatch Reduction Device (BRD) Specifications (SH-3-2012)*, N.C. DIV. MARINE FISHERIES (May 24, 2012), available at http://portal.ncdenr.org/c/document_library/get_file?uuid=79d27a57-6b0b-4664-b6ae-2df70a3ca132&groupId=38337.

³³ 15 N.C. ADMIN. CODE 3H.0103(a) (2014).

³⁴ See *Amendment 1*, *supra* note 17, at 284 (referring to N.C. GEN. STAT. 150B-19.3 (2014)).

³⁵ See 16 U.S.C. § 1811 (2012).

³⁶ 16 U.S.C. § 1851(a)(9) (2012).

Atlantic EEZ.³⁷ Generally speaking, the MSA does not pre-empt state fishery management plans that regulate fishing activity in state territorial waters only.³⁸ Further, the MSA preserves states' jurisdiction to develop fishery management plans for fisheries in state waters.³⁹ A state's waters include waters within three miles of its coast line.⁴⁰ The State of North Carolina has the authority to regulate fishing activities within its waters. The North Carolina General Assembly delegated all regulatory authority over marine resources "to the extent of the State jurisdiction over the resources" to the MFC.⁴¹ In sum, the MFC and DMF should re-consider its position requiring the use BRDs and adopt a rule requiring the use of such devices in North Carolina waters.⁴²

The MFC further proposes closing certain areas to trawling. Specifically, the MFC proposes closing the New River to trawl nets except skimmer trawls upstream from the N.C. Highway 172 Bridge.⁴³ The 2006 shrimp FMP proposed closing these areas to otter trawls over a four-year period because this area includes fragile nursery areas.⁴⁴ In furtherance of that recommendation in the 2006 shrimp FMP, this area has been closed to trawling for many years by proclamation by the Fisheries Director.⁴⁵ This proposed rule follows through on the 2006 shrimp FMP recommendation and permanently closes this special secondary nursery area to

³⁷ See 50 C.F.R. § 622.207(a) (2014). See also 50 C.F.R. Part 622, Appendix D (outlining specifications for certified BRDs).

³⁸ See, e.g., *Louisiana Seafood Management Council, Inc. v. Foster*, 917 F.Supp. 439, 443-34 (E.D.La. 1996) (upholding a Louisiana law that attempted to regulate fishing activity in state territorial waters and finding that the law was not pre-empted by MSA because the state did not attempt to enforce the state law in the exclusive economic zone).

³⁹ See 16 U.S.C. § 1856(a) ("Except as provided in subsection (b) of this section, nothing in this chapter shall be construed as extending or diminishing the jurisdiction or authority of any State within its boundaries.").

⁴⁰ See 43 U.S.C. § 1312 (2012).

⁴¹ N.C. GEN. STAT. § 113-134.1 (2014).

⁴² Under Amendment 1, the MFC has proposed only to convene a stakeholder group to test BRDs, including minimum tail bag mesh sizes, T-90 panels, skylight panels, and reduced bar spacing in TEDs to reduce finfish bycatch. See Amendment 1, *supra* note 17, at 27 (outlining all of the Commission's preferred management strategies under Amendment 1 and listing the convening of a stakeholder group to initiate industry testing of multiple BRDs with a 40 percent bycatch reduction target). As discussed above, the MFC should adopt a BRD requirement as part of the current proposed changes to MFC rules and enforce such a requirement. At the very least, however, NCWF encourages the MFC to expedite the work of the stakeholder group and provide the public progress reports on the status of the group's study of BRDs.

⁴³ 29-07 N.C. Reg. at 735, 744 (proposing an amendment to 15A N.C. ADMIN. CODE 03J.0208).

⁴⁴ 2006 Shrimp FMP, *supra* note 16, at 97. See also 15A N.C. ADMIN. CODE 03R.0105(7) (2014) (designating all waters upstream of the N.C. Highway 172 Bridge over the New River as special secondary nursery areas).

⁴⁵ See Proclamation Re: 2011 Shrimping and Crab Trawling (SH-10-2011), N.C. DIV. MARINE FISHERIES (Aug. 15, 2011), available at http://portal.ncdenr.org/c/document_library/get_file?uuid=4432d317-88ba-4092-b757-278577c32614&groupId=38337 (prohibiting the use of otter trawls upstream of Highway 172 Bridge over the New River after August 17, 2013); Proclamation Re: Shrimp and Crab Trawling (SH-2-2012), N.C. DIV. OF MARINE FISHERIES (Apr. 27, 2012), available at http://portal.ncdenr.org/c/document_library/get_file?uuid=24650202-b862-444d-b9c3-945051fde4a9&groupId=38337 (prohibiting otter trawls upstream of the Highway 172 Bridge over the New River after May 1, 2012); Proclamation Re: 2013 Shrimping and Crab Trawling (SH-7-2013), N.C. DIV. MARINE FISHERIES (Aug. 26, 2013), available at http://portal.ncdenr.org/c/document_library/get_file?uuid=a51a305f-954d-43d7-bc5a-ab0848fdb561&groupId=38337 (prohibiting the use of otter trawls upstream of the Highway 172 Bridge over the New River after Aug. 30, 2013).

damaging otter trawling. MFC also proposes closing the Intracoastal Waterway channel from the Sunset Beach Bridge south to the South Carolina line, including the Shallotte River, Eastern Channel, and lower Calabash River to trawling.⁴⁶ This change was also contemplated during the development of the 2006 shrimp FMP.⁴⁷ Much of the area covered by this rule has been closed to trawling by proclamation.⁴⁸ The areas covered by this proposed rule are important habitat for young and small shrimp and juvenile finfish, and should be protected from destructive shrimp trawls.⁴⁹ NCWF strongly supports these changes to existing MFC rules. NCWF encourages the MFC to limit trawling in additional inshore waters, as well. Specifically, NCWF asks the MFC to re-designate nursery areas to take into consideration all economically beneficial species to the commercial and recreational fishing industries. Primary, secondary, and special secondary nursery areas are fragile estuarine and marine areas supporting juvenile finfish, and these areas should be permanently closed under MFC regulations.⁵⁰

The MFC proposes restructuring the rule granting the Fisheries Director authority to “impose . . . restrictions” on time, area, means and methods, season, size, and quantity for the taking of shrimp.⁵¹ The language of this proposed rule broadens the Fisheries Director’s discretion to impose restrictions without providing any criteria guiding the imposition of such restrictions, including, notably, the Director’s discretion to restrict areas open to the taking of shrimp. Despite language in the regulation indicating that this proclamation power is only to “impose . . . restrictions,” NCWF is concerned that the lack of language limiting the proclamation power may be read to allow the Fisheries Director to open protected areas to shrimp trawling. The exercise of proclamation power described in this section must be limited by existing MFC rules permanently closing primary, secondary, and special secondary nursery areas and other designated areas to trawling. As noted above, designated nursery areas are important spawning grounds for juvenile finfish and are protected under MFC rules.⁵² The Director should be guided by conservation principles in exercising proclamation authority under this proposed rule.

Finally, the MFC proposes restricting the taking of shrimp until the Director opens the season,⁵³ allowing hand cast netting of shrimp in areas currently closed to the taking of shrimp⁵⁴;

⁴⁶ 29:07 N.C. Reg. at 737, 795 (proposing an amendment to 15A N.C. ADMIN. CODE 03R.0114).

⁴⁷ See *Amendment 1*, *supra* note 17, at 342. See also *2006 Shrimp FMP*, *supra* note 16, at 102.

⁴⁸ See, e.g. *Proclamation Re: Crab Trawling and Taking Shrimp With Nets* (SH-10-2014), N.C. DIV. MARINE FISHERIES (Sept. 17, 2014), available at http://portal.ncdemr.org/c/document_library/get_file?uuid=43d0c8ca-47c1-4491-80b1-c648234f9c5e&groupId=38337 (closing the Intracoastal Waterway west of Sunset Beach High Rise Bridge to the South Carolina line to shrimp trawls). But see *Proclamation Re: Crab Trawling and Taking Shrimp with Nets* (SH-14-2014), N.C. DIV. OF MARINE FISHERIES (Oct. 28, 2014), available at http://portal.ncdemr.org/c/document_library/get_file?uuid=7fa5d873-3178-4cf9-a14f-dee81551a392&groupId=38337 (opening only the main channel of the Intracoastal Waterway from Sunset Beach High Rise Bridge to the South Carolina line to shrimp nets).

⁴⁹ See text and notes accompanying *supra* note 5.

⁵⁰ 15A N.C. ADMIN. CODE 3N.0101 – 0105 (2014).

⁵¹ 29:07 N.C. Reg. at 736, 747-48 (proposing an amendment to 15A N.C. ADMIN. CODE 03L.0101(a)-(b)).

⁵² See text accompanying *supra* note 4.

⁵³ *Id.* at 736, 747 (proposing an amendment to 15A N.C. ADMIN. CODE 03L.0101(a)).

⁵⁴ *Id.* at 736, 748 (proposing an amendment to 15A N.C. ADMIN. CODE 03L.0105 (1)-(2)).

N.C. Division of Marine Fisheries
Attn: Ms. Catherine Blum
December 1, 2014
Page 9

and increasing the amount of shrimp that may be taken from these areas.⁵⁵ NCWF does not oppose these amendments.

Conclusion

Moving forward, NCWF encourages the MFC to establish rational and sustainable goals for bycatch reduction in the shrimp trawl fishery, adopt meaningful management strategies to achieve those goals, set a timetable for implementing management strategies, enforce the implementation of these strategies, evaluate the status of the management strategies, and update management strategies as needed. To this end, MFC should consider limiting tow times, creating seasons for shrimping, requiring monitoring and reporting of bycatch from all commercial and recreational fishermen, and establishing a goal of reducing finfish bycatch by 40 percent.⁵⁶ Further, the MFC should incorporate the findings and goals of the Coastal Habitat Protection Plan into the 2006 shrimp FMP.⁵⁷

In sum, the MFC had an opportunity to meaningfully address issues associated with bycatch, taking into account the overwhelming evidence that the level of bycatch in inshore waters is unacceptably high and the public call for efforts to reduce bycatch. The MFC's proposed rules fall short of implementing meaningful strategies to reduce the level of bycatch in North Carolina inshore waters, protecting juvenile finfish and their habitat, and ensuring sustainable fisheries resources management. NCWF encourages MFC to consider the recommendations discussed herein when adopting rules implementing Amendment 1 to the 2006 shrimp FMP.

Thank you in advance for your consideration of these comments.

Sincerely,



Sierra B. Weaver
Blakely E. Hildebrand

⁵⁵ *Id.*

⁵⁶ See *Amendment 1*, *supra* note 17, at 356 (outlining MFC's preferred management strategies).

⁵⁷ See *North Carolina Coastal Habitat Protection Plan*, N.C. DEP'T. OF ENV'T AND NATURAL RES. (Dec. 2010), available at <http://portal.ncdemr.org/web/mf/59>.

14.2 APPENDIX2- AMENDMENT 1- PUBLIC COMMENT

Public comment and recommendations by five different advisory committees are required as part of the FMP process to ensure adequate input from interested citizens. Both Shrimp AC and DMF recommendations regarding the management of bycatch in the shrimp fishery were vetted through the MFC's Southern AC, Northern AC, Habitat and Water Quality AC, Finfish AC and the Shellfish/Crustacean AC during January 2014.

Trawling in the New River above the Highway 172 Bridge

Shrimp FMP Advisory Committee Recommendation

Recommend the MFC allow skimmer and otter shrimp trawling in the New River special secondary nursery area.

Division Recommendation

Status quo

MFC Advisory Committee Recommendations

Southern AC	Northern AC	Habitat AC	Finfish AC	Shell/Crust AC
Same as DMF	Same as DMF	Same as DMF	Motion to support DMF, failed 3-3-1	Same as DMF

Evaluation of the skimmer trawl and other gears used for shrimping in North Carolina

Shrimp FMP Advisory Committee Recommendations

Allow hand cast netting of shrimp in all closed areas and increase the limit to four quarts per person.

Recommend the MFC require a fishing license from DMF to fish a cast net.

Division Recommendation

Status quo

MFC Advisory Committee Recommendations

Four quart limit

Southern AC	Northern AC	Habitat AC	Finfish AC	Shell/Crust AC
Same as AC	Same as AC	Abstain	Same as AC	Same as AC

Cast net license

Southern AC	Northern AC	Habitat AC	Finfish AC	Shell/Crust AC
Motion to support AC, failed 3-3-2	<i>Status quo</i>	Motion to support suggestion of a license, failed 1-2-4	Motion to support license, failed 2-5	No Action

The use of TEDs in commercial skimmer trawl operations

Shrimp FMP Advisory Committee Recommendation

No Recommendation

Division Recommendation

Upon federal adoption of TEDs in skimmer trawls, the division will support the federal requirement. Rule 15A NCAC 03L .0103 (g) allows for state enforcement.

MFC Advisory Committee Recommendations

Southern AC	Northern AC	Habitat AC	Finfish AC	Shell/Crust AC
Same as DMF	Same as DMF	Abstain	Same as DMF	Same as DMF

Consideration of a commercial live bait shrimp fishery in North Carolina

Shrimp FMP Advisory Committee Recommendation

Recommend NC establish a permitted live shrimp bait fishery and for DMF to craft the guidelines and permit fees after reviewing permitted operations in other states.

Division Recommendation

Status quo

MFC Advisory Committee Recommendations

Southern AC	Northern AC	Habitat AC	Finfish AC	Shell/Crust AC
Same as AC	<i>Status quo</i>	Same as AC	<i>Status quo</i>	<i>Status quo</i>

Gear Modifications in North Carolina shrimp trawls to reduce finfish bycatch

Shrimp FMP Advisory Committee Recommendation

Recommend the Marine Fisheries Commission allow any federally certified BRD in all NC internal and offshore waters.

Recommend the MFC update and certify bycatch reduction devices through the state bycatch reduction program.

Recommend the MFC convene an ongoing stakeholder workgroup charged with suggesting new trawl gear or trawl gear modification.

Initiate industry testing of new or modified bycatch reduction devices and gear modifications under the supervision of the NC DMF. After testing and collection of scientific data, regulations

should be implemented to require or allow such devices or modifications to be used in N.C. internal and offshore waters.

Recommend the MFC test a three-inch bar-spaced turtle excluder device to see if it can be certified as a bycatch reduction device.

Recommend the MFC allow the shrimp industry a two year period to test bycatch reduction devices.

Division Recommendations

Allow any federally certified BRD in all NC internal and offshore waters.

Update the scientific testing protocol for the state BRD certification program.

Convene a stakeholder group to initiate industry testing of minimum tail bag mesh size, T-90 panels, skylight panels, and reduced bar spacing in TEDs.

- Upon securing funding, testing in the ocean and internal waters will consist of three years of data using test nets compared to a control net with a Florida Fish Eye, and a federally approved TED.
- Results should minimize shrimp loss and maximize reduction of bycatch of finfish. Promising configurations will be brought back to the MFC for consideration for mandatory use.
- This stakeholder group may be partnered with DMF and Sea Grant.
- Members could consist of fishermen, net/gear manufacturers and scientist/gear specialists.

MFC Advisory Committee Recommendations

Southern AC	Northern AC	Habitat AC	Finfish AC	Shell/Crust AC
Same as DMF	Same as DMF	Same as DMF	Same as DMF	Same as DMF

Shrimp FMP Advisory Committee Recommendation

No recommendation

Division Recommendation

Require either a T-90 panel/ square mesh tailbag or other applications of square mesh panel (e.g., skylight panel), reduced bar spacing in a TED, or another federal or state certified BRD in addition to existing TED and BRD requirements in all skimmer and otter trawls.

MFC Advisory Committee Recommendations

Southern AC	Northern AC	Habitat AC	Finfish AC	Shell/Crust AC
Same as DMF	<i>Status quo</i>	Abstain	Same as DMF	Same as DMF but to require one year of testing

Effort Management for bycatch reduction in the North Carolina shrimp trawl fishery

Shrimp FMP Advisory Committee Recommendation

No Recommendation

Division Recommendation

Status quo

MFC Advisory Committee Recommendations

Southern AC	Northern AC	Habitat AC	Finfish AC	Shell/Crust AC
No Discussion	No Discussion	Abstain	No Discussion	No Discussion

Characterization of the North Carolina commercial shrimp trawl fleet

Shrimp FMP Advisory Committee Recommendation

No Recommendation

Division Recommendation

In order to put a cap on fleet capacity as a management tool, establish a maximum combined headrope length of 220 feet in all internal coastal waters where there are no existing maximum combined headrope requirements (i.e., 90 foot requirement).

MFC Advisory Committee Recommendations

Southern AC	Northern AC	Habitat AC	Finfish AC	Shell/Crust AC
Do not support DMF recommendation	<i>Status quo</i>	Abstain	Same as DMF but include a three year phase in period	Same as DMF

Area restrictions to reduce shrimp trawl bycatch in North Carolina's internal coastal waters

Shrimp FMP Advisory Committee and DMF Recommendation

Recommend to the MFC to prohibit shrimp trawling in the IWW channel from the Sunset Beach Bridge to the SC line, including Eastern Channel, lower Calabash River and Shallotte River.

MFC Advisory Committee Recommendations

Southern AC	Northern AC	Habitat AC	Finfish AC	Shell/Crust AC
Same as DMF	Same as DMF	Same as DMF	Same as DMF	Same as DMF

Shrimp FMP Advisory Committee Recommendation

No recommendation

Division Recommendation

Recommend the MFC Habitat and Water Quality Committee considers changing the designation of special secondary nursery areas that have not been opened to trawling since 1991 to permanent secondary nursery areas.

MFC Advisory Committee Recommendations

Southern AC	Northern AC	Habitat AC	Finfish AC	Shell/Crust AC
Same as DMF	Same as DMF	Same as DMF	Motion to support DMF, failed 3-3-1	Same as DMF

The Marine Fisheries Commission at its November meeting requested that an additional recommendation also be included during the public comment period.

Marine Fisheries Commission Recommendation

Convene a stakeholder group to initiate a three year study to test minimum tail bag mesh size, T-90 (square mesh) panels, skylight panels, reduced bar spacing in TEDs and any other new methods of reducing unwanted finfish bycatch to achieve a minimum of a 40 percent reduction of finfish by weight.

- Compare these to a control net with a Florida fish eye, a federally approved TED, and a one and half inch mesh tail bag.
- The stakeholder group should partner with DMF and Sea Grant to help secure funding for the study.
- If the 40 percent target reduction by weight in finfish is not achieved, further restrictions will be placed on the shrimp trawl industry to achieve the 40 percent reduction.
- Additional restrictions on the shrimp trawl industry will be reviewed and discussed at that time.

Southern AC

Do not support the MFC recommendation because of no support for the 40% reduction due to no scientific basis and also to not support the remaining portions of the MFC's motion because they are redundant to earlier recommendations.

Northern AC

Strongly reject the MFC recommendation for the 40% reduction due to no scientific basis and also to not support the remaining portions of the MFC's motion because they are redundant to earlier recommendations.

Habitat and Water Quality AC

Convene a stakeholder group to initiate a three year study to test minimum tail bag mesh size, T-90 (square mesh) panels, skylight panels, reduced bar spacing in TEDs and any other new methods of reducing unwanted finfish bycatch to achieve a reduction in bycatch.

- Compare these to a control net with a Florida fish eye, a federally approved TED, and a one and half inch mesh tail bag.
- The stakeholder group should partner with DMF and Sea Grant to help secure funding for the study.

Finfish AC

Strongly reject the MFC recommendation for the 40% reduction due to no scientific basis and also to not support the remaining portions of the MFC's motion because they are redundant to earlier recommendations.

Shellfish and Crustacean AC

Do not support the MFC recommendation because recommendations are already addressed in the DMF recommendation.

Public Comment

Southern Advisory Committee (January 8)

Buzzy Frederick- He participated in skimmer trawl testing of TEDs. Tests showed a 25% to 45% decrease in bycatch. In 2011 bycatch decreased between 23% and 43% in skimmer rigs and in 2011 there was a 27% to 45% decrease in bycatch. When combining 25 boats in both the Gulf and in NC the overall reduction was between 25% and 43% reduction.

Birdie Potter-Please do not support the MFC's motion to reduce bycatch by 40%. If we do not reach it, the MFC will do it biologically.

Chris McCaffity- Fisheries are at a cross roads and will be lost. Fishermen are beat down with so many regulations (gamefish, petition). It is harassment. Stop pushing regulations; give everyone a chance to work together.

Bradley Styron- Forty percent reductions in bycatch is unreasonable and what baseline are we working from? We need to know what is in the system. How many fish will live to maturity? There is no basis for the 40%. The industry is always proactive. Go back 70 years. There has been a 90% decrease through attrition, gear modifications and other things. Fishermen are always looking to get rid of bycatch. It is inefficient to fish with bycatch in your net. Bycatch is area specific and can even be hard to find sometimes to compare gear. There is no way to gage bycatch and 40% is arbitrary and unattainable.

Steve Weeks- *read off a prepared statement handed out to AC. See below.*

Brent Fulcher- He agrees with Bradley and supports the stakeholder group. He disagrees with anything more than a 30% reduction. The 40% is not achievable and is unreasonable.

Bill Hooper- He agrees with the DMF recommendations. The 40% is unachievable. He proposes a more reasonable reduction and to get funding. There is no evidence of bycatch impacting species. The MFC is overstepping its power in light of biological evidence.

Ken Sieglar- The southern area of Brunswick County is like the White Oak River when the shrimp get a certain size and leave. When they leave they do not get caught. Size does not matter down there.

Steve Parrish- We still need to improve the gear to reduce bycatch without losing shrimp bycatch. We tried the 1" bar in the TED and it excluded bycatch but lost a lot of shrimp. The MFC should reconsider its recommendation and give us a reasonable goal. Mr. Parrish is in favor of the stake holder group and volunteers to participate.

Northern Advisory Committee (January 9)

Terry Pratt- There is no baseline to reduce 40% from. The fishery has reduced bycatch. It used to be 10:1, now it is 4:1. Every BRD was developed by fishermen. Fishermen attempt to reduce bycatch.

Steve Weeks- *read off a prepared statement handed out to AC. See below.*

Brent Fulcher- *read off handout prepared by Jerry Schill. See below.*

Brent Fulcher-Bycatch is a lot of things. Some is sellable, it is not all dead. The T-90, the reduced bar TEDs, all of the BRDs were developed by the industry. He agrees with the DMF's recommendation to form a stakeholder group to test new BRDs and TEDs. He disagrees with anything over 30%. Support reducing bycatch with minimum shrimp loss. Forty percent is not achievable.

Greg Judy- Was involved with BRD development I NC while he worked with the DMF. When you reduced weakfish by 50%, you reduced the spot and croaker by 70%. The 40% reduction that the MFC is asking for is unachievable; you will lose too many shrimp. Amendment 6 of the SA shrimp plan stated there is no evidence of bycatch having an adverse effect on weakfish, spot, or croaker. Thus the extra 40% reduction on top of the 30% reduction we have already achieved is too much and unfair.

Bill Hooper- Agrees the DMF needs to work with the fishermen and the industry will find a way to reduce bycatch. We can build better BRDs, but we should not be held to a number that is unachievable. TEDs have been shown to reduce bycatch as much as 40%; however, an additional 40% on top of the 30% that is in place now is unachievable without shrimp loss. Biological measures to impose if the reductions are not met are no more than a threat without a scientific basis to support such a number. There will have to be too many assumptions to establish a benchmark.

Glenn Skinner- I'm disappointed with the current MFC, there is no data to support the 40% number and they are setting the industry up for failure.

Habitat and Water Quality Committee (January 13)

Jerry Schill- *read off a prepared statement handed out to AC. See below.*

Greg Judy-BRDs decrease gray trout by 50%. He tested lots of BRDs. A 50% reduction in gray trout equals about a 60% reduction in other species. An additional 40% reduction is unattainable. If you get a 40% reduction, you will lose too many shrimp. SAMFC shrimp plan

also states that there is no evidence that trawling is having an impact on bycatch of weakfish, spot and croaker. In 1975-1989 average landings of shrimp were 4.9 million. There were no BRD or TED requirements. During the same time frame the average landings of croaker were 6.7 million, spot 5.4 million, and weakfish 1.8 million. It makes you wonder if shrimp trawling was the culprit, there is something else limiting these fisheries. I ask you to not support the additional 40% reduction as suggested by the MFC.

Finfish Committee (January 14)

Clarence Fredrick- Decisions that are being developed will have impacts. You need to address the potential impacts of a live bait fishery. They should be treated like other commercial shrimpers and they should not be allowed to trawl in closed areas. A Sunday evening, 5:00 tow is the best tow. The industry manages itself. I am also against the closure in the south; it will hurt recreational shrimpers too. If the shrimp are small, the commercial fishermen will not go because the shrimp will not sell. Studies conducted by NMFS, testing TEDs in skimmer reduced bycatch 28% to 45%. We are reducing bycatch now. The shrimpers are also studying the 3" bar in the TED; as a whole the industry is working to reduce bycatch.

Shellfish/Crustacean (January 16)

Doug Cross-The 40% motion from Joe Shute is not achievable. Originally, there were discussions with commissioners about what were good reductions. Somehow it evolved into a target before there was data or logic to support it. He is totally against the 40%. We should not set a target without the science to back it up. There should be no consequences if there is no scientific data to support reductions. He supports bycatch reduction but we should not have a target first. That is putting the cart before horse. He did not see how any committee could support this recommendation. Let us eliminate bycatch as much as humanly possible. Do not set an arbitrary number that is not achievable. We do not need a dooms day effect in the 40% is not met.

Presented to Northern, Southern, Habitat, and Crustacean ACs

North Carolina Fisheries Association, Inc. (Jerry Schill, Brent Fulcher)

There is one thing that is striking to me since getting back involved in fisheries issues after an absence of personal involvement for almost 9 years. I was with the North Carolina Fisheries Association for 18 years, from 1987 till 2005, and during that time served on numerous boards, committees and panels including 6 years on the South Atlantic Fishery Management Council and several years on the Joint Legislative Commission on Seafood & Aquaculture.

The one striking issue that I referred to is the loss of memory of what has transpired over the years in fishery management, in this case, in the shrimp bycatch history. Last summer in Raleigh it was crystal clear that many who were proposing gamefish or were involved with the banning of inside shrimping, had little to no experience in fisheries issues. There were others who knew better but had selective memories. I say that because I heard directly or indirectly that fishermen needed to compromise, and that opinion seemed to be based upon an assumption that commercial fishermen have not conceded anything when sitting at the table to discuss a myriad of issues, including bycatch. So let's talk about that.

When I started with NCFCA in 1987 I had no preconceived notions about anything regarding fishing issues. I had no bias from a trawling, gillnetting, bottom fishing, crabbing or even from a

hook and line recreational fishing perspective. I didn't do any of it. My only connection to fishing was as a consumer. I was, however, attuned to the political winds and the public perception of a number of issues including the protection of turtles and bycatch issues. And so were many fishermen who made their living on the water. In the late 80s, the debate wasn't really about whether or not to protect turtles for example, but how to do it. We learned quickly that the federal government shoving a particular method down the fishermen's throat wasn't going to do it. It was only after fishermen got involved with the planning and testing was there success in coming up turtle excluder devices that worked.

And the same is true with bycatch reduction. Whether you prefer to call them BRDs, bycatch reduction devices, or FEDs, fish excluder devices, they came to be because they were developed and tested by fishermen. (We prefer BRDs because the word FED is so negative!)

In the case of North Carolina, many shrimpers used them voluntarily. Why? Because they worked! It's also important to note that North Carolina was the first state to mandate their use in shrimp trawls and it was OK with the shrimpers because most were using them anyway!

So why is this stuff important? I'll paraphrase something I heard the late Congressman Walter Jones, Sr., say at a Merchant Marine and Fisheries Committee meeting a long time ago: **“NO fisheries regulation will work without the acceptance, albeit grudgingly, of the fishermen being regulated.”**

In the mid-80s, if any of the self-described conservationists who were complaining about bycatch in the shrimp trawl fishery could have envisioned North Carolina shrimpers helping to develop and actually use reduction devices that actually worked such as what we're using now, they would have thought they died and went to heaven!

Now, does that mean we should just forget about it and do nothing to reduce it even further? Absolutely not! But I would strongly caution this committee, when you make your recommendations to the Marine Fisheries Commission, not to push for any particular percentage reduction that is unattainable or worse yet, any threat of what you'll do to the fishermen if they don't reach that unattainable goal, because you will be doomed to fail from the start! (UNLESS the ultimate goal is the elimination of the shrimpers in the first place.)

Such a mandate back in the 80s would have doomed the process. Cooperation is the key, and yes, I know full well about those who claim otherwise. Just remember that they weren't sitting at the table back then and really have no idea what went on. The process I'm speaking about is not easy, but if our goal is to truly reduce bycatch even more, rather than sabre rattling, then the cooperative approach is the only way to be effective.

The North Carolina Fisheries Association appeals to you to go the route that was taken for many years and that is the fostering of cooperation on the studies and testing of ANY gear in our efforts to conserve our resources while allowing a proud and noble fishing tradition to continue.

Fishing families and the seafood consumers are counting on you!

Presented to Northern and Southern ACs

North Carolina Fisheries Association, Inc. (Steve Weeks)

Commercial fishermen want to reduce bycatch for the viability of all finfish species, not just by reducing bycatch in the shrimp fishery, but in all fisheries, recreationally and commercially.

The North Carolina Fisheries Association is opposed to the Commission's recommendation requiring a minimum 40% reduction of finfish by weight within a 3 year period.

The Association supports the Division's recommendations to:

1. Convene a stakeholder group to initiate industry testing of bycatch reduction devices;
2. To allow any federally certified bycatch reduction devices in all internal and offshore waters;
3. Upon Federal adoption of turtle excluder devices in skimmer trawls, state enforcement of the Federal requirement; and
4. Updating the scientific testing protocol for the state bycatch reduction device certification program.

The shrimp industry since the introduction of the bycatch reduction device has reduced bycatch by approximately 1/3. Before a bycatch reduction device can receive Federal certification it must reduce bycatch by a minimum of 30%. In addition to a bycatch reduction device, all commercial shrimp trawls require a turtle excluder device. Recent testing by the National Marine Fisheries in conjunction with a North Carolina skimmer trawl fisherman has indicated that turtle excluder devices also reduce bycatch.

In addition, there has been a substantial reduction in effort in the shrimp industry. In 1994 there were 14,585 shrimp trips with otter trawls, in 2011 there were 3,004 trips, a 485% reduction. In 1994 there were 1,118 shrimp trawl trips, in 2011 there were 327 trips, a 340% reduction. In 1994 there were 2,109 channel net trips, in 2011 there were 531 trips, a reduction of 397%.

The recommended 40% reduction over a 3 year time period is not achievable without destroying the North Carolina shrimp industry, is without scientific basis and is arbitrary and capricious.

Scientifically the Division has not established an accurate finfish to shrimp, bycatch ratio. Director Daniel, at the hearing in Raleigh in August 2013, testified that there was no accurate basis in the bycatch ratio the State of North Carolina was using. This ratio is considerably higher than the ratio of all South Atlantic States according to data from National Marine Fisheries, Southeast Region.

Steven Parrish, a net maker and designer with significant experience and expertise in bycatch reduction devices spoke before the Southern Advisory Committee on January 8, 2014. Mr. Parrish advised that through his experience and testing a 40% additional reduction in bycatch was not achievable without a significant loss of the shrimp catch.

The reduction of bycatch in the shrimp fishery should be achieved in a reasonable manner and over a reasonable time period with cooperation between the State and the fisherman. It took years to develop, test and implement the fish excluder devices currently in use, which have to be federally approved. There are currently Federally approved finfish excluder devices that the State of North Carolina will not allow the fisherman in State waters to use.

Kevin Brown with the Division, who is in charge of the bycatch reduction program, advised the Southern Advisory Committee on January 8, 2014 that he questions whether he has

adequate personnel and resources to verify the data required to substantiate whether or not any reduction mandated by the Commission has been met.

In 2013 NOAA Fisheries awarded 16 grants totaling nearly \$2.4 million as a part of its Bycatch Reduction Engineering Program. Bycatch of various species – whether fish, marine mammals, or turtles – can have significant, biological, economic, and social impacts. Preventing and reducing bycatch is a shared goal of fisheries managers, the fishing industry, and the environmental community.

NOAA Fisheries' Bycatch Reduction Engineering Program provides funds critical to key partners for the research and development of innovative approaches and strategies for reducing bycatch.

Mr. Brown advised the Southern Advisory Committee on January 8, 2014 that he has applied for grants to assist in the research and testing of bycatch reduction devices.

This advisory committee should recommend the above recommendations of the Division and should not recommend the Commission's recommendation of a 40% bycatch reduction over a three year period as there is no scientific basis for said reduction and said reduction is not achievable without significant monetary loss to the North Carolina shrimp industry, which has traditionally been one of the more lucrative fisheries in this State.

Additional Public input (emails)

United National Fisherman's Association (received January 8)

Do not need a number or percentage for the amount of by catch.

Reduction in shrimp Trawls. DIVISION & National Marine Fisheries Service needs to document the by Catch reduction from Turtle Excluder Devices. No credit is given for large fish excluded by Turtle Excluder Devices. {Loss of income to fishermen}

NOW! The committee should address the by catch from recreational fish that can be reduced by changing the regulations on all regulated recreational fish.

A possession limit for each species in total length in inches to be retained, all fish must be retained, thus allowing low income fishing from the bank access to fish for food.

In brought over the rail. Require barb less hooks on all recreational vessels, only allow barbed hooks on piers bridges or shore. Consider barbs on hook side away from shank.

Trout as an example would have a 60 inch total length limit, thus allowing 5 12 inch fish

Or 6 10 inch fish NO BY CATCH NO CATCH & RELEASE!

ELIMINATE BY CATCH OR HOOK & RELEASE IN RECREATIONAL FISHING.

Coastal Fishery Reform Group (received January 16)

The Coastal Fisheries Reform Group (CFRG) is a coalition of recreational coastal fishermen, who support sound management of our marine fisheries based upon the best available science. We represent many thousands of fishermen from across the state who fish in our coastal waters. We have had over 127,000 hits on our blog site (<http://cfrgnc.blogspot.com/>) where we have discussed coastal fisheries issues since 2009. In the role as a voice for the average salt water fisherman, we submit the following comments on the proposed Shrimp FMP amendment to reduce finfish bycatch that the Marine Fisheries Commission will consider at their February 2014 meeting.

We strongly believe that the draft amendment to the shrimp plan, which includes only proposals for industry testing of bycatch reduction devices, updating testing protocols for the state bycatch reduction device certification program, and requiring additional bycatch reduction devices in all

shrimp trawl nets, falls woefully short of an acceptable proposal to amend the Shrimp FMP to reduce bycatch.

The Shrimp FMP Advisory Committee met several times over the course almost a year and many additional, significant measures were discussed and considered. The proposals emerging from the study are almost meaningless and will do little if anything to reduce finfish bycatch in shrimp trawling operations. The recommended amendment contains no options for gear restrictions, no time closures, no areas closures, and no target reduction in bycatch. The Shrimp FMP should be amended to include goals, timetables, and management measures to accomplish significant by-catch reduction and an aggressive data collection and analysis program to monitor the success of management actions taken over the next five year period.

We quote here from the draft amendment (page 65 Section **6.3 Shrimp Trawl Bycatch**):
“As perhaps the prime example of the new policy positions, the re-authorized Magnuson-Stevens Fishery Conservation and Management Act (MSFCMA) contains a National Standard (#9) requiring bycatch minimization (USDOC 1996). National Standard 9 states: “Conservation and management measures shall, to the extent practicable, (A) minimize bycatch and (B) to the extent bycatch cannot be avoided, minimize the mortality of such bycatch.” Additionally, in 1991 the MFC adopted a policy directing the DMF to establish the goal of reducing bycatch losses to the absolute minimum and to consciously incorporate that goal into all of its, management considerations (Murray et al. 1991).”

The CFRG urges the MFC to amend the Shrimp FMP to include the following provisions:

1. Limit all trawl nets in inshore coastal waters (especially Pamlico Sound) to a maximum headrope size of 110 feet and only allow two nets per boat. This would remove the large nets and their excessive bycatch but would allow the small trawlers that have shrimped in our sounds for generations to continue working uninterrupted. These smaller shrimp boats are mostly local boats, with local crews that sell their catch at local fish houses in North Carolina. Such a rule change would greatly benefit the vast majority of North Carolina shrimpers while truly helping our coastal economies and our marine resources by significantly reducing bycatch.
2. Limit tow times to 60 minutes. This would allow for some bycatch to be released alive and also increase the chance of sparing any endangered turtles which are entrapped in the net.
3. Delay shrimp season until the shrimp size has reached the level of having 36 to 41 (or lower) shrimp per pound. This would postpone the harvest of shrimp and allow juvenile finfish to grow larger and have more of a chance of escaping shrimp trawls. These fish would also have more time to move out of their nursery areas where the trawlers are now working. In addition, this change would cause the shrimp to be larger when they are harvested and market value would be greater, thereby benefiting shrimp fishermen.
4. Establish exclusion zones around both sides of our inlets where trawlers with headropes exceeding 110 feet would not be allowed. This would allow juvenile finfish that are transitioning to a life in the open ocean to escape our sounds without being killed by a shrimp trawler. These fish become concentrated when they are near the inlets and are especially vulnerable to trawlers until they can disperse into the ocean.

Now is the time to get serious about the finfish decimation caused by the current activities of shrimp trawlers in the inshore waters of NC. Destruction of fisheries resources of this magnitude cannot be tolerated any longer. If the proposed amendment to the Shrimp FMP is adopted as presented, the schedule for meaningful action will be delayed for years while we look for the magic solution that is right before us now. Establish some realistic goals, implement some meaningful management measures, set a timetable for implementation, evaluate

improvements in terms of bycatch reduction, and make subsequent changes as dictated by results.

Joe Albea
On behalf of Coastal Fisheries Reform Group

North Carolina Wildlife Federation Camo Coalition (received January 16)

Dr. Daniel:

I have closely followed the course of the current attention given bycatch in the Shrimp FMP from the first proposal to simply revise the FMP to the decision to amend the FMP and all of the work of the Advisory Committee that was appointed and has worked for about a year to review the bycatch issue and make proposals to amend the FMP to address bycatch.

If I correctly interpret the draft amendment being considered now, the recommendations are limited to an industry study of bycatch reduction devices, updating testing protocols for the state bycatch reduction device certification program, and requiring additional bycatch reduction devices in all shrimp trawl nets. These limited proposals are not at all significant if we are trying to reduce bycatch from shrimp trawling in a timely and effective way. Many reasonable and effective means to reduce bycatch are available now. If we limit the amendment to these points, then bycatch will not come up again for five years. We need to at least adopt a list of alternative management measures such as gear restrictions, maximum tow times, area closures around inlets and a schedule for implementation and a plan for evaluation in terms of reduction of bycatch.

Essential to any deliberate, serious plan of action to address a natural resource issue as crucial as the unacceptable bycatch of immature finfish in shrimp trawls is a plan of action with a slate of management choices, a timetable of implementation and evaluation, and a target level of success. The draft amendment has none of these elements. The Advisory Committee discussed many of the management measures that could have given promise toward achieving a meaningful reduction in bycatch, but none of these actions are before the Commission for consideration. The omission of potential actions that could work flaws the whole process.

Now is the time to begin an approach toward reduction of shrimp trawling bycatch. We do not need more studies that will continue to show that finfish mortality is significant and the effect on their stocks is uncertain. We do not need to evaluate bycatch reduction devices as the main thrust of bycatch reduction. A risk of doing nothing substantial at this good opportunity is the possibility of a far more precipitous and radical change similar to what happened with the sea turtle and the gill nets.

Dick Hamilton

Dr. Daniel:

Reference: Proposed amendment Shrimp FMP to Reduce Bycatch

The North Carolina Wildlife Federation is a statewide, non-profit, conservation organization dating back to 1945 dedicated to the professional management of our fish and wildlife resources based upon scientific principles. We represent many thousands of fishermen from across the state who fish in our coastal waters. It is within this purview that we submit the following

comments on the proposed Shrimp FMP amendment to reduce finfish bycatch that the Marine Fisheries Commission will consider at their February 2014 meeting.

We strongly believe that the draft amendment to the shrimp plan falls far short of addressing the serious problem of bycatch in the shrimp trawling industry. It seems as if the draft amendment includes only proposals for industry testing of by-catch reduction devices, updating testing protocols for bycatch reduction device certification program, and requiring additional by-catch reduction devices in all shrimp trawl nets. These limited proposals will do little if anything to reduce by-catch.

The Shrimp FMP Advisory Committee met several times over the course almost a year and many additional, significant measures were discussed and considered. The recommended amendment contains no options for gear restrictions, no time closures, no areas closures, and no target reduction in bycatch. We believe definite, measurable reductions must be implemented by and for the commercial trawlers. The Shrimp FMP should be amended to include definitive goals, timetables, and management measures to accomplish significant by-catch reduction and an aggressive data collection and analysis program to monitor the success of management actions taken over the next five year period.

NCWF urges the MFC to amend the Shrimp FMP to include the following provisions:

1. Limit all trawl nets in inshore coastal waters (especially Pamlico Sound) to a maximum headrope size of 110 feet and only allow one net per boat. This would remove the large nets and their excessive bycatch but would allow the small trawlers that have shrimped in our sounds for generations to continue working uninterrupted. These smaller shrimp boats are mostly local boats, with local crews that sell their catch at local fish houses in North Carolina. Such a rule change would greatly benefit the vast majority of North Carolina shrimpers while truly helping our coastal economies and our marine resources by significantly reducing bycatch.
2. Limit tow times to 45 minutes. This would allow for some bycatch to be released alive and also increase the chance of sparing any endangered turtles which are entrapped in the net.
3. Delay shrimp season until the shrimp size has reached the level of having 36 to 41 (or lower) shrimp per pound. This would postpone the harvest of shrimp and allow juvenile finfish to grow larger and have more of a chance of escaping shrimp trawls. These fish would also have more time to move out of their nursery areas where the trawlers are now working. In addition, this change would cause the shrimp to be larger when they are harvested and market value would be greater, thereby benefiting shrimp fishermen.
4. Establish exclusion zones around both sides of our inlets where trawlers with headropes exceeding 90 feet would not be allowed. This would allow juvenile finfish that are transitioning to a life in the open ocean to escape our sounds without being killed by a shrimp trawler. These fish become concentrated when they are near the inlets and are especially vulnerable to trawlers until they can disperse into the ocean.

Now is the time to get serious about the finfish decimation caused by the current activities of shrimp trawling in the inshore waters of NC. Destruction of fisheries resources of this magnitude cannot and should not be tolerated any longer as it is in nobody's interests. If the proposed amendment to the Shrimp FMP is adopted as presented, the schedule for meaningful action will be delayed for years while we look for solutions, which in our opinion, are right before us now. We urge you to establish realistic goals, implement meaningful, deliberate, and measurable reductions by the industry, management measures, set a timetable for implementation, evaluate improvements in terms of by-catch reduction, and make subsequent changes as dictated by results.

Thank you for considering our requests,

Tim Gestwicki
CEO
North Carolina Wildlife Federation

Email received January 16

Please accept this communication as unconditional support of the Coastal Fisheries Reform Group's proposal, dated this day, regarding the referenced matter. My personal experience in a Marine Fisheries advisory capacity fosters my concern that, by the time any effective action is taken, it will be too late for the resource. Let's get on with a common sense approach, and do it now! Sincerely, Frank Liggett

Email received January 16

To whom this may concern: I fully support the CFRG's position on the proposed amendment to reduce shrimp trawling bycatch in NC. I urge you to do everything in your power to look at the science, and the reality, of the unconscionable damage that shrimp trawling is daily perpetuating on our environment, and act accordingly. Thank you, Lee Dunn, Beaufort

Phone call received January 23

Joe Buck called and suggested that shrimping should not be allowed at night, because you catch a lot more bycatch at night compared to day time shrimping.

Email received January 31

- * Limit all trawl nets in inshore coastal waters (especially Pamlico Sound) to a maximum headrope size of 110 feet and only allow two nets per boat.
- * Limit tow times to 60 minutes to allow some by-catch to be released alive and increase the chance of sparing endangered turtles trapped in the nets.
- * Delay shrimp season until the shrimp size has reached the level of having 36 to 41 (or less) shrimp per pound. This would postpone the harvest of shrimp and allow juvenile finfish to grow larger and have more of a chance of escaping shrimp trawls. These fish would also have more time to move out of their nursery areas where trawlers now work.
- * Establish exclusion zones around both sides of inlets where trawlers with headropes exceeding 110 feet wouldn't be allowed.

"Now is the time to get serious about the finfish decimation caused by the current activities of shrimp trawlers in the inshore waters of North Carolina," CFRG wrote. "Destruction of fisheries resources of this magnitude cannot be tolerated any longer."

CFRG also asked the Commission to establish "realistic goals, implement some meaningful management measures, set a timetable for implementation, evaluate improvements in terms of by-catch reduction, and make subsequent changes as dictated by results." it's time to get serious about the damage being done to our nurseries in nc thank you paul brown 600 n. rocky river rd. sanford n.c.

Email received January 31

Mr. Laughridge, It's time to end inshore shrimp trawling. Not reduce, not alter limits, no other half-steps, END. The old song of jobs lost doesn't cut it anymore. The damage trawling does FAR outweighs the benefit and this can and has been proven in many ways. If you would like I can easily support this position with data. The snowball is growing if you haven't noticed. Long

overdue change is coming to NC fisheries management. I hope to be able to count on you to finally take the big picture in to account and join every other east coast state and BAN inshore trawling. The reasons they banned it are 100% applicable here too. Thanks, Bruce

Email received January 31

Mr. Rose, It's time to end inshore shrimp trawling. Not reduce, not alter limits, no other half-steps, END. The old song of jobs lost doesn't cut it anymore. The damage trawling does FAR outweighs the benefit and this can and has been proven in many ways. If you would like I can easily support this position with data. The snowball is growing if you haven't noticed. Long overdue change is coming to NC fisheries management. I hope to be able to count on you to finally take the big picture in to account and join every other east coast state and BAN inshore trawling. The reasons they banned it are 100% applicable here too. Thanks, Bruce

Email received January 31

The CFRG recommendations on shrimp trawling would be a great step in the right direction. Better still, STOP ALL TRAWLING INSIDE! Farm raised shrimp is the way to go. Recreational fishing has become so bad now that it is barely worth trying in NC coastal waters. Friends and I have been fishing at the coast for more than 50 years and have found it difficult to catch enough fish for one dinner in the last several years. Our long trips to Florida for great fishing would end if NC would copy Florida's approach to marine management. rcaptroger@aol.com

Email received January 31

I have fished the North Carolina coast for over 30 years and have seen how the shrimp trawlers have destroyed the NC fishing. I would pay triple for shrimp or fish than to continue seeing the shrimp trawlers continue to destroy the fishing for not only myself but for all future fishermen. First of all the Commission or personnel involved in making changes to the fishing laws that have interest or own commercial fishing license should be banned from voting on changes to the fishing regulations. I really believe that if the N.C. Marine Fisheries Commission continue allowing nets and shrimp trawlers to continue in North Carolina, fishing for everyone will be destroyed. Looks at Virginia and how they banned nets and shrimp trawlers – five years after the ban, fishing is plentiful. Thanks for your time, Charles Brown, 109 Holly Creek Rd, Morrisville, NC 27560

Email received January 31

This, if all reports are even half way accurate, is a travesty...there is absolutely no way that killing all those small spots, croakers, and weakfish can have anything but a disastrous effect on those species....it does not take a fisheries biologist to recognize the terrible practice needs to be stopped or at least drastically changed. Shrimp trawling by catch is the 600 lb. gorilla in the room and he isn't going away. I ask the MFC to address this issue and do what is right for the resource, for a change. I, and a great number of others, am fed up with the lack of foresight and continued lack of courage that has allowed this issue to fester like a boil on the reputation of fisheries management in our state. Thank you, Hubert Parrott

Email received January 31

The people of NC should know about the by catch situation, if they did maby their would be better managment by the marine fishries. This has been going on for many years and has had a big impact on the poor fish stock situation. Billy Reavis [bjreavis@gmail.com]

Email received February 1

Ms. Fish: It is obvious that the SMP put forth by the Marine Fisheries Comm. is but a stopgap measure and will do nothing to actually limit the killing of juvenile finfish by trawlers in the sounds of NC. The coastal Fisheries Reform Group has listed a number of operating procedures and rules that IF ENACTED will actually give a more realistic chance for the survival of some of the affected finfish. I urge you to hear these proposals as a sincere effort to address the massive bycatch problem that retards any future growth of NC's fish stocks. Sincerely, Neil M. Smith, 486 Tom Absher RD. Scottville, NC 28672, neilmlynn@skybest.com.

Email received February 13

To: Fishwatch@noaa.gov

Good Morning,

Please take the following into consideration when you rate the impact of otter trawling caught NC shrimp for your FishWatch Bulletin.

The Atlantic States Marine Fisheries Commission is charged with managing weakfish (gray trout). The current weakfish stock status is severely depleted with the adult spawning population at levels so low, that further declines are expected. In fact, in 2003, the ASMFC projected a greater than 90% chance that weakfish biomass could fall to zero by 2015. In 2008, weakfish biomass was less than 4.5-million pounds, a 96% drop in thirty years. In a 2009 report, the ASMFC Weakfish Technical Committee states "Unless there has been a steady rise in weakfish juvenile discards since 1999, the emergence of a demographic bottleneck is consistent with enhanced predation (e.g. spiny dogfish and striped bass) on smaller weakfish."

What is a weakfish's #1 predator in NC? The Spiny Dogfish? The Striped Bass? The Pamlico Sound shrimp boat?

NCDMF Director Daniel has publicly stated that 4.5 to 1 is a clear and well established bycatch ratio in NC's shrimp industry. In 2008, NC landed 9.4-million pounds of shrimp. Approximately 68% of NC shrimp landings come from the Pamlico Sound system. According to NCDMF studies, juvenile weakfish represent approximately 7% of trawling bycatch in the Pamlico Sound. In those studies, weakfish bycatch averaged 27.5-fish per pound. In 2008, NC shrimp trawlers killed 55-million Pamlico Sound weakfish as bycatch, 2-million pounds. The total east coast weakfish spawning stock biomass was only 4.5-million pounds in 2008.

Bycatch is not only affecting weakfish, but also spot and croaker stocks- once both important seafood staples. Those two stocks had historical low catches in 2012. NC spot landings have dropped from 7.1-million pounds to less than 500,000-pounds, a 93% decline. NC croaker landings have dropped from 21.1-million pounds to 3.1-million pounds, an 85% decline.

On February 19-21, the NCMFC will meet in Morehead City and the topic of shrimp bycatch will be discussed. While there is always a possibility that meaningful change will come from that meeting, history will show such wishful thinking is doubtful. It appears the NCMFC is going to vote to "study" the issue for three more years, a vote for maintaining status quo. During the next three years, NC shrimpers will continue to trawl in critical habitat nursery areas important to weakfish, Atlantic croaker, spot, southern flounder and blue crab. Important finfish and crab stocks will continue to decline as trawling bycatch kills 1.0 to 1.5 billion juvenile species in

those three years.

I understand that it is difficult for outside agencies to control what happens in the territorial waters of NC, but those agencies can at minimum- acknowledge the problem, document it and suggest improvements to NC's unsustainable fishery practices, practices that are not only detrimental to NC fish stocks, but interstate fish stocks.

Thank you for your time and consideration. Sincerely, Rick Sasser, Goldsboro, NC,
rick.sasser@hotmail.com

Email received February 17

Can all of bycatch be converted to Economic Value & nothing was returned to water, would By Catch remains a problem in shrimp fishery? Product would be worth 10 to 12.5 cent per pound. Pass question on to whom ever. Thank you, James Fletcher, United National Fisherman's Association, 123 Apple Rd. Manns Harbor NC 27953, Phone: 252-473-3287 Cell: 757-435-8475, Fax: 252-473-4969

14.3 APPENDIX 3 – REVISION REVIEW PROCESS

MEMORANDUM

TO: Management Review Team

FROM: Shrimp Plan Development Team

DATE: May 3, 2012

SUBJECT: Amendment versus Revision of the Shrimp FMP

The Shrimp Plan Development Team (PDT) has met and discussed the question of whether or not the Division Shrimp Fishery Management Plan (FMP) should be amended or revised. The PDT has met on three occasions to discuss management issues that have developed since the implementation of the 2006 Shrimp FMP. These issues include:

1. Restricted Trawl Area Offshore of Bogue Banks
2. Permanent Shrimp Line in Newport River
3. Trawling in New River above the Highway 172 Bridge
4. Volumetric Measurement of Shrimp

Each issue was addressed by the PDT in issue papers (see attached), including management options. After thorough discussion, no management changes were recommended for three of the four issues listed above. The fourth issue; Volumetric Measurement of Shrimp was discussed and two options were suggested for consideration by the Management Review Team (MRT). Both options require a rule change and it is unclear to the PDT whether these suggested rule changes constitute a change in management of the shrimp fishery.

To insure the public was aware that the Shrimp FMP was under review, a press release was sent out on November 7th, 2011 requesting public comment as part of our review process to determine whether to proceed with an amendment or revision of the FMP. The last day for comment by the public was December 2nd, 2011. The PDT received five comments. Each comment was reviewed and addressed by the PDT (see attached). A sixth comment was received on December 9th, after the deadline and after the PDT's review of the other comments. This comment was forwarded to the PDT and is also included within the public review document but was not thoroughly reviewed by the PDT outside of email.

After careful consideration of the issues listed above and of the public comments, the Shrimp PDT recommends to the MRT that the Shrimp FMP should proceed as a revision.

/plm
Enclosures

PERMANENT SHRIMP LINE IN NEWPORT RIVER

November 15, 2011

I. ISSUE

In the 2006 Shrimp Fishery Management Plan (FMP) a permanent closure line was established at the Penn Point-Hardesty Farm line. Fishermen who fish in Newport River would like the Division to repeal this rule in Newport River.

II. ORIGINATION

A request was made by the Newport River fishermen.

III. BACKGROUND

The Newport River is a relatively small estuary of about 63 square miles located north of Morehead City in Carteret County. Average depth is less than three feet with a maximum depth in natural channels of six feet and 40 feet in the dredged channels near the State Port. The western portion of the Newport River has bottoms composed of silts, clays and oyster rocks and the eastern part is composed of a firm sand bottom. There is a Primary Nursery Area (PNA) and a Special Secondary Nursery Area (SSNA) located in the western portion as well.

Before the 2006 FMP, the Newport River had a long history of disagreements concerning the best location of a shrimping closure line. Lines used in the past were the Hardesty Farm line, the White Rock line (SSNA line) and the Turtle Rock line (PNA line). During this long period of conflict that peaked in the mid-1980s, the line would move several times during a season in response to requests by fishermen and the variation in shrimp size. By October of each year the river would open to the PNA line with the opening of the SSNA by proclamation. Based on input from the public, the Shrimp Advisory Committee, the Division of Marine Fisheries and the Marine Fisheries Commission (MFC), a permanent trawl nets prohibited line was established from Penn Point to Hardesty Farms (15A NCAC 03R .0106) (Figure 1).

Shrimp harvest generally begins in June with the presences of brown shrimp and can continue into November and sometimes as late as December if white shrimp are abundant. The primary conflict has historically occurred in the fall, between fishermen, who generally wanted the Hardesty Farm line established because shrimp that have migrated down are a more marketable size. This line also allows for more maneuverability for large shrimping vessels, while other fishermen with smaller vessels, preferred the White Rock line (SSNA) in order to access the shrimp and harvest the majority of them, before the shrimp moved down to the Hardesty Farm line. The White Rock line is located in shallow water, where the larger boats are unable to work because only a small portion of the White Rock line is deep enough for trawling.

The western half of the Newport River above the Hardesty Farm permanent closure line contains sites where significant shellfish management efforts have occurred over the past 35 years. Natural oyster rocks extend from the Cross Rock in the western part of the river through White Rock located at the mouth of Harlowe Creek. Oyster rocks also exist along the shores of Newport River Marshes and the entrance to Core Creek. The Division has planted approximately 201,514 bushels of cultch material in the western portion of Newport River above the Hardesty Farm line since 1981 and 22,990 from 2006 through 2011. These plantings have

expanded the natural rocks (Flat Rock, White Rock, Turtle Rock and the Bullseye Rock). There are also 15 active leases above the shrimp line totaling 103 acres.

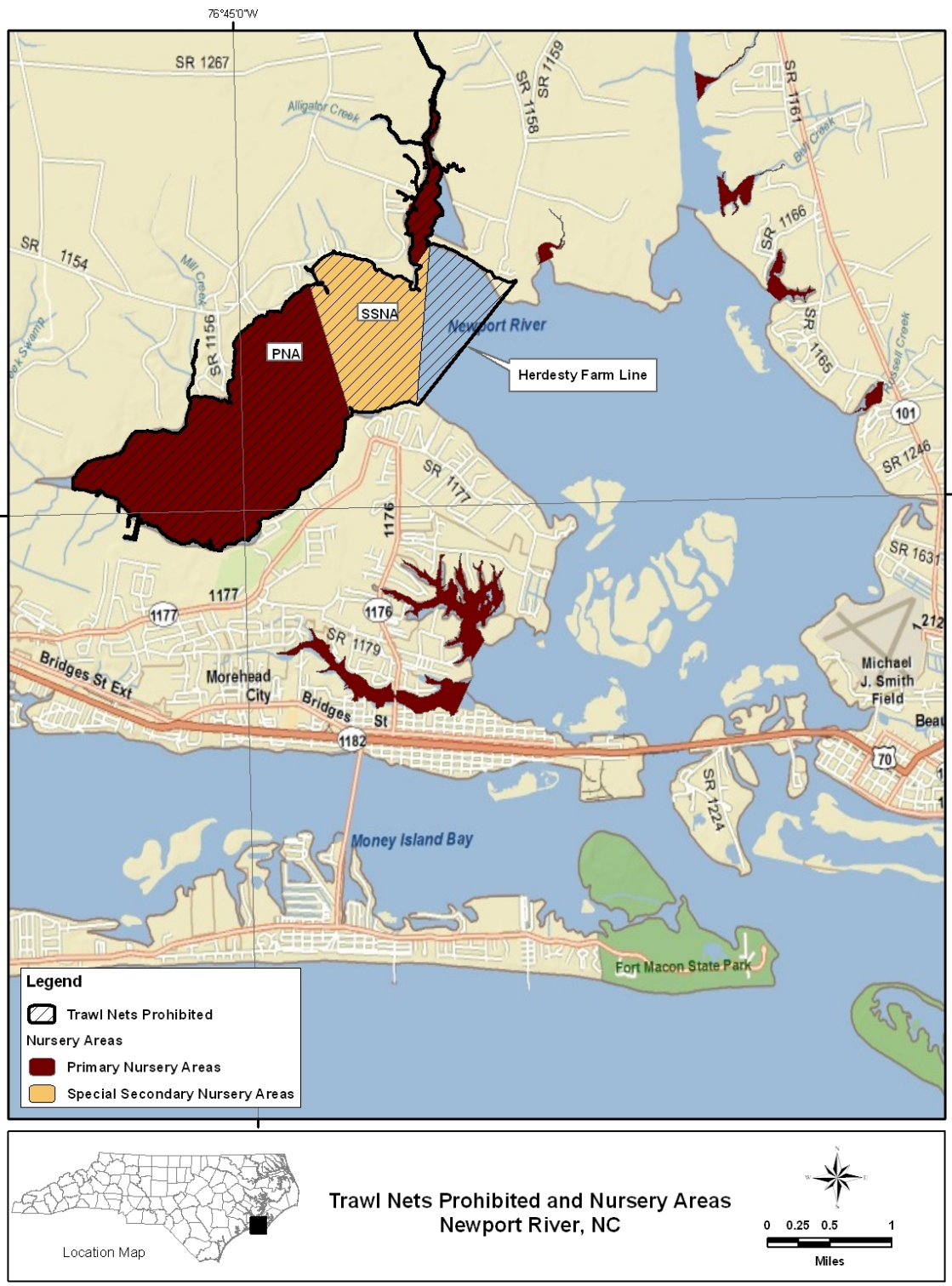


Figure 1. Newport River Shrimp Lines

III AUTHORITY

G.S. 113-182.1 FISHERY MANAGEMENT PLANS

North Carolina Marine Fisheries Commission Rules for Coastal Fishing Waters (15A NCAC) 15A NCAC 03R .0106 TRAWL NETS PROHIBITED

IV. DISCUSSION

Since 2006, the implementation of the Hardesty Farms line has been successful because it protects small shrimp that move out of Harlowe Creek in the early summer and provides a buffer when the abundance of juvenile shrimp, heavy rainfall or strong northerly winds pushes the shrimp downstream of their normal location. The permanent line has also eliminated the costs and time spent by division staff sampling this area in response to requests to move the shrimp closure lines. Total landings in the Newport River do not appear to have been impacted by the establishment of the permanent line (Figure 2). Total fall landings in the Newport River for the years when the lines moved (2001-2005) ranged from 4% to 33%. After implementation of the permanent line in 2006, total fall landings ranged from 15% to 23%. Number of trips during the same time frame has averaged 200 per year from 2001 to 2005, while number of trips averaged 109 from 2006 through 2010. Overall, fall landings have remained stable, averaging approximately 20% of the total landings in Newport River before and after the implementation of the permanent line (Figure 2).

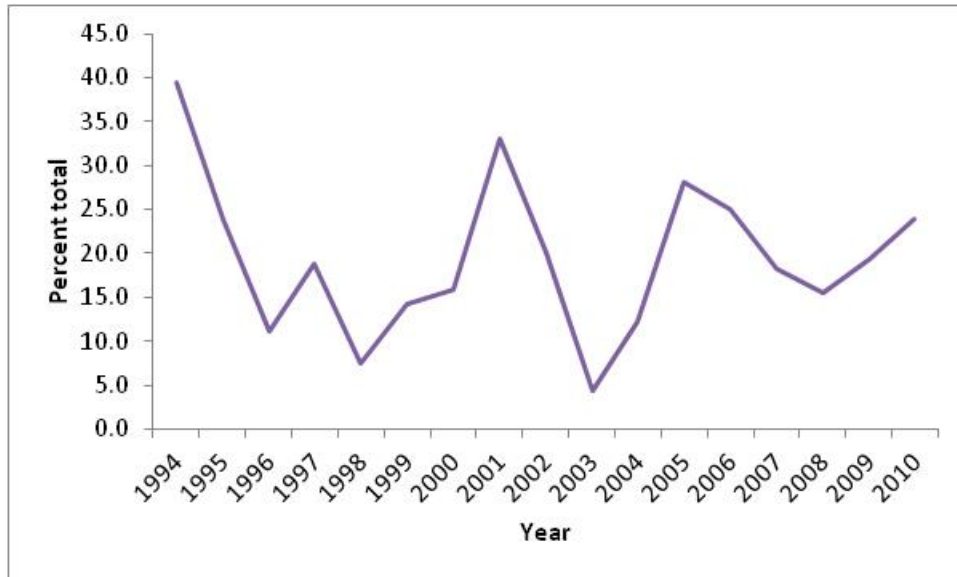


Figure 2. Percent total landings (lbs.) from October through December in Newport River

Juvenile spot, croaker, brown shrimp, blue crab and southern flounder utilize the PNA and SSNA habitats in Newport River. Trawling is prohibited in PNAs; however, the Fisheries Director may open SSNAs by proclamation from August 16 through May 14. With the implementation of the Hardesty Farm line in rule, the Fisheries Director no longer has the authority to open the Newport River SSNA. This protects leases and other oyster resources

from being trawled over or covered in sediment. This was a frequent concern for both lease holders and resource enhancement staff of the division when the SSNA was opened to trawling.

Small mesh gill net attendance rules have been impacted by the implementation of the Hardesty Farm line causing confusion to fishermen because of a contradiction in gill net attendance requirements. Rule 15A NCAC 03R .0112 (b) (1) states that in areas that are prohibited to trawl nets, permanent secondary nursery areas and in PNAs, small mesh gill nets must be attended from May 1st through November 30th. However according to 15A NCAC 03R .0112 (b) (5) gill net attendance is from May 1st through September 1st within 50 yards of the shore line. The Rules Review Team will be addressing this contradiction.

Proponents for trawling above the permanent line and in the SSNA cite the lack of growth of remaining shrimp due to falling water temperatures and the need to stir up sedimentation by trawling to remove silt from the upper river and that stirring the bottom removes silt (at least at ebbing tides), keeps it oxygenated (or alive), and exposes old oyster rocks and plantings to new spat set the following spring. Fishermen have noted an increase in siltation since the area has been closed to trawling.

V. PROPOSED RULE(S)

VII. MANAGEMENT OPTIONS/IMPACTS

(+ Potential positive impact of action)

(- Potential negative impact of action)

1. *Status quo* (permanent line at Hardesty Farm)
 - + Eliminates grand openings
 - + Protection of shellfish plantings, natural oyster rocks and leases
 - + Longer and deeper line for less congestion when trawling
 - +/- Trawling in SSNA is prohibited
 - No flexibility of management by proclamation
 - Continued confusion of small mesh gill net attendance

2. Remove permanent line at Penn Point-Hardesty Farm
 - + Provides flexibility in managing around variable conditions (excessive rainfall, early migration)
 - + Access to resource by a variety of users
 - + Able to open the SSNA by proclamation
 - No confusion on small mesh gill net attendance
 - Does not minimize harvest of small shrimp and bycatch
 - Does not prevent damage to shellfish plantings, natural rocks and leases
 - Labor intensive and expensive to sample
 - Necessitates "grand openings"

VIII. RECOMMENDATION

PDT: *Status quo* (permanent line at Hardesty Farm)

Prepared by: Trish Murphey
Trish.Murphey@ncdenr.gov
(252)-726-7021
November 15, 2011

Revised:

NOTICE OF TEXT ATTACHMENT

#6 – Explain Reason for Proposed Action:

MFC Rulebook Index Worksheet

Rule	Rulebook Page #	Subject	Index Entry	Add/Delete

TRAWLING IN NEW RIVER ABOVE THE HIGHWAY 172 BRIDGE

November 15, 2011

I. ISSUE

Request to reexamine the provision in the 2006 Shrimp Fishery Management Plan (FMP) which prohibits the use of otter trawls upstream of the Highway 172 Bridge over the New River.

II. ORIGINATION

Request by the New River shrimp and crab trawlers

III. BACKGROUND

The use of otter trawls upstream of the Highway 172 Bridge was phased out in 2010 following the adoption of the 2006 Shrimp FMP. Those who wished to continue to harvest shrimp in the waters above the 172 Bridge were allowed a four year grace period to convert to skimmers. Subsequently, crab trawls were also phased out of this area as part of the 2006 Shrimp FMP. Prior to the 2006 Shrimp FMP, crab trawlers would often fish above the Highway 172 Bridge to target flounder more so than crab; however, stricter minimum size limits for flounder made it economically unfeasible for crab trawlers to harvest only crabs in this area. Currently, the waters upstream of the Highway 172 Bridge are only open to boats equipped with skimmer rigs.

The waters upstream of the Highway 172 Bridge (Figure 1) were designated by rule as a Special Secondary Nursery Area (SSNA) in 1996. The areas of the SSNA that are impacted by the trawling opening include the river above the bridge up to the marked closure line running from Grey's Point to the opposite side of the river. Trawling in any of the tributary creeks is prohibited. The river consists mostly of shallow bays with the exception of the marked navigation channel. Bottom types range from sand and sand/mud to live shell bottom. The Division of Marine Fisheries (DMF) actively manages seven Shellfish Management Areas (SMAs) in this portion of New River.

Data from the DMF Trip Ticket Program were used to describe the commercial shrimp fishery in New River from 1994 to 2010 (Tables 1-5). Landed bycatch by gear was calculated and ratios (in pounds) of marketable bycatch relative to shrimp catch were also calculated for the four main gears: channel nets, otter trawls, skimmers, and the various miscellaneous gears (cast nets, gill nets, etc). Marketable bycatch from skimmers was consistently lower than with the other gears. Marketable bycatch landings in channel nets were also low, with the exception of 2000-2002 when significant amounts of blue crabs were landed in this fishery. In 2005, trip limits were put in place to restrict harvest of crabs in channel nets in the first crab fmp.pg.18 O3J.0106 (h). During this three-year period, ratios of pounds of shrimp per pound of marketable bycatch in the channel nets were 4:1, 2:1, and 3:1 respectively. These bycatch ratios apply only to the portion of bycatch retained and sold.

Discarded bycatch is much more difficult to quantify because of the lack of data in most areas. However, during 2003-2009, DMF staff sampled the study area for shrimp management purposes using a 25-foot, 4-seam otter trawl. This gear was not equipped with a turtle excluder or a finfish excluder. Catches were separated into four categories: commercial finfish, non-

commercial finfish, invertebrates, and shrimp. Each component was weighed and bycatch percentages were derived for each year (Table 6). Tow times ranged from one to 10 minutes. The primary objective of the sampling was to determine if the shrimp were large enough to warrant an opening or a closing but the weights of all the biomass components were recorded.

Overall, finfish accounted for 39.6% of the total biomass, with shrimp representing 51.2% of the weight, and invertebrates making up the remaining 9.1% of the weight from 2004 to 2009. Total bycatch ranged from 42.0% (2006) to 97.1% (2008).

The number of trips by the major shrimp gears indicates a decrease in effort for all gears from 1994 to 2010 (Figure 2). Following the ban of trawls above the Highway 172 Bridge, the numbers of otter trawl trips and participants dropped significantly in the New River. Prior to the ban, only 10 trips were made by seven participants in 2009 and only 13 trips were made by seven participants in 2010. The use of channel nets and skimmer rigs increased slightly in 2010. Prior the 2006 Shrimp FMP, channel nets were fished in the waters above and below the Highway 172 Bridge while skimmer effort was focused more in the SSNA located above the bridge. Currently, channel nets are only allowed to be set above the 172 Bridge Channel when the river opens to trawling by proclamation. Channel nets show the most consistency in the mean number of pounds harvested per trip while skimmers and otter trawls show similar year-to-year fluctuations; skimmers generally harvest more shrimp per trip (Figure 3). Landings from skimmers have shown a marked increase since 1994 reflecting the increased popularity of this gear, especially in the capture of white shrimp during the late summer and early fall (Figure 4). However, the variability of catches between all the gears is expected and is a result of year class strength.

The number of trips made by crab trawls also indicates a decrease in effort from 1994 to 2010 (Table 5). Following the adoption of the 2006 Shrimp FMP, there were no reported trips from 2007 to 2009 (Figure 5). In 2010, 32 trips were made by nine participants below the 172 bridge, landing 23,383 pounds of crab. Prior to the trawl ban above the Highway 172 Bridge, mean catch per trip ranged from 64 to 725 pounds from 1994 to 2006. In 2010, an average of 731 pounds of crab per trip was landed below the Highway 172 Bridge, well above the 262 pound per trip average observed from 1994 to 2006 when trawls were allowed above the bridge (Figure 6).

IV. AUTHORITY

G.S. 113-182.1 FISHERY MANAGEMENT PLANS

15A NCAC 03J .0104 TRAWL NETS

15A NCAC 03J .0208 NEW RIVER

15A NCAC 03L .0101 SEASON

15A NCAC 03N .0105 PROHIBITED GEAR, SECONDARY NURSERY AREAS

V. DISCUSSION

As part of the 2006 Shrimp FMP, otter trawls were prohibited by proclamation upstream of the Highway 172 Bridge in the New River beginning in 2010. Subsequently, this also prohibited the use of crab trawls, eliminating a traditional Sneads Ferry fishery, prompting the remaining members of that fishery to question the prohibition. The area above the Highway 172 Bridge is still designated as a SSNA, but the use of otter trawls is prohibited to minimize waste/bycatch and disturbance to the bottom. Additionally, trip ticket harvest data indicates that following the prohibition of otter trawls in New River SSNA, otter trawl bycatch has been reduced significantly

while the mean catch per trip (lbs) for shrimp has remained fairly high for the rest of the river (Table 2; Figure 3). The trip ticket data also indicates that skimmers are more effective at catching the target species than conventional otter trawls (Table 3). A skimmer trawl study conducted by Sea Grant found that skimmers were much more effective on white shrimp than otter trawls in water less than 12 feet (most of the water above the bridge in the New River) and in some cases out-fishing otter trawls as much as five to one (Coale, et al. 1994). The majority of the shrimp openings in the New River SSNA are for white shrimp, since by late summer most of the brown shrimp have already migrated.

Continuing to prohibit the use of all trawls, including crab trawls, above the Highway Bridge 172 protects the New River SSNA from bottom disturbing activities. Given the inherent design of most crab trawls (heavy-framed gears designed to dig into the substrate) the effect they have on the benthos is no different than that of otter trawls used to take shrimp. In some cases their effect on the benthos is worse due to their added weight. In addition, trip ticket data indicates that the highest mean catch per trip (lbs) occurred in 2010 when trawlers were not allowed access to the New River SSNA; higher than that of all the years prior to the trawl ban (Table 2). The implementation of the rule that prohibits otter trawls above the Highway 172 Bridge has been successful; opening the waters to crab and shrimp trawls would only reverse the progress made in the 2006 Shrimp FMP.

VI. PROPOSED RULE(S)

VII. MANAGEMENT OPTIONS/IMPACTS

(+ potential positive impact of action)
(- potential negative impact of action)

1. *Status quo* (prohibit trawls as an allowable gear in New River SSNA)
 - + Benefit to existing Shellfish management areas
 - + Encourage the use of a more efficient gear for harvesting white shrimp
 - + Reduction in waste/fish kills, especially on opening day
 - + Added protection for sub-legal flounder in New River SSNA
 - Eliminates part of a traditional Sneads Ferry fishery in this SSNA
 - Difficult to catch shrimp in a few deep-water spots
 - Financial hardship on trawlers who would likely convert to skimmers
2. Allow all trawlers in New River SSNA
 - + Allows prosecution of traditional fishery in SSNA
 - + Possible decreased financial hardship
 - No immediate remedy for waste/fish kills on opening day
 - No benefits to SMAs
 - Increased harvest on opening day, reduced price at market
3. Prohibit all trawlers and skimmers in New River SSNA
 - + Bycatch issue completely eliminated
 - + Potential for healthier shellfish/finfish stocks
 - Eliminates potential lucrative opening days for fishermen
 - Eliminates traditional Sneads Ferry fishery in this SSNA

VIII. RECOMMENDATION

PDT recommendation: *Status quo*

Prepared by: Chris Stewart
Chris.Stewart@ncdenr.gov
(910)-796-7370
November 15, 2011

Revised: November 15, 2011
December 9, 2011

Literature Cited

Coale, J.S., R. A. Rulifson, J. D. Murray, and R. Hines. Comparisons of shrimp catch and bycatch between a skimmer trawl and an otter trawl in the North Carolina inshore shrimp fishery. *North American Journal of Fisheries Management* 14: 751-768.

MFC Rulebook Index Worksheet

Rule	Rulebook Page #	Subject	Index Entry	Add/Delete

Table 1. Catch and effort data on shrimp and landed bycatch for channel nets in New River, 1994-2010 (courtesy of DMF trip ticket program).

Year	Participants	Trips	Shrimp (lbs)	Sold bycatch (lbs)	Mean catch per trip (lbs)	Ratio shrimp of sold to bycatch
1994	37	544	47,556	747	87	64
1995	39	850	87,536	1,435	103	61
1996	36	585	62,590	1,894	107	33
1997	44	1,122	86,610	3,065	77	28
1998	29	856	80,714	428	94	189
1999	40	1,453	124,727	4,444	86	28
2000	45	1,380	163,109	38,998	118	4
2001	41	1,112	137,595	79,793	124	2
2002	38	1,257	163,831	61,907	130	3
2003	33	835	100,667	1,685	121	60
2004	32	570	59,799	4,370	105	14
2005	19	126	15,379	886	122	17
2006	18	206	57,011	240	277	238
2007	15	255	36,742	1,043	144	35
2008	14	168	40,892	750	243	55
2009	10	118	16,558	259	140	64
2010	19	322	39,297	1,279	122	31

Table 2. Catch and effort data on shrimp and landed bycatch for otter trawls in New River, 1994-2010 (courtesy of DMF trip ticket program).

Year	Participants	Trips	Shrimp (lbs)	Sold bycatch (lbs)	Mean catch per trip (lbs)	Ratio shrimp of sold to bycatch
1994	120	807	53,787	7,115	67	8
1995	152	1,186	152,285	12,142	128	13
1996	96	508	42,113	3,941	83	11
1997	109	828	79,788	3,721	96	21
1998	109	569	109,034	4,875	192	22
1999	141	755	77,956	4,537	103	17
2000	157	614	163,640	7,479	267	22
2001	70	186	14,926	4,389	80	3
2002	76	445	91,652	4,710	206	19
2003	67	247	39,264	5,612	159	7
2004	62	174	32,618	4,085	187	8
2005	26	58	11,820	1,528	204	8
2006	21	88	26,029	666	296	39
2007	36	71	21,117	1,735	297	12
2008	19	36	11,499	1,127	319	10
2009	7	10	1,016	30	102	34
2010	10	13	3,450	5	265	690

Table 3. Catch and effort data on shrimp and landed bycatch for skimmer in New River, 1994-2010 (courtesy of DMF trip ticket program).

Year	Participants	Trips	Shrimp (lbs)	Sold bycatch (lbs)	Mean catch per trip (lbs)	Ratio shrimp of sold to bycatch
1994	5	12	1,468	7	122	226
1995	25	85	21,554	0	254	0
1996	34	224	42,677	267	191	160
1997	41	341	75,029	188	220	400
1998	43	302	69,396	13	230	5,338
1999	49	449	68,813	222	153	310
2000	77	615	155,949	2,508	254	62
2001	44	306	36,043	1,879	118	19
2002	51	832	173,091	1,701	208	102
2003	55	564	89,780	1,356	159	66
2004	37	432	82,384	385	191	214
2005	24	155	21,714	307	140	71
2006	15	169	76,501	121	453	632
2007	27	265	93,094	152	351	611
2008	20	148	48,834	12	330	4,246
2009	9	42	4,973	3	118	1,658
2010	16	297	102,032	330	344	309

Table 4. Catch and effort data on shrimp and landed bycatch for other gear (cast nets, gill nets, etc.) in New River, 1994-2010 (courtesy of DMF trip ticket program). *Data confidential due to less than three participants reporting landings.

Year	Participants	Trips	Shrimp (lbs)	Sold bycatch (lbs)	Mean catch per trip (lbs)	Ratio shrimp of sold to bycatch
1994	2	2	*	*	*	1
1995	24	162	12,837	11,043	79	1
1996	12	20	884	1,528	44	1
1997	11	53	2,934	4,394	55	1
1998	3	6	130	442	22	0
1999	5	10	387	553	39	1
2000	11	18	1,041	827	58	1
2001	7	9	519	819	58	1
2002	5	5	209	184	42	1
2003	5	16	670	27	42	25
2004	6	5	100	710	20	0
2005	4	4	594	1,039	149	1
2006	10	64	4,870	349	76	14
2007	6	16	790	2,100	49	0
2008	3	6	329	631	55	1

Table 4 (cont).

Year	Participants	Trips	Shrimp (lbs)	Sold bycatch (lbs)	Mean catch per trip (lbs)	Ratio shrimp of sold to bycatch
2009	1	1	*	*	*	0
2010	3	3	140	104	47	1

Table 5. Catch and effort data on crab and landed bycatch for crab trawls in New River, 1994-2010 (courtesy of DMF trip ticket program). *Data confidential due to less than three participants reporting landings.

Year	Participants	Trips	Crab (lbs)	Sold bycatch (lbs)	Mean catch per trip (lbs)	Ratio crab of sold to bycatch
1994	7	35	10,848	492	310	22
1995	15	94	33,616	3,512	358	10
1996	14	47	8,284	519	176	16
1997	14	187	33,196	2,777	178	12
1998	10	62	3,988	373	64	11
1999	12	32	23,214	489	725	48
2000	11	42	17,643	555	420	32
2001	16	103	17,476	446	170	39
2002	13	77	12,190	183	158	67
2003	15	101	18,732	459	185	41
2004	23	159	41,192	863	259	48
2005	14	125	28,060	113	224	248
2006	2	5	*	*	*	17
2010	9	32	23,383	61	731	386

Table 6. Percent of weight in pounds of trawl biomass caught in the DMF 25-foot, 4-seam otter trawl in New River 2003-2009.

Year	Shrimp	Invertebrate	Commercial Finfish	Non-commercial Finfish	Combined Finfish	All Bycatch
2003	29.9	18.0	36.3	15.7	52.0	70.1
2004	40.2	14.2	24.7	20.9	45.6	59.8
2005	40.8	13.9	30.9	14.3	45.2	59.2
2006	58.0	6.2	27.7	8.1	35.8	42.0
2007	38.7	9.0	40.6	11.7	52.3	61.3
2008	2.9	7.8	23.2	66.1	89.3	97.1
2009	1.4	8.2	43.5	38.6	82.1	90.3
All	51.2	9.1	23.3	16.3	39.6	48.8

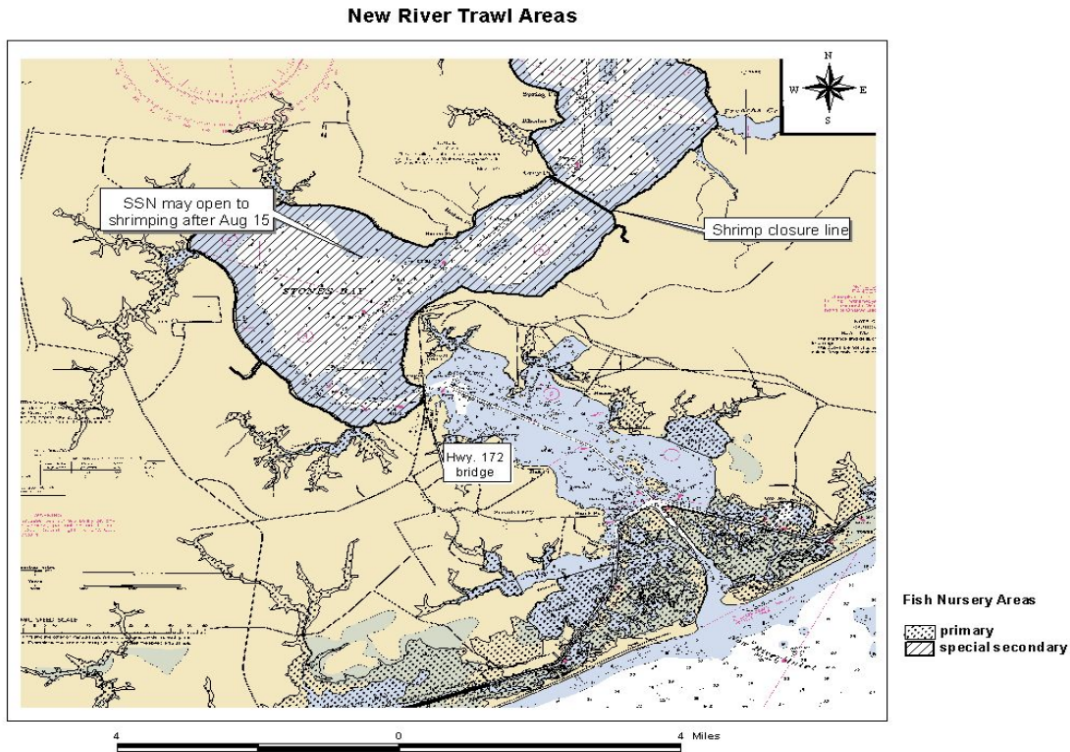


Figure 1. Map of the New River showing the areas for the PNAs and SSNA as well as the other trawl closure line.

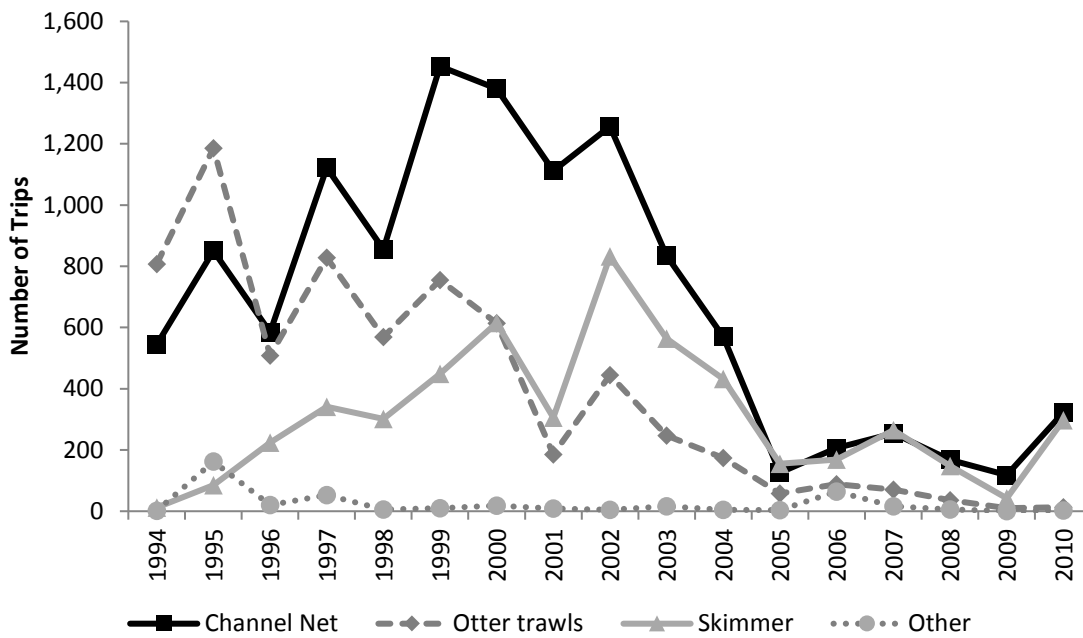


Figure 2. Shrimp trips by gear in New River, 1994-2010.

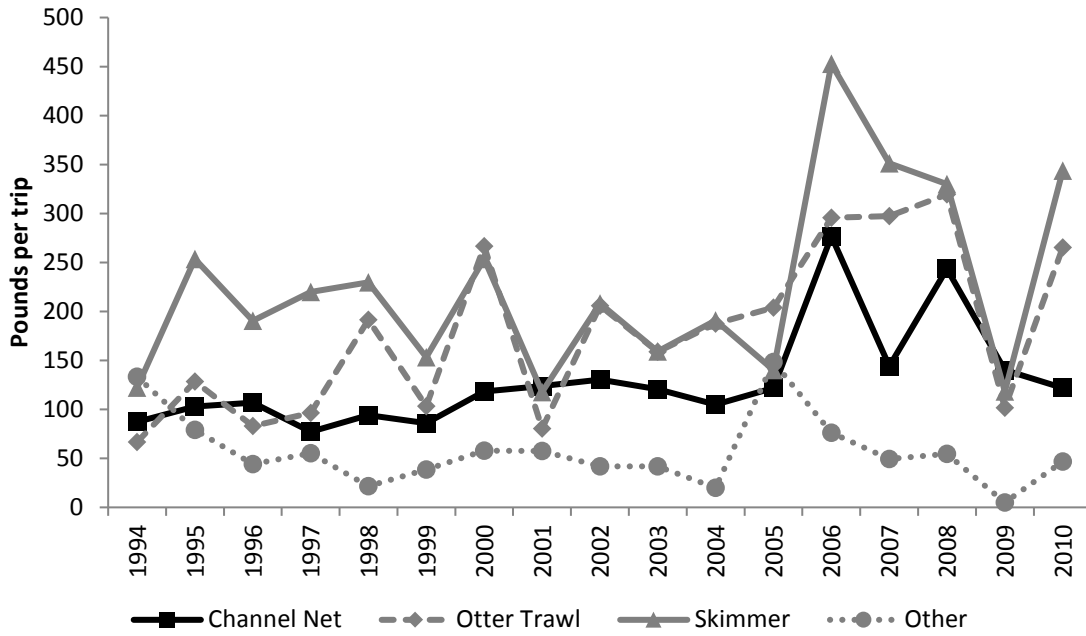


Figure 3. Mean catch of shrimp in New River, 1994-2010.

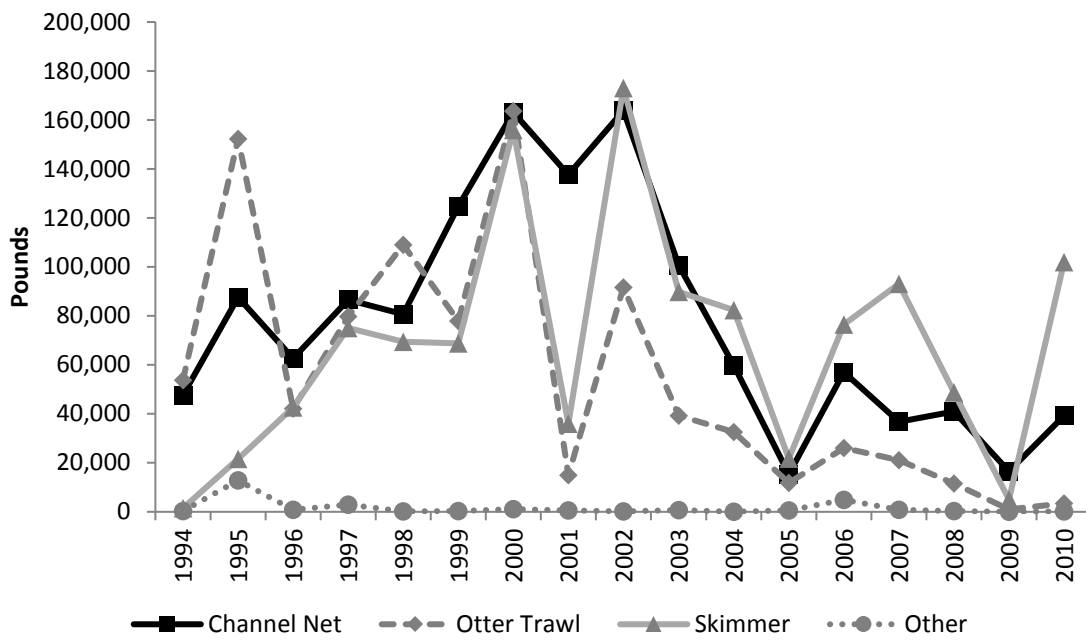


Figure 4. Total catch of shrimp in pounds by gear in the New River, 1994-2010.

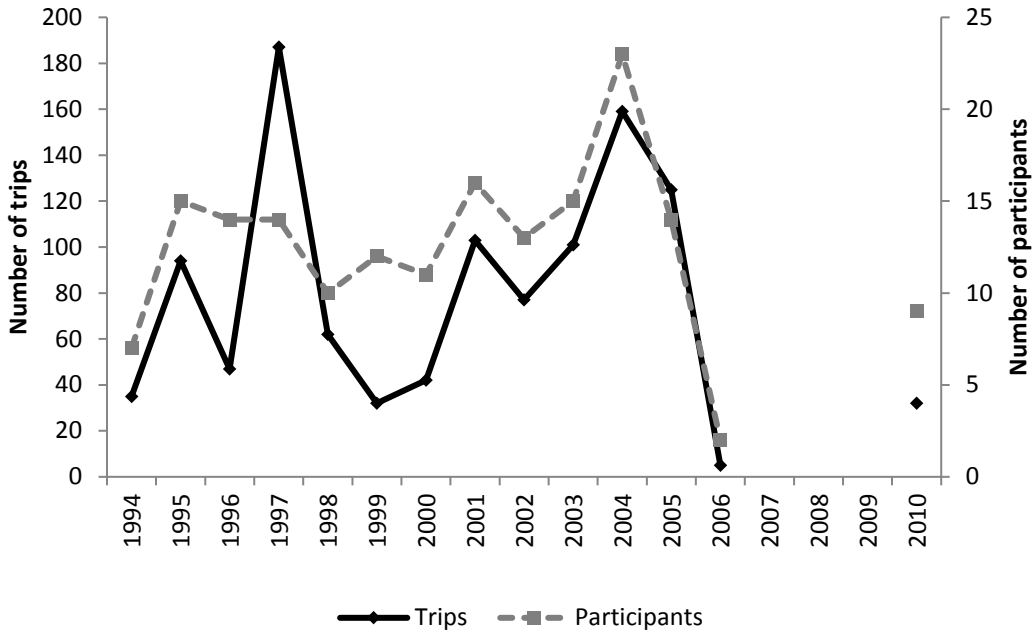


Figure 5. Number of trips and participants in the New River crab trawl fishery, 1994-2010.

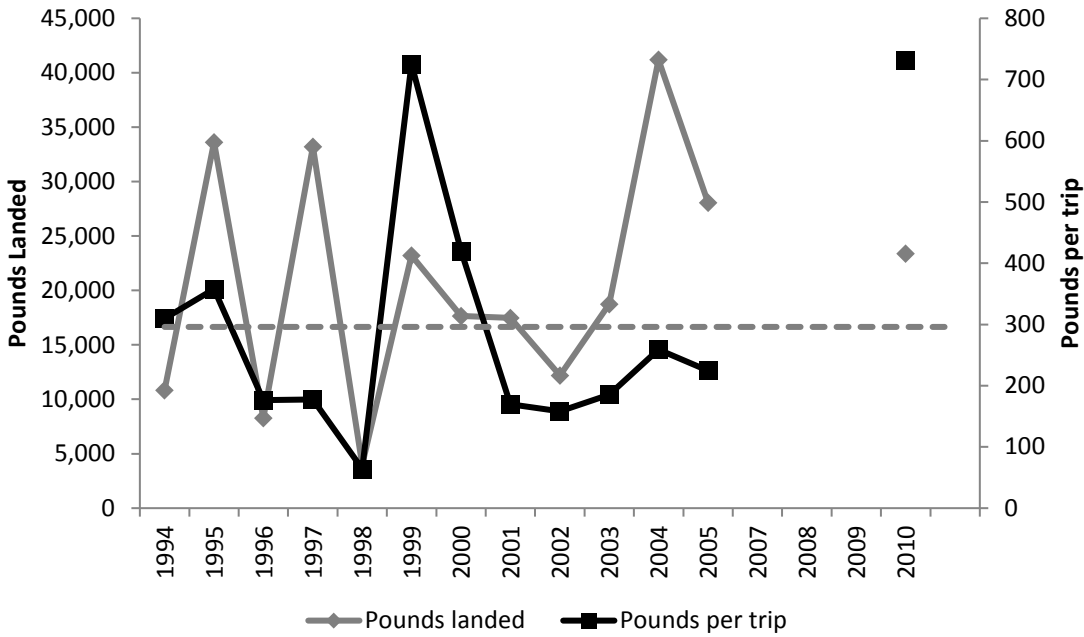


Figure 6. Pounds of crab landed and number of pounds of crab landed per trip in the New River crab trawl fishery, 1994-2010. Dotted line represents the average pounds per trip landed from 1994-2010.

VOLUMETRIC MEASUREMENT OF SHRIMP

December 9, 2011

I. ISSUE

Under Rule 15A NCAC 03L .0105 (2) recreational fishermen using cast nets in closed areas to harvest shrimp are limited to 100 shrimp per person per day, it was requested that a volumetric measurement of shrimp be used in place of counts to check individuals.

II. ORIGINATION

The North Carolina Marine Patrol

III. BACKGROUND

The cast net fishery was originally developed for live bait fishermen who wanted to capture shrimp for bait. Overtime the fishery has evolved into a means of capturing shrimp for personal consumption and for sale. This rule has been in place since 1985, with very few changes made since its inception; however, the number of participants in the cast net fishery for shrimp in these closed areas has drastically increased. As a result of this increase in recreational consumption harvest for shrimp harvested with cast net gears, it has become increasingly difficult and dangerous for Marine Patrol officers to enforce the 100 count rule. This is mainly due to the nature of this fishery, where a number of fishermen will work together and combine their harvest in a single large container. This will often time lead to a Marine Patrol officer having to count shrimp while surrounded by numerous fishermen. Establishing a volumetric measurement would help to alleviate this problem.

IV. AUTHORITY

G.S. 113-134 Rules

G.S. 113-182 Regulation of Fishing and Fisheries

G.S. 143B-289.52 Marine Fisheries Commission—Powers and Duties

15A NCAC 03L.0101 Season

15A NCAC 03L.0105 Recreational Shrimp Limits

V. DISCUSSION

The Marine Patrol would like to use a volumetric measurement of shrimp instead of an individual count of 100 heads on shrimp per person. This method would be a more efficient and effective way to check individuals who harvest shrimp with a cast net in closed areas, allowing officers to check more individuals. This method would also make it safer for each officer working alone, who may need to determine the quantity of shrimp harvested for a number of recreational cast netters. The count of 100 shrimp takes a lot of time, especially when there are extra ordinary circumstances involved, i.e., weather, numerous fishermen, language barriers, time of day, live shrimp, size, and location. By using a volumetric measurement of shrimp, an officer would not have to bend down and expose their backs, weapon and other body parts in a manner that could leave them vulnerable to attack. The Marine Patrol would like to use a half-gallon bucket, approximately 80-120 shrimp depending on size as the standard volumetric measurement of shrimp taken by cast nets in a closed area. This proposed measure would still allow fishermen to retain shrimp for bait purposes and promote officer safety.

VI. PROPOSED RULE

15A NCAC 03L .0105 RECREATIONAL SHRIMP LIMITS

It is unlawful to:

(1) Possess more than 48 quarts, heads on or 30 quarts, heads off, of shrimp per person per day or if a Vessel is used, per vessel per day for recreational purposes except as provided in 15A NCAC 03O .0303 (e) and (f).

Option 1

(2) Take or possess shrimp taken from any area closed to the taking of shrimp except ~~100 shrimp per one half gallon~~ of heads on shrimp person per day may be taken while fishing in a closed area with a cast net. Individual limits shall be kept in separate one half-gallon containers.

Option 2

(2) Take or possess shrimp taken from any area closed to the taking of shrimp except 100 shrimp per person per day may be taken while fishing in a closed area with a cast net. Individual limits shall be kept in separate containers.

*History Note: Authority G.S. 113-134; 113-182; 143B-289.52;
Eff. April 1, 2009.*

VII. PROPOSED MANAGEMENT OPTIONS

(+ Potential positive impact of actions)

(- Potential negative impact of actions)

1. *Status quo* (continue to limit fishermen to 100 shrimp in closed areas)
 - + Still allows shrimp to be taken for bait purposes only
 - + No equipment to be purchased
 - + No grey areas, either 100 shrimp or not
 - Very time consuming when dealing with large groups
 - Potential safety issues when working alone
2. Use a volumetric measurement of shrimp (limit fishermen to one half gallon heads on shrimp)
 - + Officers less vulnerable to attacks
 - + More effective use of time, allowing more people to be checked
 - + Standardization of measurement throughout the State
 - + No numbers to keep track of
 - Shrimp may exceed 100 or less depending on size/count
 - Larger containers may promote the use of cast nets to take shrimp in closed areas for consumption and not for bait purposes
 - Extra gear to carry
3. Limit fishermen to 100 shrimp in closed areas but require individuals to keep their catch in individual containers
 - + Still allows shrimp to be taken for bait purposes only
 - + No equipment to be purchased
 - + No grey areas, either 100 shrimp or not
 - Very time consuming when dealing with large groups
4. Eliminate the ability to take or possess 100 shrimp per person per day in areas closed to shrimping.

- + Officers less vulnerable to attack
- + Less time consuming for officers to enforce
- + No equipment to purchase
- Eliminates a bait fishery

VIII. RECOMMENDATIONS

PDT: Use a volumetric measurement of shrimp (limit fishermen to one half gallon heads on shrimp) OR;
 Limit fishermen to 100 shrimp in closed areas but require individuals to keep their catch in individual containers

Prepared by: Lieutenant Michael S. Ervin
 Michael.ervin@ncdenr.gov
 (910)-796-7286

Revised: December 9, 2011

NOTICE OF TEXT ATTACHMENT

MFC Rulebook Index Worksheet

Rule	Rulebook Page #	Subject	Index Entry (Bold major headings)	Add/Delete
03L.0105(2)	40	Recreational Shrimp Limits		

RESTRICTED TRAWL AREA OFFSHORE BOGUE BANKS

November 15, 2011

I. ISSUE

Request to investigate the history of existing Marine Fisheries Rule 15A NCAC 03J .0202 (3), which prohibits trawling within one-half mile of shore in the Atlantic Ocean between Beaufort Inlet and Salter Path with the intention of changing that distance to one-fourth of a mile.

II. ORIGINATION

Marine Fisheries Commissioner in January of 2009

III. BACKGROUND

The Marine Fisheries Commission (MFC) has made use of its authority to regulate fishing practices in areas of existing or potential conflict between user groups. This prohibition of trawling within one-half mile of shore in the Atlantic Ocean between Beaufort Inlet and Salter Path originated in 1967 in an effort to separate conflicting user groups and residents along the shore from shrimp trawlers. Until a few years ago, there were four ocean piers (TripleS, Oceanana, Sportsman's and Sheraton), several public swimming areas (Fort Macon State Park, Oceanana, Atlantic Beach Circle, Sheraton), Fort Macon State Park, and several beachfront developments (Tar Landing, Sea Spray, Place at the Beach, etc.). The prohibition of trawling within one-half mile of the beach separated trawlers from physical proximity to the ocean fishing piers and helped reduce the amount of bycatch discarded from the trawlers that washed up on the beach during prevailing southwest winds in the summer, disturbing Park officials, beach and pier anglers, beachgoers and residents. Due to the removal of two of the four fishing piers, it has been requested that the one-half mile distance from shore in rule be reduced to one-fourth of a mile to allow for white shrimp harvest during years when they are present along the beach.

IV. AUTHORITY

G. S. 113-134 RULES

G.S. 113-182 REGULATION OF FISHING AND FISHERIES

G.S. 143B-289.52 MARINE FISHERIES COMMISSION –POWERS AND DUTIES

North Carolina Marine Fisheries Commission Rules for Coastal Fishing Waters (15A NCAC)

03J .0104 TRAWL NETS

03J .0202 ATLANTIC OCEAN NET RULES

V. DISCUSSION

The request to reduce the distance that Atlantic Ocean shrimp trawlers (by virtue of the mesh sizes in the rule) must stay offshore of the eastern portion of Bogue Banks was made due to a reduction in the number of ocean fishing piers present from four to two. Two piers still exist (Oceanana and Sheraton) in that area as does the state park, swimming beaches and more numerous condominium developments. Public sentiment against trawling has become increasingly negative in the past few years and bycatch washed up on the beach is less well-tolerated (based on complaints) by beachgoers and residents. Therefore, even though the

number of piers has decreased by two, the remaining two piers, increased houses and condominiums, the state park and public and private swimming areas that are present still cause the same concerns that led to the 1967 closure. With a legislative study ongoing to look at banning trawling, relaxing restrictions that have been effective is not advised.

It must be noted that while examining this issue, the Shrimp FMP PDT found a contradiction to other existing rules regarding mesh size. This contradiction will be examined by the Rules Advisory Team and addressed in a separate issue paper.

VI. PROPOSED MANAGEMENT OPTIONS

(+ Potential positive impact of action)

(- Potential negative impact of action)

1. *Status quo* (prohibit shrimp trawling within one half mile of shore in the Atlantic Ocean between Beaufort Inlet and Salter Path)
 - + No change in distance from shore requirement
 - + No potential increase in complaints from pier patrons, swimmers and beachgoers
 - Continued restriction of area that shrimp trawlers have access to
2. Allow shrimp trawling within one quarter mile of shore in the Atlantic Ocean between Beaufort Inlet and Salter Path
 - + Additional area opened to shrimp trawling in that area
 - Potential increase in numbers of complaints received due to increased bycatch and physical interaction with pier patrons and beachgoers.

VII. RECOMMENDATION

PDT: Due to the remaining two fishing piers along that stretch of shoreline, increased condominium development and the continued presence of the state park and swimming beaches (Oceanana, Fort Macon State Park, Dunes Club, the Circle, etc.), it is recommended that the rule remain *status quo*.

Prepared by: David L. Taylor

David.L.Taylor@ncdenr.gov

252-808-8074

October 7, 2011

NOTICE OF TEXT ATTACHMENT

#6 – Explain Reason for Proposed Action:

**15A NCAC 03J .0202 ATLANTIC OCEAN
MFC Rulebook Index Worksheet**

Rule	Rulebook Page #	Subject	Index Entry (Bold major headings)	Add/Delete
03J .0202 (3)	20	Atlantic Ocean Trawling		

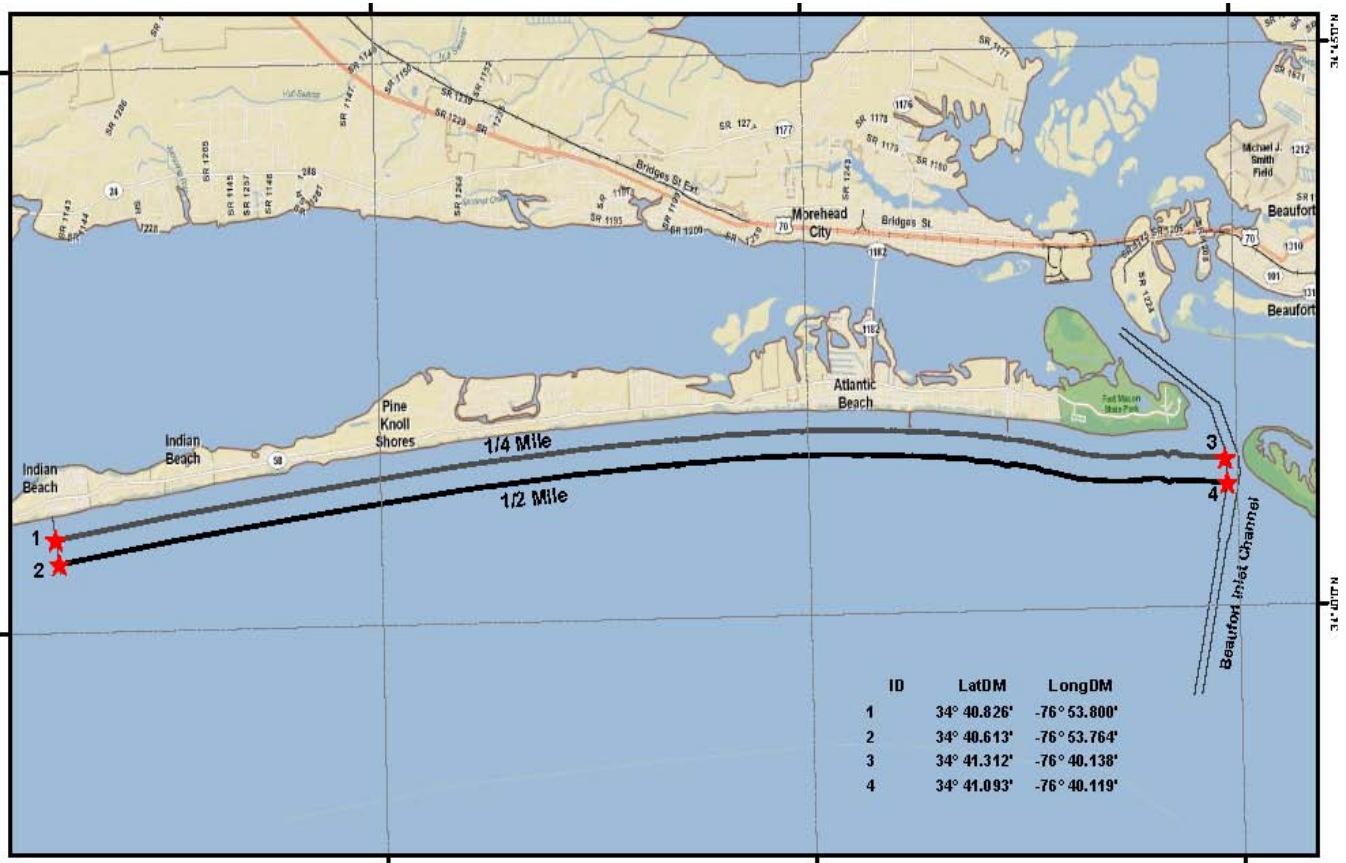


Figure 1. Bogue Banks Trawl Restricted Area 15A NCAC 03J .0202 (3)

Public Input for Shrimp FMP review 2011

Press Release sent November 7, 2011

MOREHEAD CITY – The N.C. Division of Marine Fisheries is asking the public to submit comments on issues they would like to see addressed in an upcoming Shrimp Fishery Management Plan.

The division is beginning a mandated five-year review of the N.C. Shrimp Fishery Management Plan that was adopted by the N.C. Marine Fisheries Commission in 2006. The agency is soliciting public comment as part of an internal process to determine what procedural method to take in reviewing the plan.

If changes in management strategies or rules are needed, the division will pursue a plan amendment, where division staff and an advisory committee develop positions on specific issues that need to be addressed. If changes in management strategies are not required, the division will proceed with a revision, which is a more abbreviated process that involves updating data and fishery information contained in the plan.

Written comments will be accepted until Dec. 2 and should be addressed to Trish Murphey, N.C. Division of Marine Fisheries, P.O. Box 769, Morehead City, N.C. 28557 or sent by email to Trish.Murphey@ncdenr.gov or to Chris Stewart, N.C. Division of Marine Fisheries, 127 Cardinal Dr., Wilmington, N.C. 28405 or sent by email to Chris.Stewart@ncdenr.gov.

State law requires the division to prepare a fishery management plan for adoption by the Marine Fisheries Commission for all commercially and recreationally significant species or fisheries that comprise state coastal waters. These plans provide management strategies designed to ensure long-term viability of the fishery. State law also requires the division to review each fishery management plan every five years.

###

nr-53-11

From the Public

1. You want to finally start managing the shrimp-- EASY! Ban all trawling in the waterways and nurseries, for years I have watched the tiny shrimp get murdered in the waterways, for the most part they are so small these guys cull thru them for just the big ones and shovel the smaller ones overboard, along with all the juvenile dead fish, what a waste. I also have observed the boats on the outside shoveling and culling thru the smaller shrimp when the market is flooded, I remember years back when marine fisheries had the inside and outside closed and kept sampling till the shrimp reached a predetermined size on the outside, these were white shrimp, that was a win win, everybody made the best money they had in years because the shrimp were a decent count and brought a fair price. In summary, ban all trawling on the inside, it will help the fishery and the shrimp season, allow both commercial and recreational to bait and cast net for their shrimp, eliminates the bycatch

and people will not be killing the juvenile (popcorn) shrimp, which in turn will make it profitable for the outside boats, anyone wanting to commercial trawl can afford a real shrimp boat now., Also control the outside trawling, keep it closed until the white or brown shrimp reach a predetermined size.

PDT Response

Currently, it is unlawful to use trawl nets for any purpose in primary nursery areas (15A NCAC03N .0104) and permanent secondary nursery areas [15A NCAC03N .0105(a)]. In areas considered special secondary nursery areas (SSNA), it is unlawful to use trawl nets except by proclamation from the Fisheries Director from August 16 through May 14 [15A NCAC03N .0105(b)]. Management rationale for this rule included minimizing bycatch by delaying the trawl opening date to reduce the finfish bycatch and to reduce user conflicts. Shrimp abundance, count size, growth, as well the abundance of other economically important species (crabs and finfish) are sampled prior to August 16 depending on waterbody. Once it has been established that the shrimp are of a fair marketable size and bycatch is minimal, a proclamation is issued opening that area. Generally the ocean, sound, and major rivers remain open to shrimping year round except when extreme environmental conditions lead to significant percentages of small shrimp in that area. Allocating the resource solely to commercial ocean trawlers does not consider the needs of all user groups and does not provide sufficient opportunities for recreational and commercial shrimpers to optimize the use of the resource, thus not meeting the goals of the Shrimp FMP. In addition, a legislative study committee has been appointed to look at trawling in North Carolina. This includes all trawling, not just shrimp trawling and therefore will not be further addressed in this FMP.

NC Shrimp Fishery Management Plan 2006

http://portal.ncdenr.org/c/document_library/get_file?uuid=7dc55c67-c6df-4a39-9ffc-32471c055c23&groupId=38337

See Shrimp Trawl Bycatch p 90

See Shrimp Management by Size in North Carolina estuaries p 92

See Shrimp Management in the Atlantic Ocean p 110

2. Address the ongoing problem of shrimp size (or count): as re-opening and closing of the season.

I guess what I am looking for is a solution for a waste of our resource. Each year it seems to be in a different water body so my suggestion is to have a state-wide count rule. What I mean by waste is the low price that small shrimp bring. It seems that all other species have a size limit. I think one could fit the shrimp fishery. My suggestion of size would be 36/40 heads on minimum.

PDT Response

In North Carolina, shrimp develop at different growth rates depending on water temperature and salinity. Post-larvae shrimp are carried by wind driven currents from the ocean to the upper reaches of the estuaries, where in several weeks they develop into juveniles. As growth increases, shrimp migrate to the deeper, saltier waters of the sound and eventually to the ocean. As shrimp migrate to the ocean, they enter areas that are open or may be opened by the DMF to the harvest of shrimp. These areas include bays, creeks, rivers, sounds and the ocean. Sampling is conducted by the DMF staff to determine if an area should be opened or closed, based primarily on size and count. Over time, target sizes for opening different waterbodies have evolved and allows for better flexibility of management for both recreational and commercial shrimpers than what a single statewide count size will allow.

NC Shrimp Fishery Management Plan 2006

http://portal.ncdenr.org/c/document_library/get_file?uuid=7dc55c67-c6df-4a39-9ffc-32471c055c23&groupId=38337.

See Shrimp Management by Size in North Carolina Estuaries p 92

3. Changes were adopted in 2006 for the boundary lines for trawling in the Neuse River. They were extended down river about a mile to Wilkerson's Point (around the ferry landing). I would like to see the boundary go back to where they were prior to 2006. This allowed us to harvest shrimp around the mouth of Baird and Slocum creeks. I am still allowed to pull a crab trawl but not a shrimp trawl in this area. Impact in these areas is minimal because of shallow waters. Only small boats harvest shrimp in this area. Please present this in the upcoming Shrimp Management plan. I pulled a shrimp trawl around the mouth of Bairds Creek for thirty years until they closed it. Thanks for your time and voice.

PDT Response

The 2005 Southern Flounder FMP recommended that shrimp trawling be examined with the goal of reducing the impact of incidental shrimp trawl bycatch on juvenile southern flounder. The restrictions that resulted from the 2006 Shrimp FMP established the shrimp trawl line at Wilkerson Point and Cherry Point. Prior to this, no line had been established. Crab trawling was not impacted due mainly to the difference in mesh sizes between shrimp and crab trawls. Crab trawls must have a minimum of four inch (stretch mesh) webbing while shrimp trawls have a minimum mesh length of one and one half inches, allowing fewer juvenile flounder to escape. The 2009 DMF stock assessment indicated that the southern flounder stock is overfished and overfishing is occurring and since the stock is heavily influenced by recruitment, it is felt that this measure should remain in place. The Marine Fisheries Commission has had a standing policy since 1991 to “establish the goal of reducing bycatch losses to the absolute minimum and to consciously incorporate that goal into all its management considerations”.

NC Shrimp Fishery Management Plan 2006

http://portal.ncdenr.org/c/document_library/get_file?uuid=7dc55c67-c6df-4a39-9ffc-32471c055c23&groupId=38337.

See Southern Flounder Bycatch in the Inshore Shrimp Trawl Fishery p 91

See Shrimp Management in Neuse River p 106

4. Phone in with input about the (1) amount of puppy drum in the southern rivers and their predatory impacts on shrimp in the rivers. There are “acres of schools” of puppy drum in the rivers. One fisherman this person mentioned, was fishing for mullet and it took 4.5 hours to remove the drum from the net. (2) New River has become a cleaner river and that we should consider opening New River further up (halfway to Jacksonville) to skimmer trawls. This person is a supporter of skimmer trawls.

PDT Response

Red drum prey upon numerous species of shrimp, crab, and fish at various stages of their life history. Other species of fish also prey upon penaeid shrimp making it hard to quantify exactly how much is consumed by each species and what effect it has on the year-to-year fluctuations in shrimp abundance. There also has been a strong body of scientific evidence indicating that as red drum grow, their diets shift from shrimp and crab to primarily fish. In many cases age 1-2 red drum consumed fish more frequently, in greater numbers, and in greater volume than either shrimp or crabs alone. Given that the 2009 Atlantic States Marine Fisheries Commission stock assessment for red drum indicates that the current regulations have been effective at preventing

overfishing, it is unlikely that these regulations will be changed to protect species outside of red drum.

Division of Water Quality staff from the Wilmington Regional Office agree that the New River is cleaner in some aspects, noting that there have been fewer algal blooms resulting from nutrient loading associated with municipal discharge. However, the shrimp line established at Grey Point was created to protect smaller shrimp until they grow to a harvestable size and not due to water quality. Based on the 2006-2010 DMF juvenile shrimp management sampling, shrimp biomass was typically higher for stations below the current line. In other regions of the state fishermen have also expressed their displeasure in the constant movement of shrimp lines, the line established at Grey Point is well marked (telephone poles and orange barrels), easily enforceable by Marine Patrol, and has been widely accepted by fishermen since the 1980s. NC Red Drum Fishery Management Plan Amendment I 2008

http://portal.ncdenr.org/c/document_library/get_file?uuid=cd9ce130-c426-40d7-b9d1-ecf446dec77e&groupId=38337

See Stock Status of Northern Red Drum Stock (attached at the end)

NC Shrimp Fishery Management Plan 2006

http://portal.ncdenr.org/c/document_library/get_file?uuid=7dc55c67-c6df-4a39-9ffc-32471c055c23&groupId=38337

See Shrimp Management in New River Above the Highway 172 Bridge p 96

5. Over the years, one of NCDMF's answers to shrimp management has been to close certain areas of NC's coastal waters. While that may be an effective management effort for some areas over a given period of time; I am convinced that closing an area and keeping it closed for years and years is not a real good shrimp management practice. Maybe it was for awhile, but by keeping these areas closed on a permanent basis is having a negative impact on the resource, the areas closed, and the fishermen.

Maybe it's time to try some other management practices such as reopening some of these areas on certain days of the week and restricting the size and type of trawls used in these areas. Also, in some cases we may be better served by allowing the resource to manage itself.

PDT Response

Many of the lines in existence now have resulted from years of practical experience, sampling and public input. The North River lines, for example were the result of a public meeting in Harkers Island in June of 1997. At that meeting, fisherman expressed displeasure over the constant movement of the lines at that time and negotiated acceptable lines to be made "permanent" with DMF staff. While extreme rainfall events occasionally force small shrimp downstream of the lines, overall the lines serve the purpose of protecting smaller shrimp until they grow to a harvestable size and migrate out of the creeks, into the river and out of the inlet. The question of "cultivating" or "turning over" the bottom in these long-closed areas is one which has its proponents and detractors. A large body of research exists (although very little of it local) documenting negative effects of damage caused by the physical trawl and resulting sedimentation to seagrass beds, oyster rocks, coral reefs and larval fish and shellfish

NC Shrimp Fishery Management Plan 2006

http://portal.ncdenr.org/c/document_library/get_file?uuid=7dc55c67-c6df-4a39-9ffc-32471c055c23&groupId=38337

See Environmental Factors p 59

See Management of Trawling for Habitat Protection p 90

See Shrimp Management in Bogue Sound and North River p 104

6. *Unfortunately I just got my Beacon Newspaper in the mail, and thus missed the deadline for input on shrimp issue [Dec 2]. However, if there is interest in hearing some thoughts at this late date, I offer the following.*

In southern Brunswick County, Marine Fisheries identifies the side of the intercoastal waterway as "primary nursery", no trawling allowed, in recognition that the side of the waterway is nursery area. However MF allows trawling in the middle of the intercoastal. The obvious question is ... "what happens as the tide goes out", and the obvious answer is all the marine life that MF is attempting to protect in the primary nursery flows with the outgoing tide to the middle of the waterway, and thus is subject to trawling. Clearly the rules in this instance work in conflict with each other. Thus, a SOLUTION. What if trawling wasn't allowed 3 hours before low tide and 3 hours after low tide? This would prevent juvenile marine life from direct exposure to trawling in the middle of the waterway during low water.

The same issue impacts juvenile marine life leaving creeks out to the waterway on a outgoing tide. SOLUTION: Don't allow trawling within 1000 yards of a creek leading into the intercoastal. Sharing my thoughts; sorry I missed the deadline, but hope you can pass on to the MF folks.

PDT Response

This management strategy would be difficult to enforce and would further restrict shrimpers in the Brunswick county area, basically closing shrimping in the IWW. Large portions of the IWW around the Yaupon Beach Bridge (Yellow Banks) would be closed to shrimping as well a majority of the waterway below the Shallotte Inlet to the South Carolina state line. Most fishermen in Brunswick County tend to work around the tides. In North Carolina, the tides follow a semi-diurnal pattern; with two high tides and two low tides each day at different heights. Only allowing fishermen to fish three hours before and after each low tide would subsequently limit fishing to 12 hours. Further compounding the problem is the fact that the tide cycle shifts about an hour forward each day, forcing fishermen to work at night if they are to catch the right tide. More fishermen on the water at night could lead to potential safety issues and increased user conflict among boaters and shrimpers alike.

NC Shrimp Fishery Management Plan 2006

http://portal.ncdenr.org/c/document_library/get_file?uuid=7dc55c67-c6df-4a39-9ffc-32471c055c23&groupId=38337

See Shrimp Management in Brunswick County p 101

2012 Shrimp FMP Revision Committee Review Table

At the MFC meeting in August of 2012, the MFC voted to send the 2012 Shrimp FMP Revision to regional and standing committee review as well as public review. The revision was presented to the Southern Regional AC, the Northern Regional AC, the Habitat and Water Quality AC and the Crustacean/Shellfish AC during September and October of 2012. Table 13.1 summarizes recommendations of the different ACs. The DMF changed its recommendation from revise the plan to amend the plan after following the AC meetings and public comment (Table 13.1).

Table 13.1 Advisory Committee recommendations on whether to revise or amend the Shrimp FMP

ISSUE	DMF	SOUTHERN Sept 19	NORTHERN Sept 27	HABITAT AND WATER QUALITY Oct 2	CRUSTACEAN/SHELL FISH Oct 2
Recommend the revision or the amendment of the 2006 Shrimp FMP. The 2012 revision of the plan had data up through 2010, latest fishery trends, a new protected resources section and the continuation of management strategies put in place through the 2006 Shrimp FMP.	<p>May 2012 Recommend to revise the Shrimp FMP</p> <p>Oct 2012 Recommend to amend the Shrimp FMP</p>	<p>Recommend an amendment to the Shrimp FMP. Recommend to investigate the use of otter trawls upstream of the 172 Bridge over New River and adding a special license for bait shrimp fishery.</p> <p>150 public attended</p>	<p>Recommend to revise the Shrimp FMP</p> <p>6 public attended</p>	<p>Recommend to revise the Shrimp FMP</p> <p>4 public attended</p>	<p>Recommend to revise the Shrimp FMP.</p> <p>55 public attended</p>

Public Comment

Bycatch

Bycatch is no different from what it was years ago.

There are less shrimpers today, thus their impact is less. Among those who are left, effort is down. We can't afford to go unless we know there is a market.

This is a good plan. We catch 25 lbs of shrimp and catch 25 lbs of bycatch, 85% of the bycatch lives. I have caught 5-6 speckled trout per season and have never caught a drum. I catch mostly croakers and pinfish. When you catch a lot of shrimp, there is very little bycatch.

Ninety percent of bycatch is tongue fish and pinfish.

A 2004 bycatch study showed Cape Fear had a bycatch ratio of 0.38:1, Williams Landing had a ratio of 0.7:1, and Brunswick County had a ratio of 1.55:1.

I do all I can to return bycatch to the water.

Otter trawls, skimmer trawls, and channel nets all have bycatch. There is bycatch in the ocean too.

We have BRDs in our nets to let out the bycatch.

I throw out flounders and crabs first, croakers live a while.

I worked with Logothetis on bycatch study. There was less than 1 lb of total bycatch to 1 lb of shrimp and 0.5 lbs of finfish bycatch to 1 lb of shrimp.

There are four species (spot, croaker, weakfish, and flounder) that are concerned” or “depleted.” To meet the objectives of the plan, the Division needs to amend the plan and study the best course of action.

A revision means status quo. I want an amendment. We are wasting spot, weakfish and croaker. You have to go to VA to catch croaker. Limit inshore trawls to 50 ft headrope length.

Yes there is bycatch. Efforts have been made to reduce bycatch. There were nine active packing houses, now there are three. There is less bycatch now because effort is down. Trawlers are bigger and come from out of state. Look at headrope length.

There are 480 million to 500 million juvenile finfish killed annually. We need to minimize bycatch. Look at 50 ft headrope limit.. Amend FMP to address the issue of bycatch of shrimp trawlers operating in our inshore waters.

Bycatch has been addressed. PNAs were recommended by the NCFR. There are TEDs and BRDs that were developed through cooperation of the industry. Can't say it is good enough, but the industry has done things to address bycatch.

Need to amend the plan. There are other things we can do to reduce bycatch while sustaining and perpetuating the industry. Reduce internal trawling and study its effects.

Need to amend the plan. There are multiple gear types to replace trawling. Limiting the size of the gear may also work. The plan lacks adequate options.

Spot fishing is down 90%, Croaker are plentiful in VA, weakfish landings are down; all the states south of us are reporting higher catches than NC.

Using numbers from the DMF website, finfish landings appear to be down 90% based on best years (70s & 80s) and worst years (2006-2009). Water quality is an issue, but bycatch is problem. Amend.

Looking at the landings data for spot, croaker, and weakfish as indicators of the stock's health is misleading; there are other reasons beside bycatch driving why landings down. The loss of the flynet fishery south of Hatteras, less effort, and new regulations are just a few of the things that have caused the landings to go down. It's not that the fish aren't there, they are not being caught.

If we push trawlers out 3 miles, bycatch will still be a problem and we will then have to deal with super draggers.

The industry is trying to reduce bycatch, we would be willing to give up head rope lengths before be pushed out 3 miles.

We need to implement a maximum head rope length of 50 feet in certain areas to reduce the amount of juvenile finfish being killed.

We need to amend, to address both commercial and recreational bycatch. Cast nets catch bycatch too.

Regulations

More rules will kill us.

Do not need any more changes. Do not like what has been done.

The shrimp fishery needs zero management.

We do not need any more regulations. Our rights are being violated. We are overregulated now. You are discriminating against otter trawls. They should be allowed to work above the 172 bridge just like skimmer trawls.

There are too many rules. We do not need any more closures.

I disagree with allowing skimmer trawls above the 172 bridge and not otter trawls.

If skimmer trawls can go up New River, then otter trawls should be allowed too.

Shrimping regulates itself.

The goal says to consider all user groups. I am a live bait shrimp dealer. You need to consider a special license for bait shrimp fishermen. I pull a 15 ft trawl and pull 10 minute tows. There is very little bycatch. You have bait shrimping licenses in other states. Managing by size does not allow for a bait shrimp fishery to exist. Can we look into what other states have done and how they do their licensing?

I am concerned about the turtles. I see a lot of turtles that have been hit by boats.

You can't manage by size because it changes from year to year and a set size or count may not work every year. At beginning of the year smaller shrimp are worth more and fishermen should be allowed to catch and sell these.

Socio/Economic

We are losing our heritage. Our rights are being destroyed.

There are far less of us than in the past. Our impact can't be that great. Pamlico Sound is not like it used to be. There are fewer boats everywhere.

You need a historical perspective of bycatch, the industry has greatly diminished.

You worry about the mortality of finfish, what about the mortality of fishermen?

If you cut out shrimping, then we will be sitting on the streets collecting food stamps.

It's the large fish houses and bigger boats that are making all the money. More regulations will only hurt the smaller operations. If you change anything, you will put the small boats out of business.

There are very few of the younger generations fishing; there is no use for them to get into the fishery because of all the regulations. In the 1980s, 95% of the fishermen relied on all their income to come from fishing. Now it's more like 51%. Everyone else has to rely on other sources of income.

If shrimp are not available in a particular area, then we don't go, our boats burn too much fuel to go look for them.

Small shrimp are worth more, early in the season, when they are the first on the market. Once those shrimp size up, the larger shrimp from Pamlico sound flood the district and our shrimp aren't worth anything when their shrimp are selling for \$2 a pound. When the shrimp get bigger, they fall out to the ocean, where we can't catch them. We should have access to them.

Effort is down, probably due to economics (rising fuel / operations costs, imports) more so than management measures.

I have seen a lot of impacts from the shrimp fishery. Finfish numbers are down. I make a living off the recreational fishery. Boat manufacturers, other tackle store owners are being impacted. You need to amend the shrimp plan. My tackle shop is losing money as a result of the poor fishing in North Carolina, bycatch and its effects need to be addressed.

Imports are killing us, fuel prices are killing us, we don't need any new regulations; North Carolina consumers want wild caught shrimp.

There are forces at work trying to end shrimping in NC, fishermen need to strike together and join up with the North Carolina Shrimpers Association

Habitat and Water Quality

We need to clean out the creeks. Increased development and population growth are degrading the habitat.

The New River bottom needs to be stirred up. There are no brown shrimp anymore.

The sewage plant from Holly Ridge is filling New River.

Sewer plant outlets and pump-out stations need to be examined; their water is overflowing into our PNAs. Pollution also enters our nursery areas from Marines washing boats down.

Sludge from the Marine Corp Base and Jacksonville is in the New River. The river needs turning up to get the stuff off the bottom.

If you don't turn the bottom over, New River won't produce.

If you close Pamlico Sound, then you need to just give up sportfishing and crabbing. You need to drag the bottom. Look at Rose Bay. It has not been dragged for years and now there is very little in it.

The habitat and water quality is bad in Neuse River.

Pamlico Sound is the second largest nursery area. Need to do something, so amend the plan.



CCA North Carolina
Board of Directors

Jim Hardin
Chairman

Greg Hurt
President

Bud Abbott
Vice President

Dr. Cogill
Vice President

Dick Hamilton
Vice President

Seth Vernon
Vice President

Bud Abbott
Treasurer

Bill Austin
Dr. Nick Blackerby

Andrew Boyd
Craig Boyd

Mel Broughton
Bill Brown

Arthur Brownell
Billy Byrd

Frank Colonna
Jay Dall

Jerry Edmon
Dennis Edwards

Ken Eller
Dave Hawkins

Harris Huddle
Mike Kalet

John Knight
Dr. Bill Lambeth

Chuck Laughridge
Bob Lorenz

Bill Mendulak
Larry Mize

Edwin Newell
Bo Nowell

Ken Oppenheim
Bert Owens

Dale Patty
Alex Posay

Jeff Prince
John Rea

Chris Ritchey
Rob Spelfr

Matt Tynes
Warren Ward

Chris West
Rex Willis III

Donald Willis, Jr

Stephen Anmons
Executive Director

Cindy Davis
Office Administrator

The Coastal Conservation Association North Carolina has reviewed the proposed revision to the Shrimp Fisheries Management Plan. CCA NC is very concerned that the proposed Shrimp FMP does not meaningfully address high levels of bycatch in the otter trawl fishery in our sounds and estuaries. The discarded bycatch of juvenile finfish ranges from two to four times as much as the harvest of shrimp by weight. This translates into an unacceptable waste of immature croaker, spot, weakfish and southern flounder that are discarded dead. These species represent both commercially and recreationally important species to North Carolina fishermen. Two of these species are listed as depleted and two are listed as species of concern.

In addition to bycatch issues in the shrimp otter trawl fishery, this bottom disturbing gear has the potential to limit productivity of certain areas of our sounds and estuaries by increasing turbidity and reducing bottom structure. This could again limit the productivity of areas of our sounds.

CCA NC urges the NC DMF to pursue a full amendment process for the Shrimp FMP. This amendment should consider multiple gear types that might have less bycatch such as skimmer trawls, channel trawls or shrimp pots where appropriate. Limitation in the size of otter trawls could limit bycatch and reduce destruction of bottom habitat and structure. Other options could be to examine time and area closures to protect important juvenile species as well as potential improvements in Bycatch Reduction Devices (BRDs).

Finally, while the Shrimp FMP recognizes the problems of discarded bycatch, there are no objective, measurable reduction targets for otter trawl bycatch. If you do not have some idea of what success should look like, and you do not quantify it, you are unlikely to achieve it

CCA NC believes a full amendment to the Shrimp FMP is the only possible way to fully examine all these issues.

Dedicated to the Conservation of North Carolina's Marine Resources
4809 Hargrove Road, Suite 123 Raleigh, NC 27616
(919) 781-3474 (FISH) Fax (919) 781-3475 contact@ccanc.org
www.ccanc.org



**COASTAL FISHERIES
REFORM GROUP**
www.cfrgnc.blogspot.com

September 26, 2012

NC Division of Marine Fisheries
Attn: Nancy Fish
P.O. Box 769
Morehead City, NC 28557

Dear Ms. Fish,

The Coastal Fisheries Reform Group (CFRG) is a coalition of recreational coastal fishermen, who support sound management of our marine fisheries based upon the best available science. We represent many thousands of fishermen from across the state who fish in our coastal waters. We have had 122,533 visits to our blog site (<http://cfrgnc.blogspot.com/>) where we have discussed coastal fisheries issues since 2009. In the role as a voice for the average salt water fisherman, we submit the following comments on the proposed Shrimp FMP revision that the Marine Fisheries Commission will consider at their November meeting.

First and foremost, the by-catch of juvenile finfish taken in otter trawls used to harvest shrimp in North Carolina inshore waters is excessive and potentially harmful to the life cycles of some of the important finfish that are being killed and discarded. Recent studies by DMF personnel revealed alarming numbers of juvenile finfish in the by-catch of otter trawls with estimates in the range of a combined 300,000,000 young spot, croaker, and weakfish taken each year. In our opinion, this by-catch is excessive given the relative small annual harvest of shrimp (6 million pounds valued at about \$11,000,000.) Economic studies have shown the value of recreational fisheries to be many times greater than the commercial harvest. In the shrimp trawl fishery, you have the harvest of one commercial species (shrimp) cutting into the productivity of three species of fin fish (spot, croaker, and weakfish) whose recreational value is much greater than the product taken. This equation cannot be balanced in any way that you try to solve it.

While many options exist, some of which are described in the current Draft Shrimp FMP revision, to reduce the trawling by-catch without compromising the annual harvest of shrimp in North Carolina, the proposal recommends that none of them be implemented as management measures in the next five years. Instead, the recommendation is to adopt a status quo position with regard to by-catch. This "No Action" is unacceptable given the severity of the problem and the overwhelming evidence that otter trawling for shrimp is inherently destructive to the habitat and to a major portion of the finfish resource. We think the preferred management action should be to move trawls out of inshore waters altogether and as soon as possible due to the damage they do to the bottom, the sedimentation they cause, and the destruction of way too many juvenile finfish. Moving trawlers three miles offshore has been the solution in most Atlantic and Gulf States.

(continued)

The Shrimp FMP should be amended (not revised) to include goals, timetables, and management measures to accomplish significant by-catch reduction within the next five year period. We quote here from the proposed revision:

"As perhaps the prime example of the new policy positions, the re-authorized Magnuson-Stevens Fishery Conservation and Management Act (MSFCMA) contains a National Standard (#9) requiring bycatch minimization (USDOC 1996). National Standard 9 states: "Conservation and management measures shall, to the extent practicable, (A) minimize bycatch and (B) to the extent bycatch cannot be avoided, minimize the mortality of such bycatch." Additionally, in 1991 the MFC adopted a policy directing the DMF to establish the goal of reducing bycatch losses to the absolute minimum and to consciously incorporate that goal into all of its, management considerations (Murray et al. 1991)."

It is time to follow the national and state policies pointing to the importance of reducing by-catch. We can start with an amendment to the Shrimp FMP that does this in an effective way.

One additional factor that needs to be incorporated into the Shrimp FMP for the next five years is the continuation of the requirement that Turtle Excluding Devices be used in shrimp trawls. This requirement should be expanded to all types of trawls operating in waters where endangered and threatened sea turtles are found. In areas where, and times when, sea turtles are especially abundant, tow times for shrimp trawling should be reduced to a period that will prevent mortality of any sea turtle that may be engaged.

Thank you for the opportunity to comment on the Shrimp FMP. Please consider and share our points as you decide how to proceed in the important process of reviewing the Plan.

Sincerely,



Joe Alpea
Coastal Fisheries Reform Group



Bycatch photograph taken week of September 17, 2012 just outside New River Inlet, NC.



North Carolina
Wildlife Federation
Affiliated with the National Wildlife
Federation

2155 McClintock Rd.
St.
Charlotte, NC 28205

1024 Washington
St.
Raleigh, NC 27605

September 26, 2012

Louis Daniels, PhD
Director Division of Marine Fisheries
P.O. Box 769
Morehead City, NC 28557

Dear Dr. Daniel:

The North Carolina Wildlife Federation is a statewide nonprofit conservation organization created in 1945 and dedicated to the professional management of our fish and wildlife resources based upon the best available science. We represent many thousands of fishermen from across the state who fish in our coastal waters. In that role, we submit the following comments on the proposed Shrimp FMP revision that the Marine Fisheries Commission will consider at their November meeting.

First and foremost, the by-catch of juvenile finfish taken in otter trawls used to harvest shrimp in about one half of North Carolina inshore waters is excessive and potentially harmful to the life cycles of the important finfish taken and discarded as by-catch. Recent studies by DMF personnel reveal alarming numbers of juvenile finfish in the by-catch of otter trawls with estimates in the range of 300,000,000 young spot, croaker, and weakfish taken each year. In our opinion, this by-catch is excessive given the relative small harvest of shrimp (6 million pounds annually valued at about \$11,000,000.)

Many options exist to reduce the trawling by-catch without compromising the annual harvest of shrimp in North Carolina. Such management measures as time and area closures and restrictions, water depth restrictions for otter trawls, alternate gear and gear modification, limits on the size of trawls, and other measures, some of which are included in the proposal. We think the ultimate goal should be to move trawls out of inshore waters altogether due to the damage they do to the bottom, the sedimentation they cause, and the by-catch and discard of way too many juvenile finfish. Moving trawlers three miles offshore has been the solution in most Atlantic and Gulf States.

The Shrimp FMP should be amended (not revised) to include goals, timetables, and management measures to accomplish significant by-catch reduction within the next five year period. We quote here from the proposed revision:

"As perhaps the prime example of the new policy positions, the re-authorized Magnuson-Stevens Fishery Conservation and Management Act (MSFCMA) contains a National Standard (#9) requiring bycatch minimization (USDOC 1996). National Standard 9 states: "Conservation and management measures shall, to the extent practicable, (A) minimize bycatch and (B) to the extent bycatch cannot be avoided, minimize the mortality of such bycatch." Additionally, in 1991 the MFC adopted a policy directing the DMF to establish the goal of reducing bycatch losses to the absolute minimum and to consciously incorporate that goal into all of its, management considerations (Murray et al. 1991)."

It is time to follow the national and state policies pointing to the importance of reducing by-catch. We can start with an amendment to the Shrimp FMP that does this in an effective way.

We have no criticism of the remainder of the proposal developed by the DMF shrimp management team and presented for public comment. All three species of shrimp are being managed well based upon surveys and science and are in the "viable" category. Environmental and habitat protections that establish nursery areas and maintain water quality are paramount to the well being of shrimp.

One additional factor needs to be incorporated into the Shrimp FMP for the next five years, which is continuation of the requirement that Turtle Excluding Devices be used in shrimp trawls. This requirement should be expanded to all types of trawls operating at times and in waters where endangered and threatened sea turtles are found. In areas where and at times when sea turtles are especially abundant, tow times for shrimp trawling should be reduced to a period that will prevent mortality of sea turtle that may be engaged.

Thank you for the opportunity to comment on the Shrimp FMP. Please consider and share our points as you decide how to proceed in the important process of reviewing the Plan.

Sincerely,



Tim Gestwicki
Chief Executive Officer
North Carolina Wildlife Federation

From: Byrd, Johnny [<mailto:JByrd@precisionwalls.com>]
Sent: Monday, August 27, 2012 8:59 AM
To: bizzyb@coastalnet.com; Fish, Nancy
Subject: upcoming NCMFC discussions about shrimp harvest

Gentlemen and ladies,

It is my understanding that MFC is currently reviewing inshore (sounds and ICW) shrimp trawling.

Due to work and family constraints, I will not be able to attend the meetings but I deserve for my thoughts to be part of the overall picture.

Some of my earliest memories are of North Carolina saltwater fishing with my family on surf, pier and boat. I have personally experienced the wonderful saltwater fishing that we have had in the past and the heartbreak it has become in the past couple of decades. I am not a scientist but I have read reports from scientists about our waters and waters in other places and they ALL have extremely similar results, TREMENDOUS bycatch for otter trawls. I actually had the opportunity to go out on an otter trawler on three different occasions back in the mid 70's and my personal experience all three times were heartbreaking to say the least. Thousands, probably hundreds of thousands of baby spot, croaker and quarter sized flounder dumped dead back over the side for on those trips about 6 or 7 baskets of shrimp. This was in the New River on the north end of Topsail.

Years of this activity has GOT to be taking a tremendous toll on the health of these and other fish in our waters. We MUST take steps to curtail or even prohibit inshore otter trawling before we pass the point of no return for species much like river herring and weakfish may already be.

PLEASE PLEASE, I and others like me are begging for resource based management so that my 4 granddaughters and my future generations can at least partially experience the same pleasures I did as a child.

Thank you and may the good Lord guide you on this matter.

Johnny R. Byrd
Native North Carolinian

From: Eddie Eatmon [<mailto:beeatmon@gmail.com>]

Sent: Monday, August 27, 2012 3:52 PM

To: bizzyb@coastalnet.com; Fish, Nancy

Subject: Shrimp Trawl Meeting Comments

I am a commercial fisherman and a recreational fisherman. I am in full support of banning wasteful fishing practices and shrimp trawling is the most wasteful of them all. I have been on shrimp trawl boats and it seems like we are killing 10-20lbs of small fish and crabs for every pound of shrimp we get. We had one tow that I bet we threw back 500-1000 dead flounder from 3in-8in long. It's unbelievable that NC still allows this. I'm almost positive that we are one of the last states to allow this fishing practice inshore. What's crazy is that someone can get a \$150 fine for a 14.75in flounder that they plan to eat while a commercial shrimper might kill 10,000 flounder a night that will be pushed overboard dead. There are far more environmentally friendly ways to catch shrimp without these trawls. I've seen shrimp channel nets work in topsail beach that catch 99.9% shrimp with the few fish that it does catch can be thrown back alive. Or why don't we push shrimp farming to so that our natural shrimp can help feed the depeted fish populations in NC? Dragging chains and nets along the bottom and destorying our delicate estuaries in the process is far to wasteful and destructful to be legal.

-Bryce Eatmon

From: Tom Canady [<mailto:tomcanady@bellsouth.net>]

Sent: Tuesday, August 28, 2012 7:25 AM

To: Fish, Nancy; bizzyb@coastalnet.com

Cc: beeatmon@gmail.com; 'RCANADY'

Subject: North Carolina Fishery Resources

I am a concerned citizen and tax payer in Pender,Hyde,Bladen and New Hanover counties. I have spent my entire life on the coast in these communitites. I have never seen the Jolly Roger

Pier never produce a King Mackerel by the end of eight months of a calendar year! What is up with that? Beach renurishment? Commercial netting. I bought a season pass; I have only fished once due to the lack of fish!!! Trawling is destroying the fishery we have in the Pamlico Sound. I have seen it go to pot in the last several years. We have got to do something to back this off to give our fisheries a chance to survive. If we miss this opportunity, we want have to worry about the commercial fisherman losing their income. We will have to worry about how to sustain our general population that the esturine resource sustains in some form or fashion. I am sure my comments from this email will be to no avail. But I feel I have to make the effort. I am also sure the people I am sending it to are more aware of the issues than I and have the facts to back it up. But until politics and political greed do not make the decisions for our best interests, it will probably not change.

Thank you,

Tom Canady
Barker & Canady Custom Homes, Inc.
President
910-612-4442 (mobile)
910-509-2014 (office)
www.barkercanady.com
[Follow us on FACEBOOK!](#)



From: Brown, Charles (HNP) [<mailto:CharlesL.Brown@pgnmail.com>]
Sent: Tuesday, September 11, 2012 10:00 AM
To: Fish, Nancy
Subject: Shrimp Trawling Public Meeting

I regret that I will not be able to attend the meeting concerning the hearing in the Shrimp Trawling issue. This allowance of shrimp trawling has been destroying the fishing in North Carolina for years and I think it is time that the fishermen have their rights to eliminate this terrible practice. Not only should shrimp trawling be disallowed but all type of nets for fish should also be disallowed in the state of North Carolina. I would recommend that the NCDMF look at the Virginia fishing areas and see how the numbers of fish have recovered since they have eliminated shrimp trawling and fish nets. As many of us have had to look for a different job or profession, it is time for the shrimp trawlers to do so likewise. Please case my vote to completely eliminate all shrimp trawling and types of fish netting in the state of North Carolina.

Thanks, Charles Brown, NCW lifetime license #16292

Charles L. Brown
(w) 919-362-2184, (c) 919-812-5310
email: charles.brown2@duke-energy.com



From: Humphries, Scott M (GE Power & Water) [<mailto:scott.m.humphries@ge.com>]
Sent: Tuesday, September 11, 2012 10:10 AM
To: Fish, Nancy
Subject: Shrimp Trawling Mtg

You have my vote to discontinue using shrimp trawling or any netting in the inland waters. I've been a recreational fisherman for over 40 years and have witnessed the continuing decline of inshore fishing. Thank you

Scott

Scott Humphries
Manufacturing Project Manager
GE Hitachi Nuclear Energy

T 910-819-1011
M 910-616-7073
F 910-341-2618
D *292-1011

3901 Castle Hayne Rd
PO Box 780, M/C B-11
Wilmington, N.C. 28401

From: w kerner [<mailto:kernerw@suddenlink.net>]
Sent: Tuesday, September 11, 2012 4:18 PM
To: Fish, Nancy
Subject: comments on internal waters trawling

Good Afternoon,

Regarding trawling in internal waters we have a brief comment. We go out several times a year on Pamlico Sound and almost every time we have gone in the last couple of years (recreational fishing) we have caught **nothing!** We have very experienced fishermen in our little group of friends and we even used chum, etc... However, we regularly see the trawlers working in the area. Now, anyone with any common sense can figure out that if there are no fish in such an area- where the environment should be holding tons of fish; then it can mean only one thing. The commercial fisherman/ trawlers are catching everything in their path. We don't want to deny those people a living but we all have to adapt to changing industries and environments. Certainly the scientists can figure out a way that recreational fishermen (a.k.a. "taxpayers" too) can coexist and be happy. But right now it seems the trawlers are destroying recreational fishing in the Pamlico Sound area.

Thank you.
Walt Kerner

From: Bert Owens [<mailto:ocean@embarqmail.com>]
Sent: Tuesday, September 11, 2012 4:03 PM
To: Fish, Nancy
Subject: inshore trawling

Nancy: Like many, I have reviewed the finfish by catch associated with Shrimp trawling in our inshore waters. The numbers are alarming and to assume they are of no effect to these species would be a mistake and poor stewardship of our resources. Fortunately, all other states to our South all the way to Mexico also have trawling. It would be prudent to look at their actions,

including allowed gear, and learn what we could do here. A table of allowed gear, amount of gear and seasons etc. by state prepared by the DMF and distributed at the public meetings would be helpful. Whether I can make any of the meetings or not please add my voice to those calling for an **amendment** to the Shrimp FMP. Thank you.

Bert Owens
Crystal Coast **CCA**

From: Bob Fuller [<mailto:rhf.antares@gmail.com>]
Sent: Tuesday, September 11, 2012 7:27 PM
To: Fish, Nancy
Cc: Jim White
Subject: Shrimp trawling hearings

Ms. Fish:

With regard to the shrimp trawling meetings scheduled in the next few weeks, can you advise me what alternatives or options your department is proposing to solve this problem. Thank you very much for your courtesy and consideration.

Capain Bob Fuller

From: Mark Cable [<mailto:macable@uncg.edu>]
Sent: Tuesday, September 11, 2012 1:58 PM
To: Fish, Nancy
Subject: Ban Shrimp Trawling in Internal Waters in North Carolina !!!

Recent studies by the North Carolina Division of Marine Fisheries (NCDMF) showed that shrimp trawlers kill an estimated 500 million (half a billion!) small fish every year. Most of this "bycatch" consists of weakfish, croaker, and spot, and these finger-sized fish are destroyed before they reach breeding age, guaranteeing that the fish populations in our sounds cannot recover. I would ask that North Carolina follow the example of every other state on the east coast and "**Ban Shrimp Trawling in Internal Waters**" and help to keep our fish stocks at sustainable levels.

--

Mark Cable
Facilities Operations
University of North Carolina at Greensboro

From: HreStore1@aol.com [<mailto:HreStore1@aol.com>]
Sent: Tuesday, September 11, 2012 1:21 PM
To: Fish, Nancy
Subject: Shrimp

Dear Ms. Fish:

I agree with the following and therefore request an end to this process:

North Carolina is the last state on the Atlantic Coast to allow commercial shrimp trawling in internal waters. As other states banned this terribly destructive practice, their trawlers came to our sounds.

Recent studies by the North Carolina Division of Marine Fisheries (NCDMF) showed that shrimp trawlers kill an estimated 500 million (half a billion!) small fish every year. Most of this "bycatch" consists of weakfish, croaker, and spot, and these finger-sized fish are destroyed before they reach breeding age, guaranteeing that the fish populations in our sounds cannot recover.

Jay Shoffner

From: Scott Gould [<mailto:sgould@capefearperio.com>]
Sent: Tuesday, September 11, 2012 12:11 PM
To: Fish, Nancy
Subject: shrimp trawling

To whom it may concern,

I want to start by saying that I'm not against commercial fishing. But, I've hoped for a long time that this destructive practice might come to an end in north Carolina inland waters. Before I moved to the coast and actually saw the effects of inshore trawling, this issue had little effect on me. Then, I started spending a lot of time on the water in July and August in the Pamlico sound. I would repeatedly see 25 – 50 boats scavenging the sound floor, running back and forth across the sound. We would ride for miles and see thousands of dead fish (spot, gray and speckled trout, redfish, and croakers) floating on the surface that were discarded as by-catch, not to mention the seabed destruction which is supposed to naturally clean our waters (oysters, grass, etc). I thought to myself, there has to be a better way. I'm not against commercial fishing at all, but this type of practice is destructive and results in wanton waste of resources that are supposed to be shared by all North Carolinians. I would like to voice my opposition to allowing continued inshore trawling of any kind in North Carolina, but I am not against trawling in the ocean waters. Can we really ignore that all of the other Atlantic States have already agreed to ban shrimp trawling inshore? Sometimes, it's embarrassing to be from NC with the way that we treat our coastal resources. Please help make this long overdue change effective. I appreciate your consideration. Sincerely, Scott Gould

M. Scott Gould
7010 Market Street
Wilmington, NC 28411

From: ncparrott@gmail.com [<mailto:ncparrott@gmail.com>]
Sent: Tuesday, September 11, 2012 10:53 AM
To: Fish, Nancy
Cc: Bert
Subject: Shrimp trawling

Nancy----i believe that inshore shrimp trawling is having a negative impact on several finfish species. I would suggest that this practice be eliminated if possible ---bycatch figures from your own scientists have shown how. Destructive this method of shrimp trawling really is..... Best regards, hubert parrott Sent from my U.S. Cellular BlackBerry® smartphone

From: Neil Smith [<mailto:neilmlynn@skybest.com>]
Sent: Wednesday, September 12, 2012 8:05 AM

To: Fish, Nancy
Subject: inshore trawling

Dear Ms. Fish

It is not hard to see that inshore trawling should be banned in N.C.'s waters. We are the only state on the eastern seaboard who still allows this destructive practice, and scientific studies show that this practice and gill-netting contribute to a fish mortality rate in young fish that prevents our fish stocks from ever recovering to a sustainable point. Recreational fishing certainly brings more revenue to NC than all the commercial fishing put together, considering that many of the commercial fishermen are not even native North Carolinians, and are sending their money out of state. This is an issue that is a hot topic on any NC fishing pier, and it has been recognized for years that something needs to be done. Please give this matter your full attention. BAN GILL NETTING IN NC.

THANKYOU

Neil M. Smith
Scottville, NC

From: Ann Wisz [<mailto:kawisz@bellsouth.net>]
Sent: Wednesday, September 12, 2012 1:58 PM
To: Fish, Nancy
Subject: Commercial Shrimp Trawling

Please consider our comments at the upcoming public hearings regarding commercial shrimp trawling, as we are unable to attend. We must not lose this opportunity to stop commercial shrimp trawling. It is destroying many small fish every year, including spot, croaker and others, before they can reproduce and increase their numbers. These fish are vital to the anglers and tourism numbers in NC. Let us join the ranks of states on the Atlantic Coast which have stopped this practice which is so harmful to our fisheries.

Thank you very much.

Ken & Ann Wisz
1645 Kings Landing Road
Hampstead, NC 28443

From: Harry Archer III [<mailto:harcher3@gmail.com>]
Sent: Wednesday, September 12, 2012 2:13 PM
To: Fish, Nancy
Subject: Shrimp Trawling

Ms. Fish,

I cannot attend the public hearing on 9/19 in Wilmington. I would like to state that I am opposed to any and all trawling for any species in all internal waters, including the Pamlico and Albemarle Sounds. As someone who used to work in the shrimping business in Morehead City, I have seen the destruction trawlers reap on juvenile fish.

I support the banning of all netting, including trawls and gill nets, in our internal waters.

When you travel to other states like Fla, Ga, Texas, LA and SC (to spend money to fish), their sounds and rivers are cleaner and the fishing is light years better than we have in NC. It is very sad for NC natives who love our coastal sound waters.

Thanks, Harry Archer

Harry Archer III
910-791-7880 Office
910-470-7974 Cell



From: Gardner Reynolds [<mailto:info@bartoncreekcreative.com>]
Sent: Wednesday, September 12, 2012 1:54 PM
To: Fish, Nancy
Subject: shrimp and southern flounder management plans

Nancy,

I highly oppose shrimpers killing the fish that they do and would vote to have major restrictions on shrimping and get the guys into fish guiding like other states like Texas and Louisiana. They make more money and it makes sense for our fishery.

I can't even catch a nice flounder anymore.

BORN AND RAISED in NC.

Gardner Reynolds
Owner & Marketing Director
Barton Creek Creative, LLC

919.844-9492 Raleigh Office
919.749.3177 Mobile

[.info@bartoncreekcreative.com](mailto:info@bartoncreekcreative.com)
www.bartoncreekcreative.com

From: Howie Hink [<mailto:howiehink@gmail.com>]

Sent: Wednesday, September 12, 2012 9:24 PM

To: Fish, Nancy

Subject: Shrimp Trawling

Thank you for taking time to look at my opinion. I own a trawl and one year, I used it. Got very disgusted with the by catch and the grass that was torn up from the bottom. Got very few shrimp. Please move the trawls out into the ocean where they will catch bigger shrimp and not baby flounders, trout, croakers etc. Thank you.

Howard Hink

PS Threw the doors away and kept the net for decoration. Never again.

From: Sheryl and Walton Joyner [<mailto:wjoyner262@aol.com>]
Sent: Wednesday, September 12, 2012 6:05 PM
To: Fish, Nancy
Subject: Inshore shrimp trawling

I will not be able to attend the upcoming hearing, but I wanted to at least have a say in the debate. I have lived and fished in NC all my life. I have seen the devastation that inshore "otter" trawls create first hand as a fisherman and a past recreational shrimper. It appalled me 40 yrs. ago and it stuns me that in this day and age that it continues. Bottom trawling is destructive and efficiently destroys nearly everything in its path. It rips up grassbeds, dislodges shellfish and crabs, and kills juvenile finfish by the 1000's at a time. Inshore botom trawling is no different than clear cutting a forest over and over again....except that it is nearly invisible to those not around or "in the know". I don't want the shrimping industry in NC to be shut down by any means, but I think that the time is long overdue for elimination of that part the industry that has been destroying statewide resources for the benefit of only a few.

Walton Joyner
Raleigh

From: Richard J Sessoms [<mailto:sessomsr@centurylink.net>]
Sent: Wednesday, September 12, 2012 5:42 PM
To: Fish, Nancy
Subject:

I rode in a shrimp boat once.after about about three pulls I asked to be taken back to the dock.The "bycatch" of immature fish was more than I could Watch. There we many species of fish that were just raked overboard. None of these fish were living. We need to take the shrimp trawls out of the inland waterway and other nursery areas and let the fish population have a chance to replenish itself. Everyone who goes to the coast fishing is aware of this situation and would like to see it stopped. we have too many politicians who depend on the commercial fishermans vote making the decisions about what is happenoing in our inland waters.Our neighbors to the north and south have have made the necessary changes to their trawling laws. It's time we did likewise.

Richard J. Sessoms

Magnolia NC 28458

Cell # 910 284 1900

From: lwf0831@suddenlink.net [<mailto:lwf0831@suddenlink.net>]

Sent: Wednesday, September 12, 2012 4:57 PM

To: Fish, Nancy

Subject: ShrimpTrawls

I grew up in Hyde county and have seen first hand what shrimp trawls do to our fisheries. We should not sacrifice flounder ,trout, and other species of fin fish for the sake of shrimp harvest in our inland

waters. I recommend that we abolish shrimp trawling in inland waters
Sinderely, Lonnie Foreman

From: Woodard [<mailto:woodard@esn.net>]
Sent: Thursday, September 13, 2012 2:11 PM
To: Fish, Nancy
Subject: trawls

I am very much against fish trawls in inland waters (rivers & sounds} I saw this first hand today in white oak river. Shrimp trawls were trawling river channel 24 hrs straight mudding up water and wiping out every thing as they went. This waste has got to stop Woodard Jackson 919 658 5565 woodard@esn.net former advisory member

From: Sandlin Gaudette [<mailto:sandlingaudette@yahoo.com>]

Sent: Thursday, September 13, 2012 11:02 AM

To: Fish, Nancy

Subject: NC Shrimp Trawling

Ms. Fish,

Please help stop the shrimp trawling in North Carolina. I love shrimp but not at the expense of our environment. We have to change our "backwards" ways in this state and this is one way to do just that.

My family and I have lived in North Carolina for many many generations and we want to leave our children with the rich resources this state has to offer for many more generations to come.

Kindest Regards,

Sandlin A. Hunter

4516 Touchstone Forest Rd.

Raleigh, NC 27612

919.427.0191

From: E T Weaver [<mailto:deereman@skybest.com>]
Sent: Thursday, September 13, 2012 9:31 AM
To: Fish, Nancy
Subject: Shrimp Trawling Comment

Ms. Fish,

N.C. Marine Fisheries needs to put a stop to shrimp trawling in internal waters until (if ever) a way is found to reduce destruction of other species (bycatch). The economic value of our marine resources for

recreational use must be acknowledged. Inside waters are the key to North Carolina's reputation for "the place to go". We need to show everyone that NC intends to protect and make best use of our resources.

Thank you, E.T. Weaver Jefferson, NC

From: groberson@ec.rr.com [<mailto:groberson@ec.rr.com>]

Sent: Thursday, September 13, 2012 7:53 AM

To: Fish, Nancy

Subject: shrimp trawling

Please use the power of your office to stop this trawling in internal waters; even the NCDMF says this is harmful. I am a 67yr old rec fisherman around Morehead City and know some of the small time shrimpers that will be hurt in the pocketbook if not put out of business but we need to protect the environment. Thanks in advance for any assistance, Gary Roberson.

From: Vernon Hunter [<mailto:vhunter@copycei.com>]

Sent: Thursday, September 13, 2012 4:13 PM

To: Fish, Nancy

Subject: Shrimp Trawling

Dear Ms Fish,

I own property in Beaufort and Hyde County and grew up spending summers as a child at my parent's cottage at Emerald Isle. I love shrimp. But the price we are paying for inshore trawling is just too much. I have commercial fished for a living in Alaska and NC have seen clean fisheries. This is not one of them.

This fishery is destroying our inshore fishery in NC. The millions of pounds of bycatch including immature croaker, grey trout, speckled trout, red drum, turtles, black drum, flounder and untold baitfish (menhaden, pinfish, spot, etc) is not worth any price for shrimp.

This fishery also destroys the filter feeders that clean the water - oysters, hard bottom areas, crabs, and the ecosystem on the sound bottom. It is a matter of time before this fishery is banished inshore. If the public really had any idea of the wanton waste of this fishery the outcry would be deafening. I would really like my daughter to see a glimmer of what the fishery in the Pamlico Sound used to be, can be. Please help this happen.

Sincerely,
-R Vernon Hunter
1925 Sunset Drive
Raleigh, NC 27608
AND
5510 Sidney Road
Belhaven, NC 27810

From: dbuck16@embarqmail.com [<mailto:dbuck16@embarqmail.com>]

Sent: Saturday, September 15, 2012 7:55 AM

To: Fish, Nancy

Subject: Shrimping laws

I am 64 and have fished our coastal waters extensively. I have been on shallow water shrimp trawlers and the by catch is sickening! This is an obvious destructive practice. I can't believe it has been allowed to continue. Thank you.

Sent from my U.S. Cellular BlackBerry® smartphone

From: Wille Zee [<mailto:ddcarver123@yahoo.com>]

Sent: Sunday, September 16, 2012 7:05 AM

To: Fish, Nancy

Subject: trawlers

we the people of nc would love to see the trawlers move out and leave the beaches clean. We need to educate them they need to learn fish farming. If we don't do this now we will end up like other places that have dead zones (no fish). I've seen them dump out dead fish for miles just to have a few shrimp. It makes me sick. There is only a few people still doing it also trawlers come from other places just because we are so relaxed about laws concerning them. WE NEED TO STOP ESP> THE STOP NETS AND LIMIT OTHER NETS ALSO!!!!!! protect and preserve our fish and coast.

From: Billy Reavis [<mailto:bjreavis@gmail.com>]

Sent: Sunday, September 16, 2012 9:27 PM

To: Fish, Nancy

Subject: shrimp trawling

I've been fishing in the area of Core Sound for too many years to tell. But you can be assured that I have seen the effects of shrimp trawling. This practice should have been stopped many years ago it will take to recover. There is years so much by kill. Also if nothing is done about the practice of long haul, which is killing many juvenile fish. The sound should be considered a nursery area.

From: bensdaddy@suddenlink.net [<mailto:bensdaddy@suddenlink.net>]

Sent: Monday, September 17, 2012 8:00 PM

To: Fish, Nancy

Subject: Public Comment Sought on Shrimp Trawling and Bycatch

Dear Ms. Fish,

I am pleased to see that North Carolina Marine Fisheries Commission is looking into the damage that shrimp trawling does to fish species when

done in internal waters. I am opposed to this practice by commercial fishermen and hope that the NCMFC can come up with a plan to eliminate it.

I grew up in Southwest Florida and experienced first hand what damage unrestrained netting in internal waters can do to internal waters. I can remember the days when it was considered a waste of time to fish in Tampa Bay or Sarasota Bay back in the 70's. Now that I live in North Carolina, many people now tell me that it is a waste of my time to fish in Bogue Sound and that I would be much better off planning fishing trips to Virginia.

When Florida eliminated the commercial netting in its internal waters, the recreational fishing is outstanding. I hope that the NCMFC will see that shrimp trawling in these areas is devastating the fish populations and will restrict or eliminate this practice within a mile of shore.

Again, I thank the NCMFC for looking into this and hope they have the courage and the sense of duty to our state to make the right choice.

Sincerely,

Brack Craven

Greenville, NC

From: BC [<mailto:bcraver4@triad.rr.com>]
Sent: Monday, September 17, 2012 11:28 AM
To: Fish, Nancy
Cc: bC
Subject: ?

Nancy,

I wish that trawlers stripping our coast line of fish would be forced to further out off our coast line. I do not live there but have visited our coast a few times a year for years to fish . I find fewer fish every year . Would your please try to find more balance between tourism and commercial fishers so we could enjoy a few self caught fish for ourselves. Thanks Bud C.

From: Bruce [<mailto:bdmmjm@charter.net>]
Sent: Tuesday, September 18, 2012 10:48 AM
To: Fish, Nancy
Subject: Shrimp Trawling

Dear Ms. Fish:

I am writing to you to make a comment on the current Shrimp Fishery in North Carolina. While I believe that shrimping is a significant part of our North Carolina Commercial Fishery, the current method of the use of Otter Trawls is one of the most devastating to our environment and to the current and future health of our overall fisheries. Each year hundreds of millions of fingerling sized fish are wiped out and the trawls continue to destroy the bottom structure. Submerged aquatic vegetation never has a chance to recover as the bottom is continuously scraped. There

are other methods of shrimping that allow netting without scraping the bottom where many of the fingerling fish reside and our aquatic vegetation grows. I would recommend we eliminate Otter Trawls completely and set up areas of our sound where shrimping is not allowed until the vegetation is healthy again. Please take the necessary action to protect the future of the precious fisheries resource in North Carolina.

Sincerely

Bruce D. Matthews

Manteo, NC

Sent: Tuesday, September 18, 2012 5:36 PM

To: Fish, Nancy

Subject: Against shrimp net trawling

Dear Ms Fish,

I am a resident of North Carolina (Troy, N.C.) and a recreational saltwater fisherman. Please vote to stop the destructive practice of shrimp net trawling in our NC waters. The juvenile fish by-catch that is wasted by the shrimp trawlers costs the State far more economic dollars than the few pounds of shrimp that are caught and sold. Please help our State and vote "No" to shrimp net trawling.

Sincerely,

Richard Capel (Troy, NC)

From: Mark Cable [<mailto:macable@uncg.edu>]

Sent: Wednesday, September 19, 2012 11:04 AM

To: Fish, Nancy

Subject: Reopen and Amend the "Shrimp Management Plan" !!!

In the latest studies by the DMF, the by catch ratio was typical (approximately 4:1) and indicates that an estimated 24 million pounds of finfish by catch has occurred annually for the last five years. The study, which is considered valid and solid by DMF scientists, also determined that the finfish killed in the trawlers were small, averaging around 20 fish per pound. Multiplying 20 fish per pound by 24 million pounds allows us to get a rough estimate of 480 million juvenile finfish that are killed annually by trawlers operating in North Carolina waters.

I am asking the MFC to reopen and **amend** the Shrimp FMP to better address the issue of by catch by shrimp trawlers operating in our in shore waters.

--

Mark Cable

Facilities Operations

University of North Carolina at Greensboro

From: Eb Pesci [<mailto:ebpesci@gmail.com>]

Sent: Wednesday, September 19, 2012 9:23 PM

To: Fish, Nancy

Subject: Amendment of the shrimp FMP

Dear Ms. Fish, Please forward this message to the members of the Marine Fisheries Commission. Thank you.

Dear Marine Fisheries Commission Members,

I am writing this letter to ask the MFC to reopen and amend the shrimp FMP. Studies by the NCDMF have clearly shown that shrimp trawl bycatch has averaged approximately 25 million pounds per year for the last five years. This equates to hundreds of millions of small finfish that are wasted before ever reaching maturity. The NCDMF studies have also shown that most of this bycatch consists of croaker and spot. In addition, there is also a large number of weakfish, a depleted species, included in this waste. It is time for this waste to stop. I am asking for an amendment to the shrimp FMP and I'm also asking for shrimp trawling inside of the ocean to be ceased immediately. Most other states and many countries have stopped or severely restricted inshore trawling but we continue to allow our fish nurseries to be raided. Others have reaped a huge bounty by removing trawlers (an 8 fold increase in biomass was seen in an Italian trawl ban area) yet we continue to have only the memories of sounds full of plentiful fish. Those days are gone, and there is no doubt that inshore shrimp trawling holds part of the blame.

It's time to start working for the resource and provide our marine environment with an opportunity to rebuild what was once a world class fishery. Please end inshore trawling immediately.

Thank you,

Eb Pesci
Greenville, NC

From: Richard Fulton [<mailto:rfulton1955@embarqmail.com>]
Sent: Wednesday, September 19, 2012 8:41 PM
To: Fish, Nancy
Cc: Tim Hergenrader
Subject: Shrimp FMP

Please reopen and **amend** the Shrimp FMP. The waste here is deplorable. It is time we changed our ways so that future generations can enjoy OUR resources.

Thank you,

Richard C. Fulton
101 Birch Rd
Hubert, NC

From: Russell Long [<mailto:fishingruss@gmail.com>]
Sent: Wednesday, September 19, 2012 3:15 PM
To: Fish, Nancy
Subject: shrimp trawling in our state waters

This wasteful practice has to stop. I went shrimping once and I was appalled by the by catch. This is not a tolerable means of gathering seafood anymore. Things have to change in NC. I would rather buy imported shrimp than local because I know how destructive our practice is.

Russell Long PO Box 1954 Kill Devil Hills, NC 27948

From: Will Brown [mailto:w_h_brown@yahoo.com]
Sent: Wednesday, September 19, 2012 2:43 PM

To: Fish, Nancy
Subject: shrimp trawling and bycatch

Dear Ms. Fish,

I am writing you about the current discussions of bycatch in the shrimp trawling industry. I know that NC is the only state on the east coast to allow trawling in internal waters. I believe that all internal (non-ocean) waters should be closed to trawling because this method of fishing is too devastating to the environment. It destroys countless numbers of juvenile trout, croaker, and spot, and forever changes the contours of the bottom, removing vegetation and flattening ridges. In the 1970's and very early 1980's my family used to catch quality gray trout in the Pamlico sound, but for the last 30 years, the fish have been difficult to find and small. Current recreational regulations are severely restrictive, but even these cannot allow the species to rebound with the current shrimp trawling industry wreaking havoc on this species' population. Shrimp trawling in internal waters should be banned! the shrimping industry will still have productive waters to fish, the ocean! Our sounds and estuaries are too important to all of NC's fish species. Thank you,

Will Brown
8813 New Forest Dr
Wilmington NC 28411
910-540-0332

From: Betts Tackle LTD [<mailto:bettstackle@bettstackle.net>]
Sent: Wednesday, September 19, 2012 2:02 PM
To: Fish, Nancy
Subject: Inland Shrimping

Marine Fisheries Commission

- I know you have correct information
- I know you have received this information again and again by hundreds of concerned people.
- You know N.C. is the only state that allows shrimping in the internal waters

I ask you to rise above politics and personal interest. I believe if you really care about the Marine Resources of North Carolina, you will stop this inland practice of shrimping.

Don Betts
Betts Tackle Ltd.
1701 West Academy St.
Fuquay Varina, NC 27526
Phone 919-552-2226
Fax 919-552-3423
bettstackle@bettstackle.net

From: Joe Lail [<mailto:lumberped@charter.net>]
Sent: Wednesday, September 19, 2012 1:22 PM
To: Fish, Nancy
Subject: Inshore trawling.

As a recreational fisherman of 30 years , it has become abundantly clear , that year over year our fish stocks have been depleted. Just a brief glimpse at the figures posted by the NCDENR

in it's Marine Recreational Finfish Harvest report shows astronomical declines between the years of 1989 to 2010.

One particular example would be the reported catch of "Spot". The reported catch of this fish in 1999 was down 220% from the total reported in 1989. To go further , one just has to look at the catch reported in 2010 which was down 159% from the total reported in 1999. Total decline of the reported catch over this 20 year period amount to 2,089,739 fish.

While 2 million may seem like a small number , this is just one species that represents a huge cross section of the finfish decline, and these are only recreationally reported numbers. I chose the spot as a good example of a finfish that migrates to inland waters to mature. This is important, as the Spot is a staple in the diet of many other larger inshore fish that will in turn range into pelagic waters and become part of the diet for many pelagic specie. Thus , the decline of the "Spot" can immediately have an impact on the mortality rate of much larger and economically important specie. The "Spot " is only one example of the drastic decline of finfishes. Another example and perhaps ecologically, and economically more significant would be the "Atlantic Menhaden". Menhaden stocks are at a tipping point of un-sustainability up and down the eastern seaboard. This has occurred largely due to commercial overfishing of adult populations. However , the problem can only be compounded exponentially by reducing their numbers when taking them from their nursery grounds as juveniles. This happens predominantly as by-catch , but the "Menhaden" is a very delicate specie that has a very high morbidity rate when handled in any manner. There are countless other specie , even outside of finfish that are impacted by inshore trawling that have an astounding impact on the long term health of our marine eco-system.

By curtailing or altogether banning the trawling of inshore waters we begin to re-stabilize the nursery environment for countless numbers of species , thus ensuring a brighter economic future for all fisheries. While the immediate economic impact for this may be sharp for many , by adapting , we can ensure a more long term and sustainable economy for all of us that earn a living or just plain enjoy fishing our coastal waters. Understanding the plight of our commercial shrimpers in this situation is paramount. Many of our shrimpers are family businesses that have existed for decades off of the sea , and we cannot arbitrarily just throw them to the wind. But, with that being said ; all business environments change , and business models must change to adapt or cease to exist. A business is no different than a specie in the wild , when tampered with or manipulated in any way it will either adapt to it's environment , or decline and perish. The advantage that our shrimpers have , that wild creatures do not , is the ability to think long term and plan for a change that is coming , and that is exactly what will get them thru this potential change.

Economic planning is essential when considering changing business models. By looking at traditionally accepted supply and demand principles, we can help North Carolina shrimpers prepare for the future.

Currently , shrimpers are facing extreme pressure from imported, low priced and inferior shrimp. To make this transition , shrimpers may have to look several business cycles into the future.

By removing a portion of North Carolina's shrimp from the market , the supply side will be somewhat shortened , and perhaps raise the prices proportionally.

This could have a two pronged effect:

Foreign suppliers may increase their shipments to take advantage of this , but this could also make the "offshore" taken shrimp more profitable (higher margins) for the local fishermen. This could help give the local fishermen an influx of cash to help them thru the transitional period. A longer term effect could be that foreign shrimp may eventually flood the market when trying to

take advantage of the higher margins. When the market becomes flooded , prices will plummet and the margins will decrease making the market less attractive to importers. Eventually forcing importers out entirely , making them opt to sell their goods in their local market with lower over head costs. As this happens it would give our local fishermen a chance to take advantage of this and fill the gap in supply with profitable shrimp taken from our local “offshore” waters. Optimally , by this time the local fishermen will have figured out alternative means to bridge the gap in seasonal fluctuation of prices by supplying different products to market , without flooding any one item in particular. This would allow for a profitable business model , and yet preserve our fisheries for the decades to come.

Any way we look at it , our current path is not sustainable , a change must be made and made sooner rather than later. For each season that passes the problem is only compounded and will eventually result in a situation where the shrimper may have no product to catch , making their demise inevitable. In any of life’s endeavors there is a price to pay. The choice is clear here ; continue to “play” now and pay the balloon payment at the end , or pay a small price immediately for the ability to continue to “play” indefinitely.

Thank You For Your Time

Joe Lail
Concerned Angler

From: James Coleman [<mailto:colemanj56@hotmail.com>]
Sent: Thursday, September 20, 2012 9:51 AM
To: Fish, Nancy; bill.cook@ncleg.net; marian.mclawhorn@ncleg.net; edith.warren@ncleg.net; The Honorable Clark Jenkins; louis.pate@ncleg.net
Subject:

Date: September 20, 2012
To: Ms. Nancy Fish, NCDMF/NCDENR
From: James Coleman, Greenville, NC colemanj56@hotmail.com
Re: Shrimp Trawling

I am writing to request that policies be enacted as soon as possible to prohibit inshore shrimp trawling activities in the North Carolina inshore waters. The irrefutable facts are that trawling activities in our waters directly lead to the killing massive numbers of vital species of feed- and game-fish at the fingerling stage. Decimation of these populations not only affects fish populations in our waters, but populations along the entire Eastern seaboard, because of the major role the vast estuary systems of North Carolina play as breeding and nursing areas for Atlantic Ocean fish species. Executive and legislative boards in other states controlling similar bodies of water such as Delaware River and Bay and Chesapeake Bay and its tributaries have taken seriously their responsibilities as stewards of our natural resources and have wisely restricted certain practices in these bodies of water. It is time now for North Carolina policy-makers to study the FACTS and ignore the anecdotal “old fisherman” myths and make a forward-thinking decision which can do nothing but help the future of the fishing and shell fishing industries – both commercial and recreational – in North Carolina.

PLEASE – amend the Shrimp FMP now!

Thank you.

From: Maxwell, Galen S Civ USAF ACC 4 FSS/FSMM [<mailto:galen.maxwell@seymourjohnson.af.mil>]
Sent: Thursday, September 20, 2012 1:44 PM
To: Fish, Nancy
Subject: Public Comment Sought on Shrimp Trawling and Bycatch

Ms Fish;

Since I cannot travel to one of the public meetings I would like to offer my input via email:

North Carolina is the last state on the Atlantic Coast to allow extensive commercial shrimp trawling in internal waters. Recent studies by the North Carolina Division of Marine Fisheries (NCDMF) indicate that shrimp trawlers destroy small fish every year and by-catch needs to be reduced. A significant portion of this "by-catch" consists of weakfish, croaker, and spot (recreational pan fish). These finger-sized fish are destroyed before they reach breeding age, and as a recreational salt water fishing advocate, this remains my concern. I would like to see the N.C. Marine Fisheries Commission switch from a revision to an amendment process, so that the proposal to ban inshore commercial trawling altogether in NC waters can at least be debated.

Thank you.

V/r,
Galen S. Maxwell
Goldsboro NC
Member, CCANC

From: Greg Hefner [<mailto:gahefner@hotmail.com>]
Sent: Thursday, September 20, 2012 2:37 PM
To: Fish, Nancy; Tim Hergenrader
Subject: Excessive by catch of juvenile finfish in otter trawls used to harvest shrimp

Nancy,

I am emailing you to ensure my comments will be added to the public record concerning the by catch of juvenile finfish in otter trawls used to harvest shrimp.

I strongly urge the MFC to **reopen and amend** the Shrimp FMP! I understand that the DMF is only recommending a revision of the current Shrimp FMP. When is this state going to wake up and realize that we are wiping out our natural resources by allowing this to continue? Why has all the other South Eastern states amended or completely stopped in shore netting of all kinds? Why does North Carolina think they are so different?

It is very easy for any citizen who follows these matters to see and understand that our policies are driven by money and greed, not by science and evidence! It makes me shameful to call myself a North Carolinian when these practices continue to contribute to the few instead of the greater good for all, and most importantly our declining natural resources!

I am an avid recreational fisherman that has fished these waters for over 25 years. When I go out for a day of rod and reel fishing and struggle to catch a single fish in our inshore waters, there is a major problem occurring! I am by no means an expert, just your average everyday guy that enjoys time out on the water fishing with friends and family. But, it gets very frustrating when you have more no catch days than days of catching. Especially when a day on the water usually costs me well over 200 dollars when you add it all up, gas, tackle, bait, and food. Fifteen, even ten years ago this was unheard of. To go out

in these waters, this huge **NURSERY** area of ours, and not catch fish means there are huge problems brewing. I could go on and on, but I think I have made my point and I'll leave it at that!

Once again, I strongly urge the MFC to reopen and amend the Shrimp FMP!

Thank you for your time,

Greg Hefner
Retired Marine
Sneads Ferry, NC

Courage is endurance for one moment more...

From: tthompson19 [<mailto:tthompson19@ctc.net>]

Sent: Thursday, September 20, 2012 4:10 PM

To: Fish, Nancy

Subject: Trawlers

Its been said over and over....but ill say it again....The amount of money the recreational fishermen put into, a Wide array of the economy, BY FAR, outweighs what the commercial fishermen do for our economy! Not to mention the commercial fishermen depleting a WIDE array of fish species!. There is NOT anywhere near "good" versus bad that the commercial fishermen are doing! Get the politics out of the equation! Let common sense be the deciding factor! Its for all good reasons all other atlantic coast states have stopped inshore trawlers. Lets get er done before its too late! Please! Skip the gay marriage issues and get to something important to us all! Our Economy! Our future! Our fish! TimmyT

From: Ted Mayer [<mailto:tedmdds@nc.rr.com>]

Sent: Thursday, September 20, 2012 8:29 PM

To: Fish, Nancy

Subject: Public comments against shrimp trawling in internal waters

Please include my comments on the topic of shrimp trawling. North Carolina is the last state on the Atlantic Coast to allow commercial shrimp trawling in internal waters.

Recent studies by the North Carolina Division of Marine Fisheries (NCDMF) showed that shrimp trawlers kill an estimated 500 million (half a billion!) small fish every year. Most of this "by catch" consists of weakfish, croaker, and spot, and these finger-sized fish are destroyed before they reach breeding age, guaranteeing that the fish populations in our sounds cannot recover.

Concerning the issue of excessive by catch of juvenile finfish in otter trawls used to harvest shrimp at the upcoming meeting I request the MFC to reopen and **amend** the Shrimp FMP. The Division of Marine Fisheries (DMF) is recommending that the Shrimp FMP only be revised and this revision is not adequate. If the Shrimp FMP is merely revised and not amended, then we will be stuck with no meaningful change to the use of otter trawls for five more years.

As a recreational fishermen, a citizen of Craven County, a healthcare professional and a member of the NC Commission for Public Health I have a concern for our marine environment who would like to see our fisheries improve.

Regards,

Theodore F. Mayer
4008 Marina Townes
New Bern, NC 28560

tedmdds@nc.rr.com

From: Bill Gibson [<mailto:wgibsonlg@nc.rr.com>]
Sent: Saturday, September 22, 2012 1:23 PM
To: Fish, Nancy
Subject: Shrimp MFP

To not open the shrimp MFP for discussion/debate/review is irresponsible in light of the abosultely hugh numbers of small finfish destroyed as bycatch. No matter the fish, it is part of the food chain. Decimate the small end of the food chain and there is less food for larger fish. The larger fish either do not flourish or they move elsewhere. Decimate the small finfish, some of which grow to larger gamefish, and there are fewer gamefish. It is very simple. One does not need to have a Phd to see and understand. MFC is responsible for the health of our fisheries and to watch the decline and do nothing to one significant factor perpetuating the decline is reprehensible.

WH Gibson
NC Native

From: John Rakoci [<mailto:john@rakoci.com>]
Sent: Sunday, September 23, 2012 8:40 AM
To: Fish, Nancy
Subject: Comment

Hard to believe the only state that still permits this is asking for comments. First, I only buy local caught sea food. I used to be a charter boat captain on Lake Erie. The commercial people do toss the bycatch back into the ocean and ICW. No reason as nearly all of it is dead or will die. If commercial fisherman are professionals they should be offshore a minimum of 3 miles. This is important not only for the long term survival of the entire fishery but for safety reasons too. A strong commercial fishery is important to NC and those that make their living fishing and in related industry.

What is mostly seen inshore are those with minimal investment in boats and equipment. Last Thursday there were three shrimpers between the Ocean Isle Beach bridge and Sunset Beach bridge. That area of the ICW is narrow and there are quite a few boaters on the water still.

Commercial gigging- that is a sad practice!

Within 2 miles on that same day, there were 3 gill netters. Another very sad practice for all but the gulls and pelicans that feast on that dead bycatch. I live on the coast. The strength of the commercial lobby is well known. The influence of the coastal legislators is also strong. Expecting change is not very promising. There must be a rec/comm compromise or both will lose. If the animal rights activists and anti-fishing/hunting groups get involved everyone including the fishery loses.

John Rakoci

From: Paul Brown [<mailto:paulbbrown@windstream.net>]

Sent: Tuesday, September 25, 2012 9:02 PM

To: Fish, Nancy

Subject: shrimp amendment

the bycatch is unacceptable we can't keep killing these fish just to catch shrimp. this needs to be fixed now and not put on the back burner any more. the fish can't wait any more for someone to take action.

From: Ron Bennett

Sent: Tuesday, September 25, 2012 2:51 PM

To: nancy.fish@ncdenr.org

Subject: Shrimp FMP

Dear Ms Fish,

I strongly believe we need to amend the current regulations to ban shrimp trawling in our sounds. Killing over 500 Million fish as "by catch" of shrimping is unacceptable and one reason our fisheries are in such poor shape relative to most coastal states that have already banned this type of activity.

Thank you for entering my comments into the Public Record.

"Recent studies by the North Carolina Division of Marine Fisheries have shown that approximately 78 percent (by weight) of what is caught in shrimp trawls is untargeted "by catch" that will die before being shoveled overboard. More shockingly, the annual by catch from NC shrimp trawlers consists of over 500 million individual small fish."

Ron Bennett
117 Pudding Pan Lane

Kitty Hawk, NC 27949
252-261-4863

From: Stephen Martin [<mailto:stephenrmartin@suddenlink.net>]
Sent: Tuesday, September 25, 2012 1:15 PM
To: Fish, Nancy
Subject: Shrimp Trawling Bycatch

I am unable to attend any of the public meetings scheduled to address this issue but wish to register my opinion. At the very least the subject should be reopened so that further research and evidence can be brought into play before the issue is buried for several more years. North Carolina has been my home for only 6 years and my time here has confirmed often the decision to move to the state. One thing which consistently disappoints is the blind eye turned toward the steady and unnecessary decimation of fish stocks in our state. Whether it is the wanton waste produced by in-shore gill netting, the high-grading by striped bass netters or the even more dramatic destruction of fish stocks by shrimp trawling in-shore, North Carolina seems always to disappoint when it comes to reasonable protections for marine resources. And it seems that the proud tradition of coastal fishing families in our state is the banner waved to justify the blind eye turned time after time. I moved here from Louisiana where there is an equally strong and proud tradition of commercial fishing stretching back many generations in the same families. The difference is that Louisiana (and nearly every other coastal state from here to Texas) recognizes the obvious: if destructive practices continue the commercial fishermen will eventually catch the last fish and in the meantime will have driven the far more economically significant recreational fishery away. So, rather than quibble about how many pounds of juvenile finfish it is okay to sacrifice for each pound of shrimp taken, why not talk about which of the already available techniques for limiting bycatch are to be mandated for general use. If not, I can guarantee that there are enough angry, frustrated recreational fishermen out there that no politician supporting the status quo will ever get elected again. Thanks for listening.

Steve Martin
1003 Coopers Ct.
Trent Woods, NC 28562

From: John Canup [<mailto:jcanup@suddenlink.net>]
Sent: Tuesday, September 25, 2012 10:01 AM
To: Fish, Nancy
Subject: Trawling in internal waters

I totally support banning trawling in internal waters in North Carolina. I have personally witnessed the mass destruction of small fish (bycatch) generated by shrimp trawling in Core and Pamlico Sounds. Also, yesterday (September 24, 2012) while I was trout fishing near Chapel Creek in Bay River I observed a net boat working a set net. He removed three turtles in the first sixty yards of the net. I had been fishing there for approximately 45 minutes before he arrived and had seen no turtle activity—therefore I assume they were dead. Our sounds and rivers are fish nurseries and we must protect them to sustain our fisheries resource.

From: Mike Hadley [<mailto:mikehadley@geoguys.net>]
Sent: Tuesday, September 25, 2012 8:20 AM
To: Fish, Nancy
Subject: Trawling Nets

Nancy,

I am not able to attend my area meeting in New Bern, NC and would like to voice my experience/opinion about shrimp trawling nets inside coastal waters.

Years ago with my ex-father in law, I helped him on his small boat pulling a shrimp net in the intercoastal waterway between Sneads Ferry & Surf City. I witness the destruction of juvenile fish that in numbers and weight accounted for the majority of the catch. At the time I thought nothing of it since I was young and we were part of what I thought was a very small number of boats pulling shrimp nets. Then I witnessed opening day one year in the New River and I saw at least 100 boats pulling shrimp nets in the river. It then hit me! If we are destroying small fish by the hundreds, then how many juvenile fish are going to be killed in the next few hours? 3,000, 4000, or 5000 lbs.? That was when I quit helping on the shrimp boat and started asking my then father in law to quit. He told me that the river and waterways would never run out of fish.

That was the mindset then and I do believe that some people still think that way. Those are the people that need to be educated about the declining fish populations that we are experiencing now. For some reason, I have seen more menhaden in the waterways this year than I have seen in the past 5 years. Is this just coincidental or is it because we have new rules covering catching menhaden within 3 miles of the NC coast? I vote to ban all trawl nets in any interior coastal waterway. RIGHT NOW!!!!

Mike Hadley
128 Magens Way
Cedar Point, NC 28584
252-393-6382

From: John Trueblood [<mailto:jrdntrue@gmail.com>]

Sent: Wednesday, September 26, 2012 1:24 PM

To: Fish, Nancy

Subject: shrimp FMP

For the record:

I urge MFC to reopen the shrimp FMP and amend the plan regarding the "by catch" issue.

Thank You.

John R. Trueblood,

Recreational fisherman

Sent: Wednesday, September 26, 2012 10:08 AM

To: Fish, Nancy

Subject: shrimp management plan

i am asking the marine fisheries commission to please amend the shrimp fisheries management plan so me and my children and grandchildren will be able to enjoy and catch fish in pamlico sound like we once did 40 years ago .thank you

From: Lee Dunn [<mailto:lhduinn@comcast.net>]

Sent: Wednesday, September 26, 2012 9:22 AM

To: Fish, Nancy

Subject: Shrimp FMP comments: please meaningfully regulate bycatch

I cannot be present at any of the public hearings on the Shrimp FMP, but I want to enter my sentiments about the plan, and about the great state of North Carolina's fisheries management in general, into the public record:

I am in 100% agreement with the position of the Coastal Fisheries Reform Group, who's memo and position on this issue you are no doubt familiar. The present Shrimp FMP does not seriously address the bycatch issue, and to allow the status quo to continue without critical review is disdainful to NC citizens and blind to the resource. The statistics on bycatch clearly speak for themselves, though this issue alone is far from the only problem with the destructive otter trawl shrimping effort going on in NC's inland waters.

Could it be possible that there is a new day dawning in regard to marine fisheries in NC? Could NC actually move out of the dark ages and towards managing it's marine resources with respect to science, logic, and the fact that it belongs to all of NC's citizens, not just to fish house owners? Is it possible for North Carolina rise above it's current status as the laughing stock of coastal fisheries management in the U.S.?

I sure hope so, and it seems that the tide of awareness and concern is rising. To that end, as an initial step, please do everything in your power to support implement regulations to curtail this destructive fishery.

Thank you,

Lee H. Dunn

Beaufort

From: William Mayo [<mailto:william.mayo@rockymountnc.gov>]

Sent: Wednesday, September 26, 2012 7:03 AM

To: Fish, Nancy

Subject: Restrict/ban coastal trawling

Nancy,

I'm emailing in support of RESTRICTING or BANNING commercial trawling and other netting in NC's coastal waters. While I understand the detrimental effect my position poses to those who fish commercially, I also acknowledge that if the State doesn't make some changes, commercial

nor recreational fishermen will have any resources to pursue. It is time to take a bold step to protect our declining natural resources. The many recreational fishermen in the State have been dictated to by the few commercial fishermen and their political allies for too long.

Thank you,

--

Trey Mayo, Fire Chief
City of Rocky Mount
375 East Raleigh Boulevard
Rocky Mount, NC 27801
Office: 252 972 1490
Mobile: 252 343 3167
Facsimile: 252 972 1670
william.mayo@rockymountnc.gov
rockymountfire.org

Raleigh

From: Max [<mailto:mkasselt@suddenlink.net>]
Sent: Sunday, September 30, 2012 9:32 PM
To: Fish, Nancy
Subject: Public Comment Sought on Shrimp Trawling and Bycatch - Outline for a possible solution

Dear Ms Fish,
I passed my letter to you (below) to a few friends - but only received ome reply. I deleted his name as this info could become public.

----- Original Message -----

From: [Max](#)
To:
Sent: Tuesday, September 25, 2012 7:54 PM
Subject: Re: Public Comment Sought on Shrimp Trawling and Bycatch - Outline for a possible solution

Pay no taxes - Yet they rob the nursery.

----- Original Message -----

From:
To: mkasselt@suddenlink.net
Sent: Tuesday, September 25, 2012 9:22 AM
Subject: RE: Public Comment Sought on Shrimp Trawling and Bycatch - Outline for a possible solution

The fishermen never declare profits thus pay no income taxes....if this was put into law you would all of a sudden have huge declared incomes and tax return revisions.

From: Max [<mailto:mkasselt@suddenlink.net>]
Sent: Monday, September 24, 2012 11:00 PM
To: ;
Subject: Public Comment Sought on Shrimp Trawling and Bycatch - Outline for a possible solution

This is what I want to to send. Please make suggestions. Please send in your own comments as well

nancy.fish@ncdenr.gov

Dear Ms Fish,

The damage done to our fish resources by commercial and "recreational" shrimp trawling in internal waters is a known fact.

That we allow it is a tragedy.

My rough outline for a possible solution:

1. Ban all trawling for shrimp in internal waters
2. Have the state buy all the operational boats of fisherman who claim they cannot survive - then resell them - even at a loss.

Sellers of boats, may not buy or have an interest in any sold boat for 5 years.

3. Reimburse all active fishermen (who sold their boat and/or turned in their commercial license) 10 or 20 times their highest declared income (from fishing) in the last 10 years.

The rewards of creating an angler's paradise will more than pay for the above.

Max Kasselt

From: Jim Parsons [<mailto:jparsons5@ec.rr.com>]

Sent: Tuesday, October 02, 2012 10:31 AM

To: Fish, Nancy

Subject: Shellfish/Crustacean Meeting

I am also unable to attend the meeting tonight due to a previous appointment. I concur with the analysis of Dr. Danzler which is reprinted below. I have seen the carnage first hand. I have owned a shrimp trawl and the terrible damage it was inflicting upon the resource is why I no longer own it. The skimmer rigs do a lot of damage, but the trawls have done, and do, immense damage to the finfish resource.

I urge the MFC to amend the Shrimp FMP to eliminate trawls in the inland waters. It is the right thing to do for the finfish resource!

**James C Parsons
210 Sumter Court
Havelock, NC 28532**

From: Lee [<mailto:lee.dantzler@adamscreek.com>]

Sent: Tuesday, October 02, 2012 9:30 AM

To: Fish, Nancy

Cc: Jim Parsons; Tony Michalek

Subject: Unable to attend tonight's Shellfish/Crustacean Meeting New Bern meeting on shrimping by-catch etc, BUT ... written comments provided

Due to prior business plans I am unable to attend the **Shellfish/Crustacean Meeting** at the

Craven County Cooperative Extension Office in New Bern. I understand you accept written comments, which I am providing below:

The latest studies by the DMF, the by catch ratio was typically 4 to 5: 1 and indicates that an estimated 24 million pounds of finfish by-catch has occurred each year for the last five years. The study, which is considered valid and solid by DMF scientists, also determined that the finfish killed in the trawlers were small, averaging around 20 finfish per pound. Multiplying 20 fish per pound by 24 million pounds allows us to get a rough estimate of 480 million juvenile finfish that are killed annually by trawlers operating in North Carolina waters. This is unacceptable to the long-term health of our finfish populations.

I implore the MFC to amend the Shrimp FMP and address the issue of by catch by shrimp trawlers operating in our in shore waters.

I urge you to consider issuing an emergency order to suspend all shrimping and powered boat netting in inshore waters (including all our sounds) until an effective emergency by-catch reduction plan can be developed, vetted and approved.

Dr. H. Lee Dantzler
Ph.D, Oceanography
538 Joyner Drive
Havelock, NC 28532

Sent: Friday, October 05, 2012 3:22 PM

To: Fish, Nancy

Subject: Shrimp trawls

To whom it may concern:

Something has got to change in NC about trawling for Shrimp and the by-catch kill it is causing. To do nothing for the next five years borders on being criminal. At this rate no fishery can sustain itself. I don't understand how Mr. Stryron can sit chair this board and be impartial. It is the same old story of " Having the Fox watch the Chickens " It's no wonder this State is so far behind our neighbors when it comes to fish management.

I would implore you to take action to stop this needless killing of our small fish, which will eventually lead to the decimation of all our inshore fish species. We need to act now !

Thank you,

David L. Griffith
New Bern NC

From: Larry Mize [<mailto:jmize2@triad.rr.com>]

Sent: Sunday, October 07, 2012 4:08 PM

To: Fish, Nancy

Subject: Shrimp Fisheries Management Plan

Larry Mize

701 N. Main St.

Graham N.C. 27253

336-227-1592

E-Mail jmize2@triad.rr.com

Date; October, 7, 2012

To: North Carolina Commission of Marine Fisheries

Subject; Shrimp Fisheries Management Plan

Dear Sirs,

I would like to recommend that the Marine Fisheries Commission amend the current Shrimp Fisheries Management Plan.

While I wouldn't want to see the shrimping industry in North Carolina shut down, I do believe we have a responsibility to properly and immediately manage all of our saltwater resources.

Sincerely,

Larry Mize

From: Ron Zielinski [<mailto:reellucky@centurylink.net>]

Sent: Wednesday, October 10, 2012 8:42 AM

To: Fish, Nancy

Subject: Comments on proposed 2012 shrimp fisheries managemant plan

Dear Ms. Nancy Fish,-----I attended the Oct. 2nd Shellfish/Crustacean meeting in New Bern to gather printed information and hear those who chose to speak during the comment period. After reviewing my notes and reading all material gathered, I wish to offer my thoughts on the future of N.C. coastal water's commercial shrimping and fish management. My past experiences include working with an organization to help clean up the Hudson River in New York, guest speaker at many fishing clubs and seminars, promoting the use of circle hooks to reduce by-catch mortality, spearheading the rebuilding of the local AR-396 Artificial Reef in conjunction with the NCDMF Artificial Reef program, occasionally writing articles for magazines, and being a licensed charter captain for 14 years. I am devoted to protecting our local natural resources for future generations' enjoyment and use. Before moving to North Carolina, many visits were made to experience the quality of local fishing. Talking to long time residents about their past fishing experiences made me realize there had been a reduction of sport fish in the Neuse River and Pamlico Sound. In the past 14 years, since first starting to fish the local waters, this reduction seems to be continuing. Several reasons have been offered for this development: lack of water quality, hurricanes, oxygen depletion leading to fish kills, commercial netting in nursery areas of local waters, the influx of commercial fishermen from states that have banned netting in inland waters, and the shrimp trawler's fin fish by-catch mortality. We cannot control Mother Nature but can work on modifying what we as individuals can do. Being we have the possibility of changing the N.C. commercial netting practices with the upcoming Shrimp Fisheries Management Plan, I wish to offer some changes for consideration. With an estimated annual 24 million pounds of juvenile finfish, (mostly spot, croaker, and grey trout), being netted and wasted as by-catch in our inshore waters, we should think of ways to protect these needed " seeds " to increase the numbers of these depleted species. From what has been printed, these figures were gathered from recent trawler studies conducted by the N.C. Dept. of Marine Fisheries. This summer and early fall, while piloting on the lower Neuse River and the Pamlico Sound, there were days when 30-40 shrimp trawlers were actively working in small areas from the mouth of

Broad Creek (west of the NR buoy) and into the sound while chasing the migrating shrimp. This has also happened in previous years. Discussing this practice with other recreational fishermen and local commercial netters, the idea of permitting shrimp trawling only in the eastern part of the Pamlico Sound seemed an acceptable alternative. This compromise would reduce the juvenile by-catch mortality in the Neuse River and near other feeder creeks and rivers used as nursery areas that flow into the west part of the sound. This would continue allowing the shrimp harvest in somewhat weather-protected inland waters behind the Outer Banks. A north/south longitude line or something similar like 2 marker buoys or points of land could be used for a defined separation. An additional benefit would be the elimination of the destruction of bottom habitat and structure which is needed for fin fish habitat. This could also stop the movement for the total elimination of trawling in the N.C. inland waters, as most other coastal states have already done. A reduction of the total head rope while in the Pamlico Sound was brought up by several speakers and sounded like a good idea. There did not seem to be a strong negative reaction to this proposal. In the end we are all in North Carolina to enjoy what it has to offer for work and recreation. We have to consider what's best for the environment, the economy and wellness for our state.-----Best Regards, Ron Zielinski

14.4 APPENDIX 4 – BYCATCH REDUCTION DEVICES AND TURTLE EXCLUDER DEVICES



FOR INFORMATION CONTACT:

Michael Barnette, Michael.Barnette@noaa.gov
2012
(727) 551-5794, FAX (727) 824-5309

May 21,

FB12-037

NOAA Certifies Additional Designs and Materials for Fishermen Currently Required to Use Turtle Excluder Devices

NOAA Fisheries Service announces a final rule adding allowable Turtle Excluder Device (TED) modifications and additional certified TED designs for the shrimp and summer flounder trawl fisheries. The additional designs and modifications may enhance TED effectiveness in reducing sea turtle mortality, promote catch retention, and increase vessel fuel efficiency. The allowable modifications are not mandatory, but provide additional options for fishermen currently required to utilize TEDs.

Provisions of the rule include:

- The addition of flat bar, box pipe, and oval pipe as construction material in currently-approved TED grids.
- An increase in the maximum mesh size on TED escape flaps from 1-5/8 to 2 inches (4.1 to 5.1 cm).
- The addition of the Boone Big Boy TED and Boone Wedge Cut TED escape opening for use in the shrimp fishery.
- The addition of three large TED escape openings.
- The addition of a brace bar as an allowable modification to hard TEDs.
- The addition of the Chauvin Shrimp Deflector to improve shrimp retention.
- The addition of a new TED for use in the summer flounder fishery.

There is also a correction to the TED regulations to rectify an oversight regarding the maximum size chain that can be used on the Parker TED escape opening flap.

NOTE: This final rule is not related to the proposed rule published in the *Federal Register* on May 10, 2012, that would, if implemented, require all skimmer trawls, pusher-head trawls, and wing nets (butterfly trawls) to use TEDs in their nets.

TEDs incorporate an escape opening, usually covered by a webbing flap, which allows sea turtles to escape from trawl nets. To be approved by NOAA Fisheries, a TED design must be shown to be 97 percent effective in excluding sea turtles during testing based upon specific testing protocols.

These latest modifications were developed in coordination with the commercial trawl industry, the Southeast Fisheries Science Center, and the Southeast Regional Office's Protected Resources Division. The modifications and TED designs were developed and tested by NOAA Fisheries gear specialists. Results from a study conducted by the Gulf and South Atlantic Fisheries Foundation were utilized in the development of these allowable modifications.

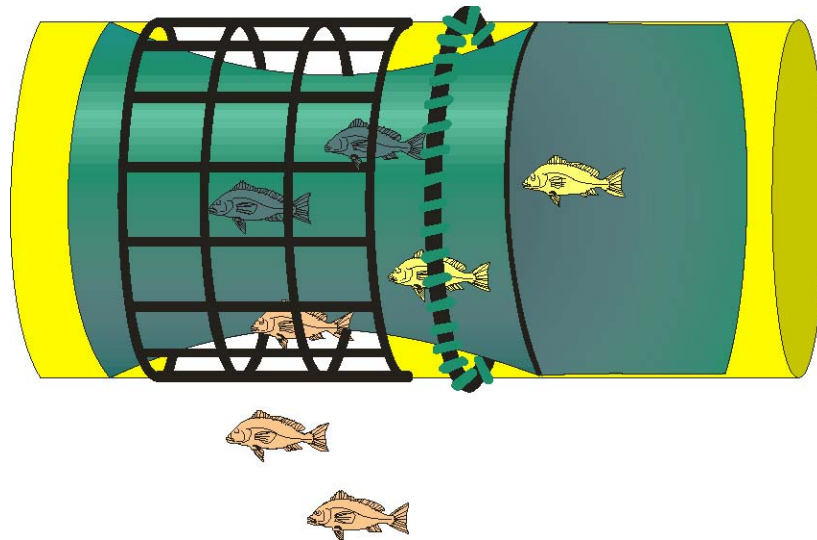
If you would like to receive these fishery bulletins via e-mail as soon as they are published, e-mail us at: SERO.Communications.Comments@noaa.gov . You will still receive a hard copy of these bulletins through the mail.

This bulletin provides only a summary of the information regarding the existing regulations. Any discrepancies between this bulletin and the regulations as published in the *Federal Register* will be resolved in favor of the *Federal Register*.

Recommended Construction and Installation Instructions

for the Extended Funnel Bycatch Reduction Device

NOAA Fisheries Service, Mississippi Laboratories
P.O. Drawer 1207, Pascagoula, Ms 39568-1207
March, 2008



The Extended Funnel Bycatch Reduction Device (BRD) has been certified for use in the Atlantic and provisionally certified for use in the Gulf of Mexico shrimp fishery. A **provisional certification** applies to an experimental BRD not quite meeting the criteria for certification, but deemed likely to meet the criteria with further testing. A provisional certification of a BRD is effective for 2 years from the date of publication in the Federal Register. This time period allows additional wide scale industry evaluation of the BRD candidate. The intent is to further refine the design or application of the experimental BRD so it could eventually meet the certification criterion.

Extended Funnel Description

The extended funnel BRD consists of an extension with large mesh webbing in the center and small mesh webbing on each end held open by a semi-rigid hoop. A funnel of small mesh

webbing is placed inside the large mesh section to form a passage for shrimp to the codend. It also creates an area of reduced water flow to allow for fish escapement through the large mesh. One side of the funnel is extended vertically to form a lead panel and area of reduced water flow.

Minimum Construction and Installation Requirements

Figure 1. Extension Material

The small mesh used on both sides of the large mesh escape section is constructed from #30, 1-5/8 inch (41 mm) stretch mesh nylon webbing. The front section is 120 meshes around by 6-1/2 meshes deep. The back section is 120 meshes around by 23 meshes deep.

Figure 2. Large Mesh Section

The large mesh escape section is constructed of 8 to 10 inch (20-25 cm) stretch mesh webbing. This section is cut on the bar to form a section that is 15 inches (38 cm) long, 95 inches (241 cm) in circumference. The leading edge is attached to the 6-1/2 mesh extension section and the rear edge is attached to the 23 mesh extension section.

Figure 3. Semi-Rigid Hoop

A 30 inch (76 cm) diameter hoop constructed of plastic coated trawl cable installed evenly 5 meshes behind the trailing edge of the large mesh section. The hoop is constructed using a 94-1/2 inch x 1/2 inch (240cm x 12.7mm) plastic coated cable. The ends are joined using a 3/8 inch micropress sleeve.

Figure 4. Funnel

The funnel is constructed of 1-1/2 inch (38 mm) stretch mesh #30 depth stretched and heat set polyethylene webbing. The circumference of the leading edge is 120 meshes and the back edge is 104 meshes. The short side of the funnel is 34 to 36 inches (86-91 cm) long and half of the opposite side of the funnel extends an additional 22 to 24 inches (5661 cm).

Figure 5. Funnel Attachment

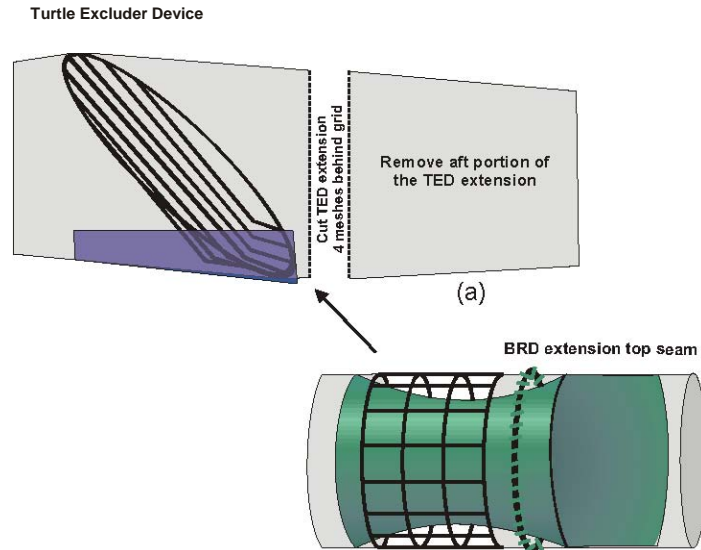
The leading edge of the funnel is attached 3 meshes forward of the large mesh leading edge. Seven meshes of the short side of the funnel is attached to the back section of extension webbing on the top and bottom, 8 meshes back from the trailing edge of the large mesh section. The extended side of the funnel is attached on a slight angle to the top and bottom of the back extension webbing.

Installation of the Extended Funnel BRD

The Extended Funnel BRD is attached behind a hard TED 8 inches (20 cm) behind the posterior edge with the codend attached to the trailing edge of the BRD. If a soft TED is used a second hoop must be installed in the front section of the BRD extension webbing at the leading edge of the funnel.

The Extended Funnel BRD is designed to be installed immediately behind the Turtle

Excluder Device (TED). To install the BRD, first remove the rear portion of the TED extension by cutting the TED extension on an even row of meshes 4 meshes behind the posterior edge of the TED grid (a). Next, join the leading edge of the BRD extension evenly to the TED extension directly behind the TED (b). When attached, the BRD extension should be oriented so that the BRD extension seam is located on top of the trawl when towing. Complete the installation by attaching the codend (bag) to the trailing edge of the BRD extension.



This document was prepared for general informational purposes in March 2008 and has no legal force or effect. Please refer to the federal BRD regulations, 50 CFR part 622 and 622 Appendix D and the Federal Register for specific and controlling BRD requirements.

For more information contact:
NOAA Fisheries
Harvesting Systems and Engineering Branch
P.O. Drawer 1207
Pascagoula, MS 39568
(228) 762-4591
Robert.D.Stevens@noaa.gov or
Daniel.G.Foster@noaa.gov

Figure 1.

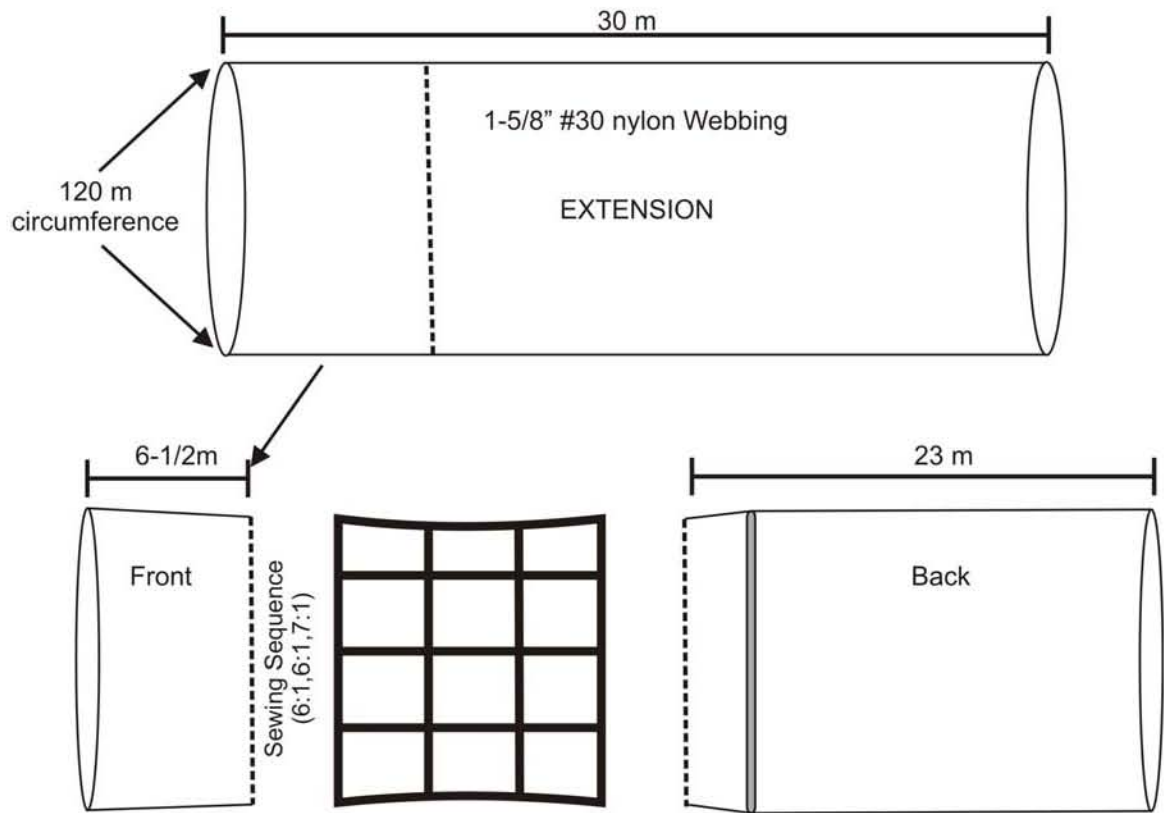
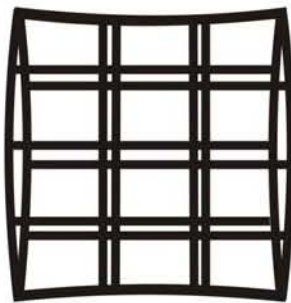
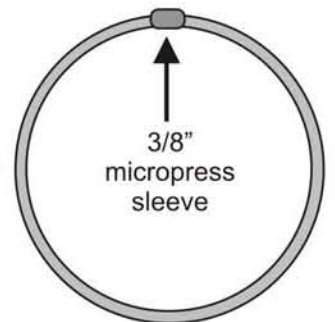


Figure 2.



Large Mesh
10" x 10"mm polyester

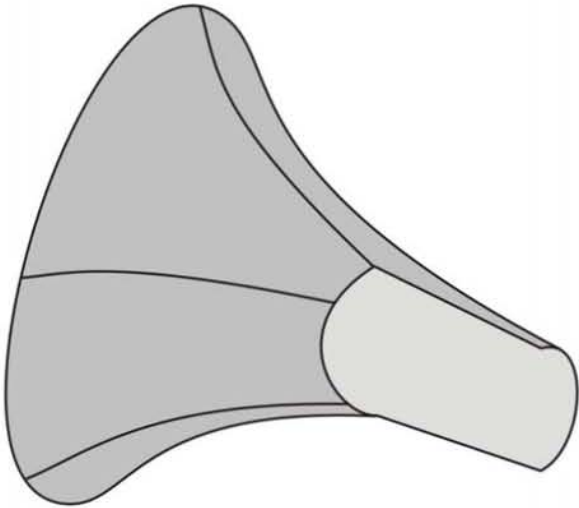
Figure 3.



3/8" micropress sleeve
1/2" plastic coated cable ring circumference 94-1/4"

Figure 4.

Funnel

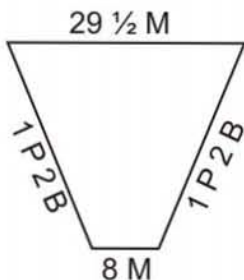
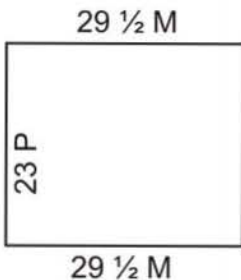
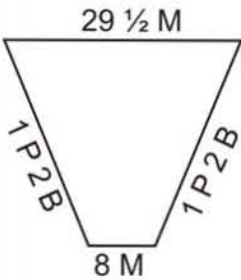


Side

Top

Side

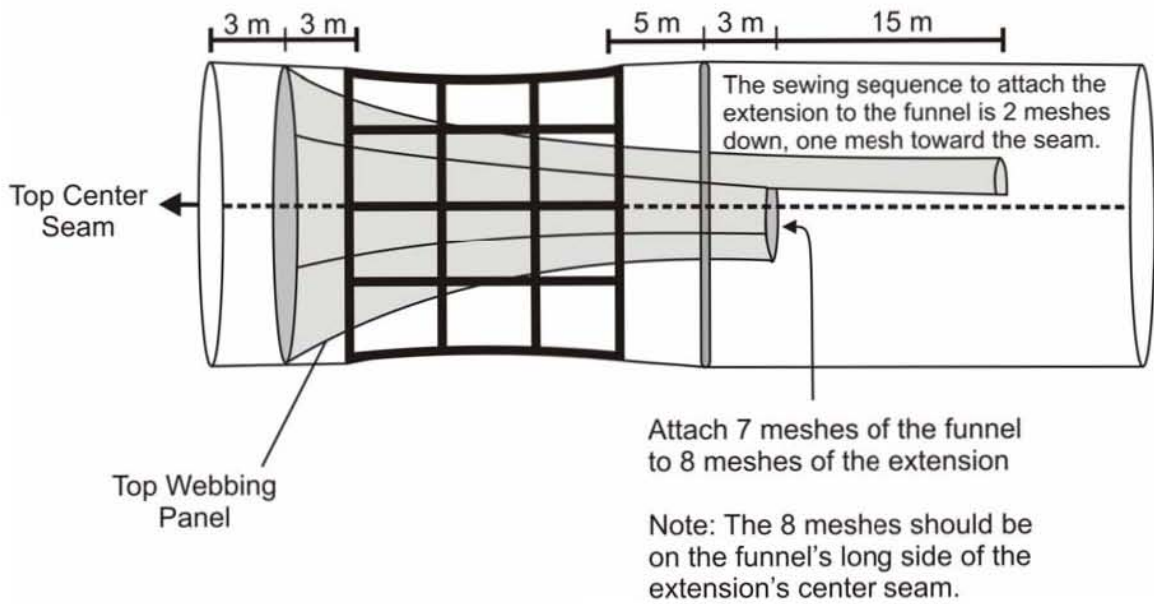
Bottom



Webbing Panels

Figure 5.

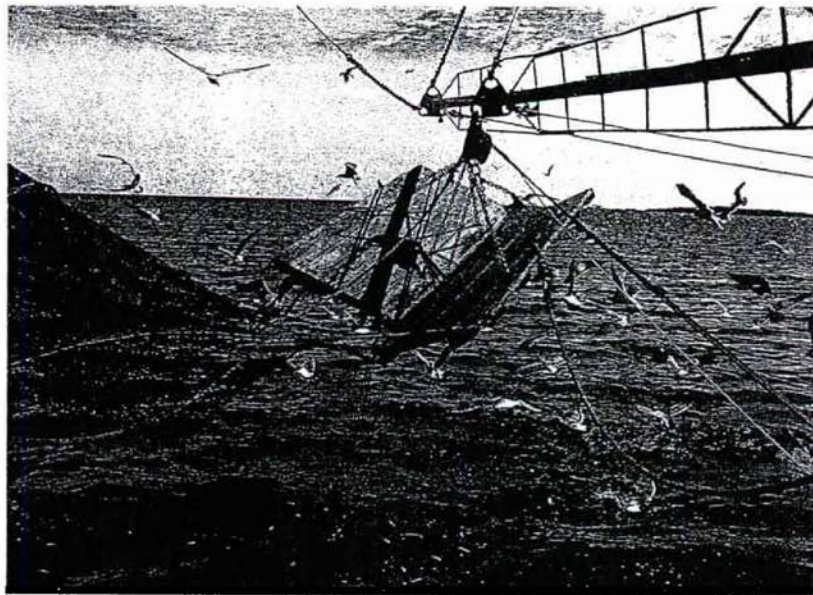
Top View



99-FEG-33

Dennis Sawyer
Pamlico County Schools

CERTIFICATION OF BYCATCH REDUCTION DEVICES IN NORTH CAROLINA



99-FEG-33

November, 2001

Bruce Morris, Captain
F/V Miss PCHS
Pamlico County Schools
507 Anderson Drive
Bayboro, North Carolina 28515
Ph. (252) 745-4171 Fax (252) 745-4172

**CERTIFICATION OF
BYCATCH REDUCTION DEVICES
IN NORTH CAROLINA**

By

Bruce Morris

Pamlico County Schools

507 Anderson Drive
Bayboro, NC 28515
(252)745-4171
FAX
(252)745-4172

The research in this report was financed by the North Carolina Sea Grant administered Fisheries Resource Grant Program and conducted by the North Carolina Department of Public Instruction and Pamlico County Schools.

The contents of this publication do not necessarily reflect the views or policies of any of the above agencies or entities.

Grant 99-FEG-33

November, 2001

ACKNOWLEDGMENTS

The researcher wishes to thank the following individuals for their assistance during the course of this grant.

- Owen Lupton, Pamlico County Schools-retired, computer analysis, statistics, and report writing
- Dr. Julia Mobley, Hank Waters, Steve Curtis, Caroline Willis, and Jean Abbott from the Pamlico County Board of Education
- Allen Buck, Ryan Cuthrell, Travis Hardison, Tyler Hardison, Jason Harris, Justin Harris, Ricky Henries, Brad Newman, Scott Paul, Todd Powers, Daniel Rios, and Robbie Simpson, –students in the Marine Occupations II class of Pamlico County High School
- Sean McKenna, North Carolina Division of Marine Fisheries, technical assistance
- Greg Faulkner, net designer from Louisiana
- Tom Jamir, Gulf and South Atlantic Fisheries Foundation, Inc.

EXECUTIVE SUMMARY

The purpose of Marine Resources Grant 99-FEG-33 awarded to Pamlico County Schools was to help the North Carolina Division of Marine Fisheries certify bycatch reduction devices in the shrimp trawl fishery. The Atlantic States Fisheries Management Council (ASFMC) has adopted a protocol which Atlantic states within their jurisdiction must follow for the certification of bycatch reduction devices. Before any bycatch reduction device is approved for use in North Carolina, it must be certified according to this adopted protocol. Bycatch reduction devices can substantially reduce the bycatch of most species of finfish without causing shrimp trawling to become economically impossible. A second primary objective was to ascertain the percentage of shrimp loss in each bycatch reduction device.

When all tows for the control net were combined the total number of weakfish in the control was 2448. The total number of weakfish in all bycatch reduction devices was 1724, and total reduction by number was 30%. The total weight of all weakfish in the control was 161 kg. Total weight of weakfish in all bycatch reduction devices was 108 kg, and total reduction by weight was 33%. Total number of Spanish mackerel was 23 in the control, and 3 in all bycatch reduction devices for a reduction of 87%. Total weight of all Spanish mackerel in the control was 1.56 kg, and .18 kg in all bycatch reduction devices for a reduction of 89%.

The control net had a combined shrimp catch of 613 kg. The bycatch reduction devices had a combined shrimp catch of 566 kg. The overall percentage of shrimp loss was 8% for all bycatch reduction devices. Total tows for the entire research project was 126. Total useable tows was 108.

Results from subsamples showed most of the finfish in the tows were overwhelmingly Atlantic croaker and spot with a few miscellaneous species.

The ASFMC has adopted a protocol to use in certifying bycatch reduction devices and is primarily concerned about reaching a 40% reduction in numbers of weakfish and Spanish mackerel. North Carolina must have adequate data to meet the protocol for reduction of weakfish and Spanish mackerel in the shrimp trawl fishery. Bycatch reduction continues to be a major concern in all fisheries. Shrimp trawling takes place in a very fragile ecosystem. Inshore shrimp trawling in particular is adjacent to primary and secondary nursery areas where large numbers of the finfish are young of the year or juveniles that are non-marketable and therefore wasted other than as cull scrap returned to the water. The use of trawling gear is bottom disturbing, but the impact, if any, has not yet been proven to do permanent damage. The bottoms of shallow water sounds in North Carolina are just as easily disturbed by storms and wave action. The shrimp trawl industry is working in areas that are already under stress because of human and animal waste. The trawling industry must help preserve the limited reproductive and growing capacities of our waters, because human population is ever increasing which constantly results in loss of habitat. Less volume in the bycatch translates into more profit and less work for the shrimpers.

TABLE OF CONTENTS

	Page
Acknowledgments.....	ii
Executive Summary.....	iii
Table of Contents.....	iv
List of Tables.....	v
List of Figures.....	vi
Introduction.....	1
Gear Specifications.....	1
Data Analysis and Collection.....	4
Results	
Fish Slot II.....	5
Lake Arthur BRD.....	6
Kelly/Girourard Grid.....	6
Conclusions.....	7
Recommendations.....	8
Appendices	
References	

LIST OF TABLES

	Page
Table 1 Fish Slot II- Total weights.....	10
Table 2 Lake Arthur BRD- Total weights	14
Table 3 Kelly/Girourard Grid- Total weights.....	17
Table 4 Fish Slot II - Finfish average length and average weight	21
Table 5 Lake Arthur BRD - Finfish average length and average weight	22
Table 6 K/G Grid - Finfish average length and average weight	23

LIST OF FIGURES

	Page
Figure 1 Fish Slot II	2
Figure 2 Lake Arthur BRD.....	3
Figure 3 Kelly/Girourard Grid	4
Figure 4 Fish Slot II Total Weights.....	11
Figure 5 Weakfish Length Frequency Distribution- Fish Slot II	12
Figure 6 Spanish mackerel Length Frequency Distribution-Fish Slot II	13
Figure 7 Total Weights Lake Arthur BRD.....	15
Figure 8 Weakfish Length Frequency Distribution- Lake Arthur BRD	16
Figure 9 Total Weights K/G Grid.....	18
Figure 10 Weakfish Length Frequency Distribution- K/G Grid	19
Figure 11 Spanish mackerel Length Frequency Distribution- K/G Grid.....	20

INTRODUCTION

The purpose of Fishery Resource Grant 99-FEG-33 awarded to the Pamlico County Board of Education was to gather data to help the Division of Marine Fisheries certify bycatch reduction devices for the shrimp trawl fishery. North Carolina is following a testing protocol established by SAFMC (South Atlantic Fisheries Management Council) and adopted by ASFMC (Atlantic States Fisheries Management Council) for bycatch reduction of weakfish and Spanish mackerel in shrimp trawls. This grant gathered data for three bycatch reduction devices being tested for certification in North Carolina. They were the Fish Slot II, the Lake Arthur BRD, and the Kelly/Girourard Grid. This is the final report on the results.

The paired tow method of testing was used for certification. This method employs a control trawl without a bycatch reduction device pulled alongside a trawl using the test bycatch reduction device. The testing protocol requires a minimum of 30 tows for certification of a BRD with at least 5 or more weakfish or 1 Spanish mackerel in one of the trawls. Bycatch reduction in the shrimp trawl fishery is important from a conservation and economic standpoint. This research determined the numbers of weakfish and Spanish Mackerel caught, reduction of both species, and loss of shrimp with each bycatch reduction device.

The research for the grant began on June 26, 2000, and ended on September 11, 2001. Ten 60-minute tows calibrated the trawls to within 10% of each other prior to testing. Tow times were for 60 minutes unless otherwise noted. The BRD was switched to the opposite side of the vessel after 5 tows to minimize any difference in the gear. The completed summer research during 2000 yielded 41 tows for the Fish Slot II, but 3 were fouled and were discarded. The summer research during 2001 yielded 38 tows with the Lake Arthur BRD, but 4 were fouled and discarded. The 2001 summer research also yielded 37 tows for the Kelly/Girourard Grid with 1 fouled and discarded.

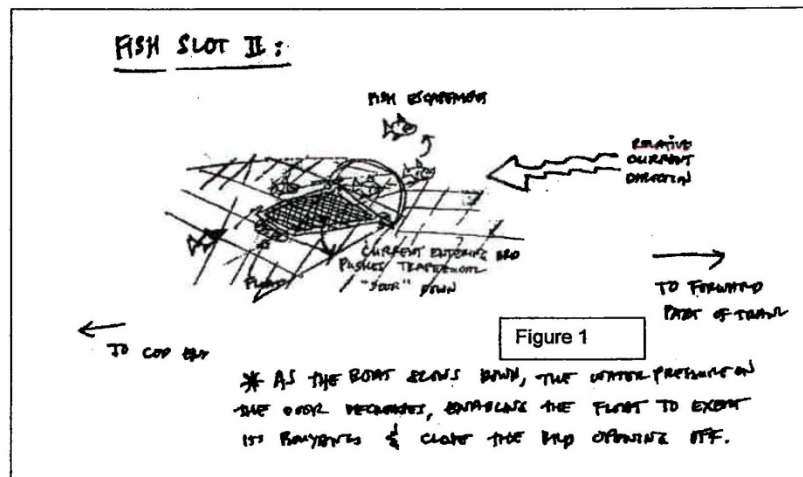
GEAR SPECIFICATIONS

The shrimp trawls were 32 foot (headrope) two-seam nets built by Harris Net Shop at Atlantic with 1.5 inch stretch mesh bodies cut on a 4/1 taper and constructed of #12 nylon webbing. Hanging was on 5/16-inch combination cable and the leg lines were 4 ft. The footrope rope had 1/4 inch galvanized chain. The wings had seven loops of chain (*16 links per loop*) and the belly had three loops. Three additional loops of chain were located between the wings and belly at the jib corners. The 3/16-inch tickler chain was two feet shorter than the footrope. The trawl doors were 5 and 1/2 feet long by 28 inches high and had 4 inch by 3/8-inch shoes on the bottom. The towing bridles were 3/8-inch diameter by 150 feet long. Both trawls were equipped with 120 mesh mini super-shooter TED's with bottom exit and accelerator funnels of stretch poly. The 1.5 inch

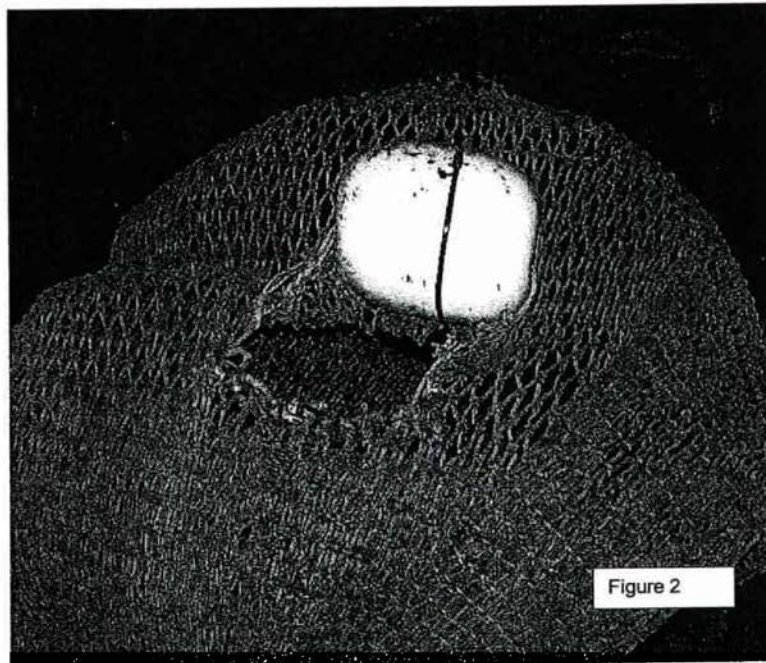
stretch mesh tailbags were constructed of #36 nylon webbing, 120 meshes around, and 120 meshes long with tie-off up 15 meshes from the bottom. All tailbags had elephant ears attached in place of choke straps to avoid the normal clogging that occurs with choke straps. Both trawls had YKK zippers about 10 feet in circumference sewn in between the TED and tailbag to facilitate BRD changes. The zippers worked well and did not come apart on any tows. Tailbag changes took less than 15 minutes.

The research vessel was the F/V Miss PCHS. The Miss PCHS is 38 feet long, powered by a CAT 3208 diesel with a 2:1 gear, and double rigged. All tows were at a vessel ground speed of 2.5 kts. as measured by GPS and Loran. Additional information for each tow included the date of tow, time of tow, and starting/stopping coordinates for the tow. Other recorded information included water temperature, salinity, water depth, wind direction and velocity, and tow number. As much as possible, all tows were in a straight line to prevent one net from fishing more ground than the other. No trynet was used during the research tows.

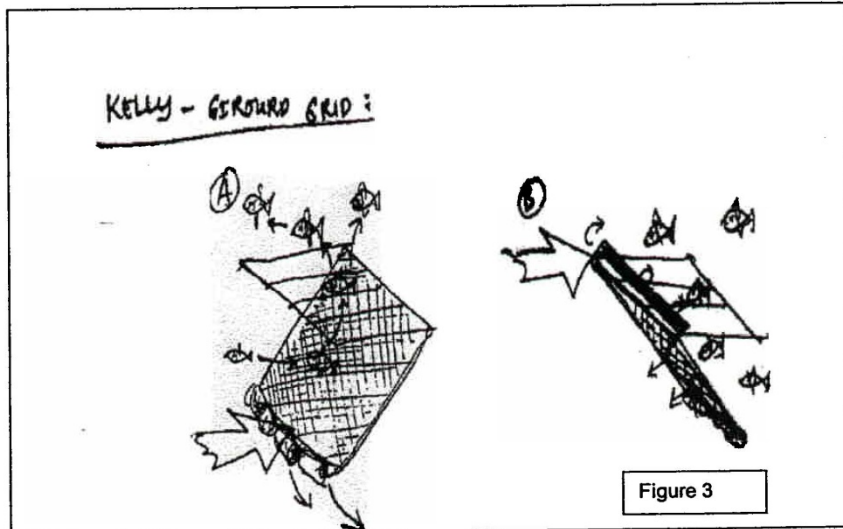
The Fish Slot II (Figure 1) is an aluminum rod-framed structure similar in design to the NMFS-approved Fish Eye. The Fish Slot II, however has a wider curvature and front-deflector. The Fish Slot II is installed at the 12 o'clock position in the tailbag, up 56 meshes from the tailbag tie-off. The Fish Slot II's trapezoid-shaped, bottom-floating trap door, made of extruded mesh, floats up and closes the escape hole to block shrimp from swimming out. This allows for a slightly longer period of time for fish to escape before shutting off as compared to similar devices like the Sea Eagle II, (National Fisherman, April 1999). The Fish Slot II testing yielded 38 useable tows from July 3, 2000 to August 3, 2000.



The Lake Arthur BRD (Figure 2) was originally used in the Lake Arthur area of western Louisiana. It was in use on single-rigged vessels for 20 years before the term BRD was ever coined. The Lake Arthur BRD doesn't depend on any type of framework. There is a 12-inch slit in the top of the tailbag at the 12 o'clock position. This slit was cut 56 meshes ahead of the tailbag tie-off. A chain is affixed to the front side of the slit, and a football float to the rear side. The combination of the float rising and the chain pulling down keeps the slit open while trawling. As the net slows down, the float pulls the net to the surface and bunches up webbing, which keeps the shrimp inside the tailbag (National Fisherman, April 1999). Testing yielded 34 useable tows from June 12, 2001 to July 10, 2001.



The Kelly/Girourard Grid is a grid-like aperture placed directly behind a TED. It can be used in the top or bottom of the cod end. The device has evenly spaced lateral bars that allow the fish to swim out of the trawl. When the BRD is fitted with a floating ramp, placed directly beneath the grid, fish swim out until the forward speed of the net slows down enough for the ramp to float upward and close off the escapement hole (National Fisherman, April 1999). The Kelly/Girourard Grid was tested from July 16, 2001 until September 11, 2001.



DATA ANALYSIS AND COLLECTION

The catch from each tailbag was examined in the following manner. All weakfish and Spanish mackerel were picked up. The numbers were counted from each tailbag and a random subsample of up to 30 individuals was taken. The subsample yielded an average length to the nearest millimeter, total length (TL), and an average weight to the nearest gram. The subsample also yielded a length frequency distribution of the weakfish caught with each BRD. The percentage of difference in total catch weight between the control and test BRD used the formula $[(\text{control-test})/\text{control} \times 100]$. The paired t-test method compared mean catches between the gear. A significance level of $P \leq 0.05$ was used for all tests. All data was recorded and calculated on Microsoft Excel 97. All the research data has been submitted to NCDMF for analysis and certification of the individual BRD's.

A subsample of the fish species caught was taken periodically to determine the types of finfish taken with the trawls. This subsample yielded a percentage of reduction for the different species. This subsample was taken by filling up one shrimp basket from each net and sorting the contents.

All shrimp were picked up and weighed. Then a sample of 3 pounds yielded a count per pound with heads on. A percentage of loss was calculated with each BRD.

Anything found forward of the elephant ear was excluded from the sample. Shaking out the nets before each tow began cleaned the trawls.

RESULTS

Fish Slot II

The number of weakfish in the control was 1770, and the Fish Slot II caught 1280 for a reduction of 27.7% (Table 1). Total weakfish weight in the control was 83.68 kg and in the Fish Slot II 58.68 for a reduction of 30%, (Figure 4).

The average length of weakfish in the control was 169 mm and the average weight was 54 grams. The average length of weakfish in the Fish Slot II was 167 mm and the average weight was 48 grams (Table 4). The control average was 46.6 weakfish per tow and the Fish Slot II average was 37.6 per tow.

The length frequency distribution range of weakfish was 90 mm to 300 mm. Both the control and BRD had weakfish in the greatest abundance in the 150 mm to 180 mm range with 160 mm predominating (Figure 5).

The control caught 7 Spanish mackerel with an average length of 156 mm and an average weight of 57 grams (Table 4). Length frequency distribution for the control was 150 mm to 165 mm with 3 at 150 mm, 3 at 160 mm, and 1 at 165 mm (Figure 6). The Fish Slot II caught no Spanish mackerel.

Total shrimp catch was 283.41 kg in the control and 267.41 kg in the Fish Slot II for a loss of 5.5% (Figure 4).

Weight reduction of spot in the 13 subsample tows was 19.3%, and reduction of Atlantic Croaker was 26.3%. Total finfish weight including the 13 subsample tows was 304.57 kg in the control and 229.65 kg in the Fish Slot II giving an overall reduction of 24.6% (Table 1).

Lake Arthur

The number of weakfish in the control was 199 and the number in the Lake Arthur was 131 for a reduction of 34.2% (Table 2). The control had a total weakfish weight of 31.46 kg and the Lake Arthur BRD had 20.80 kg for a reduction of 33.9% (Figure 7).

The average length of weakfish in the control was 237 mm and the average weight was 157 grams. The average length of weakfish in the Lake Arthur was 234 mm and the average weight was 160 grams (Table 5). The control average was 5.85 weakfish per tow and the Lake Arthur average was 3.85 per tow.

The length frequency distribution range of weakfish was 80 mm to 350-mm. Both the control and BRD had weakfish in the greatest abundance in the 220 mm to 260 mm range with the peak at about 240 mm (Figure 8).

Only one Spanish mackerel was caught in the control at a length of 150 mm and weight of 50 grams (Table 5). No Spanish were caught in the Lake Arthur.

Total shrimp catch was 156.25 kg in the control and 141.36 kg in the Lake Arthur giving a loss of 9.5% in the Lake Arthur (Figure 7).

Weight increased for spot in the 6 subsamples at 4.8%, and Atlantic Croaker had an 18.8% increase in the subsamples. Finfish weight including the 6 subsample tows was 118.78 kg for the control and 116.71 kg for the Lake Arthur giving a reduction of 1.7%. (Table 2).

Kelly/Girourard Grid

Total number of weakfish was 479 in the control and 313 in the K/G Grid for a reduction of 34.7% (Table 3). The control had a total weakfish weight of 45.55 kg and the Kelly/Girourard Grid had 28.25 kg for a reduction of 38% (Figure 9).

The average length of weakfish in the control was 177 mm and the average weight was 97 grams. The average length of weakfish in the K/G Grid was 171 mm and the average weight was 96 grams (Table 6). The control average was 13.3 weakfish per tow and the K/G Grid average was 8.7 weakfish per tow.

The length frequency distribution range of weakfish was 90 mm to 320 mm. Both the control and BRD had weakfish in the greatest abundance in the 120 mm to 170 mm range (Figure 10).

The control caught 15 Spanish mackerel and the K/G Grid caught 3 for a reduction of 80% by number. The average length of Spanish mackerel in the control was 159 mm and the average weight was 67 grams. The average length of Spanish mackerel in the K/G Grid was 133 mm and the average weight was 58 grams (Table 6).

The length frequency distribution for Spanish mackerel was 120 mm to 210 mm. The control had Spanish in the greatest abundance at 170 mm, while the 3 Spanish in the K/G grid were at the 130 mm to 140 mm range (Figure 11).

Total shrimp catch was 172.84 kg in the control and 156.70 kg in the K/G Grid for a loss of 9.3% (Figure 9).

The 5 subsample tows had a 21% weight increase for spot, and an 11.4% weight increase for Atlantic croaker. Total finfish weight including the 5 subsample tows was 104.86 kg in the control and 95.49 kg in the BRD giving an overall reduction of 8.9% (Table 3).

CONCLUSIONS

Fish Slot II

The Fish Slot II, which originated in the Gulf of Mexico shrimp fishery, did not have enough reduction of weakfish, at 27.7%, to certify in North Carolina. While the reduction of Spanish mackerel was 100%, there simply was not enough catch of Spanish, with only 7, to draw any valid conclusions. The shrimp loss was reasonably low at 5.5%, but there was not a high reduction of our two most abundant fish species with croaker at 26% and spot at 19%. This model is prone to hang on the bumper rails of the vessel's sides and can damage or destroy the tailbag or BRD.

Lake Arthur

The Lake Arthur BRD did not certify where it was installed with a 34.2% weakfish reduction by number. Reduction of Spanish mackerel was 100% but only 1 was caught in all the tows and so that data is not reliable. Shrimp loss was fairly substantial at 9.5%. In an unexpected occurrence, both croaker and spot increased in the Lake Arthur at 18.8% and 4.8% respectively. Since only 6 subsample tows were made during this testing, that could account for the

increase where a decrease should normally be expected. This model, much like the Fish Slot II, is prone to hang on the bumper railings of the vessel during haul-back.

Kelly/Girourard Grid

The Kelly/Girourard Grid had almost a 35% reduction of weakfish by number, but was still short of the 40% needed for certification. Reduction of Spanish mackerel was good at 80%, but again the small number, of only 15 in the control and 3 in the K/G Grid, was not really enough to be sure what it would do on a long-term basis. However, 15 Spanish is far more than would normally be caught in the control, and so the reduction of Spanish alone could possibly be used as a basis for certification, or further testing.

Shrimp loss was significant with this BRD at over 9%. This BRD also gave the same unexpected result as the Lake Arthur. During the 5 subsample tests the weight increased for croaker at 11% and spot at 21%. Obviously this should not be occurring since the reduction of both weakfish and Spanish was a significant amount. The relatively small number of tows (5) where a total subsample was taken could account for the increases in croaker and spot.

With the K/G Grid installed so close to the accelerator funnel of the TED some finfish may not be excluded since the bottom of the tailbag is so far from the release point. The K/G Grid did not present a problem hanging up on the bumper rails like the other two devices.

Sportfish Bycatch

Spanish mackerel do not show as a significant part of the bycatch in Pamlico Sound. With 108 tows completed, only 26 Spanish mackerel were caught. Speckled trout are also insignificant in the bycatch with only 3 caught. No red drum were caught in any tows.

RECOMMENDATIONS

The Fish Slot II is not recommended since it did not certify, and was substantially below the needed 40% for weakfish. Changing the placement in the tailbag could make a significant enough difference that the Fish Slot II might certify. This BRD apparently works well in some states, but did not do very good in Pamlico Sound.

While the concept of the Lake Arthur is very simple, and apparently has worked well at excluding menhaden in western Louisiana, it did not do good

enough to certify or be recommended. Changing the placement in the tailbag could fine-tune this BRD so that it might certify. The almost 10% loss of shrimp would be a problem unless that can be lowered. If changed to a different tailbag location, it could conceivably certify.

The Kelly/Girourard Grid worked without any hang-ups, but did not have enough reduction of weakfish to certify. It was reasonably close, and since it had an 80% reduction on Spanish mackerel, further fine-tuning could find a way to certify it. This BRD is recommended for further testing to see whether the reduction of Spanish mackerel remains constant and the reduction of weakfish can be increased to 40%. The loss of over 9% of shrimp needs to be lowered to receive good acceptance by industry even if the K/G Grid could certify.

Our testing took three devices that have worked well in the Gulf of Mexico and none of them did well enough to certify here in North Carolina. Differences in water clarity, bottom conditions, types of finfish encountered and even the species of shrimp being sought can make significant differences from one state to another. The only way to be sure what any BRD will do in a particular state is to test and see what the results finally turn out to be.

Shrimp trawling will constantly be faced with the need to reduce unwanted bycatch to help preserve as many finfish as possible. While there are no scientific studies available to determine what percentage of finfish die from natural mortality before maturity, everyone can agree that dead fish from trawling looks wasteful even if the effect may be negligible.

At the same time, government must not make it impossible, by over-regulation of bycatch reduction requirements, for the shrimp trawling industry to catch enough shrimp to be economically feasible. What we must work together to achieve is maximum bycatch reduction with minimum loss of shrimp.

Lowering bycatch is not just a good conservation measure, but also makes trawling more efficient and saves time, money, fuel, and effort. While we may never reach 100% bycatch reduction, the only way to improve is to continue to invent, test, and modify as much as humanly possible.

TABLE 1. Total catch weights and reduction for 38 tows with Fish Slot II, tested in western Pamlico Sound, North Carolina, Summer 2000.

	Total Number		Percent	
	Control	Fish Slot II	Difference	
***n=38				
WEAKFISH	1770	1280	-27.7%	
SPANISH MACKEREL	7	0	-100.0%	
SPECKLED TROUT	0	0		

	Total Weight (kg)		Percent		P(T<=t)
	Control	Fish Slot II	Difference		
SHRIMP	283.41	267.73	-5.5%	8.26E-03*	
Summer Shrimp	283.41	267.73	-5.5%		
SOUTHERN FLOUNDER**	4.98	4.27	-14.3%		
sublegal-und 330 mm**	4.98	4.27	-14.3%		
SPOT**	113.18	91.36	-19.3%	6.56E-02	
ATLANTIC CROAKER**	96.82	71.36	-26.3%	6.33E-03*	
WEAKFISH	83.68	58.68	-29.9%	2.52E-08*	
SPANISH MACKEREL	0.40	0.00	-100.0%	1.64E-02*	
ATLANTIC MENHADEN**	0.91	0.80	-12.5%		
PIGFISH**	2.80	2.18	-22.0%		
INSHORE LIZARDFISH**	1.00	1.00	0.0%		
SOUTHERN KINGFISH**	0.68	0.00	-100.0%		
BLACK DRUM**	0.13	0.00	-100.0%		
CRABS & OTHER INVERTEBRATES**	43.18	42.50	-1.6%		
JELLYFISH**	9.77	8.41	-14.0%		
Total Finfish + Subsample	304.57	229.65	-24.6%		
Total Weight + Subsample	640.94	548.29	-14.5%		

***all tows conducted during the daytime

**subsample weights only for 13 tows

*Significant difference at the p<=.05 level or less

Figure 4. Total catch weights for 38 tows with the Fish Slot II, tested in western Pamlico Sound, North Carolina, Summer 2000.

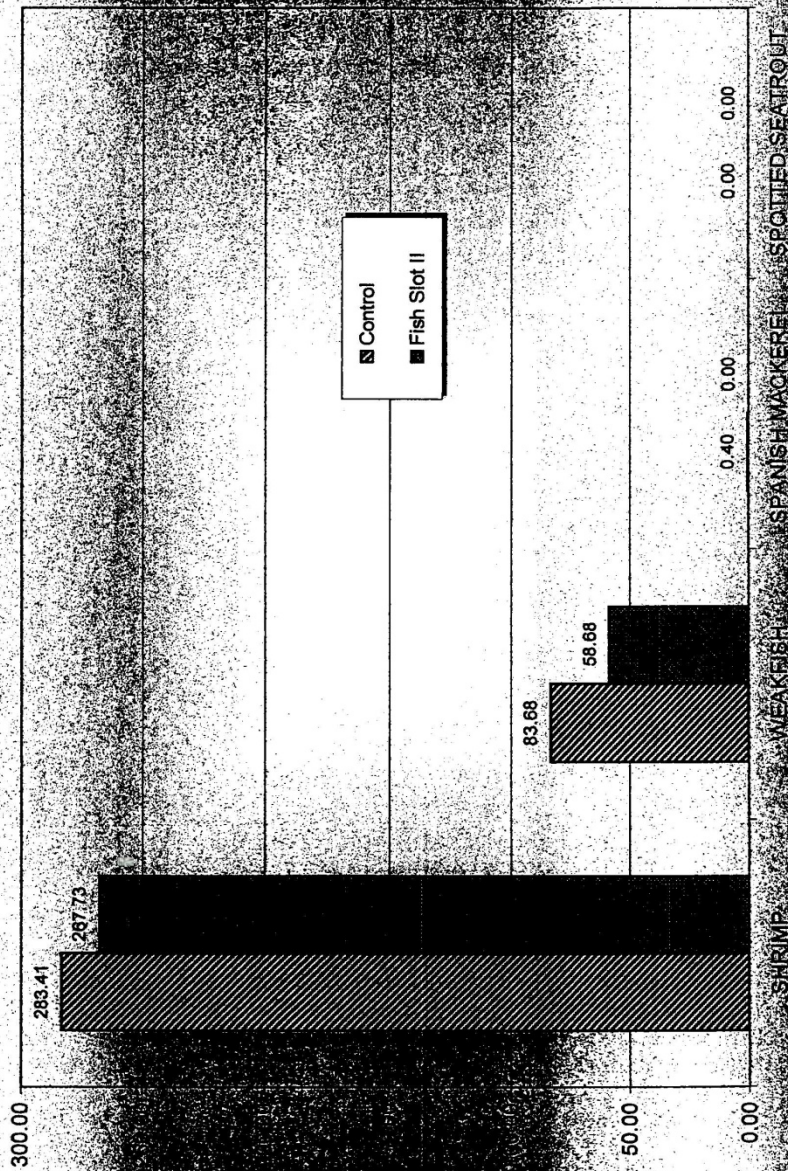
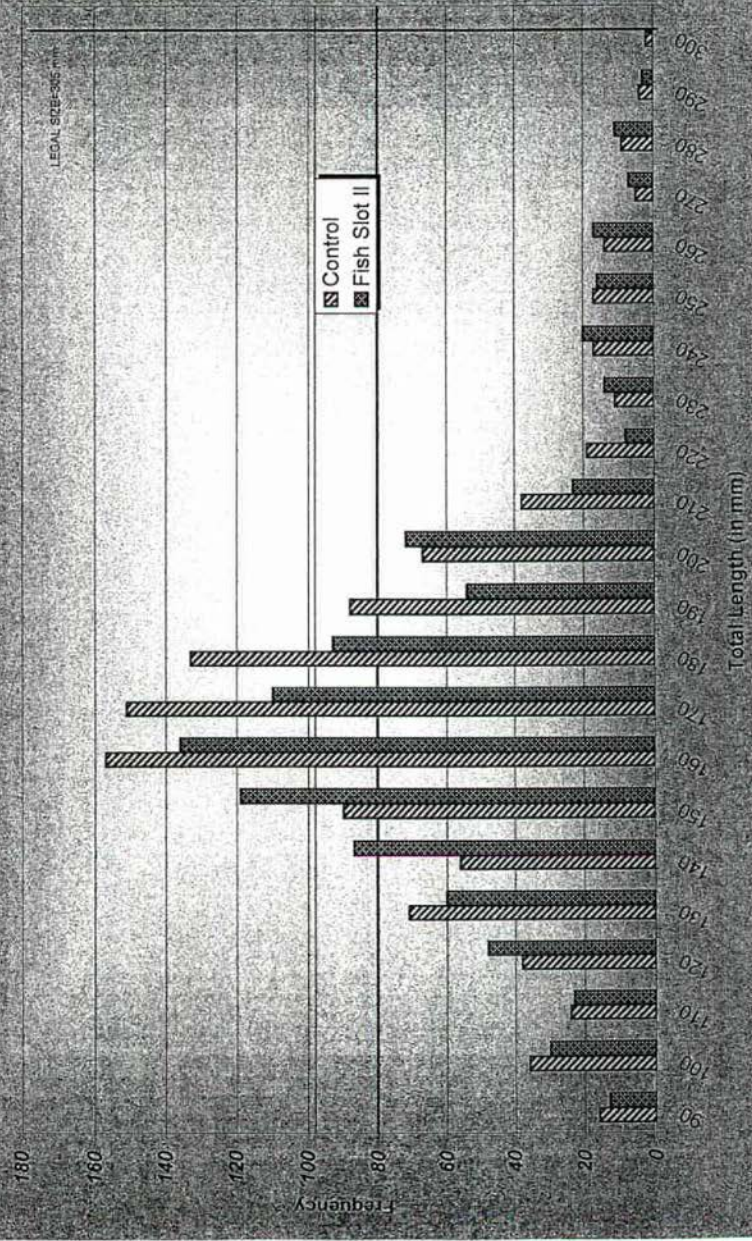


Figure 5. Length Frequency of Weakfish + Fish Slot II for 38 tows tested in western Pamlico Sound, summer 2000.



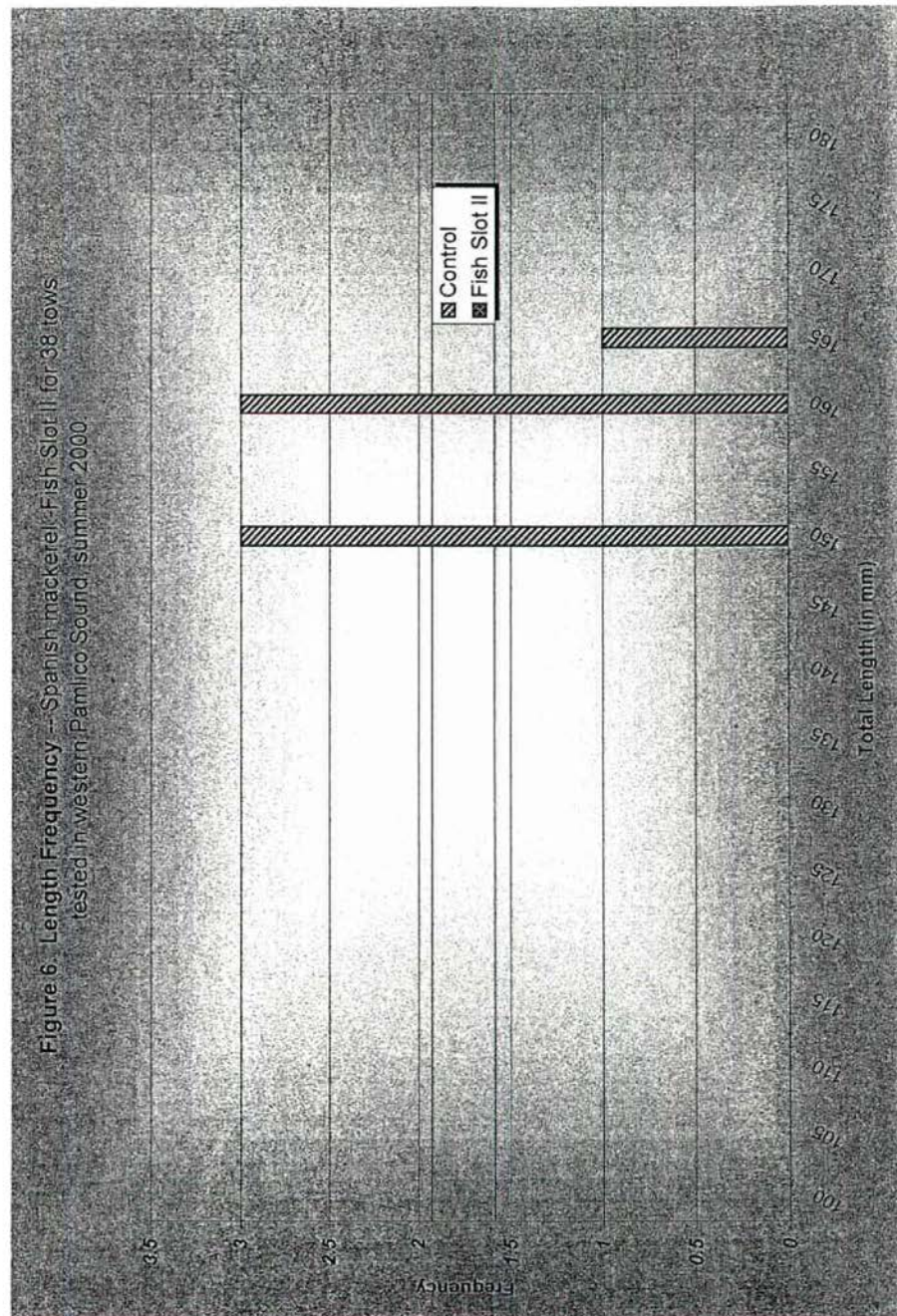


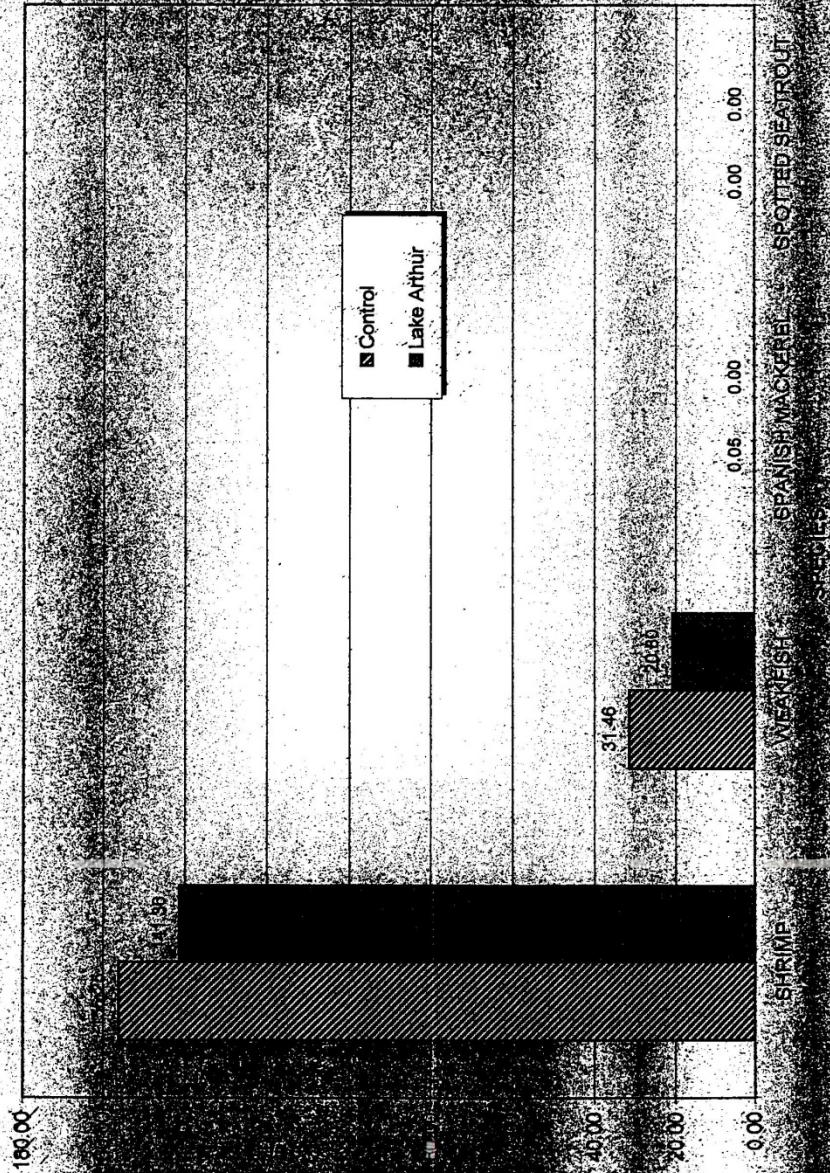
TABLE 2. Total catch weights and reduction for 34 tows with Lake Arthur BRD, tested in western Pamlico Sound, North Carolina, Summer 2001.

	Total Number		Percent Difference	
	Control	Lake Arthur		
***n=34				
WEAKFISH	199	131	-34.2%	
SPANISH MACKEREL	1	0	-100.0%	
SPECKLED TROUT	0	0		

	Total Weight (kg)		Percent Difference	P(T<=t)
	Control	Lake Arthur		
SHRIMP	156.25	141.36	-9.5%	6.25E-04*
Summer Shrimp	156.25	141.36	-9.5%	
SOUTHERN FLOUNDER**	0.91	0.00	-100.0%	
sublegal-und 330 mm**	0.91	0.00	-100.0%	
SPOT**	47.73	50.00	4.8%	8.13E-01
ATLANTIC CROAKER**	38.64	45.91	18.8%	3.61E-01
WEAKFISH	31.46	20.80	-33.9%	5.92E-05*
SPANISH MACKEREL	0.05	0.00	-100.0%	3.24E-01
CRABS & OTHER INVERTEBRATES**	3.86	3.64	-5.9%	
JELLYFISH**	26.36	22.73	-13.8%	
Total Finfish + Subsample	118.78	116.71	-1.7%	
Total Weight + Subsample	305.26	284.44	-6.8%	

***all tows conducted during the daytime
 **subsample weights 6 tows only
 *Significant difference at the p<=.05 level or less

Figure 7. Total catch weights for 34 tows with the Lake Arthur BRD, tested in western Pamlico Sound, North Carolina, Summer 2001.



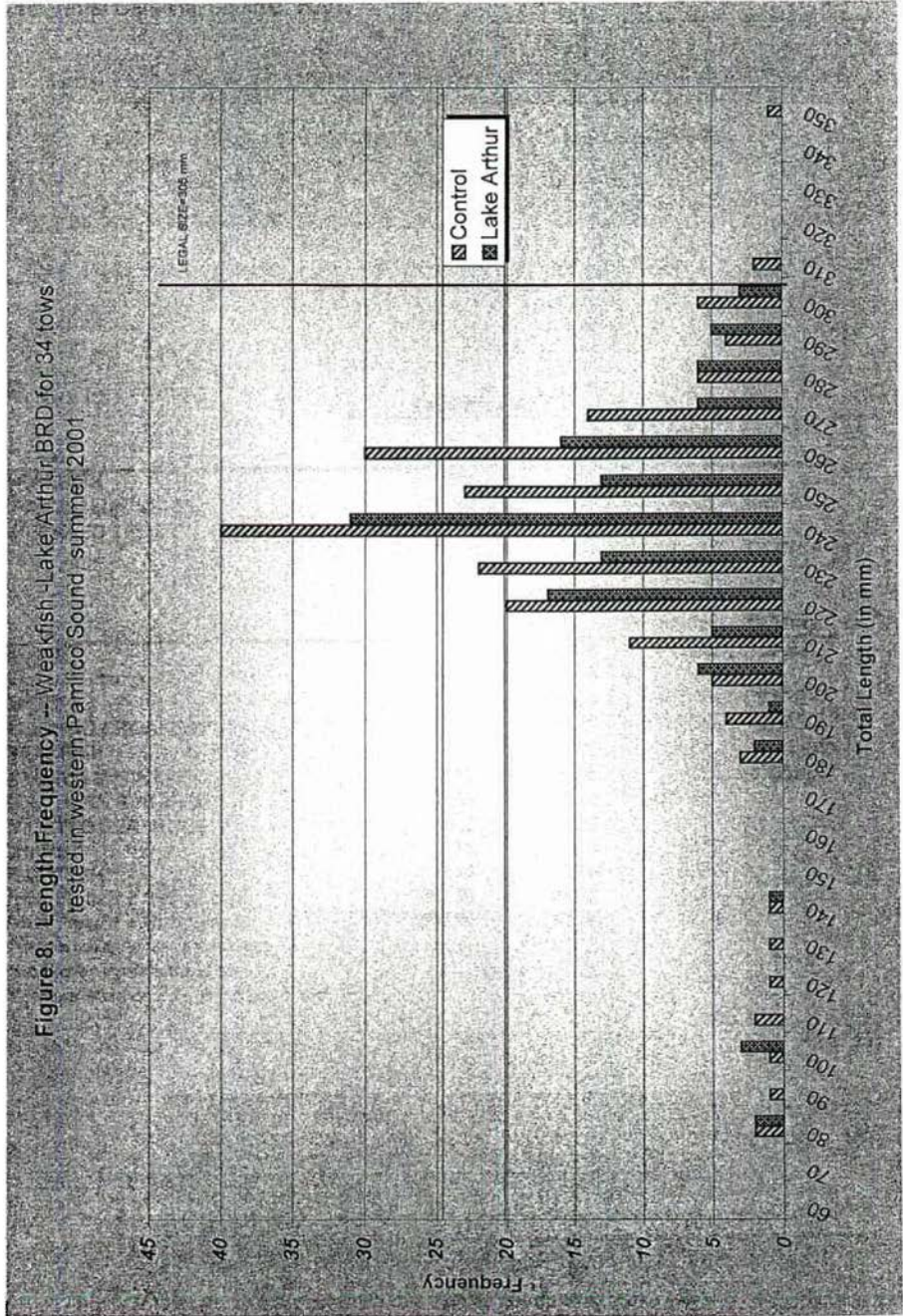


TABLE 3. Total catch weights and reduction for 36 tows with Kelly/Girourard Grid, tested in western Pamlico Sound, North Carolina, Summer 2001.

	Total Number		Percent Difference	
	Control	K/G Grid		
***n=36				
WEAKFISH	479	313	-34.7%	
SPANISH MACKEREL	15	3	-80.0%	
SPECKLED TROUT	2	1	-50.0%	

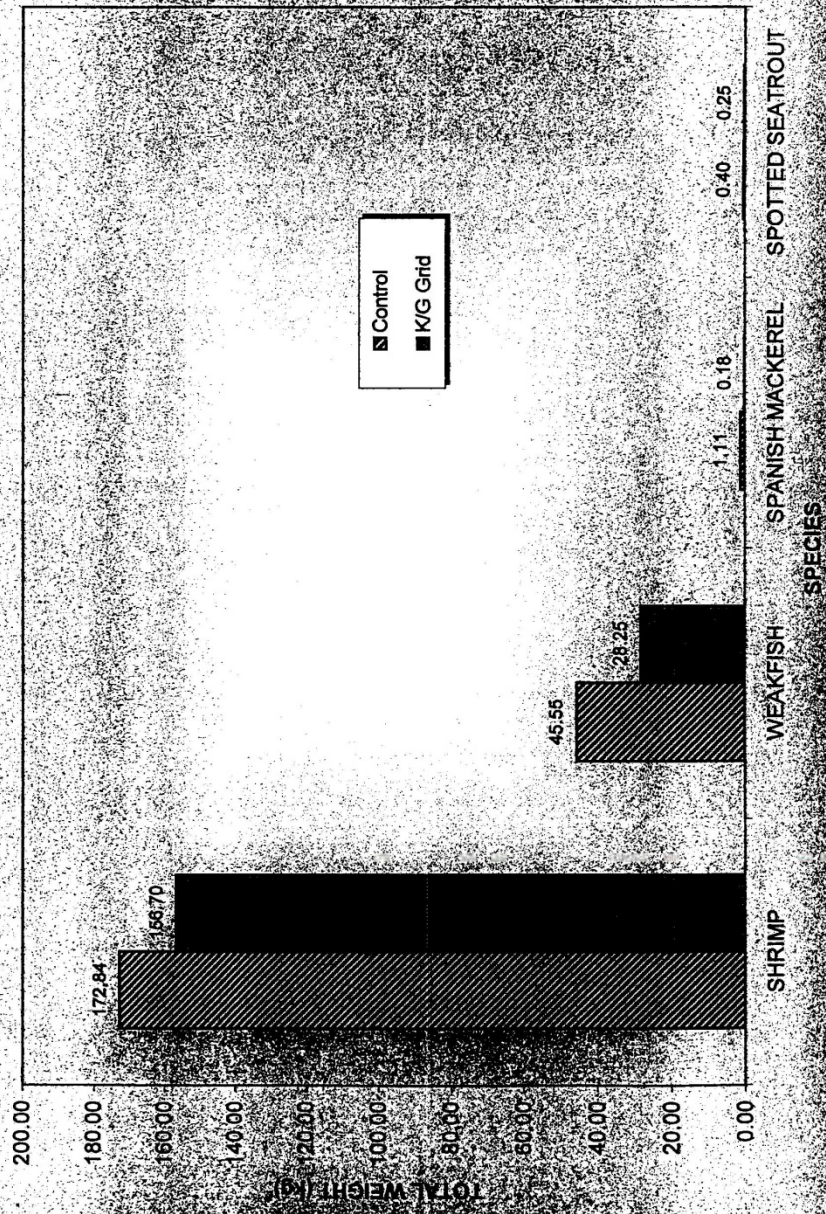
	Total Weight (kg)		Percent Difference	P(T<=t)
	Control	K/G Grid		
SHRIMP	172.84	156.70	-9.3%	1.24E-03*
Summer Shrimp	172.84	156.70	-9.3%	
SPOT**	25.91	31.36	21.1%	5.81E-01
ATLANTIC CROAKER**	31.82	35.45	11.4%	3.74E-01
WEAKFISH	45.55	28.25	-38.0%	1.06E-09*
SPANISH MACKEREL	1.11	0.18	-84.2%	8.82E-03*
SOUTHERN KINGFISH**	0.08	0.00	-100.0%	
SPOTTED SEATROUT	0.40	0.25		
CRABS**	2.73	2.73	0.0%	
JELLYFISH**	0.45	0.45	0.0%	
Total Finfish + Subsample	104.86	95.49	-8.9%	
Total Weight + Subsample	280.89	255.37	-9.1%	

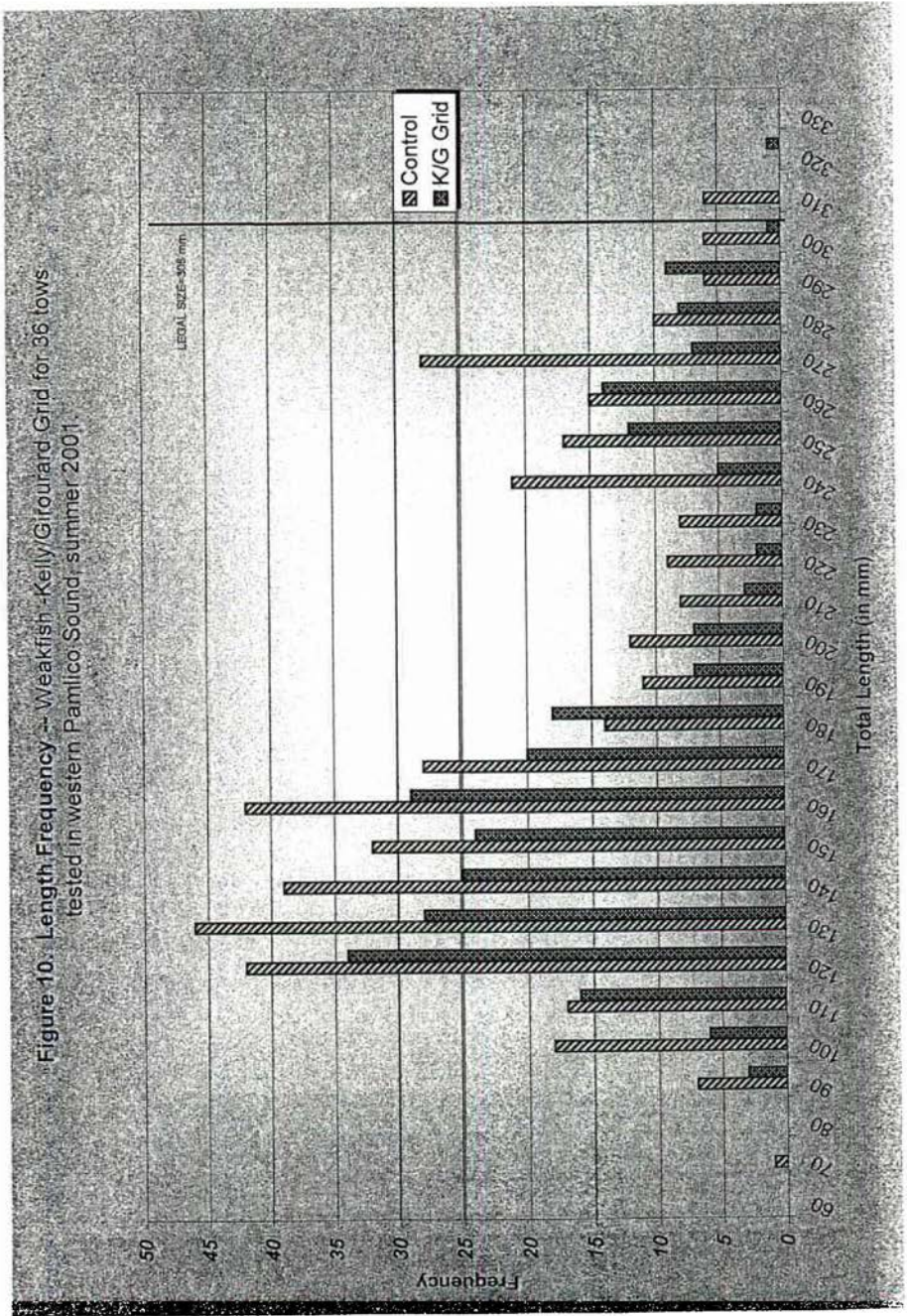
***all tows conducted during the daytime

**subsample weights for 5 tows only

*Significant difference at the p<=.05 level or less

Figure 9. Total catch weights for 36 tows with the Kelly/Girouard Grid, tested in western Pamlico Sound, North Carolina, Summer 2001





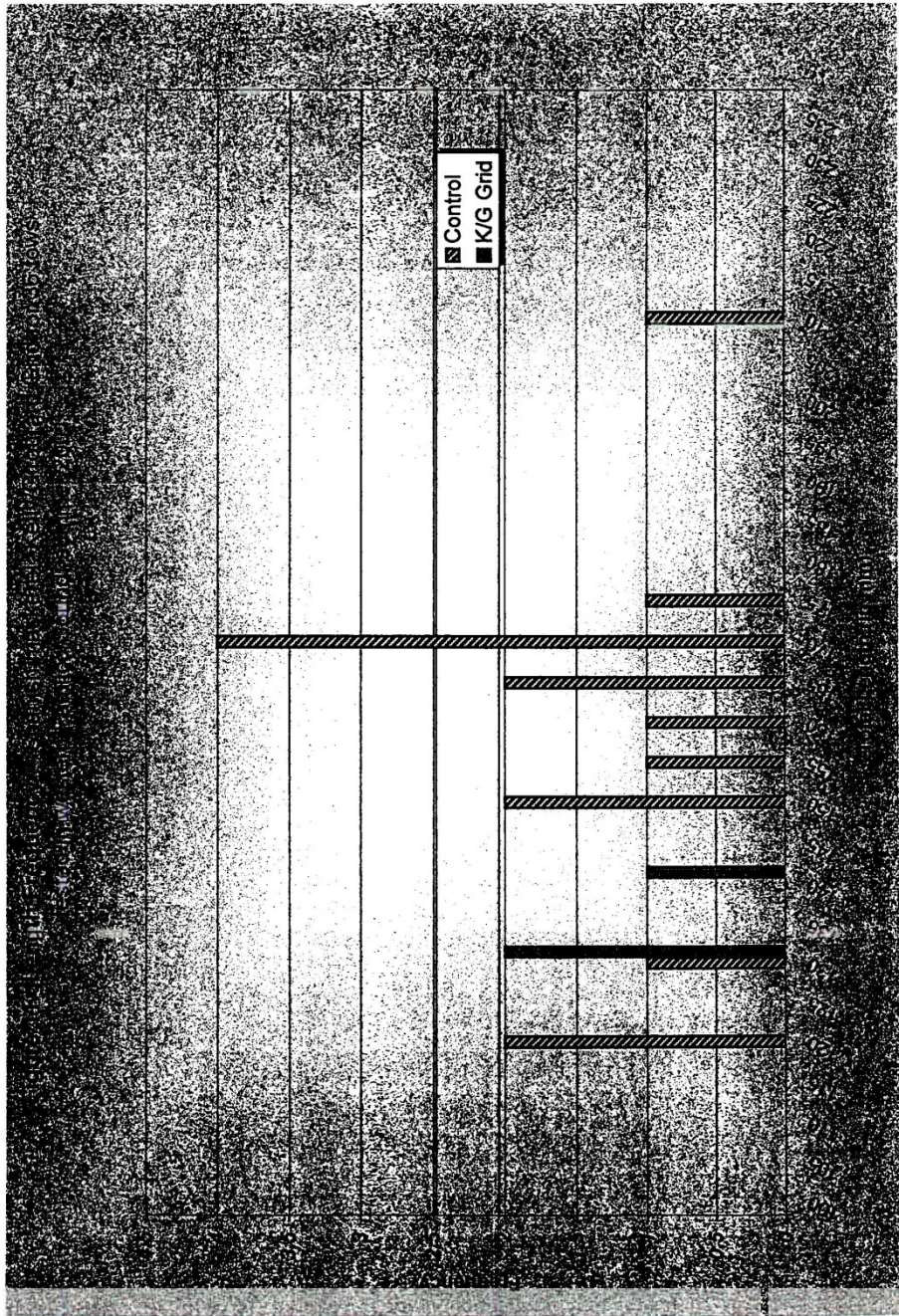


Table 4. Average weight and average length of finfish for 38 tows with the Fish Slot II, tested in western Pamlico Sound, summer, 2000.

	Weakfish		Speckled Trout		Spanish Mackerel	
	Control	Fish Slot II	Control	Fish Slot II	Control	Fish Slot II
Ave. LT.	169	167	0	0	156	0
Agg. WT.	57925	45940	0	0	400	0
Ave. WT.	54	48	0	0	57	0

Table 5. Average length and average weight of finfish for 34 tows with the Lake Arthur BRD, tested in western Pamlico Sound, Summer, 2001.

	Weakfish		Speckled Trout		Spanish mackerel	
	Control	Lake Arthur	Control	Lake Arthur	Control	Lake Arthur
Ave. LT.	237	234	0	0	100	0
Agg. WT.	31460	20800	0	0	50	0
Ave. WT..	157	160	0	0	50	0

Table 6. Average length and average weight of finfish for 36 tows with the Kelly/Girouard Grid tested in western Pamlico Sound, summer, 2001.

	WEAKFISH		Speckled Trout		Spanish Mackerel	
	CONTROL	K/G GRID	Control	K/G GRID	Control	K/G GRID
Ave. LT.	177	171	180	110	159	133
Agg. WT.	43150	26925	425	25	1000	175
Ave. WT.	97	96	213	25	67	58

REFERENCES

- Cunningham, P., R. Curry, R. Pratt, S. Stichter, K. West, L. Mercer, P. Phalen, S. Sherman, B. Burns, and S. Winslow. 1992. Watershed planning in the Albemarle-Pamlico estuarine system: fishing practices mapping. Albemarle Pamlico Estuarine Study Rep. No. 92-05.
- Faulkner, Greg. April, 1999. BRD's of Paradise, National Fisherman, Vol. 79, No. 12, Diversified Business Communications, Portland, Maine.
- Knopf, A. 1983. The Audobon Society Field Guide to North American Fishes, Whales, and Dolphins. Chanticleer Press, Inc., New York.
- Lupton, Owen A. 1996. Bycatch reduction in the estuarine crab trawl industry through manipulating tailbag sizes. Marine Fisheries Grant FRG-94-11, Pamlico County Schools, Bayboro, North Carolina.
- Lupton, Owen A. 1997. Bycatch reduction in the inshore shrimp trawl fishery. Marine Fisheries Grant FRG 95-15, Pamlico County Schools, Bayboro, North Carolina.
- Lupton, Owen A. 1998. Certification of Bycatch Reduction Devices for North Carolina. Marine Fisheries Grant FEG 97-40, Pamlico County Schools, Bayboro, North Carolina.
- McKenna, S., and J.T. Camp. 1992. An examination of the blue crab fishery in the Pamlico River Estuary. Albemarle-Pamlico Estuarine Study Rep. No. 92-08.
- McKenna, S., and A.H. Clark 1993. An examination of alternative fishing devices for the estuarine shrimp and crab trawl fisheries. Albemarle-Pamlico Estuarine Study Rep. No. 93-11.
- Morris, Bruce 1999. North Carolina Bycatch Reduction Device Certification. North Carolina Marine Fisheries Grant 98-FEG-23, Pamlico County Schools, Bayboro, North Carolina.
- Tyler, J. and M. McKenzie. 1969. *To Catch a Million Fish: North Carolina Commercial Fishing Gear and Methods*. North Carolina Department of Conservation and Development, Division of Commercial and Sport Fishing, Raleigh, North Carolina.



Southeast Fishery Bulletin

National Marine Fisheries Service, Southeast Regional Office, 263 13th Avenue South, St. Petersburg, FL 33701

FOR INFORMATION CONTACT:

Michael Barnette, Michael.Barnette@noaa.gov
(727) 551-5794, FAX (727) 824-5309

May 21, 2012

FB12-037

NOAA Certifies Additional Designs and Materials for Fishermen Currently Required to Use Turtle Excluder Devices

NOAA Fisheries Service announces a final rule adding allowable Turtle Excluder Device (TED) modifications and additional certified TED designs for the shrimp and summer flounder trawl fisheries. The additional designs and modifications may enhance TED effectiveness in reducing sea turtle mortality, promote catch retention, and increase vessel fuel efficiency. The allowable modifications are not mandatory, but provide additional options for fishermen currently required to utilize TEDs.

Provisions of the rule include:

- VI. The addition of flat bar, box pipe, and oval pipe as construction material in currently-approved TED grids.
- VII. An increase in the maximum mesh size on TED escape flaps from 1-5/8 to 2 inches (4.1 to 5.1 cm).
- VIII. The addition of the Boone Big Boy TED and Boone Wedge Cut TED escape opening for use in the shrimp fishery.
- IX. The addition of three large TED escape openings.
- X. The addition of a brace bar as an allowable modification to hard TEDs.
- XI. The addition of the Chauvin Shrimp Deflector to improve shrimp retention.
- XII. The addition of a new TED for use in the summer flounder fishery.

There is also a correction to the TED regulations to rectify an oversight regarding the maximum size chain that can be used on the Parker TED escape opening flap.

NOTE: This final rule is not related to the proposed rule published in the *Federal Register* on May 10, 2012, that would, if implemented, require all skimmer trawls, pusher-head trawls, and wing nets (butterfly trawls) to use TEDs in their nets.

TEDs incorporate an escape opening, usually covered by a webbing flap, which allows sea turtles to escape from trawl nets. To be approved by NOAA Fisheries, a TED design must be shown to be 97 percent effective in excluding sea turtles during testing based upon specific testing protocols.

These latest modifications were developed in coordination with the commercial trawl industry, the Southeast Fisheries Science Center, and the Southeast Regional Office's Protected Resources Division. The modifications and TED designs were developed and tested by NOAA Fisheries gear specialists. Results from a study conducted by the Gulf and South Atlantic Fisheries Foundation were utilized in the development of these allowable modifications.

If you would like to receive these fishery bulletins via e-mail as soon as they are published, e-mail us at: SERO.Communications.Comments@noaa.gov . You will still receive a hard copy of these bulletins through the mail.

This bulletin provides only a summary of the information regarding the existing regulations. Any discrepancies between this bulletin and the regulations as published in the *Federal Register* will be resolved in favor of the *Federal Register*.

RULEMAKING UPDATE



ROY COOPER
Governor

MICHAEL S. REGAN
Secretary

STEPHEN W. MURPHEY
Director

January 24, 2020

MEMORANDUM

TO: N.C. Marine Fisheries Commission

FROM: Catherine Blum, Fishery Management Plan and Rulemaking Coordinator
Fisheries Management Section

SUBJECT: Rulemaking Update

Issues

Provide an update to the Marine Fisheries Commission (MFC) on the status of rulemaking and request the MFC vote on the final readoption of two rules. The MFC will also have the opportunity to vote on its preferred management option for the Shrimp Fishery Management Plan (FMP) Amendment 1 Special Secondary Nursery Area (SSNA) issue paper.

Findings

- 2019/2020 Rulemaking Cycle – Final Adoption of Rules
 - At its August 2019 meeting, the MFC approved the fiscal analysis and notice of text for rulemaking to begin the readoption process for 15A NCAC 03M .0509 (Tarpon) and 03O .0108 (License and Commercial Fishing Vessel Registration) per G.S. 150B-21.3A.
 - The proposed rules were published in the *N.C. Register* Oct. 1, 2019. The public comment period was from Oct. 16 through Dec. 2, 2019. A public hearing was held in Morehead City Oct. 23.
 - Per G.S. 150B-21.2, prior to final readoption the MFC must consider fully all written and oral comments received.
 - The division received 35 public comments on the proposed rules. One email was not in support of the license rule change. Thirty-four public comments were received about the tarpon rule change: four oral comments in support; 23 emails in support, six not in support, and one with mixed comments.
- 2020/2021 Rulemaking Cycle – Select Preferred Management Option
 - In February 2015, the MFC adopted the Shrimp FMP Amendment 1 and its rules. The focus of Amendment 1 was to address bycatch in the commercial and recreational shrimp fishery.
 - Amendment 1 included a recommendation by the MFC for its Habitat and Water Quality Advisory Committee to provide input on changing certain SSNAs that have not been opened to trawling since 1991 to permanent Secondary Nursery Areas.
 - In 2016 and 2019, petitions for rulemaking were submitted that potentially overlapped with this issue. Both petitions have been resolved.
 - Division staff drafted the Shrimp FMP Amendment 1 SSNA issue paper and obtained input from the advisory committee, as directed.

Action Needed

The MFC is scheduled to vote on the final readoption of 15A NCAC 03M .0509 and 03O .0108 and has the opportunity to vote to select its preferred management option for the Shrimp FMP Amendment 1 SSNA issue paper.

Recommendation

Staff recommends the MFC vote on the final readoption of 15A NCAC 03M .0509 and 03O .0108. Staff requests the MFC vote to select its preferred management option for the Shrimp FMP Amendment 1 SSNA issue paper, to facilitate the rulemaking process. For a copy of the supporting documents, including rules, public comments, and the SSNA issue paper, see the [Rulemaking](#) section of the briefing materials.

Rulemaking Update

15A NCAC 03 - Marine Fisheries

2019-2020 Rulemaking Cycle

Overview of Public Comments Received

At its August 2019 meeting, the MFC approved the fiscal analysis and notice of text for rulemaking to begin the readoption process for the second of four packages of rules in 15A NCAC 03. A handout showing the steps in the [MFC's 2019-2020 annual rulemaking cycle](#) is included in the briefing materials. This package includes two proposed rules for readoption: 15A NCAC 03M .0509, Tarpon, and 15A NCAC 03O .0108, License and Commercial Fishing Vessel Registration Transfers. A [copy of the rules](#) as published Oct. 1, 2019 in the *N.C. Register* is included in the briefing materials. The public comment period was from Oct. 16 to Dec. 2, 2019 and a public hearing was held Oct. 23 in Morehead City. The division received 35 public comments on the proposed rules. A [copy of the emailed comments](#) and [a summary of the public hearing](#) is included in the briefing materials. One email was not in support of the license rule change. Thirty-four public comments were received about the tarpon rule change: four oral comments in support; 23 emails in support, six not in support, and one with mixed comments.

MFC Vote on Final Approval of Rules

The MFC is scheduled to vote on the final readoption of 15A NCAC 03M .0509 and 03O .0108. Per G.S. 150B-21.2, prior to final readoption the MFC must consider fully all written and oral comments received. If the MFC approves the final readoption of the rules as published, the rules will be submitted to the Rules Review Commission for approval. The proposed effective date of the rules is subject to legislative review per S.L. 2019-198 and G.S. 14-4.1.

2020-2021 Rulemaking Cycle

Shrimp FMP Amendment 1 Special Secondary Nursery Area Issue Paper

In February 2015, the MFC adopted the Shrimp FMP Amendment 1 and its rules. The focus of Amendment 1 was to address bycatch in the commercial and recreational shrimp fishery. Amendment 1 included a recommendation by the MFC for its Habitat and Water Quality Advisory Committee to provide input on changing certain Special Secondary Nursery Areas (SSNAs) that have not been opened to trawling since 1991 to permanent Secondary Nursery Areas. In 2016 and 2019, petitions for rulemaking were submitted that potentially overlapped with this issue. Both petitions have been resolved. Division staff drafted the Shrimp FMP Amendment 1 SSNA issue paper and obtained input from the advisory committee, as directed. A copy of the [SSNA issue paper](#) is included in the briefing materials. Staff will give a presentation to the MFC at the February commission meeting. Staff requests the MFC vote to select its preferred management option for the issue, to facilitate the rulemaking process and the required fiscal analysis of proposed rule changes.

Oyster Sanctuary Rule Change Issue Paper Update

The Division of Marine Fisheries Oyster Sanctuary Program is responsible for creating artificial reef habitat, designed to support healthy and abundant oyster populations throughout Pamlico Sound and its tributaries. Background on the program is provided in the [oyster sanctuary issue paper](#) in the briefing materials. Once built, a reef site is protected from harvest by rule or proclamation to preserve broodstock and is called an “oyster sanctuary.” With healthy and abundant broodstock populations inside sanctuary boundaries, these sites serve their intended function by supplying oyster larvae to other reefs nearby.

Division staff propose amendments to the current oyster sanctuary rule that would add the boundaries of five additional sanctuaries (Long Shoal, Little Creek, Pea Island, Raccoon Island, and Swan Island) to rule. These sanctuaries are serving their intended function and can now be moved from the protection of proclamation to permanent rule. Additional proposed amendments would update boundaries for three existing sanctuaries

(Neuse River, West Bluff, and Gibbs Shoal). Side-scan imagery revealed these sanctuaries have material slightly outside of their permitted boundaries. This is likely due to construction error or slight movement during material settlement. To prevent this error from occurring during future development, the division recommends establishing a 100-foot buffer of no development for reef construction. Proposed changes to the rule also include removing the boundaries of two sanctuaries (Ocracoke and Clam Shoal) that are not serving their intended function. While these two areas do not sustain high population densities of adult oysters, they continue to provide valuable habitat and would be managed as artificial reefs.

Overall, the proposed rule changes would align the rule with the current status of the state's oyster sanctuaries and comply with the principles of rulemaking in G.S. 150B. The oyster sanctuary issue paper is provided as information to the MFC; no action is needed to begin the rulemaking process until the MFC's May 2020 meeting.

15A NCAC 18A - Sanitation

Readoption Schedule Update

The process of rule readoption for MFC rules in 15A NCAC 18A is scheduled to begin at the MFC’s May 2020 business meeting. Given the large number of rules subject to readoption, the wide variety of issues regulated by these rules, and the generally controversial nature of the rules, this will be the first of several years to readopt rules. In preparation for the May meeting, staff recommended a four-year readoption schedule for the rules of June 30, 2024. At its November 2019 meeting, the MFC approved the staff recommendation. MFC Chairman Rob Bizzell sent a [letter](#) to the Rules Review Commission Chairman Jeffery T. Hyde asking for the schedule to be approved. On Jan. 16, 2020, the Rules Review Commission approved the readoption schedule. The MFC is now ready to begin the rule readoption process at its May 2020 business meeting.

Background Information

Periodic Review and Expiration of Existing Rules per G.S. 150B-21.3A

Session Law 2013-413, the Regulatory Reform Act of 2013, implemented requirements known as the “Periodic Review and Expiration of Existing Rules.” These requirements are codified in a new section of Article 2A of Chapter 150B of the General Statutes in G.S. 150B-21.3A. Under the requirements, each agency is responsible for conducting a review of all its rules at least once every 10 years in accordance with a prescribed process.

The review has two parts. The first is a report phase, which has concluded, followed by the readoption of rules. An evaluation of the rules under the authority of the MFC was undertaken in two lots (see Figure 1.) The MFC has 211 rules in Chapter 03 (Marine Fisheries), of which 172 are subject to readoption, and 164 rules in Chapter 18, Subchapter 18A (Sanitation) that are also subject to readoption. The MFC is the body with the authority for the approval steps prescribed in the process.

Rules	2017	2018	2019	2020	2021	2022	2023	2024
Chapter 03 (172 rules)	Report	41 Rules Readopted	Rule Readoption (131)			6/30/22 deadline		
Subchapter 18A (164 rules)			Report	Rule Readoption (164)				6/30/24 deadline

Figure 1. Marine Fisheries Commission rule readoption schedule to comply with G.S. 150B-21.3A, Periodic Review and Expiration of Existing Rules.

N.C. Marine Fisheries Commission 2019-2020 Annual Rulemaking Cycle

February 2020

Time of Year	Action
April-July 2019	Fiscal analysis of rules prepared by DMF staff and approved by Office of State Budget and Management
August 2019	MFC approved Notice of Text for Rulemaking
Oct. 1, 2019	Publication of proposed rules in the <i>North Carolina Register</i>
Oct. 16-Dec. 2, 2019	Public comment period held
Wednesday, Oct. 23, 2019	Public hearing held: 6 p.m., Division of Marine Fisheries, 5285 Highway 70 West, Morehead City, NC 28557
February 2020	MFC considers approval of permanent rules
April 2020	Rules reviewed by Office of Administrative Hearings Rules Review Commission.
TBD	Proposed effective date of rules is subject to legislative review per S.L. 2019-198 and G.S. 14-4.1.

NORTH CAROLINA REGISTER

VOLUME 34 • ISSUE 07 • Pages 529 – 709

October 1, 2019

I. EXECUTIVE ORDERS	
Executive Order No. 100	529 – 532
Executive Order No. 101	533 – 534
Executive Order No. 102	535 – 538
Executive Order No. 103	539 – 541
Executive Order No. 104	542 – 543
Executive Order No. 105	544 – 546
II. PROPOSED RULES	
Natural and Cultural Resources, Department of	
Department.....	547
Health and Human Services, Department of	
Department.....	547 – 548
Environmental Quality, Department of	
Marine Fisheries Commission	548 – 551
Wildlife Resources Commission.....	551 – 552
Occupational Licensing Boards and Commissions	
Cemetery Commission.....	553
Recreational Therapy Licensure, Board of	553 – 556
III. APPROVED RULES.....	557 – 698
State Board of Elections	
Board	
Health and Human Services, Department of	
Social Services Commission	
Insurance, Department of	
Department	
Public Safety, Department of	
Alcoholic Beverage Control Commission	
Alarm Systems Licensing Board	
Environmental Quality, Department of	
Environmental Management Commission	
Coastal Resources Commission	
Occupational Licensing Boards and Commissions	
Architecture, Board of	
General Contractors, Licensing Board for	
Electrolysis Examiners, Board of	
State Human Resources, Office of	
State Human Resources Commission	
IV. RULES REVIEW COMMISSION	699 – 706
V. CONTESTED CASE DECISIONS	
Index to ALJ Decisions	707 – 709

Contact List for Rulemaking Questions or Concerns

For questions or concerns regarding the Administrative Procedure Act or any of its components, consult with the agencies below. The bolded headings are typical issues which the given agency can address, but are not inclusive.

Rule Notices, Filings, Register, Deadlines, Copies of Proposed Rules, etc.

Office of Administrative Hearings

Rules Division

1711 New Hope Church Road

(919) 431-3000

Raleigh, North Carolina 27609

(919) 431-3104 FAX

contact: Molly Masich, Codifier of Rules	molly.masich@oah.nc.gov	(919) 431-3071
Dana McGhee, Publications Coordinator	dana.mcgee@oah.nc.gov	(919) 431-3075
Lindsay Silvester, Editorial Assistant	lindsay.silvester@oah.nc.gov	(919) 431-3078
Cathy Matthews-Thayer, Editorial Assistant	cathy.thayer@oah.nc.gov	(919) 431-3006

Rule Review and Legal Issues

Rules Review Commission

1711 New Hope Church Road

(919) 431-3000

Raleigh, North Carolina 27609

(919) 431-3104 FAX

contact: Amber Cronk May, Commission Counsel	amber.may@oah.nc.gov	(919) 431-3074
Amanda Reeder, Commission Counsel	amanda.reeder@oah.nc.gov	(919) 431-3079
Ashley Snyder, Commission Counsel	ashley.snyder@oah.nc.gov	(919) 431-3081
Alexander Burgos, Paralegal	alexander.burgos@oah.nc.gov	(919) 431-3080
Julie Brincefield, Administrative Assistant	julie.brincefield@oah.nc.gov	(919) 431-3073

Fiscal Notes & Economic Analysis

Office of State Budget and Management

116 West Jones Street

(919) 807-4700

Raleigh, North Carolina 27603-8005

(919) 733-0640 FAX

Contact: Carrie Hollis, Economic Analyst

osbmruleanalysis@osbm.nc.gov (919) 807-4757

NC Association of County Commissioners

215 North Dawson Street

(919) 715-2893

Raleigh, North Carolina 27603

contact: Amy Bason

amy.bason@ncacc.org

NC League of Municipalities

(919) 715-4000

150 Fayetteville Street, Suite 300

Raleigh, North Carolina 27601

contact: Sarah Collins

scollins@nclm.org

Legislative Process Concerning Rule-making

545 Legislative Office Building

300 North Salisbury Street

(919) 733-2578

Raleigh, North Carolina 27611

(919) 715-5460 FAX

Jason Moran-Bates, Staff Attorney

Jeremy Ray, Staff Attorney

NORTH CAROLINA REGISTER
 Publication Schedule for January 2019 – December 2019

FILING DEADLINES			NOTICE OF TEXT		PERMANENT RULE			TEMPORARY RULES
Volume & issue number	Issue date	Last day for filing	Earliest date for public hearing	End of required comment Period	Deadline to submit to RRC for review at next meeting	RRC Meeting Date	Earliest Eff. Date of Permanent Rule	270 th day from publication in the Register
33:13	01/02/19	12/06/18	01/17/19	03/04/19	03/20/19	04/18/19	05/01/19	09/29/19
33:14	01/15/19	12/19/18	01/30/19	03/18/19	03/20/19	04/18/19	05/01/19	10/12/19
33:15	02/01/19	01/10/19	02/16/19	04/02/19	04/22/19	05/16/19	06/01/19	10/29/19
33:16	02/15/19	01/25/19	03/02/19	04/16/19	04/22/19	05/16/19	06/01/19	11/12/19
33:17	03/01/19	02/08/19	03/16/19	04/30/19	05/20/19	06/20/19	07/01/19	11/26/19
33:18	03/15/19	02/22/19	03/30/19	05/14/19	05/20/19	06/20/19	07/01/19	12/10/19
33:19	04/01/19	03/11/19	04/16/19	05/31/19	06/20/19	07/18/19	08/01/19	12/27/19
33:20	04/15/19	03/25/19	04/30/19	06/14/19	06/20/19	07/18/19	08/01/19	01/10/20
33:21	05/01/19	04/09/19	05/16/19	07/01/19	07/22/19	08/15/19	09/01/19	01/26/20
33:22	05/15/19	04/24/19	05/30/19	07/15/19	07/22/19	08/15/19	09/01/19	02/09/20
33:23	06/03/19	05/10/19	06/18/19	08/02/19	08/20/19	09/19/19	10/01/19	02/28/20
33:24	06/17/19	05/24/19	07/02/19	08/16/19	08/20/19	09/19/19	10/01/19	03/13/20
34:01	07/01/19	06/10/19	07/16/19	08/30/19	09/20/19	10/17/19	11/01/19	03/27/20
34:02	07/15/19	06/21/19	07/30/19	09/13/19	09/20/19	10/17/19	11/01/19	04/10/20
34:03	08/01/19	07/11/19	08/16/19	09/30/19	10/21/19	11/21/19	12/01/19	04/27/20
34:04	08/15/19	07/25/19	08/30/19	10/14/19	10/21/19	11/21/19	12/01/19	05/11/20
34:05	09/03/19	08/12/19	09/18/19	11/04/19	11/20/19	12/19/19	01/01/20	05/30/20
34:06	09/16/19	08/23/19	10/01/19	11/15/19	11/20/19	12/19/19	01/01/20	06/12/20
34:07	10/01/19	09/10/19	10/16/19	12/02/19	12/20/19	01/16/20	02/01/20	06/27/20
34:08	10/15/19	09/24/19	10/30/19	12/16/19	12/20/19	01/16/20	02/01/20	07/11/20
34:09	11/01/19	10/11/19	11/16/19	12/31/19	01/21/20	02/20/20	03/01/20	07/28/20
34:10	11/15/19	10/24/19	11/30/19	01/14/20	01/21/20	02/20/20	03/01/20	08/11/20
34:11	12/02/19	11/06/19	12/17/19	01/31/20	02/20/20	03/19/20	04/01/20	08/28/20
34:12	12/16/19	11/21/19	12/31/19	02/14/20	02/20/20	03/19/20	04/01/20	09/11/20

This document is prepared by the Office of Administrative Hearings as a public service and is not to be deemed binding or controlling.

EXPLANATION OF THE PUBLICATION SCHEDULE

This Publication Schedule is prepared by the Office of Administrative Hearings as a public service and the computation of time periods are not to be deemed binding or controlling. Time is computed according to 26 NCAC 2C .0302 and the Rules of Civil Procedure, Rule 6.

GENERAL

The North Carolina Register shall be published twice a month and contains the following information submitted for publication by a state agency:

- (1) temporary rules;
- (2) text of proposed rules;
- (3) text of permanent rules approved by the Rules Review Commission;
- (4) emergency rules
- (5) Executive Orders of the Governor;
- (6) final decision letters from the U.S. Attorney General concerning changes in laws affecting voting in a jurisdiction subject of Section 5 of the Voting Rights Act of 1965, as required by G.S. 120-30.9H; and
- (7) other information the Codifier of Rules determines to be helpful to the public.

COMPUTING TIME: In computing time in the schedule, the day of publication of the North Carolina Register is not included. The last day of the period so computed is included, unless it is a Saturday, Sunday, or State holiday, in which event the period runs until the preceding day which is not a Saturday, Sunday, or State holiday.

FILING DEADLINES

ISSUE DATE: The Register is published on the first and fifteen of each month if the first or fifteenth of the month is not a Saturday, Sunday, or State holiday for employees mandated by the State Personnel Commission. If the first or fifteenth of any month is a Saturday, Sunday, or a holiday for State employees, the North Carolina Register issue for that day will be published on the day of that month after the first or fifteenth that is not a Saturday, Sunday, or holiday for State employees.

LAST DAY FOR FILING: The last day for filing for any issue is 15 days before the issue date excluding Saturdays, Sundays, and holidays for State employees.

NOTICE OF TEXT

EARLIEST DATE FOR PUBLIC HEARING: The hearing date shall be at least 15 days after the date a notice of the hearing is published.

END OF REQUIRED COMMENT PERIOD
An agency shall accept comments on the text of a proposed rule for at least 60 days after the text is published or until the date of any public hearings held on the proposed rule, whichever is longer.

DEADLINE TO SUBMIT TO THE RULES REVIEW COMMISSION: The Commission shall review a rule submitted to it on or before the twentieth of a month by the last day of the next month.

Pursuant to G.S. 150B-21.2(c)(1), the text of the rule(s) proposed for re adoption without substantive changes are not required to be published. The text of the rules are available on the OAH website: <http://reports.oah.state.nc.us/ncac.asp>.

Link to agency website pursuant to G.S. 150B-19.1(c): <https://info.ncdhhs.gov/dhsr/ruleactions.html>

Proposed Effective Date: March 1, 2020

Public Hearing:

Date: November 13, 2019

Time: 10:00 a.m.

Location: Dorothea Dix Park, Edgerton Building, Room 026, 809 Ruggles Drive, Raleigh, NC 27603

Reason for Proposed Action: Pursuant to GS 150B-21.3A, Periodic Review and Expiration of Existing Rules, all rules are reviewed at least every 10 years or they shall expire. As a result of the periodic review of Chapter 10A NCAC 15, Radiation Protection, these two proposed re adoption rules were determined as "Necessary With Substantive Public Interest," requiring re adoption. Rule 10A NCAC 15 .1102 is proposed for re adoption with substantive changes to update division and department name through technical changes and add the option for online fee payment for licensees and registrants. Rule 10A NCAC 15 .1106 is proposed for re adoption without substantive changes with no change to the text of the rule because of an amendment to this rule that became effective 5/1/19.

Comments may be submitted to: Nadine Pfeiffer, 809 Ruggles Drive, 2701 Mail Service Center, Raleigh, NC 27699-2701; email DHSR.RulesCoordinator@dhhs.nc.gov

Comment period ends: December 2, 2019

Procedure for Subjecting a Proposed Rule to Legislative Review:

If an objection is not resolved prior to the adoption of the rule, a person may also submit written objections to the Rules Review Commission after the adoption of the Rule. If the Rules Review Commission receives written and signed objections after the adoption of the Rule in accordance with G.S. 150B-21.3(b2) from 10 or more persons clearly requesting review by the legislature and the Rules Review Commission approves the rule, the rule will become effective as provided in G.S. 150B-21.3(b1). The Commission will receive written objections until 5:00 p.m. on the day following the day the Commission approves the rule. The Commission will receive those objections by mail, delivery service, hand delivery, or facsimile transmission. If you have any further questions concerning the submission of objections to the Commission, please call a Commission staff attorney at 919-431-3000.

Fiscal impact. Does any rule or combination of rules in this notice create an economic impact? Check all that apply.

- State funds affected
Local funds affected
Substantial economic impact (>= \$1,000,000)
Approved by OSBM

No fiscal note required

CHAPTER 15 - RADIATION PROTECTION

SECTION .1100 - FEES

10A NCAC 15 .1102 PAYMENT DUE

(a) All fees established in this Section shall be due on the first day of July of each year.

(b) Notwithstanding Paragraph (a) of this Rule, when a new license or registration is issued by the agency after the effective date of this Rule or after the first day of July of any subsequent year, the initial fee shall be due on the date of issuance of the license or registration.

(c) The initial fee in Paragraph (b) of this Rule shall be computed as follows:

- (1) When any new license or registration is issued before the first day of January of any year, the initial fee shall be the full amount specified in Rule .1105 or .1106 of this Section; and
(2) When any new license or registration is issued on or after the first day of January of any year, the initial fee shall be one-half of the amount specified in Rule .1105 or .1106 of this Section.

(d) All fees received by the agency pursuant to provisions of this Section shall be nonrefundable.

(e) Each licensee or registrant shall pay all fees online at https://www.thepayplace.com/northcarolinadhhs/dhsr/ncrpsfees/challenge.aspx, or by check or money order made payable to "Radiation Protection Section" and mail such payment to: Radiation Protection Section, Division of Environmental Health, Department of Environment and Natural Resources, 1645 Mail Service Center, Raleigh, North Carolina 27699 1645. Such payment may be delivered to the agency at its office located at 3825 Barrett Drive, Raleigh, North Carolina 27609 7221. Health Service Regulation, Department of Health and Human Services to the address shown on the facility invoice.

Authority G.S. 104E-9(a)(8); 104E-19(a).

10A NCAC 15 .1106 RADIOACTIVE MATERIALS AND ACCELERATOR FEE AMOUNTS (READOPTION WITHOUT SUBSTANTIVE CHANGES)

TITLE 15A – DEPARTMENT OF ENVIRONMENTAL QUALITY

Notice is hereby given in accordance with G.S. 150B-21.3A(c)(2)g that the Marine Fisheries Commission intends to re adopt with substantive changes the rules cited as 15A NCAC 03M .0509; and 03O .0108.

Link to agency website pursuant to G.S. 150B-19.1(c): http://portal.ncdenr.org/web/mf/mfc-proposed-rules-links

Proposed Effective Date: Subject to Legislative Review per S.L. 2019-198.

Public Hearing:

Date: October 23, 2019

Time: 6:00 p.m.

Location: Division of Marine Fisheries, 5285 Highway 70 West, Morehead City, NC 28557

Reason for Proposed Action: The agency proposed two rules for re adoption in accordance with G.S. 150B-21.3A for the Periodic Review and Expiration of Existing Rules. This is the second of four packages of rules in 15A NCAC 03 for re adoption over a four-year period. Proposed text shows conforming and minor technical changes to the rules. Additional changes are proposed to 15A NCAC 03M .0509 to make it unlawful to puncture or harvest tarpon, but to still allow catch and release. These changes are proposed to improve the survival of the fish. Additional changes are proposed to 15A NCAC 03O .0108 to allow transfers of Standard Commercial Fishing Licenses (SCFL) or Retired SCFL's under specific conditions, in addition to the conditions set forth in G.S. 113-168.2. These proposed changes provide flexibility for businesses to complete license transfers under specific conditions; the changes also add additional immediate family members as individuals eligible to receive a transferred license.

Comments may be submitted to: Catherine Blum, P.O. Box 769, Morehead City, NC 28557; phone (252) 808-8014; email catherine.blum@ncdenr.gov

Comment period ends: December 2, 2019

Fiscal impact. Does any rule or combination of rules in this notice create an economic impact? Check all that apply.

- [X] State funds affected
[] Local funds affected
[] Substantial economic impact (>= \$1,000,000)
[X] Approved by OSBM
[] No fiscal note required

CHAPTER 03 - MARINE FISHERIES

SUBCHAPTER 03M - FINFISH

SECTION .0500 - OTHER FINFISH

15A NCAC 03M .0509 TARPON

- (a) It is shall be unlawful to sell possess, sell, or offer for sale tarpon.
(b) It is unlawful to possess more than one tarpon per person taken in any one day.
(c) It is shall be unlawful to take tarpon by any method other than hook and line. hook and line.
(c) It shall be unlawful to gaff, spear, or puncture a tarpon.

Authority G.S. 113-134; 113-182; 113-221; 143B-289.4; 143B-289.52.

SUBCHAPTER 03O - LICENSES, LEASES, FRANCHISES AND PERMITS

SECTION .0100 - LICENSES

15A NCAC 03O .0108 LICENSE AND COMMERCIAL FISHING VESSEL REGISTRATION TRANSFERS

- (a) To transfer a license or Commercial Fishing Vessel Registration, the license or registration cannot be expired prior to transfer.
(b) Upon transfer of a license or Commercial Fishing Vessel Registration, the transferee becomes the licensee and assumes the privileges of holding the license or Commercial Fishing Vessel Registration.
(c) A transfer application including a certification statement form shall be provided by the Division of Marine Fisheries. A transfer application shall be completed for each transfer including, but not limited to:

- (1) the information required as set forth in Rule .0101(a) of this Section;
(2) a certified statement from the transferee listing any violations involving marine and estuarine resources in the State of North Carolina during the previous three years; and
(3) a certified statement from the transferee that the information and supporting documentation submitted with the transfer application is true and correct, and that the transferee acknowledges that it is unlawful for a person to accept transfer of a license for which they are ineligible.

(d) A properly completed transfer application shall be returned to an office of the Division by mail or in person, except as set forth in Paragraph (e) of this Rule.

(e) A transfer application submitted to the Division without complete and required information shall be deemed incomplete and shall not be considered further until resubmitted with all required information. Incomplete applications shall be returned to the applicant with deficiency in the application so noted.

(a)(f) Licenses A License to Land Flounder from the Atlantic Ocean may shall only be transferred:

- (1) with the transfer of the ownership of a vessel that the licensee owns that individually met the eligibility requirements of 15A NCAC 3O .0101 (b)(1)(A) and (b)(1)(B) Rule .0101(b)(1)(A) and (b)(1)(B) of this Section to the new owner of that vessel. Transfer of the License to Land Flounder from the Atlantic Ocean transfers all flounder landings from the Atlantic Ocean associated with that vessel; or
(2) by the owner of a vessel to another vessel under the same ownership.

Transfer of a License to Land Flounder from the Atlantic Ocean transfers with it all flounder landings from the Atlantic Ocean associated with that vessel. Any transfer of license under this Paragraph may shall only be processed through the Division of Marine Fisheries Morehead City Headquarters Office and no transfer is effective until approved and processed by the Division.

(b)(g) Transfer of a Commercial Fishing Vessel Registration Transfer. Registration: When if transferring ownership of a vessel

bearing a current ~~commercial fishing vessel registration~~, Commercial Fishing Vessel Registration, the new ~~owner~~ owner:

- (1) shall follow the requirements in ~~15A NCAC 030 .0101~~ Rule .0101 of this Section and pay a replacement fee of ~~ten dollars (\$10.00)~~ as set forth in Rule .0107 of this Section for a replacement ~~commercial fishing vessel registration~~ Commercial Fishing Vessel Registration; and
- (2) ~~The new owner must~~ shall submit a transfer form application provided by the Division with the signatures of the former ~~licensee~~ owner and the ~~signature~~ signature of the new ~~licensee~~ owner notarized.

~~(e)~~(h) Transfer of a Standard or Retired Standard Commercial Fishing License transfers: License:

- (1) It is unlawful for a person to accept transfer of a Standard or Retired Standard Commercial Fishing License for which they are ineligible.
- ~~(+)~~(2) A Standard or Retired Standard Commercial Fishing License ~~may~~ shall only be transferred if both the transferor and the transferee have no current suspensions or revocations of any Marine Fisheries license privileges. In the event of the death of the transferor, this requirement shall only apply to the transferee.
- (3) For purposes of effecting transfers under this Paragraph:
 - (A) in addition to those family members defined in G.S. 113-168(3a), "immediate family" shall mean grandparents, grandchildren, and legal guardians of an individual;
 - (B) "business" shall mean corporations and limited liability companies that have been registered with the Secretary of State; and
 - (C) "owner" shall mean owner, shareholder, or manager of a business.
- ~~(2)~~(4) At the time of the transfer of a Standard or Retired Standard Commercial Fishing License, the transferor ~~must~~ shall indicate the retainment or transfer of the landings history associated with that Standard or Retired Standard Commercial Fishing License. The transferor may retain a landings history only if the transferor holds an additional Standard or Retired Standard Commercial Fishing License. Transfer of a landings history is all or none.
- ~~(3)~~(5) To transfer a Standard or Retired Standard Commercial Fishing License, the following information is required:
 - (A) information on the transferee as set ~~out~~ forth in 15A NCAC 030 .0101; Rule .0101 of this Section;
 - (B) notarization of the ~~current license holder's~~ transferor's and the transferee's signatures on a the transfer

~~form provided by the Division; application; and~~

- ~~(C)~~ when the transferee is a non-resident, a written certified statement from the applicant listing any violations involving marine and estuarine resources during the previous three years;
- ~~(D)~~(C) when if the transferor is retiring from commercial fishing, the transferor must submit evidence showing that such retirement has in fact occurred, for example, which may include, but is not limited to, evidence of the transfer of all licensee's the transferor's Standard Commercial Fishing Licenses, sale of all the licensee's transferor's registered vessels, or discontinuation of any active involvement in commercial fishing. Properly completed transfer forms must be returned to Division Offices by mail or in person.
- ~~(4)~~(6) The Standard or Retired Standard Commercial Fishing License ~~which that~~ is being transferred must shall be surrendered to the Division at the time of the transfer application.
- ~~(5)~~(7) Fees:
 - (A) ~~Transferee~~ The transferee must shall pay a replacement fee of ~~ten dollars (\$10.00)~~ as set forth in Rule .0107 of this Section.
 - (B) ~~Transferee~~ The transferee must shall pay the differences in fees as specified in G.S. 113-168.2 (e) 113-168.2(e) or G.S. 113-168.3 (b) 113-168.3(b) ~~when if the transferee who is a non-resident is being transferred a resident Standard or Retired Standard Commercial Fishing License. non-resident.~~
 - (C) ~~Transferee~~ The transferee must shall pay the differences in fees as specified in G.S. 113-168.2 (e) 113-168.2(e) ~~when if the license to be transferred is a Retired Standard Commercial Fishing License and the transferee is less than 65 years old.~~
- (8) Transfer of Standard or Retired Standard Commercial Fishing License for a Business:
 - (A) An individual holding a Standard or Retired Standard Commercial Fishing License may transfer their license to a business in which the license holder is also an owner of the business in accordance with application requirements as set forth in Rule .0101(a) of this Section.

(B) If a business is dissolved, the business may transfer the license or licenses of the business to an individual owner of the dissolved business. A dissolved business holding multiple licenses may transfer one license or multiple licenses to one owner or multiple owners or any combination thereof. A notarized statement showing agreement for the transfer of all owners of the business is required to complete this transaction.

(C) If a business is sold, the business may transfer the license or licenses of the business to the successor business at the time of sale.

(D) If an owner leaves the business, any license originally owned by that owner may be transferred back to themselves as an individual at the time the owner leaves the corporation. A notarized statement showing agreement for the transfer of all owners of the business is required to complete this transaction.

~~(6)~~(9) Transfer of Standard or Retired Standard Commercial Fishing License for a Deceased Licensee: Licensee:

(A) ~~When the deceased licensee's~~ If an immediate surviving family member(s) member of the deceased licensee is eligible to hold the deceased's deceased licensee's Standard Commercial Fishing License License or Retired Standard Commercial Fishing License, the Administrator/Executor must give written notification within six months after the Administrator/Executor qualifies under G.S. G.S. 28A to the Morehead City Office of the Division of Marine Fisheries of the request to transfer the deceased's deceased's license to the estate Administrator/Executor.

(B) A transfer to the Administrator/Executor shall be made according to the provisions of Subparagraphs ~~(e)(2)~~ (e)(4)(2) through (4) of this Rule. Paragraph. The Administrator/Executor must provide a copy of the deceased licensee's death certificate, a copy of the certificate of ~~administration~~ administration, and a list of eligible immediate family members to the ~~Morehead City Office of the Division of Marine Fisheries. Division.~~

(C) The Administrator/Executor ~~may~~ shall only transfer a license in the

Administrator/Executor name on behalf of the estate to a an eligible surviving family member. The surviving family member transferee ~~may~~ shall only transfer the license to a third party purchaser of the deceased licensee's fishing vessel. Transfers shall be made according to the provisions of Subparagraphs ~~(e) 2—(e)(4)(2) through (4) of this Rule. Paragraph.~~

~~(d) Transfer forms submitted without complete and required information shall be deemed incomplete and will not be considered further until resubmitted with all required information.~~

~~(e) It is unlawful for a person to accept transfer of a Standard or Retired Standard Commercial Fishing License for which they are ineligible.~~

Authority G.S. 113-134; 113-168.1; 113-168.2; 113-168.3; 113-168.6; 113-182; 143B-289.52.

Notice is hereby given in accordance with G.S. 150B-21.2 that the Wildlife Resources Commission intends to amend the rules cited as 15A NCAC 10F .0306 and .0340.

Link to agency website pursuant to G.S. 150B-19.1(c): <https://www.ncwildlife.org/Proposed-Regulations>

Proposed Effective Date: May 1, 2020

Public Hearing:

Date: October 17, 2019

Time: 10:00 a.m.

Location: WRC Headquarters, 5th Floor, 1751 Varsity Drive, Raleigh, NC 27606

Reason for Proposed Action:

15A NCAC 10F .0306 *The Town of Carolina Beach submitted an application and Resolution requesting rulemaking for a no-wake zone in a portion of Myrtle Grove Sound on the eastern side, to mitigate boater safety hazards within 50 yards of the fueling docks and community pier at Oceana Marina and Carolina Beach Yacht Club and Marina, and within 50 yards of the shoreline in the congested area south of Carolina Beach Yacht Club and Marina to the intersection with the existing no-wake zone at Carolina Beach Yacht Basin. The U.S. Army Corps of Engineers concurs with placement of markers in this portion of the Intracoastal Waterway if the no-wake zone does not extend into the federal channel. The Town of Carolina Beach will purchase and place buoys and pilings and obtain the required CAMA permit. A Fiscal Note was submitted to OSBM and was approved by the WRC on 8-29-19.*

15A NCAC 10F .0340 *Currituck County submitted an application and Resolution for rulemaking for a no-wake zone within the canals at Wild Horse Estates at Carova Beach. Canals are shallow and narrow with sharp turns, creating boater safety*

N.C. Marine Fisheries Commission
2019-2020 Annual Rulemaking Cycle

Public Comment Period
Oct. 16-Dec. 2, 2019

Written Public Comments

From: [Blum, Catherine](#)
To: [REDACTED]
Subject: RE: [External] Re: [DENR.DMF.NewsRelease] Marine Fisheries Commission accepting public comment on two proposed rule changes
Date: Wednesday, October 02, 2019 12:06:00 PM

Dear Jerry Anderson,

Thank you for taking the time to submit your comments on the Marine Fisheries Commission's proposed changes to the License and Commercial Fishing Vessel Registration Transfers rule, 15A NCAC 03O .0108. Your comments will be provided to lead staff and to the commission for its consideration prior to voting on final approval of the rule, scheduled for the February 2020 commission meeting.

Catherine

Catherine Blum
Fishery Management Plan and Rulemaking Coordinator
Division of Marine Fisheries
N.C. Department of Environmental Quality

252-808-8014 office
252-726-0254 fax
catherine.blum@ncdenr.gov

P.O. Box 769
3441 Arendell Street
Morehead City, NC 28557-0769



Email correspondence to and from this address is subject to the North Carolina Public Records Law and may be disclosed to third parties.

From: Odom, Kelly
Sent: Tuesday, October 01, 2019 2:08 PM
To: Blum, Catherine <catherine.blum@ncdenr.gov>
Subject: FW: [External] Re: [DENR.DMF.NewsRelease] Marine Fisheries Commission accepting public comment on two proposed rule changes

Catherine,

Tricia wanted me to forward this to you.

Kelly

Kelly B. Odom
Education Specialist
N.C. Department of Environmental Quality
Post Office Box 769
Morehead City, NC 28557
[*Kelly.Odom@ncdenr.gov*](mailto:Kelly.Odom@ncdenr.gov)
252-808-8027

From: Smith, Tricia <tricia.smith@ncdenr.gov>
Sent: Tuesday, October 01, 2019 2:07 PM
To: Odom, Kelly <kelly.odom@ncdenr.gov>
Subject: Re: [External] Re: [DENR.DMF.NewsRelease] Marine Fisheries Commission accepting public comment on two proposed

rule changes

Forward to Catherine.

Get [Outlook for Android](#)

From: Odom, Kelly <kelly.odom@ncdenr.gov>
Sent: Tuesday, October 1, 2019 1:26:39 PM
To: Smith, Tricia <tricia.smith@ncdenr.gov>
Subject: FW: [External] Re: [DENR.DMF.NewsRelease] Marine Fisheries Commission accepting public comment on two proposed rule changes

FYI

From: jerry anderson [REDACTED]
Sent: Tuesday, October 01, 2019 1:20 PM
To: Odom, Kelly <kelly.odom@ncdenr.gov>
Subject: [External] Re: [DENR.DMF.NewsRelease] Marine Fisheries Commission accepting public comment on two proposed rule changes

CAUTION: External email. Do not click links or open attachments unless you verify. Send all suspicious email as an attachment to report.spam@nc.gov

So basically you are making my licence have no value. Can't sell it. I'm glad you're not regulating my real estate.

On Tue, Oct 1, 2019, 10:19 AM Odom, Kelly <kelly.odom@ncdenr.gov> wrote:

Roy Cooper
Governor

Michael S. Regan
Secretary



Steve Murphey
Director

Release: Immediate
 Date: Oct. 1, 2019

Contact: [Patricia Smith](#)
 Phone: 252-726-7021

Marine Fisheries Commission accepting public comment on two proposed rule changes

MOREHEAD CITY – The N.C. Marine Fisheries Commission is accepting public comments on changes to two rules, one pertaining to tarpon and the other pertaining to transfers of commercial fishing licenses.

The public may comment in person at a public hearing scheduled for Oct. 23 at 6 p.m. at the division’s Central District Office, 5285 Highway 70 West, Morehead City. The public may also comment in writing to division Rules Coordinator Catherine Blum at P.O. Box 769, Morehead City, N.C. 28557 or via email at Catherine.Blum@ncdenr.gov. The deadline for written comments is Dec. 2.

The proposed rules would:

- Amend 15A NCAC 03M .0509 to prohibit possession of tarpon and make it illegal to gaff, spear, or puncture tarpon by any method other than hook and line.
- Modify 15A NCAC 03O .0108 to clarify the circumstances under which transfers of Standard Commercial Fishing Licenses are allowed, including the following:
 1. Add grandparents, grandchildren, and legal guardians to the list of immediate family members eligible to receive a transferred license.
 2. Codify the existing requirement of a certification statement from the transferee that affirms the information

provided to the division is true and accurate.

3. Allow an individual license holder to transfer the license to a business in which the license holder is also an owner.
4. Allow a business that is dissolved to transfer a license to an individual owner of the business.
5. Allow a business that is sold to transfer a license to the successor business at the time of sale.
6. Allow a business to transfer a license back to an owner who is leaving the business, if the owner originally held the license as an individual.
7. Restrict business transfers to corporations and limited liability companies.
8. Define "owner" to include shareholder of a corporation and member of a limited liability company.

The proposed rule changes come at the request of the Marine Fisheries Commission, which voted in February 2018 to start the process of amending the tarpon rule to improve the survivability of the fish and has, over the past couple of years, expressed concern about the types of license transfers allowed by statute and rule.

Modification of the two rules also meets a state-mandated periodic review schedule under which state agencies must review existing rules at least once every 10 years.

The proposed effective date of the rules is subject to legislative review.

For specific wording of the rule changes, go to the N.C. Marine Fisheries Commission's [Proposed Rules Page](#).

For more information, contact [Catherine Blum](#), rules coordinator for the N.C. Division of Marine Fisheries, at 252-808-8014.

###

Website: <http://www.ncmarinefisheries.net>
Facebook: <http://www.facebook.com/ncdeq>
Twitter: <http://www.twitter.com/NCDEQ>
RSS Feed: <http://portal.ncdenr.org/web/opa/news-releases-rss>
P.O. Box 769, 3441 Arendell St., Morehead City N.C. 28557

Patricia Smith
Communications Director
Division of Marine Fisheries/Division of Coastal Management
252-808-8025 (Work)
252-342-0642 (Mobile)
Tricia.Smith@ncdenr.gov

<http://portal.ncdenr.org/web/mf/>
<https://deq.nc.gov/about/divisions/coastal-management>

Email correspondence to and from this address is subject to the North Carolina Public Records Law and may be disclosed to third parties.

Kelly B. Odom
Education Specialist
N.C. Department of Environmental Quality
Post Office Box 769
Morehead City, NC 28557
[*Kelly.Odom@ncdenr.gov*](mailto:Kelly.Odom@ncdenr.gov)
252-808-8027

DENR.DMF.NewsRelease mailing list
DENR.DMF.NewsRelease@lists.ncmail.net

From: [Blum, Catherine](#)
To: [My Gmail](#)
Subject: RE: [External] Tarpon rules
Date: Wednesday, October 02, 2019 12:02:00 PM

Dear Mr. Mandulak,

Thank you for taking the time to submit your comments on the Marine Fisheries Commission's proposed changes to the tarpon rule, 15A NCAC 03M .0509. Your comments will be provided to lead staff and to the commission for its consideration prior to voting on final approval of the rule, scheduled for the February 2020 commission meeting.

Catherine

Catherine Blum
Fishery Management Plan and Rulemaking Coordinator
Division of Marine Fisheries
N.C. Department of Environmental Quality

252-808-8014 office
252-726-0254 fax
catherine.blum@ncdenr.gov

P.O. Box 769
3441 Arendell Street
Morehead City, NC 28557-0769



Email correspondence to and from this address is subject to the North Carolina Public Records Law and may be disclosed to third parties.

From: My Gmail
Sent: Tuesday, October 01, 2019 12:24 PM
To: Blum, Catherine <catherine.blum@ncdenr.gov>
Subject: [External] Tarpon rules

CAUTION: External email. Do not click links or open attachments unless you verify. Send all suspicious email as an attachment to report.spam@nc.gov

Catherine, not that I have caught many tarpon so my experience is limited but it is useful to lip gaff tarpon. This facilitates controlling them to remove hooks and take a quick picture before release. I suggest you consider some verbiage to allow lip gaffing the tarpon as a "boga" type gripper is not terribly effective with these big fish. Landing nets just get torn up by large tarpon. Bill Mandulak

From: [Blum, Catherine](#)
To: [Steve Bernardo](#)
Subject: RE: [External] MFC accepting public comment on two proposed rule changes
Date: Wednesday, October 02, 2019 12:08:00 PM

Dear Steve Bernardo,

Thank you for taking the time to submit your comments on the Marine Fisheries Commission's proposed changes to the tarpon rule, 15A NCAC 03M .0509. Your comments will be provided to lead staff and to the commission for its consideration prior to voting on final approval of the rule, scheduled for the February 2020 commission meeting.

Catherine

Catherine Blum
Fishery Management Plan and Rulemaking Coordinator
Division of Marine Fisheries
N.C. Department of Environmental Quality

252-808-8014 office
252-726-0254 fax
catherine.blum@ncdenr.gov

P.O. Box 769
3441 Arendell Street
Morehead City, NC 28557-0769

Email correspondence to and from this address is subject to the North Carolina Public Records Law and may be disclosed to third parties.

-----Original Message-----

From: Steve Bernardo
Sent: Tuesday, October 01, 2019 9:42 PM
To: Blum, Catherine <catherine.blum@ncdenr.gov>
Subject: [External] MFC accepting public comment on two proposed rule changes

CAUTION: External email. Do not click links or open attachments unless you verify. Send all suspicious email as an attachment to report.spam@nc.gov <<mailto:report.spam@nc.gov>>

Re: Tarpon Regs

There is no need to change any Tarpon Regs since so few are killed. Most are caught and released. Tarpon are not endangered and only a select few people want a rules change.

I am a firm NO on changing any Tarpon laws

Best regards,
Steve Bernardo

Sent from my iPad

From: [Blum, Catherine](#)
To: "Riley Inman"
Subject: RE: [External] Proposed amendment 15A NCAC 03M .0509 Regarding Tarpon
Date: Thursday, October 03, 2019 11:41:00 AM

Dear Riley Inman,

Thank you for taking the time to submit your comments on the Marine Fisheries Commission's proposed changes to the tarpon rule, 15A NCAC 03M .0509. Your comments will be provided to lead staff and to the commission for its consideration prior to voting on final approval of the rule, scheduled for the February 2020 commission meeting.

Catherine

Catherine Blum
Fishery Management Plan and Rulemaking Coordinator
Division of Marine Fisheries
N.C. Department of Environmental Quality

252-808-8014 office
252-726-0254 fax
catherine.blum@ncdenr.gov

P.O. Box 769
3441 Arendell Street
Morehead City, NC 28557-0769



Email correspondence to and from this address is subject to the North Carolina Public Records Law and may be disclosed to third parties.

From: Riley Inman
Sent: Thursday, October 03, 2019 11:18 AM
To: Blum, Catherine <catherine.blum@ncdenr.gov>
Subject: [External] Proposed amendment 15A NCAC 03M .0509 Regarding Tarpon

CAUTION: External email. Do not click links or open attachments unless you verify. Send all suspicious email as an attachment to report.spam@nc.gov

Good Morning Catherine,

I hope you are well. I would like to express my concern about the proposed amendment listed below:

Amend 15A NCAC 03M .0509 to prohibit possession of tarpon and make it illegal to gaff, spear, or puncture tarpon by any method other than hook and line.

I have many concerns about this proposal and would like to share them with you:

1. This proposal is being presented not because of scientific data showing the population is in decline, but because a small, handful of charter captains feel tarpon should not be harvested. As they are entitled to their opinions, these opinions alone should not allow for an amendment to a current rule without peer reviewed scientific data stating that species is in decline.
2. Tarpon are considered a pelagic species that are thought to travel 1000's of miles. There is some data to support this out of Florida but there is very little recent data showing what the populations of tarpon in NC do during the winter.
3. If this amendment passes it will allow future amendments and rules to be put into place based on the feelings of folks rather than facts. I understand many people view tarpon as a game fish species that should be protected but again, that opinion should not determine whether or not a fish can be harvested.
4. The reason this concern was brought to the committee by these captains is they became aware of a few tarpon that were being harvested and used for land based shark fishing bait. Because they felt that the tarpon was more "valuable" than bait they felt people should not be able to keep them if they were using the fish in a way not deemed suitable by this small group of captains. We cannot allow a small group of captains to determine what bait recreational fisherman are allowed to use.
5. No one knows or can provide an answer in regard to how many tarpon are harvested annually in NC.
6. No one can provide an answer for what condition the pelagic stock of tarpon in NC are in.
7. No one can provide an answer in regards to the financial impact tarpon fishing has on the state of North Carolina.

Again, we cannot make rules and amendments to our state's fisheries based on the opinion of a select few. This opens Pandora's box to allow other species to be subject to similar rules based on the perceived value of a fish without any factual basis. I sincerely hope the committee will consider the impact this will have on future decisions.

--

Thank you for your time,

Riley.

From: [Blum, Catherine](#)
To: [Jason Fowler](#)
Cc: [Moore, Tina](#)
Subject: RE: [External] Public Comment Opposing Amend 15A NCAC 03M .0509 (Tarpon)
Date: Thursday, October 03, 2019 1:20:00 PM

Dear Jason Fowler,

Thank you for taking the time to submit your comments on the Marine Fisheries Commission's proposed changes to the tarpon rule, 15A NCAC 03M .0509. Your comments will be provided to lead staff and to the commission for its consideration prior to voting on final approval of the rule, scheduled for the February 2020 commission meeting.

Catherine

Catherine Blum
Fishery Management Plan and Rulemaking Coordinator
Division of Marine Fisheries
N.C. Department of Environmental Quality

252-808-8014 office
252-726-0254 fax
catherine.blum@ncdenr.gov

P.O. Box 769
3441 Arendell Street
Morehead City, NC 28557-0769



Email correspondence to and from this address is subject to the North Carolina Public Records Law and may be disclosed to third parties.

From: Jason Fowler
Sent: Thursday, October 03, 2019 1:04 PM
To: Blum, Catherine <catherine.blum@ncdenr.gov>
Cc: Moore, Tina <tina.moore@ncdenr.gov>
Subject: [External] Public Comment Opposing Amend 15A NCAC 03M .0509 (Tarpon)

CAUTION: External email. Do not click links or open attachments unless you verify. Send all suspicious email as an attachment to report.spam@nc.gov

Good afternoon Catherine,
I would like to express my concerns about the proposed amendment Amend 15A NCAC 03M .0509 to prohibit possession of tarpon and make it illegal to gaff, spear, or puncture tarpon by any method other than hook and line. Being a member of the [REDACTED] [REDACTED]

[REDACTED], I understand the importance of protecting a vulnerable species of fish from being overfished or declining in population due to environmental factors but to place restrictions on harvest solely because of moral/personal beliefs in regards to that fishery is opening a Pandora's box method of fisheries management. Per the IUCN (International Union for Conservation of Nature) Red List of Threatened Species, there has been no formal stock assessment of Tarpon in any portion of the species' range so there is no scientific data to support closing this fishery to become catch and release only in our North Carolina waters.

This proposal was presented to the NC Division of Marine Fisheries not because of scientific data showing the population is in decline, but because a small, handful of charter captains feel that tarpon should not be harvested as they align their principles with the BTT (Bonefish and Tarpon Trust) of Florida. One of the main proponents of this amendment recently admitted on social media that "Two years ago when I saw photos of Tarpon being used as shark bait yes it irritated me." As they are entitled to their opinions, these opinions alone should not allow for an amendment to a current rule without peer reviewed scientific data stating that species is in decline. Tarpon are a nomadic pelagic species that are thought to travel 1000's of miles. There is little data showing what the populations of tarpon in North Carolina do during the winter months but it is believed that many continue their journey back down to warmer waters. If this amendment passes it will allow future amendments and rules to be put into place based on the morals and feelings of individuals/groups rather than facts. I understand many people view tarpon as a game fish species that should be protected but again, that opinion should not determine whether or not a fish can be harvested. By passing this amendment, North Carolina will become the only state in which a tarpon is not eligible for harvest from our waters to the waters of Texas. Below are the regulations for the other states in which tarpon is an active fishery:

South Carolina - 77" FL minimum size limit and daily bag limit is one per person per day

Georgia - 68" FL minimum size limit and daily bag limit is one per person per day

Florida - Catch and Release only fishery but one tarpon tag per person per year may be purchased when in pursuit of an IGFA record

Alabama - 60" TL minimum size limit, 1 fish possession requires tarpon tag

Mississippi - No regulations

Louisiana - No regulations

Texas - 85" TL minimum size limit, 1 per person per day and 2 possession limit

The reason this concern was brought to the Marine Fisheries

Commission by these captains is they became aware of a few tarpon that were being harvested and used for land based shark fishing bait. They felt that the tarpon was more "valuable" than bait and should not be able to keep them if they were using the fish in a way not deemed suitable by this small group of captains. We cannot allow a small group of anyone to determine what bait recreational fisherman are allowed to use without scientific data to back it up. No one knows or can provide an exact answer in regard to how many tarpon are harvested annually in NC but from my educated knowledge, it is under 20 total since 2016 when the first one was harvested for the use of shark bait and to my knowledge, 0 so far this season for that purpose. No one can provide an answer for what condition the pelagic stock of tarpon in NC are in nor can one provide an answer in regards to the financial impact tarpon fishing has on the state of North Carolina.

Closing the fishery will have an economic impact on one of the largest public accesses to the North Carolina Tarpon fishery, our ocean side fishing piers. Countless anglers flock to the coast and piers each summer for a chance to battle *Megalops atlanticus* in hopes of achieving the rewarding moment when you have won the battle and caught the fish. Many anglers do release the fish to receive a North Carolina Saltwater Tournament Citation while others harvest the fish to provide bait for the Land Based Shark Fishing community as the mortality of a released fish after a long arduous fight is a definite probability. Taking this option away, will cause many anglers to not want to spend the time and money on travelling to the coast to participate in a fishery that is solely catch and release and the most restrictive on the eastern and gulf seaboard.

Again, we cannot make rules and amendments to our state's fisheries based on the opinions of a select few without the necessary scientific data to support these actions. This will allow other species to be subject to similar rules based on the perceived value of a fish without any factual basis. I sincerely hope the committee will consider the impact this will have on future decisions and vote to NOT APPROVE the proposed amendment Amend 15A NCAC 03M .0509.

Thank you for your time and consideration in this matter,

Jason Fowler

[REDACTED]
[REDACTED]

From: [Blum, Catherine](#)
To: [P "PWaLL" Parks](#)
Subject: RE: [External] Tarpon
Date: Thursday, October 03, 2019 3:43:00 PM

Dear Paul Park,

Thank you for taking the time to submit your comments on the Marine Fisheries Commission's proposed changes to the tarpon rule, 15A NCAC 03M .0509. (You must be an acquaintance of someone who is a member of the [REDACTED] who submitted similar comments, as I do not see you on that roster.) Your comments will be provided to lead staff and to the commission for its consideration prior to voting on final approval of the rule, scheduled for the February 2020 commission meeting.

Catherine

Catherine Blum
Fishery Management Plan and Rulemaking Coordinator
Division of Marine Fisheries
N.C. Department of Environmental Quality

252-808-8014 office
252-726-0254 fax
catherine.blum@ncdenr.gov

P.O. Box 769
3441 Arendell Street
Morehead City, NC 28557-0769

Email correspondence to and from this address is subject to the North Carolina Public Records Law and may be disclosed to third parties.

-----Original Message-----

From: P "PWaLL" Parks
Sent: Thursday, October 03, 2019 1:43 PM
To: Blum, Catherine <catherine.blum@ncdenr.gov>
Subject: [External] Tarpon

CAUTION: External email. Do not click links or open attachments unless you verify. Send all suspicious email as an attachment to report.spam@nc.gov <<mailto:report.spam@nc.gov>>

Good afternoon Catherine,

I would like to express my concerns about the proposed amendment Amend 15A NCAC 03M .0509 to prohibit possession of tarpon and make it illegal to gaff, spear, or puncture tarpon by any method other than hook and line. Being a member of the [REDACTED], I understand the importance of protecting a vulnerable species of fish from being overfished or declining in population due to environmental factors but to place restrictions on harvest solely because of moral/personal beliefs in regards to that fishery is opening a Pandora's box method of fisheries management. Per the IUCN (International Union for Conservation of Nature) Red List of Threatened Species, there has been no formal stock assessment of Tarpon in any portion of the species' range so there is no scientific data to support closing this fishery to become catch and release only in our North Carolina waters.

This proposal was presented to the NC Division of Marine Fisheries not because of scientific data showing the population is in decline, but because a small, handful of charter captains feel that tarpon should not be harvested as

they align their principles with the BTT (Bonefish and Tarpon Trust) of Florida. One of the main proponents of this amendment recently admitted on social media that "Two years ago when I saw photos of Tarpon being used as shark bait yes it irritated me." As they are entitled to their opinions, these opinions alone should not allow for an amendment to a current rule without peer reviewed scientific data stating that species is in decline. Tarpon are a nomadic pelagic species that are thought to travel 1000's of miles. There is little data showing what the populations of tarpon in North Carolina do during the winter months but it is believed that many continue their journey back down to warmer waters. If this amendment passes it will allow future amendments and rules to be put into place based on the morals and feelings of individuals/groups rather than facts. I understand many people view tarpon as a game fish species that should be protected but again, that opinion should not determine whether or not a fish can be harvested. By passing this amendment, North Carolina will become the only state in which a tarpon is not eligible for harvest from our waters to the waters of Texas.

Below are the regulations for the other states in which tarpon is an active fishery:

South Carolina - 77" FL minimum size limit and daily bag limit is one per person per day Georgia - 68" FL minimum size limit and daily bag limit is one per person per day Florida - Catch and Release only fishery but one tarpon tag per person per year may be purchased when in pursuit of an IGFA record Alabama - 60" TL minimum size limit, 1 fish possession requires tarpon tag Mississippi - No regulations Louisiana - No regulations Texas - 85" TL minimum size limit, 1 per person per day and 2 possession limit

The reason this concern was brought to the Marine Fisheries Commission by these captains is they became aware of a few tarpon that were being harvested and used for land based shark fishing bait. They felt that the tarpon was more "valuable" than bait and should not be able to keep them if they were using the fish in a way not deemed suitable by this small group of captains. We cannot allow a small group of anyone to determine what bait recreational fisherman are allowed to use without scientific data to back it up. No one knows or can provide an exact answer in regard to how many tarpon are harvested annually in NC but from my educated knowledge, it is under 20 total since 2016 when the first one was harvested for the use of shark bait and to my knowledge, 0 so far this season for that purpose. No one can provide an answer for what condition the pelagic stock of tarpon in NC are in nor can one provide an answer in regards to the financial impact tarpon fishing has on the state of North Carolina.

Closing the fishery will have an economic impact on one of the largest public accesses to the North Carolina Tarpon fishery, our ocean side fishing piers. Countless anglers flock to the coast and piers each summer for a chance to battle *Megalops atlanticus* in hopes of achieving the rewarding moment when you have won the battle and caught the fish. Many anglers do release the fish to receive a North Carolina Saltwater Tournament Citation while others harvest the fish to provide bait for the Land Based Shark Fishing community as the mortality of a released fish after a long arduous fight is a definite probability. Taking this option away, will cause many anglers to not want to spend the time and money on travelling to the coast to participate in a fishery that is solely catch and release and the most restrictive on the eastern and gulf seaboard.

Again, we cannot make rules and amendments to our state's fisheries based on the opinions of a select few without the necessary scientific data to support these actions. This will allow other species to be subject to similar rules based on the perceived value of a fish without any factual basis. I sincerely hope the committee will consider the impact this will have on future decisions and vote to NOT APPROVE the proposed amendment Amend 15A NCAC 03M .0509.

Thank you for your time and consideration in this matter,

Paul Park

From: [Blum, Catherine](#)
To: [Eric Bregman](#)
Subject: RE: [External] Proposed amendment 15A NCAC 03M .0509 Regarding Tarpon
Date: Thursday, October 03, 2019 3:43:00 PM

Dear Eric Bregman,

Thank you for taking the time to submit your comments on the Marine Fisheries Commission's proposed changes to the tarpon rule, 15A NCAC 03M .0509. Your comments will be provided to lead staff and to the commission for its consideration prior to voting on final approval of the rule, scheduled for the February 2020 commission meeting.

Catherine

Catherine Blum
Fishery Management Plan and Rulemaking Coordinator
Division of Marine Fisheries
N.C. Department of Environmental Quality

252-808-8014 office
252-726-0254 fax
catherine.blum@ncdenr.gov

P.O. Box 769
3441 Arendell Street
Morehead City, NC 28557-0769



Email correspondence to and from this address is subject to the North Carolina Public Records Law and may be disclosed to third parties.

From: Eric Bregman
Sent: Thursday, October 03, 2019 2:41 PM
To: Blum, Catherine <catherine.blum@ncdenr.gov>
Subject: [External] Proposed amendment 15A NCAC 03M .0509 Regarding Tarpon

CAUTION: External email. Do not click links or open attachments unless you verify. Send all suspicious email as an attachment to report.spam@nc.gov

Catherine,

I hope you are well. I would like to express my concern about the proposed amendment listed below:

Amend 15A NCAC 03M .0509 to prohibit possession of tarpon and make it illegal to gaff, spear, or puncture tarpon by any method other than hook and line.

I have many concerns about this proposal and would like to share them with you:

1. This proposal is being presented not because of scientific data showing the population is in decline, but because a small, handful of charter captains feel tarpon should not be harvested. As they are entitled to their opinions, these opinions alone should not allow for an amendment to a current rule without peer reviewed scientific data stating that species is in decline. While I understand that a stock assessment would not be necessary for a species with no commercial value, no data is still no data.
2. Tarpon are considered a pelagic species that are thought to travel 1000's of miles. There is some data to support this out of Florida but there is very little recent data showing what the populations of tarpon in NC do during the winter and and if our population is even in the same biomass as the Florida fish. We dont even know the number harvested this year or the last 2-3 years.
3. If this amendment passes it will allow future amendments and rules to be put into place based on the feelings of folks rather than facts. I understand many people view tarpon as a game fish species that should be protected, which is a very valid argument, but again, that opinion should not determine whether or not a fish can be harvested. Furthermore, I personally would never harvest a tarpon and probably would never take one out of the water...but that should have no bearing on rule making.
4. The reason this concern was brought to the committee by these captains is they became aware of a few tarpon that were being harvested and used for land based shark fishing bait. Because they felt that the tarpon was more"valuable" than bait they felt people should not be able to keep them if they were using the fish in a way not deemed suitable by this small group of captains. We cannot allow a small group of captains to determine what bait recreational fisherman are allowed to use.
5. No one can provide an answer in regards to the financial impact tarpon fishing has on the state of North Carolina.
6. If the population of Tarpon is such a huge risk why is Florida the only state between here and Texas that doesnt allow harvest of tarpon? If the population was in dire condition

Unfortunately, based on the decision last meeting to deny the petition for rule making regarding trawlers with ample scientific data to support the petition, my expectation as to whether science (or lack there of) will be taken into consideration when making this decision is low at best

Again, we cannot make rules and amendments to our state's fisheries based on the opinion of a select few. This opens Pandora's box to allow other species to be subject to similar rules based on the perceived value of a fish without any factual basis. I sincerely hope the committee will consider the impact this will have on future decisions.

--

Eric D, Bregman, CPA

[Redacted signature block]

From: [Blum, Catherine](#)
To: [Eric Fowler](#)
Subject: RE: [External] Public Comment on Tarpon Rule Change
Date: Thursday, October 03, 2019 3:44:00 PM

Dear Eric Fowler,

Thank you for taking the time to submit your comments on the Marine Fisheries Commission's proposed changes to the tarpon rule, 15A NCAC 03M .0509. Your comments will be provided to lead staff and to the commission for its consideration prior to voting on final approval of the rule, scheduled for the February 2020 commission meeting.

Catherine

Catherine Blum
Fishery Management Plan and Rulemaking Coordinator
Division of Marine Fisheries
N.C. Department of Environmental Quality

252-808-8014 office
252-726-0254 fax
catherine.blum@ncdenr.gov

P.O. Box 769
3441 Arendell Street
Morehead City, NC 28557-0769



Email correspondence to and from this address is subject to the North Carolina Public Records Law and may be disclosed to third parties.

From: Eric Fowler
Sent: Thursday, October 03, 2019 3:13 PM
To: Blum, Catherine <catherine.blum@ncdenr.gov>
Subject: [External] Public Comment on Tarpon Rule Change

CAUTION: External email. Do not click links or open attachments unless you verify. Send all suspicious email as an attachment to report.spam@nc.gov

Ms. Blum,

I am an avid outdoors man and like to call North Carolina my home. I love being able to go to my local fishing pier and attempt to catch a tarpon every summer as it is one of the best fights that I can obtain from the pier. Many times, we release the fish that we catch but on occasion, we harvest them to provide bait for our local sharking fishermen as they are targeting large apex predators and tagging them for NOAA.

I have looked at the proposed amendment change and strongly oppose making our tarpon fishery a

catch and release only fishery. The population is definitely not hurting as we see thousands of tarpon swimming and rolling every summer from the pier. These are just the fish that we do see, imagine the ones that are out of our view from the pier.

I also understand that this proposed rule change is coming about because of several guides in the Wilmington area that got upset when they saw that tarpon was being used at cut bait. While everyone might not agree that tarpon should be used for this purpose, it is legal and should not result in a shut down of a booming fishery. A lot of these fish, if released, would succumb to the rigors of being caught and die. In order to make a change, you need to show scientific data to support their claims that the fish population is declining. This cannot be done as there has not been any stock assessment performed on tarpon.

In conclusion, I DO NOT support the proposed tarpon amendment and would like to see North Carolina still have the option to harvest a tarpon if the angler so desires.

Regards,

Eric Fowler

From: [Blum, Catherine](#)
To: [kevin brown](#)
Subject: RE: [External] Tarpon protection
Date: Wednesday, October 16, 2019 11:06:00 AM

Dear Kevin Brown,

Thank you for taking the time to submit your comments on the Marine Fisheries Commission's proposed changes to the tarpon rule, 15A NCAC 03M .0509. Your comments will be provided to lead staff and to the commission for its consideration prior to voting on final approval of the rule, scheduled for the February 2020 commission meeting.

Catherine

Catherine Blum
Fishery Management Plan and Rulemaking Coordinator
Division of Marine Fisheries
N.C. Department of Environmental Quality

252-808-8014 office
252-726-0254 fax
catherine.blum@ncdenr.gov

P.O. Box 769
3441 Arendell Street
Morehead City, NC 28557-0769



Email correspondence to and from this address is subject to the North Carolina Public Records Law and may be disclosed to third parties.

From: kevin brown
Sent: Wednesday, October 16, 2019 9:29 AM
To: Blum, Catherine <catherine.blum@ncdenr.gov>
Subject: [External] Tarpon protection

CAUTION: External email. Do not click links or open attachments unless you verify. Send all suspicious email as an attachment to report.spam@nc.gov

I support Amendment 15A NCAC 03M.0509 to prohibit possession of tarpon and make it illegal to gaff, spear or puncture tarpon by any method other than hook and line. We need to do more to protect this specie so we can insure they are around for future generations.

Thanks for your attention to this matter.

Kevin Brown



[Sent from Yahoo Mail for iPhone](#)

From: [Blum, Catherine](#)
To: [Bill Lunsford](#)
Subject: RE: [External] Amendment 15A NCAC 03M.0509
Date: Wednesday, October 16, 2019 11:07:00 AM

Dear Bill Lunsford,

Thank you for taking the time to submit your comments on the Marine Fisheries Commission's proposed changes to the tarpon rule, 15A NCAC 03M .0509. Your comments will be provided to lead staff and to the commission for its consideration prior to voting on final approval of the rule, scheduled for the February 2020 commission meeting.

Catherine

Catherine Blum
Fishery Management Plan and Rulemaking Coordinator
Division of Marine Fisheries
N.C. Department of Environmental Quality

252-808-8014 office
252-726-0254 fax
catherine.blum@ncdenr.gov

P.O. Box 769
3441 Arendell Street
Morehead City, NC 28557-0769

Email correspondence to and from this address is subject to the North Carolina Public Records Law and may be disclosed to third parties.

-----Original Message-----

From: Bill Lunsford
Sent: Wednesday, October 16, 2019 9:39 AM
To: Blum, Catherine <catherine.blum@ncdenr.gov>
Subject: [External] Amendment 15A NCAC 03M.0509

CAUTION: External email. Do not click links or open attachments unless you verify. Send all suspicious email as an attachment to report.spam@nc.gov <<mailto:report.spam@nc.gov>>

I support Amendment 15A NCAC 03M.0509. Tarpon, if protected, have the potential to drive significant economic benefit to NC if the population is protected and their numbers grow. For sports fisherman that enjoy fishing within sight of the coast, tarpon represent the very top of the pyramid when it comes to difficulty to catch, good chaos when on the line, and a very unique fishing experience. This is true whether fishing with live bait, artificial or fly. The potential for guides to build their book of business and grow the market is significant. The species has no material negative impact to NC, and represents something that should be protected for future generations. I strongly am in favor of passing this Amendment.

Bill Lunsford

Bill Lunsford

Phone: 

From: [Blum, Catherine](#)
To: [Brian Blackman](#)
Subject: RE: [External] Amendment 15A NCAC 03M.0509
Date: Wednesday, October 16, 2019 11:08:00 AM

Dear Brian Blackman,

Thank you for taking the time to submit your comments on the Marine Fisheries Commission's proposed changes to the tarpon rule, 15A NCAC 03M .0509. Your comments will be provided to lead staff and to the commission for its consideration prior to voting on final approval of the rule, scheduled for the February 2020 commission meeting.

Catherine

Catherine Blum
Fishery Management Plan and Rulemaking Coordinator
Division of Marine Fisheries
N.C. Department of Environmental Quality

252-808-8014 office
252-726-0254 fax
catherine.blum@ncdenr.gov

P.O. Box 769
3441 Arendell Street
Morehead City, NC 28557-0769



Email correspondence to and from this address is subject to the North Carolina Public Records Law and may be disclosed to third parties.

From: Brian Blackman
Sent: Wednesday, October 16, 2019 9:46 AM
To: Blum, Catherine <catherine.blum@ncdenr.gov>
Subject: [External] Amendment 15A NCAC 03M.0509

CAUTION: External email. Do not click links or open attachments unless you verify. Send all suspicious email as an attachment to report.spam@nc.gov

Dear Catherine,

Please know that I support Amendment 15A NCAC 03M.0509 and as an avid marine outdoorsman see firsthand the devastating impacts of unsustainable fishing practices. Tarpon are one of many species that are indiscriminately destroyed by gill nets and poor fishing practices.

I advocate the prohibition to possess Tarpon and would like to see it made illegal to gaff, spear or puncture tarpon by any method other than hook and line. I also advocate education for recreational fishing

to ensure that those who pursue tarpon as a catch and release game fish know how to properly handle and revive this amazing, prehistoric species.

Thank you for your work and efforts to protect our marine fisheries.

Best

Brian Blackman



From: [Blum, Catherine](#)
To: [REDACTED] David Democko
Subject: RE: [External] I support Amendment 15A NCAC 03M.0509
Date: Wednesday, October 16, 2019 11:09:00 AM

Dear David Democko,

Thank you for taking the time to submit your comments on the Marine Fisheries Commission's proposed changes to the tarpon rule, 15A NCAC 03M .0509. Your comments will be provided to lead staff and to the commission for its consideration prior to voting on final approval of the rule, scheduled for the February 2020 commission meeting.

Catherine

Catherine Blum
Fishery Management Plan and Rulemaking Coordinator
Division of Marine Fisheries
N.C. Department of Environmental Quality

252-808-8014 office
252-726-0254 fax
catherine.blum@ncdenr.gov

P.O. Box 769
3441 Arendell Street
Morehead City, NC 28557-0769



Email correspondence to and from this address is subject to the North Carolina Public Records Law and may be disclosed to third parties.

From: [REDACTED] David Democko
Sent: Wednesday, October 16, 2019 9:47 AM
To: Blum, Catherine <catherine.blum@ncdenr.gov>
Subject: [External] I support Amendment 15A NCAC 03M.0509

CAUTION: External email. Do not click links or open attachments unless you verify. Send all suspicious email as an attachment to report.spam@nc.gov

- I support Amendment 15A NCAC 03M.0509 to prohibit possession of tarpon and make it illegal to gaff, spear or puncture tarpon by any method other than hook and line.
- Atlantic tarpon have been classified as "vulnerable" across the extent of their range by the International Union for the Conservation of Nature; the tarpon population has declined due to over-harvest in some locations, loss of habitat, and detrimental fish handling practices.
- Tarpon in North Carolina waters are part of a larger, regional fishery; the harvest of tarpon impacts the recreational fishery locally and regionally.
- Practices such as lip gaffing and other puncture methods negatively effect tarpon feeding and

increases catch-and-release mortality.

- Tarpon support a valuable recreational fishery having annual economic impacts counted in the millions of dollars in some other states.
- Given the potential growth of the recreational tarpon fishery locally, these proactive measures to both reduce harvest and harm to the fish will help conserve the species and benefit the State of North Carolina.

David Democko

[REDACTED]

[REDACTED]

[REDACTED]

[REDACTED]

[REDACTED]

Please consider the environment before printing this email

From: [Blum, Catherine](#)
To: [Lorian Schweikert](#)
Subject: RE: [External] Letter to Ms. Catherine Blum - support for Amendment 15A NCAC 03M.0509
Date: Wednesday, October 16, 2019 11:09:00 AM

Dear Lorian Schweikert,

Thank you for taking the time to submit your comments on the Marine Fisheries Commission's proposed changes to the tarpon rule, 15A NCAC 03M .0509. Your comments will be provided to lead staff and to the commission for its consideration prior to voting on final approval of the rule, scheduled for the February 2020 commission meeting.

Catherine

Catherine Blum
Fishery Management Plan and Rulemaking Coordinator
Division of Marine Fisheries
N.C. Department of Environmental Quality

252-808-8014 office
252-726-0254 fax
catherine.blum@ncdenr.gov

P.O. Box 769
3441 Arendell Street
Morehead City, NC 28557-0769



Email correspondence to and from this address is subject to the North Carolina Public Records Law and may be disclosed to third parties.

From: Lorian Schweikert
Sent: Wednesday, October 16, 2019 9:48 AM
To: Blum, Catherine <catherine.blum@ncdenr.gov>
Subject: [External] Letter to Ms. Catherine Blum - support for Amendment 15A NCAC 03M.0509

CAUTION: External email. Do not click links or open attachments unless you verify. Send all suspicious email as an attachment to report.spam@nc.gov

Dear Ms. Catherine Blum,

Please see the attached letter. I have also copied the contents of the letter here. Thank you for your consideration.

Dear Ms. Catherine Plum and members of the hearing committee:

I am writing to show my support for Amendment 15A NCAC 03M.0509 to prohibit

possession of tarpon and make it illegal to gaff, spear or puncture tarpon by any method other than hook and line.

Atlantic tarpon have been classified as "vulnerable" across the extent of their range by the International Union for the Conservation of Nature; the tarpon population has declined due to over-harvest in some locations, loss of habitat, and detrimental fish handling practices. Tarpon in North Carolina waters are part of a larger, regional fishery; the harvest of tarpon impacts the recreational fishery locally and regionally across the southeastern United States. Practices such as lip gaffing and other puncture methods negatively effect tarpon feeding and increases catch-and-release mortality. Tarpon support a valuable recreational fishery having annual economic impacts counted in the millions of dollars in some other states. Given the potential growth of the recreational tarpon fishery locally, these proactive measures to both reduce harvest and harm to the fish will help conserve the species and benefit the State of North Carolina.

I am a marine biologist who has studied marine fish sensory systems and sensory-guided for the nearly ten years. My doctoral dissertation was completed on the visual ability and life history of the Atlantic tarpon. I have been a resident of North Carolina State, employed by [REDACTED], and I am currently a Distinguished Postdoctoral Fellow at [REDACTED] University. The management of tarpon in North Carolina is falling behind the proactive measures being taken by other states to protect this economically valuable species, such as Florida. I fully support Amendment 15A NCAC 03M.0509.

Sincerely,
Lorian Schweikert

--

Lorian E. Schweikert, Ph.D.
Postdoctoral Fellow

[REDACTED] University
Depart. of Biological Sciences

[REDACTED]
lab: [REDACTED]

office: [REDACTED]

From: [Blum, Catherine](#)
To: [Mann, George T.](#)
Subject: RE: [External] NC Tarpon Regulations Amendment
Date: Wednesday, October 16, 2019 11:10:00 AM

Dear George Mann,

Thank you for taking the time to submit your comments on the Marine Fisheries Commission's proposed changes to the tarpon rule, 15A NCAC 03M .0509. Your comments will be provided to lead staff and to the commission for its consideration prior to voting on final approval of the rule, scheduled for the February 2020 commission meeting.

Catherine

Catherine Blum
Fishery Management Plan and Rulemaking Coordinator
Division of Marine Fisheries
N.C. Department of Environmental Quality

252-808-8014 office
252-726-0254 fax
catherine.blum@ncdenr.gov

P.O. Box 769
3441 Arendell Street
Morehead City, NC 28557-0769




Email correspondence to and from this address is subject to the North Carolina Public Records Law and may be disclosed to third parties.

From: Mann, George T.
Sent: Wednesday, October 16, 2019 10:08 AM
To: Blum, Catherine <catherine.blum@ncdenr.gov>
Subject: [External] NC Tarpon Regulations Amendment

CAUTION: External email. Do not click links or open attachments unless you verify. Send all suspicious email as an attachment to report.spam@nc.gov

- I support Amendment 15A NCAC 03M.0509 to prohibit possession of tarpon and make it illegal to gaff, spear or puncture tarpon by any method other than hook and line.
- Atlantic tarpon have been classified as "vulnerable" across the extent of their range by the International Union for the Conservation of Nature; the tarpon population has declined due to over-harvest in some locations, loss of habitat, and detrimental fish handling practices.
- Tarpon in North Carolina waters are part of a larger, regional fishery; the harvest of tarpon impacts the recreational fishery locally and regionally.
- Practices such as lip gaffing and other puncture methods negatively affect tarpon feeding and increases catch-and-release mortality.
- Tarpon support a valuable recreational fishery having annual economic impacts counted in the millions of dollars in some other states.
- Given the potential growth of the recreational tarpon fishery locally, these proactive measures to both reduce harvest and harm to the fish will help conserve the species and benefit the State of North Carolina.

George T. ("Ted") Mann
[REDACTED]
[REDACTED] | [REDACTED]



Any incoming e-mail reply to this communication will be electronically filtered for "spam" and/or "viruses." That filtering process may result in such reply being quarantined and/or delayed in reaching us. Accordingly, you should consider sending communications to us which are particularly important or time-sensitive by means other than e-mail.

This e-mail communication and the attachments hereto, if any, are intended solely for the information and use of the addressee(s) identified above and may contain information which is legally privileged and/or otherwise confidential. Accordingly, if a recipient of this e-mail is not an addressee (or an authorized representative of an addressee), such recipient is hereby advised that any review, disclosure, reproduction, re-transmission or other dissemination or use of this e-mail communication (or any information contained herein) is strictly prohibited. If you are not an addressee and/or have received this e-mail communication in error, please advise the sender of that circumstance either by reply e-mail or by telephone at [REDACTED], immediately delete this e-mail communication from any computer and destroy all physical copies of same.

From: [Blum, Catherine](#)
To: [Charles Aikens](#)
Subject: RE: [External] Amendment to its existing tarpon regulation 15A NCAC 03M.0509.
Date: Wednesday, October 16, 2019 11:11:00 AM

Dear Chuck Aikens,

Thank you for taking the time to submit your comments on the Marine Fisheries Commission's proposed changes to the tarpon rule, 15A NCAC 03M .0509. Your comments will be provided to lead staff and to the commission for its consideration prior to voting on final approval of the rule, scheduled for the February 2020 commission meeting.

Catherine

Catherine Blum
Fishery Management Plan and Rulemaking Coordinator
Division of Marine Fisheries
N.C. Department of Environmental Quality

252-808-8014 office
252-726-0254 fax
catherine.blum@ncdenr.gov

P.O. Box 769
3441 Arendell Street
Morehead City, NC 28557-0769



Email correspondence to and from this address is subject to the North Carolina Public Records Law and may be disclosed to third parties.

From: Charles Aikens
Sent: Wednesday, October 16, 2019 10:11 AM
To: Blum, Catherine <catherine.blum@ncdenr.gov>
Subject: [External] Amendment to its existing tarpon regulation 15A NCAC 03M.0509.

CAUTION: External email. Do not click links or open attachments unless you verify. Send all suspicious email as an attachment to report.spam@nc.gov

Hi Catherine,

I am taking a minute to write to in regard to the current regulations on *Megalops atlanticus* (Tarpon). As a member of Bonefish Tarpon Trust, BTT, As you know, Tarpon visit the NC coast and for the most part are just passing through following the Atlantic thermocline up to the Chesapeake bay.

Over the years, specifically in Florida, strict regulations have been adopted along with proper handling of these magnificent fish for a safe release. It is important that we join Florida and other states along the South Eastern seaboard to protect this species on their journey.

As a guide in North Carolina, who is developing this fishery in Coastal rivers and estuaries, I support this amendment to protect these fish and to reduce their mortality rate and to install a catch and release mentality, including not removing them from the water. Every year these fish are caught on the piers along our coast and needlessly killed.

Please let me know if I can help in any way.

Below are some key points as they relate to current regulations:

- Atlantic tarpon have been classified as "vulnerable" across the extent of their range by the International Union for the Conservation of Nature; the tarpon population has declined due to over-harvest in some locations, loss of habitat, and detrimental fish handling practices.
- Tarpon in North Carolina waters are part of a larger, regional fishery; the harvest of tarpon impacts the recreational fishery locally and regionally.
- Practices such as lip gaffing and other puncture methods negatively effect tarpon feeding and increases catch-and-release mortality.
- Tarpon support a valuable recreational fishery having annual economic impacts counted in the millions of dollars in some other states.
- Given the potential growth of the recreational tarpon fishery locally, these proactive measures to both reduce harvest and harm to the fish will help conserve the species and benefit the State of North Carolina.

Best,

Chuck Aikens

From: [Blum, Catherine](#)
To: [Jim Morgan](#)
Subject: RE: [External] Tarpon Amendment
Date: Wednesday, October 16, 2019 11:11:00 AM

Dear Jim Morgan,

Thank you for taking the time to submit your comments on the Marine Fisheries Commission's proposed changes to the tarpon rule, 15A NCAC 03M .0509. Your comments will be provided to lead staff and to the commission for its consideration prior to voting on final approval of the rule, scheduled for the February 2020 commission meeting.

Catherine

Catherine Blum
Fishery Management Plan and Rulemaking Coordinator
Division of Marine Fisheries
N.C. Department of Environmental Quality

252-808-8014 office
252-726-0254 fax
catherine.blum@ncdenr.gov

P.O. Box 769
3441 Arendell Street
Morehead City, NC 28557-0769



Email correspondence to and from this address is subject to the North Carolina Public Records Law and may be disclosed to third parties.

From: Jim Morgan
Sent: Wednesday, October 16, 2019 10:16 AM
To: Blum, Catherine <catherine.blum@ncdenr.gov>
Subject: [External] Tarpon Amendment

CAUTION: External email. Do not click links or open attachments unless you verify. Send all suspicious email as an attachment to report.spam@nc.gov

Cathy,

A few thoughts on the proposed amendment:

- I support Amendment 15A NCAC 03M.0509 to prohibit possession of tarpon and make it illegal to gaff, spear or puncture tarpon by any method other than hook and line.
- Atlantic tarpon have been classified as "vulnerable" across the extent of their range by the International Union for the Conservation of Nature; the tarpon population has declined due to over-harvest in some locations, loss of habitat, and detrimental fish handling practices.

- Tarpon in North Carolina waters are part of a larger, regional fishery; the harvest of tarpon impacts the recreational fishery locally and regionally.
- Practices such as lip gaffing and other puncture methods negatively effect tarpon feeding and increases catch-and-release mortality.
- Tarpon support a valuable recreational fishery having annual economic impacts counted in the millions of dollars in some other states.
- Given the potential growth of the recreational tarpon fishery locally, these proactive measures to both reduce harvest and harm to the fish will help conserve the species and benefit the State of North Carolina.

Thank you,
Jim Morgan

From: [Blum, Catherine](#)
To: [Tom Hollinshed](#)
Subject: RE: [External] TARPON!!
Date: Wednesday, October 16, 2019 11:12:00 AM

Dear Tom Hollinshed,

Thank you for taking the time to submit your comments on the Marine Fisheries Commission's proposed changes to the tarpon rule, 15A NCAC 03M .0509. Your comments will be provided to lead staff and to the commission for its consideration prior to voting on final approval of the rule, scheduled for the February 2020 commission meeting.

Catherine

Catherine Blum
Fishery Management Plan and Rulemaking Coordinator
Division of Marine Fisheries
N.C. Department of Environmental Quality

252-808-8014 office
252-726-0254 fax
catherine.blum@ncdenr.gov

P.O. Box 769
3441 Arendell Street
Morehead City, NC 28557-0769



Email correspondence to and from this address is subject to the North Carolina Public Records Law and may be disclosed to third parties.

From: Tom Hollinshed
Sent: Wednesday, October 16, 2019 11:09 AM
To: Catherine.Blum@ncdenr.gov.
Cc: 'John Guggenheimer' [REDACTED]; Jay Cole [REDACTED]; Grant Singleton [REDACTED]
Subject: [External] TARPON!!

CAUTION: External email. Do not click links or open attachments unless you verify. Send all suspicious email as an attachment to report_spam@nc.gov

Catherine, I just got word that there was a move afoot to amend the existing Tarpon regulation 15A NCAC 03M.0509. I had no idea anyone, educated or not would consider killing a Tarpon. It's not like you could eat it? If there is not a prohibition on Killing or mishandling, during release of a Tarpon, such as lip gaffing or removing the fish from the water there should be. Research is now showing a possible year round resident population as close as South Carolina. Between our Pamlico sound, its

rivers and two capes and another Cape with it's river North Carolina has an amazing Tarpon habitat and recreational opportunity I and many others enjoy. I hope most recreational fisherman are receiving information either from DMF, NCWRC, CCA and The Bonefish Tarpon Trust on the proper way to catch, handle and release these amazing fish. Thank you for your effort and support of this amendment and all the work you do in support of our states coastal resources! Please let me know if some how I can help this get approved.

Tom Hollinshed

[REDACTED]

[REDACTED]

[REDACTED]

From: [Blum, Catherine](#)
To: [Stephens, Louis](#)
Subject: RE: [External] Carolina Tarpon support
Date: Thursday, October 17, 2019 7:25:00 AM

Dear Louis Stephens,

Thank you for taking the time to submit your comments on the Marine Fisheries Commission's proposed changes to the tarpon rule, 15A NCAC 03M .0509. Your comments will be provided to lead staff and to the commission for its consideration prior to voting on final approval of the rule, scheduled for the February 2020 commission meeting.

Catherine

Catherine Blum
Fishery Management Plan and Rulemaking Coordinator
Division of Marine Fisheries
N.C. Department of Environmental Quality

252-808-8014 office
252-726-0254 fax
catherine.blum@ncdenr.gov

P.O. Box 769
3441 Arendell Street
Morehead City, NC 28557-0769



Email correspondence to and from this address is subject to the North Carolina Public Records Law and may be disclosed to third parties.

From: Stephens, Louis
Sent: Wednesday, October 16, 2019 11:35 AM
To: Blum, Catherine <catherine.blum@ncdenr.gov>
Subject: [External] Carolina Tarpon support

CAUTION: External email. Do not click links or open attachments unless you verify. Send all suspicious email as an attachment to report.spam@nc.gov

- I support Amendment 15A NCAC 03M.0509 to prohibit possession of tarpon and make it illegal to gaff, spear or puncture tarpon by any method other than hook and line.
- Atlantic tarpon have been classified as "vulnerable" across the extent of their range by the International Union for the Conservation of Nature; the tarpon population has declined due to over-harvest in some locations, loss of habitat, and detrimental fish handling practices.
- Tarpon in North Carolina waters are part of a larger, regional fishery; the harvest

- of tarpon impacts the recreational fishery locally and regionally.
- Practices such as lip gaffing and other puncture methods negatively effect tarpon feeding and increases catch-and-release mortality.
 - Tarpon support a valuable recreational fishery having annual economic impacts counted in the millions of dollars in some other states.
 - Given the potential growth of the recreational tarpon fishery locally, these proactive measures to both reduce harvest and harm to the fish will help conserve the species and benefit the State of North Carolina

Louis Stephens, CCIM, SIOR
Managing Director



[One of the 2019 World's Most Ethical Companies®](#)

Jones Lang LaSalle

For more information about how JLL processes your personal data, please click [here](#).

This email is for the use of the intended recipient(s) only. If you have received this email in error, please notify the sender immediately and then delete it. If you are not the intended recipient, you must not keep, use, disclose, copy or distribute this email without the author's prior permission. We have taken precautions to minimize the risk of transmitting software viruses, but we advise you to carry out your own virus checks on any attachment to this message. We cannot accept liability for any loss or damage caused by software viruses. The information contained in this communication may be confidential and may be subject to the attorney-client privilege. If you are the intended recipient and you do not wish to receive similar electronic messages from us in the future then please respond to the sender to this effect.

From: [Blum, Catherine](#)
To: [Kimberly B Walker](#)
Subject: RE: [External] Proposed Amendment to North Carolina Tarpon Regulation
Date: Thursday, October 17, 2019 7:26:00 AM

Dear Kim Walker,

Thank you for taking the time to submit your comments on the Marine Fisheries Commission's proposed changes to the tarpon rule, 15A NCAC 03M .0509. Your comments will be provided to lead staff and to the commission for its consideration prior to voting on final approval of the rule, scheduled for the February 2020 commission meeting.

Catherine

Catherine Blum
Fishery Management Plan and Rulemaking Coordinator
Division of Marine Fisheries
N.C. Department of Environmental Quality

252-808-8014 office
252-726-0254 fax
catherine.blum@ncdenr.gov

P.O. Box 769
3441 Arendell Street
Morehead City, NC 28557-0769



Email correspondence to and from this address is subject to the North Carolina Public Records Law and may be disclosed to third parties.

From: Kimberly B Walker
Sent: Wednesday, October 16, 2019 11:51 AM
To: Blum, Catherine <catherine.blum@ncdenr.gov>
Subject: [External] Proposed Amendment to North Carolina Tarpon Regulation
Importance: High

CAUTION: External email. Do not click links or open attachments unless you verify. Send all suspicious email as an attachment to report.spam@nc.gov

I support Amendment 15A NCAC 03M.0509 to prohibit possession of tarpon and make it illegal to gaff, spear or puncture tarpon by any method other than hook and line.

Atlantic tarpon have been classified as "vulnerable" across the extent of their range by the International Union for the Conservation of Nature; the tarpon population has declined due to over-harvest in some locations, loss of habitat, and detrimental fish handling practices.

Tarpon in North Carolina waters are part of a larger, regional fishery; the harvest of tarpon

impacts the recreational fishery locally and regionally.

Practices such as lip gaffing and other puncture methods negatively effect tarpon feeding and increases catch-and-release mortality.

Tarpon support a valuable recreational fishery having annual economic impacts counted in the millions of dollars in some other states.

Given the potential growth of the recreational tarpon fishery locally, these proactive measures to both reduce harvest and harm to the fish will help conserve the species and benefit the State of North Carolina. FL has a multi-million dollar Tarpon fishery, when the fish are protected there and allowed to be harvested in areas where they migrate, it defeats the whole purpose.

Thank you in advance for your consideration,

Kim Walker, Licensed Staff Agent & Office Manager

[Redacted signature block]

From: [Blum, Catherine](#)
To: [Ted DuBose](#)
Subject: RE: [External] Tarpon
Date: Thursday, October 17, 2019 7:27:00 AM

Dear Ted DuBose,

Thank you for taking the time to submit your comments on the Marine Fisheries Commission's proposed changes to the tarpon rule, 15A NCAC 03M .0509. Your comments will be provided to lead staff and to the commission for its consideration prior to voting on final approval of the rule, scheduled for the February 2020 commission meeting.

Catherine

Catherine Blum
Fishery Management Plan and Rulemaking Coordinator
Division of Marine Fisheries
N.C. Department of Environmental Quality

252-808-8014 office
252-726-0254 fax
catherine.blum@ncdenr.gov

P.O. Box 769
3441 Arendell Street
Morehead City, NC 28557-0769

Email correspondence to and from this address is subject to the North Carolina Public Records Law and may be disclosed to third parties.

-----Original Message-----

From: Ted DuBose
Sent: Wednesday, October 16, 2019 11:56 AM
To: Blum, Catherine <catherine.blum@ncdenr.gov>
Subject: [External] Tarpon

CAUTION: External email. Do not click links or open attachments unless you verify. Send all suspicious email as an attachment to report.spam@nc.gov <<mailto:report.spam@nc.gov>>

I want to let you know I fully support the new law on Tarpon handling. I've fished for tarpon for over forty years. There is absolutely no reason to kill a tarpon or handle it in any way that would jeopardize its survival. Thank you for doing what is necessary to bring this to law.

Sent from my iPhone

From: [Blum, Catherine](#)
To: [Frank Armstrong](#)
Subject: RE: [External] Amendment 15A NCAC 03M.0509
Date: Thursday, October 17, 2019 7:27:00 AM

Dear Frank Armstrong,

Thank you for taking the time to submit your comments on the Marine Fisheries Commission's proposed changes to the tarpon rule, 15A NCAC 03M .0509. Your comments will be provided to lead staff and to the commission for its consideration prior to voting on final approval of the rule, scheduled for the February 2020 commission meeting.

Catherine

Catherine Blum

Fishery Management Plan and Rulemaking Coordinator
Division of Marine Fisheries
N.C. Department of Environmental Quality

252-808-8014 office
252-726-0254 fax
catherine.blum@ncdenr.gov

P.O. Box 769
3441 Arendell Street
Morehead City, NC 28557-0769



Email correspondence to and from this address is subject to the North Carolina Public Records Law and may be disclosed to third parties.

From: Frank Armstrong
Sent: Wednesday, October 16, 2019 1:53 PM
To: Blum, Catherine <catherine.blum@ncdenr.gov>
Subject: [External] Amendment 15A NCAC 03M.0509

CAUTION: External email. Do not click links or open attachments unless you verify. Send all suspicious email as an attachment to report.spam@nc.gov

- I support Amendment 15A NCAC 03M.0509 to prohibit possession of tarpon and make it illegal to gaff, spear or puncture tarpon by any method other than hook and line.
- Atlantic tarpon have been classified as "vulnerable" across the extent of their range by the International Union for the Conservation of Nature; the tarpon population has declined due to over-harvest in some locations, loss of habitat, and detrimental fish handling practices.
- Tarpon in North Carolina waters are part of a larger, regional fishery; the harvest of tarpon impacts the recreational fishery locally and regionally.
- Practices such as lip gaffing and other puncture methods negatively effect tarpon feeding and increases catch-and-release mortality.

- Tarpon support a valuable recreational fishery having annual economic impacts counted in the millions of dollars in some other states.
- Given the potential growth of the recreational tarpon fishery locally, these proactive measures to both reduce harvest and harm to the fish will help conserve the species and benefit the State of North Carolina.

Thank-you for working to protect the Tarpon fishery in North Carolina.

Frank Armstrong



From: [Blum, Catherine](#)
To: [Ron Shealy](#)
Subject: RE: [External] Tarpon Amendment
Date: Thursday, October 17, 2019 7:27:00 AM

Dear Ron Shealy,

Thank you for taking the time to submit your comments on the Marine Fisheries Commission's proposed changes to the tarpon rule, 15A NCAC 03M .0509. Your comments will be provided to lead staff and to the commission for its consideration prior to voting on final approval of the rule, scheduled for the February 2020 commission meeting.

Catherine

Catherine Blum
Fishery Management Plan and Rulemaking Coordinator
Division of Marine Fisheries
N.C. Department of Environmental Quality

252-808-8014 office
252-726-0254 fax
catherine.blum@ncdenr.gov

P.O. Box 769
3441 Arendell Street
Morehead City, NC 28557-0769



Email correspondence to and from this address is subject to the North Carolina Public Records Law and may be disclosed to third parties.

From: Ron Shealy
Sent: Wednesday, October 16, 2019 3:18 PM
To: Blum, Catherine <catherine.blum@ncdenr.gov>
Subject: [External] Tarpon Amendment

CAUTION: External email. Do not click links or open attachments unless you verify. Send all suspicious email as an attachment to report.spam@nc.gov

- I support Amendment 15A NCAC 03M.0509 to prohibit possession of tarpon and make it illegal to gaff, spear or puncture tarpon by any method other than hook and line.
- Atlantic tarpon have been classified as "vulnerable" across the extent of their range by the International Union for the Conservation of Nature; the tarpon population has declined due to over-harvest in some locations, loss of habitat, and detrimental fish handling practices.
- Tarpon in North Carolina waters are part of a larger, regional fishery; the harvest of tarpon impacts the recreational fishery locally and regionally.
- Practices such as lip gaffing and other puncture methods negatively effect tarpon feeding and

increases catch-and-release mortality.

- Tarpon support a valuable recreational fishery having annual economic impacts counted in the millions of dollars in some other states.
- Given the potential growth of the recreational tarpon fishery locally, these proactive measures to both reduce harvest and harm to the fish will help conserve the species and benefit the State of North Carolina.

Ronald B Shealy MD

██████████, NC

Sent from [Mail](#) for Windows 10

From: [Blum, Catherine](#)
To: [jay murphy](#)
Subject: RE: [External] Tarpon regulations
Date: Thursday, October 17, 2019 3:26:00 PM

Dear Jay Murphy,

Thank you for taking the time to submit your comments on the Marine Fisheries Commission's proposed changes to the tarpon rule, 15A NCAC 03M .0509. Your comments will be provided to lead staff and to the commission for its consideration prior to voting on final approval of the rule, scheduled for the February 2020 commission meeting.

Catherine

Catherine Blum
Fishery Management Plan and Rulemaking Coordinator
Division of Marine Fisheries
N.C. Department of Environmental Quality

252-808-8014 office
252-726-0254 fax
catherine.blum@ncdenr.gov

P.O. Box 769
3441 Arendell Street
Morehead City, NC 28557-0769

Email correspondence to and from this address is subject to the North Carolina Public Records Law and may be disclosed to third parties.

-----Original Message-----

From: jay murphy
Sent: Thursday, October 17, 2019 8:56 AM
To: Blum, Catherine <catherine.blum@ncdenr.gov>
Subject: [External] Tarpon regulations

CAUTION: External email. Do not click links or open attachments unless you verify. Send all suspicious email as an attachment to report.spam@nc.gov <<mailto:report.spam@nc.gov>>

As a lifetime North Carolinian (with a lifetime Coastal rec license) I want to fully support support Amendment 15A NCAC 03M.0509 Thank you!

Jay Murphy


From: [Blum, Catherine](#)
To: [Dan Litaker](#)
Subject: RE: [External] NC Tarpon Regulations
Date: Thursday, October 17, 2019 3:27:00 PM
Attachments: [image002.png](#)
[image003.png](#)
[image004.png](#)
[image005.png](#)
[image006.png](#)

Dear Dan Litaker,

Thank you for taking the time to submit your comments on the Marine Fisheries Commission's proposed changes to the tarpon rule, 15A NCAC 03M .0509. Your comments will be provided to lead staff and to the commission for its consideration prior to voting on final approval of the rule, scheduled for the February 2020 commission meeting.

Catherine

Catherine Blum
Fishery Management Plan and Rulemaking Coordinator
Division of Marine Fisheries
N.C. Department of Environmental Quality

252-808-8014 office
252-726-0254 fax
catherine.blum@ncdenr.gov

P.O. Box 769
3441 Arendell Street
Morehead City, NC 28557-0769



Email correspondence to and from this address is subject to the North Carolina Public Records Law and may be disclosed to third parties.

From: Dan Litaker
Sent: Thursday, October 17, 2019 10:02 AM
To: Blum, Catherine <catherine.blum@ncdenr.gov>
Subject: [External] NC Tarpon Regulations

CAUTION: External email. Do not click links or open attachments unless you verify. Send all suspicious email as an attachment to report.spam@nc.gov

Catherine,

As a lifelong NC resident, I fully support the amendment to our current tarpon regulation and agree with all the points made below.

- I support Amendment 15A NCAC 03M.0509 to prohibit possession of tarpon and make it illegal to

- gaff, spear or puncture tarpon by any method other than hook and line.
- Atlantic tarpon have been classified as "vulnerable" across the extent of their range by the International Union for the Conservation of Nature; the tarpon population has declined due to over-harvest in some locations, loss of habitat, and detrimental fish handling practices.
 - Tarpon in North Carolina waters are part of a larger, regional fishery; the harvest of tarpon impacts the recreational fishery locally and regionally.
 - Practices such as lip gaffing and other puncture methods negatively effect tarpon feeding and increases catch-and-release mortality.
 - Tarpon support a valuable recreational fishery having annual economic impacts counted in the millions of dollars in some other states.
 - Given the potential growth of the recreational tarpon fishery locally, these proactive measures to both reduce harvest and harm to the fish will help conserve the species and benefit the State of North Carolina.

Thank you,

Dan M. Litaker III - Managing Partner / CEO

[Redacted]

[Redacted]

Free: [Redacted] | **Office:** [Redacted] | **Fax:** [Redacted]

Mailing: [Redacted]

Physical: [Redacted] | [Redacted] | [Redacted]

 [Redacted]

Email Confidentiality Notice: The information contained in this transmission is confidential, proprietary or privileged and may be subject to protection under the law, including the Health Insurance Portability and Accountability ACT (HIPAA). The message is intended for the sole use of the individual or entity to which it is addressed. If you are not the intended recipient, you are hereby notified that any use, distribution or copying of the message is strictly prohibited and may subject you to criminal or civil penalties. If you received this transmission in error, please contact the sender immediately by replying to this email and delete the material from any computer. For your protection, coverage cannot be bound or altered via voice mail, email, fax or online via the agency's website and is not effective until confirmed directly with a licensed agent. **Please consider the environment before printing this email.**

From: [Blum, Catherine](#)
To: [Robert Barnes](#)
Subject: RE: [External] Amendment to 15A NCAC 03M.0509
Date: Thursday, October 17, 2019 3:28:00 PM

Dear Robert Barnes,

Thank you for taking the time to submit your comments on the Marine Fisheries Commission's proposed changes to the tarpon rule, 15A NCAC 03M .0509. Your comments will be provided to lead staff and to the commission for its consideration prior to voting on final approval of the rule, scheduled for the February 2020 commission meeting.

Catherine

Catherine Blum
Fishery Management Plan and Rulemaking Coordinator
Division of Marine Fisheries
N.C. Department of Environmental Quality

252-808-8014 office
252-726-0254 fax
catherine.blum@ncdenr.gov

P.O. Box 769
3441 Arendell Street
Morehead City, NC 28557-0769



Email correspondence to and from this address is subject to the North Carolina Public Records Law and may be disclosed to third parties.

From: Robert Barnes
Sent: Thursday, October 17, 2019 10:05 AM
To: Blum, Catherine <catherine.blum@ncdenr.gov>; Whit Barnes [REDACTED]
Subject: [External] Amendment to 15A NCAC 03M.0509

CAUTION: External email. Do not click links or open attachments unless you verify. Send all suspicious email as an attachment to report.spam@nc.gov

Hi Catherine,

Hope you are well. I am writing to you to voice my support of the Amendment to 15A NCAC 03M.0509 to prohibit possession of tarpon and make it illegal to gaff, spear or puncture tarpon by any method other than hook and line.

As a [REDACTED] local, you see the same shrimp boats pass down the Bogue in the intercoastal that I see from our house on [REDACTED]. I have a sympathy for local, sustainable, commercial fishing practices, and I believe that this amendment could create a fishery that can be fiscally beneficial to the people of Eastern NC while not taking away from commercial fishing practices embedded in the history of the area.

It is easy to see how much more a fish like a tarpon is worth in the water than on land to the community locals when you visit areas where Amendments, like the one being proposed in NC, already exist. A healthy tarpon fishery could add to the growth that Morehead City is already seeing in its inshore and offshore sport fishing industry.

Many thanks to you and the Marine Fisheries Commission for all that you do.

Best,

Robert Barnes
[REDACTED]
[REDACTED]

understand the

As the Bahamian locals like to say, "a bonefish is worth more in the water than it is on land." I believe that this too can be the case for Tarpon in the Carolinas.

From: [Blum, Catherine](#)
To: [Josh Idol](#)
Subject: RE: [External] Public Comment Re: 15A NCAC 03M.0509
Date: Wednesday, October 23, 2019 11:45:00 AM

Dear Josh Idol,

Thank you for taking the time to submit your comments on the Marine Fisheries Commission's proposed changes to the tarpon rule, 15A NCAC 03M .0509. Your comments will be provided to lead staff and to the commission for its consideration prior to voting on final approval of the rule, scheduled for the February 2020 commission meeting.

Catherine

Catherine Blum
Fishery Management Plan and Rulemaking Coordinator
Division of Marine Fisheries
N.C. Department of Environmental Quality

252-808-8014 office
252-726-0254 fax
catherine.blum@ncdenr.gov

P.O. Box 769
3441 Arendell Street
Morehead City, NC 28557-0769

Email correspondence to and from this address is subject to the North Carolina Public Records Law and may be disclosed to third parties.

-----Original Message-----

From: Josh Idol
Sent: Thursday, October 17, 2019 8:09 PM
To: Blum, Catherine <catherine.blum@ncdenr.gov>
Subject: [External] Public Comment Re: 15A NCAC 03M.0509

CAUTION: External email. Do not click links or open attachments unless you verify. Send all suspicious email as an attachment to report.spam@nc.gov <<mailto:report.spam@nc.gov>>

Hi Catherine,

I wanted to reach out to you and the rest of the Marine Fisheries Commission about the proposed changes to 15A NCAC 03M.0509. As a life long recreational angler in North Carolina and someone who fishes for tarpon all across the southeast every year, these issues are important to me. I believe the proposed changes would be a step in the right direction for fisheries management in North Carolina.

The results of recent satellite tagging studies show that the tarpon fishery in NC is a part of a larger fishery that includes much of the gulf coast and the south east Atlantic coast. What we do here effects residents and tarpon fishermen from Texas to Virginia and I think we have a responsibility to do our part in protecting these amazing fish from harmful practices.

Tarpon are not a table fish of choice for most anglers outside of Central America and there's no good reason beyond fishermen's egos to kill, lip gaff, or even remove an adult tarpon from the water. As you know, our state does not have a juvenile tarpon fishery, all of our tarpon are mature fish and the methods I mentioned have a negative effect on mortality after release (for the fish that are released).

As some one who spends a good deal of time and money pursuing these fish outside of our state, I think there's an opportunity here to protect and promote a trophy fishery that could be a boon to local economies in eastern NC and set an example for the importance of responsible management for our other gamefish species.

Thank you for taking the time to read my note and I hope you'll consider supporting the proposed changes to 15A NCAC 03M.0509.

Thank you,

Josh Idol



From: [Blum, Catherine](#)
To: [Al Goodrich](#)
Subject: RE: [External] Regulation 15A NCAC 03M.0509 (Tarpon)
Date: Wednesday, October 23, 2019 12:02:00 PM

Dear Al Goodrich,

Thank you for taking the time to submit your comments on the Marine Fisheries Commission's proposed changes to the tarpon rule, 15A NCAC 03M .0509. Your comments will be provided to lead staff and to the commission for its consideration prior to voting on final approval of the rule, scheduled for the February 2020 commission meeting.

Catherine

Catherine Blum
Fishery Management Plan and Rulemaking Coordinator
Division of Marine Fisheries
N.C. Department of Environmental Quality

252-808-8014 office
252-726-0254 fax
catherine.blum@ncdenr.gov

P.O. Box 769
3441 Arendell Street
Morehead City, NC 28557-0769



Email correspondence to and from this address is subject to the North Carolina Public Records Law and may be disclosed to third parties.

From: Al Goodrich
Sent: Friday, October 18, 2019 10:05 AM
To: Blum, Catherine <catherine.blum@ncdenr.gov>
Subject: [External] Regulation 15A NCAC 03M.0509 (Tarpon)

CAUTION: External email. Do not click links or open attachments unless you verify. Send all suspicious email as an attachment to report.spam@nc.gov

Dear Ms. Blum,

I support the aforementioned amendment to prohibit possession of Atlantic Tarpon. It has come to my attention that they have been classified as vulnerable and wish our State to do its part in protecting this magnificent species. Furthermore I believe it to be wise to prohibit puncturing the fish in anyway that would cause it harm or prohibit its natural ability to feed in our waters. Hopefully these measures will allow our fishery to continue to provide a thriving habitat for future generations.

Sincerely,

Al Goodrich

[REDACTED]

From: [Blum, Catherine](#)
To: [Kevin Stewart](#)
Subject: RE: [External] 15A NCAC 03M.0509
Date: Wednesday, October 23, 2019 12:06:00 PM

Dear Kevin Stewart,

Thank you for taking the time to submit your comments on the Marine Fisheries Commission's proposed changes to the tarpon rule, 15A NCAC 03M .0509. Your comments will be provided to lead staff and to the commission for its consideration prior to voting on final approval of the rule, scheduled for the February 2020 commission meeting.

Catherine

Catherine Blum
Fishery Management Plan and Rulemaking Coordinator
Division of Marine Fisheries
N.C. Department of Environmental Quality

252-808-8014 office
252-726-0254 fax
catherine.blum@ncdenr.gov

P.O. Box 769
3441 Arendell Street
Morehead City, NC 28557-0769



Email correspondence to and from this address is subject to the North Carolina Public Records Law and may be disclosed to third parties.

From: Kevin Stewart
Sent: Saturday, October 19, 2019 11:44 AM
To: Blum, Catherine <catherine.blum@ncdenr.gov>
Subject: [External] 15A NCAC 03M.0509

CAUTION: External email. Do not click links or open attachments unless you verify. Send all suspicious email as an attachment to report.spam@nc.gov

Dear Ms. Blum,

I am writing in support of the proposed amendment to 15A NCAC 03M.0509 which would prohibit the possession of a Tarpon and make it illegal to gaff, spear or puncture a Tarpon by any means other than a hook and line. In addition, I would encourage the Commission to go one step further and consider adopting regulations which would prohibit removing a Tarpon from the water before it is released.

Why is protecting Tarpon important? Tarpon are a migratory game fish and are typically not caught for consumption. As such, it is important to ensure the survival of a caught Tarpon by requiring (and practicing) proper catch and release techniques. Gaffing or dragging a Tarpon out of the water for a picture often results in the subsequent death of the fish. Other states have adopted similar measures which have greatly enhanced their Tarpon fisheries and related business. There is no reason for North Carolina to not do the same thing.

With a wide variety of species and abundant numbers of fish, North Carolina has a well deserved reputation for being one of the best, if not the best, places to fish. Protecting Tarpon by adopting the proposed amendment is consistent with other actions taken by the Commission to promote North Carolina's fisheries.

Respectfully,

Kevin Stewart
714 Cannonsgate Drive
Newport, NC 28570

Sent from [Mail](#) for Windows 10

From: [Blum, Catherine](#)
To: [Jim Eatman](#)
Subject: RE: [External] Amendment 15A NCAC 03M.0509
Date: Thursday, October 24, 2019 10:23:00 AM

Dear Jim Eatman,

Thank you for taking the time to submit your comments on the Marine Fisheries Commission's proposed changes to the tarpon rule, 15A NCAC 03M .0509. Your comments will be provided to lead staff and to the commission for its consideration prior to voting on final approval of the rule, scheduled for the February 2020 commission meeting.

Catherine

Catherine Blum
Fishery Management Plan and Rulemaking Coordinator
Division of Marine Fisheries
N.C. Department of Environmental Quality

252-808-8014 office
252-726-0254 fax
catherine.blum@ncdenr.gov

P.O. Box 769
3441 Arendell Street
Morehead City, NC 28557-0769



Email correspondence to and from this address is subject to the North Carolina Public Records Law and may be disclosed to third parties.

From: Jim Eatman
Sent: Wednesday, October 23, 2019 4:30 PM
To: Blum, Catherine <catherine.blum@ncdenr.gov>
Subject: [External] Amendment 15A NCAC 03M.0509

CAUTION: External email. Do not click links or open attachments unless you verify. Send all suspicious email as an attachment to report.spam@nc.gov

Ms. Blum,

My name is Jim Eatman and I am writing to you to express my support for Amendment 15A NCAC 03M.0509. I have attached a formal letter which outlines in greater detail the importance of this Amendment and why I adamantly support it. Thank you for your consideration and please feel free to contact me with any questions.

Best,
Jim

James A. Eatman

[REDACTED]
[REDACTED]
[REDACTED]

October 23, 2019

Via Electronic Mail

Ms. Catherine Blum
Marine Fisheries Commission
Catherine.Blum@ncdenr.gov

Dear Ms. Blum,

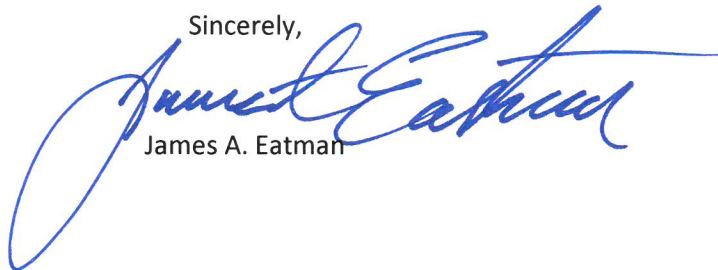
I am writing for to express my utmost support for Amendment 15A NCAC 03M.0509 (the "Amendment"), which will prohibit possession of tarpon and make it illegal to gaff, spear or puncture tarpon by any method other than hook and line.

Tarpon in North Carolina are extremely vulnerable as an overall population due largely to over-harvesting, loss of habitat and poor fish handling practices. By enacting the Amendment, we can address these issues and allow the North Carolina tarpon fishery not only to recover, but eventually to thrive.

Enacting this amendment to protect tarpon would also be an excellent economic decision. Tarpon not only support, but are the mainstay, of valuable recreational fisheries having annual economic impacts counted in the millions of dollars in some other states. North Carolina already draws in millions in tourism dollars from recreational fisherman, and a viable tarpon fishery is likely to exponentially increase those figures. Given the potential growth of the recreational tarpon fishery locally, these proactive measures to both reduce harvest and harm to the fish will help conserve the species and benefit the State of North Carolina and its residents.

For the foregoing reasons, I support Amendment 15A NCAC 03M.0509 and I hope that you will support the Amendment as well. Please feel free to contact me with any questions at [REDACTED] or [REDACTED]

Sincerely,



James A. Eatman

From: [Blum, Catherine](#)
To: [Harrison Mabry](#)
Subject: RE: [External] 15A NACAC 03M.0509
Date: Monday, October 28, 2019 4:44:00 PM

Dear Harrison Mabry,

Thank you for taking the time to submit your comments on the Marine Fisheries Commission's proposed changes to the tarpon rule, 15A NCAC 03M .0509. Your comments will be provided to lead staff and to the commission for its consideration prior to voting on final approval of the rule, scheduled for the February 2020 commission meeting.

Catherine

Catherine Blum
Fishery Management Plan and Rulemaking Coordinator
Division of Marine Fisheries
N.C. Department of Environmental Quality

252-808-8014 office
252-726-0254 fax
catherine.blum@ncdenr.gov

P.O. Box 769
3441 Arendell Street
Morehead City, NC 28557-0769



Email correspondence to and from this address is subject to the North Carolina Public Records Law and may be disclosed to third parties.

From: Harrison Mabry
Sent: Monday, October 28, 2019 1:13 PM
To: Blum, Catherine <catherine.blum@ncdenr.gov>
Subject: [External] 15A NACAC 03M.0509

CAUTION: External email. Do not click links or open attachments unless you verify. Send all suspicious email as an attachment to report.spam@nc.gov

I support Amendment 15A NCAC 03M.0509 to prohibit possession of tarpon and make it illegal to gaff, spear or puncture tarpon by any method other than hook and line. I would hope to see NC come along other states such as Florida that make it illegal to remove a tarpon over 40 inches from the water. Thanks for your consideration.
Harrison

From: [Blum, Catherine](#)
To: [Charles Causey](#)
Subject: RE: [External] 15A NCAC 03M 0509
Date: Tuesday, November 05, 2019 9:50:00 AM

Dear Charles Causey,

Thank you for taking the time to submit your comments on the Marine Fisheries Commission's proposed changes to the tarpon rule, 15A NCAC 03M .0509. Your comments will be provided to lead staff and to the commission for its consideration prior to voting on final approval of the rule, scheduled for the February 2020 commission meeting.

Catherine

Catherine Blum
Fishery Management Plan and Rulemaking Coordinator
Division of Marine Fisheries
N.C. Department of Environmental Quality

252-808-8014 office
252-726-0254 fax
catherine.blum@ncdenr.gov

P.O. Box 769
3441 Arendell Street
Morehead City, NC 28557-0769

Email correspondence to and from this address is subject to the North Carolina Public Records Law and may be disclosed to third parties.

-----Original Message-----

From: Charles Causey
Sent: Monday, November 04, 2019 11:44 AM
To: Blum, Catherine <catherine.blum@ncdenr.gov>
Subject: [External] 15A NCAC 03M 0509

CAUTION: External email. Do not click links or open attachments unless you verify. Send all suspicious email as an attachment to report.spam@nc.gov <<mailto:report.spam@nc.gov>>

Dear Ms. Blum,

I am writing in support of making the Atlantic Tarpon a "catch and release"

Fish, and amending your current rule 15A NCAC 03M 0509 to effect this.

I am a long time tarpon fisherman living in [REDACTED], but born and raised in

[REDACTED] where I visit still. I helped institute catch and release in Florida

In the late eighties and it has had a very positive effect not only on a larger

Fishery, but on the Keys' economy. As my background is finance, the economics

Of this move was important. I have spent approximately 400 days fishing and

Studying these fish. If you wish to discuss aspects of the results of Florida's Rule, please call me at [REDACTED]. Thank you for your consideration.

Sincerely,

Charles Causey

**MARINE FISHERIES COMMISSION
SUMMARY OF PUBLIC HEARING FOR PROPOSED RULES
DIVISION OF MARINE FISHERIES
MOREHEAD CITY CENTRAL DISTRICT OFFICE
MOREHEAD CITY, N.C.
OCT. 23, 2019, 6 PM**

Marine Fisheries Commission: Cameron Boltes

Division of Marine Fisheries Staff: Ashley Bishop, Catherine Blum, Dana Gillikin, Lara Klibansky, Stephanie McNerny, Tina Moore

Public: Jot Owens, Nick Roberts, Kelly Bordeaux, Phillip Ambler

Media: None

Commissioner Cameron Boltes opened the public hearing for Marine Fisheries Commission proposed rules at 6 p.m. He explained that there are changes to two rules proposed by the Marine Fisheries Commission and the effective date of these rules is subject to legislative review per S.L. 2019-198. He said public comments on the proposed rules will be presented to the Marine Fisheries Commission at its Feb. 19-21, 2020 meeting prior to its vote on final approval of the rules. Written comments will be accepted through Dec. 2. He reviewed guidelines of the public hearing process and explained the hearing is a formal process to receive public comments only about the proposed rules as published in the *N.C. Register*.

Division staff member Catherine Blum reviewed the proposed rules by explaining the reason for proposed action for each of the two rules as published in Volume 34, Issue 07 of the *N.C. Register*.

Commissioner Boltes opened the floor for the public to provide comments.

Jot Owens, a full-time fishing guide in the Wilmington area, supports the tarpon rule change. He takes many anglers tarpon fishing and says that it makes up about 10-15% of his annual trips. Tarpon anglers are passionate about these fish and come to North Carolina from all over to catch tarpon. He notes that he is also a finfish tagger for the division and NOAA Fisheries. He has been talking to other anglers and organizations about tarpon migratory patterns to try to figure out what is going on. He said these fish are killed from time to time because they are being used for bait or do not survive after being handled. The Union for Conservation of Nature has classified the tarpon as vulnerable and stocks are down by about 30% due to overfishing in some areas, habitat loss, and harmful fish handling practices. Tarpon are highly vulnerable and recreationally valued fish into the millions of dollars in other states. He said that it is our duty to protect these highly migratory fish while they are in our waters.

Nick Roberts is a native of North Carolina and worked for many years as a fishing guide in North Carolina. He said he is representing the Bonefish and Tarpon Trust (BTT), based in Miami, Florida. He said BTT is a science-based conservation organization working to conserve gamefish species, including tarpon. BTT's efforts focus on the species, their habitats, and the effective management of the tarpon fishery locally and regionally. BTT supports the tarpon rule change to prohibit the possession of tarpon and to make it illegal to gaff, spear, or puncture a tarpon by any method other than hook and line. They support this change for many reasons. 1) The Atlantic tarpon have been classified as vulnerable by the International Union of Conservation of Nature due to overharvest, loss of habitat, and detrimental fish handling practices. 2) Tarpon in North Carolina waters are part of a larger regional fishery that could have

originated as far south as the Florida Keys. The harvest of tarpon impacts the recreational fishery locally and regionally. 3) Tarpon are long-lived and slow to reach sexual maturity and harvest can further accelerate losses in the population. 4) Lip gaffing and other puncturing methods reduce the tarpon feeding and increase catch and release mortality. 5) Economic impacts of the tarpon counted in the millions in other states. Proactive measures to reduce harm and harvest of the fish will help conserve the species and benefit the state of North Carolina.

Kelly Bordeaux spoke on behalf of several recreational anglers from Beaufort, North Carolina. He and his group have been fishing for over 35 years and fish for tarpon on the Neuse River and in Pamlico Sound. They have two tournaments each summer that bring in about 20 boats, which boosts the economic impact of the recreational fishery. Poor handling practices will cause a decline in the fishery, which will negatively affect participation and the economy. He has been involved with research at the University of Miami, including a 2008 tag that was recovered in North Carolina in September 2019. He believes there is no commercial value in the tarpon fishery. He said it is a good thing if we can eliminate the chance of losing a few fish to poor handling practices.

Phillip Ambler said it would save a lot of fish if you would not be allowed to take the fish on the boat and if you have to use circle hooks only. He did it for red drum and said that hundreds were saved by not using J-hooks. Many years ago, he tagged fish from the Florida Keys and had tags come all the way from Havana, Cuba. He said they have been losing a lot of fish in the Pamlico Sound. Many that were tagged went to the Chesapeake; the fish have gone north. He said fishing is down to about 10% of what is used to be over the last 10 years. He said to leave the fish in the water, but he does not know how that would work for pier fishing.

Hearing no further comments on the proposed rules, Commissioner Boltes closed the hearing at 6:20 p.m.

/jl

Reclassification of Special Secondary Nursery Areas to Permanent Secondary Nursery Areas Issue Paper

Jan. 27, 2020

I. ISSUE

The consideration of changing the designation of special secondary nursery areas (SSNAs) that have not been opened to trawling since 1991 to permanent secondary nursery areas (SNAs)

II. ORIGINATION

The North Carolina Shrimp Fishery Management Plan (FMP) Amendment 1 and the North Carolina Marine Fisheries Commission (MFC)

III. BACKGROUND

In February 2015, the Shrimp FMP Amendment 1 and its rules were adopted by the MFC. The focus of Amendment 1 was to address bycatch in the commercial and recreational shrimp fishery (NCDFM 2015a). Management options examined in the FMP were separated into 1) gear modifications; 2) effort management; 3) area restrictions; and 4) the use of other fishing gears. For each of these management options, issue papers were developed and presented to the Shrimp FMP Advisory Committee (AC), as well as the regional and standing advisory committees of the MFC. Area restrictions to reduce shrimp trawl bycatch were evaluated for all internal coastal waters, Pamlico Sound and its adjacent tributaries, SSNAs, and portions of Brunswick County. With the adoption of Amendment 1, shrimp trawling was prohibited in the Intracoastal Waterway (IWW) channel from Sunset Beach to the South Carolina state line, including Eastern Channel, lower Calabash River and Shallotte River, and was supported by both the Division and Shrimp FMP AC. Prior to the adoption of Amendment 1, these areas were not opened for 10 to 12 years due to the abundance of small fish and shrimp. In addition to the area closure, the MFC also recommended that the MFC Habitat and Water Quality Advisory Committee (AC) provide input on changing the designation of certain SSNAs that have not been opened to trawling since 1991 to permanent SNAs. This recommendation was also supported by the Division and adopted by the MFC. The Shrimp FMP AC did not provide a recommendation for this management option.

A petition for rulemaking was submitted to the Marine Fisheries Commission in November 2016 that potentially overlapped with the issue of changing the designation of SSNAs and a second petition was submitted in May 2019. Due to continuing petition issues, rule action was held until the petitions were resolved. Both rulemaking petitions have been resolved and neither one resulted in rulemaking. To comply with the selected action on this issue in Shrimp FMP Amendment 1 this Issue Paper was drafted and begins the process for rule consideration as part of the 2020-2021 rule cycle.

Primary nursery areas (PNAs), SNAs, and SSNAs are defined in MFC Rule 15A NCAC 03I .0101 and designated in 15A NCAC 03R .0103, .0104, and .0105. It is unlawful to use any trawl net, long haul seine, swipe net, dredge, or mechanical method for clams or oysters for the purpose of taking any marine fishes in PNAs. In SNAs, it is unlawful to use trawl nets for any purpose. However, in SSNAs the Fisheries Director, may, by proclamation, open any or all of the SSNAs, or any portion thereof to shrimp or crab trawling from August 16 through May 14. The intent of these rules and proclamations is to protect this nursery habitat for young finfish and crustaceans as well as developing sub-adults. By allowing limited trawling in SSNAs, fishermen are allowed to catch shrimp late in the season that have not migrated out into the larger estuaries. The opening and closing of SSNAs is based on the size and the amount of the shrimp and finfish presence. The division conducts regular sampling to monitor shrimp size and abundance as well as the abundance of bycatch if the area is being considered for opening. Target sizes (count of shrimp per pound heads-on) differ by waterbody within the state to account for variability of boat sizes, size preferences of user groups, geographical differences in shrimp size at migration, weather events, and socioeconomic conditions. The opening and closing of these SSNAs can be highly influenced by environmental conditions and their proximity to major inlets and rivers, as well as stakeholder input.

There are approximately 37,400 acres of SSNAs in North Carolina; however, several of these areas have not opened since the 1990s (Table 1). In the Pamlico and Pungo rivers, these SSNAs include: Pungo, Scranton, Slade, South, and Bond/Muddy creeks (Figure 1). Currently, the use of shrimp trawls (not crab trawls) is prohibited in the Pungo River upstream of a line from

Wades Point to Abel Bay and in the Pamlico River upstream of a line from Wades Point to the western shore entrance of Goose Creek. However, in November 2019, the MFC selected the preferred management action to prohibit the use of crab trawls in areas where shrimp trawls are already prohibited in the Pamlico, Pungo, and Neuse Rivers (15A NCAC 03R .0114). Thus, reclassifying these areas as permanent SNAs would not further impact crab trawling once Amendment 3 of the Blue Crab FMP is adopted in 2020.

Following the adoption of the 2006 Shrimp FMP, the Newport River SSNA was closed as a result of the Trawl Nets Prohibited Area (TNPA) designation (Hardesty Farm line) becoming a permanent line by rule (MFC Rule 15A NCAC 03R .0106(7); Figure 2). The Fisheries Director no longer has the authority to open these SSNAs since they are upstream of the permanent shrimp trawls prohibited and TNPA lines established by the Shrimp FMP. The SSNAs in the lower Cape Fear River, Lockwood Folly River, and Saucepan Creek have not opened since the late 1980s (Figures 3 and 4). Division sampling has shown that shrimp in these areas rarely reach large sizes with the heads-on count being greater than 60 throughout the season; the target size for this area is 40-50 count.

Table 1. Special secondary nursery areas (SSNA) that have not been opened.

Current Rule ID 03R .0105	Description	Year Designated (reclassified)	Latest Year Opened	Proclamation Reference
2 (a)	Pungo Creek*	1989	1990	SH-22-90
2 (b)	Scranton Creek*	1989	1990	SH-22-90
2 (c)	Slade Creek*	1989	1990	SH-22-90
2 (d)	South Creek*	1989	1990	SH-22-90
2 (e)	Bond Creek/Muddy Creek*	1989	1990	SH-22-90
6	Newport River*	1991	2004	SH-4-2003
10	Cape Fear River**	1986	-	None
11	Lockwood Folly River**	1986	-	None
12	Saucepan Creek**	1986	-	None

* Fisheries Director no longer has authority to open to shrimp trawls due to line changes from rule 15A NCAC 03R .0106(7) and 15A NCAC 03R .0114 (1) & (2)

** Not opened after SSNA designation

IV. AUTHORITY

- § 113-134. Rules
- § 113-173. Recreational Commercial Gear License
- § 113-182. Regulation of fishing and fisheries
- § 113-182.1 Fishery Management Plans
- § 113-221.1 Proclamations; emergency review
- § 143B-289.52 Marine Fisheries Commission - powers and duties

- 15 NCAC 03J .0103 Gill nets, seines, identification, restrictions
- 15 NCAC 03N .0105 Prohibited gear, secondary nursery areas

V. DISCUSSION

Area restrictions for trawling have been used to deal with allocation, resource, bycatch, habitat, and safety issues in North Carolina. Since 1978 almost one million acres of estuarine waters have been closed to trawling through nursery area designations (PNA and SNA), military danger zones and restricted areas, and trawl net prohibited areas. In the North River and Ward Creek SSNAs, permanent closures occurred through public negotiations to resolve the constant movement of lines where shrimp trawling was allowed. These closures eliminated confusion over lines continually moving and provided additional habitat protection from bottom disturbing gear. The movement of the shrimp trawl lines in the Pamlico, Pungo, and

Newport rivers has also prohibited the use of shrimp trawls upstream of the permanent lines, thus protecting habitat used by juvenile spot (*Leiostomus xanthurus*), Atlantic croaker (*Micropogonias undulatus*), shrimp, blue crab (*Callinectes sapidus*), and southern flounder (*Paralichthys lethostigma*). The closure of the Newport River SSNA also provided additional protection to shellfish leases, cultch planting sites, and natural oyster rock located in the SSNA. The most recent closure of the IWW channel from Sunset Beach to the South Carolina state line as well as the SSNAs in Eastern Channel, lower Calabash River, and Shallotte River provide further protection to habitats used by juvenile finfish and crustaceans. These closures will eliminate future bycatch and bottom habitat disturbance since they will be permanently closed to shrimp trawling. However, because most of these areas have been closed for well over two decades, the overall reduction in potential bycatch cannot be quantified.

Changing the designation of the SSNAs listed in Table 1, will have no impact to commercial shrimping since there has been no shrimp trawling in most of these areas since 1990. However, by re-designating these areas to permanent SNAs, crab trawling will no longer be allowed in these areas. However, as noted previously, crab trawling areas in the Pamlico, Pungo, and Neuse Rivers are slated for elimination with the adoption of Amendment 3 of the Blue Crab FMP in 2020. Statewide, effort in the crab trawl fishery has been low in recent years with the number trips ranging from 180 to 470 per year from 2014 to 2016 (NCDMF 2019). The majority of the effort occurs in portions of the Pamlico Sound and the Pamlico, Pungo, and Neuse rivers. Currently, there is no crab trawling in Cape Fear River, Lockwood Folly River, and Saucepan Creek. While the habitat impacts from crab trawling are thought to be limited due to the low amount of effort, studies have shown that crab trawls elevate turbidity and cause structural damage or loss to benthic habitats such as submerged aquatic vegetation and oyster reefs (NCDEQ 2016). Not allowing crab trawling in these areas would provide further protection to critical habitats used by numerous economically important species of fish and invertebrates as well as other prey species. Furthermore, eliminating bottom disturbing gear such as crab and shrimp trawling in these areas would provide additional protection to significant portions of MFC approved Strategic Habitat Areas (SHA). Draft Amendment 3 to the NC Blue Crab FMP (NCDMF 2019) notes that prohibition of blue crab harvest by use of crab and shrimp trawls would have minimal economic effects on the fishery, while addressing fishery and habitat level concerns of these gears.

Attendance requirements for gill nets could also change if the designation of these SSNAs were reclassified to permanent SNAs (see Table 2). MFC Rules 15A NCAC 03J .0103 and 03R .0112 require the attendance of small mesh gill nets in all permanent SNAs, but not in SSNAs. Rule 15A NCAC 03J .0103 was established in October 1999 and at the time contained a list of areas where seasonal small mesh gill net attendance was required. The list of areas was moved to 03R .0112 in 2004. The 2001 Red Drum FMP contained measures for reducing red drum (*Sciaenops ocellatus*) bycatch from small mesh gill nets through attendance requirements (NCDMF 2001). The plan implemented small mesh gill net attendance from May 1 through October 31 (later extended through November) in areas where juvenile red drum typically occur, in shallow bays and creeks, shorelines, and over shallow grass beds. Additionally, the South Atlantic Fishery Management Council (SAFMC) designated specific inshore areas in the south Atlantic region as Essential Fish Habitat (EFH) and Habitat Areas of Particular Concern (HAPC) in their Habitat Plan for red drum (SAFMC 1998). In North Carolina, these federal areas included all state-designated nursery habitats of particular importance for red drum (i.e., all PNAs and all SNAs). When the gill net attendance rule language was adopted it covered areas listed as PNAs and SNAs, but not SSNAs. The stated rationale for red drum bycatch reduction would apply to any SNA (past or future). The SSNAs in the lower Cape Fear River, Lockwood Folly River, and Saucepan Creek, with a change to permanent SNAs, would require additional attendance in all waters (not just 50 yards from the shoreline) from May through November, unless exempted from the gill net attendance rule 15A NCAC 03R .0112 (Table 2).

Following the adoption of the 2006 Shrimp FMP (NCDMF 2006), an issue occurred in a portion of the Newport River upstream of the “Hardesty Farm line” after it was classified as a trawl net prohibited area (TNPA) under MFC Rule 15A NCAC 03R .0106(7). While the new designation served the desired purpose of prohibiting trawling upstream of that line, it created an inconsistency with MFC Rule 15A NCAC 03N .0105(b) concerning existing SSNA designation which allowed for seasonal openings of shrimp trawling within the area inside the TNPA. With the adoption of Amendment 1 to the Striped Mullet FMP (NCDMF 2015b), inconsistencies with gill net attendance rules within the Newport River TNPA were resolved by removing the Newport River TNPA reference from MFC Rule 15A NCAC 03R .0112(b)(1), but leaving it subject to 03R .0112(b)(5). By doing this, the striped mullet (*Mugil cephalus*) fishery as well as the other small mesh gill net fisheries could continue to operate, while still prohibiting trawling as intended in the 2006 Shrimp FMP. If the Newport River SSNA is changed to a permanent SNA, the inconsistency with proclamation authority to open the area to trawling which is in a TNPA is corrected, but the change would require May through November small mesh gill net attendance.

The current gill net attendance requirements for each SSNA are visualized in Figures 5-10. If the SSNAs are reclassified to permanent SNAs, consideration could be given to whether they should or should not be subject to MFC Rule 03R .0112(b)(1). Additional rule changes may be required based on this need. Areas could only be subject to MFC Rule 03R .0112(b)(5), which requires gill net attendance (<5 inch stretched mesh) within 50 yards of shore from May 1 through September 30 for the southern areas if exemption wording for these SNAs is added to MFC Rule 03R .0112(b)(1). For the SNAs in the Pamlico and Pungo rivers, if exemption wording is not added to MFC Rule 03R .0112(b)(1) then these SNAs would be required to have gill net attendance (<5 inch stretched mesh) in all waters from May 1 through November 30 and within 200 yards of shore from December 1 through April 30 [except for Scranton Creek which already has year-round gill net attendance (<5 inch stretched mesh) in all waters]. However, if these areas are made permanent SNAs, other fisheries and FMPs could be impacted. MFC Rule 15A 03N .0105 prohibits the use of trawl nets for any purpose in permanent SNAs, thus the Blue Crab FMP would be impacted and crab trawling would be prohibited in these areas. Another option is to reclassify the SSNAs in Table 1 as TNPAs. By doing this, issues associated with gill net attendance would be avoided, while prohibiting shrimp trawling as recommended by Amendment 1 to the Shrimp FMP. However, making these areas TNPAs, they would lose their designation as “nursery areas”. Maintaining the designation of SNA, rather than TNPA, makes the basis for no trawling clear to stakeholders. Additionally, the nursery designation allows future opportunities for protections from habitat related impacts associated with development activities through actions by other agencies. Another option would be for these areas to keep their current designation as SSNAs and remain closed to shrimp trawling unless changed in subsequent Shrimp FMP amendments.

Table 2. Current and potential gill net attendance requirement changes (<5 inch stretched mesh) for each special secondary nursery area under consideration for reclassification by management option.

Management Options	Special Secondary Nursery Area								
	Pungo Creek	Scranton Creek	Slade Creek	South Creek	Bond and Muddy creeks	Newport River	Cape Fear River	Lockwood Folly River	Saucepan Creek
Current gill net attendance requirements	Year-round attendance within 200 yards of shore	Year-round attendance in all waters	Year-round attendance within 200 yards of shore	Year-round attendance within 200 yards of shore	Year-round attendance within 200 yards of shore	Attendance within 50 yards of shore from May 1 - September 30	Attendance within 50 yards of shore from May 1 - September 30	Attendance within 50 yards of shore from May 1 - September 30	Attendance within 50 yards of shore from May 1 - September 30
Option 1: Remain as SSNAs*	No change	No change	No change	No change	No change	No change	No change	No change	No change
Option 2: Reclassify as SNAs with gill net attendance	Year-round attendance within 200 yards of shore and attendance in all waters from May 1 - November 30	No Change	Year-round attendance within 200 yards of shore and attendance in all waters from May 1 - November 30	Year-round attendance within 200 yards of shore and attendance in all waters from May 1 - November 30	Year-round attendance within 200 yards of shore and attendance in all waters from May 1 - November 30	Extends gill net attendance period in all waters from May 1 - November 30	Extends gill net attendance period in all waters from May 1 - November 30	Extends gill net attendance period in all waters from May 1 - November 30	Extends gill net attendance period in all waters from May 1 - November 30
Option 3: Reclassify as SNAs [±] with gill net attendance exemption	No change	No change	No change	No change	No change	No change	No change	No change	No change
Option 4: Reclassify as TNPA [†]	No change	No change	No change	No change	No change	No change	No change	No change	No change

* *Special Secondary Nursery Area*

[±] *Secondary Nursery Area*

[†] *Trawl Net Prohibited Area*

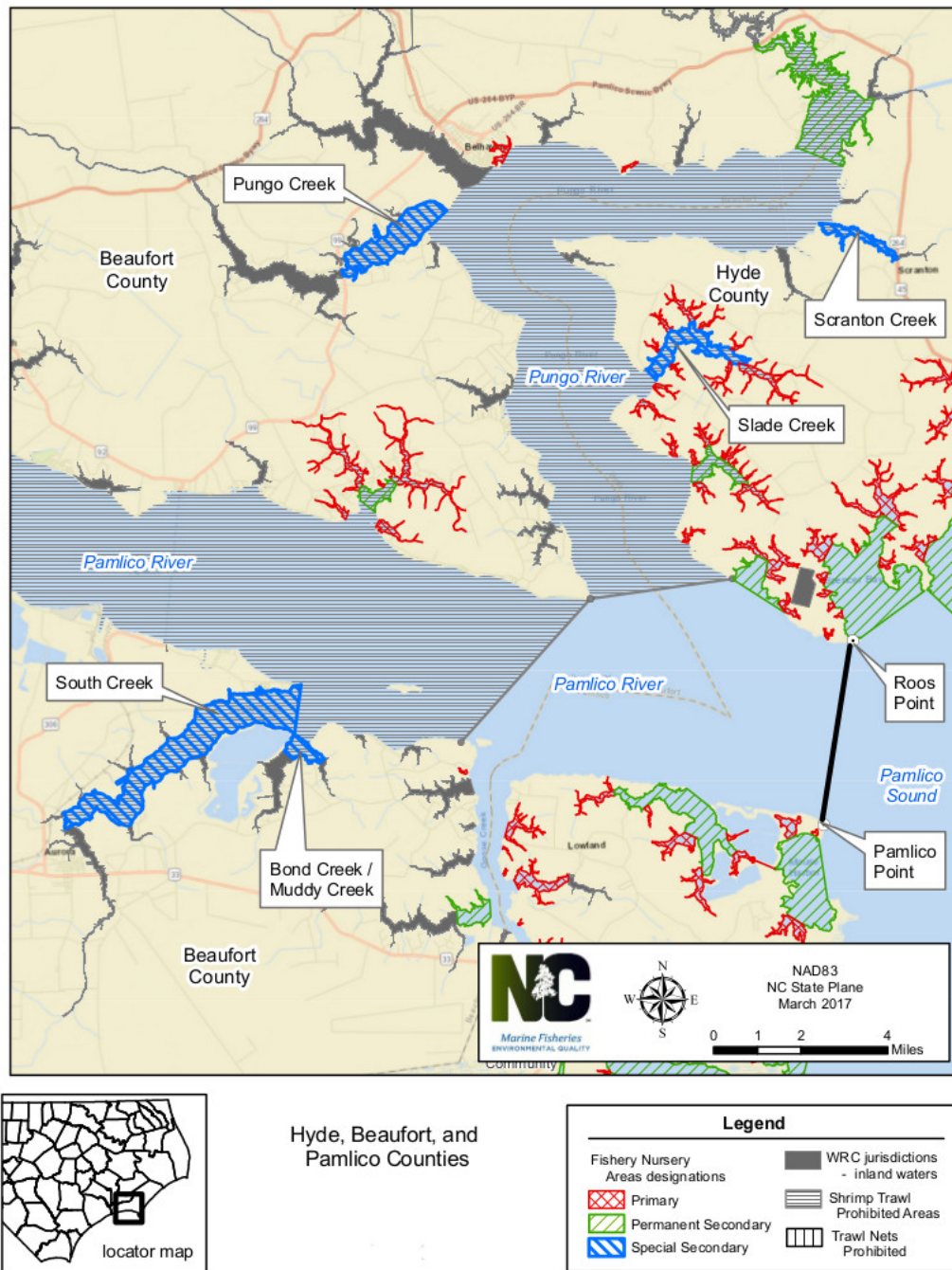
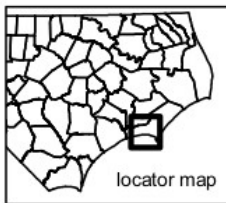
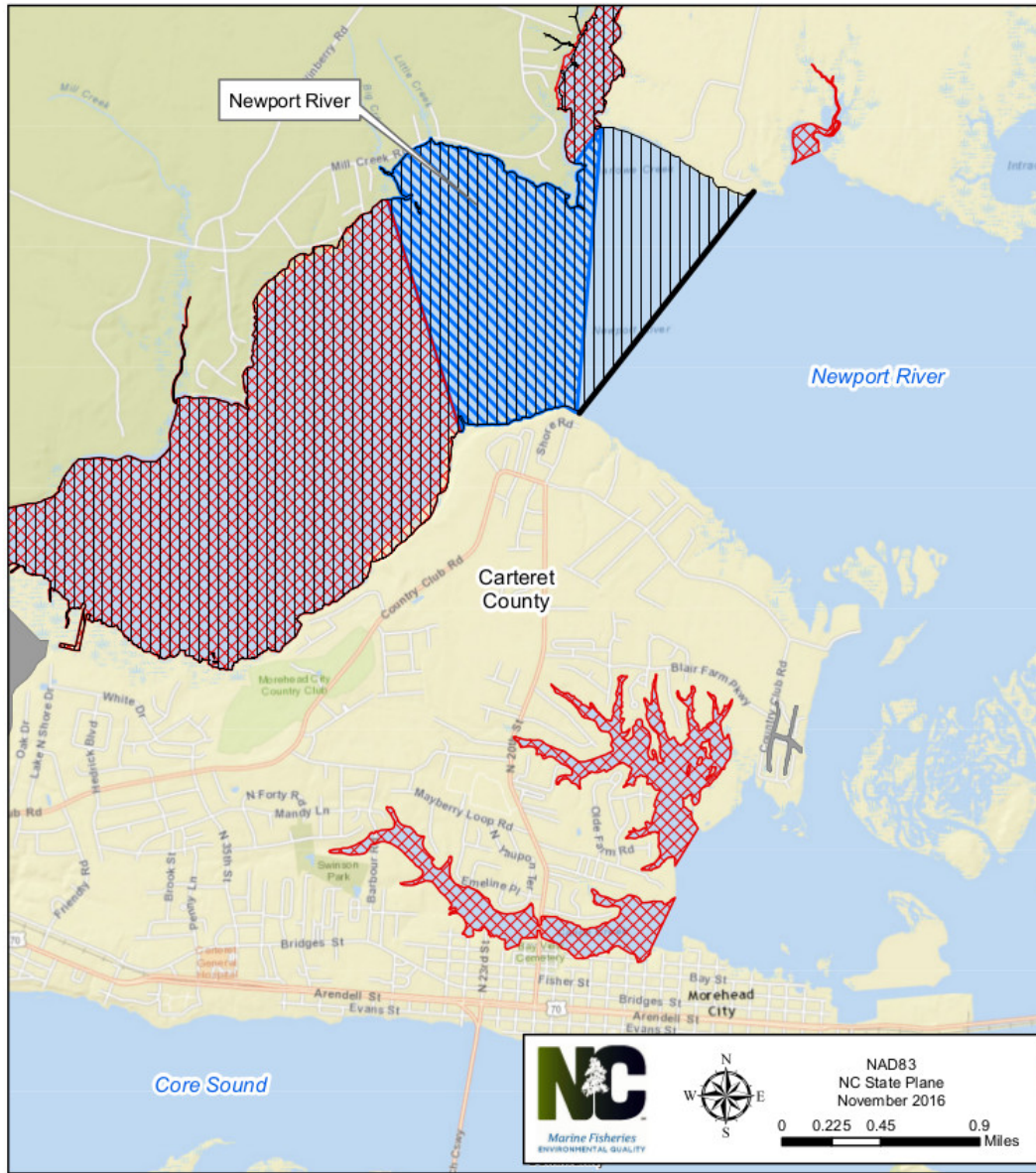


Figure 1. Map of the shrimp management and nursery areas in the Pamlico and Pungo rivers. Areas to the west of the line beginning at Roos Point to Pamlico Point are subject to gill net attendance rules (<5 inch stretched mesh). Gill net attendance will be required in all areas marked as special secondary nursery areas (SSNAs) from May 1 through November 30 if their designation is changed to permanent secondary nursery areas (SNAs). Year-round attendance (<5 inch stretched mesh) is already required in Scranton Creek.



Carteret County

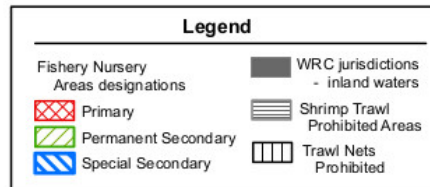
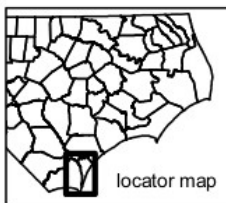
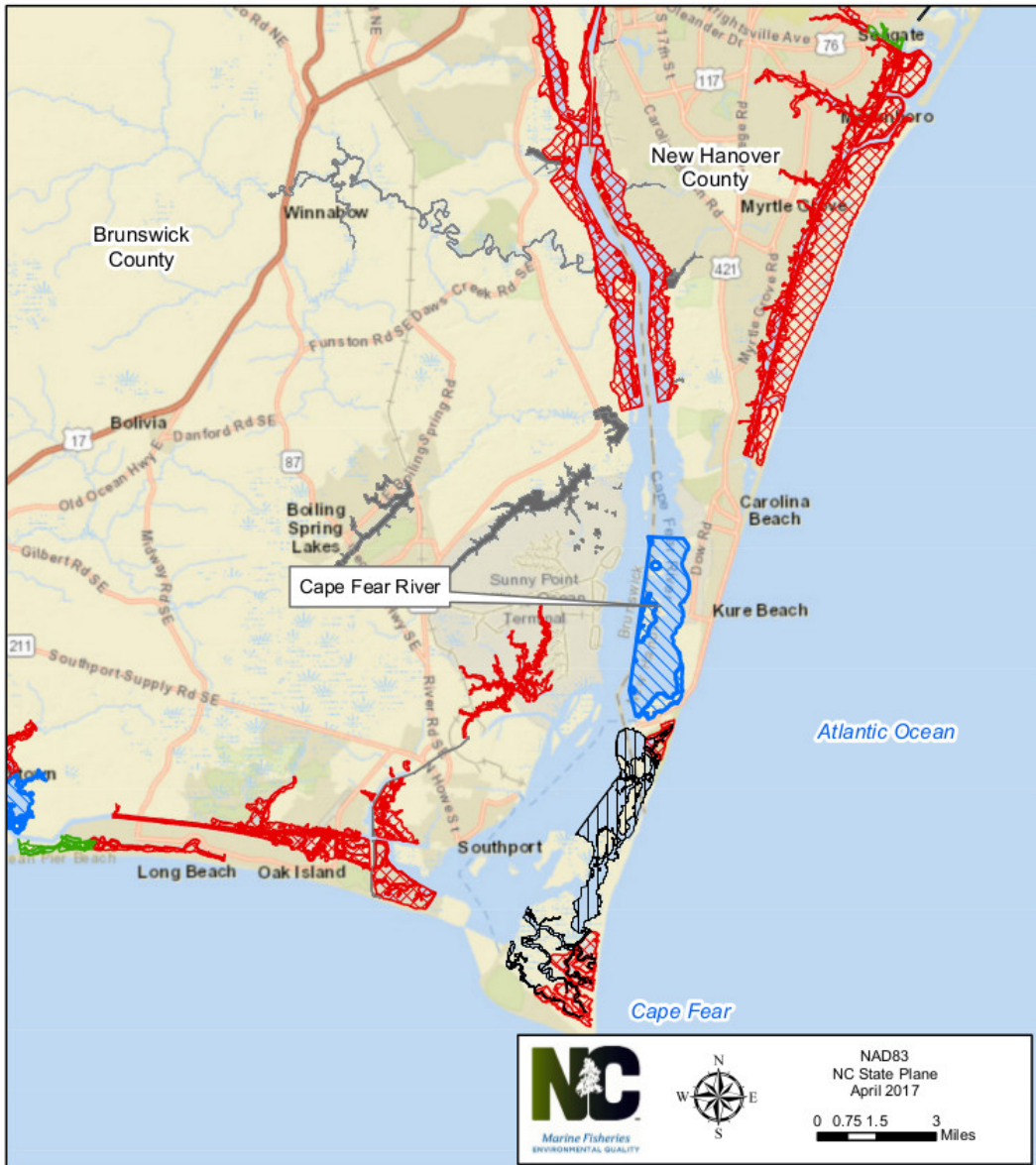


Figure 2. Map of the shrimp management and nursery areas in the Newport River. Gill net attendance (<5 inch stretched mesh) will be required in all areas marked as special secondary nursery areas (SSNAs) from May 1 through November 30 if their designation is changed to permanent secondary nursery areas (SNAs).



Brunswick County
and
New Hanover County

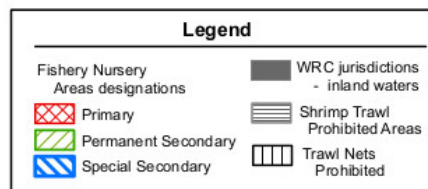
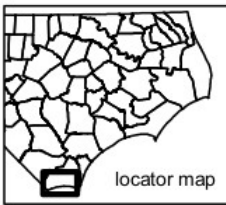
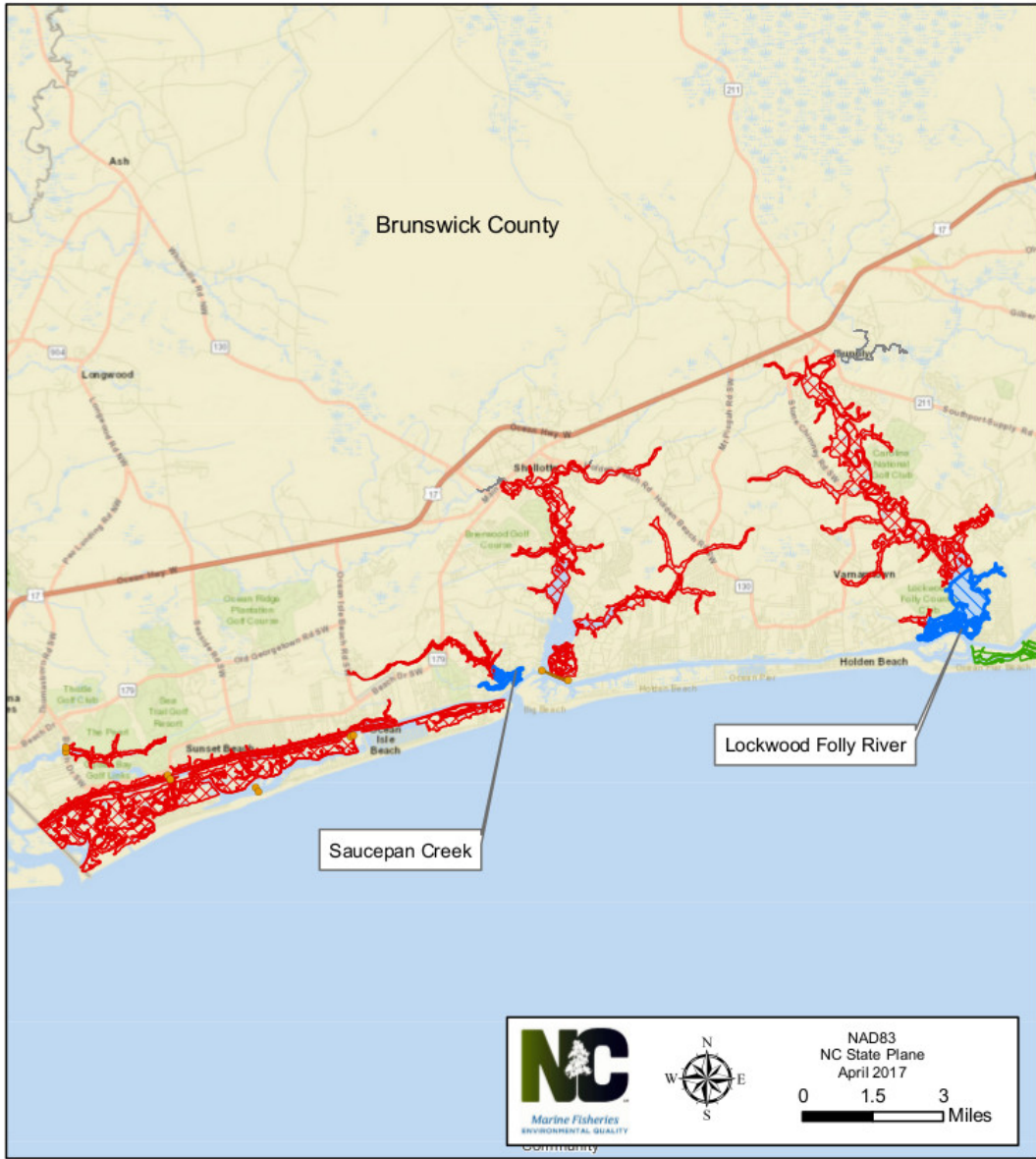


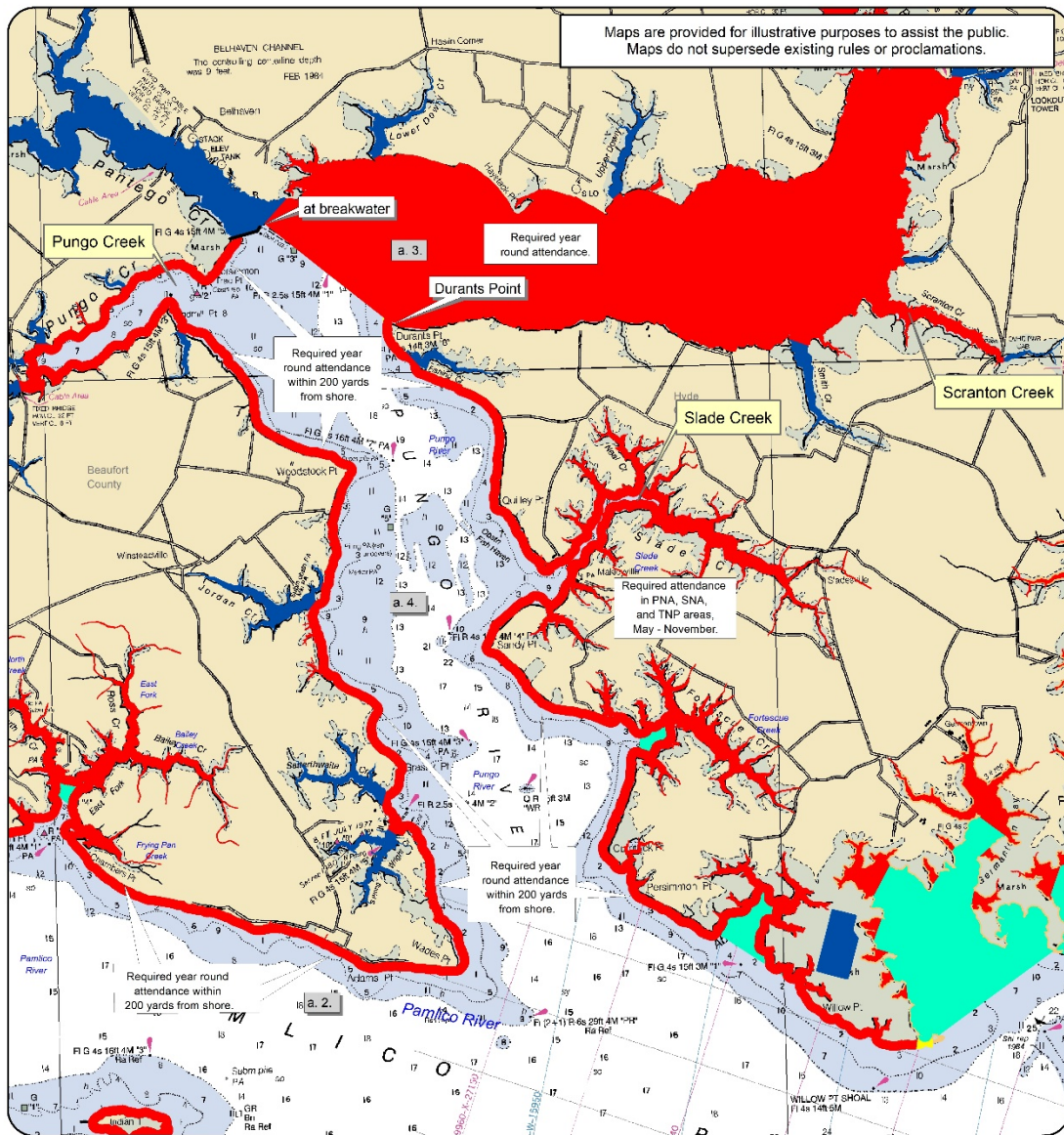
Figure 3. Map of the shrimp management and nursery areas in the Cape Fear River. Gill net attendance (<5 inch stretched mesh) will be required in all areas marked as special secondary nursery areas (SSNAs) from May 1 through November 30 if their designation is changed to permanent secondary nursery areas (SNAs).



Brunswick County

Legend	
Fishery Nursery Areas designations	WRC jurisdictions - inland waters
Primary	Shrimp Trawl Prohibited Areas
Permanent Secondary	Trawl Nets Prohibited
Special Secondary	

Figure 4. Map of the shrimp management and nursery areas in Brunswick County. Gill net attendance (<5 inch stretched mesh) will be required in all areas marked as special secondary nursery areas (SSNAs) from May 1 through November 30 if their designation is changed to permanent secondary nursery areas (SNAs).



Maps are provided for illustrative purposes to assist the public. Maps do not supersede existing rules or proclamations.

Background maps are NOAA nautical charts.

Attended Gill Net Areas for Gill Nets Less Than 5 Inches Mesh Length

- WRC Waters - Gill net prohibited
- Required year round attendance area
- Attendance May- September - 50 yards from shore
- Attendance May - November
- Attendance May - November - 200 yards from shore
- Attendance May - November 50 yards from shore



0 0.5 1 Miles

Datum: NAD83
Projection: NC State Plane
Map Date: November 2019

North Carolina DEQ - Division of Marine Fisheries

Figure 5. Map of current gill net attendance (<5 inch stretched mesh) and primary and permanent secondary nursery areas in Pungo, Scranton, and Slade creeks.

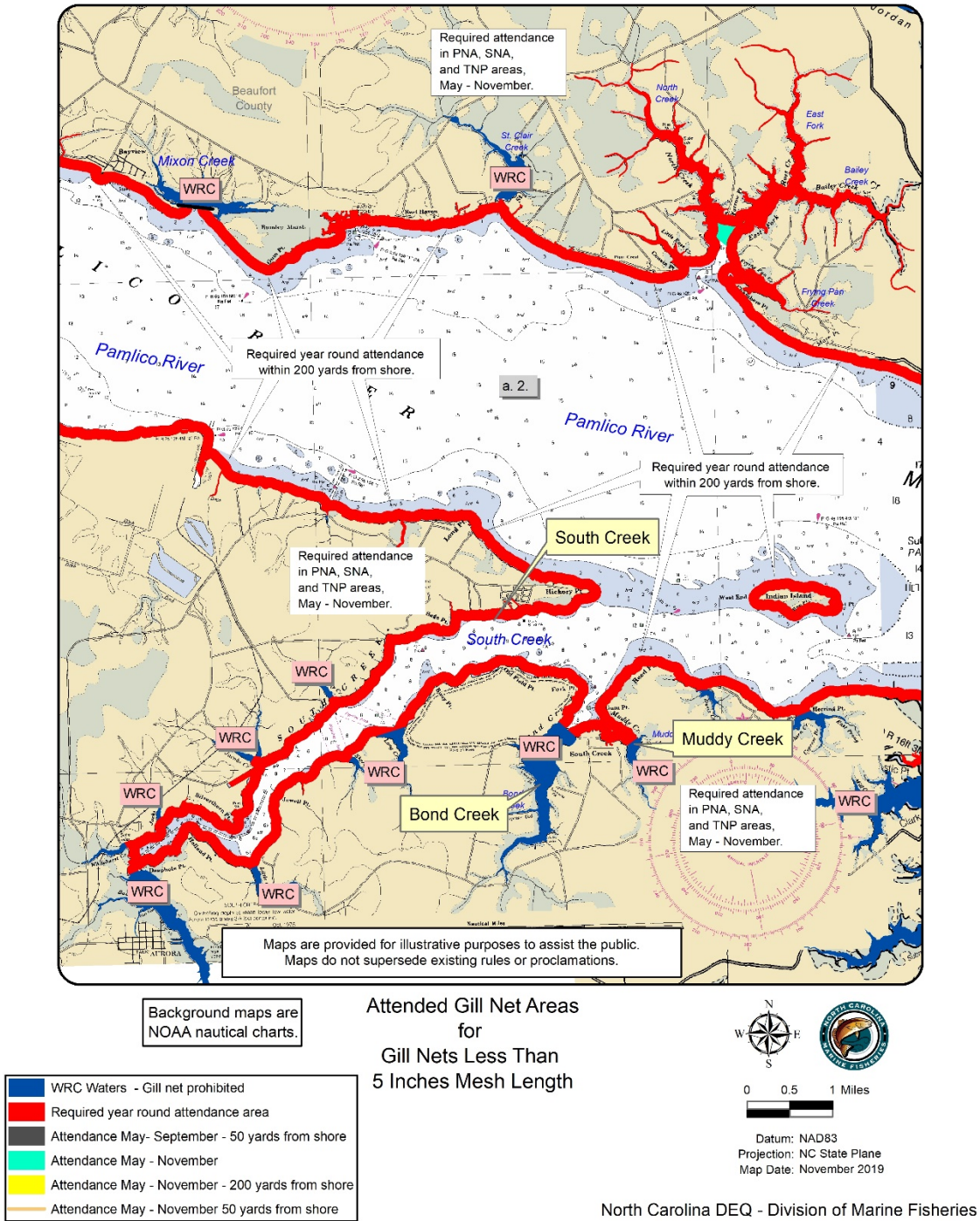


Figure 6. Map of current gill net attendance (<5 inch stretched mesh) and primary and permanent secondary nursery areas in South, Bond, and Muddy Creeks.

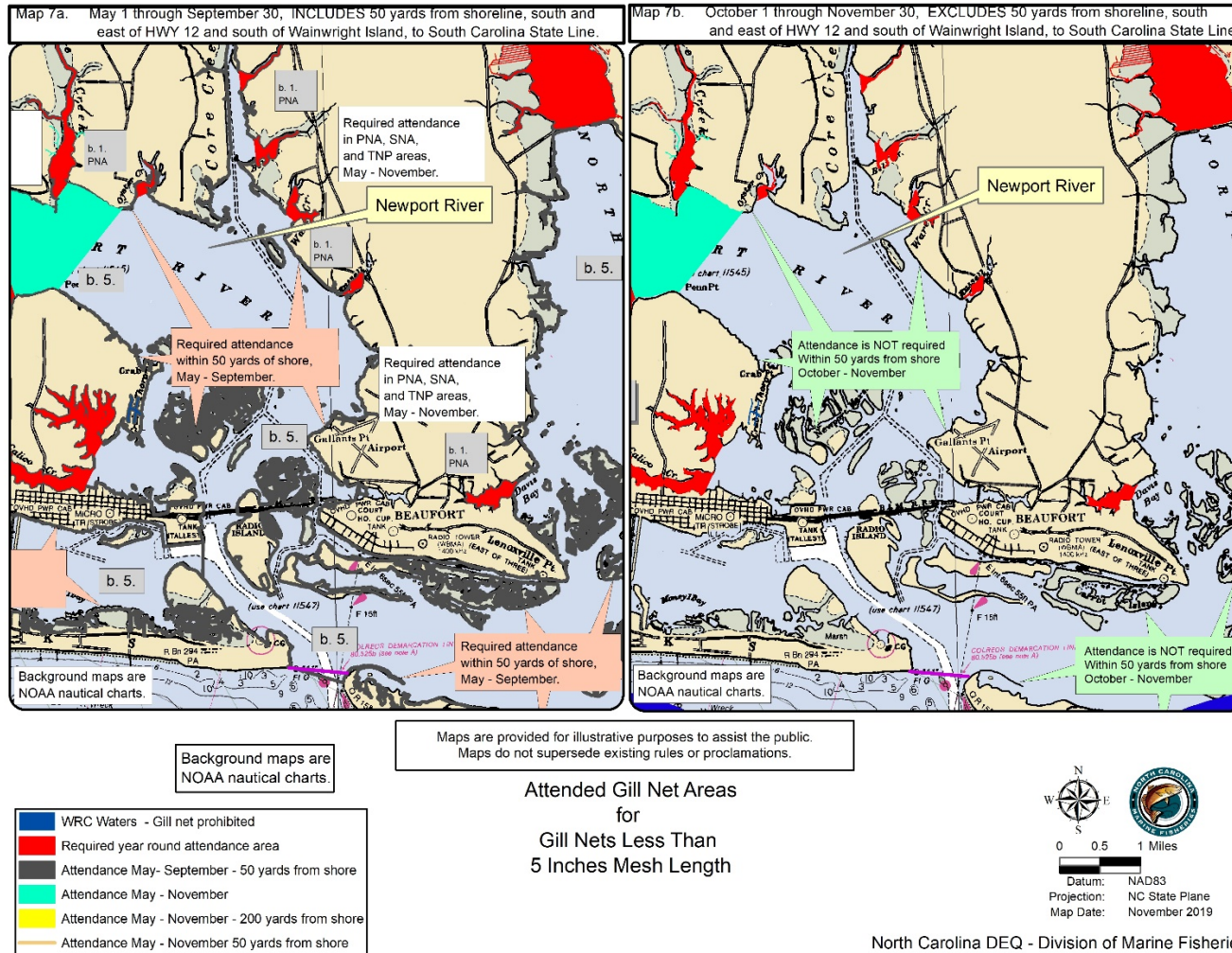


Figure 7. Map of current gill net attendance (<5 inch stretched mesh) and nursery areas in the Newport River.

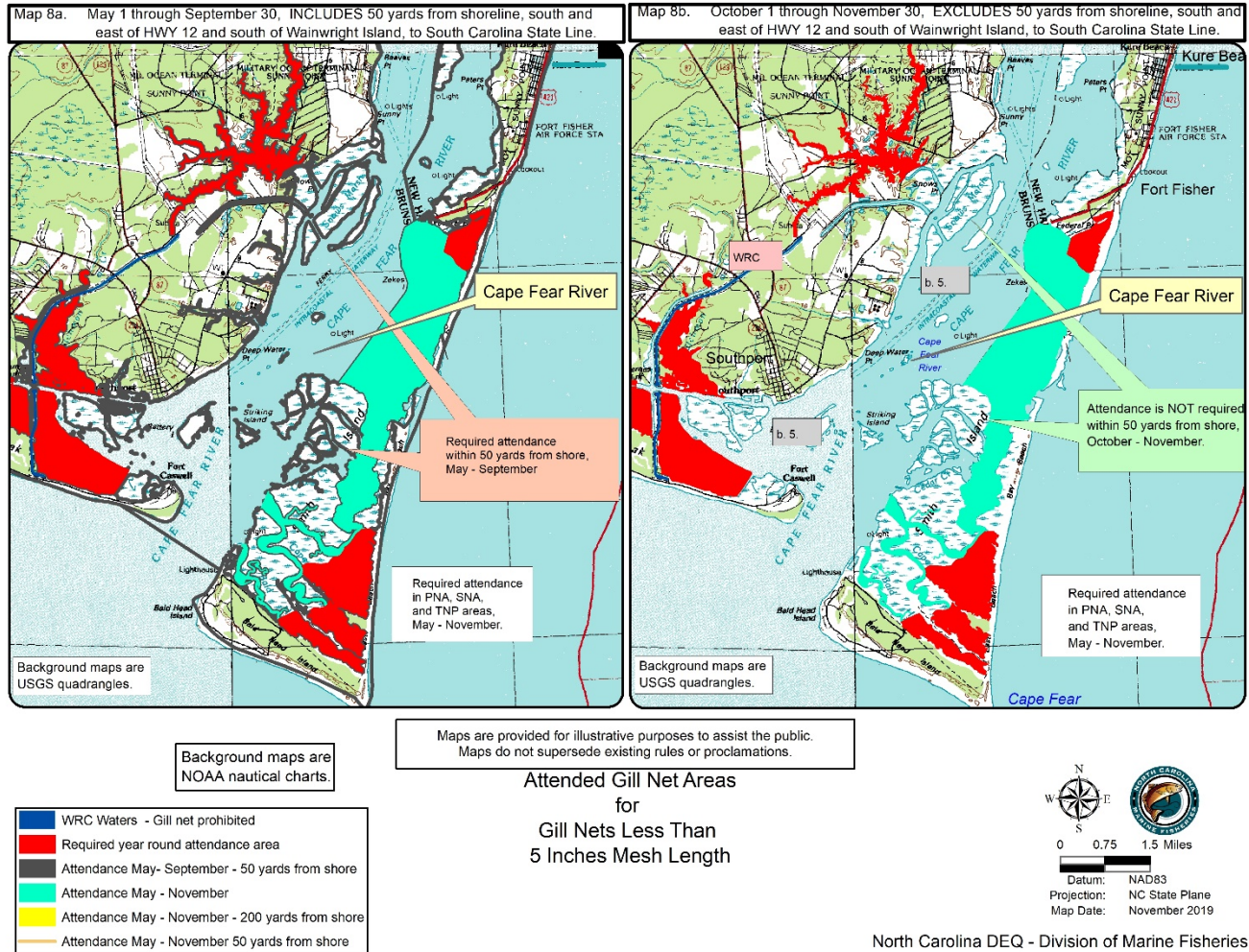


Figure 8. Map of current gill net attendance (<5 inch stretched mesh) and nursery areas in the Cape Fear River.

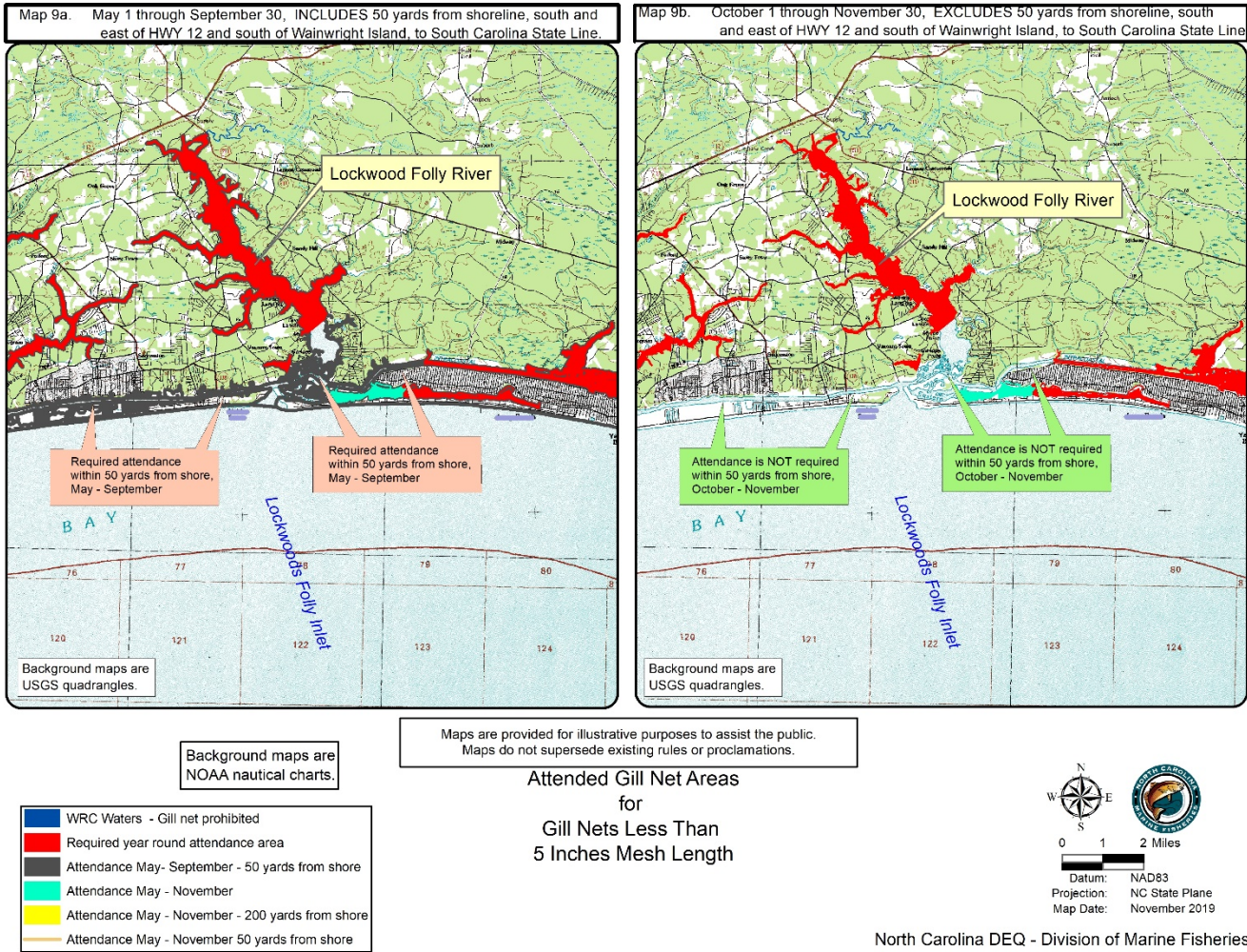


Figure 9. Map of current gill net attendance (<5 inch stretched mesh) and nursery areas in the Lockwood Folly River.

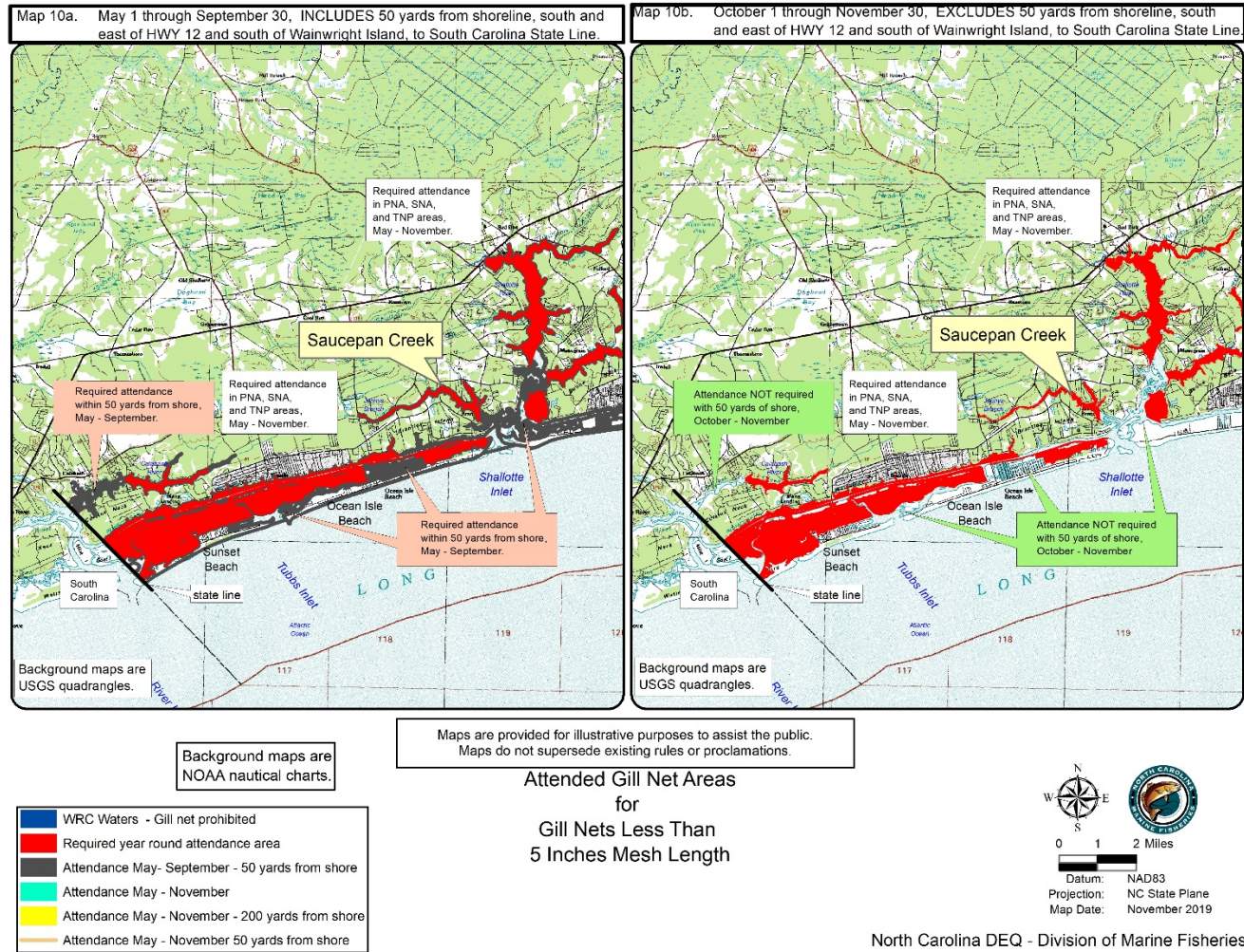


Figure 10. Map of current gill net attendance (<5 inch stretched mesh) and nursery areas in Saucepan Creek.

VI. PROPOSED RULE(S)

Options 2 and 3:

15A NCAC 03R .0104 PERMANENT SECONDARY NURSERY AREAS

The permanent secondary nursery areas referenced in 15A NCAC 03N .0105(a) are delineated in the following coastal water areas:

- (1) Roanoke Sound:
Inner Shallowbag Bay - west of a line beginning on the northeast shore at a point 35° 54.6729' N – 75° 39.8099' W; running southerly to the southeast shore to a point 35° 54.1722' N – 75° 39.6806' W;
- (2) ~~In~~ in the Pamlico Long Sound Area:
 - (a) Long Shoal River - north of a line beginning at the 5th Avenue Canal at a point 35° 35.2120' N – 75° 53.2232' W; running easterly to the east shore on Pains Point to a point 35° 35.0666' N – 75° 51.2000' W;
 - (b) Pains Bay - east of a line beginning on Pains Point at a point 35° 35.0666' N – 75° 51.2000' W; running southerly to Rawls Island to a point 35° 34.4666' N – 75° 50.9666' W; running easterly to the east shore to a point 35° 34.2309' N – 75° 50.2695' W;
 - (c) Wysocking Bay - northwest of a line beginning at Benson Point at a point 35° 22.9684' N – 76° 03.7129' W; running northeasterly to Long Point to a point 35° 24.6895' N – 76° 01.3155' W;
 - (d) Juniper Bay-Cunning Harbor - north of a line beginning on the west shore of Juniper Bay at a point 35° 20.6217' N – 76° 15.5447' W; running easterly to a point 35° 20.4372' N – 76° 13.2697' W; running easterly to the east shore of Cunning Harbor to a point 35° 20.3413' N – 76° 12.3378' W;
 - (e) Swanquarter Bay - north of a line beginning at The Narrows at a point 35° 20.9500' N – 76° 20.6409' W; running easterly to the east shore to a point 35° 21.5959' N – 76° 18.3580' W;
 - (f) Deep Cove - The Narrows - north and east of a line beginning on the west shore at a point 35° 20.9790' N – 76° 23.8577' W; running southeasterly to Swanquarter Island to a point 35° 20.5321' N – 76° 22.7869' W; and west of a line at The Narrows beginning on the north shore to a point 35° 20.9500' N – 76° 20.6409' W; running southerly to Swanquarter Island to a point 35° 20.7025' N – 76° 20.5620' W;
 - (g) Rose Bay - north of a line beginning on Long Point at a point 35° 23.3404' N – 76° 26.2491' W; running southeasterly to Drum Point to a point 35° 22.4891' N – 76° 25.2012' W;
 - (h) Spencer Bay - northwest of a line beginning on Roos Point at a point 35° 22.3866' N – 76° 27.9225' W; running northeasterly to Long Point to a point 35° 23.3404' N – 76° 26.2491' W;
 - (i) Abel Bay - northeast of a line beginning on the west shore at a point 35° 23.6463' N – 76° 31.0003' W; running southeasterly to the east shore to a point 35° 22.9353' N – 76° 29.7215' W;
 - (j) Mouse Harbor - west of a line beginning on Persimmon Tree Point at a point 35° 18.3915' N – 76° 29.0454' W; running southerly to Yaupon Hammock Point to a point 35° 17.1825' N – 76° 28.8713' W;
 - (k) Big Porpoise Bay - northwest of a line beginning on Big Porpoise Point at a point 35° 15.6993' N – 76° 28.2041' W; running southwesterly to Middle Bay Point to a point 35° 14.9276' N – 76° 28.8658' W;
 - (l) Middle Bay - west of a line beginning on Deep Point at a point 35° 14.8003' N – 76° 29.1923' W; running southerly to Little Fishing Point to a point 35° 13.5419' N – 76° 29.6123' W;
 - (m) Jones Bay - west of a line beginning on Mink Trap Point at a point 35° 13.4968' N – 76° 31.1040' W; running southerly to Boar Point to a point 35° 12.3253' N – 76° 31.2767' W; and
 - (n) ~~In~~ in the Bay River Area:
 - (i) Bonner Bay - southeast of a line beginning on the west shore at a point 35° 09.6281' N – 76° 36.2185' W; running northeasterly to Davis Island Point to a point 35° 10.0888' N – 76° 35.2587' W; and
 - (ii) Gales Creek-Bear Creek - north and west of a line beginning on Sanders Point at a point 35° 11.2833' N – 76° 35.9000' W; running northeasterly to the east shore to a point 35° 11.9000' N – 76° 34.2833' W;
- (3) ~~In~~ in the Pamlico and Pungo Rivers Area:

- (a) Pungo River - north of a line beginning on the west shore at a point 35° 32.2000' N – 76° 29.2500' W; running east near Beacon "21" to the east shore to a point 35° 32.0833' N – 76° 28.1500' W;
 - ~~(b)~~ Pungo Creek - west of a line beginning on Persimmon Tree Point at a point 35° 30.7633' N – 76° 38.2831' W; running southwesterly to Windmill Point to a point 35° 31.1546' N – 76° 37.7590' W;
 - ~~(c)~~ Scranton Creek - south and east of a line beginning on the west shore at a point 35° 30.6810' N – 76° 28.3435' W; running easterly to the east shore to a point 35° 30.7075' N – 76° 28.6766' W;
 - ~~(d)~~ Slade Creek - east of a line beginning on the west shore at a point 35° 27.8879' N – 76° 32.9906' W; running southeasterly to the east shore to a point 35° 27.6510' N – 76° 32.7361' W;
 - ~~(b)(e)~~ Fortescue Creek - east of a line beginning on Pasture Point at a point 35° 25.9213' N – 76° 31.9135' W; running southerly to the Lupton Point shore to a point 35° 25.6012' N – 76° 31.9641' W;
 - ~~(e)(f)~~ Pamlico River - west of a line beginning on Ragged Point at a point 35° 27.5768' N – 76° 54.3612' W; running southwesterly to Mauls Point to a point 35° 26.9176' N – 76° 55.5253' W;
 - ~~(d)(g)~~ North Creek - north of a line beginning on the west shore at a point 35° 25.3988' N – 76° 40.0455' W; running southeasterly to the east shore to a point 35° 25.1384' N – 76° 39.6712' W;
 - ~~(h)~~ South Creek - west of a line beginning on Hickory Point at a point 35° 21.7385' N – 76° 41.5907' W; running southerly to Fork Point to a point 35° 20.7534' N – 76° 41.7870' W;
 - ~~(i)~~ Bond Creek/Muddy Creek - south of a line beginning on Fork Point at a point 35° 20.7534' N – 76° 41.7870' W; running southeasterly to Gum Point to a point 35° 20.5632' N – 76° 41.4645' W;
 - ~~(e)(j)~~ ~~In~~ in the Goose Creek Area, Campbell Creek - west of a line beginning on the north shore at a point 35° 17.3600' N – 76° 37.1096' W; running southerly to the south shore to a point 35° 16.9876' N – 76° 37.0965' W; and
 - ~~(f)(k)~~ Oyster Creek-Middle Prong - southwest of a line beginning on Pine Hammock at a point 35° 19.5586' N – 76° 32.8830' W; running easterly to Cedar Island to a point 35° 19.5490' N – 76° 32.7365' W; and southwest of a line beginning on Cedar Island at a point 35° 19.4921' N – 76° 32.2590' W; running southeasterly to Beard Island Point to a point 35° 19.1265' N – 76° 31.7226' W;
- (4) ~~In~~ in the Neuse River Area:
- (a) Lower Broad Creek - west of a line beginning on the north shore at a point 35° 05.8314' N – 76° 35.3845' W; running southwesterly to the south shore to a point 35° 05.5505' N – 76° 35.7249' W;
 - (b) Greens Creek - north of a line beginning on the west shore of Greens Creek at a point 35° 01.3476' N – 76° 42.1740' W; running northeasterly to the east shore to a point 35° 01.4899' N – 76° 41.9961' W;
 - (c) Dawson Creek - north of a line beginning on the west shore at a point 34° 59.5920' N – 76° 45.4620' W; running southeasterly to the east shore to a point 34° 59.5800' N – 76° 45.4140' W;
 - (d) Goose Creek - north and east of a line beginning at a point on the west shore at a point 35° 02.6642' N – 76° 56.4710' W; running southeasterly to a point on Cooper Point 35° 02.0908' N – 76° 56.0092' W;
 - (e) Upper Broad Creek - northeast of a line beginning at a point on Rowland Point on the north shore at a point 35° 02.6166' N – 76° 56.4500' W; running southeasterly to the south shore to a point 35° 02.8960' N – 76° 56.7865' W;
 - (f) Clubfoot Creek - south of a line beginning on the west shore at a point 34° 54.5424' N – 76° 45.7252' W; running easterly to the east shore to a point 34° 54.4853' N – 76° 45.4022' W; and
 - (g) ~~In~~ in the Adams Creek Area, Cedar Creek - east of a line beginning on the north shore at a point 34° 56.1203' N – 76° 38.7988' W; running southerly to the south shore to a point 34° 55.8745' N – 76° 38.8153' W;
- ~~(5)~~ Newport River - west of a line beginning near Penn Point on the south shore at a point 34° 45.6960' N – 76° 43.5180' W; running northeasterly to the north shore to a point 34° 46.8490' N – 76° 43.3296' W;
- ~~(5)(6)~~ Virginia Creek - all waters of the natural channel northwest of the primary nursery area line;
 - ~~(6)(7)~~ Old Topsail Creek - all waters of the dredged channel northwest of the primary nursery area line;
 - ~~(7)(8)~~ Mill Creek - all waters west of a line beginning on the north shore at a point 34° 20.6420' N – 77° 42.1220' W; running southwesterly to the south shore to a point 34° 20.3360' N – 77° 42.2400' W;
 - ~~(8)(9)~~ Pages Creek - all waters west of a line beginning on the north shore at a point 34° 16.1610' N – 77° 45.9930' W; running southwesterly to the south shore to a point 34° 15.9430' N – 77° 46.1670' W;

- ~~(9)~~(10) Bradley Creek - all waters west of a line beginning on the north shore at a point 34° 12.7030' N – 77° 49.1230' W; running southerly near the dredged channel to a point 34° 12.4130' N – 77° 49.2110' W; ~~and~~
- (11) Cape Fear River - all waters bounded by a line beginning on the south side of the Spoil Island at the intersection of the Intracoastal Waterway and the Cape Fear River ship channel at a point 34° 01.5780' N – 77° 56.0010' W; running easterly to the east shore of the Cape Fear River to a point 34° 01.7230' N – 77° 55.1010' W; running southerly and bounded by the shoreline to the Ferry Slip at Federal Point at a point 33° 57.8080' N – 77° 56.4120' W; running northerly to Bird Island to a point 33° 58.3870' N – 77° 56.5780' W; running northerly along the west shoreline of Bird Island and the Cape Fear River spoil islands back to point of origin;
- (12) Lockwood Folly River - all waters north of a line beginning on Howells Point at a point 33° 55.3680' N – 78° 12.7930' W and running in a westerly direction along the Intracoastal Waterway near Intracoastal Waterway Marker "46" to a point 33° 55.3650' N – 78° 13.8500' W;
- (13) Saucepan Creek - all waters north of a line beginning on the west shore at a point 33° 54.6290' N – 78° 22.9170' W; running northeasterly to the east shore to a point 33° 54.6550' N – 78° 22.8670' W; and
- ~~(10)~~(14) Davis Creek - all waters east of a line beginning on Horse Island at a point 33° 55.0160' N – 78° 12.7380' W; running southerly to Oak Island to a point 33° 54.9190' N – 78° 12.7170' W; continuing upstream to the primary nursery line and Davis Canal, all waters southeast of a line beginning on Pinner Point at a point 33° 55.2930' N – 78° 11.6390' W; running southwesterly across the mouth of Davis Canal to the spoil island at the southwest intersection of the ~~IWW~~-Intracoastal Waterway and Davis Canal to a point 33° 55.2690' N – 78° 11.6550' W.

*History Note: Authority G.S. 113-134; 113-182; 143B-289.52;
 Eff. January 1, 1991;
 Amended Eff. March 1, 1996; March 1, 1994;
 Recodified from 15A NCAC 3R .0004 Eff. December 17, 1996;
 Amended Eff. April 1, 2021; April 1, 2011; August 1, 2004; May 1, 1997.*

Options 2-4:

15A NCAC 03R .0105 SPECIAL SECONDARY NURSERY AREAS

The special secondary nursery areas referenced in 15A NCAC 03N .0105(b) are designated in the following coastal water areas:

- (1) Roanoke Sound:
- (a) Outer Shallowbag Bay - west of a line beginning on Baum Point at a point 35° 55.1461' N – 75° 39.5618' W; running southeasterly to Ballast Point to a point 35° 54.6250' N – 75° 38.8656' W; including the canal on the southeast shore of Shallowbag Bay; and
- (b) Kitty Hawk Bay/Buzzard Bay - within the area designated by a line beginning at a point on the east shore of ~~Collington~~-Collington Creek at a point 36° 02.4360' N – 75° 42.3189' W; running westerly to a point 36° 02.6630' N – 75° 41.4102' W; running along the shoreline to a point 36° 02.3264' N – 75° 42.3889' W; running southwesterly to a point 36° 02.1483' N – 75° 42.4329' W; running along the shoreline to a point 36° 01.6736' N – 75° 42.5313' W; running southwesterly to a point 36° 01.5704' N – 75° 42.5899' W; running along the shoreline to a point 36° 00.9162' N – 75° 42.2035' W; running southeasterly to a point 36° 00.8253' N – 75° 42.0886' W; running along the shoreline to a point 35° 59.9886' N – 75° 41.7284' W; running southwesterly to a point 35° 59.9597' N – 75° 41.7682' W; running along the shoreline to the mouth of Buzzard Bay to a point 35° 59.6480' N – 75° 32.9906' W; running easterly to Mann Point to a point 35° 59.4171' N – 75° 32.7361' W; running northerly along the shoreline to the point of beginning;
- ~~(2) In the Pamlico and Pungo rivers Area:~~
- ~~(a) Pungo Creek west of a line beginning on Persimmon Tree Point at a point 35° 30.7633' N – 76° 38.2831' W; running southwesterly to Windmill Point to a point 35° 31.1546' N – 76° 37.7590' W;~~
- ~~(b) Seranton Creek south and east of a line beginning on the west shore at a point 35° 30.6810' N – 76° 28.3435' W; running easterly to the east shore to a point 35° 30.7075' N – 76° 28.6766' W;~~
- ~~(c) Slade Creek east of a line beginning on the west shore at a point 35° 27.8879' N – 76° 32.9906' W; running southeasterly to the east shore to a point 35° 27.6510' N – 76° 32.7361' W;~~

- (d) ~~South Creek west of a line beginning on Hickory Point at a point 35° 21.7385' N 76° 41.5907' W; running southerly to Fork Point to a point 35° 20.7534' N 76° 41.7870' W; and~~
- (e) ~~Bond Creek/Muddy Creek south of a line beginning on Fork Point 35° 20.7534' N 76° 41.7870' W; running southeasterly to Gum Point to a point 35° 20.5632' N 76° 41.4645' W;~~
- (3)(2) ~~In~~ in the West Bay Area:
- (a) West Thorofare Bay - south of a line beginning on the west shore at a point 34° 57.2199' N – 76° 24.0947' W; running easterly to the east shore to a point 34° 57.4871' N – 76° 23.0737' W;
- (b) Long Bay-Ditch Bay - west of a line beginning on the north shore of Ditch Bay at a point 34° 57.9388' N – 76° 27.0781' W; running southwesterly to the south shore of Ditch Bay to a point 34° 57.2120' N – 76° 27.2185' W; then south of a line running southeasterly to the east shore of Long Bay to a point 34° 56.7633' N – 76° 26.3927' W; and
- (c) Turnagain Bay - south of a line beginning on the west shore at a point 34° 59.4065' N – 76° 30.1906' W; running easterly to the east shore to a point 34° 59.5668' N – 76° 29.3557' W;
- (4)(3) ~~In~~ in the Core Sound Area:
- (a) Cedar Island Bay - northwest of a line beginning near the gun club dock at a point 34° 58.7203' N – 76° 15.9645' W; running northeasterly to the south shore to a point 34° 57.7690' N – 76° 16.8781' W;
- (b) Thorofare Bay-Barry Bay - northwest of a line beginning on Rumley Hammock at a point 34° 55.4853' N – 76° 18.2487' W; running northeasterly to Hall Point to a point 34° 54.4227' N – 76° 19.1908' W;
- (c) Nelson Bay - northwest of a line beginning on the west shore of Nelson Bay at a point 34° 51.1353' N – 76° 24.5866' W; running northeasterly to Drum Point to a point 34° 51.6417' N – 76° 23.7620' W;
- (d) Brett Bay - north of a line beginning on the west shore at a point 34° 49.4019' N – 76° 26.0227' W; running easterly to Piney Point to a point 34° 49.5799' N – 76° 25.0534' W; and
- (e) Jarrett Bay - north of a line beginning on the west shore near Old Chimney at a point 34° 45.5743' N – 76° 30.0076' W; running easterly to a point east of Davis Island 34° 45.8325' N – 76° 28.7955' W;
- (5)(4) ~~In~~ in the North River Area:
- (a) North River - north of a line beginning on the west shore at a point 34° 46.0383' N – 76° 37.0633' W; running easterly to a point on the east shore 34° 46.2667' N – 76° 35.4933' W; and
- (b) Ward Creek - east of a line beginning on the north shore at a point 34° 46.2667' N – 76° 35.4933' W; running southerly to the south shore to a point 34° 45.4517' N – 76° 35.1767' W;
- (6) ~~Newport River west of a line beginning near Penn Point on the south shore at a point 34° 45.6960' N 76° 43.5180' W; running northeasterly to the north shore to a point 34° 46.8490' N 76° 43.3296' W;~~
- (7)(5) New River - all waters upstream of a line beginning on the north side of the N.C. Highway 172 Bridge at a point 34° 34.7680' N – 77° 23.9940' W; running southerly to the south side of the bridge at a point 34° 34.6000' N – 77° 23.9710' W;
- (8)(6) Chadwick Bay - all waters west of a line beginning on the northeast side of Chadwick Bay at a point 34° 32.5630' N – 77° 21.6280' W; running southeasterly to a point near Marker "6" at 34° 32.4180' N – 77° 21.6080' W; running westerly to Roses Point at a point 34° 32.2240' N – 77° 22.2880' W; following the shoreline in Fullard Creek to a point 34° 32.0340' N – 77° 22.7160' W; running northwesterly to a point 34° 32.2210' N – 77° 22.8080' W; following the shoreline to the west point of Bump's Creek at a point 34° 32.3430' N – 77° 22.4570' W; running northeasterly to the east shore to a point 34° 32.4400' N – 77° 22.3830' W; following the shoreline of Chadwick Bay back to the point of origin; and
- (9)(7) Intracoastal Waterway - all waters in the ~~IWW~~ Intracoastal Waterway maintained channel from a point near Marker "17" north of Alligator Bay 34° 30.7930' N – 77° 23.1290' W; to a point near Marker "49" at Morris Landing at a point 34° 28.0820' N – 77° 30.4710' W; and all waters in the ~~IWW~~ Intracoastal Waterway maintained channel and 100 feet on either side from Marker "49" to the N.C. Highway 50-210 Bridge at Surf City; City.
- (10) ~~Cape Fear River all waters bounded by a line beginning on the south side of the Spoil Island at the intersection of the IWW and the Cape Fear River ship channel at a point 34° 01.5780' N 77° 56.0010' W; running easterly to the east shore of the Cape Fear River to a point 34° 01.7230' N 77° 55.1010' W; running southerly and bounded by the shoreline to the Ferry Slip at Federal Point at a point 33° 57.8080' N 77°~~

- ~~56.4120' W; running northerly to Bird Island to a point 33° 58.3870' N 77° 56.5780' W; running northerly along the west shoreline of Bird Island and the Cape Fear River spoil islands back to point of origin;~~
- (11) ~~Lockwood Folly River all waters north of a line beginning on Howells Point at a point 33° 55.3680' N 78° 12.7930' W and running in a westerly direction along the IWW near IWW Marker "46" to a point 33° 55.3650' N 78° 13.8500' W; and~~
- (12) ~~Saucepan Creek all waters north of a line beginning on the west shore at a point 33° 54.6290' N 78° 22.9170' W; running northeasterly to the east shore to a point 33° 54.6550' N 78° 22.8670' W.~~

*History Note: Authority G.S. 113-134; 113-182; 143B-289.52;
Eff. January 1, 1991;
Amended Eff. March 1, 1996; March 1, 1994;
Recodified from 15A NCAC 3R .0005 Eff. December 17, 1996;
Amended Eff. April 1, 2011; August 1, 2004; May 1, 1997;
Readopted Eff. April 1, 2021.*

Option 4:

15A NCAC 03R .0106 TRAWL NETS PROHIBITED

The trawl net prohibited areas referenced in 15A NCAC 03J .0104 (b)(4) are delineated in the following coastal water areas:

- (1) In Pamlico, Core and Back sounds - within the area described by a line beginning at a point 35° 43.7457' N – 75° 30.7014' W on the south shore of Eagles Nest Bay on Pea Island; running westerly to a point 35° 42.9500' N – 75° 34.1500' W; running southerly to a point 35° 39.3500' N – 75° 34.4000' W; running southeasterly to a point 35° 35.8931' N – 75° 31.1514' W in Chicamacomico Channel near Beacon "ICC"; running southerly to a point 35° 28.5610' N – 75° 31.5825' W on Gull Island; running southwesterly to a point 35° 22.8671' N – 75° 33.5851' W in Avon Channel near Beacon "1"; running southwesterly to a point 35° 18.9603' N – 75° 36.0817' W in Cape Channel near Beacon "2"; running westerly to a point 35° 16.7588' N – 75° 44.2554' W in Rollinson Channel near Beacon "42RC"; running southwesterly to a point 35° 14.0337' N – 75° 45.9643' W southwest of Oliver Reef near the quick-flashing beacon; running westerly to a point 35° 09.3650' N – 76° 00.6377' W in Big Foot Slough Channel near Beacon "14BF"; running southwesterly to a point 35° 08.4523' N – 76° 02.6651' W in Nine Foot Shoal Channel near Beacon "9"; running westerly to a point 35° 07.1000' N – 76° 06.9000' W; running southwesterly to a point 35° 01.4985' N – 76° 11.4353' W near Beacon "HL"; running southwesterly to a point 35° 00.2728' N – 76° 12.1903' W near Beacon "2CS"; "1CS"; running southerly to a point 34° 59.5027' N – 76° 12.3204' W in Wainwright Channel immediately east of the northern tip of Wainwright Island; running easterly to a point 34° 58.6760' N – 76° 12.4164' W; running southerly to a point 34° 56.6697' N – 76° 13.6052' W near Marker "15"; running southwesterly to a point 34° 54.1584' N – 76° 16.9016' W; running southwesterly to a point 34° 52.1484' N – 76° 19.2607' W; running southwesterly to a point 34° 51.0617' N – 76° 21.0449' W; running southwesterly to a point 34° 48.3137' N – 76° 24.3717' W; running southwesterly to a point 34° 46.3739' N – 76° 26.1526' W; running southwesterly to a point 34° 44.5795' N – 76° 27.5136' W; running southwesterly to a point 34° 43.4895' N – 76° 28.9411' W near Beacon "37A"; running southwesterly to a point 34° 40.4500' N – 76° 30.6833' W; running westerly to a point 34° 40.7061' N – 76° 31.5893' W near Beacon "35" in Back Sound; running westerly to a point 34° 41.3178' N – 76° 33.8092' W near Buoy "3"; running southwesterly to a point 34° 39.6601' N – 76° 34.4078' W on Shackleford Banks; running easterly and northeasterly along the shoreline and across Barden Inlet following the COLREGS Demarcation line; then running northerly along the shoreline across the inlets following the COLREGS Demarcation line up the Outer Banks to Eagles Nest Bay at the point of beginning.
- (2) In Northern Pamlico Sound, Stumpy Point Bay - north of a line beginning at a point 35° 40.9719' N – 75° 44.4213' W on Drain Point; running westerly to a point 35° 40.6550' N – 75° 45.6869' W on Kazer Point;
- (3) In the Pamlico River area, lower Goose Creek - south of a line beginning at a point 35° 18.2676' N – 76° 37.4706' W on the north shore of Snode Creek; running easterly to a point 35° 18.1660' N – 76° 36.9095' W on Store Point;
- (4) Pungo Creek - west of a line beginning on Persimmon Tree Point at a point 35° 30.7633' N – 76° 38.2831' W; running southwesterly to Windmill Point to a point 35° 31.1546' N – 76° 37.7590' W;
- (5) Scranton Creek - south and east of a line beginning on the west shore at a point 35° 30.6810' N – 76° 28.3435' W; running easterly to the east shore to a point 35° 30.7075' N – 76° 28.6766' W;

- (6) Slade Creek - east of a line beginning on the west shore at a point 35° 27.8879' N – 76° 32.9906' W; running southeasterly to the east shore to a point 35° 27.6510' N – 76° 32.7361' W;
- (7) South Creek - west of a line beginning on Hickory Point at a point 35° 21.7385' N – 76° 41.5907' W; running southerly to Fork Point to a point 35° 20.7534' N – 76° 41.7870' W;
- (8) Bond Creek/Muddy Creek - south of a line beginning on Fork Point at a point 35° 20.7534' N – 76° 41.7870' W; running southeasterly to Gum Point to a point 35° 20.5632' N – 76° 41.4645' W;
- (4)(9) In the Bay River Area:
- (a) In Dump Creek - north of a line beginning at a point 35° 11.6666' N – 76° 33.4207' W on the west shore; running southeasterly to a point 35° 11.3926' N – 76° 32.8993' W on the east shore;
- (b) In Rockhole Bay - north of a line beginning at a point 35° 11.3926' N – 76° 32.8993' W on the west shore; running southeasterly to a point 35° 11.1321' N – 76° 32.1360' W on the east shore;
- (c) In Vandemere Creek - north of a line beginning at a point 35° 11.2681' N – 76° 39.5220' W on the west shore; running southerly to a point 35° 11.0879' N – 76° 39.3200' W on the east shore;
- (d) In Cedar Creek - west of a line beginning at a point 35° 11.2681' N – 76° 39.5220' W on the north shore; running southwestly to a point 35° 11.1033' N – 76° 39.7321' W on the south shore of an unnamed tributary;
- (e) In Chapel Creek - north of a line beginning at a point 35° 08.6768' N – 76° 42.7985' W on the west shore; running easterly to a point 35° 08.7677' N – 76° 42.3604' W on the east shore;
- (f) In Upper Bay River - west of a line beginning at a point 35° 08.6704' N – 76° 43.0836' W on the north shore; running southwestly to a point 35° 08.4590' N – 76° 43.1930' W on the south shore;
- (5)(10) In the Neuse River Area, Pierce Creek - west of a line beginning at a point 35° 02.4336' N – 76° 39.7653' W on the north shore; running southerly to a point 35° 02.3767' N – 76° 39.7876' W on the south shore;
- (6)(11) In Cape Lookout Bight, all of Cape Lookout Bight - southwest of the COLREGS Demarcation line at Barden Inlet to the northeastern most point of Power Squadron Spit; running northeasterly to a point 34° 38.6150' N – 76° 32.7434' W on Shackleford Banks;
- (7)(12) Newport River - all waters upstream of a line beginning at a point 34° 45.6960' N – 76° 43.5180' W near Penn Point; running northeasterly to a point 34° 46.5733' N – 76° 42.6350' W at Hardesty Farms subdivision;
- (8)(13) White Oak River - all waters upstream of a line beginning at a point on the west side of the river 34° 43.3425' N – 77° 07.2209' W; running northerly to a point 34° 43.6445' N – 77° 07.3177' W in the river above Cahoon's Slough; running easterly to a point 34° 43.5588' N – 77° 06.6206' W at Hancock Point;
- (9)(14) Intracoastal Waterway - all waters in the maintained channel from a point near Marker #105 34° 18.8167' N – 77° 42.8833' W running southerly to a point at the Wrightsville Beach Drawbridge 34° 12.9500' N – 77° 47.9833' W;
- (10)(15) Cape Fear River - all waters bounded by a line beginning on the south side of the Spoil Island at the intersection of the Intracoastal Waterway and the Cape Fear River ship channel at a point 34° 01.5780' N – 77° 56.0010' W; running easterly to the east shore of the Cape Fear River to a point 34° 01.7230' N – 77° 55.1010' W; running southerly and bounded by the shoreline to the Ferry Slip at Federal Point at a point 33° 57.8080' N – 77° 56.4120' W; running northerly to Bird Island to a point 33° 58.3870' N – 77° 56.5780' W; running northerly along the west shoreline of Bird Island and the Cape Fear River spoil islands back to point of origin; and all waters bounded by a line beginning at a point near Fort Fisher 33° 57.5333' N – 77° 56.9333' W running southwestly along The Rocks to a point 33° 55.1833' N – 77° 58.0833' W running southeasterly and southerly along the shorelines of Second and Buzzard's Bays to a point 33° 53.0333' N – 57.9333' W running ~~northeasterly and northwesterly~~ northeasterly and northwesterly along the barrier island shorelines of Buzzard's Bay, Second Bay and The Basin back to the point of ~~origin;~~ origin;
- (11)(16) Cape Creek - all waters upstream of a line beginning at a point on the north shore 33° 53.6167' N – 77° 59.3333' W running southwestly to a point on the south shore 33° 53.3667' N – 77° 59.4667' W; ~~and~~
- (12)(17) Bald Head Creek - all waters upstream of a line beginning at a point on the west shore 33° 52.8667' N – 77° 59.8000' W running easterly to a point on the east shore 33° 52.8667' N – 77° 59.7167' W; ~~W; W;~~
- (18) Lockwood Folly River - all waters north of a line beginning on Howells Point at a point 33° 55.3680' N – 78° 12.7930' W and running in a westerly direction along the Intracoastal Waterway near Intracoastal Waterway Marker "46" to a point 33° 55.3650' N – 78° 13.8500' W; and
- (19) Saucepan Creek - all waters north of a line beginning on the west shore at a point 33° 54.6290' N – 78° 22.9170' W; running northeasterly to the east shore to a point 33° 54.6550' N – 78° 22.8670' W.

History Note: Authority G.S. 113-134; 113-182; 143B-289.52;
Eff. January 1, 1991;
Amended Eff. March 1, 1994;
Recodified from 15A NCAC 3R .0006 Eff. December 17, 1996;
Amended Eff. April 1, 2021; July 1, 2006; August 1, 2004; April 1, 1997.

Option 3:

15A NCAC 03R .0112 ATTENDED GILL NET AREAS

- (a) The attended gill net areas referenced in 15A NCAC 03J .0103(g) are delineated in the following areas:
- (1) Pamlico River, west of a line beginning at a point 35° 27.5768' N – 76° 54.3612' W on Ragged Point; running southwesterly to a point 35° 26.9176' N – 76° 55.5253' W on Mauls Point;
 - (2) within 200 yards of the shoreline in Pamlico River and its tributaries east of a line beginning at a point 35° 27.5768' N – 76° 54.3612' W on Ragged Point; running southwesterly to a point 35° 26.9176' N – 76° 55.5253' W on Mauls Point; and west of a line beginning at a point 35° 22.3622' N – 76° 28.2032' W on Roos Point; running southerly to a point at 35° 18.5906' N – 76° 28.9530' W on Pamlico Point;
 - (3) Pungo River, east of the northern portion of the Pantego Creek breakwater and a line beginning at a point 35° 31.7198' N – 76° 36.9195' W on the northern side of the breakwater near Tooleys Point; running southeasterly to a point 35° 30.5312' N – 76° 35.1594' W on Durants Point;
 - (4) within 200 yards of the shoreline in Pungo River and its tributaries west of the northern portion of the Pantego Creek breakwater and a line beginning at a point 35° 31.7198' N – 76° 36.9195' W on the northern side of the breakwater near Tooleys Point; running southeasterly to a point 35° 30.5312' N – 76° 35.1594' W on Durants Point; and west of a line beginning at a point 35° 22.3622' N – 76° 28.2032' W on Roos Point; running southerly to a point at 35° 18.5906' N – 76° 28.9530' W on Pamlico Point;
 - (5) Neuse River and its tributaries northwest of the Highway 17 highrise bridge;
 - (6) Trent River and its tributaries; and
 - (7) within 200 yards of the shoreline in Neuse River and its tributaries east of the Highway 17 highrise bridge and south and west of a line beginning on Maw Point at a point 35° 09.0407' N – 76° 32.2348' W; running southeasterly near the Maw Point Shoal Marker "2" to a point 35° 08.1250' N – 76° 30.8532' W; running southeasterly near the Neuse River Entrance Marker "NR" to a point 35° 06.6212' N – 76° 28.5383' W; running southerly to a point 35° 04.4833' N – 76° 28.0000' W near Point of Marsh in Neuse River. In Core and Clubfoot creeks, the Highway 101 Bridge shall constitute the attendance boundary.
- (b) The attended gill net areas referenced in 15A NCAC 03J .0103(h) are delineated in the following Internal Coastal Waters and Joint Fishing Waters of the State south of a line beginning on Roanoke Marshes Point at a point 35° 48.3693' N – 75° 43.7232' W; running southeasterly to a point 35° 44.1710' N – 75° 31.0520' W on Eagles Nest Bay to the South Carolina state line:
- (1) all primary nursery areas described in 15A NCAC 03R .0103, all permanent secondary nursery areas described in ~~15A NCAC 03R .0104, 15A NCAC 03R .0104~~ except (3)(b), (3)(c), (3)(d), (3)(h), (3)(i), (5), (11), (12), and (13), and no-trawl areas described in 15A NCAC 03R .0106(2), (4), (5), (8), (10), (11), and (12);
 - (2) in the area along the Outer Banks, beginning at a point 35° 44.1710' N – 75° 31.0520' W on Eagles Nest Bay; running northwesterly to a point 35° 45.1833' N – 75° 34.1000' W west of Pea Island; running southerly to a point 35° 40.0000' N – 75° 32.8666' W west of Beach Slough; running southeasterly and passing near Beacon "2" in ~~Chicamacomico~~-Chicamacomico Channel to a point 35° 35.0000' N – 75° 29.8833' W west of the Rodanthe Pier; running southwesterly to a point 35° 28.4500' N – 75° 31.3500' W on Gull Island; running southerly to a point 35° 22.3000' N – 75° 33.2000' W near Beacon "2" in Avon Channel ; running southwesterly to a point 35° 19.0333' N – 75° 36.3166' W near Beacon "2" in Cape Channel; running southwesterly to a point 35° 15.5000' N – 75° 43.4000' W near Beacon "36" in Rollinson Channel; running southeasterly to a point 35° 14.9386' N – 75° 42.9968' W near Beacon "35" in Rollinson Channel; running southwesterly to a point 35° 14.0377' N – 75° 45.9644' W near a "Danger" Beacon northwest of Austin Reef; running southwesterly to a point 35° 11.4833' N – 75° 51.0833' W on Legged Lump; running southeasterly to a point 35° 10.9666' N – 75° 49.7166' W south of Legged Lump; running southwesterly to a point 35° 09.3000' N – 75° 54.8166' W near the west end of Clarks Reef; running westerly to a point 35° 08.4333' N – 76° 02.5000' W near Nine Foot Shoal Channel; running southerly to a point 35° 06.4000' N – 76° 04.3333'

- W near North Rock; running southwesterly to a point 35° 01.5833' N – 76° 11.4500' W near Beacon "HL"; running southerly to a point 35° 00.2666' N – 76° 12.2000' W; running southerly to a point 34° 59.4664' N – 76° 12.4859' W on Wainwright Island; running easterly to a point 34° 58.7853' N – 76° 09.8922' W on Core Banks; running northerly along the shoreline and across the inlets following the COLREGS Demarcation Line to the point of beginning;
- (3) in Core and Back sounds, beginning at a point 34° 58.7853' N – 76° 09.8922' W on Core Banks; running northwesterly to a point 34° 59.4664' N – 76° 12.4859' W on Wainwright Island; running southerly to a point 34° 58.8000' N – 76° 12.5166' W; running southeasterly to a point 34° 58.1833' N – 76° 12.3000' W; running southwesterly to a point 34° 56.4833' N – 76° 13.2833' W; running westerly to a point 34° 56.5500' N – 76° 13.6166' W; running southwesterly to a point 34° 53.5500' N – 76° 16.4166' W; running northwesterly to a point 34° 53.9166' N – 76° 17.1166' W; running southerly to a point 34° 53.4166' N – 76° 17.3500' W; running southwesterly to a point 34° 51.0617' N – 76° 21.0449' W; running southwesterly to a point 34° 48.3137' N – 76° 24.3717' W; running southwesterly to a point 34° 46.3739' N – 76° 26.1526' W; running southwesterly to a point 34° 44.5795' N – 76° 27.5136' W; running southwesterly to a point 34° 43.4895' N – 76° 28.9411' W near Beacon "37A"; running southwesterly to a point 34° 40.4500' N – 76° 30.6833' W; running westerly to a point 34° 40.7061' N – 76° 31.5893' W near Beacon "35" in Back Sound; running westerly to a point 34° 41.3178' N – 76° 33.8092' W near Buoy "3"; running southwesterly to a point 34° 39.6601' N – 76° 34.4078' W on Shackleford Banks; running easterly and northeasterly along the shoreline and across the inlets following the COLREGS Demarcation lines to the point of beginning;
- (4) within 200 yards of the shoreline in the area upstream of the 76° 28.0000' W longitude line beginning at a point 35° 22.3752' N – 76° 28.0000' W near Roos Point in Pamlico River; running southeasterly to a point 35° 04.4833' N – 76° 28.0000' W near Point of Marsh in Neuse River; and
- (5) within 50 yards of the shoreline east of the 76° 28.0000' W longitude line beginning at a point 35° 22.3752' N – 76° 28.0000' W near Roos Point in Pamlico River; running southeasterly to a point 35° 04.4833' N – 76° 28.0000' W near Point of Marsh in Neuse River, except from October 1 through November 30, south and east of Highway 12 in Carteret County and south of a line from a point 34° 59.7942' N – 76° 14.6514' W on Camp Point; running easterly to a point at 34° 58.7853' N – 76° 09.8922' W on Core Banks; to the South Carolina state Line.

History Note: Authority G.S. 113-134; 113-173; 113-182; 143B-289.52; Eff. August 1, 2004; Amended Eff. April 1, 2016; June 1, 2013; April 1, 2011; April 1, 2009; Readopted Eff. April 1, 2019; Amended Eff. April 1, 2021.

VIII. PROPOSED MANAGEMENT OPTIONS

- 1) *Status quo* (keep all areas classified as special secondary nursery areas and continue to keep them closed to shrimp trawling)
 - + No rule changes are needed
 - + Implements actions of Amendment 1 to the Shrimp FMP
 - + Does not impact other FMPs
 - + Does not impact other fisheries
 - + No impacts to commercial shrimp fishermen since the areas have not been opened in recent years
 - Inconsistencies between current management practices and area designations for the Newport, Cape Fear, and Lockwood Folly rivers and Pungo, Scranton, Slade, South and Bond/Muddy creeks SSNAs remain
- 2) Change the designation of special secondary nursery areas that have not been opened to trawling in many years to permanent secondary nursery areas which would make them subject to gill net attendance under 03R .0112(b)(1).
 - + Eliminate bycatch from shrimp trawls in these SSNAs
 - + Protects habitat from bottom disturbing gear
 - + Implements actions of Amendment 1 to the Shrimp FMP

- + No impact to commercial shrimp fishermen since the areas have not been opened in recent years
 - +/- Gill net attendance required from May 1 through November 30
 - Nursery rule changes are needed
 - Eliminates crab trawling
- 3) Change the designation of special secondary nursery areas that have not been opened to trawling in many years to permanent secondary nursery areas and exempt them from 03R .0112(b)(1).
- + Eliminate bycatch from shrimp trawls in these SSNAs
 - + Protects habitat from bottom disturbing gear
 - + Implements actions of Amendment 1 to the Shrimp FMP
 - + No impact to commercial shrimp fishermen since the areas have not been opened in recent years
 - Both nursery and gill net attendance rule changes are needed
 - Eliminates crab trawling
- 4) Change the designation of special secondary nursery areas that have not been opened in many years to trawling to permanent trawl net prohibited area (15A NCAC 03R 0106).
- + Eliminate bycatch from shrimp trawls in SSNAs
 - + Protects habitat from bottom disturbing gear
 - + Eliminates the need for gill net attendance
 - + Implements actions of Amendment 1 to the Shrimp FMP
 - + No impact to commercial fishermen since the areas have not been opened in recent years
 - Nursery and TNPA rule changes are needed
 - Eliminates crab trawling
 - Areas would lose “nursery” designation

VIII. RECOMMENDATION

NCDMF:

Change the designation of special secondary nursery areas that have not been opened to trawling in many years to permanent secondary nursery areas which would make them subject to additional gill net attendance under 03R .0112(b)(1). [Option 2]

Habitat and Water Quality Advisory Committee:

Change the designation of special secondary nursery areas that have not been opened to trawling in many years to permanent secondary nursery areas which would make them subject to additional gill net attendance under 03R .0112(b)(1). [Option 2]

MFC Selected Management Strategy:

IV. REFERENCES CITED

NCDEQ (North Carolina Department of Environmental Quality). 2016. North Carolina Coastal Habitat Protection Plan Source Document. NC Division of Marine Fisheries, Morehead City, NC, 487 p.

NCDMF (North Carolina Division of Marine Fisheries). 2001. North Carolina Red Drum Fishery Management Plan. North Carolina Department of Environment and Natural Resources. North Carolina Division of Marine Fisheries. Morehead City, NC, 111 p.

NCDMF. 2006. North Carolina Fishery Management Plan for Shrimp. North Carolina Department of Environment and Natural Resources, Division of Marine Fisheries, Morehead City, NC, 390 p.

NCDMF. 2015a. North Carolina Shrimp Fishery Management Plan, Amendment 1. North Carolina Department of Environment and Natural Resources, Division of Marine Fisheries, Morehead City, NC. 514 p.

NCDMF. 2015b. North Carolina Striped Mullet Fishery Management Plan, Amendment 1. North Carolina Department of Environment and Natural Resources, Division of Marine Fisheries, Morehead City, NC. 388 p.

NCDMF. 2019. Draft North Carolina Blue Crab (*Callinectes sapidus*) Fishery Management Plan Amendment 3. North Carolina Department of Environment Quality. North Carolina Division of Marine Fisheries. Morehead City, NC, 239 p.

SAFMC (South Atlantic Fishery Management Council). 1998. Final habitat plan for the south Atlantic region: essential fish habitat requirements for fishery management plans of the South Atlantic Fishery Management Council. SAFMC, Charleston, SC, 457 p.

Prepared by: Chris Stewart
Chris.Stewart@ncdenr.gov
910-796-7370

Revised: April 18, 2017
May 11, 2017
July 5, 2017
July 7, 2017
Nov. 25, 2019
Dec. 12, 2019
Jan. 27, 2020

Notice of Text Attachment

Option 2

15A NCAC 03R .0104 PERMANENT SECONDARY NURSERY AREAS

15A NCAC 03R .0105 SPECIAL SECONDARY NURSERY AREAS

In accordance with the North Carolina Shrimp Fishery Management Plan Amendment 1, proposed amendments change the designation of special secondary nursery areas that have not recently been opened to trawling to permanent secondary nursery areas and subject these areas to gill net attendance under 15A NCAC 03R .0112(b)(1).

Option 3

15A NCAC 03R .0104 PERMANENT SECONDARY NURSERY AREAS

15A NCAC 03R .0105 SPECIAL SECONDARY NURSERY AREAS

15A NCAC 03R .0112 ATTENDED GILL NET AREAS

In accordance with the North Carolina Shrimp Fishery Management Plan Amendment 1, proposed amendments change the designation of special secondary nursery areas that have not recently been opened to trawling to permanent secondary nursery areas and exempt them from the attendance requirements of 15A NCAC 03R .0112(b)(1), but leave them subject to the attendance requirements in either 15A NCAC 03R .0112(a)(2), (a)(3), (a)(4), or (b)(5), depending on their location.

Option 4

15A NCAC 03R .0105 SPECIAL SECONDARY NURSERY AREAS

15A NCAC 03R .0106 TRAWL NETS PROHIBITED

In accordance with the North Carolina Shrimp Fishery Management Plan Amendment 1, proposed amendments change the designation of special secondary nursery areas that have not recently been opened to trawling to permanent trawl net prohibited areas.

MFC Rulebook Index Worksheet

Rule	Subject	Index Entry (Bold major headings)	Add/Delete/ No Change
TBD			

Ancillary Items: TBD

OYSTER SANCTUARY RULE CHANGES ISSUE PAPER

April 10, 2019

I. ISSUE

Rule amendments are proposed to add the boundaries of five Oyster Sanctuaries (Long Shoal, Little Creek, Pea Island, Raccoon Island, and Swan Island) and update boundaries for three existing sanctuaries (Neuse River, West Bluff, and Gibbs Shoal). Coordinates delineating boundaries for two sanctuaries (Ocracoke and Clam Shoal) are proposed to be removed from rule.

II. ORIGINATION

North Carolina Division of Marine Fisheries (DMF) Habitat and Enhancement Section

III. BACKGROUND

Marine protected areas (MPAs) are a powerful management approach for restoration and conservation of marine species and ecosystems. In general, the abundance and size of individuals within MPAs is often significantly greater and larger, respectively, than outside MPAs, which can also lead to a “spill-over effect” of larvae and individuals from inside to outside the MPA (Gell and Roberts 2002, Halpern 2003, Sobel and Dahlgren 2004). In other words, fish are generally larger and more abundant in MPAs. In pursuit of shellfish rehabilitation, the Division of Marine Fisheries has applied the MPA model through its Oyster Sanctuary Program. This program is responsible for creating artificial reef habitat, designed to support healthy and abundant oyster populations throughout Pamlico Sound and its tributaries. Once built, a reef site is protected from harvest to preserve broodstock and is called an “oyster sanctuary.” With healthy and abundant broodstock populations inside sanctuary boundaries, these sites continue to serve their intended function by supplying oyster larvae to other reefs nearby.

It is important to distinguish that while all artificial reef habitat is considered “reef,” not all reefs are considered “sanctuary.” The term sanctuary refers only to reefs protected from oyster harvest in Marine Fisheries Commission (MFC) rule or by proclamation. It is also important to consider that the created habitat within sanctuary or artificial reef boundaries always exists as a collection of separate reef habitat patches; see figures 2-6 in Section VI. for examples of this. Therefore, sanctuaries and artificial reefs are sometimes referred to as reef sites. In most cases concerning reef sites managed by the Oyster Sanctuary Program, the entire reef site authorized by state and federal permits is protected from oyster harvest. Therefore, reef, sanctuary, and reef site are often used interchangeably. When describing area as can be seen in Tables 1 and 2 (see section VI.), managers typically refer to boundary area as the total sanctuary area (acres) within the boundaries delineated in rule or by proclamation. Habitat footprint area refers to the cumulative total area of reef patches only, not to include unconsolidated soft bottom. For example, in Table 1, the Croatan Sound oyster sanctuary site has 3.10 acres of habitat within the overall boundary of 7.73 acres, meaning 4.63 acres of the site do not have habitat material deposited on them.

The Blue Ribbon Advisory Council on Oysters (BRACO) made the first recommendations concerning the establishment of oyster sanctuaries in North Carolina in 1995. The BRACO recommended the state provide selected areas where wild oyster stocks can adapt to present water quality and disease conditions without being subjected to the additional stress of habitat disturbance and oyster harvest. In addition to providing a sanctuary for oysters, these areas would also provide good nursery habitat for other species increasing their abundance for commercial and recreational fishing. The protected oysters would also provide for increased water filtration reducing turbidity and excess nutrients in the estuary. As part of the recommendation, oyster sanctuaries would be closed to taking of shellfish (oysters, clams, mussels, and scallops) and to bottom disturbing activities such as trawling, long hauling, and dredging for an indefinite period (Frankenberg 1995). DMF developed 10 oyster sanctuaries in Pamlico Sound and its tributaries. These sanctuaries were originally designated as shellfish management areas by proclamation, as authorized by Rule 15A NCAC 03K .0103. For these reef sites to serve their intended management function as oyster broodstock sanctuaries, harvest protections must be applied. As part of the 2008 Oyster Fishery Management Plan Amendment 2, the MFC moved the protection of sanctuaries from proclamation into rules 15A NCAC 03K .0209 and 03R .0117, Oyster Sanctuaries. The Nature Conservancy, National Oceanic and Atmospheric Administration National Estuarine Counsel, Coastal Recreational Fishing License, and other mitigation sources provided funding to expand the Oyster Sanctuary Program. DMF has since constructed five additional sanctuaries, which will increase the amount of broodstock and help answer research needs. These additional sanctuaries are

situated in the Neuse River (Little Creek) and Pamlico Sound (Long Shoal, Raccoon Island, Pea Island, and Swan Island). Under the authority of Rule 15A NCAC 03K .0103, Proclamation SF-6-2013 was issued July 8, 2013 to initially protect Long Shoal and Raccoon Island Oyster Sanctuaries by declaring them shellfish management areas and closing them to all fishing equipment. A proclamation covering these two oyster sanctuaries and the three subsequent sanctuaries that were constructed (Pea Island, Little Creek, and Swan Island) has since been issued (Proclamation SF-2-2019). All five of these sanctuaries would be protected under the proposed rule changes.

The North Carolina General Assembly recognized the continued importance of oyster sanctuaries in the 2014 and 2015 legislative sessions. Session Law 2014-120, Section 44 as amended by Session Law 2015-241, Section 14.9 established the Senator Jean Preston Oyster Sanctuary Network (Figure 1). This was done “to enhance shellfish habitats within the Albemarle and Pamlico Sounds and their tributaries to benefit fisheries, water quality, and the economy. This will be achieved through the establishment of a network of oyster sanctuaries, harvestable enhancement sites, and coordinated support for the development of shellfish aquaculture.” Today DMF maintains and manages 15 oyster sanctuaries in the network, but only 10 of them are currently in the oyster sanctuary rules. The sanctuaries are in Pamlico Sound and its tributaries encompassing 4.59 – 60.30 acres each, totaling 395.44 acres, with over 205,000 tons of material deployed for oyster habitat. (Table 1).

IV. AUTHORITY

Authority G.S. 113-134; 113-182; 113-201; 113-204; 143B-289.52
Session Law 2014-120, Section 44 as amended by Session Law 2015-241, Section 14.9

V. DISCUSSION

Rule amendments are proposed to add the boundaries of the five most recently developed Oyster Sanctuaries (Long Shoal, Little Creek, Pea Island, Raccoon Island, and Swan Island) and update boundaries for three existing sanctuaries (Neuse River, West Bluff, and Gibbs Shoal). Boundaries delineating sanctuary area for two reefs (Ocracoke and Clam Shoal) are proposed to be removed from rule.

Addition of Five Recently Developed Oyster Sanctuaries

There are presently 10 developed sanctuaries protected by MFC rule (15A NCAC 03K .0209 and 03R .0117), the last of which was added to rule effective April 1, 2011. Since that time, five additional sanctuaries have been developed. These sites are named Long Shoal, Raccoon Island, Pea Island, Little Creek, and Swan Island. For these reef sites to serve their intended management function as oyster broodstock sanctuaries, harvest protections need to be applied. While these sites are currently protected by proclamation, it is proposed to add these five new sites to the existing rule delineating the sanctuary boundaries in permanent rule.

Modification of Boundary Coordinates for Three Sites Already in Rule

Further, in an ongoing effort to review oyster sanctuary boundaries post-construction, DMF recently discovered through side-scan imagery that 3 of the 10 sanctuaries (Neuse River, Gibbs, Shoal, and West Bluff) had material slightly outside of their permitted boundaries. This is likely due to construction error or slight movement during material settlement. To prevent this error from occurring during future development, DMF intends to establish a 100-foot buffer of no development for reef construction. The no-development buffer is intended to protect against deployment error and possible material transport over time (Figures 2-4). The Oyster Sanctuary Program has updated the boundary coordinates for these sites to incorporate any material that was found outside of the original depicted sanctuary perimeters. Revisions have already been made to existing reef site permits (state and federal) and now need to be updated in rule for consistency. These changes will delineate all reef site area intended for oyster sanctuary purposes so that protections provided by 15A NCAC 03K .0209 may be accurately applied. In addition, accurately delineated boundaries will help safeguard boaters navigating the area.

Removal of Two Non-functioning Sanctuary Sites from Rule

Along with the amendments described above, DMF proposes to remove coordinates delineating boundaries for two sanctuaries, OS-04 (Clam Shoal) and OS-06 (Ocracoke), from rule. These two sites were originally founded by fishing clubs in Hatteras and Ocracoke, for the purpose of recreational hook and line fishing. Following the BRACO's recommendations to establish oyster sanctuaries in 1996, the reef sites were delineated as oyster sanctuaries under 15A NCAC 03R .0117 and thereby protected from oyster harvest under 15A NCAC 03K .0209. In the years following sanctuary delineation, the boundaries of the reef sites were substantially expanded in permit and further developed by the Artificial Reef Program as artificial reefs. The boundaries for sanctuary protections were never expanded at these two sites, therefore only a subsection of each reef site is protected from oyster harvest as described in 15A NCAC 03R .0117 (Figures 5 and 6). Presently, both Ocracoke and Clam Shoal reefs are marked by buoys identifying their outside margins, but do not offer any reference point for where harvest is restricted.

Long term biological evaluation has led to a determination that the Clam Shoal and Ocracoke sites no longer function as biologically productive oyster sanctuaries. The Marine Protected Area/sanctuary model is a management tool whereby small areas of high productivity habitats are protected to support broodstock with high reproductive potential. For oyster restoration, effective sanctuary sites must intrinsically sustain high population densities of adult oysters. DMF maintains a monitoring program to assess the productivity of each sanctuary with a restoration target of 10 oysters/m² (Powers et al. 2009). Sanctuaries are expected to maintain oyster densities above this threshold to be considered functioning restoration tools. Under DMF's monitoring, Clam Shoal initially showed promising settlement success similar to other sanctuaries within the Pamlico Sound. By year three, however, Clam Shoal's oyster densities fell well below the threshold of 10 oysters/m² and has remained below this threshold since that time. The apparent low oyster densities are indicative of low juvenile oyster recruitment or low survivorship to adulthood. Oyster densities at Ocracoke, identical to Clam Shoal, exhibited an abrupt decline with little evidence of recovery (Figure 7; Z. Knorek, unpublished). Observed population density trends here offer strong evidence that oyster population recovery is unlikely, given relatively unfavorable environmental conditions. Both Clam Shoal and

Ocracoke oyster sanctuaries are unique compared to all others due to their locations in relatively high salinity waters (>16 psu; Figure 8). In this habitat regime, increased diversity and abundance of competing biofouling organisms (barnacles, alga, sponge), shellfish predators (sheepshead, crabs, etc.) and pests (*Cliona* boring sponge) commonly occur and can negatively influence oyster settlement and reef persistence. Given that long term oyster population trends at both Ocracoke and Clam Shoal reefs exhibit extremely low oyster population densities, is it easy to conclude that these sites are not serving their management purpose for oyster restoration. Therefore, it is appropriate for these sites to be considered for removal from the existing oyster sanctuary rule.

While Ocracoke and Clam Shoal, also known as Artificial Reef-298 (AR-298) and AR-296, respectively, are not reasonably considered oyster reefs, it is important to appreciate the habitat value these sites continue to offer. Both reefs function as hard bottom habitat for many other invertebrates and finfish as well as a destination for many anglers along the Outer Banks. These reefs will be included with other reefs as estuarine and oceanic artificial reef rules develop under future rule amendments and in conjunction with proposed Special Management Zone designation.

Summary and Implications

Historically, oyster sanctuary site selection leaned heavily on a very limited understanding of oyster habitat suitability and was largely dependent upon where historic oyster reefs once existed. New strategies and techniques used for deployment, as well as new technology for physical and biological monitoring have substantially improved oyster reef enhancement success rates and have reduced errors. With the development of a more modern habitat suitability index (HSI) model which rates areas based on salinity gradient, bottom type, tidal flow, larval transport, wave action, and prevailing wind data as well as historic oyster presence data and input from stakeholders, managers are able to better choose areas to develop as sanctuaries and accurately delineate their boundaries.

The DMF recommends amending North Carolina Marine Fisheries Rule 15A NCAC 03R .0117 by adding boundaries for five additional oyster sanctuaries (Long Shoal, Raccoon Island, Pea Island, Little Creek, and Swan Island) developed since the rule was last amended. The DMF also proposes modified boundaries of three existing sanctuaries (Neuse River, Gibbs Shoal, and West Bluff). Modifications to these sanctuary boundaries are necessary to encompass existing reef material recently discovered outside the present boundaries. Finally, Ocracoke and Clam Shoal sanctuaries are proposed for removal from the rule, considering the apparent lack of existing resource to protect and the unlikely reestablishment of new oyster resource in the future.

While proposed modifications would affect previously reported sanctuary acreage, a net positive effect is realized considering the changes would adopt a substantially greater total area of protected oyster resource and accurately delineate high quality oyster habitat with extreme precision. The proposed modifications align the MFC rules with delineated boundaries in permits, which is essential for state and federal regulatory consistency as well as safe maritime navigation.

Rule 15A NCAC 03R .0117 (1)(c), (1)(d), (1)(i), (1)(j) and (2)(a) show proposed changes to incorporate the boundaries of the new sanctuaries, Pea Island, Long Shoal, Swan Island, Raccoon Island, and Little Creek. The proposed changes in 15A NCAC 03R .0117 (1)(e), (1)(g), and (2)(b) update the boundaries of Gibbs Shoal, West Bluff, and Neuse River sanctuaries. Clam Shoal and Ocracoke are proposed to be deleted from (1). Proposed changes result in a net total increase of ~101 acres of protected oyster sanctuary area (Table 2).

Additional minor changes are proposed to address inconsistencies with organization of the existing rule. The “Croatan Sound area” actually designates the “Croatan Sound” Oyster Sanctuary, which is located in the Pamlico Sound area. As a result, this sanctuary is proposed to be re-numbered in the rule from (1) to (1)(a). Similarly, “Neuse River area” actually designates the “Neuse River” Oyster Sanctuary, so it is proposed to be renumbered from (3) to (2)(b).

IV. TABLES AND FIGURES

Table 1. Oyster Sanctuary Names, Locations, Spatial Extents, and Development. Reported boundary sizes are calculated on areas bound by delineating coordinates in 15A NCAC 03K .0209. Ocracoke and Clam Shoal sites are substantially larger than what is reported in this table (*see Discussion*). Values for Habitat Footprint and Total Material Deployed are subject to increase over time, as reef enhancement and construction are ongoing.

OS#	Site Name	Latitude	Longitude	Boundary Size (Acres)	Habitat Footprint (Acres)	Total Material Deployed (Tons)
1	Croatan Sound	35° 48.238' N	75° 38.397' W	7.73	3.10	2,093
2	Deep Bay	35° 22.842' N	76° 22.249' W	17.20	4.15	1,749
3	West Bay	34° 58.809' N	76° 21.418' W	6.56	2.27	2,329
4	Clam Shoal	35° 17.334' N	75° 37.325' W	58.12	21.45	38,359
5	Crab Hole	35° 43.592' N	75° 40.629' W	30.52	13.26	36,489
6	Ocracoke	35° 10.723' N	75° 59.743' W	28.05	10.36	15,183
7	Middle Bay	35° 14.137' N	76° 30.255' W	4.59	0.27	900
8	Neuse River	35° 0.433' N	76° 32.005' W	11.21	3.55	7,357
9	West Bluff	35° 18.223' N	76° 10.182' W	29.42	2.82	10,162
10	Gibbs Shoal	35° 27.228' N	75° 56.075' W	54.69	8.19	22,447
11	Long Shoal	35° 33.806' N	75° 49.833' W	10.01	1.13	2,173
12	Raccoon Island	35° 5.422' N	76° 23.471' W	9.97	1.61	1,824
13	Pea Island	35° 39.960' N	75° 36.940' W	46.63	2.62	3,420
14	Little Creek	35° 2.616' N	76° 30.889' W	20.71	6.14	5,700
15	Swan Island	35° 5.551' N	76° 27.134' W	60.30	10.93	55,000
Total				395.44	91.85	205,185

- Sanctuaries (1-10) are under authority of rules 15A NCAC 03K .0209 and 03R .0117.
- Sanctuaries 4 and 6 are proposed for removal from 15A NCAC 03R .0117 and subsequent protections of 15A NCAC 03K .0209
- Sanctuaries (11-12) are under authority of Rule 15A NCAC 03K .0103 via Proclamation SF-2-2019.
- Sanctuaries (13-15) are not yet codified in rule.
- Latitude and longitude points mark the center of each site.

Table 2: Oyster Sanctuaries with New or Updated Boundaries for Sanctuary Protection in Rule

OS #	Site Name	Old Boundary (Acres)	Proposed Boundary (Acres)	Difference (Acres)
4	Clam Shoal	58.12	0	-58.12
6	Ocracoke	28.05	0	-28.05
8	Neuse River	5.71	11.21	5.50
9	West Bluff	19.95	29.42	9.47
10	Gibbs Shoal	30.02	54.69	24.67
11	Long Shoal	0	10.01	10.01
12	Raccoon Island	0	9.97	9.97
13	Pea Island	0	46.63	46.63
14	Little Creek	0	20.71	20.71
15	Swan Island	0	60.30	60.30
--	Total	141.85	242.94	101.09

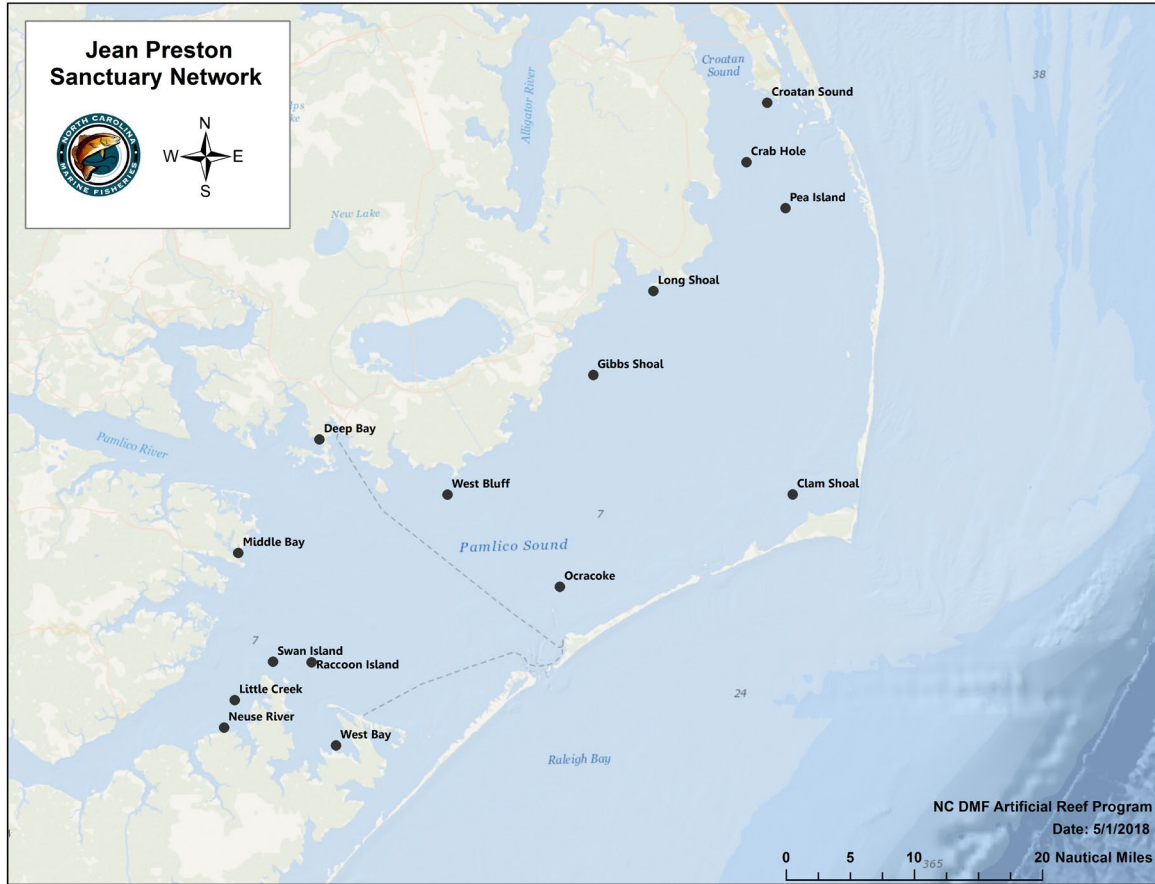


Figure 1. Oyster Sanctuary locations.

OS-08 Neuse River

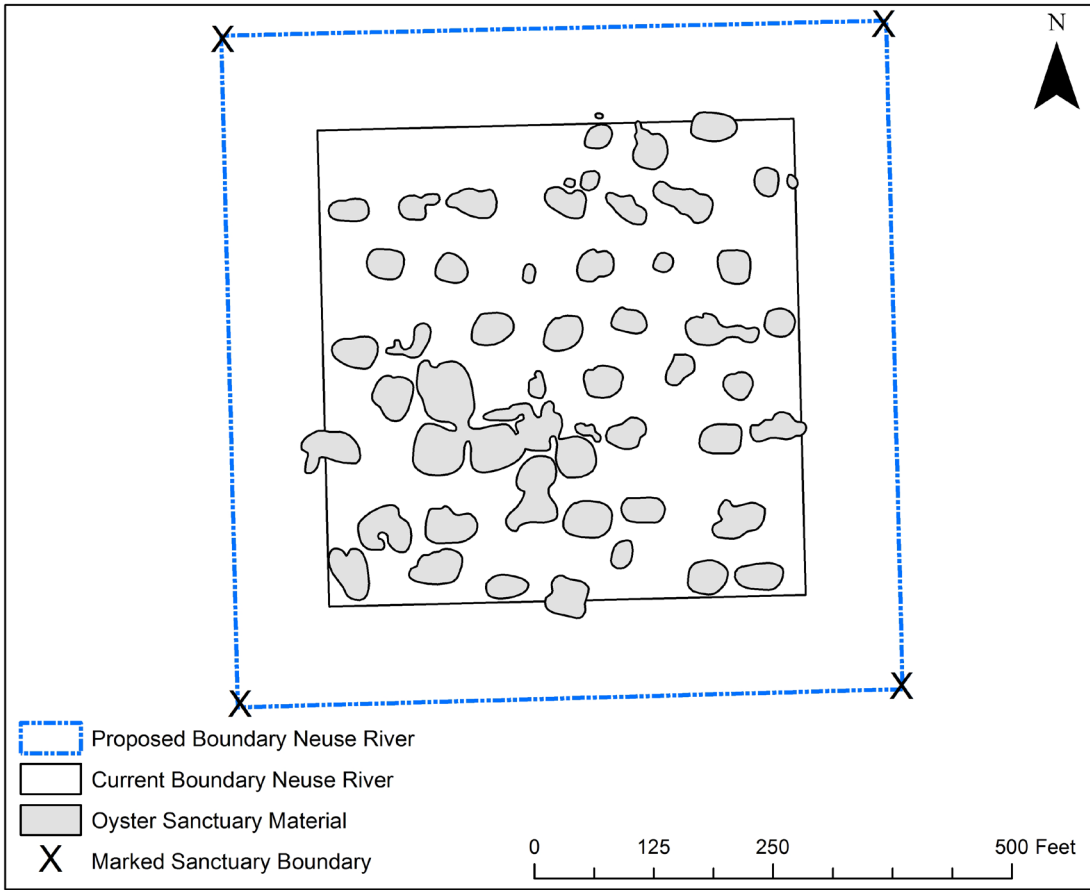


Figure 2. Neuse River Oyster Sanctuary. Proposed boundary marks 100-foot buffer from outermost material.

OS-09 West Bluff

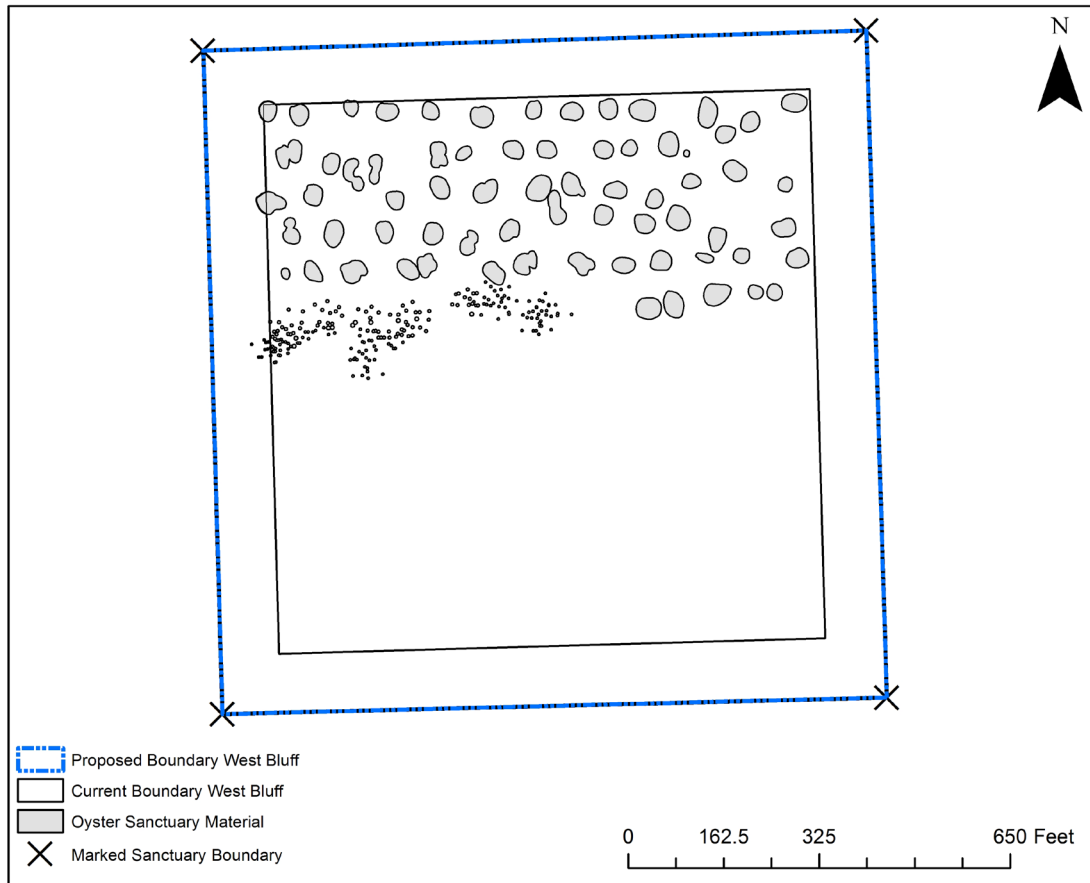


Figure 3. West Bluff Oyster Sanctuary. Proposed boundary marks 100-foot buffer from outermost material.

OS-10 Gibbs Shoal

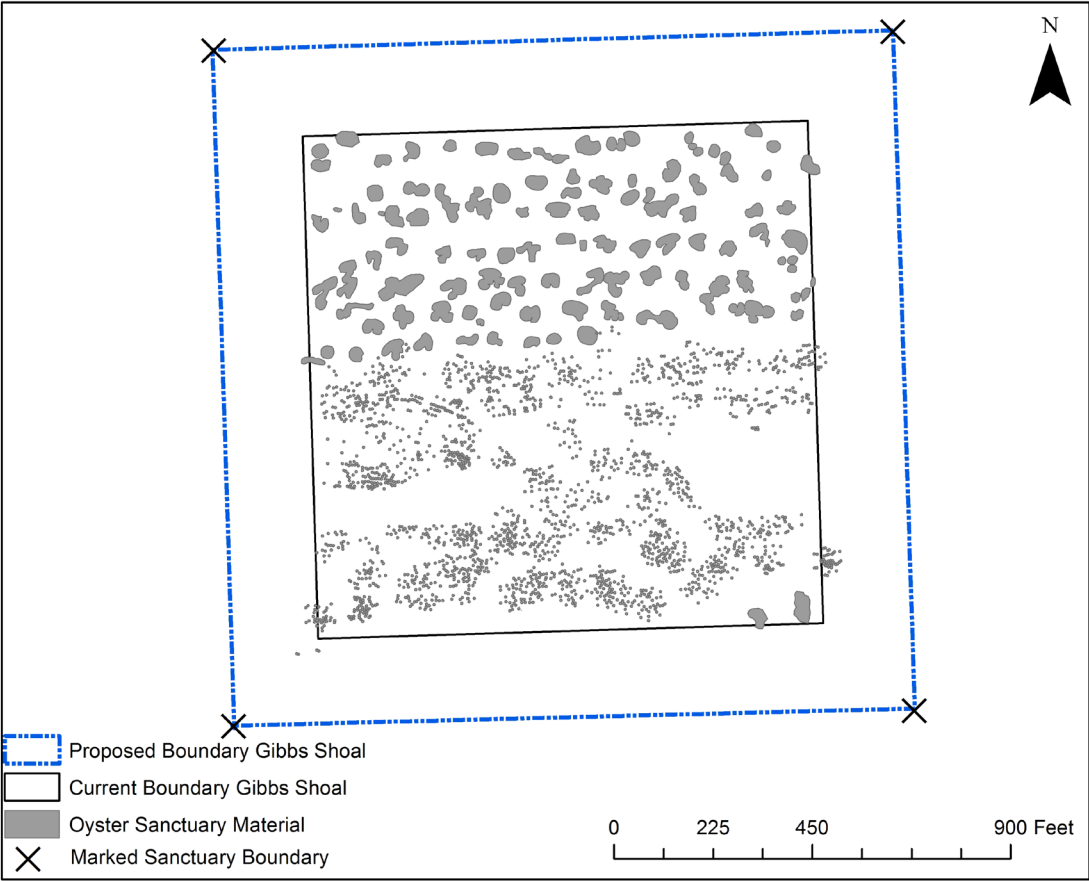


Figure 4. Gibbs Shoal Oyster Sanctuary. Proposed boundary marks 100-foot buffer from outermost material.

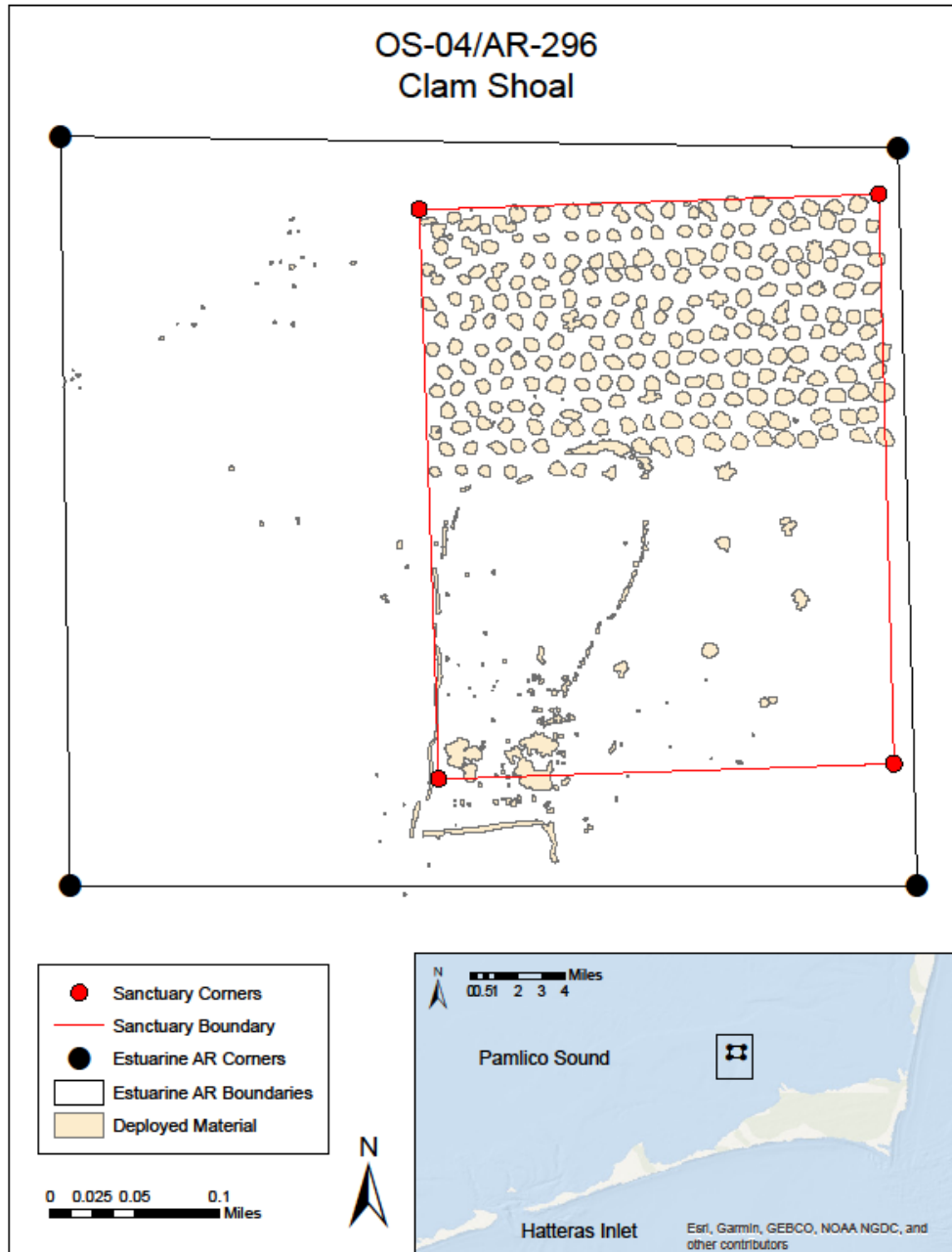


Figure 5. Map of Clam Shoal Reef (Hatteras Island Business Association Reef) and Oyster Sanctuary.

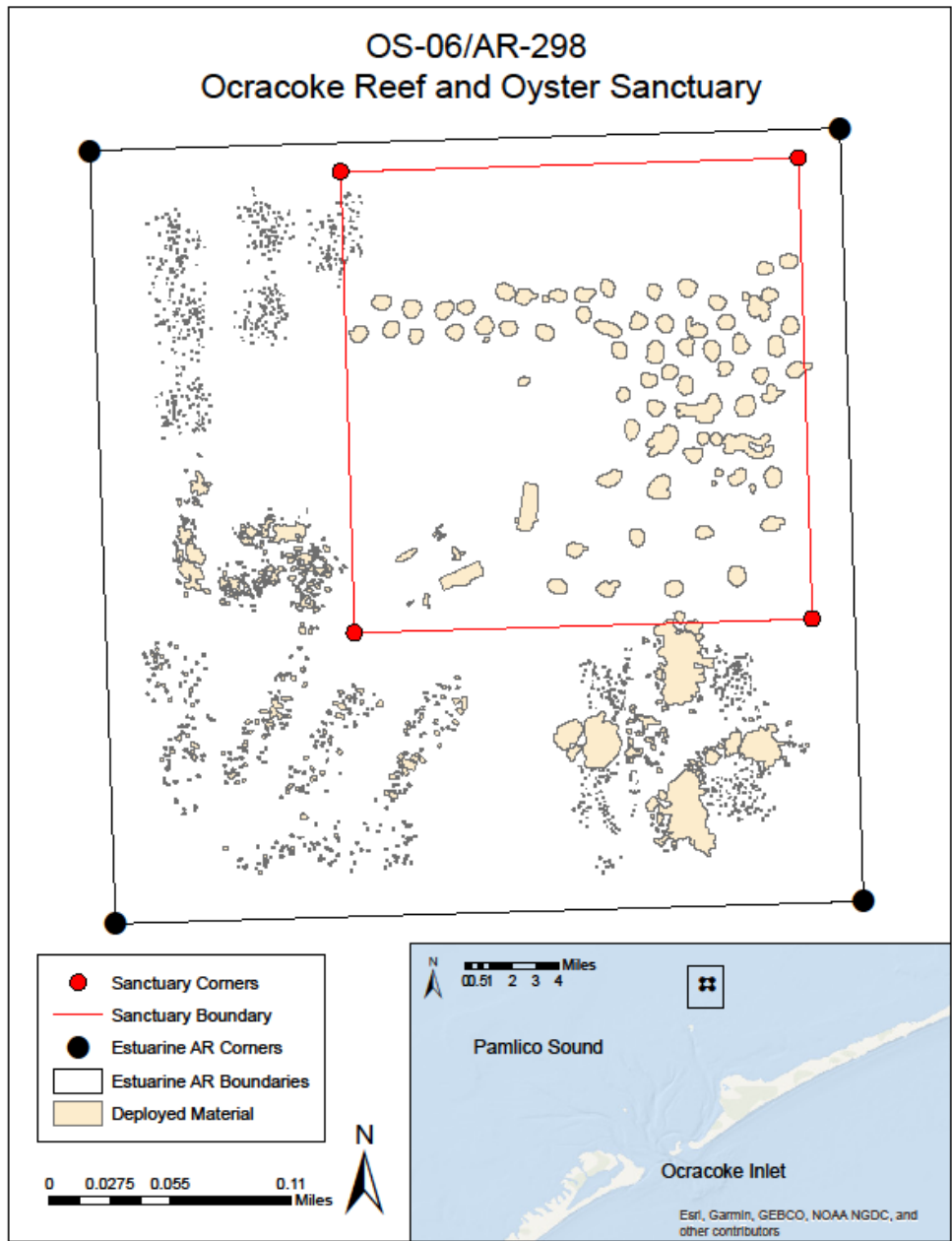


Figure 6. Map of Ocracoke Reef and Oyster Sanctuary.

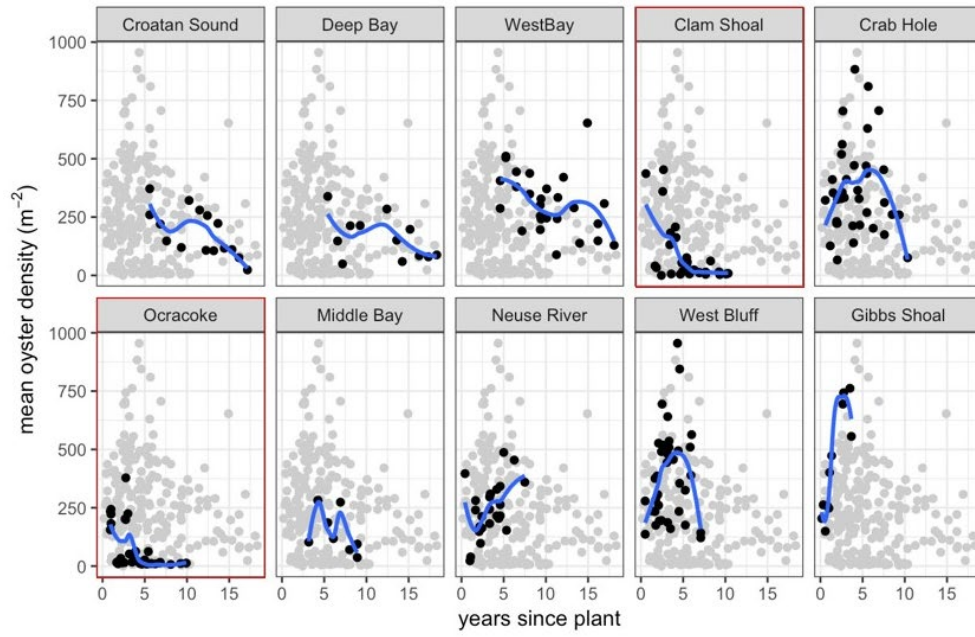


Figure 7. Oyster mean densities per site since sanctuary was planted (Z. Knorek, unpublished).

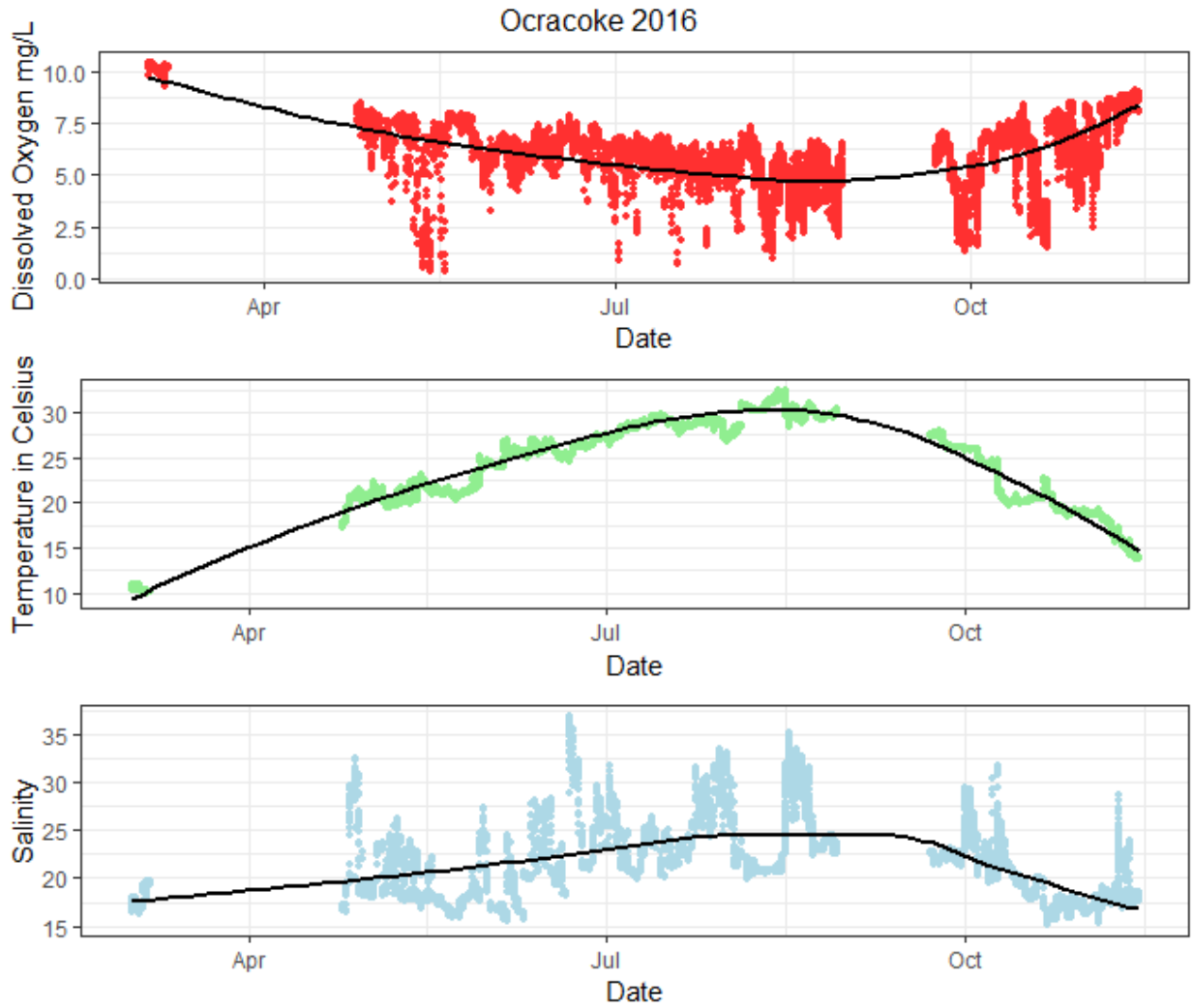


Figure 8. Water quality data collected at OS-04/AR 298 from March 2, 2016 - October 25, 2016.

VII. PROPOSED RULE(S)

15A NCAC 03R .0117 OYSTER SANCTUARIES

The Oyster Sanctuaries referenced in 15A NCAC 03K .0209 are delineated in the following coastal water areas:

- (1) ~~Croatan Sound area: within the area described by a line beginning at a point 35° 48.2842' N - 75° 38.3360' W; running southerly to a point 35° 48.1918' N - 75° 38.3360' W; running westerly to a point 35° 48.1918' N - 75° 38.4575' W; running northerly to a point 35° 48.2842' N - 75° 38.4575' W; running easterly to the point of beginning.~~
- (2)(1) Pamlico Sound area:
- (a) ~~Croatan Sound: within the area described by a line beginning at a point 35° 48.2842' N - 75° 38.3360' W; running southerly to a point 35° 48.1918' N - 75° 38.3360' W; running westerly to a point 35° 48.1918' N - 75° 38.4575' W; running northerly to a point 35° 48.2842' N - 75° 38.4575' W; running easterly to the point of beginning.~~
- (a)(b) ~~Crab Hole: within the area described by a line beginning at a point 35° 43.6833' N - 75° 40.5083' W; running southerly to a point 35° 43.5000' N - 75° 40.5083' W; running westerly to a point 35° 43.5000' N - 75° 40.7500' W; running northerly to a point 35° 43.6833' N - 75° 40.7500' W; running easterly to the point of beginning.~~
- (c) ~~Pea Island: within the area described by a line beginning at a point 35° 05.4760' N - 76° 23.5370' W; running southerly to a point 35° 05.4760' N - 76° 23.4040' W; running westerly to a point 35° 05.3680' N - 76° 23.4040' W; running northerly to a point 35° 05.3680' N - 76° 23.5370' W; running easterly to the point of beginning.~~
- (d) ~~Long Shoal: within the area described by a line beginning at a point 35° 33.8600' N - 75° 49.9000' W; running southerly to a point 35° 33.8600' N - 75° 49.7670' W; running westerly to a point 35° 33.7510' N - 75° 49.7670' W; running northerly to a point 35° 33.7510' N - 75° 49.9000' W; running easterly to the point of beginning.~~
- (b)(c) ~~Gibbs Shoal: within the area described by a line beginning at a point 35° 27.3557' N - 75° 55.8434' W; 35° 27.3550' N - 75° 55.9190' W; running southerly to a point 35° 27.1732' N - 75° 55.8434' W; 35° 27.1010' N - 75° 55.9190' W; running westerly to a point 35° 27.1732' N - 75° 56.0735' W; 35° 27.1010' N - 75° 56.2300' W; running northerly to a point 35° 27.3557' N - 75° 56.0735' W; 35° 27.3550' N - 75° 56.2300' W; running easterly to the point of beginning.~~
- (e)(f) ~~Deep Bay: within the area described by a line beginning at a point 35° 22.9126' N - 76° 22.1612' W; running southerly to a point 35° 22.7717' N - 76° 22.1612' W; running westerly to a point 35° 22.7717' N - 76° 22.3377' W; running northerly to a point 35° 22.9126' N - 76° 22.3377' W; running easterly to the point of beginning.~~
- (d)(g) ~~West Bluff: within the area described by a line beginning at a point 35° 18.3000' N - 76° 10.0890' W; 35° 18.3160' N - 76° 10.2960' W; running southerly to a point 35° 18.1460' N - 76° 10.0890' W; 35° 18.3160' N - 76° 10.0690' W; running westerly to a point 35° 18.1460' N - 76° 10.2760' W; 35° 18.1290' N - 76° 10.0690' W; running northerly to a point 35° 18.3000' N - 76° 10.2760' W; 35° 18.1290' N - 76° 10.2960' W; running easterly to the point of beginning.~~
- (e) ~~Clam Shoal: within the area described by a line beginning at a point 35° 17.4800' N - 75° 37.1800' W; running southerly to a point 35° 17.1873' N - 75° 37.1800' W; running westerly to a point 35° 17.1873' N - 75° 37.4680' W; running northerly to a point 35° 17.4800' N - 75° 37.4680' W; running easterly to the point of beginning.~~
- (f)(h) ~~Middle Bay: within the area described by a line beginning at a point 35° 14.1580' N - 76° 30.1780' W; running southerly to a point 35° 14.1150' N - 76° 30.1780' W; running westerly to a point 35° 14.1150' N - 76° 30.3320' W; running northerly to a point 35° 14.1580' N - 76° 30.3320' W; running easterly to the point of beginning.~~
- (i) ~~Swan Island: within the area described by a line beginning at a point 35° 05.6170' N - 76° 27.5040' W; running southerly to a point 35° 05.6020' N - 76° 26.7650' W; running westerly to a point 35° 05.4850' N - 76° 26.7640' W; running northerly to a point 35° 05.4990' N - 76° 27.5030' W; running easterly to the point of beginning.~~

- (g) ~~Ocracoke area: within the area described by a line beginning at a point 35° 10.8150' N - 75° 59.6320' W; running southerly to a point 35° 10.6320' N - 75° 59.6320' W; running westerly to a point 35° 10.6320' N - 75° 59.8530' W; running northerly to a point 35° 10.8150' N - 75° 59.8530' W; running easterly to the point of beginning.~~
- (j) Raccoon Island: within the area described by a line beginning at a point 35° 05.4760' N - 76° 23.5370' W; running southerly to a point 35° 05.4760' N - 76° 23.4040' W; running westerly to a point 35° 05.3860' N - 76° 23.4040' W; running northerly to a point 35° 05.3680' N - 76° 23.5370' W; running easterly to the point of beginning.
- ~~(h)~~(k) West Bay: within the area described by a line beginning at a point 34° 58.8517' N - 76° 21.3632' W; running southerly to a point 34° 58.7661' N - 76° 21.3632' W; running westerly to a point 34° 58.7661' N - 76° 21.4735' W; running northerly to a point 34° 58.8517' N - 76° 21.4735' W; running easterly to the point of beginning.
- ~~(3)~~(2) Neuse River: River area:
- (a) Little Creek: within the area described by a line beginning at a point 35° 02.6940' N - 76° 30.9840' W; running southerly to a point 35° 02.6940' N - 76° 30.7940' W; running westerly to a point 35° 02.5380' N - 76° 30.7940' W; running northerly to a point 35° 02.5380' N - 76° 30.9840' W; running easterly to the point of beginning.
- (b) Neuse River: within the area described by a line beginning at a point ~~35° 00.4742' N - 76° 31.9550' W~~; 35° 00.4910' N - 76° 31.9350' W; running southerly to a point ~~35° 00.3920' N - 76° 31.9550' W~~; 35° 00.3750' N - 76° 31.9350' W; running westerly to a point ~~35° 00.3920' N - 76° 32.0550' W~~; 35° 00.3750' N - 76° 32.0750' W; running northerly to a point ~~35° 00.4742' N - 76° 32.0550' W~~; 35° 00.4910' N - 76° 32.0750' W; running easterly to the point of beginning.

*History Note: Authority G.S. 113-134; 113-182; 113-201; 113-204; 143B-289.52;
Eff. October 1, 2008;
Amended Eff. May 1, 2020; April 1, 2011.*

VIII. LITERATURE CITED

Frankenberg, D. 1995. North Carolina Blue Ribbon Advisory Council on Oysters. Final Report on Studies and Recommendations. North Carolina Department of Environment, Health, and Natural Resources. Raleigh, NC.

Gell FR and Roberts CM (2002) The fishery effects of marine reserves and fishery closures. World Wildlife Fund-US, Washington D.C., USA.

Halpern BS (2003) The impact of marine reserves: Do reserves work and does reserve size matter? *Ecol Appl* 13:S117-S137

Powers, S. P., C.H. Peterson, J. H. Grabowski & H. S. Lenihan. 2009. Success of constructed oyster reefs in no harvest sanctuaries: implications for restoration. *Mar. Ecol. Prog. Ser.* 389:159-170

Sobel JA and Dahlgren CP (2004) Marine reserves. A guide to science, design and use. Island Press, Washington, D.C., USA

IX. PROPOSED MANAGEMENT OPTIONS

(+ Potential positive impact of action)

(- Potential negative impact of action)

A. *Status quo*

- New Oyster Sanctuaries not fully protected in rule
- Outdated boundaries remain in rule for existing Oyster Sanctuary boundary lines
- Navigational Hazards to boaters

- Does not comply with principles of rulemaking in G.S. 150-B
- Inconsistent with state and federal permitting
- + No additional expenses for law enforcement and buoy maintenance

B. Amend rule to add new oyster sanctuaries, remove two sanctuaries, and update boundaries

- + New Oyster Sanctuaries fully protected in rule
- + Existing Oyster Sanctuary boundary lines would be updated
- + Safeguards boaters navigating the Oyster Sanctuaries
- + Complies with principles of rulemaking in G.S. 150-B
- + Removes unnecessary protections from certain reefs that are no longer effective oyster restoration tools
- + Addition of 100-foot construction buffer
- + Net increase of more than 101 acres of high-quality oyster habitat
- Increased expenses for marine law enforcement and buoy maintenance

X. RECOMMENDATION

DMF recommends the MFC approve Notice of Text for rulemaking in support of the proposed changes (Option B).

Prepared by: Kaitlin DeAeth
 April 3, 2018
 Revised: May 7, 2018
 Revised by: Jason Peters
 April 10, 2019

NOTICE OF TEXT ATTACHMENT

15A NCAC 03R .0117 OYSTER SANCTUARIES

Proposed amendments add the boundaries of five new Oyster Sanctuaries (Long Shoal, Little Creek, Pea Island, Raccoon Island, and Swan Island), remove boundaries of two Oyster Sanctuaries (Ocracoke and Clam Shoal), and update boundaries for three existing Oyster Sanctuaries (Neuse River, West Bluff, and Gibbs Shoal) where material was found to be outside of the perimeter due to construction or movement during settlement. These changes will protect oysters from bottom disturbing gear and safeguard boaters navigating the sanctuaries.

MFC Rulebook Index Worksheet			
Subject	Rulebook Page #	Entries	Add or Delete?
N/A	N/A	N/A	N/A

Ancillary items: update GIS database/maps; rescind Proclamation SF-2-2019

DIRECTOR'S REPORT

**HOOK-AND-LINE
MODIFICATIONS**

ASMFC

MAFMC

SAFMC

HMS

**PROTECTED
RESOURCES
UPDATE**

**RULES
SUSPENSION
UPDATE**

**LANDINGS
UPDATE**



ROY COOPER
Governor

MICHAEL S. REGAN
Secretary

STEPHEN W. MURPHEY
Director

January 24, 2020

MEMORANDUM

TO: N.C. Marine Fisheries Commission
FROM: Steve Poland, Executive Assistant for Councils
SUBJECT: Information on Recreational Hook and Line Modifications

Issue

Information on the efficacy of circle hook and barbless treble hook requirements in North Carolina coastal waters.

Action Needed

For informational purposes only, no action is needed at this time.

Overview

The following information paper summarizes the most recent scientific information related to hook modifications in the recreational fishery to reduce dead discards from catch-and-release fishing and provides commentary on potential considerations for the implementation of circle and barbless treble hook requirements in North Carolina coastal waters. Summary findings from the information paper include:

- In general, science supports the use of circle hooks as a means to reduce hook trauma and discard mortality
 - Aside from extensive research on red drum, few studies have been conducted in North Carolina that evaluate the effectiveness of circle hooks
 - Studies suggests that off-set circle hooks negate the positive benefits of circle hooks
- Very little research exists on the effects of hook trauma by treble hooks
- No industry standard exists for circle hook style and size
 - If circle hook use is required, a clear definition is needed
- Other management jurisdictions that require the use of circle hooks focus on single species/fisheries or complexes to implement hook requirements
 - Reduces unintended consequences, i.e. live bait trolling, exclusion of species with unique mouth physiologies, etc.
 - Increases the likelihood of compliance and enforcement
- Consider positive and negative social and economic effects
 - Potential decrease in angler satisfaction through decreased catch rates for some species
 - Positive impact to catch rates if population responds to reduced discard mortality
 - Economic impact to anglers and tackle shops

Information on requiring the use of circle hooks and bent-barbed treble hooks in North Carolina

January 28, 2020

Prepared by the Recreational Hook-and-line Discard Work Group

I. ISSUE

Provide summary scientific information on the efficacy of using circles hooks and bent-barbed treble hooks to reduce discard mortality of captured-and-released fish in North Carolina joint, coastal, and Atlantic Ocean waters out to three nautical miles. Additionally, provide input on the pros and cons of implementation of circle hook and bent barbed requirements including summary information of neighboring states and jurisdictions, expected benefits and limitations, and enforcement applicability.

II. ORIGINATION

At the August 2019 meeting of the Marine Fisheries Commission, the Chairman asked for the consideration of a motion to instruct the Division of Marine Fisheries to initiate rulemaking to require the use of circle hooks larger than 2/0 when fishing with natural bait and that all treble hooks have barbs pinched down. After discussion and a withdrawal of the motion, the Chair asked the Division to provide information on the science supporting the use of circles hooks, bent-barbed treble hooks and input on the efficacy of requiring their use in North Carolina waters.

III. BACKGROUND

Literature Review

The location of hook-related injuries is an important factor in determining catch-and-release mortality. A number of studies have shown the use of circle hooks in marine recreational fisheries reduce deep hooking and release mortality in marine finfish species (Grover et al. 2002; Lukacovic and Uhhoff 2002; Skomal et al. 2002). The first use of circle hooks in modern fisheries were by long line fisherman in the Pacific Ocean in the 1970s. However, the basic style of the hook pre-dates this use by thousands of years, evidenced by the discovery of circle hooks fashioned from shell and bone discovered throughout ancient Polynesia, Japan, and Latin America. The style hook was adopted by commercial fisherman in an effort to increase retention of target species in longline and trot line fisheries and to reduce mortality of bycatch and regulatory discards. The basic mechanics of a circle hook are explained by Johanes (1981). As a fish consumes a baited-circle hook and moves away, the hook naturally slides to the edge of the mouth in an orientation that allows for the gap to position around the jaw (Figure 1). As the pressure begins to increase, the hook point begins to “bite” against the soft flesh around the mandible or hinge. As pressure further increases, the hook rotates fully around and the fish is hooked. The circular design with the hook pointed back towards the shank prevents the hook from backing out completely while steady pressure is applied. Because the orientation of the hook point is not the same as the shank (Figure 1), when pressure is applied to the hook via the fishing line, the point does not catch as it would with a traditional style “J” hook. This reduces the chance of deep hooking when a hook is swallowed past the esophageal sphincter (Kerstetter and Graves 2006).

Hook size, fishing style, fish feeding mode, and mouth morphology are all elements that contribute to the effectiveness of circle hooks. In a study on bluegills, circle hooks permanently impaired vision of up to 22% of the fish, much more than J-hooks (Cooke et al. 2003). Conversely, Graves and Horodysky (2008) state that the post-release survival of white marlin captured using circle hooks is significantly higher than J-hooks. There was no significant difference in survival among different configurations of non-offset circle hooks commonly employed in the white marlin troll fishery (i.e. offset, bite, gap, bend, etc.) suggesting that the use of a non-offset circle hook, regardless of configuration, is better. These varying factors make the implementation of circle hook regulations as a universal solution to reduce release mortality for all fisheries in coastal waters complex. Several studies have recommended that management agencies focus on recommending circle hooks only for instances for which appropriate scientific data exist (Cooke and Suski 2004, Serafy et al. 2012). While the use of circle hooks may present a conservation benefit in some of these fisheries, only the adult red drum fishery in Pamlico Sound has been fully evaluated comparing large J-hooks to circle hooks in our coastal waters (Beckwith and Rand 2005).

Literature for the effects of treble hooks on the survival of captured and released fish is limited and at this time, few studies have been reviewed for species that occur in the state. Studies in Texas, showed no significant differences in release mortality for red drum and spotted seatrout between J-hooks and treble hooks (Matlock et al. 1993; Stunz and McKee 2006). Unfortunately, these studies did not include circle hooks as a gear type for comparison.

Defining a circle hook

A growing body of literature suggests that the use of circle hooks by recreational saltwater anglers reduces discard mortality (Cooke et al. 2012). Despite this general consensus, inconsistency exists regarding the definition of a circle hook among federal, regional, and state management authorities (Table 1). This complicates the implementation of management actions across regulatory jurisdictions. However, an overlapping characteristic across all circle hook definitions include “*the point turned perpendicularly back to the shank*”.

Table 1. Definitions of a Circle Hook across multiple management authorities

<i>National Marine Fisheries Service (NMFS) Highly Migratory Species Division (HMS):</i> A circle hook is defined as “A hook with the point turned perpendicularly back to the shank to form a generally circular or oval shape.” An offset circle hook is further defined as “a circle hook originally designed and manufactured so that the barbed end of the hook is displaced relative to the parallel plane of the eyed-end, or shank, of the hook when laid on its side.” (50 C.F.R. § 635.2)
<i>Atlantic States Marine Fisheries Commission (ASMFC):</i> A circle hook is defined as “Non-offset hook with the point turned perpendicularly back to the shank.”
<i>Gulf of Mexico Fishery Management Council (GMFMC) and South Atlantic Fishery Management Council (SAFMC):</i> A circle hook is defined as “A fishing hook designed and manufactured so that the point is turned perpendicularly back to the shank to form a generally circular, or oval, shape” (50 C.F.R. § 622.2)
<i>North Carolina Marine Fisheries Commission (MFC):</i> A circle hook is defined as “A hook with the point of the hook directed perpendicularly back toward the shank, and with the barb either compressed or removed”. (15A NCAC 03J.0306)

Inconsistency among management authorities is further complicated by non-uniformity in circle hook design among and within major hook manufacturers. While hooks may have the same basic anatomy (Figure 1), extensive combinations of attributes (gap, bite, shank length, total length, gap, eye, barb, bend), and barb orientation (offset or inline) make it almost impossible to adequately classify a hook by the manufacturer sizing.

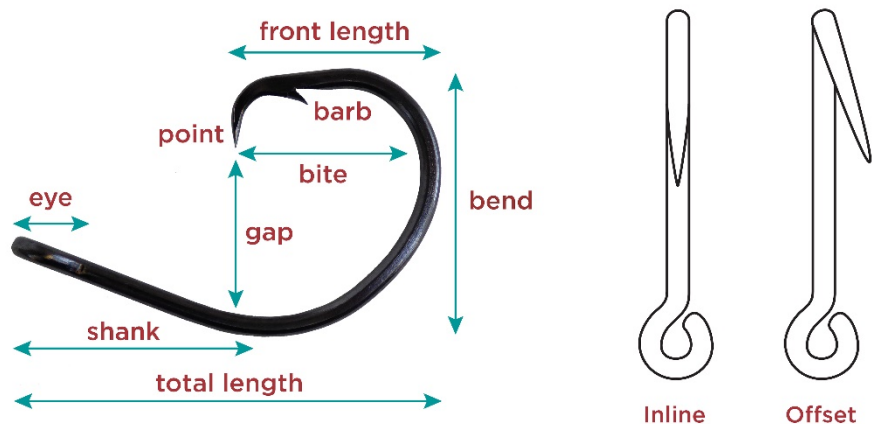


Figure 1. Basic hook anatomy and barb orientation. Reproduced from: www.in-fisherman.com/editorial/all-about-hooks/154924.

Hooks are manufactured from a myriad of metal and alloys (vanadium, high-carbon steel, stainless steel, etc.) and may come with an assortment of coatings for color preference and/or corrosion resistance. Most importantly, there is no size standardization within and among manufacturers. Figure 2 presents 4/0 hooks from three manufacturers (Eagle Claw, Mustad, Owner) with gap measurements ranging from 10mm to 14mm. The largest difference in gap shown is from two separate models of Eagle Claw 4/0 hooks. The same holds true for J-hook sizing as well. Although offerings are limited at this time, most hook manufactures do offer barbless versions of circle hooks and treble hooks.

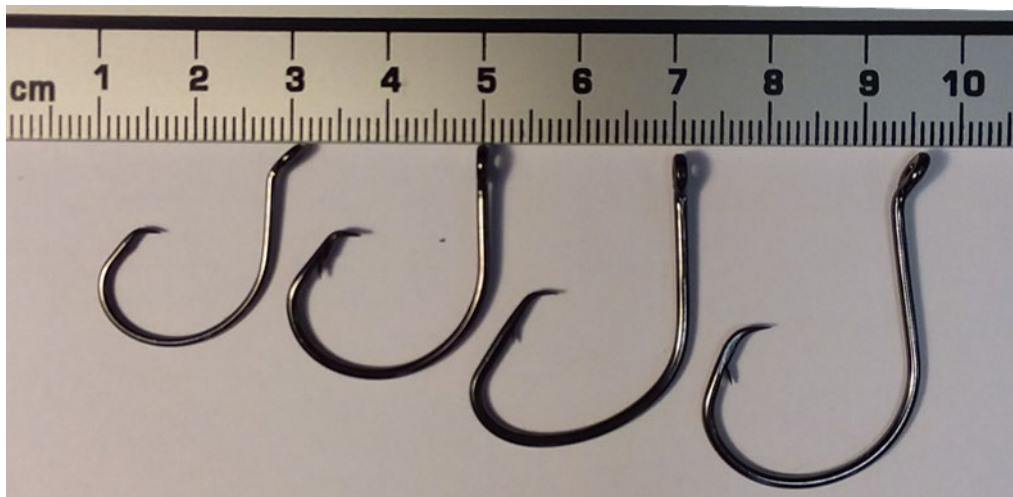


Figure 2. Left to right; Eagle Claw L2004EL, Mustad 3994-BN, Owner 5114T-141, Eagle Claw L7228BPG.

Other Jurisdictions

The Wildlife Resources Commission (WRC) restricts the use of multiple hooks and barbed hooks in the inland waters of the Roanoke River upstream of the U.S. 258 bridge. Only a single barbless hook or a lure with a single barbless hook may be used from April 1 to June 30. “Barbless” means that the hook either does not have a barb or that the barb is bent down. Tandem rigs are prohibited.

Many Atlantic coast states have rules that limit the time and area certain species can be harvested using traditional and/or barbed hooks and restrictions on the style of hooks used. The Florida Fish and Wildlife Commission (FWC) prohibits the harvest of Florida and African pompano, sheepshead, permit, spotted sea trout, snook, tarpon, flounder, and red and black drum with any multiple point hook in conjunction with live or natural bait. Multiple point hooks are defined as a hook with two or more points that share a common shaft. The FWC also requires angler who are shark fishing from shore or private vessel to use non-offset, non-stainless steel circle hooks when using live or dead natural bait. Further, an angler must also have in their possession a device that is capable of quickly cutting the hook or leader, i.e. bolt cutters, lineman pliers, cable cutters, etc.

Maryland Department of Natural Resources require the use of non-offset circle hooks while fishing in the Chesapeake Bay and its tidal tributaries when live-lining or chumming from May 16 to December 15. The use of treble hooks is prohibited when using other natural or processed baits while not live-lining or chumming. Additional restrictions on terminal tackle apply when fishing for striped bass depending on season and area. Some of these restrictions include the prohibition on using “stinger” hooks, use of barbless hooks when trolling, limited to six trolling lines per vessel, and require use of circle and J hooks with less than ½-inch gap.

The New York State Department of Environmental Conservation prohibits the take of sharks by baited hooking except with the use of non-stainless steel, non-offset circle hooks. Additionally, no person shall conduct, sponsor, or participate in any fishing tournament that offers a prize for sharks unless the tournament rules require the exclusive use of non-stainless steel, non-offset circle hooks.

Federal and interstate requirements for the use or restriction of certain types of hooks and terminal gear exist. The South Atlantic Fishery Management Council (SAFMC) requires the use of non-offset, non-stainless steel circle hooks North of 28° latitude when in possession of any snapper-grouper species. The SAFMC recently approved Regulatory Amendment 29 to the Snapper-Grouper Fishery Management Plan which requires the use of non-stainless steel hooks throughout the South Atlantic and possession of a descender device.

For Highly Migratory Species (HMS) managed by NOAA Fisheries Highly Migratory Species Division, anglers aboard federally permitted vessels fishing recreationally for sharks are required to use non-offset, non-stainless steel circle hooks, except when fishing with flies or artificial lures. Anglers participating in Atlantic billfish tournaments must use only non-offset circle hooks when deploying natural bait or natural bait/artificial lure combinations. A billfish tournament is defined as any fishing tournament that awards points or prizes for billfishes, even if billfishes are not the main species targeted in the tournament. Billfish tournament anglers may deploy “J”-hooks only if they are fishing with artificial lures.

The Atlantic States Marine Fisheries Commission requires the use of non-offset, corrodible, non-stainless steel circle hooks when fishing for sharks recreationally, except when fishing with flies or artificial lures in state waters from Maine through the east coast of Florida. States must implement these management measures no later than July 1, 2020. The Atlantic States Marine

Fisheries Commission also requires the use of circle hooks when recreational fishing for striped bass with natural bait from Maine through North Carolina. In North Carolina, this measure only applies to striped bass fishing in ocean waters. States must implement these management measures no later than January 1, 2021.

Current circle hook regulation in North Carolina

Harvest of red drum greater than 27 inches in total length has been prohibited in North Carolina since 1998, however, recreational fishing for adult red drum for catch and release continues to be very popular. Given the popularity, release mortality of adult red drum in the recreational fishery has long been a management concern. Of particular concern is the tendency for a high incidence of deep hooking that occurs in the Pamlico Sound summer fishery where large adult red drum are aggregate prior to spawning. In this fishery, bait fishing on the bottom is a commonly employed method used from boats. This fishery creates somewhat of a unique scenario because the lack of strong currents often results in slack fishing lines and as a result can lead to a high incidence of deep hooking and elevated release mortality.

Each of the two prior FMPs for this species considered how to address this issue. The 2001 North Carolina Red Drum FMP considered various methods to reduce release mortality, but ultimately the plan opted to develop educational information on conservative angling practices for red drum, including the promotion of circle hooks and proper handling methods. Subsequent to the plan, educational information was provided by the Division and North Carolina Sea Grant including educational seminars to recreational fishing clubs, video productions, magazine and newspaper articles, as well as, distributing various types of educational pamphlets and other promotional giveaways. The plan also included research recommendations to characterize the adult red drum fishery and assess the mortality associated with the recreational releases of adult red drum.

In 2002, the Division and North Carolina Sea Grant conducted a survey of 456 anglers who target adult red drum in order to better characterize this fishery (unpublished data, NCDMF). Overall (all areas and modes of fishing), 56% of the respondents indicated that they always use circle hooks when fishing for adult red drum and another 27% occasionally used circle hooks. The results were similar for anglers in Pamlico Sound, with 52% of the respondents using circle hooks exclusively and 16% sometimes using circle for adult red drum.

Specific research was also conducted in the Pamlico Sound adult red drum fishery to estimate recreational release mortality, determine factors contributing to release mortality and determine the differences in deep hooking events between circle hooks and J-style hooks (Aguilar 2003, Beckwith and Rand 2004a, Beckwith and Rand 2004b). Studies by Aguilar (2003) and Beckwith and Rand (2004a) had overall mortality rates ranging from 3.8% to 6.7% based on adult red drum that were held for three days after being caught using either circle hooks or J-style hooks. Considering just fish that were deep hooked mortality rates were much higher (>15%) and all mortalities in the study showed evidence of internal bleeding from being deep hooked (Aguilar 2003, Beckwith and Rand 2004a). Aguilar (2003) found that circle hooks had a significantly lower incidence of deep hooking than J-style hooks when both were fished on standard bottom fishing rigs. Beckwith and Rand (2004b) advanced these findings and found that a large (Mustad 14/0 and 16/0 circle hook style: 39960D) or intermediate (Eagle Claw 8/0 circle hook (Style: L2004EL) sized circle hook combined with a short leader and a fixed weight resulted in the lowest incidence of deep hooking (4%) in the study. This was compared to greater than 50% deep hooking with a 7/0 J-style hook rigged with a standard leader and a slip weight (Beckwith and Rand 2004a).

Amendment 1 to the North Carolina Red Drum FMP reconsidered the issue of targeting adult red drum and the associated release mortality in light of this new research. Management options included hook requirements (size and type), seasonal closures and area closures. The primary focus was in protecting spawning aggregations of red drum in Pamlico Sound where catch rates were high and deep hooking and elevated mortality was known to be an issue. Impacts to other fisheries both in terms of species affected, seasons and areas played a major role in crafting the final rule that was adopted. Also, because the majority of the effort in the adult red drum fishery using bait occurred primarily at night, the final option limited the circle hook requirements to nighttime fishing to avoid conflicts with anglers using J-hooks to target tarpon. A further concern in rule adoption was the enforceability of a specific hook size given the lack of standardization in the tackle industry and the need to specifically define what constituted a circle hook. The benefit to the stock however was given paramount importance over these obstacles at the time the rule was passed. Efforts were made to educate the public on what constituted a legal rig both by giving rigs away at boating access points and by publishing the rig configuration on the Division website. The final rule was worded as follows:

15A NCAC 03J .0306 HOOK-AND-LINE

It is unlawful to use any hook larger than 4/0 from July 1 through September 30 in the internal coastal fishing waters of Pamlico Sound and its tributaries south of the Albemarle Sound Management Area as defined in 15A NCAC 03R .0201 and north of a line beginning at a point 34° 59.7942' N - 76° 14.6514' W on Camp Point; running easterly to a point 34° 58.7853' N - 76° 09.8922' W on Core Banks while using natural bait from 7:00 p.m. to 7:00 a.m. unless the terminal tackle consists of:

- (1) A circle hook defined as a hook with the point of the hook directed perpendicularly back toward the shank, and with the barb either compressed or removed; and
- (2) A fixed sinker not less than two ounces in weight, secured not more than six inches from the fixed weight to the circle hook.

History Note: Authority G.S. 113-182; 113-182.1; 143B-289.52; Eff. April 1, 2009.

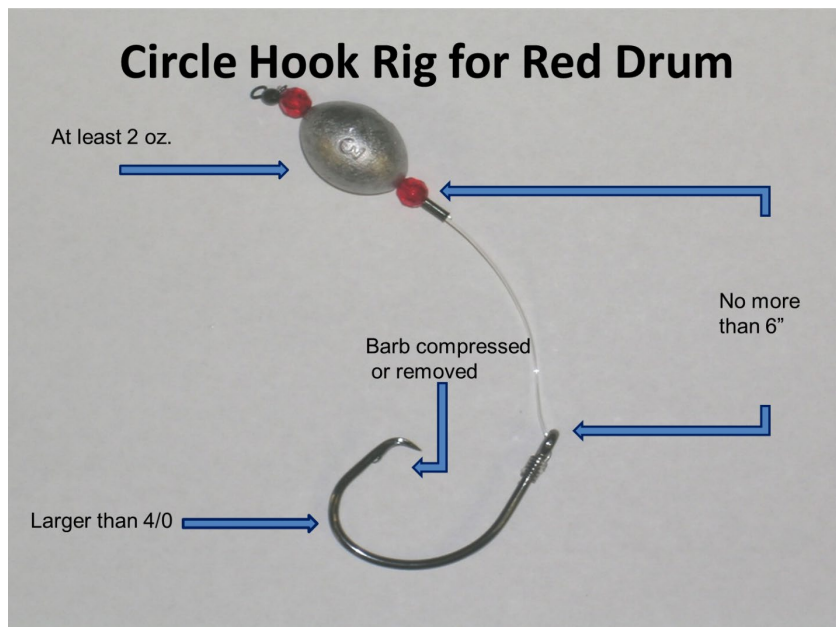


Figure 3. Current configuration of red drum natural bait rig described in Marine Fisheries Commission rule 15A NCAC 03J .0306.

IV. AUTHORITY

G.S. 113-182. Regulation of fishing and fisheries.

- (a) The Marine Fisheries Commission is authorized to authorize, license, regulate, prohibit, prescribe, or restrict all forms of marine and estuarine resources in coastal fishing waters with respect to:
 - (1) Time, place, character, or dimensions of any methods or equipment that may be employed in taking fish;
 - (2) Seasons for taking fish;
 - (3) Size limits on and maximum quantities of fish that may be taken, possessed, bailed to another, transported, bought, sold, or given away.
- (b) The Marine Fisheries Commission is authorized to authorize, regulate, prohibit, prescribe, or restrict and the Department is authorized to license:
 - (1) The opening and closing of coastal fishing waters, except as to inland game fish, whether entirely or only as to the taking of particular classes of fish, use of particular equipment, or as to other activities within the jurisdiction of the Department; and
 - (2) The possession, cultivation, transportation, importation, exportation, sale, purchase, acquisition, and disposition of all marine and estuarine resources and all related equipment, implements, vessels, and conveyances as necessary to implement the work of the Department in carrying out its duties.
 - (3) The possession, transportation, importation, exportation, sale, purchase, acquisition, and disposition of all fish taken in the Atlantic Ocean out to a distance of 200 miles from the State's mean low watermark, consistent with the Magnuson Fishery Conservation and Management Act, 16 U.S.C. § 1801, et seq., as amended. (1915, c. 84, s. 21; 1917, c. 290, s. 7; C.S., s. 1878; 1925, c. 168, s. 2; 1935, c. 35; 1945, c. 776; 1953, cc.774, 1251; 1961, c. 1189, s. 1; 1963, c. 1097, s. 1; 1965, c.957, s. 2; 1973, c. 1262, s. 28; 1995, c. 507, s. 26.5(c); 1997-400, s. 6.6.

V. DISCUSSION

Compliance with regulations requiring the use of circle hooks and bent barbs on treble hooks can only be achieved if the following factors are met; 1) enforceable rules for the use and modification of the gear including clear and quantifiable definitions of circle hooks and barbless treble hooks, 2) readily available gear that complies with aforementioned definition, 3) reasonable exclusions for fisheries and activities where catch rates may be disproportionately affected using the new required gear, 4) extensive public education on the proper use of new gear, and 5) clearly articulated benefits relative to current conservation and management strategies employed for our marine resources. Failing to consider or act on these factors will significantly curtail compliance with any regulations prescribing the use of circle hooks and bent barbed treble hooks and potentially undermine the conservation benefits of employing such practices.

To ensure effective and enforceable regulations, a definition of a circle hook including quantifiable metrics must be established. Numerous management agencies, including the NCDMF, already define what a circle hook is in rule with some variation. The circle hook requirements for sharks and striped bass are based on the Atlantic States Marine Fisheries Commission's circle hook definition (Table 1). The current Commission rule (*15A NCAC 03J.0306*) that defines a circle hook does not require the use of a non-offset hook but does require that the barb be pinched down. Research evaluating the effectiveness of circle hooks in reducing deep hooking suggests that the gear loses its intended effectiveness if the point is offset (Prince et al 2002). Additionally, rule *15A*

NCAC 03J.0306 requires the use of hooks larger than 4/0. As described previously, hook manufacturers do not standardize the sizes of their hook offerings. If hook size is to be considered, a definition including “the point turned perpendicularly back to the shank” and establishing discrete measurements for gap and offset should be included. In order for officers to testify in a court of law to the size of a circle hook, a gauge or measuring device will be needed similar to what is currently used for crabs, oysters, clams, and finfish. The current Commission rule defining a circle hook and prescribing its use is considered un-enforceable as written given the aforementioned inconsistencies in hook size. Officers can inspect the tackle relative to rig requirements listed in the rule but are unable to enforce hook size requirements. If the rule was modified to remove the size requirement, essentially making circle hooks a requirement regardless of size, an officer would have more discretion to enforce the regulation.

Circle hooks outperform J-hooks in reducing deep hooking of fish when using natural baits due to the manner in which natural bait is typically fished. These baits are often fished suspended or on the bottom with slack line which allows the fish to swallow the bait and hook without the tension or movement of the line or bait rig spooking or otherwise preventing the fish from consuming the bait. To aid in enforcement and ensure that anglers are using circle hooks when fishing with such bait, a clear definition of what does and does not constitute natural bait is needed. Natural bait is not currently defined in rule so a definition will need to be developed if required use of circle hooks is subject to natural bait. Other jurisdictions have defined natural and artificial bait for the purpose of requiring or excluding their use in certain fisheries or areas. The Wildlife Resources Commission defines bait in mountain trout waters as “any living or dead organism (plant or animal), or parts thereof, or prepared substances designed to attract fish by the sense of taste or smell” (15A NCAC 10C .0205). Anglers are prohibited from using natural bait in mountain trout waters which includes not only live or dead bait, but also prepared or synthetic baits and attractants. A definition this broad applied to coastal waters could impact access to certain fisheries by limiting certain bait and lure configurations or undermine any conservation benefits to circle hooks by creating unintentional “loop holes” to avoid their use. Additionally, it could go beyond the intent of the rule by prohibiting fishing practices that do not pose a conservation concern. Careful consideration is needed in crafting an appropriate definition for natural bait that allows for its use or prohibition as intended.

Catch rates are another factor to consider with the implementation of circle hook regulations. Depending on the species targeted and style of fishing, rates of hook-up and landings can differ greatly between J- hooks and circle hooks. In a Maryland striped bass study, anglers using J-hooks landed a fish 42% of the time they detected a strike. When using non-offset circle hooks, anglers landed a fish 27% of the time. J-hooks were 52% more efficient than non-offset circle hooks in landing a fish once a strike was detected (Lukacovic and Uphoff 2002). The reduction in catch especially in trolling fisheries may present a significant concern with compliance. Trolling for king mackerel with strip baits or dead ballyhoo requires the use of 7/0 to 9/0 J-hooks. Catch rates for king mackerel using circle hooks while trolling has been shown to be reduced significantly (Rudershausen et al. 2011). Additionally, live bait trolling using barbed and barbless treble hooks have not been evaluated for differences in catch rates. Sheepshead are typically targeted using natural baits and either small, short shanked J-hooks or small treble hooks. Their hard mouth and dentition often require anglers to forcibly set the hook to ensure proper hooks set. A circle hook in this situation would not set. Catch rates may not differ using barbless treble hooks but there has been no research to evaluate the effectiveness of different hook types or the incidence of deep hooking using traditional methods and gear for this species. Another notable species that some anglers target in North Carolina using natural bait are flounder. They can be harvested drifting cut bait, fishing live bait, and with jigs in combination with natural or synthetic baits. Flounder are

ambush predators and engulf baits and prey as they drift or swim by and do not typically swim off after consuming a bait. It is up to the angler to set the hook either actively or passively by drifting by. The effectiveness of circle hooks for flounder fishing will depend on the fishing method with circle hooks likely more effective when anchored or shore fishing than from a drifting boat. No studies have evaluated the efficacy of circle hooks on the capture and survival of flounder in North Carolina. A study conducted on summer flounder in New York and Virginia tested for difference in hook type and survival in the recreational fishery and observed no significant difference between circle hooks and J-hooks (Malchoff and Lucy 1998).

The effective implementation of new gear regulations and best fishing practices will require an extensive public outreach and education campaign to educate anglers on the correct use of the new gear. A Texas study that evaluated hook types as well as rig configurations, bait, and angler experience level found that the only significant predictor of post release mortality was angler skill level with higher mortality associated with beginner/novice fisherman (Stunz and McKee 2006). The NC DMF has long prompted the use of ethical angling practices including the use of circle hooks. NC DMF publishes and distributes a pamphlet titled *Ethical Angling: A Guide to Responsible Fishing*, which details the use of circle hooks, catch and release, and proper handling of fish. NC DMF also distributes bumper stickers depicting a red drum and circle hook encouraging anglers to fish responsibly. Partnerships with the SAFMC, the FishSmart program supported by the Angler Action Foundation, and others have provided numerous other informational brochures and tackle giveaways to promote the use of circle hooks and other gears, such as fish descending devices, and information on best handling practices. Division staff have distributed over 500 red drum short leader rigs (with circle hook) obtained through its partnership with FishSmart. In addition to efforts by FishSmart, the NMFS Recreational Fisheries Policy Program provide 7,000 circle hooks of various sizes for distribution by the NC DMF. Staff assembled these hooks into “inshore” and “offshore” packages along with informational pamphlets for distribution. Over half of these were distributed during 2019. While it is challenging to quantify the impacts of information campaigns on angler use of circle hooks, anecdotal reports by Marine Patrol indicate that most anglers are using circle hooks while bait fishing in Pamlico Sound for red drum during the day, while regulations only require use at night.

The promotion of barbless treble hooks as a conservation measure has largely been replaced by the use of single inline hooks. The eye of this style of hook is turned inline and is meant to replace treble hooks on topwater and suspending hard baits. Their use has been promoted for a variety of reasons – less damage to fish, ease of unhooking, fish hooked more securely, less likely to collect grass or debris, and angler safety. This trend is gaining ground in the industry. Many manufacturers have started selling lures already rigged with single hooks. A local tackle shop in Eastern North Carolina advertised a promotion in June 2019 where anglers could bring 5 lures and have the trebles swapped out for inline single hooks. This trend is being driven by the tackle industry, retailers, and conservation-minded anglers. A coordinated public information campaign by NCDMF and tackle shops may shift the needle toward the use of single inline hooks in specific fisheries such as artificial lures for speckled trout.

Several North Carolina General Statutes (NCGS) address the authority for and requirements of implementing MFC rules. NCGS 113-134 authorizes the MFC to adopt rules to implement requirements of NCGS 113, Subchapter IV, Conservation of Marine and Estuarine and Wildlife Resources. The N.C. Fisheries Reform Act (FRA) of 1997 restructured the way North Carolina managed its coastal fisheries and enacted general statutes for the MFC, Coastal Habitat Protection Plan, Fishery Management Plans (FMPs), Marine Fisheries Law Enforcement, and Commercial Fishing Licenses. NCGS 143B-289.52 requires the MFC to adopt rules to be

followed in the management, protection, preservation, and enhancement of the marine and estuarine resources within its jurisdiction, including commercial and sports fisheries resources. NCGS 113-182.1 requires the NCDMF to develop FMPs for adoption by the MFC with the goal of the plans to ensure the long-term viability of North Carolina's commercially and recreationally significant species or fisheries. The N.C. Administrative Procedure Act (APA; NCGS 150B) applies to an agency's exercise of its authority to adopt a rule and states a rule is not valid unless it is adopted in substantial compliance with the requirements of the APA.

Currently, there are six species on the state FMP schedule that would be affected by changes in hook requirements. Estuarine Striped Bass, Kingfish, Red Drum, Sheepshead, Southern Flounder and Spotted Seatrout all support significant recreational fisheries and any changes to hook requirements could have potential impacts on the fisheries and associated anglers. Variations in size, location, and fishing techniques as they apply to the above species would require specific considerations when selecting appropriate hook size, shape, materials, etc. These variations make assigning one circle hook requirement across the board for various species problematic. What might work for one species may not be suitable for another. Additionally, given that paucity of research for state managed species and the current and potential future un-quantified metrics of use with circle hooks and barbless treble hooks the NC DMF may be unable to incorporate the positive effects of these management measures into stock assessments. Rather, any conservation gains realized by the required use of these gears will have to indirectly inferred from multiple assessments.

The FMP development process is a slow deliberate process that requires significant public input and legislative review. Considering the significant variability in effectiveness of circle hook requirements, developing this issue within each state FMP may be a more effective approach. This would allow the Division to evaluate existing literature, data, and current management to develop circle hook requirements that are specific to that species and associated fisheries and potentially evaluate their effectiveness directly. Development of FMP Amendments for Spotted Seatrout, Striped Bass, and Southern Flounder are currently underway, and consideration of circle hook and barbless treble hook requirements could be addressed in those upcoming amendments. Addressing hook requirements on a species-specific basis is also consistent with upcoming requirements for sharks and striped bass by the Atlantic States Marine Fisheries Commission and for snapper-grouper complex species by the South Atlantic Fishery Management Council.

VI. SUMMARY OF FINDINGS

- In general, science supports the use of circle hooks as a means to reduce hook trauma and discard mortality
 - Aside from extensive research on red drum, few studies have been conducted in North Carolina that evaluate the effectiveness of circle hooks
 - Studies suggests that off-set circle hooks negate the positive benefits of circle hooks
- Very little research exists on the effects of hook trauma by treble hooks
- No industry standard exists for circle hook style and size
 - If circle hook use is required, a clear definition is needed
- Other management jurisdictions that require the use of circle hooks focus on single species/fisheries or complexes to implement hook requirements
 - Reduces unintended consequences, i.e. live bait trolling, exclusion of species with unique mouth physiologies, etc.
 - Increases the likelihood of compliance and enforcement

- Consider positive and negative social and economic effects
 - Potential decrease in angler satisfaction through decreased catch rates for some species
 - Positive impact to catch rates if population responds to reduced discard mortality
 - Economic impact to anglers and tackle shops

VII. LITERATURE CITED

- Aguilar, R. 2003. Short-term post-hooking mortality and movement of adult red drum in the Neuse River, North Carolina. Master's Thesis. North Carolina State University, Raleigh, NC.
- Beckwith, Jr., G. H. and P. S. Rand. 2004a. Investigating post-hooking recovery and mortality of red drum in the Neuse River. North Carolina Sea Grant Fishery Research Grant Program, Final Report 02-FEG-03.
- Beckwith, Jr., G. H. and P. S. Rand. 2004b. Large circle hooks and short leaders with fixed weights reduce incidence of deep hooking in angled adult red drum. *Fisheries Research*. 71 (2005) 115-120.
- Cooke S. J., Suski C. D., Barthe B. L., Ostrand K. G., Tufts B. L., Philipp D. P., 2003. Injury and Mortality Induced by Four Hook Types on Bluegill and Pumpkinseed, *North American Journal of Fisheries Management*, 23:3, 883-893.
- Cooke S. J., Suski C. D., 2004. Are circle hooks an effective tool for conserving marine and freshwater recreational catch-and-release fisheries? *Aquatic Conservation: Marine and Freshwater Ecosystems*.14:299–326.
- Graves, J. E., & Horodysky, A. Z. 2008. Does hook choice matter? Effects of three circle hook models on postrelease survival of white marlin. *North American Journal of Fisheries Management*, 28(2), 471-480.
- Grover A. M., Mohr M. S., Palmer-Zwahlen M. L. 2002. Hook-and-release mortality of Chinook salmon from drift mooching with circle hooks: management implications for California's ocean sport fishery. In: Lucy J. A., Studholme, A. L., editors. *Catch and release in marine recreational fisheries*. Bethesda, Maryland. American Fisheries Society Symposium 30. p. 80–87.
- Johannes R. E. 1981. *Words of the Lagoon: Fishing and Marine Lore in the Palau District of Micronesia*. University of California Press, Los Angeles, CA.
- Kerstetter, D. W. and Graves, J. E., 2006. Effects of circle versus J-style hooks on target and non-target species in a pelagic longline fishery. *Fisheries Research*, 80(2-3), pp.239-250.
- Lukacovic R., Uphoff J. H. 2002. Hook location, fish size, and season as factors influencing catch-and-release mortality of striped bass caught with bait in Chesapeake Bay. In: Lucy J. A., Studholme, A. L., editors. *Catch and release in marine recreational fisheries*. Bethesda, Maryland. American Fisheries Society Symposium 30. p. 97–100.

- Malchoff, M. H., & Lucy, J. A. 1998. Short-Term Hooking Mortality of Summer Flounder In New York and Virginia. Marine Resource Report No. 98-7. Virginia Institute of Marine Science, College of William and Mary.
- Matlock, G. C., McEachron, L. W., Dailey, J. A., Unger, P. A. and Chai, P. 1993. Management Briefs: Short-Term Hooking Mortalities of Red Drums and Spotted Seatrout Caught on Single-Barb and Treble Hooks. *North American Journal of Fisheries Management*, 13(1), pp.186-189.
- Prince, E. D., Ortiz, M. and Venizelos, A. 2002. A Comparison of Circle Hook and “J” Hook Performance in Recreational Catch-and-Release. In: Lucy J. A., Studholme, A. L., editors. *Catch and release in marine recreational fisheries*. Bethesda, Maryland. American Fisheries Society Symposium 30 p. 66-79.
- Rudershausen, P. J., Buckel, J. A., Bolton, G. E., Gregory, R. W., Averett, T. W., and Conn, P. B. 2011. A comparison between circle hook and J hook performance in the dolphinfish, yellowfin tuna, and wahoo troll fishery off the coast of North Carolina. *Fishery Bulletin*, 110(2), pp. 156-175.
- Serafy J. E., Cooke S. J., Diaz G. A., Graves J., Hall M., Shivji M., and Swimmer Y. 2012. Circle hooks in commercial, recreational, and artisanal fisheries: research status and needs for improved conservation and management. *Bulletin of Marine Science*. 88:371-391.
- Skomal G. B., Chase B. C., Prince E. D. 2002. A comparison of circle hook and straight hook performance in recreational fisheries for juvenile Atlantic bluefin tuna. In: Lucy J. A., Studholme, A. L., editors. *Catch and release in marine recreational fisheries*. Bethesda, Maryland. American Fisheries Society Symposium 30. p. 57–65.
- Stunz, G.W. and McKee, D.A., 2006. Catch-and-release mortality of spotted seatrout in Texas. *North American Journal of Fisheries Management*, 26(4), pp.843-848.



Atlantic States Marine Fisheries Commission

2020 Winter Meeting Summary

Sustainable and Cooperative Management of Atlantic Coastal Fisheries

2020 Winter Meeting
Arlington, VA
February 4 – 6, 2020

Toni Kerns, ISFMP, or
Tina Berger, Communications
For more information, please contact
the identified individual at
703.842.0740

Meeting Summaries, Press Releases and Motions

TABLE OF CONTENTS:

ATLANTIC HERRING MANAGEMENT BOARD (FEBRUARY 4, 2020)	3
<i>Press Release</i>	3
<i>Motions</i>	3
ATLANTIC STRIPED BASS MANAGEMENT BOARD (FEBRUARY 4, 2020)	4
<i>Meeting Summary</i>	4
<i>Motions</i>	5
COASTAL SHARKS MANAGEMENT BOARD (FEBRUARY 4, 2020)	7
<i>Meeting Summary</i>	7
<i>Motions</i>	8
BLUEFISH MANAGEMENT BOARD (FEBRUARY 4, 2020)	8
<i>Meeting Summary</i>	8
<i>Motions</i>	9
ATLANTIC MENHADEN MANAGEMENT BOARD (FEBRUARY 5, 2020)	9
<i>Press Release</i>	9
<i>Motions</i>	11
SOUTH ATLANTIC STATE/FEDERAL FISHERIES MANAGEMENT BOARD (FEBRUARY 5, 2020)	12
<i>Press Releases</i>	12
<i>Meeting Summary</i>	15
<i>Motions</i>	16
EXECUTIVE COMMITTEE (FEBRUARY 6, 2020)	17
<i>Meeting Summary</i>	17
<i>Motions</i>	18

INTERSTATE FISHERIES MANAGEMENT PROGRAM POLICY BOARD (FEBRUARY 6, 2020) 18
 Meeting Summary 18
 Motions 19
BUSINESS SESSION (FEBRUARY 6, 2020)..... 19
 Meeting Summary 19
 Motions 19

ATLANTIC HERRING MANAGEMENT BOARD (FEBRUARY 4, 2020)

Press Release

ASMFC Atlantic Herring Board Approves Draft Addendum III for Public Comment

Arlington, VA – The Commission’s Atlantic Herring Management Board approved Draft Addendum III to Amendment 3 of the Interstate Fishery Management Plan for Atlantic Herring for public comment. The Draft Addendum proposes options to better manage the Area 1A (inshore Gulf of Maine) sub-annual catch limit (ACL) under low quota scenarios. This action responds to the challenges encountered in managing the reduced sub-ACL based on the 2018 benchmark stock assessment, which highlighted declining trends in recruitment and spawning stock biomass.

Currently, the Board can allocate the sub-ACL throughout the fishing season using bi-monthly, trimester, or seasonal quota periods to meet the needs of the fishery. For the 2019 fishing season, the Board implemented a bimonthly quota period approach to maximize use of the reduced sub-ACL when demand for bait is high. Due to the low quota, the 2019 fishery experienced frequent closures to avoid an overage. The 2020 sub-ACL (3,344 mt) is lower than in 2019, creating further challenges in distributing the quota throughout the fishing season. The Draft Addendum considers additional tools to provide the Board more flexibility in specifying the allocation under low quota scenarios and meet the needs of the herring fishery moving forward.

Additionally, the Draft Addendum considers expanding landing provisions across different permit categories within the days out program. The Board utilizes days out of the fishery and weekly landing limits to adjust the rate of Area 1A catch. The Draft Addendum includes options that apply weekly landing limits to all vessel categories landing herring in Area 1A throughout the entire fishing season.

Interested groups are encouraged to provide input on the Draft Addendum either by attending state public hearings or providing written comment. The Draft Addendum will be available on the Commission website (www.asmfc.org) under Public Input by February 12, 2020. Public comment will be accepted until 5:00 PM on March 25, 2020 and should be forward to Kirby Rootes-Murdy, Senior FMP Coordinator, 1050 N. Highland St., Suite 200 A-N, Arlington, Virginia 22201; 703.842.0741 (fax) or at comments@asmfc.org (Subject line: Atlantic Herring Draft Addendum III). It is anticipated some states will conduct public hearings on the Draft Addendum; the details of which will be released via a press release once they are finalized.

For more information, please contact Kirby Rootes-Murdy at krootes-murdy@asmfc.org or 703.842.0740.

###

PR20-03

Motions

Move to approve Atlantic Herring Draft Addendum III for public comment as amended today.

Motion made by Mr. White and seconded by Mr. Train. Motion passes (8 in favor, 1 opposed).

Move to approve the following Atlantic herring specifications for 2020 as recommended by the New England Fishery Management Council contingent on the final rule being published by NOAA Fisheries:

Annual Catch Limit (ACL) = 11,571 mt

Domestic Annual Harvest = 11,571 mt

Border Transfer = 100 mt

Area 1A Sub-ACL = 3,344 mt

Area 1B Sub-ACL = 498 mt

Area 2 Sub-ACL = 3,217 mt

Area 3 Sub-ACL = 4,513 mt

Fixed Gear Set-Aside= 30 mt

Motion made by Ms. Ware and seconded by Mr. Kane. Motion passes by unanimous consensus. (Roll Call: In Favor – ME, NH, MA, RI, CT, NY, NJ, NEFMC, NMFS.)

Motion to elect Cheri Patterson as Vice Chair of the Atlantic Herring Management Board.

Motion made by Mr. White and seconded by Mr. Kane. Motion passes by unanimous consensus.

ATLANTIC STRIPED BASS MANAGEMENT BOARD (FEBRUARY 4, 2020)

Meeting Summary

The Atlantic Striped Bass Management Board met to review and consider implementation plans and conservation equivalency (CE) proposals for Addendum VI. The Addendum aims to address overfishing and reduce fishing mortality (F) to the F target by 2020. Any states and jurisdictions submitting for CE were required to demonstrate that the proposed measures achieve at least an 18% reduction in total removals at the state-level (i.e., recreational and commercial fisheries combined). The Striped Bass Technical Committee (TC) reviewed all proposed measures based on the technical merit of the analyses used to calculate the expected reductions in total removals and to ensure the proposals met state-specific target reductions. The TC also developed a list of uncertainties and caveats that should be considered.

A number of states submitted multiple CE proposals which resulted in a wide range of measures being considered, and raised questions about consistency, equitability, and accountability if CE measures didn't meet their respective targets. Furthermore, the Board quickly recognized that the effects of combined CE measures had the potential to fall short of the 18% reduction needed to achieve F target in 2020. These realizations led to focused discussion on a few proposals that relied heavily on assumptions regarding angler behavior, and proposals that would achieve a lower percent reduction at the state-level under CE measures than under the Addendum VI measure.

After lengthy deliberations, and while acknowledging the need for CE to address unique state and regional differences, the Board pared down the number of measures being considered and approved implementation plans and CE proposals on a state-by-state basis (see list of motions below).

During deliberation, the Board discussed the need to revisit the CE provision in the next management document, which will be considered at the Spring Meeting, and the need for unique accountability measures for this predominantly recreational fishery. The Board will also consider accountability measures with Addendum VI at the Spring Meeting.

Lastly, the Board required states to submit implementation plans for recreational circle hook provisions by August 15th. The Plan Review Team will review circle hook provisions for Board consideration at Annual Meeting.

For more information, please contact Max Appelman, Fishery Management Plan Coordinator, at mappelman@asmfc.org or 703.842.0740.

Motions

Main Motion

Move that state implementation of the Addendum VI conservation equivalency proposals approved today be contingent upon a Technical Committee analysis documenting that the combined effect of the states' selected measures is at least a projected 18% reduction from 2017 total removals. Failure to achieve a projected 18% reduction shall result in mandatory implementation of the Addendum VI management measures.

States will advise ASMFC of their selected conservation equivalency measures by March 6. The Board will be advised of the results of the Technical Committee's analysis by March 13. The implementation deadline for fishery regulations remains April 1.

Motion made by Mr. McKiernan and seconded by Mr. White.

Motion to Substitute

Move to substitute to approve the conservation equivalency plans and implementation plans as approved by the Technical Committee.

Motion made by Mr. Clark and seconded by Mr. Luisi. Motion fails (4 in favor, 12 opposed). (Roll Call: In favor – NJ, DE, MD, PRFC; Opposed – ME, NH, MA, RI, CT, NY, PA, DC, VA, NC, NMFS, USFWS)

Main Motion

Move that state implementation of the Addendum VI conservation equivalency proposals approved today be contingent upon a Technical Committee analysis documenting that the combined effect of the states' selected measures is at least a projected 18% reduction from 2017 total removals. Failure to achieve a projected 18% reduction shall result in mandatory implementation of the Addendum VI management measures.

States will advise ASMFC of their selected conservation equivalency measures by March 6. The Board will be advised of the results of the Technical Committee's analysis by March 13. The implementation deadline for fishery regulations remains April 1.

Motion to Table

Move to table the motion.

Motion made by Mr. White and seconded by Mr. Keliher. Motion carries without objection.

Revisit Tabled Motion

Move that state implementation of the Addendum VI conservation equivalency proposals approved today be contingent upon a Technical Committee analysis documenting that the combined effect of the states' selected measures is at least a projected 18% reduction from 2017 total removals. Failure to achieve a projected 18% reduction shall result in mandatory implementation of the Addendum VI management measures.

States will advise ASMFC of their selected conservation equivalency measures by March 6. The Board will be advised of the results of the Technical Committee's analysis by March 13. The implementation deadline for fishery regulations remains April 1.

Motion to Substitute

Motion to substitute to approve the Addendum VI recreational measures for the coast and the Chesapeake bay/producer areas (Hudson and Delaware estuaries) conservation equivalency measures as perfected today.

Motion made by Mr. Miller and second by Mr. Keliher. Motion split.

Motion to Split

Move to split the question to take up the coastal measures separately from the Chesapeake Bay and producer area measures.

Motion made by Mr. Luisi and seconded by Mr. Geer. Motion adopted by unanimous consensus.

Motion to postpone indefinitely all previous motions

Motion made by Mr. Abbott and seconded by Sen. Miramant. Motion approved by Board consent.

At this point in the meeting, the Board proceeded to consider implementation plans and conservation equivalency proposals on a state-by-state basis:

The Board approved state implementation plans and conservation equivalency proposals for ME, NH, MA, CT, PA, DE, DC, PRFC, VA, and NC by unanimous consent.

Motion to approve the Rhode Island conservation equivalency proposals.

Motion made by Dr. McNamee and seconded by Mr. Nowalsky. Motion carries (9 in favor, 4 opposed, 2 abstentions).

Motion to approve New York's NY-1, NYD-1, NYH-1 options under recreational measures, and NY-D2 under commercial measures.

Motion made by Dr. Davis and seconded by Mr. Abbott. Motion carries (11 in favor, 2 opposed, 2 abstentions).

Move to approve New Jersey's R3 and R6 options under recreational measures and the suite of commercial options.

Motion made by Mr. Nowalsky and seconded by Mr. Clark. Motion fails (3 in favor, 8 opposed, 3 abstentions, 1 null).

Move to approve New Jersey's option R3 and the suite of commercial options.

Motion made by Mr. Keliher and seconded by Mr. Abbott. Motion carries (10 in favor, 3 opposed, 2 abstentions).

Move to reconsider the RI vote.

Motion made by Sen. Miramant and seconded by Mr. Abbott. Motion fails for lack of two-thirds majority (6 in favor, 7 opposed, 2 abstentions). (Roll Call: in Favor – ME, NH, MA, CT, NY, PA; Opposed – RI, NJ, DE, MD, PRFC, VA, NC; Abstentions – NMFS, USFWS.)

Move to approve Maryland's MD-1, MD-2d, MD-3a, MD-4a options for recreational and commercial fisheries in the ocean and Chesapeake Bay.

Motion made by Mr. Luisi and seconded by Mr. Clark. Motion carries (10 in favor, 3 opposed, 2 abstentions).

Move to approve a slot limit for New Jersey to develop one conservation equivalency option that would achieve at least an 18% reduction with a maximum slot size limit of no more than 40", pending Technical Committee approval.

Motion made by Mr. Nowalsky and seconded by Mr. Hasbrouck. Motion carries (9 in favor, 4 opposed, 2 abstentions).

Move to approve as part of New York State's conservation equivalency option to have an opt-in slot limit for the for-hire fishery 30"-40", monitored by license, pending Technical Committee approval.

Motion made by Mr. Gilmore and seconded by Mr. Luisi. Motion fails (5 in favor, 5 opposed, 4 abstentions, 1 null).

Motion to approve the RI-CT-NY regional proposal Option B.

Motion made by Dr. McNamee and seconded by Mr. Abbott. Motion fails (5 in favor, 6 opposed, 4 abstentions).

Move that states submit implementation plans for circle hook requirements by August 15, 2020 and Board approval at 2020 Annual Meeting.

Motion made by Dr. McNamee and seconded by Mr. Kane. Motion carries.

Move to task the Plan Review Team to review state reductions in the Fishery Management Plan Review of the 2020 fishing year. If a state is below their predicted target reduction, the Board may direct a state to modify measures for the next fishing year to achieve the target reduction.

Motion made by Mr. Keliher and seconded by Mr. Hasbrouck. Postponed to Spring Meeting.

Motion to postpone to the Spring Meeting.

Motion made by Mr. Luisi and seconded by Mr. Gary. Motion carries (10 in favor, 3 opposed, 2 abstentions).

COASTAL SHARKS MANAGEMENT BOARD (FEBRUARY 4, 2020)

Meeting Summary

The Coastal Sharks Management Board met to receive a presentation on the Convention on the International Trade in Endangered Species (CITES) Appendix II listing for Atlantic shortfin mako. CITES is a global treaty that aims to ensure international trade of plants and animals do not threaten their survival in the wild. Species protected under CITES are listed in one of three appendices. In 2019 shortfin mako was listed under CITES Appendix II, which includes species that, although not currently threatened with extinction, may become so without trade controls. Effective Nov 26, 2019, a CITES export permit is required to export shortfin mako out of the U.S. as part of international trade; a CITES import permit is not required. No CITES permits are needed for domestic trade. CITES export permits can be obtained by application from USFWS, are valid for 6 months, and are renewable. The new permit requirements will be in place unless shortfin mako is removed from Appendix II. The next opportunity to adjust which species are listed under Appendix II will be at the CITES Conference of the Parties in 2022.

The Board also received an update on 2019 the International Commission for the Conservation of Atlantic Tunas (ICCAT) Meeting specific to shortfin mako. The ICCAT Standing Committee on Research and Statistics

(SCRS) provided updated projections to include two generations (2070) as opposed to the generation (2040) in the original 2018 benchmark assessment. This information was considered by the member countries and based on the results, there was agreement to extend the current management measures for an additional year while a comprehensive rebuilding program is developed. New measures could be considered and made at the 2020 ICCAT Meeting.

For more information, please contact Kirby Rootes-Murdy, Senior Fishery Management Plan Coordinator, at krootes-murdy@asmfc.org or 703.842.0740.

Motions

No motions made.

BLUEFISH MANAGEMENT BOARD (FEBRUARY 4, 2020)

Meeting Summary

The Bluefish Management Board met to consider approval of conservation equivalency (CE) proposals submitted by New Jersey and Georgia proposing alternative measures for the 2020 recreational bluefish fishery. The Commission’s CE Policy allows states to submit proposals for alternative measures in state waters that achieve the same reduction in recreational landings that would have been achieved under the coastwide regulations approved by the Board in December 2019. The coastwide regulations include a 5-fish bag limit for the for-hire sector and a 3-fish bag limit for shore-based anglers and private fishermen.

Staff presented Technical Committee and Law Enforcement Committee recommendations to the Board on the technical merit and enforcement considerations of state proposals. The Board approved Georgia’s proposal, which includes a bag limit of 15 fish, a minimum size of 12 inches, and a seasonal closure which begins March 1 and ends on April 30, 2020 (Table 1). The Board approved New Jersey’s proposed options 1, 2, and a modified 3rd option presented in Table 1 below. Concerns regarding bluefish’s overfished status precluded the Board from accepting all options included in New Jersey’s proposal. Following the Board’s decision, New Jersey’s Marine Fisheries Council will select one of the three board approved options for implementation no later than April 1, 2020.

The Board also elected Joseph Cimino, New Jersey’s Administrative Commissioner, as the Bluefish Board Vice-Chair.

2020 Recreational Bluefish Fishery Regulations for Georgia and New Jersey

Option	Size Limit	Bag Limit	Mode	Season
Georgia				
	12” min	15	All modes	Closure March 1 – April 30
New Jersey				
1	-	3	Private/shore	Open All Season
	-	5	For-hire	
2	-	3	All modes	Open All Season
3	-	6	All modes	Closure September 1 – October 31

For more information, please contact Dustin Colson Leaning, Fishery Management Plan Coordinator, at dleaning@asmfc.org or 703.842.0740.

Motions

Main Motion

Move to prohibit the use of conservation equivalency for recreational bluefish management for 2020 with the exception of states that are accountable for less than 1% of the total coastwide harvest.

Motion made by Ms. Meserve and seconded by Ms. Patterson. Motion substituted.

Motion to Substitute

Move to substitute to allow conservation equivalency for states that are accountable for less than 1% of the total coastwide harvest and to approve New Jersey's options 1, 2, and a modified 3 with a 6 fish bag limit.

Motion made by Mr. Nowalsky and seconded by Mr. Gary. Motion passes (11 in favor, 5 opposed).

Main Motion as Substituted

Move to allow conservation equivalency for states that are accountable for less than 1% of the total coastwide harvest and to approve New Jersey's options 1, 2, and a modified 3 with a 6 fish bag limit.

Motion passes by unanimous consent. (Roll call: In favor – ME, NH, MA, RI, CT, NY, NJ, DE, MD, PRFC, VA, NC, SC, GA, FL, NMFS, USFWS)

Move to elect Joe Cimino as Vice Chair of the Bluefish Board

Motion made by Mr. Allen and seconded by Mr. Luisi. Motion passes by unanimous consent.

ATLANTIC MENHADEN MANAGEMENT BOARD (FEBRUARY 5, 2020)

Press Release

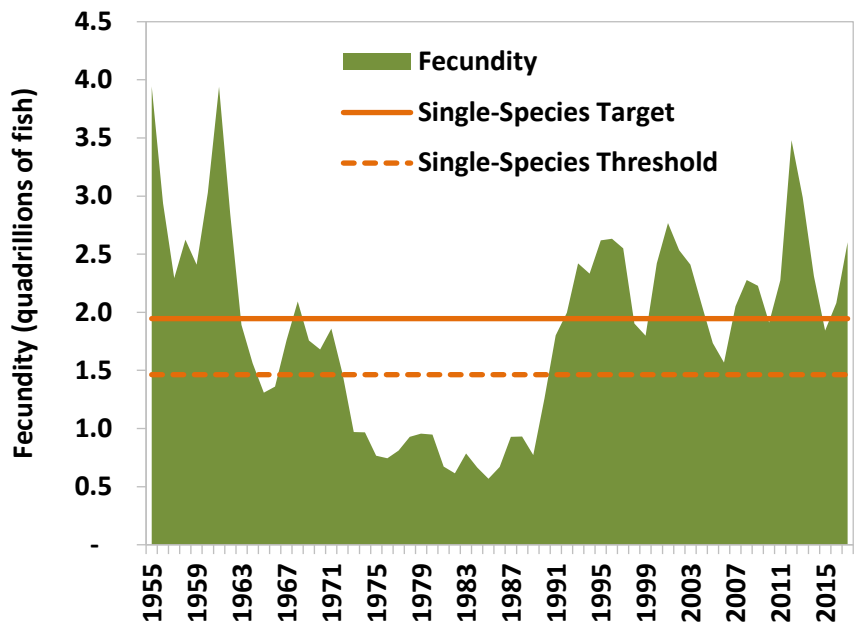
ASMFC Atlantic Menhaden Board Prepares to Move Forward with Menhaden Ecological Reference Points

Arlington, VA – The Commission's Atlantic Menhaden Management Board accepted the results of the Single-Species and Ecological Reference Points (ERPs) Assessments and Peer Review Reports for management use. The single-species assessment indicates the stock is not overfished nor experiencing overfishing relative to the single-species reference points established in Amendment 3. However, the ERP assessment indicates that the fishing mortality reference points for menhaden should be lower to account for menhaden's role as a forage fish. In order to consider moving forward with the use of ERPs for management, the Board tasked the ERP Workgroup with producing several scenarios to explore how different fishing mortality assumptions for the other predator and prey species in the ERP model (i.e., bluefish, weakfish, spiny dogfish, and Atlantic herring) might affect the menhaden ERP fishing mortality target and threshold. The Board will review these analyses and take up the issue of formally adopting ERPs in May at the Commission's Spring Meeting.

"On behalf of the Menhaden Board, I commend the ERP Workgroup and the dozens of state, federal, academic, and ASMFC scientists for their countless hours of dedication to this formidable task," stated Board Chair Nichola Meserve. "The Board has long recognized the importance of Atlantic menhaden as a

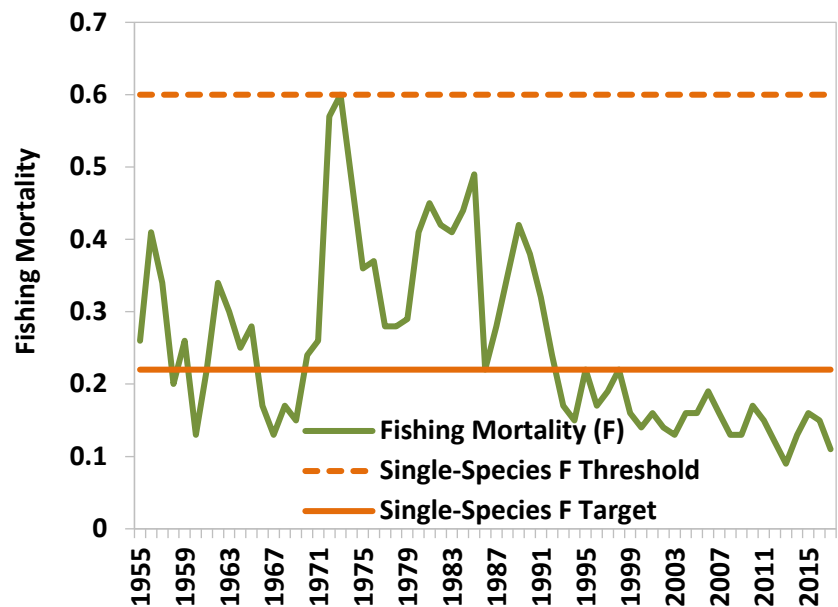
forage fish for a variety of predators as reflected in its setting of conservative harvest limits for menhaden and its emphasis on the development of ERPs as one of its highest priorities for managing the species. The ERP assessment is an impressive body of work and a huge step towards fully realized ecosystem-based fishery management. Although there is still much more work to be done, the ERP assessment provides managers with a critical tool in setting harvest targets for menhaden in an ecosystem-context.”

Atlantic Menhaden Fecundity



Under the traditional single-species reference points, Atlantic menhaden are neither overfished nor experiencing overfishing. Population fecundity, a measure of reproductive capacity (i.e., number of mature eggs in the population), has been above the single-species threshold since 1991 and above the single-species target in 20 of the 27 years since then, including 2017. Fishing mortality (F) has remained below the single-species overfishing threshold (0.6) since the mid-1970s, and below the single-species overfishing target (0.22) since the mid-1990s. Fishing mortality was estimated to be 0.11 in 2017. Although the ERP assessment

Atlantic Menhaden Fishing Mortality (ages 2-4)



indicates that the F reference points should be lower than the single-species reference points, it also showed that the conservative total allowable catch set for the 2018 to 2020 fishing seasons is consistent with the ERP F target in the example management scenario presented to the Board.

The ERP assessment, which was endorsed by an independent panel of fisheries scientists in November, uses the Northwest Atlantic Coastal Shelf Model of Intermediate Complexity for Ecosystems (NWACS-MICE) to develop Atlantic menhaden ERPs. The model was chosen from a suite of potential options because it was the only model that could explore both the impacts of predators on menhaden biomass and the effects of menhaden harvest on predator populations, and be updated in a timeframe that is informative for management. NWACS-MICE is an intermediate complexity ecosystem model that focuses

on four key predator species (striped bass, bluefish, weakfish, and spiny dogfish) and three key prey species (Atlantic menhaden, Atlantic herring, and bay anchovy). These species were chosen because diet data indicate they are top predators of Atlantic menhaden or are key alternate prey species for those predators, and datasets were available to describe their population dynamics.

The ERP assessment recommends a combination of the single-species model (Beaufort Assessment Model) and the NWACS-MICE model as a tool to evaluate trade-offs between menhaden harvest and predator biomass in a quantitative and transparent way. An important conclusion from the ERP assessment is that the final ERP definitions and values, including the appropriate harvest level for menhaden, depend on the management objectives for the ecosystem (i.e., management objectives for both Atlantic menhaden and its predators). The Board will continue to discuss management objectives and use of ERPs at the Commission's Spring Meeting in May.

Copies of the Assessment and Peer Review Reports can be found on the Commission's website on the Atlantic menhaden webpage, <http://www.asmfc.org/species/atlantic-menhaden>, under stock status. A more detailed overview of the stock assessments is available at http://www.asmfc.org/uploads/file/5e3c4663AtlanticMenhadenAssessmentsOverview_Feb2020.pdf. The overview aims to aid media and interested stakeholders in better understanding the assessment results. For more information, please contact Max Appelman, Fishery Management Plan Coordinator, at mappelman@asmfc.org or 703.842.0740.

###

PR20-04

Motions

Move to accept the Atlantic menhaden single species, ecological reference points, and peer review reports for management use.

Motion made by Mr. Woodward and seconded by Dr. Rhodes. Motion approved by unanimous consent.

Main Motion

Move to adopt:

- 1. An Atlantic Menhaden ecological reference point F target equal to the maximum F on Atlantic menhaden that maintains Atlantic striped bass at its biomass target when striped bass is fished at its F target and all other ERP species as defined in the NWACS-MICE model are fished at their status quo F rates.**
- 2. An Atlantic Menhaden ecological reference point F threshold equal to the maximum F on Atlantic menhaden that maintains Atlantic striped bass at its biomass threshold when striped bass is fished at its F target and other ERP species as defined in the NWACS-MICE model are fished at their status quo F rates.**

Motion made by Dr. Colden and seconded by Ms. Patterson. Motion postponed.

Motion to Postpone

Move to postpone until after completion of the following task: task the Ecological Reference Points Workgroup with the following analysis to better understand the parameters and outputs of the example ERP. The Work Group is asked to present this analysis at the May ASMFC meeting.

- 1. Using the existing example ERP framework, modify the assumptions on the other species such that they are fished at their F-target as opposed to F2017. Reproduce figures 144-148.**
- 2. Using the existing example ERP framework, modify the assumptions on the other species such that they are fished at their F-threshold, as opposed to F2017. Reproduce figures 144-148.**

- Using the existing example ERP framework, modify the assumptions on the other species such that bluefish and herring are fished at their F-target while spiny dogfish and weakfish are fished at their F-2017. Reproduce figures 144-148.

Motion made by Ms. Ware and seconded by Mr. Clark. Motion carries unanimously

SOUTH ATLANTIC STATE/FEDERAL FISHERIES MANAGEMENT BOARD (FEBRUARY 5, 2020)

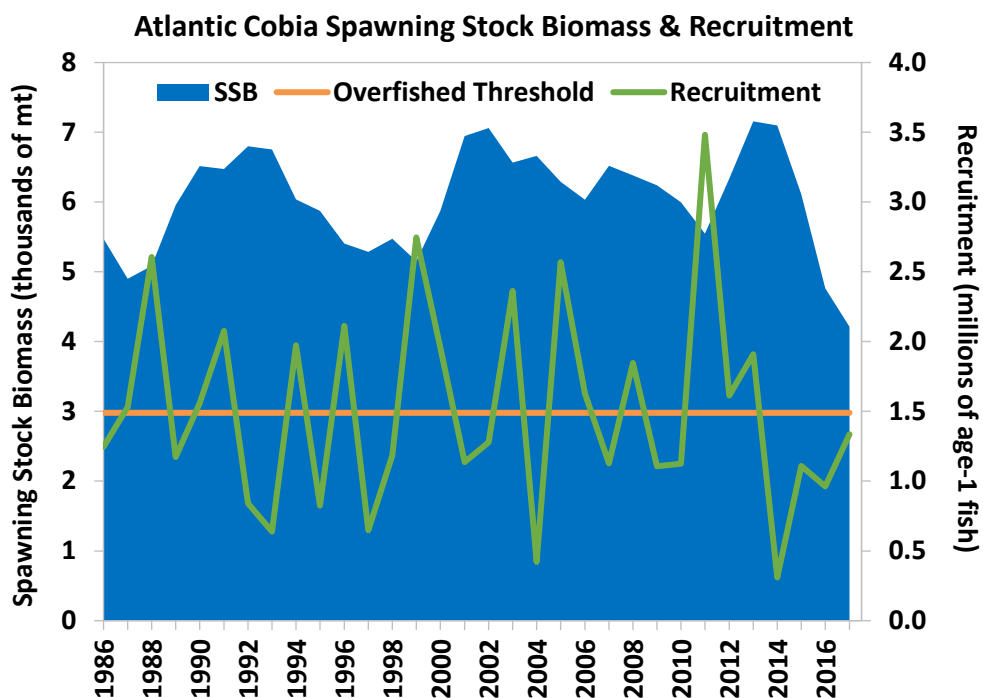
Press Releases

Atlantic Cobia Benchmark Stock Assessment Finds Resource Not Overfished Nor Experiencing Overfishing

South Atlantic Board Sets Harvest Specifications & Initiates Addendum

Arlington, VA – The Commission’s South Atlantic State/Federal Fisheries Management Board accepted the Atlantic Cobia Benchmark Stock Assessment and Peer Review Report, including new reference points, for management use. The assessment, which was conducted through the Southeast Data, Assessment, and Review (SEDAR) process, evaluated the Atlantic stock of cobia, which extends from the Georgia/Florida border north. Assessment results indicate the stock is not overfished and overfishing is not occurring.

Spawning stock biomass (SSB) has been above the overfished threshold throughout the timeframe (1986-2017), indicating the coastwide stock is not overfished. SSB has shown several large increases following years of high recruitment, the most recent following the 2011 recruitment peak, with the largest SSB in the time series occurring in 2013. These peaks in SSB have been followed by declines when recruitment moves back towards its average.

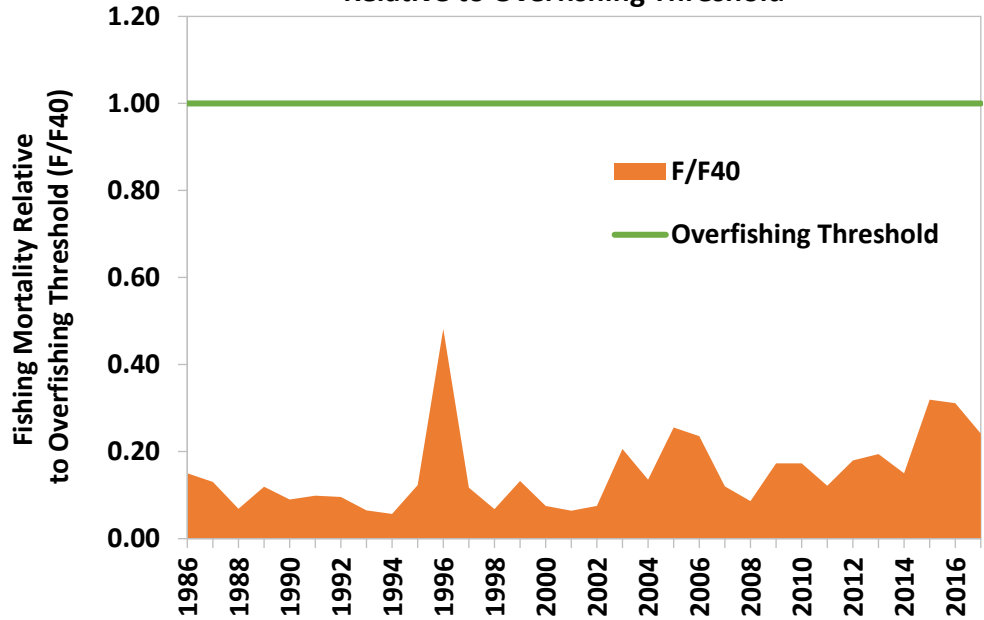


While SSB has undergone a steep decline since the 2013 peak, SSB remains above the overfished threshold.

This assessment used re-calibrated recreational catch data from the Marine Recreational Information Program (MRIP). Landings of Atlantic cobia have generally increased since the 1980s, primarily driven by the recreational fishery, which accounts for about 96% of the total landings. Fishing mortality showed some increase in the most recent years, but did not approach the overfishing threshold, indicating the coastwide stock has not undergone overfishing during the assessment timeframe.

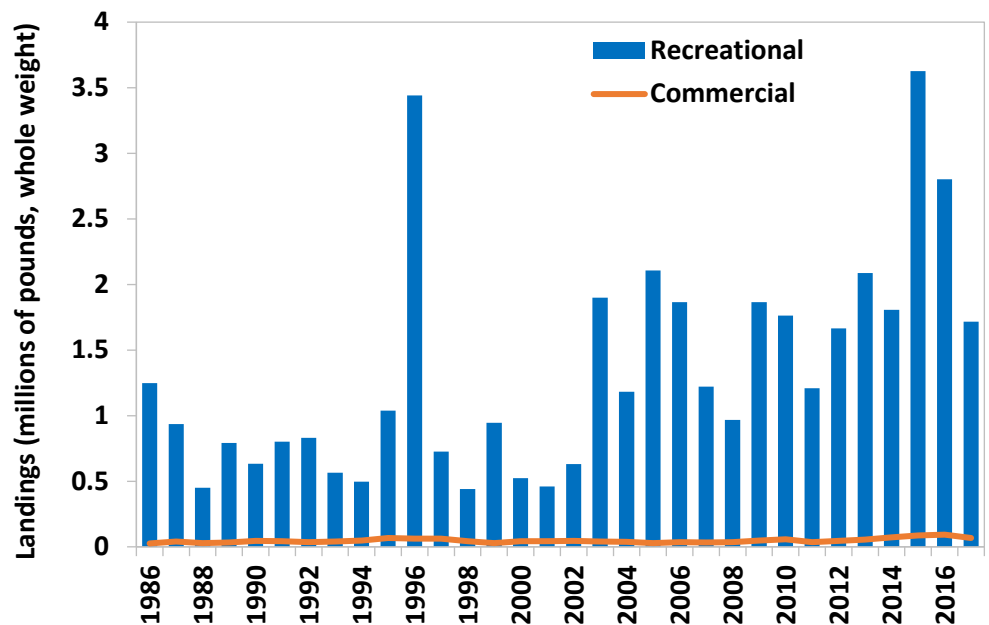
Several projections of the population under different harvest scenarios were conducted, describing predicted trends in biomass and the probability of the stock becoming overfished through 2024. The TC recommended harvest quota levels to the Board based on projections that maintained a low probability of the stock becoming overfished and did not result in consistent declines in SSB. Based on the assessment results and harvest projections, the Board approved an annual total harvest quota of 80,112 fish for the 2020-2022 fishing seasons. The Board maintained current recreational measures for 2020 while the states consider potential regulatory changes for future years.

Atlantic Cobia Fishing Mortality Relative to Overfishing Threshold



The Board also discussed recreational/commercial allocation as established by Amendment 1 to the Interstate Fishery Management Plan (FMP) for Atlantic Migratory Group Cobia, which currently allocates 92% of the total quota to the recreational fishery and 8% to the commercial fishery. These percentages were originally based on historical harvest from each sector within a period of reference years, prior to the re-calibration of MRIP estimates. With the re-calibration of the recreational data, the percentages of harvest in the reference period changed, resulting in the current commercial allocation percentage being higher than its percentage of total harvest during the reference period. In response to this, the Board initiated an addendum to reevaluate allocation. The Board also noted potential regulatory inconsistencies among *de minimis* states and determined the *de minimis* measures should be reconsidered through the addendum.

Atlantic Cobia Recreational and Commercial Landings



The SEDAR 58 Report is available at

http://www.asmf.org/uploads/file/5e3d99a3SEDAR58_AtlCobiaAssessment_PeerReviewReport.pdf

. An overview will be available on the Commission’s website, www.asmf.org, on the Cobia page under Stock Assessment Reports. For more information, please contact Dr. Mike Schmidtke, FMP Coordinator, at mschmidtke@asmfc.org.

###

PR20-06

ASMFC South Atlantic Board Approves Atlantic Croaker and Spot Addenda

Arlington, VA – The Commission’s South Atlantic State/Federal Fisheries Management Board approved Addendum III to Amendment 1 to the Interstate Fishery Management Plan (FMP) for Atlantic Croaker and Addendum III to the Omnibus Amendment to the Interstate FMPs for Spanish Mackerel, Spot, and Spotted Seatrout. These Addenda adjust management of Atlantic croaker and spot through their respective Traffic Light Approaches (TLA).

Through the annual analysis of the TLA, which assigns a color (red, yellow, or green) to characterize relative levels of indicators that reflect the condition of the fish population (abundance characteristic) or fishery (harvest characteristic). If the amount of red, indicating low abundance or low harvest, in both characteristics exceeds threshold levels (30% and 60%) for too many years, management action is triggered. In 2018, the Atlantic Croaker Technical Committee and Spot Plan Review Team recommended updates to their respective TLAs that would incorporate additional fishery-independent indices, age information, use of regional characteristics, and changes to the management-triggering mechanism.

These Addenda change the management-triggering mechanisms to enact coastwide management if the amounts of red for both the harvest and abundance characteristics within a region (Mid-Atlantic and South Atlantic) exceed threshold levels for 3 of the 4 most recent years for Atlantic croaker and 2 of the 3 most recent years for spot. The Addenda also define commercial and recreational management responses to triggers at each threshold level (see table below). Finally, the Addenda define the processes for evaluating the fisheries while triggered measures are in place and determining when triggered measures may be removed.

Management Triggers & Reponses for Atlantic Croaker & Spot

Species	Recreational		Commercial	
	30% Threshold	60% Threshold	30% Threshold	60% Threshold
Atlantic Croaker	Bag Limit: up to 50 fish for non- <i>de minimis</i> states	Bag Limit: up to 40 fish for all states	Measures to achieve 1% harvest reduction from previous 10-year average for non- <i>de minimis</i> states with no regulations	Measures to achieve 5% harvest reduction from previous 10-year average for all states
Spot	Bag Limit: up to 50 fish for non- <i>de minimis</i> states	Bag Limit: up to 40 fish for all states	Measures to achieve 1% harvest reduction from previous 10-year average for non- <i>de minimis</i> states with no regulations	Measures to achieve 10% harvest reduction from previous 10-year average for all states

Note: Regulations will not go into effect unless management is triggered by the TLA Analysis.

Both Addenda were approved for immediate implementation by the states of New Jersey through Florida. The next TLA analyses will be presented to the Board at the Commission's 2020 Summer Meeting.

The Addenda will be available on the Commission's website, www.asmfc.org (on the Atlantic Croaker and Spot webpages) by mid-February. For more information, please contact Dr. Mike Schmidtke, FMP Coordinator, at mschmidtke@asmfc.org or 703.842.0740.

###

PR20-05

Meeting Summary

The South Atlantic State/Federal Fisheries Management Board met to review and consider acceptance of the Atlantic Cobia Benchmark Stock Assessment and Peer Review (see above press release), take final action on Draft Addenda for Atlantic Croaker and Spot (see above press release), consider initiating changes to the Spanish Mackerel Fishery Management Plan (FMP) and discuss a roadmap for the next red drum stock assessment.

The Board discussed initiating management action to align state and federal management of Spanish mackerel. A federal commercial closure in 2019 prompted state, Commission, and South Atlantic Fishery Management Council (SAFMC) staff to compare Spanish mackerel management through the Commission's Omnibus Amendment to the Interstate Fishery Management Plans (FMP) for Spanish Mackerel, Spot, and Spotted Seatrout (Omnibus Amendment) with that of the SAFMC's FMP for Coastal Migratory Pelagics of the Gulf of Mexico and Atlantic Region (CMP FMP). Differences between these plans exist in terms of recreational season definition, allowable gears, commercial management zones, recreational accountability measures, and commercial trip limits. The Board was presented with a summary of the differences between the FMPs. The Board noted the next stock assessment is scheduled for completion in 2022. This assessment will incorporate re-calibrated recreational catch estimates from the Marine Recreational Information Program (MRIP), which will likely impact harvest quotas and other management measures. The Board decided action on the current differences between the FMPs can be postponed until after the stock assessment.

The Board also reviewed a proposal from the Red Drum Stock Assessment Subcommittee (SAS) concerning the next red drum stock assessment. Previous assessments have had difficulty modeling red drum due to limited data on fish larger than the current slot limit, which can disproportionately contribute reproductively to the stock. It was recommended population simulation models be developed that would simulate the full red drum population, then test a variety of assessment modeling techniques to determine which would be most useful with a peer review in 2022. The SAS noted this project will require a substantial work and modeling expertise and would change the timeline for delivery of the next red drum assessment. The Southeast Data, Assessment, and Review of red drum, currently scheduled for 2022, would be postponed until 2024. The Board agreed with the SAS's proposal, tasked the SAS with conducting the simulation project, and recommended that the Interstate Fishery Management Program Policy Board adjust the stock assessment schedule accordingly.

For more information, please contact Dr. Michael Schmidtke, Fishery Management Plan Coordinator, at mschmidtke@asmfc.org or 703.842.0740.

Motions

Atlantic Cobia

Move to accept the SEDAR 58 Atlantic Cobia Benchmark Stock Assessment and Peer Review Reports and the recommended F40-based biological reference points for management use.

Motion made by Dr. Rhodes and seconded by Ms. Fegley. Motion carries unanimously.

Main Motion

Move to recommend a 2.4 million pound annual quota for cobia for 2020-2022 with status quo recreational measures in 2020.

Motion made by Mr. Batsavage and seconded by Mr. Bell. Motion tabled.

Motion to Table

Move to table motion until after red drum items.

Motion made by Mr. Nowalsky and seconded by Dr. Rhodes.

Main Motion as Modified

Move to recommend an 80,112 fish annual quota for cobia for 2020-2022 with status quo recreational measures in 2020.

Motion made by Mr. Batsavage and seconded by Mr. Bell. Motion carries unanimously. (Roll call: In favor – NJ, DE, MD, PRFC, VA, NC, SC, GA, FL, NMFS, USFWS)

Move to initiate an addendum to reevaluate the recreational and commercial allocations for cobia and reconsider *de minimis* measures.

Motion made by Mr. Woodward and seconded by Mr. Cimino. Motion passes unanimously.

Atlantic Croaker Addendum III

Move to approve Option B, under Issue 1, for Atlantic Croaker Addendum III.

Motion made by Ms. Fegley and seconded by Mr. Gary. Motion passes by unanimous consent.

Move to approve Option B, under Issue 2, for Atlantic Croaker Addendum III.

Motion made by Mr. Batsavage and seconded by Mr. Estes. Motion passes by unanimous consent.

Move to approve Option B, sub-option B1, under Issue 3, for Atlantic Croaker Addendum III.

Motion made by Ms. Fegley and seconded Mr. Estes. Motion passes by unanimous consent.

Move to approve Option B, under Issue 4, for Atlantic Croaker Addendum III.

Motion made by Mr. Miller and seconded by Dr. Rhodes. Motion passes by unanimous consent.

Spot Addendum III

Move to approve Option B, under Issue 1, for Spot Addendum III.

Motion made by Mr. Clark and seconded by Mr. Batsavage. Motion passes by unanimous consent.

Move to approve Option B, under Issue 2, for Spot Addendum III.

Motion made by Ms. Fegley and seconded by Mr. Clark. Motion passes by unanimous consent.

Move to approve Option B, sub-option B2, under Issue 3, for Spot Addendum III.

Motion made by Mr. Batsavage and seconded by Mr. Bell. Motion passes by unanimous consent.

Move to approve Option B, under Issue 4, for Spot Addendum III.

Motion made by Mr. Miller and seconded by Dr. Rhodes. Motion passes approved unanimously.

Move to approve Addendum III to the Omnibus Amendment to the Interstate Fishery Management Plans for Spanish Mackerel, Spot, and Spotted Seatrout, and Addendum III to Amendment 1 to the croaker Fishery Management Plan as modified today with an immediate implementation date.

Motion made by Mr. Bell and seconded by Ms. Bolen. Motion passes unanimously. Roll call: In favor – NJ, DE, MD, PRFC, VA, NC, SC, GA, FL, NMFS, USFWS)

Move to elect Lynn Fegley as Vice Chair of the South Atlantic Board.

Motion made by Mr. Clark and seconded by Mr. Haymans. Motion passes by unanimous consent.

EXECUTIVE COMMITTEE (FEBRUARY 6, 2020)

Meeting Summary

The Executive Committee met and discussed several issues including: 1) allocation of remaining plus-up funds; 2) Public input process; 3) Management Board changes to accommodate shifts in species distributions; 4) Use of Modes split in Recreational Fisheries Management and 5) future Commission Annual Meetings. The following action items resulted from the Committee's discussions:

- **Allocation of remaining plus-up funds** – Staff presented options for allocating the remaining plus-up funds and the Committee had a good discussion on potential projects. An interactive spreadsheet will be developed and utilized by the Executive Committee to rank the nine projects presented for funding. Allocation of the plus-up funds will be reconsidered at the Spring Executive Committee meeting.
- **Public input process** – Staff presented the details of Advisory Panel (AP) participation by species panels, and it was determined that there is generally poor attendance and participation across most APs. After some discussion it was recognized that the old way of getting public input is becoming less effective, due in large part to the use of social media and technology, and the Commission needs to update its public input process. The Management & Science Committee (MSC) has been tasked with recommending better ways to engage stakeholders and capture public input. This will be on the agenda for the Spring Executive Committee meeting.
- **Management Board changes to accommodate shifts in species distributions** – In light of species distribution shifts due to Climate Change, the question of when is a state obligated to participate in a species management board has been asked. A healthy discussion ensued, with a number of thought-provoking ideas offered. The Chair will task the MSC with recommending better ways to engage stakeholders and capture public input. This will be on the agenda for the Summer Executive Committee meeting.

- Modes split in Recreational Fisheries Management – Concern has been raised about the fairness of allowing differential access to for-hire and private angler fisheries. The recent bluefish decision to allow a larger possession limit for individuals on for-hire trips compared to private boat and shore anglers was used as an example of differential access. The Commission is charged with the responsibility of managing public resources and fairness is an important part of that charge. A work group was established to develop a policy on this issue and will report out to the Executive Committee at the Spring Meeting.
- Future Annual Meetings – The Commission’s next four Annual Meetings will be held in New Jersey (2020), North Carolina (2021), Maryland (2022) and Delaware (2023).

The Committee also discussed the membership of the Commission’s Legislative Committee; coordination of the whelk fishery along the Atlantic coast; Pennsylvania’s membership on the Atlantic Menhaden Board and MRIP invoice from the states.

For more information, please contact Laura Leach, Director of Finance & Administration, at lleach@asmfc.org or 703.842.0740.

Motions

No motions made.

INTERSTATE FISHERIES MANAGEMENT PROGRAM POLICY BOARD (FEBRUARY 6, 2020)

Meeting Summary

The ISFMP Policy Board met to consider a number of issues, including an update from the Executive Committee; review of the 2020 Commissioner survey results; process implications for the Ecological Reference Points (ERPs) Assessment; update on the progress of the shad and lobster benchmark stock assessments; and review of the definitions for stock status categories.

The Commission Chair Pat Keliher presented the Executive Committee Report (see Executive Committee meeting summary earlier in this document) to the Policy Board.

Deke Tompkins presented the results of the 2019 Commissioner survey, highlighting that there were no significant changes from the previous year regarding Commissioner satisfaction on the progress and actions of the Commission. Areas highlighted for improvement included cooperation between Commissioners, the Commission’s ability to manage rebuilt stocks, and progress to end overfishing.

Dr. Katie Drew provided a summary of the ERPs assessment presented at the Atlantic Menhaden Board meeting earlier in the week (see press release). There is no one answer for how to manage under ERPs. The ERP Assessment provides tools to evaluate trade-offs of different management objectives for various predator and prey populations and fisheries. The Policy Board discussed how management decisions could be made for ERPs and how those decisions could impact decisions of other management boards and vice versa. For example, if ERPs were adopted as presented but the Atlantic Striped Bass Board changed its single-species reference points, the ERP values would then change. A decision by one species board could impact the actions of another board, which raised the question of what body should

make ERP decisions or decisions impacting ERPs. In its discussions, the Policy Board discussed the need to minimize the complexity of decision-making as the Commission moves towards ecosystem-based fisheries management. The Policy Board recognized the Commission may need to develop a framework within the ISFMP for ecosystem management and will continue the discussion in May.

Jeff Kipp provided an update on two ongoing benchmark stock assessments. The American lobster stock assessment will be peer-reviewed in the summer of 2020. A reference point workshop was held in October 2019 and the last modeling workshop will be in February 2020. The American shad stock assessment will be peer-reviewed in the spring of 2020. The last modeling workshop was in November of 2019. The Policy Board discussed a change in the timing of the next red drum benchmark stock assessment as recommended by the South Atlantic State/Federal Fisheries Management Board. The Policy Board approved a two-stage assessment process, which includes two years of work devoted to simulation analysis with a peer review in 2022 and a subsequent two years of work devoted to a traditional benchmark stock assessment with a peer review in 2024.

In August 2019, the Policy Board reviewed the annual performance of the stocks, which provides the Board a review of the stock status, technical committee advice, and management board actions for Commission species. Based on its review, it suggested that the current stock categories were not broad enough for all of the Commission species. At its meeting this week, the Policy Board approved adding overfished and overfishing to the stock categories.

For more information, please contact Toni Kerns, ISFMP Director, at tkerns@asmfc.org or 703.842.0740.

Motions

No motions made.

BUSINESS SESSION (FEBRUARY 6, 2020)

Meeting Summary

The Business Session (also known as the full Commission) met to receive an update on the Commonwealth of Virginia's efforts to come back into compliance with the Atlantic Menhaden FMP. The Business Session thanked the Secretary of Commerce for his support and concurrence with the Commission's non-compliance finding. The Virginia General Assembly is working toward approving legislation to bring the state back into compliance with the FMP. A bill has passed the House of Delegates and a similar bill will be considered by the Senate in the coming weeks. Upon written notification from Virginia that they are fully in compliance, the Commission Chair will submit a letter to the Secretary of Commerce to remove the potential moratorium.

For more information, please contact Robert Beal, Executive Director, at rbeal@asmfc.org or 703.842.0740.

Motions

No motions made.



PRESS RELEASE

FOR IMMEDIATE RELEASE
December 17, 2019

PRESS CONTACT: Mary Sabo
(302) 518-1143

Council and Commission Recommend Recreational Bluefish Management Measures for 2020

ANNAPOLIS, MD – Last week, the Mid-Atlantic Fishery Management Council (Council) recommended and the Atlantic States Marine Fisheries Commission (Commission) approved new recreational fishing regulations for the 2020 Atlantic bluefish fishery from Florida to Maine. These measures, which include a 3-fish bag limit for private anglers and shore-based fishermen and a 5-fish bag limit for for-hire fishermen, represent a substantial reduction compared to the federal 15-fish bag limit that has been in place since 2000. The Commission’s actions are final and apply to state waters (0-3 miles from shore), while the Council will forward its recommendation for federal waters (3 – 200 miles from shore) to the NOAA Fisheries Greater Atlantic Regional Fisheries Administrator for final approval.

The most recent operational assessment of the Atlantic bluefish stock concluded that the stock is overfished but not experiencing overfishing. During their joint meeting in October, the Council and Commission adopted a recreational harvest limit (RHL) of 9.48 million pounds for 2020 and 2021, which is an 18% decrease compared to the 2019 RHL. Using the current regulations, the recreational sector is projected to land 13.27 million pounds, which will exceed the RHL by 28.56%. Therefore, the Council and Commission met last week to approve new recreational management measures to constrain harvest to the reduced RHL.

The Council and Commission considered several combinations of bag limits and minimum size limits, including options to set a single set of regulations for all fishing modes or different regulations for shore/private modes and the for-hire mode. Although the Council’s Bluefish Monitoring Committee recommended a coastwide 3-fish bag limit, the majority of comments from the public and Bluefish Advisory Panel (AP) members expressed opposition to this option, noting that it would have severe economic consequences for the for-hire sector, which was only responsible for 3.6% of coastwide landings from 2016 to 2018. Additionally, AP members and the public emphasized that these proposed reductions come at a challenging time for for-hire stakeholders as they are also facing new restrictions on striped bass, black sea bass, summer flounder, and scup.

After an extensive discussion and thorough consideration of public comments, the Council recommended and Commission approved a 3-fish bag limit for private and shore modes and a 5-fish bag limit for the for-hire mode. No restrictions were made to minimum fish size or seasons.

“For many years, bluefish has been one of our most abundant recreational fisheries,” said Council Chairman and ASMFC Board member Mike Luisi. “The Council and Commission are fully committed to the effective conservation and management of this stock, but we also recognize that a sudden change in regulations could have severe socioeconomic consequences for some stakeholders. After evaluating a wide range of options and considering numerous comments from the public, we feel that this approach is the most fair and effective way to achieve the necessary reduction in harvest next year.”

The Council and Commission are continuing to work on development of a rebuilding plan as part of the Bluefish Allocation and Rebuilding Amendment. Additional information and updates on this action are available at <http://www.mafmc.org/actions/bluefish-allocation-amendment>



December 2019 Council Meeting Report

The following summary highlights actions taken and issues considered at the Mid-Atlantic Fishery Management Council's meeting December 9-12, 2019 in Annapolis, MD. Presentations, briefing materials, and webinar recordings are available at: <http://www.mafmc.org/briefing/december-2019>.

During this meeting, the Council:

- Approved the use of regional conservation equivalency for the recreational summer flounder fishery in 2020*
- Approved *status quo* recreational scup and black sea bass management measures in state and federal waters in 2020*
- Approved recreational bluefish measures for 2020 consisting of a 3-fish bag limit for the shore and private mode and a 5-fish bag limit for the for-hire modes*
- Approved a scoping document for the joint Summer Flounder, Scup, and Black Sea Bass Commercial/Recreational Allocation Amendment*
- Agreed to develop the Black Sea Bass Commercial Allocation Addendum/Amendment as a joint action with the ASMFC*
- Approved a supplemental scoping document for the Bluefish Allocation and Rebuilding Amendment*
- Approved the Commercial eVTR Omnibus Framework with a 48-hour reporting deadline
- Selected a preferred alternative and approved the Omnibus Risk Policy Framework
- Selected preferred alternatives and approved the Surfclam and Ocean Quahog Excessive Shares Amendment
- Approved the 2020-2024 Strategic Plan
- Approved the Comprehensive Five Year (2020-2024) Research Priorities document
- Finalized the EAFM summer flounder conceptual model and agreed to move forward with development of a summer flounder recreational discards management strategy evaluation
- Identified four areas of expertise needed on the Scientific and Statistical Committee
- Reviewed and approved a list of actions and deliverables for the 2020 Implementation Plan
- Received an update on habitat activities

** Items denoted with an asterisk (*) were undertaken during joint meetings with the Atlantic States Marine Fisheries Commission's Summer Flounder, Scup, and Black Sea Bass Management Board and Bluefish Management Board.*

Summer Flounder, Scup, Black Sea Bass, and Bluefish 2020 Recreational Management Measures

The Council met jointly with the Atlantic States Marine Fisheries Commission's (ASMFC) Summer Flounder, Scup, and Black Sea Bass Management Board (Board) and Bluefish Management Board to develop recreational management measures for summer flounder, scup, black sea bass, and bluefish for 2020.

Summer Flounder

The Council and Board approved the continued use of regional conservation equivalency for the recreational summer flounder fishery in 2020 to achieve, but not exceed, the 2020 summer flounder recreational harvest limit (RHL) of 7.69 million pounds. Conservation equivalency allows individual states or multi-state regions to develop customized measures that, in combination, will achieve the coastwide RHL. Regional measures under conservation equivalency in 2020 will be the same measures as in 2019, with the possibility of minor adjustments to season start and end dates in some states.

The Council and Board also maintained the *status quo* non-preferred coastwide measures that are written into the federal regulations but waived in favor of state regulations once conservation equivalency is approved by the National Marine Fisheries Service (NMFS). These measures include a 4-fish possession limit, a 19-inch total length minimum size, and an open season of May 15 – September 15. The Council and Board also made no changes to the current precautionary default measures (i.e., a 2-fish possession limit, a 20-inch total length minimum size, and an open season of July 1 – August 31) which would be implemented in any state or region that does not adopt measures consistent with the conservation equivalency guidelines.

The Council and Board considered the staff recommendation to implement a coastwide slot limit in the summer flounder recreational fishery (allowing harvest of summer flounder only between 17-20 inches total length), but consistent with the Monitoring Committee recommendations, did not recommend this strategy for 2020. The Monitoring Committee has identified additional analyses that should be done to more thoroughly evaluate the potential impacts of slot limits for summer flounder and whether they are appropriate to use in future years.

Scup and Black Sea Bass

The Council and Board agreed to maintain *status quo* recreational management measures for scup in state and federal waters in 2020. In federal waters, this includes a 9-inch total length minimum fish size, a 50 fish possession limit, and an open season of January 1 - December 31.

They also agreed to maintain *status quo* recreational management measures for black sea bass in state and federal waters in 2020. In federal waters, this includes a 12.5-inch total length minimum fish size, a 15 fish possession limit, and open seasons of February 1-28 and May 15 - December 31. The Board agreed that states should not modify their management measures for 2020, with the exception of states participating in the optional February recreational fishery. Virginia is the only state which indicated an interest in participating in 2020; therefore, Virginia may need to adjust their measures later in the year to account for February 2020 harvest.

For both black sea bass and scup, the Council and Board discussed the possibility that maintaining *status quo* management measures in state and federal waters may result in overages of the recreational harvest limits. However, they agreed that these measures are unlikely to harm the stocks given that biomass is much higher than the target level for both species. They agreed that it is hard to justify a restriction in harvest to prevent exceeding the 2020 recreational harvest limits when biomass and availability to anglers are so high and the need for a restriction is not driven by a conservation need, but rather by changes to the recreational harvest estimates and the commercial/recreational allocation percentages in the Fishery Management Plan. The Council and Board emphasized that this is a short-term approach to address a unique situation and allow for more time to consider how management should adapt to the revised recreational harvest estimates from the Marine Recreational Information Program.

Bluefish

The Council and Bluefish Board approved coastwide recreational bluefish measures consisting of a 3-fish bag limit for the shore and private mode and a 5-fish bag limit for the for-hire modes (party/charter). No restrictions on season or minimum size were made. Additional details are available here:

<http://www.mafmc.org/newsfeed/2019/bluefish-2020-recreational-measures>.

Summer Flounder, Scup, and Black Sea Bass Commercial/Recreational Allocation Amendment

The Council and Board approved, with minor revisions, a scoping document for a joint amendment to reconsider the allocations between the commercial and recreational sectors for summer flounder, scup, and black sea bass. Scoping hearings will be scheduled for early 2020, and a revised scoping document will be posted once available at: <http://www.mafmc.org/actions/sfsbsb-allocation-amendment>.

Black Sea Bass Commercial Allocation Addendum/Amendment

In October 2019, the Board initiated a Board-only addendum to consider modifications to the state shares of the black sea bass commercial quota. During the December 2019 joint meeting, the Council agreed that this should be a joint action to allow the Council to have a voting role in any potential changes to these allocations and to

consider including them in the Council's fishery management plan. The Council voted to move forward with a Council amendment to complement the Board's addendum.

Bluefish Allocation and Rebuilding Amendment

The Council and ASMFC are developing an amendment that will address several issues in the bluefish fishery. The Council and Board held an initial round of scoping hearings in June and July 2018. However, because the issue of rebuilding was added to the amendment during the October 2019 meeting, the Council will need to provide additional hearings and opportunities for public comment. During this meeting, the Council and Bluefish Board reviewed a supplemental scoping document and approved the document for public scoping hearings with minor suggestions. Scoping hearing are anticipated to be held in January and February with exact locations and dates to be determined. Additional information and updates on this action will be posted at <http://www.mafmc.org/actions/bluefish-allocation-amendment>.

Seized Commercial Catch and the Quota Monitoring/Accountability Process

The Council and Board discussed issues related to monitoring and reporting of illegal commercial catch. Toni Kerns (ASMFC) provided an overview of how the states are handling seized commercial catch within their own reporting and monitoring systems, and Mike Ruccio (NOAA Fisheries Greater Atlantic Regional Fisheries Office) presented several options that could be pursued to address inconsistencies between the states.

Commercial eVTR Omnibus Framework

The Council discussed the alternatives and analyses for an omnibus framework action that considers requiring federally permitted commercial vessels to submit vessel trip reports (VTRs) to NMFS electronically. This action does not change existing data being collected, and operators would have a choice of which NMFS-approved eVTR application to use. This action affects all vessels with federal commercial permits for species managed by the Mid-Atlantic and New England Fishery Management Councils once joint action is taken. The NEFMC is scheduled to take final action at their January 2020 council meeting. After considering Advisory Panel and Fishery Management Action Team recommendations, the Council took final action, selecting alternative 1c to require VTRs be submitted electronically within 48 hours of trip completion. NMFS indicated that they would likely have an extended implementation deadline of up to a year after the final rule and the Council will coordinate several workshops throughout the Northeast Region in 2020. More information is available at <http://www.mafmc.org/actions/commercial-evtr-framework>.

Omnibus Risk Policy Framework

The Council held the second framework meeting and took final action on the Omnibus Risk Policy Framework. The Council's risk policy, originally implemented in 2011, specifies the Council's acceptable level of risk (i.e., the probability of overfishing, P*) and works in conjunction with the Scientific and Statistical Committee's (SSC) application of the ABC control rule to account for scientific uncertainty when setting an Acceptable Biological Catch (ABC) for a specific stock. During this meeting, the Council reviewed the results of a biological management strategy evaluation (MSE) conducted by Dr. John Wiedenmann (Rutgers University) and an economic MSE conducted by Dr. Doug Lipton (NOAA Fisheries) and Cyrus Teng (University of Maryland) that evaluated eight different risk policy alternatives, including the Council's current risk policy. The results indicated that several alternatives would allow for increased yield and economic benefit when compared to the current risk policy and would still minimize the risk of overfishing or a stock becoming overfished.

The Council approved a new risk policy that was a hybrid approach to two of the alternatives considered (Alternatives 2 and 8). The new risk policy seeks to prevent stocks from being overfished by reducing the probability of overfishing as stock size falls below the target biomass while also allowing for increased risk under higher stock biomass conditions, particularly at very high levels such as those currently found with scup and black sea bass. The Council also approved removing the typical/atypical species distinction currently included in the risk policy. It is anticipated that the new risk policy will be implemented in 2020 and could be applied to 2021 catch and harvest specifications.

Surfclam and Ocean Quahog Excessive Share Amendment

After reviewing public comments, the Council selected preferred alternatives and approved the Atlantic Surfclam and Ocean Quahog Excessive Shares Amendment for submission to the Secretary of Commerce. The amendment was developed to address the "excessive shares" provisions of the National Standard 4 guidelines of the Magnuson-Stevens Fishery Conservation and Management Act (MSA), which require that no individual, corporation, or other entity acquires an excessive share of the SCOQ Individual Transferable Quota (ITQ) privileges. The amendment also considered modifications to the FMP goals and objectives and revisions to the multi-year specification setting process. The Council selected the following preferred alternatives:

- **Goals and Objectives.** The Council adopted the goals and objectives recommended by the Fishery Management Action Team. They were crafted around goal areas that focused on sustainability, a simple and efficient management regime, managing for stability, management that is flexible and adaptive to changes, and the promotion of science and research. The adopted goals and objectives better reflect the Council's long-term intent for these fisheries
- **Excessive Shares Cap: Sub-Alternative 4.4.** The Council's preferred alternative would implement a two-part cap, with quota share ownership cap at 35% for surfclams and 40% for quahogs, and annual allocation cap based on the possession of cage tags at 65% for surfclams and 70% for ocean quahogs. The Council selected the family affiliate level and the cumulative 100% model for tracking of ownership.
- **Excessive Shares Review: Alternative 2.** This alternative would require the periodic review of the excessive share measures at least every 10 years or as needed. The review could be done in conjunction with the Catch Share Program Review.
- **Framework Adjustment Process: Alternative 1.** This alternative would not change the list of management measures that can be addressed through the framework adjustment process.
- **Multi-Year Management Measures: Alternative 2.** The Council's preferred alternative would allow specifications to be set for maximum number of years consistent with the Northeast Regional Coordinating Council approved stock assessment schedule.

2020-2024 Strategic Plan

The Council reviewed public comments and approved a final 2020-2024 Strategic Plan with several minor modifications. A final version of the plan will be posted in the coming weeks at <http://www.mafmc.org/strategic-plan>. In addition, the Council reviewed a proposed evaluation plan which outlines a process for conducting annual, mid-plan, and comprehensive reviews of progress toward addressing the Council's strategic goals and objectives.

2020-2024 Research Priorities

The Council reviewed and approved the Comprehensive Five Year (2020-2024) Research Priorities document. This document outlines broad priority themes and species-specific research priorities and was developed with input from the Council's Research Steering Committee, SSC, Advisory Panels, Monitoring Committees, and the Northeast Fisheries Science Center (NEFSC). The document includes a review of the existing priorities document and was also re-organized and prioritized to develop a more useful, tactical, and strategic document to effectively advance scientific and management information that is aligned with Council and NEFSC resources and priorities.

EAFM Summer Flounder Conceptual Model

The Council reviewed and finalized the Ecosystem Approach to Fisheries Management (EAFM) summer flounder conceptual model. Conceptual model development is the second step in the EAFM structured decision framework and is meant to ensure that key relationships throughout the system are accounted for and help answer high priority management questions. A workgroup of summer flounder science and management experts, in consultation with the Council's Ecosystem and Ocean Planning Committee, developed a conceptual model and visualization tool that identified key high-risk factors and important ecosystem elements. Management questions relevant to summer flounder and the associated fisheries that could be answered using the model and the available data were then developed and considered by the Council. Based on application and information in the conceptual model, the Council agreed to conduct a management strategy evaluation (MSE) that will identify and

evaluate the biological and management implications of alternative strategies to minimize recreational summer flounder discards. The recreational discards MSE, the third step in the EAFM decision framework, will begin in 2020 and will involve extensive science, management, and stakeholder engagement.

SSC Membership White Paper

Earlier in 2019, the Council reappointed 16 existing members of the Scientific and Statistical Committee (SSC) to another 3-year term, leaving four vacancies on the SSC. At that time, the Council agreed to delay adding new members to the SSC in order to develop a white paper that would evaluate SSC membership, the future needs of the Council, and the expertise necessary to address those needs. The Council reviewed the white paper evaluation and recommended the following areas of need and membership expertise: one additional member with quantitative stock assessment expertise, one additional fisheries biologist/ecologist and one economist/social scientist that each have experience and expertise in ecosystem related issues, and one economist/social scientist to help support the different Council priorities and actions that will have socioeconomic implications. The Council will solicit nominations for new SSC membership in early 2020.

2020 Implementation Plan

Each year, the Council develops an annual implementation plan which identifies the activities and actions the Council expects to work on during the upcoming year. Implementation plans are designed for use as a planning tool by the Council and staff and as a way to update the public on progress toward achieving the goals and objectives of the strategic plan. During the meeting the Council reviewed and approved a list of actions and deliverables for the upcoming year. This list will be used by staff to develop a complete 2020 Implementation Plan for Council consideration at the February 2020 meeting.

Habitat Update

Council staff provided an update on the Northeast Regional Habitat Assessment (NRHA), which is a collaborative effort to describe and characterize estuarine, coastal, and offshore fish habitat distribution, abundance, and quality in the Northeast using a partnership driven approach. The project is being led by a Steering Committee composed of leadership from the major habitat conservation, restoration, and science organizations in the region. Additional information related to NRHA is available at <http://www.mafmc.org/nrha>. Staff also provided a brief update on the Council Coordination Committee Habitat Workgroup. The group met earlier this year for an Essential Fish Habitat Consultation and Regional Innovations Workshop. The purpose of the workshop was to advance our collective work toward effective essential fish habitat (EFH) consultations on non-fishing activities. Keith Hanson (GARFO Habitat Conservation Division) provided an update on projects of interest in the region, including several offshore wind activities, oil and gas survey activities, and coastal storm risk management studies.

Oscar E. Sette Award

Dr. John Boreman was recognized as the 2019 recipient of the Oscar E. Sette Award. The award is presented each year by the Marine Fisheries Section of the American Fisheries Society to an individual who has demonstrated sustained excellence in marine fishery biology through research, teaching, administration, or a combination of the three. Dr. Boreman has a distinguished career as a federal fisheries scientist with both NOAA and the U.S. Fish and Wildlife Service. He served as Director of the NOAA Fisheries Office of Science and Technology, the Science and Research Director of the NMFS Northeast Fisheries Science Center (NEFSC), the Director of the NEFSC Cooperative Marine Education and Research Program and adjunct professor of fisheries at the University of Massachusetts. At the end of this year, Dr. Boreman will step down as chair of the Council's SSC after serving in the role for 11 years.



Other Business

2020 Council Meetings

The schedule of 2020 Council Meetings is available at <http://www.mafmc.org/meetings>. Please note that the June 2020 Council meeting dates have been changed to **June 16-18, 2020**.

Next Council Meeting

February 11-13, 2020

The Sanderling Resort

1461 Duck Road, Duck, NC 27949

(855)-412-7866

<http://www.mafmc.org/council-events/february-2020-council-meeting>



SOUTH ATLANTIC FISHERY MANAGEMENT COUNCIL

4055 Faber Place Drive, Suite 201, North Charleston SC 29405
 Call: (843) 571-4366 | Toll-Free: (866) SAFMC-10 | Fax: (843) 769-4520 | Connect: www.safmc.net

Jessica McCawley, Chair | Mel Bell, Vice Chair
 Gregg T. Waugh, Executive Director

DECEMBER 2-6, 2019 COUNCIL MEETING REPORT WILMINGTON, NORTH CAROLINA

The following summary highlights the major issues discussed and actions taken at the South Atlantic Fishery Management Council’s December 2019 meeting in Wilmington, North Carolina. Briefing materials, presentations, and public comments are available on the Council’s website at:

<http://safmc.net/safmc-meetings/council-meetings/>

Final Committee Reports contain more details of what was accomplished for each committee and are located on the December 2019 briefing book page. In addition, the Summary of Motions on the Council’s website includes all motions from the meeting. Read further details and see images and other links at the December 2019 Council Meeting Round-up Story Map:

<https://www.arcgis.com/apps/MapJournal/index.html?appid=683b6570b2444ac8949710a512a31325>

Issue:	Action Taken:	Schedule:
<p>Mackerel Emergency Action</p>	<p>In June 2019, the Council approved a request for NMFS to raise the commercial king mackerel trip limit south of the Flagler/Volusia County line, Florida from 50-fish to 75-fish for the 2019-2020 season via emergency rule. The value of unharvested quota over the last four fishing seasons averaged \$3,880,961 per season.</p>	<p>The Council’s letter requesting emergency action was sent to NMFS on June 21, 2019 with a request to implement this prior to Season 2 of the 2019-2020 season (October 1st). NMFS implemented the emergency action effective October 1st.</p>
<p>Spanish Mackerel Control date</p>	<p>In June 2019, the Council approved a motion requesting that a control date be established for the open access commercial Spanish mackerel permit as of March 7, 2019, the date at which the Council first dis used limited-access for the commercial Spanish mackerel fishery.</p>	<p>The request for a control date in the commercial Spanish mackerel fishery was sent to NMFS on June 21, 2019. NMFS published an advanced notice of proposed rulemaking on October 15, 2019. The public comment period concluded on November 14, 2019. NMFS is drafting responses to the comments.</p>

Issue:	Action Taken:	Schedule:
CMP Framework Amendment 8 – increase the king mackerel commercial trip limit in the southern zone.	The Council approved the following preferred alternative for formal review: Preferred: 100 fish October 1 st to the end of February.	Staff and the IPT will prepare CMP Framework Amendment 8 for formal Secretarial review . The Council’s intent is to have these permanent regulations in place prior to the start of the second season of the 2020/21 fishing year (October 1 st).
CMP Framework Amendment 9 – Spanish mackerel commercial trip limit in the northern zone.	The Council reviewed the Advisory Panel’s recommendations and approved alternative trip limits for the Northern Zone of 1,500, 2,000, 2,500, or 3,500 pounds whole or gutted weight (no action). The Council selected 2,000 pounds as preferred and approved the amendment for public hearings.	Staff and the IPT will prepare CMP Framework Amendment 9 for public hearings to be held prior to the March 2-6, 2020 Council meeting.
Issue:	Action Taken:	Schedule:
ABC’s for Unassessed Snapper Grouper Stocks	The Council reviewed the SSC recommendations and directed staff to begin an information paper to evaluate the continued need for conservation and management of species recommended by the SSC for Ecosystem Component designation and evaluate additional species for management (barrel fish and African pompano). The Council also recommended that gray snapper, almaco jack, knobbed porgy, and jolthead porgy be considered for assessment through the SEDAR process.	The Council will review this information paper at the March 2-6, 2020 Council meeting. The SEDAR Steering Committee will review this request at their May 2020 meeting.
Snapper Grouper Abbreviated Framework Amendment 3 (South Atlantic Blueline Tilefish ACL)	The Council approved the following preferred alternative for formal review: <ul style="list-style-type: none"> • Increase the total ACL from 174,798 to 233,968 lbs ww • Increase the commercial ACL from 87,521 to 117,148 lbs ww • Increase the recreational ACL from 87,277 to 116,820 lbs ww • Increase the recreational ACT from 54,653 to 70,886 lbs ww 	Staff and the IPT will prepare SG Abbreviated Framework Amendment 3 for formal Secretarial review . The Council’s intent is to send for review prior to the March 2020 Council meeting.

Issue:	Action Taken:	Schedule:
Snapper Grouper Regulatory Amendment 31 (Modifications to Recreational Accountability Measures)	The Council revised the purpose and paused future work on Regulatory Amendment 31 until December 2020 when more will be known about how MRIP revisions will affect ACL and allocation revisions.	The Council will discuss SG Regulatory Amendment 31 at the December 2020 Council meeting.
Snapper Grouper Regulatory Amendment 33 (Red Snapper Season Modifications)	The Council revised the purpose and need for the amendment, decided not to change the start date of the commercial red snapper season, kept the preferred alternative to remove the minimum #days (3) for a season, and approved the amendment for formal review.	Staff and the IPT will prepare SG Regulatory Amendment 33 for formal Secretarial review. The Council's intent is to send for review prior to the March 2020 Council meeting.
Issue:	Action Taken:	Schedule:
Snapper Grouper Snapper Grouper Regulatory Amendment 29 (Best Fishing Practices & Powerheads)	The Council approved the amendment at the September meeting and the document is being finalized before sending for formal Secretarial review. At the December meeting, they reviewed a summary of current and past outreach efforts on best fishing practices in the South Atlantic and their results. Council staff also presented plans for future outreach efforts.	Council staff are planning an outreach program to coincide with the anticipated approval and implementation of the amendment in 2020.
System Management Plan Workgroup	The System Management Plan Workgroup met in October 8-9, 2019 to go over the Spawning Special Management webpage and begin an outline for evaluation of the Oculina Experimental Closed Area. Council staff briefed the Committee on the meeting and the evaluation plan.	Council staff will continue working with the System Management Plan Workgroup to complete the plan during 2020.
Landing Snapper Grouper Species in whole condition	The Committee discussed the regulation that requires that all snapper grouper species be landed with heads and fins intact. Staff provided background on the rationale for this regulation and recent inquiries from fishermen regarding whether certain species can be cut up to be used as bait.	The Law Enforcement Advisory Panel discussed the issue at their May 2019 meeting and stated there were no enforcement concerns. This was reiterated at the Committee meeting by the USCG representative who stated there had been very few cases where fishermen were found to be in violation of this regulation. The Committee did not express intent to modify the current regulation.

Issue:	Action Taken:	Schedule:
Shrimp Amendment 11 (Transit Provisions)	The Council reviewed scoping comments, modified the need statement, modified alternative 2 as shown below, and approved the amendment for public hearings: Alternative 2. A vessel may transit with non-stop progression through the South Atlantic cold-weather closed area with fishing gear appropriately stowed with trawl doors and nets out of the water. The bag straps must be removed from the nets.	Staff and the IPT will prepare Shrimp Amendment 11 for public hearings . Public hearings and review by the Shrimp/Deepwater Shrimp, and Law Enforcement Advisory Panels will be held prior to the March 2020 Council meeting.
Issue:	Action Taken:	Schedule:
SEDAR	The Council: <ul style="list-style-type: none"> • Approved appointments to the Gag operational assessment (SEDAR 71) and modified appointments to the Tilefish assessment (SEDAR 66). • Approved the schedule and the terms of reference for the Gag operational assessment (SEDAR 71). • Approved the scopes of work for the red snapper, blueline tilefish, and vermilion snapper assessments. The red snapper operational assessment will begin in early 2021. 	The Council will monitor progress of the assessments.
Issue:	Action Taken:	Schedule:
Advisory Panel Selection	The Council: <ul style="list-style-type: none"> • Approved appointments to the Dolphin Wahoo, Habitat Protection and Ecosystem-Based Management, Information and Education and Mackerel Cobia Advisory Panels. • Discussed concerns expressed by some Advisory Panel members about reimbursements for travel expenditures. The Council recognizes the importance of the AP members to the management process and the need to fairly cover expenses for travel for their voluntary participation. 	Staff will advertise open seats on the AP's as appropriate for consideration at the June 2020 Council meeting. Staff will draft edits to the Council Handbook that allow leeway for travel reimbursements as recommended for consideration at the March 2020 Council meeting.

Issue:	Action Taken:	Schedule:
<p>Dolphin Wahoo SSC recommendations on ABC levels</p>	<p>The Council discussed and provided the following requests for the SSC to consider at their April 2020 meeting:</p> <ul style="list-style-type: none"> • Reconsider the time series used for dolphin when setting catch level recommendations for dolphin. • Consider if a different time series that is more reflective of the current fishery for wahoo would be more appropriate in setting catch level recommendations for wahoo. • Would application of the ORCs method be a superior approach to the “third highest landings” approach in setting catch level recommendations for dolphin and wahoo? If so, does the SSC deem this approach best scientific information available (BSAI) and thus this method can be applied rather than the existing approach? 	<p>Staff will work with the SSC to be sure they address the request from the Council at their April 2020 SSC meeting.</p>
<p>Goals and Objectives</p> <p>Amendment 10 (Dolphin and Wahoo Management Measures)</p>	<p>The Council reviewed Amendment 10 and provided guidance to staff:</p> <ul style="list-style-type: none"> • To modify the goals and objective of the FMP. • Determined additional scoping was not necessary given the extensive discussions and public input during past meetings. • Moved Action 8 (Allow adaptive management of sector ACLs for dolphin) to the considered but rejected section. Directed staff to move Alternatives 3 & 4 in Action 8 to the Comprehensive ABC Control Rule amendment. • Removed Alternatives 2 and 3 in Action 9 (Revise the commercial accountability measures for dolphin). <p>Postponed further discussion of Amendment 10 until the June 2020 Council meeting when revised catch level recommendations from the SSC will be available.</p>	<p>The revised goals and objectives will be added to the next plan amendment.</p> <p>The Council will review a revised Amendment 10, with the SSC’s new ABC recommendations, at the June 8-12, 2020 meeting in Key West, FL.</p>
<p>Dolphin Wahoo Amendment 12 (Bullet & Frigate Mackerel)</p>	<p>The Council approved modifications to the purpose & need and approved further development of the amendment at the March 2020 Council meeting when the NMFS and NOAA GC will provide recommendations on regulatory measures.</p>	<p>The Council will review a revised Amendment 12 at the March 2-6, 2020 meeting in Jekyll Island, GA.</p>

Issue:	Action Taken:	Schedule:
MyFishCount	<p>BeBe Harrison gave the Council an update on activities:</p> <ul style="list-style-type: none"> • Staff participated in the American Sportfishing Association Industry Summit, Oct. 7-11, Stevenson, WA. • Staff presented at the Southeastern Association of Fish and Wildlife Agencies Meeting, Oct. 28-31, Hilton Head, SC. • Staff secured booth space at the November 1-2, 2020 National Seminar Series hosted by George Poveromo at the Fort Lauderdale Boat Show. • Staff participated in the North Carolina Boating and Fishing Industry Summit, Nov. 6-7, Greensboro, NC. • Staff participated in the South Carolina Sportfishing Industry Summit, Dec 4, Columbia, SC • Modifications have been made to give a new look and feel to MyFishCount.com. • Upgraded the software for iOS and Android MyFishCount apps. • Developed a MyFishCount message with monthly incentives and featured anglers to keep the public interested and informed. 	<p>Council staff are continuing to work on MyFishCount during the 3rd year (2019-2020).</p> <p>Information from the pilot project will be used by the Council when they continue work on the permitting and reporting amendment at a future meeting.</p>
Issue: Citizen Science Program	<p>The Council covered the following:</p> <ul style="list-style-type: none"> • Julia Byrd, Program Manager, gave an update on the 2019 Programmatic activities, pilot projects in progress, and projects and collaborations under development. Staff have been very busy presenting and participating at meetings and further developing the program. • Data collection for the SAFMC Scamp Release project is underway. The project has been and is still recruiting fishermen to participate in the program. Additionally, staff have been pursuing additional grant funding to help promote and expand the SAFMC Release mobile app. . • The FISHstory project is under development and a demonstration of the FISHstory test project in Zooniverse was conducted. • An additional collaboration is under development with the SEFSC to expand their series of Participatory Modeling 	<p>Work will continue on the program, the two pilot projects, and in developing new projects and collaborations.</p> <p>Data from the SAFMC Scamp Release project will be made available for 2020 scamp assessment.</p> <p>Work will continue on the FISHstory project. The tentative schedule is to beta test the project in Zooniverse in Dec 2019 and launch the project in early 2020.</p>

	<p>Workshops from the Gulf of Mexico to the South Atlantic. The South Atlantic workshops would focus on the Dolphin/Wahoo fishery. The tentative plan is for workshops to be held in the Carolinas and FL Keys in 2020 and have initial information available for the Council in late 2020.</p> <ul style="list-style-type: none"> • The Council reviewed, modified, and adopted the updated Citizen Science research priorities which incorporated feedback from the Citizen Science Projects Advisory and Operations Committees. • Dr. Jennifer Shirk, Interim Director of the Citizen Science Association, presented preliminary findings from her research on the development of the Council’s Citizen Science Program. Her findings found a high return on the Council’s investment in the development of the Citizen Science Program. By supporting the Citizen Science Project Design Workshop and one staff person, a volunteer corps of over 45 people was mobilized, devoting the estimated equivalent of over \$50k worth of time to develop the SOPPS and the community capacity to implement them, as well as the development of 2+ pilot projects. Recommendations for the continued development and growth of the Council’s Program included: <ul style="list-style-type: none"> ○ Investing in the continuity of the Program by maintaining and growing staff support ○ Retaining the Action Teams, which will both require and offset staff time (e.g. mobilize to review/update products) ○ Seeking and securing funds on hand to anticipate and enable timely project roll-out; and ○ To conduct an analytical study of success factors and evaluation of both the Program and individual projects. • Rick Bonney gave a presentation on evaluation, highlighting its importance in order to determine whether a project or program is working and to identify ways to improve overall effectiveness. He noted that evaluation can be complicated and requires a careful look at goals, objectives, and indicators of success. He noted that the Council has led the way in the development of its Citizen Science Program by focusing on the Program first approach and that they will need to lead the way in the development of an evaluation plan for this Program. 	<p>Staff will work with the SEFSC and reach out to the states and Dolphin/Wahoo AP members to help determine when and where to hold the workshops.</p> <p>The Council reviewed, made modifications, and approved the updated Citizen Science research priorities.</p> <p>The Council reiterated their support for the program and thanked Dr. Shirk and Rick Bonney for all their help and support.</p> <p>The Committee supported pursuing evaluation for both the overall Citizen Science Program and individual projects. As a next step for the Program evaluation, they supported staff working with Rick Bonney and the Operations Committee to draft Program objectives and indicators of success based on the Program goals identified in the SOPPS. These draft objectives and indicators of success would then be brought to the Council for their review and consideration.</p>
--	--	--

		Once there are agreed upon Program goals, objectives, and indicators of success, an evaluation plan can begin to be developed. Staff noted that it would be helpful to have someone independent of the Program help conduct an evaluation and additional resources may be required to support the evaluation.
Issue:	Action Taken:	Schedule:
For-Hire Recreational Reporting	The Amendment was sent for formal review on March 4, 2017 with a request for implementation by January 1, 2018. The amendment was approved on June 12, 2018 and the Final Rule was expected to publish in mid-April 2019 with a 60-day cooling off period.	At the December meeting, the Council was told the final rule package has been sent from the Region to NMFS HQ and is under review . No specific timing was available on publication of the final rule.
Full Council Actions: 1. Florida Keys National Marine Sanctuary 2. Menhaden 3. Council staff will develop a proposal for the South Atlantic/Gulf Council work group to look at flexible management options and bring back to the Committee at the March 2020 Council meeting. 4. Next Executive Director	<p>Sarah Fangman, FKNMS Superintendent, presented an overview of their proposed actions and alternatives. The Council discussed the input from the public and the Advisory Panels and requested some additional input from staff and NOAA GC for the March 2020 Council meeting.</p> <p>The Council discussed the request for input from NMFS on the finding of non-compliance by the State of Virginia with the ASMFC's Menhaden Plan.</p> <p>The Council directed staff develop a proposal for the work group looking at flexible management options.</p> <p>The Council thanked Gregg Waugh for his service to the Council over the past 39 years and for the excellent support provided by all Council staff under his leadership.</p>	<p>The Council will develop final recommendations at the March 2-6, 2020 meeting in Jekyll Island, GA.</p> <p>The Council approved sending a letter to NMFS supporting the non-compliance determination of Virginia with the Interstate Fishery Management Plan for Atlantic Menhaden. The letter was sent on December 5, 2019.</p> <p>Council staff will coordinate with Gulf Council staff for input at the Gulf's January 2020 meeting and bring back recommendations to the South Atlantic Council's March 2-6, 2020 meeting in Jekyll Island, GA.</p> <p>John Carmichael assumes duties as the next Executive Director effective December 13, 2019 at 5:01 p.m.</p>



ROY COOPER
Governor

MICHAEL S. REGAN
Secretary

STEPHEN W. MURPHEY
Director

January 24, 2020

MEMORANDUM

TO: N.C. Marine Fisheries Commission
FROM: Randy Gregory, Division of Marine Fisheries, NCDEQ
SUBJECT: Highly Migratory Species Update

Issue

Highly Migratory Species activity update.

Action Needed

For informational purposes only, no action is needed at this time.

Overview

The Highly Migratory Species Advisory Panel will meet in the spring 2020 in Silver Spring, Maryland. The Advisory Panel will discuss scoping for Amendment 12 to comply with Magnuson-Stevens Act National Standard Guidelines and NOAA Fisheries policy directives, Amendment 13 to consider options for modifications to bluefin tuna management, and Amendment 14 for shark quota management.

Tuna

In December 2019, the commercial bluefin tuna General category landed 22.8 metric tons of the 28.9 metric ton December adjusted sub-quota. As of January 22, 2020, preliminary commercial landings for the 2020 General category were 13.7 metric tons of the 49 metric ton January (January – March) adjusted sub-quota. Most of these bluefin tuna have been landed in the Morehead City area. The January sub-quota period will end on March 31, 2020, unless the sub-quota is reached earlier.

On January 17, 2020, NOAA Fisheries published the Final Environmental Impact Statement for a rule that would modify bluefin tuna bycatch management measures in the pelagic longline fishery. NOAA Fisheries is proposing to adjust regulatory measures to manage bluefin tuna bycatch in the pelagic longline fishery for Atlantic highly migratory species, specifically addressing the Northeastern United States Closed Area, the Cape Hatteras Gear Restricted Area, and the Spring Gulf of Mexico Gear Restricted Area as well as the weak hook requirement in the Gulf of Mexico. Of most interest to North Carolina, is the elimination of the Cape Hatteras Gear Restricted Area. Beginning in 2015, the Individual Bluefin Quota Program limited the bluefin tuna incidental catch in the pelagic longline fishery by individual vessel accountability and there is no longer a need for this restricted area.



ROY COOPER
Governor

MICHAEL S. REGAN
Secretary

STEPHEN W. MURPHEY
Director

January 24, 2020

MEMORANDUM

TO: Marine Fisheries Commission

FROM: Barbie Byrd, Protected Resources Biologist Supervisor

SUBJECT: Protected Resources Program Update

Issue

Summary information is provided from the Division's Protected Resources Program, specifically highlighting the Observer Program's coverage of estuarine commercial anchored gill nets during fall 2019 (September - November).

Action Needed

For informational purposes only, no action is needed at this time.

Findings

State-wide observer coverage during fall 2019 met or exceeded the required coverage outlined in the ESA Incidental Take Permits (ITP) for anchored large mesh (10.8%) and small mesh (2.2%) gill net fisheries. The coverage rates were calculated with preliminary trip ticket data from September – November 2019; therefore, the coverage rates could change once the trip ticket data are finalized later this year. The fall seasonal report required by the sea turtle ITP has been completed and submitted to NOAA staff. The final document can be found at the following link:

[ITP Fall Seasonal Report \(Completed 14 January 2020\)](#)

Currently, the Observer Program is focusing their effort on the anchored large mesh gill net catfish and striped bass fisheries in Management Unit A, as well as the state-wide anchored small mesh gill net fisheries.

2019 Fall Seasonal Progress Report
Incidental Take Permit No. 16230
September 1 – November 30, 2019



John McConnaughey
Protected Species Biologist
North Carolina Division of Marine Fisheries

January 14, 2020

TABLE OF CONTENTS

List of Tables	3
List of Figures	4
Summary	5
Tables	7
Figures	15

LIST OF TABLES

Table 1. Openings and closings of management units by date and regulation change from the 2019 fall season (September - November) for anchored large and small mesh gill nets for ITP Year 2020.....	7,8
Table 2. Preliminary seasonal observer coverage, fall 2019 (September - November) by management unit for anchored large mesh gill nets for ITP year 2020.....	9
Table 3. Preliminary seasonal observer coverage, fall 2019 (September - November) by management unit for anchored small mesh gill nets for ITP year 2020.....	9
Table 4. Summary of observed sea turtle interactions in anchored large and small mesh gill nets from the 2019 fall season (September - November) for ITP Year 2020.....	10
Table 5. Summary of reported sea turtle interactions in anchored large mesh gill nets from the 2019 fall season (September - November) for ITP Year 2020.....	11
Table 6. Summary of estimated and/or observed cumulative sea turtle interactions through the 2019 fall season (September - November) by management unit for anchored large mesh gill nets for ITP Year 2020.....	11
Table 7. Summary of estimated and/or observed cumulative sea turtle interactions through the 2019 fall season (September - November) by management unit for anchored small mesh gill nets for ITP Year 2020.....	11
Table 8. Citations written by Marine Patrol for anchored large and small mesh gill nets by date and violation code during the 2019 fall season (September - November) for ITP Year 2020.....	12
Table 9. Categories and descriptions of fishermen responses for the Observer Program's contact logs used for analysis.....	13
Table 10. Contacts made (n = 436) by the observers trying to set up trips by month categorized by contact type (0-15) and by total number (a), percent for total season (b), and percent for each month (c) for the 2019 fall season (September - November) for ITP Year 2020.....	14

LIST OF FIGURES

Figure 1. Map of ITP management areas.....	15
Figure 2. Map for proclamation M-13-2019. See Table 1 for full proclamation description.....	16
Figure 3. Map for proclamation M-15-2019. See Table 1 for full proclamation description.....	17
Figure 4. Map for proclamation FF-34-2019. See Table 1 for full proclamation description....	18
Figure 5. Map for proclamation M-23-2019. See Table 1 for full proclamation description.....	19
Figure 6. Map of observed sea turtle interactions in all management units (A, B, C, D1, D2, E) in anchored large mesh gill nets (n = 26) by species and disposition (alive/dead) for the 2019 fall season (September - November) for ITP Year 2020 (September 1, 2018 – August 31, 2019)	20

SUMMARY

The 2019 fall season for anchored large and small mesh gill nets in North Carolina is September 1, 2019 through November 30, 2019 for Incidental Take Permit (ITP) Year 2020 (September 1, 2019 – August 31, 2020) as defined in ITP No. 16230.

Significant regulatory changes were enacted during the fall 2019 anchored large mesh gill net fishery for southern flounder (*Paralichthys lethostigma*). These regulations were included in Amendment 2 of the Southern Flounder Fishery Management Plan adopted by the North Carolina Marine Fisheries Commission on August 23, 2019. This action was taken because the most recent southern flounder stock assessment indicated that the stock is overfished and overfishing is occurring. North Carolina state law requires management actions be taken to end overfishing within 2 years and recover the stock from an overfished condition within 10 years. To meet these legal requirements, the Division determined that a 62% reduction in harvest was necessary for 2019 and a 72% reduction would be needed in 2020.

To reduce harvest in the anchored large mesh gill-net fishery, the state was divided into 3 flounder management areas; Northern, Central, and Southern (Figure 4). Each area was scheduled an exact open and close date for fishing effort. The Northern area was open from September 15, 2019 through October 13, 2019, the Central area was open from October 1, 2019 through October 26, 2019, and the Southern area was open from October 1, 2019 through November 15, 2019. Flounder management areas were still subject to conditions put forth by federally issued ITPs for sea turtle and sturgeon incidental takes and could be closed by proclamation should allowable take numbers be approached or exceeded.

Preliminary coverage estimates were calculated differently for this report than they have been in the past as a result of regulation changes to the flounder fishery. In the past, observer coverage was calculated in each management unit by estimating fishing trips using an average of the previous five years' trip ticket data (2014 - 2018) for anchored large mesh gill nets and anchored small mesh gill nets. Averages were calculated using the proportion of actual fishing days to possible fishing days. The average, normalized effort was used to account for fluctuations in fishing effort over the previous five years, due to closures and other regulatory measures. Observed trip numbers for the season were then divided by the estimated number of trips for the season to generate the estimated coverage for each management unit.

Due to the shortened fishing season, using the average of the previous five years' trip ticket data to calculate observer coverage did not accurately represent the effort that was possible in the fishery during fall 2019. As a result, preliminary trip ticket data for large and small mesh gill net trips made during the fall 2019 season were used to calculate observer coverage. Observed trip numbers per season were then divided by the preliminary trip ticket data per season to generate the estimated coverage for each management unit. Although trip ticket data for this time were not finalized, their use allowed for greater confidence in the calculation of estimated observer coverage for the fall 2019 season. A complete list of anchored gill net proclamations implemented during the 2019 fall season can be found in Table 1.

The Observer Program achieved an estimated 10.8% overall anchored large mesh gill net coverage for the 2019 fall season (Table 2). No trips were obtained in Management Unit D1 because the management unit was closed for the entirety of the 2019 fall season (Table 2).

The Observer Program achieved an estimated 2.2% overall anchored small mesh gill net coverage for the 2019 fall season (Table 3).

There were twenty-five observed sea turtle interactions from anchored large mesh gill nets during the 2019 fall season, and one observed sea turtle interactions from anchored small mesh gill nets (Table 4; Figure 6). The species composition consisted of nineteen alive green sea turtles, six dead green sea turtles, and one alive sea turtle where positive species identification was not made (Table 4). There was one fisherman self-reported sea turtle interaction in an anchored large mesh gill net in the 2019 fall season (Table 5). The cumulative estimated and/or observed takes for anchored large mesh gill nets were calculated daily through the 2019 fall season for ITP Year 2020 (Table 6). The cumulative observed takes for anchored small mesh gill nets for the 2019 fall season ITP year 2020 are presented in Table 7.

Marine Patrol performed 277 gill net checks during the 2019 fall season and issued 21 citations (Table 8).

As per the ITP, the division established a permit in September 2014 to register all fishermen participating in the anchored large and small mesh gill net fisheries (Estuarine Gill Net Permit – EGNP). This multifaceted permit allows the division to closely monitor for compliance with the permit system already in place. Permits are renewed on an annual basis, based on the fiscal year for licenses. During the 2019 fall season there were 4 Notice of Violations (NOV) written for violations of the EGNP.

The Observer Program has various ways to contact fishermen to set up trips (i.e., alternative platform trips, calling the fisherman, waiting at boat ramps). Due to limited resources and fishermen leaving from their residence or private ramps, the most efficient and common way to contact fishermen is by phone. One of the many checks the Observer Program has is a contact log which is filled out for every contact that is made when attempting to obtain a trips. Table 10 contains information regarding the number of phone calls made and the responses to those calls. The response category descriptions can be found in Table 9.

TABLES

Table 1. Openings and closings of management units by date and regulation change from the fall 2019 season (September - November) for anchored large and small mesh gill nets for ITP Year 2020.

Year	Date(s)	Regulation change
2019	September 4	This proclamation superseded Proclamation FF-3-2016, dated January 21, 2016 and FF-48-2018, dated November 27, 2018. It closed the commercial flounder fishery to all gears in Internal Coastal Waters and to all gears except trawls in the Atlantic Ocean Waters. The commercial fishery will re-open by proclamation later in 2019. This action was being taken to comply with the requirements of Amendment 2 to the N.C. Southern Flounder Fishery Management Plan. (FF-31-2019)
2019	September 4	This proclamation superseded Proclamation M-11-2019 dated April 26, 2019. This proclamation closed all of Management Unit A to the use of gill nets with a stretched mesh length of greater than 3 ¾ inch stretched mesh (except as described in Section IV.) in accordance with Amendment 2 to the N.C. Southern Flounder Fishery Management Plan. (M-13-2019)
2019	September 4	This proclamation superseded Proclamation M-12-2019 dated June 11, 2019. This proclamation closed all Management Units south of Management Unit A to the use of gill nets with a stretched mesh length of 4 inches and greater (except as described in Section III.) in accordance Amendment 2 to the N.C. Southern Flounder Fishery Management Plan. (M-14-2019)
2019	September 15	This proclamation supersedes Proclamation M-13-2019 dated August 30, 2019. It opens the previously closed Management Unit A to the use of gill nets with stretched mesh lengths of 5 ½ inches through 6 ½ inches in accordance with Amendment 2 to the N.C. Southern Flounder Fishery Management Plan and the Sea Turtle ITP. It maintains small mesh gill net attendance requirements in the entirety of Management Unit A. (M-15-2019)
2019	September 15	This proclamation superseded Proclamation FF-31-2019, dated August 28, 2019. It established commercial flounder season dates for Internal Coastal Waters, by Flounder Management Area. It maintained a 15-inch total length minimum size limit. It maintained the regulation making it unlawful to possess flounder taken from anchored large mesh gill nets with a stretched mesh length less than 6 inches. It also made it unlawful for a commercial fishing operation to possess flounder from the Atlantic Ocean Waters taken by any method other than trawls. This action was being taken to comply with the requirements of Amendment 2 to the N.C. Southern Flounder Fishery Management Plan. (FF-34-2019)

Cont. Table 1

2019	September 30	This proclamation superseded Proclamation M-15-2019 dated September 12, 2019. It made it unlawful for Recreational Commercial Gear License holders to use gill nets with stretched mesh lengths of 5 ½ inches through 6 ½ inches. It maintained the openings in Management Unit A to the use of gill nets with stretched mesh lengths of 5 ½ inches through 6 ½ inches in accordance with Amendment 2 to the N.C. Southern Flounder Fishery Management Plan and the Sea Turtle ITP. It maintained small mesh gill net attendance requirements in the entirety of Management Unit A. (M-17-2019)
2019	October 1	This proclamation superseded Proclamation M-14-2019 dated August 30, 2019. This proclamation opened Management Units B (subunits only), C, D2 and E to the use of gill nets with a stretched mesh length of 4 inches through 6 ½ inches (except as described in Section III.) in accordance with Amendment 2 to the N.C. Southern Flounder Fishery Management Plan. (M-16-2019)
2019	October 13	This proclamation superseded Proclamation M-17-2019 dated September 27, 2019. It closed all of Management Unit A to the use of gill nets with a stretched mesh length of greater than 3 ¾ inch stretched mesh (except as described in Section IV.) in accordance with Amendment 2 to the N.C. Southern Flounder Fishery Management Plan. It maintained small mesh gill net attendance in Management Unit A. (M-20-2019)
2019	October 26	This proclamation superseded Proclamation M-16-2019 dated September 27, 2019. This proclamation closed Management Units B (subunits SGNRA 1-4, MGNRA and portions of CGNRA) and Management Unit C to the use of gill nets with a stretched mesh length of 4 inches through 6 ½ inches (except as described in Section III.). It maintained openings in Management Units D2 and E. These actions were being taken in accordance with Amendment 2 to the N.C. Southern Flounder Fishery Management Plan. (M-21-2019)
2019	November 23	This proclamation superseded Proclamation M-20-2019 dated October 10, 2019. It opened portions of Management Unit A to the use of gill nets with a stretched mesh length of 5 ½ inches through 6 ½ inches in accordance with Amendment 2 to the N. C. Southern Flounder Fishery Management Plan. It maintained attendance on small mesh nets. (M-23-2019)

Table 2. Preliminary seasonal observer coverage, fall 2019 (September - November) by management unit for anchored large mesh gill nets for ITP year 2020.

Management Unit ¹	Trips		Coverage (%)
	Preliminary Trips ²	Observed	
A	635	80	12.6
B	564	33	5.9
C	146	29	19.9
D1 ³	n/a	n/a	n/a
D2	146	11	7.5
E	345	45	13.0
Total	1,836	198	10.8

¹ Table 1 contains all of the openings and closings for each management unit

² Preliminary trips from Trip Ticket data September - November 2019

³D1 closed to large mesh for entire 2019 fall season

Table 3. Preliminary seasonal observer coverage, fall 2019 (September - November) by management unit for anchored small mesh gill nets for ITP year 2020.

Management Unit ¹	Trips		Coverage (%)
	Preliminary Trips ²	Observed	
A	343	3	0.9
B	1,071	11	1.0
C	127	3	2.4
D1	61	1	1.6
D2	228	8	3.5
E	191	19	9.9
Total	2,021	45	2.2

¹ Table 1 contains all of the openings and closings for each management unit

² Preliminary trips from Trip Ticket data September - November 2019

Table 4. Summary of observed sea turtle interactions in anchored large and small mesh gill nets from the fall 2019 season (September - November) for ITP Year 2020.

Date	Management Unit	Latitude	Longitude	Species	Disposition	Curved Carapace (mm)	
						Length	Width
10/3/2019	B	35.30813	75.58702	Unknown	alive	n/a	n/a
10/4/2019	B	35.29235	76.49730	Green	alive	272	255
10/4/2019	B	35.30377	75.5810	Green	dead	293	243
10/4/2019	B	35.30486	75.5790	Green	dead	246	212
10/8/2019	B	35.31400	76.49846	Green	alive	302	232
10/8/2019	B	35.31400	76.49631	Green	alive	274	229
10/11/2019	B	34.88595	76.40133	Green	alive	n/a	n/a
10/11/2019	B	34.88782	76.40263	Green	alive	n/a	n/a
10/11/2019	B	34.88653	76.4043	Green	alive	n/a	n/a
10/11/2019	B	34.88643	76.40437	Green	dead	n/a	n/a
10/15/2019	B	34.86201	76.38114	Green	alive	276	222
10/15/2019	B	34.86162	76.38148	Green	alive	299	234
10/15/2019	E	34.667	77.134	Green	alive	314	265
10/15/2019	B	35.19303	75.79633	Green	dead	276	251
10/15/2019	B	35.18925	75.80685	Green	dead	283	205
10/16/2019	B	35.32789	75.59853	Green	alive	298	261
10/18/2019	D2	34.68332	76.99551	Green	alive	332	288
10/29/2019	B	34.99532	76.28635	Green	alive	295	256
10/29/2019	B	34.99582	76.28541	Green	dead	295	252
10/31/2019	B	34.96300	76.27880	Green ¹	alive	275	235
11/1/2019	D2	34.68233	77.04841	Green	alive	326	280
11/1/2019	D2	34.68352	77.03974	Green	alive	298	274
11/5/2019	B	34.99495	76.28717	Green	alive	n/a	n/a
11/5/2019	B	34.99495	76.28717	Green	alive	295	240
11/12/2019	B	34.9867	76.2460	Green	alive	206	202
11/12/2019	B	34.9865	76.24610	Green	alive	n/a	n/a

¹small mesh gill-net interaction

Table 5. Summary of reported sea turtle interactions in anchored large mesh gill nets from the fall 2019 season (September - November) for ITP Year 2020.

Date	Management Unit	Latitude	Longitude	Species	Disposition	Curved Carapace (mm)	
						Length	Width
10/3/2019	E	n/a	n/a	Green	Alive	n/a	n/a

Table 6. Summary of estimated and/or observed cumulative sea turtle interactions through the fall 2019 season (September - November) by management unit for anchored large mesh gill nets for ITP Year 2020.

Management Unit	Green		Kemp's ridley		Loggerhead		Unknown	
	Alive	Dead	Alive	Dead	Alive	Dead	Alive	Dead
A	0	0	0	0	0	0	0	0
B	177.1	83	0.0	0	0	0	1	0
C	0	0	0	0	0	0	0	0
D1	0	0	0	0	0	0	0	0
D2	*3	0	0	0	0	0	0	0
E	4.1	0	0	0	0	0	0	0
Total	184.2	83	0.0	0	0	0	1	0

*Indicates observed takes

Table 7. Summary of estimated and/or observed cumulative sea turtle interactions through the fall 2019 season (September - November) by management unit for anchored small mesh gill nets for ITP Year 2020.

Management Unit	Green		Kemp's ridley		Loggerhead		Unknown	
	Alive	Dead	Alive	Dead	Alive	Dead	Alive	Dead
A	0	0	0	0	0	0	0	0
B	1*	0	0	0	0	0	0	0
C	0	0	0	0	0	0	0	0
D1	0	0	0	0	0	0	0	0
D2	0	0	0	0	0	0	0	0
E	0	0	0	0	0	0	0	0
Total	0	0	0	0	0	0	0	0

*Indicates observed takes

Table 8. Citations written by Marine Patrol for anchored large and small mesh gill nets by date and violation code during the fall 2019 season (September - November) for ITP Year 2020.

Violation		
Date	Code	Description
9/14/2019	NETG45	Set or retrieve large mesh gill nets no sooner than one hour before sunset on Monday through Thursday
9/20/2019	NETG04	Leave gill net in waters when could not be legally fished
9/23/2019	NETG04	Leave gill net in waters when could not be legally fished
9/23/2019	NETG04	Leave gill net in waters when could not be legally fished
9/23/2019	NETG03	Using gill net with improper buoys or identification
9/23/2019	NETG01	Leave gill net in coastal waters unattended
10/1/2019	NETG04	Leave gill net in waters when could not be legally fished
10/3/2019	NETG22	Improperly set gill net
10/8/2019	NETG27	Gill Net set within 50 yards from shore
10/9/2019	NETG03	Using gill net with improper buoys or identification
10/14/2019	NETG03	Using gill net with improper buoys or identification
10/14/2019	NETG02	Using gill net without buoys or identification
10/14/2019	NETG46	Set or retrieve large mesh gill nets later than one hour after sunrise on Tuesday through Friday
10/15/2019	NETG37	Leave small mesh gill nets unattended
10/18/2019	NETG46	Set or retrieve large mesh gill nets later than one hour after sunrise on Tuesday through Friday
10/19/2019	NETG02	Using gill net without buoys or identification
10/23/2019	NETG29	RCGL gear without proper buoys
10/24/2019	NETG02	Using gill net without buoys or identification
10/24/2019	NETG02	Using gill net without buoys or identification
10/28/2019	NETG22	Improperly set gill net
10/31/2019	NETG02	Using gill net without buoys or identification

Table 9. Categories and descriptions of fishermen responses for the Observer Program's contact logs used for analysis.

Categories	Category description
1	Left message with someone else
2	Not fishing general
3	Fishing other gear
4	Not fishing because of weather
5	Not fishing because of boat issues
6	Not fishing because of medical issues
7	Booked trip
8	Hung up, got angry, trip refusal
9	Call back later time/date
10	Saw in person
11	Disconnected
12	Wrong number
13	No answer
14	No answer, left voicemail
15	Not fishing because of natural disaster (e.g., hurricane)

Table 10. Contacts made (n = 436) by the observers trying to set up trips by month categorized by contact type (0-15) and by total number (a), percent for total season (b), and percent for each month (c) for the fall 2019 season (September - November) for ITP Year 2020.

	Categories ¹ (# Per Month)															Total
	1	2	3	4	5	6	7	8	9	10	11	12	13	14	15	
September	0	27	8	4	1	0	4	0	14	6	19	2	25	84	1	195
October	6	43	9	4	1	1	13	1	7	4	26	1	36	65	0	217
November	1	6	0	2	0	0	1	0	0	0	4	0	3	7	0	24
Total	7	76	17	10	2	1	18	1	21	10	49	3	64	156	1	436

	Categories ¹ (% Per Month)															Total
	1	2	3	4	5	6	7	8	9	10	11	12	13	14	15	
September	0.0	13.8	4.1	2.1	0.5	0.0	2.1	0.0	7.2	3.1	9.7	1.0	12.8	43.1	0.5	100.0
October	2.8	19.8	4.1	1.8	0.5	0.5	6.0	0.5	3.2	1.8	12.0	0.5	16.6	30.0	0.0	100.0
November	4.2	25.0	0.0	8.3	0.0	0.0	4.2	0.0	0.0	0.0	16.7	0.0	12.5	29.2	0.0	100.0
Total	1.6	17.4	3.9	2.3	0.5	0.2	4.1	0.2	4.8	2.3	11.2	0.7	14.7	35.8	0.2	100.0

	Categories ¹ (% Total Season)															Total
	1	2	3	4	5	6	7	8	9	10	11	12	13	14	15	
September	0.0	6.2	1.8	0.9	0.2	0.0	0.9	0.0	3.2	1.4	4.4	0.5	5.7	19.3	0.2	44.7
October	1.4	9.9	2.1	0.9	0.2	0.2	3.0	0.2	1.6	0.9	6.0	0.2	8.3	14.9	0.0	49.8
November	0.2	1.4	0.0	0.5	0.0	0.0	0.2	0.0	0.0	0.0	0.9	0.0	0.7	1.6	0.0	5.5
Total	1.6	17.4	3.9	2.3	0.5	0.2	4.1	0.2	4.8	2.3	11.2	0.7	14.7	35.8	0.2	100.0

¹ Contact type categories: 1) Left message with someone else 2) Not fishing general 3) Fishing other gear 4) Not fishing because of weather 5) Not fishing because of boat issues 6) Not fishing because of medical issues 7) Booked trip 8) Hung up, got angry, trip refusal 9) Call back later time/date 10) Saw in person 11) Disconnected 12) Wrong number 13) No answer 14) No answer, left voicemail 15) Not fishing because of natural disaster (e.g., hurricane)

FIGURES

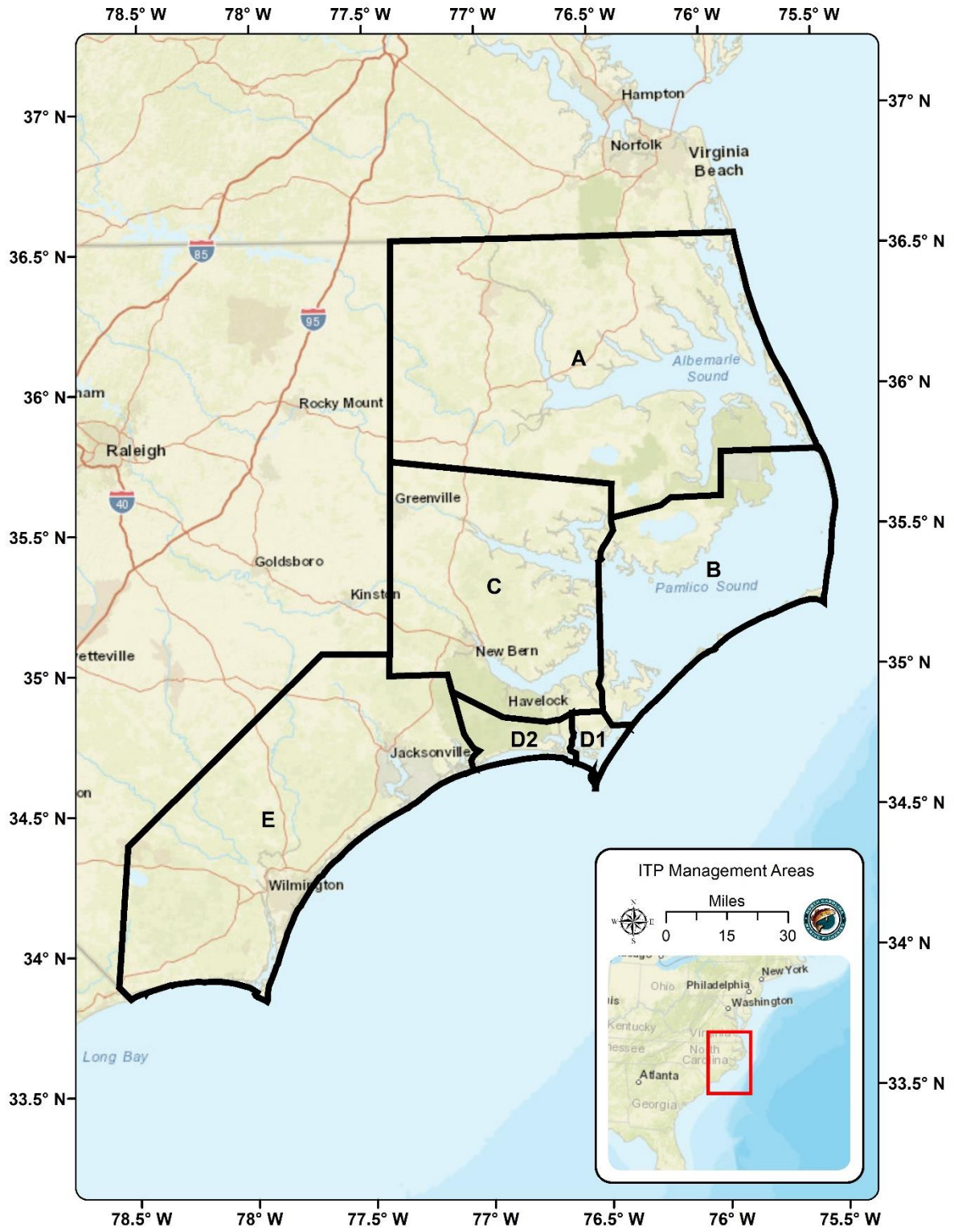


Figure 1. Map of ITP management areas.

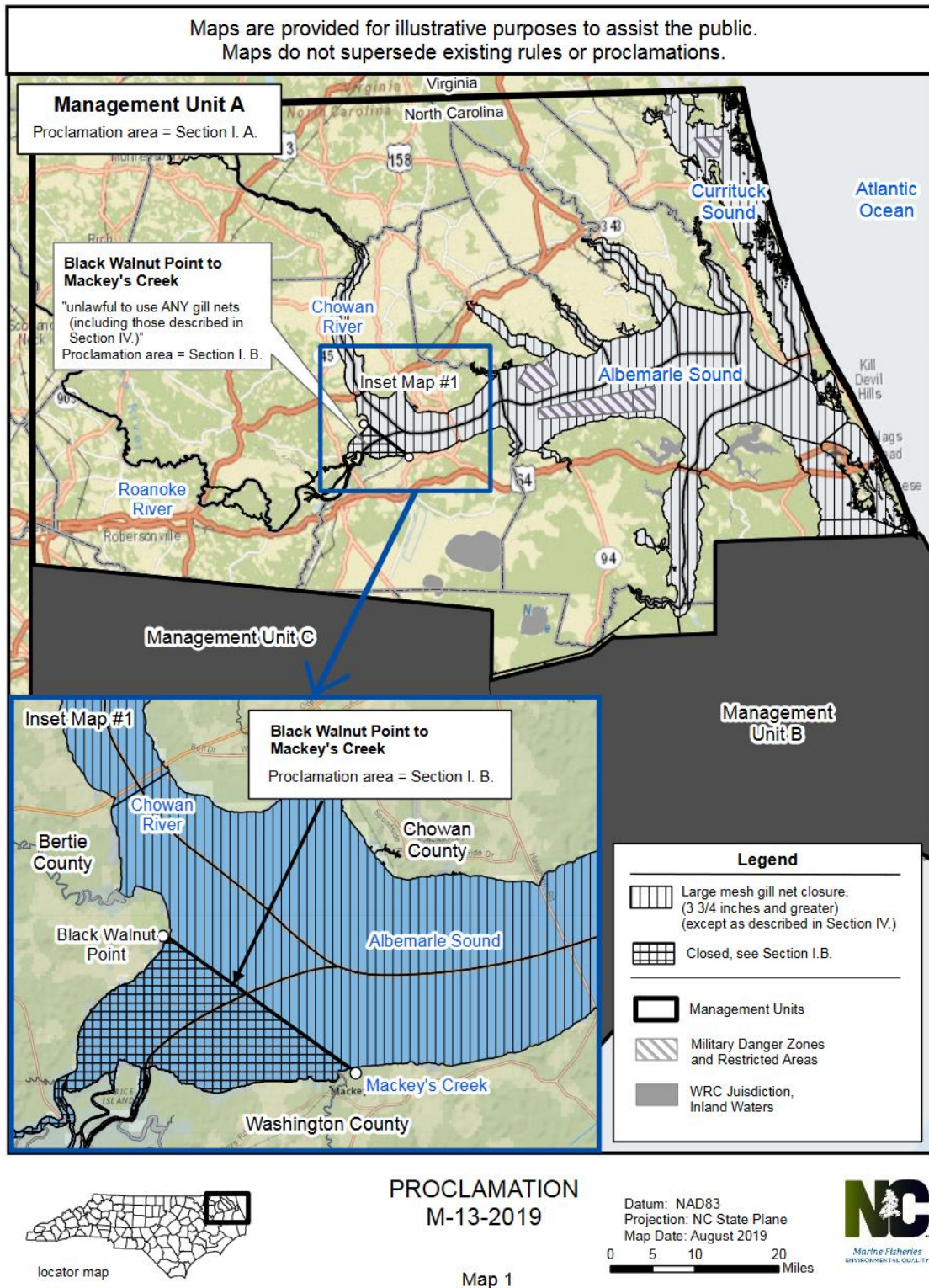
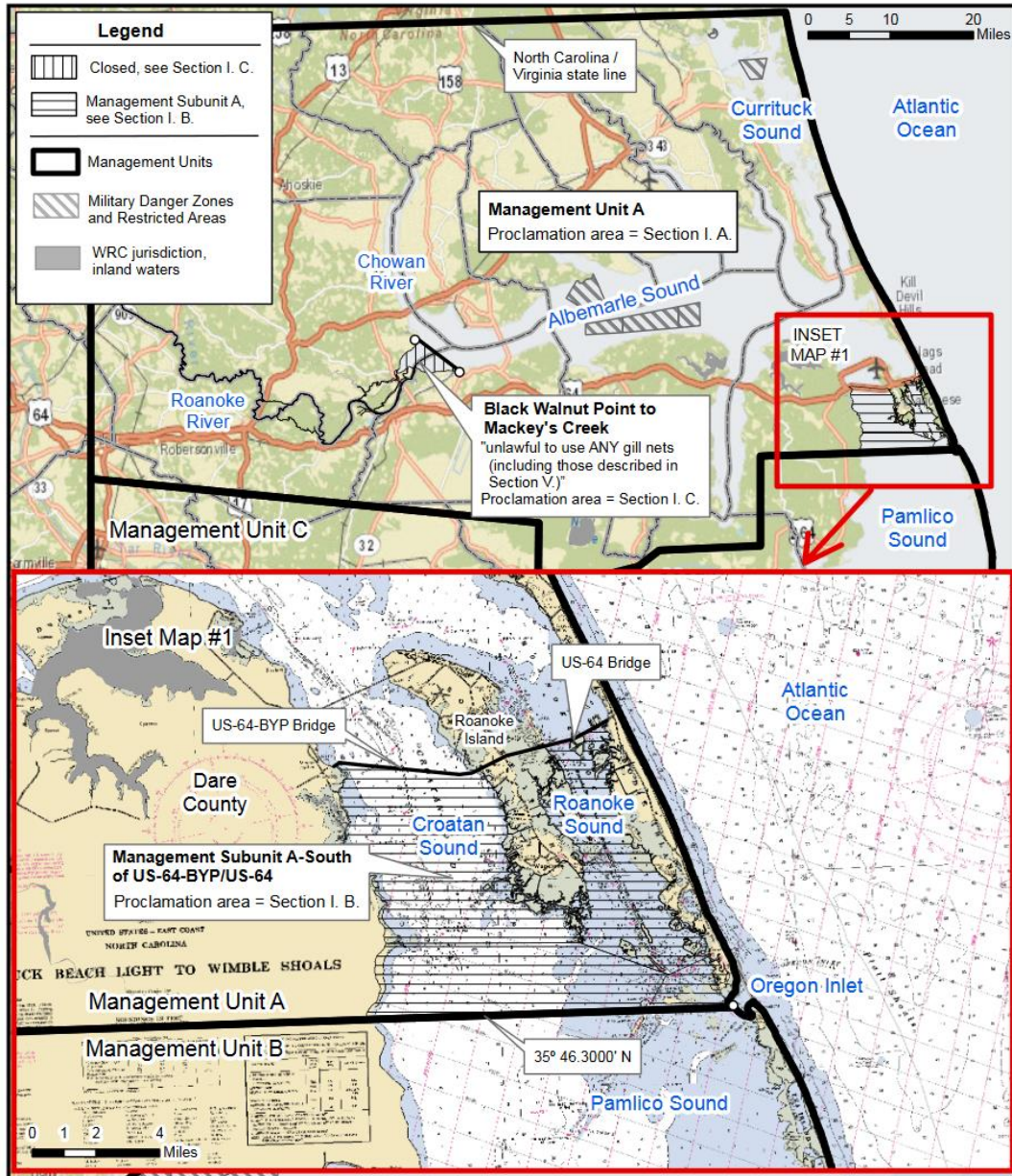


Figure 2. Map for proclamation M-13-2019. See Table 1 for full proclamation description.



PROCLAMATION
M-15-2019

Map 1

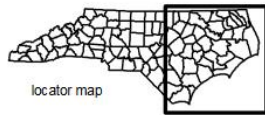
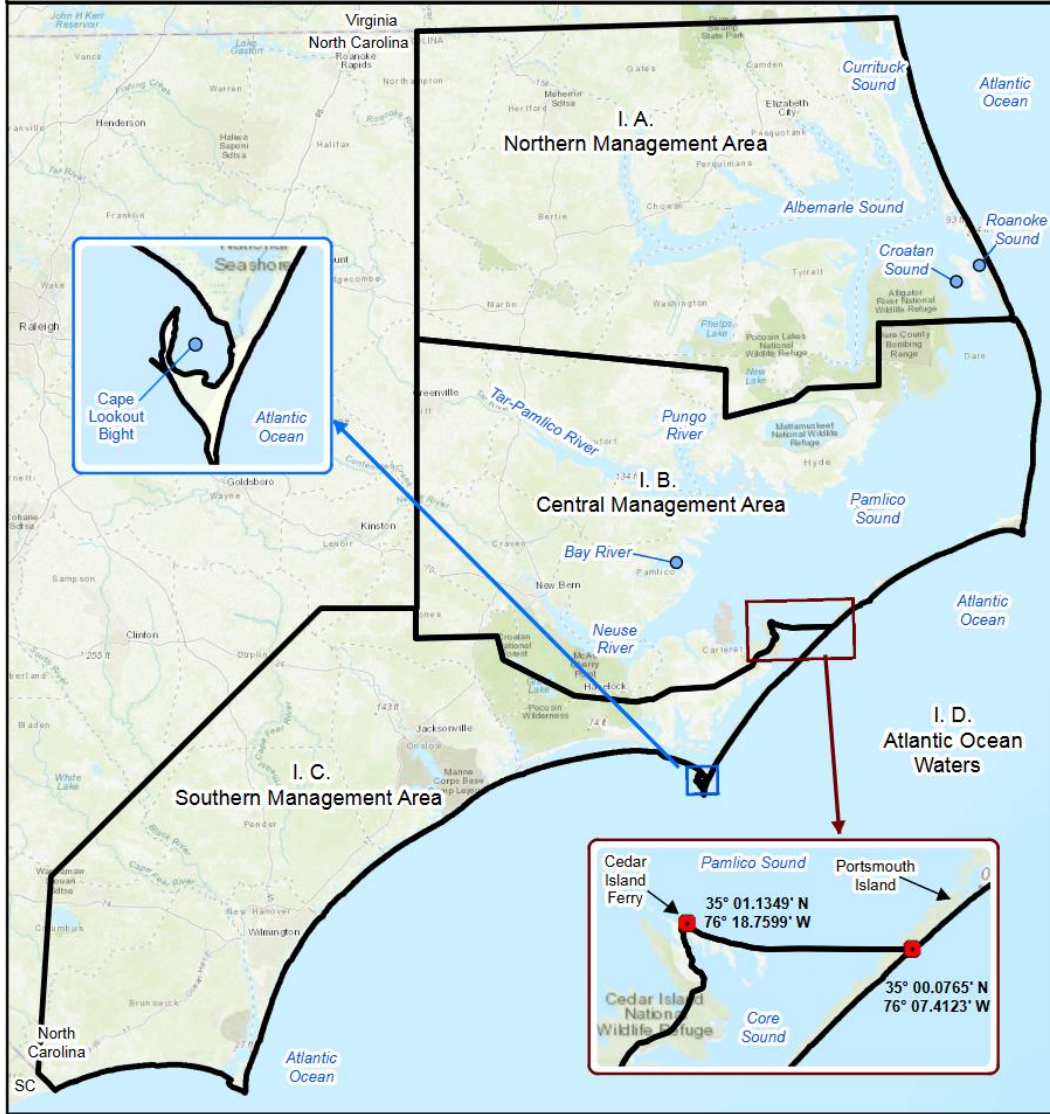


Datum: NAD83
Projection: NC State Plane
Map Date: September 2019

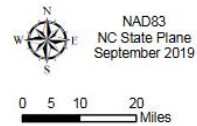


Figure 3. Map for proclamation M-15-2019. See Table 1 for full proclamation description.

Maps are provided for illustrative purposes to assist the public.
 Maps do not supersede existing rules or proclamations.



**PROCLAMATION
 FF-34-2019**



Map 1

Figure 4. Map for proclamation FF-34-2019. See Table 1 for full proclamation description.

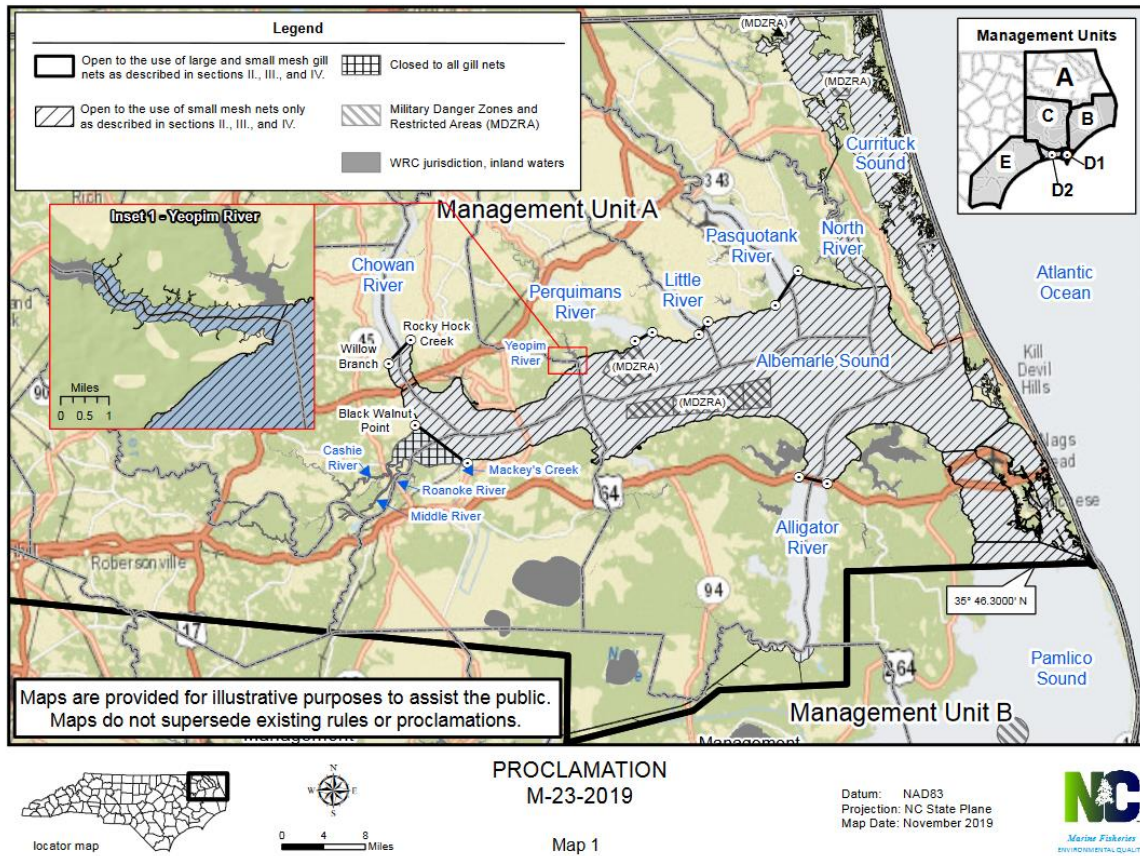


Figure 5. Map for proclamation M-23-2019. See Table 1 for full proclamation description.

Fall 2019 Sea Turtle Interactions

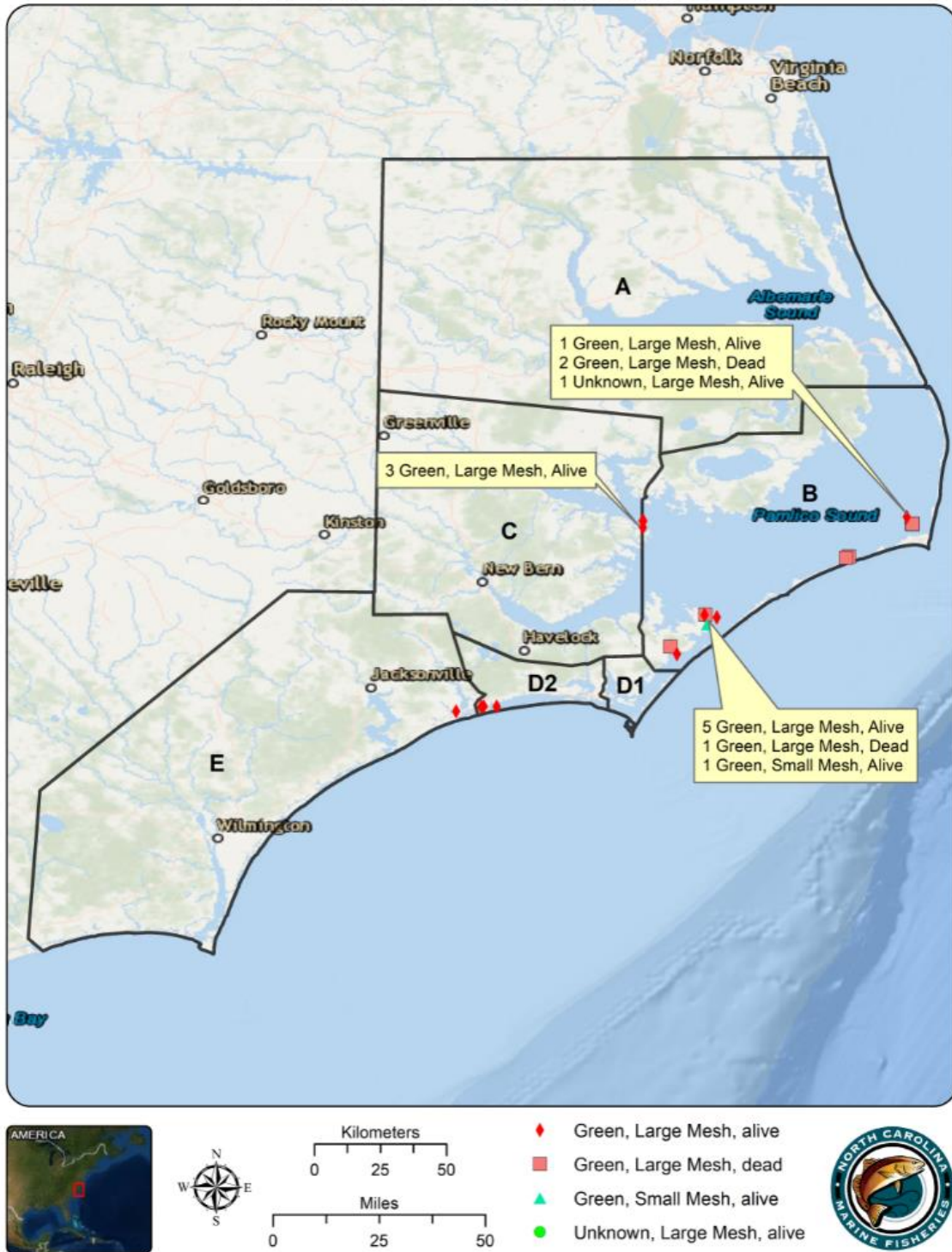


Figure 6. Map of observed sea turtle interactions in all management units (A, B, C, D1, D2, E) in anchored large mesh gill nets (n = 26) by species and disposition (alive/dead) for the 2019 fall season (September - November) for ITP Year 2020 (September 1, 2019 – August 31, 2020).



ROY COOPER
Governor

MICHAEL S. REGAN
Secretary

STEPHEN W. MURPHEY
Director

January 24, 2020

MEMORANDUM

TO: N.C. Marine Fisheries Commission
FROM: Kathy Rawls, Fisheries Management Section Chief
SUBJECT: Temporary Rule Suspension

Issue

In accordance with the North Carolina Division of Marine Fisheries Resource Management Policy Number 2014-2, Temporary Rule Suspension, the North Carolina Marine Fisheries Commission will vote on any new rule suspensions that have occurred since the last meeting of the commission.

Findings

The suspension of North Carolina Marine Fisheries Commission Rule 15A NCAC 03M .0511 Bluefish, occurred since the November 2019 meeting, is subject to commission approval and is noted as an action item on the agenda.

Action Needed

The commission is scheduled to vote on approval of the continued suspension of rule 15A NCAC 03M .0511.

Overview

The following rule suspension occurred since the November 2019 meeting, and in accordance with policy is subject to approval and is noted as an action item on the agenda:

NCMFC RULE 15A NCAC 03M .0511 Bluefish

Suspension of this rule is for an indefinite period of time. Suspension of this rule allows the division to reduce bluefish creel limits in compliance with the requirements of the Mid-Atlantic Fishery Management Council/Atlantic States Marine Fisheries Commission Bluefish Fishery Management Plan to reduce recreational harvest of bluefish. This suspension was implemented in Proclamation FF-1-2020.

Previously Suspended Rules (MFC Approved Suspensions)

In accordance with policy, the division will report current rule suspensions previously approved by the commission as non-action, items. The current rule suspensions previously approved by the commission are as follows:

NCMFC Rule 15A NCAC 03L .0103 (a)(1) Prohibited Nets, Mesh Lengths and Areas

Continued suspension of portions of this rule is for an indefinite period of time. This allows the division to adjust trawl net minimum mesh size requirements in accordance with the May 2018 Revision to Amendment 1 to the North Carolina Shrimp Fishery Management Plan. This suspension was implemented in proclamation SH-3-2019.

NCMFC 15A NCAC 03M .0516 Cobia

Continued suspension of this rule is for an indefinite period of time. This allows the division to manage the commercial and recreational cobia fisheries in accordance with management actions taken by the commission and in accordance with the Atlantic States Marine Fisheries Commission's Interstate Cobia Fishery Management Plan. This suspension was continued in Proclamation FF-52-2019.

NCMFC 15A NCAC 03J .0301 Pots

Continued suspension of portions of this rule is for an indefinite period of time. This allows the division to implement the crab pot escape ring requirements adopted by the commission in the May 2016 Revision to Amendment 2 of the North Carolina Blue Crab Fishery Management Plan. This suspension was implemented in Proclamation M-11-2016.

NCMFC Rule 15A NCAC 03L .0201 Crab Harvest Restrictions & 03L .203 Crab Dredging

Continued suspension of portions of these rules is for an indefinite period of time. This allows the division to implement the blue crab harvest restrictions adopted by the commission in the May 2016 Revision to Amendment 2 of the North Carolina Blue Crab Fishery Management Plan. These suspensions were implemented in Proclamation M-11-2016.

NCMFC Rule 15A NCAC 03J .0501 Definitions and Standards for Pound Nets and Pound Net Sets

Continued suspension of portions of this rule is for an indefinite period of time. This allows the division to increase the minimum mesh size of escape panels for flounder pound nets in accordance with Amendment 2 of the North Carolina Southern Flounder Fishery Management Plan. This suspension was implemented in Proclamation M-34-2015.

NCMFC Rule 15A NCAC 03M .0519 Shad & 03Q .0107 Special Regulations: Joint Waters

Continued suspension of portions of these rules is for an indefinite period of time. This allows the division to change the season and creel limit for American shad under the management framework of the North Carolina American Shad Sustainable Fishery Plan. These suspensions were continued in Proclamation FF-55-2019.

Red Drum Landings 2018-2020

Landings are complete through October 31, 2019.

2018 landings are final. 2019 and 2020 landings are preliminary.

Year	Month	Species	Pounds	2009-2011 Average	2013-2015 Average
2018	9	Red Drum	11,149	28,991	35,003
2018	10	Red Drum	42,805	43,644	63,662
2018	11	Red Drum	10,076	14,318	27,643
2018	12	Red Drum	2,052	3,428	2,197
2019	1	Red Drum	2,101	5,885	1,699
2019	2	Red Drum	1,952	3,448	3,996
2019	3	Red Drum	1,563	5,699	3,971
2019	4	Red Drum	5,571	7,848	6,528
2019	5	Red Drum	11,315	13,730	9,664
2019	6	Red Drum	6,259	12,681	6,985
2019	7	Red Drum	5,705	13,777	15,618
2019	8	Red Drum	5,217	21,252	15,846

Fishing Year (Sept 1, 2018 - Aug 31, 2019) Landings 105,764

Year	Month	Species	Pounds	2009-2011 Average	2013-2015 Average
2019	9	Red Drum	1,508	28,991	35,003
2019	10	Red Drum	8,090	43,644	63,662
2019	11	Red Drum	4,843	14,318	27,643 *
2019	12	Red Drum	1,413	3,428	2,197 *
2020	1	Red Drum	75	5,885	1,699 *

Fishing Year (Sept 1, 2019 - Aug 31, 2020) Landings 15,928

*partial trip ticket landings only

***landings are confidential

Year	Month	Species	Pounds	Dealers	Trips	Average (2007-2009)
2016	1	SOUTHERN FLOUNDER	2,625	33	264	7,713
2016	2	SOUTHERN FLOUNDER	1,643	31	291	4,617
2016	3	SOUTHERN FLOUNDER	9,260	58	915	23,512
2016	4	SOUTHERN FLOUNDER	10,558	72	628	68,389
2016	5	SOUTHERN FLOUNDER	24,522	90	821	122,514
2016	6	SOUTHERN FLOUNDER	44,952	100	1,242	154,090
2016	7	SOUTHERN FLOUNDER	43,574	102	1,132	170,387
2016	8	SOUTHERN FLOUNDER	53,057	106	1,409	201,862
2016	9	SOUTHERN FLOUNDER	246,269	131	3,011	396,301
2016	10	SOUTHERN FLOUNDER	280,689	117	2,181	781,717
2016	11	SOUTHERN FLOUNDER	182,768	102	1,479	392,150
2016	12	SOUTHERN FLOUNDER	14	5	5	37,303
2017	1	SOUTHERN FLOUNDER	1,677	38	122	7,713
2017	2	SOUTHERN FLOUNDER	2,758	55	215	4,617
2017	3	SOUTHERN FLOUNDER	8,254	67	874	23,512
2017	4	SOUTHERN FLOUNDER	9,591	83	787	68,389
2017	5	SOUTHERN FLOUNDER	33,105	105	1,121	122,514
2017	6	SOUTHERN FLOUNDER	74,785	115	1,904	154,090
2017	7	SOUTHERN FLOUNDER	74,879	108	1,755	170,387
2017	8	SOUTHERN FLOUNDER	102,751	116	2,364	201,862
2017	9	SOUTHERN FLOUNDER	235,915	128	2,849	396,301
2017	10	SOUTHERN FLOUNDER	548,740	142	3,971	781,717
2017	11	SOUTHERN FLOUNDER	302,286	123	2,003	392,150
2017	12	SOUTHERN FLOUNDER	166	7	8	37,303
2018	1	SOUTHERN FLOUNDER	610	14	43	7,713
2018	2	SOUTHERN FLOUNDER	1,833	34	154	4,617
2018	3	SOUTHERN FLOUNDER	2,815	43	387	23,512
2018	4	SOUTHERN FLOUNDER	8,142	74	769	68,389
2018	5	SOUTHERN FLOUNDER	18,342	90	951	122,514
2018	6	SOUTHERN FLOUNDER	42,501	105	1,407	154,090
2018	7	SOUTHERN FLOUNDER	57,273	117	1,495	170,387
2018	8	SOUTHERN FLOUNDER	72,495	121	1,916	201,862
2018	9	SOUTHERN FLOUNDER	109,125	114	1,776	396,301
2018	10	SOUTHERN FLOUNDER	363,339	109	3,062	781,717
2018	11	SOUTHERN FLOUNDER	226,832	89	1,352	392,150
2018	12	SOUTHERN FLOUNDER	471	5	5	37,303
2019	1	SOUTHERN FLOUNDER	524	25	74	7,713
2019	2	SOUTHERN FLOUNDER	558	23	69	4,617
2019	3	SOUTHERN FLOUNDER	1,412	44	216	23,512
2019	4	SOUTHERN FLOUNDER	5,966	66	448	68,389
2019	5	SOUTHERN FLOUNDER	36,010	91	1,030	122,514
2019	6	SOUTHERN FLOUNDER	60,304	108	1,431	154,090
2019	7	SOUTHERN FLOUNDER	59,191	108	1,549	170,387
2019	8	SOUTHERN FLOUNDER	95,557	109	1,776	201,862
2019	9	SOUTHERN FLOUNDER	51,734	59	551	396,301
2019	10	SOUTHERN FLOUNDER	320,914	115	2,305	781,717
2019	11	SOUTHERN FLOUNDER	151,715	45	475	392,150

*2019 data are preliminary. Data are complete through October 2019.

***data are confidential

Year	Species	Gear	Pounds	Dealers	Trips
2012	SOUTHERN FLOUNDER	GIGS	149,387	112	3,000
2012	SOUTHERN FLOUNDER	GILLNETS	879,373	168	14,713
2012	SOUTHERN FLOUNDER	OTHER	47,989	105	1,462
2012	SOUTHERN FLOUNDER	POUND NET	569,388	35	1,754
2013	SOUTHERN FLOUNDER	GIGS	118,489	101	2,408
2013	SOUTHERN FLOUNDER	GILLNETS	1,096,060	178	16,968
2013	SOUTHERN FLOUNDER	OTHER	46,953	104	2,093
2013	SOUTHERN FLOUNDER	POUND NET	924,889	41	2,112
2014	SOUTHERN FLOUNDER	GIGS	135,273	109	2,655
2014	SOUTHERN FLOUNDER	GILLNETS	659,719	145	11,779
2014	SOUTHERN FLOUNDER	OTHER	18,303	115	1,886
2014	SOUTHERN FLOUNDER	POUND NET	860,216	39	1,806
2015	SOUTHERN FLOUNDER	GIGS	130,277	92	2,616
2015	SOUTHERN FLOUNDER	GILLNETS	392,406	133	8,466
2015	SOUTHERN FLOUNDER	OTHER	12,422	102	1,002
2015	SOUTHERN FLOUNDER	POUND NET	667,847	40	1,803
2016	SOUTHERN FLOUNDER	GIGS	127,021	92	2,658
2016	SOUTHERN FLOUNDER	GILLNETS	363,699	126	8,463
2016	SOUTHERN FLOUNDER	OTHER	10,953	84	838
2016	SOUTHERN FLOUNDER	POUND NET	398,258	39	1,423
2017	SOUTHERN FLOUNDER	GIGS	136,094	90	2,752
2017	SOUTHERN FLOUNDER	GILLNETS	552,565	128	12,372
2017	SOUTHERN FLOUNDER	OTHER	8,377	90	940
2017	SOUTHERN FLOUNDER	POUND NET	697,870	45	1,912
2018	SOUTHERN FLOUNDER	GIGS	92,302	88	2,089
2018	SOUTHERN FLOUNDER	GILLNETS	364,922	122	9,124
2018	SOUTHERN FLOUNDER	OTHER	6,431	79	561
2018	SOUTHERN FLOUNDER	POUND NET	440,122	37	1,545
2019	SOUTHERN FLOUNDER	GIGS	88,460	78	1,800
2019	SOUTHERN FLOUNDER	GILLNETS	319,320	119	6,755
2019	SOUTHERN FLOUNDER	OTHER	5,621	65	365
2019	SOUTHERN FLOUNDER	POUND NET	370,484	33	1,004

*2019 data are preliminary. Data are complete through October 2019.

***data are confidential

SHELLFISH AQUACULTURE UPDATE

Study On How to Reduce User Conflict Related to Shellfish Cultivation Leases



N.C. Department of Environmental Quality, Division of Marine Fisheries
and
N.C. Marine Fisheries Commission

November 8, 2019

TABLE OF CONTENTS

- I. Introduction 3
- II. Background..... 5
 - A. North Carolina’s Shellfish Lease Program 5
 - B. Federal Permitting - U.S. Army Corps of Engineers’ Nationwide Permit 48 11
 - C. Increased Review of Shellfish Lease Applications and Resulting User Conflicts 11
 - D. Recent Increase in Legal Challenges to DMF’s Shellfish Lease Decisions 12
 - E. DMF’s Shellfish Lease Program is Under-Resourced..... 14
- III. Sources of Information Concerning User Conflicts 15
 - A. Previous Legislative Studies 15
 - 1. 2016 - Shellfish Aquaculture Plan Report..... 15
 - 2. 2018 - N.C. Strategic Plan for Shellfish Mariculture: A Vision to 2030 15
 - B. Collaboration and Public Outreach 17
 - C. User Conflict Information from Other States 18
 - 1. Leasing Authorities..... 18
 - 2. Siting Authorities..... 19
 - 3. The Permit Process 19
 - 4. Shellfish Lease Size and Acre Caps 20
 - 5. Education 20
 - D. Future Studies and Directives 21
- IV. Recommendations 22
 - A. Recommendation #1: Regulatory Reform 23
 - B. Recommendation #2: Program Evaluation 23
 - C. Recommendation #3: Collaboration 23
 - D. Recommendation #4: Resource Assessment 23

I. INTRODUCTION

The North Carolina General Assembly passed Session Law (“S.L.”) 2019-37 effective July 1, 2019. The General Assembly noted that the purpose of the bill is “to provide further support to the shellfish aquaculture industry in the State of North Carolina.”¹ Section 9 of the bill requires the North Carolina Department of Environmental Quality (“NCDEQ”), Division of Marine Fisheries (“DMF”) and the North Carolina Marine Fisheries Commission (“MFC”) to study how to reduce user conflict related to shellfish cultivation leases, and to adopt rules and reform internal operating procedures consistent with the findings of the study.

User conflicts are generally described as disagreements that arise between multiple users of areas leased for private shellfish cultivation purposes, commonly referred to as shellfish aquaculture or shellfish leases. Individuals use public trust waters in a variety of ways including navigating, swimming, hunting, fishing, and other recreational activities. The increase in coastal populations coupled with the growth of the shellfish aquaculture industry, particularly with respect to utilizing floating gear, has led to user conflicts regarding the use of coastal and estuarine waters.²

DMF and MFC address topics pertinent to user conflicts in the shellfish aquaculture industry in this study. The study also discusses the existing regulatory framework governing shellfish leases in North Carolina. DMF anticipates future amendments to shellfish lease regulations and internal changes to improve operating procedures with the objective of reducing user conflict issues. Efforts are also made to identify challenges and inefficiencies in the existing Shellfish Lease Program with suggested measures to remedy these deficiencies. The deadline for completing this study is January 1, 2020. The deadline to adopt new rules is March 1, 2021.

Some of the recommendations in this study will likely be included in future studies and directives mandated by S.L. 2019-37. These studies include:

- Shellfish Aquaculture Enterprise Areas (“SEA”) (Section 1.(a) – 1.(c));
- SEAs: Moratorium Areas (Section 1.(d));
- Pamlico Sound Shellfish Aquaculture Pilot Project (Section 2);
- Administrative Remedy for Shellfish Leasing Appeals (Sections 6.(a), 6.(b)).

DMF staff compiled information for this report from its own ongoing work, stakeholder groups, shellfish and aquaculture experts, shellfish growers, non-governmental organizations, and internal DMF shellfish staff with expertise in this area. DMF also drew upon the findings and recommendations from previous legislative studies related to shellfish leases and aquaculture. Cumulatively, the recommendations listed in this study include the provisions mandated in S.L. 2019-37, as well as considerations for enhancing existing procedures for managing the shellfish aquaculture industry and the resulting user conflicts.

¹ <https://www.ncleg.gov/EnactedLegislation/SessionLaws/PDF/2019-2020/SL2019-37.pdf>

² Overcoming Impediments to Shellfish Aquaculture through Legal Research and Outreach: Case Studies (National Oceanic and Atmospheric Administration, U.S. Department of Commerce), 2019
<http://nsglc.olemiss.edu/projects/shellfishaquaculture/index.html>

The success of shellfish aquaculture operations and the high-demand for new shellfish leases exceeds traditional DMF permitting and site selection capabilities. Achieving and sustaining a successful shellfish aquaculture industry will depend on, among other things, resolution of these user conflicts. DMF envisions approaching and addressing these issues in collaboration with multiple user groups to provide outreach and feedback to ensure shellfish aquaculture operations are consistent with sound science, public trust uses, business planning, marketing, and training. The DMF Shellfish Lease Program may not be sufficiently staffed or funded to accomplish the recommendations made in this study.

II. BACKGROUND

A. North Carolina's Shellfish Lease Program

DMF administers the Shellfish Lease Program through its Habitat and Enhancement Section. Shellfish leases using public trust bottom areas for shellfish aquaculture (in brackish and higher salinity waters) have existed in North Carolina for over 150 years. Shellfish leases are divided into two types: bottom and water column. You must have a bottom lease to have a water column lease. The water column lease can be granted over the entire footprint of a bottom lease, or on a portion of the lease. A shellfish franchise is similar to a bottom lease except that they are recognized submerged lands claims. Shellfish growers traditionally employed cultch on bottom leases or bed clams under netting. In 1989, the General Assembly expanded traditionally based growing methods by authorizing the leasing of the water column for shellfish aquaculture for areas above a shellfish bottom lease which allow for intensive gear to be used. Extensive shellfish culture means shellfish grown on the bottom without the use of cages, racks, bags, or floats. Intensive shellfish culture means shellfish grown on the bottom or in the water column using cages, racks, bags, or floats. The General Assembly amended the shellfish leasing statutes to allow the use of gear up to 18 inches off the bottom for bottom leases in 2015.³

While shellfish water column leases have been authorized since 1989, their use has only recently increased in popularity. The large growth in shellfish water column leases has increased the use of intensive gear leading to a rise in user conflicts. DMF has observed a substantial growth in submission of shellfish lease applications in the past several years with the caveat of a slight decrease in 2018 due to Hurricane Florence and Tropical Storm Michael (Table 1; Figure 1). There are eight coastal counties which have shellfish leases (Figures 2 - 4). As of October 8, 2019, there were 50 shellfish franchises, 224 shellfish bottom leases, and 88 shellfish water column leases in North Carolina covering 1,736 acres (Table 2; Figure 5). Carteret County has 127 shellfish leases, the largest of any North Carolina county (Table 2; Figure 5). Onslow County has the most acres covered by shellfish leases at 527 acres (Table 2; Figure 5). The number of shellfish lease applications in North Carolina has increased exponentially (1,491 percent) from the period of 2005 to 2011 (22 lease applications) compared to the period of 2012 to 2019 (350 lease applications). This is an increase from 2011 (two lease applications) to 2019 (106 lease applications) of 5,200 percent (Table 1; Figure 4).

By way of comparison, the Commonwealth of Virginia has a much larger shellfish lease industry, with 5,400 leases covering 122,000 acres. Currently, Virginia has hundreds of pending applications with a staff capability to process approximately 100 applications per year.

³ N.C.G.S. § 113-202(r)

Table 1. Total shellfish lease applications for bottom leases and water column leases from 2005 through 2019.

Year	Applications	
	Bottom Lease	Water Column
2005	3	1
2006	5	1
2007	3	0
2008	5	0
2009	0	0
2010	1	1
2011	1	1
2012	8	6
2013	6	10
2014	8	7
2015	9	2
2016	10	11
2017	52	46
2018	36	33
2019	58	48
Total	205	167

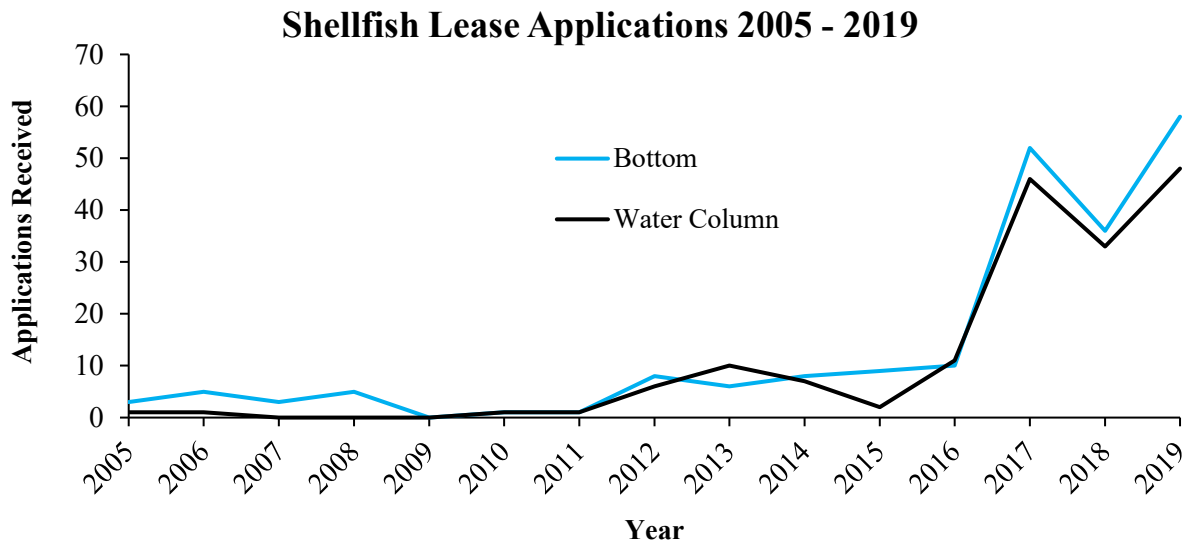


Figure 1. Total shellfish lease applications for bottom leases and water column leases from 2005 through 2019.

Table 2. Total number and acres of shellfish aquaculture leases per county and lease type sorted by total number of leases (highest to lowest).

County ¹	Bottom		Water Column		Franchise		Total	
	Number	Acres	Number	Acres	Number	Acres	Number	Acres ²
Carteret	87	318	38	98	2	2	127	417
Onslow	43	323	11	29	28	204	82	556
Pender	43	225	9	10	0	0	52	236
Hyde	26	255	11	40	9	236	46	531
Pamlico	9	52	8	48	10	71	27	171
N. Hanover	7	17	5	12	1	3	13	33
Dare	7	24	5	18	0	0	12	42
Beaufort	2	6	1	1	0	0	3	6
Total	224	1,219	88	255	50	517	362	1,736

¹ Current as of October 8, 2019

² Total only includes bottom and franchise because water column leases are over bottom lease

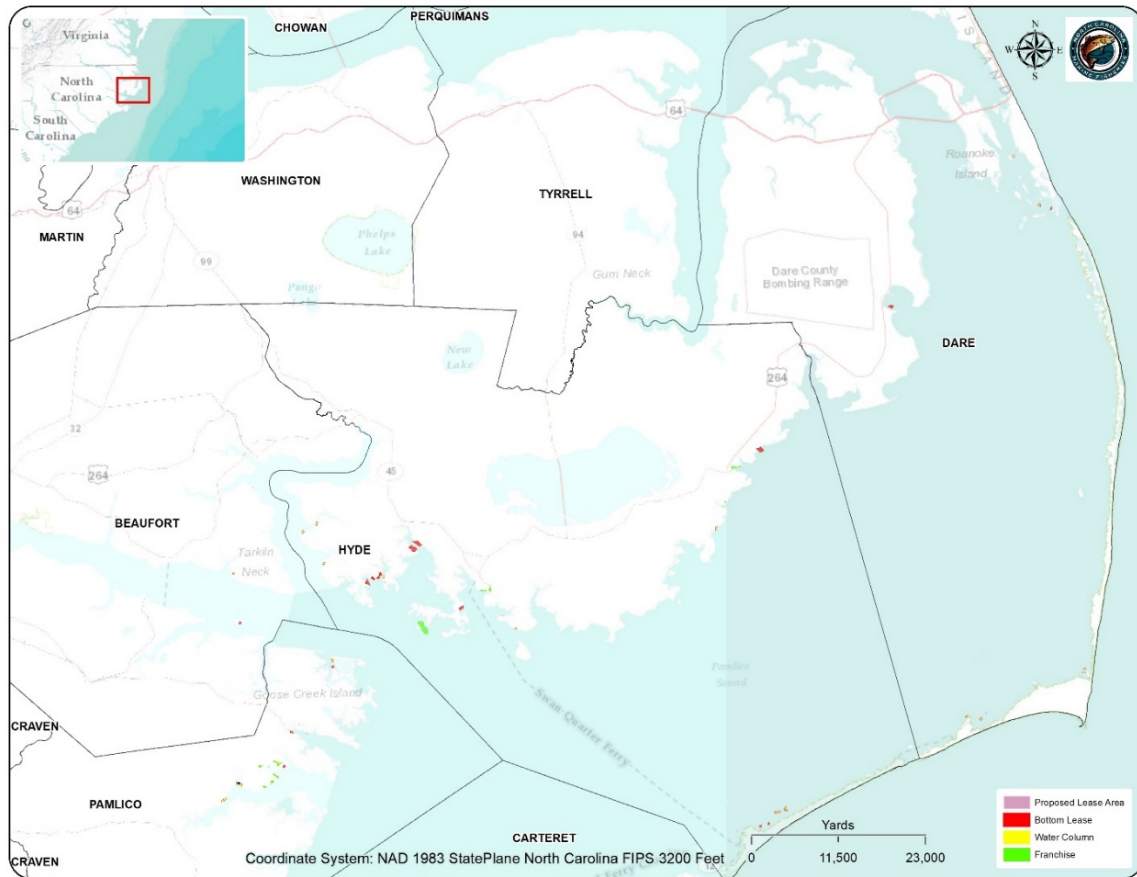


Figure 2. Active and proposed shellfish leases (bottom, water column, and franchise) in the northern region of the state.

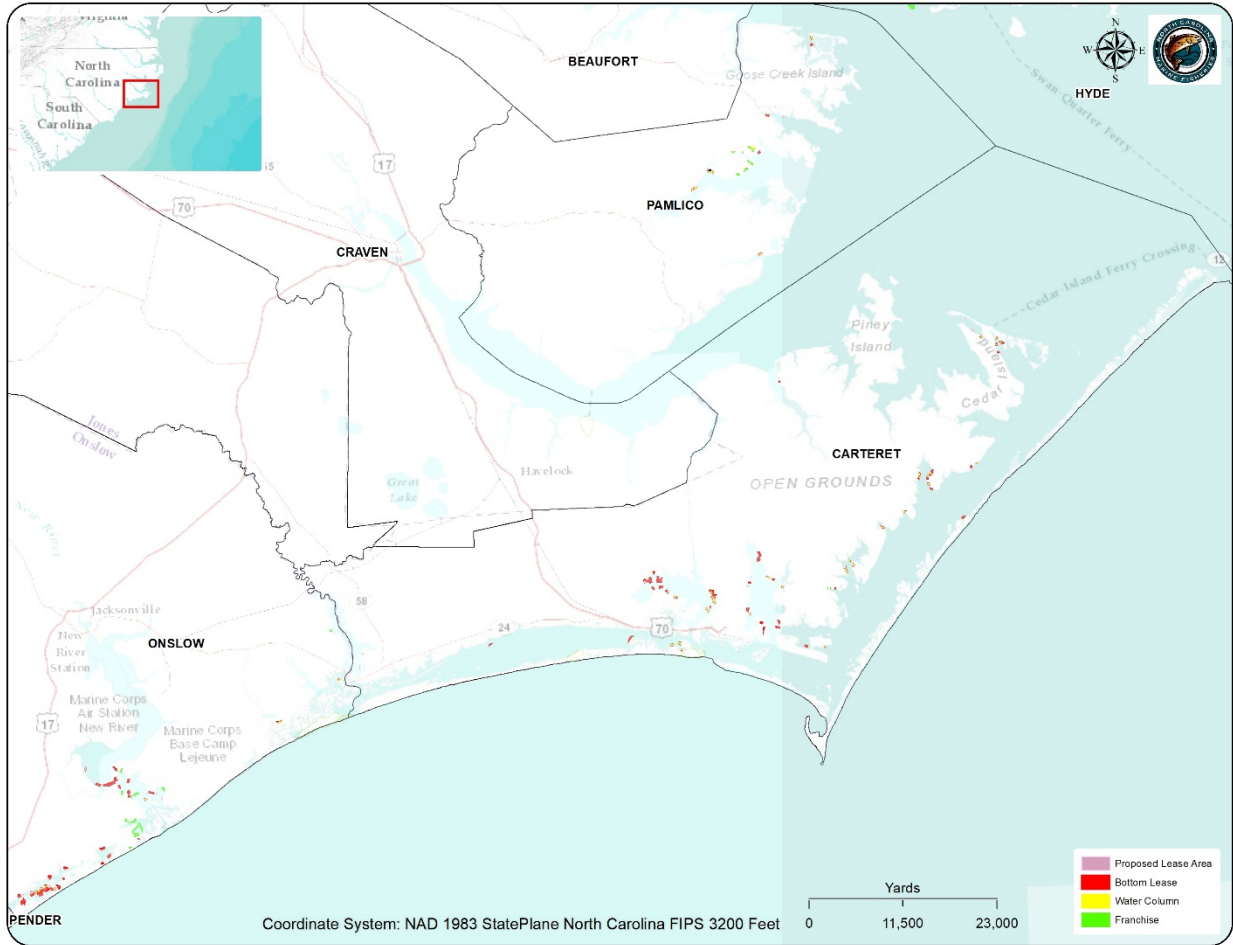


Figure 3. Active and proposed shellfish leases (bottom, water column, and franchise) in the central region of the state.

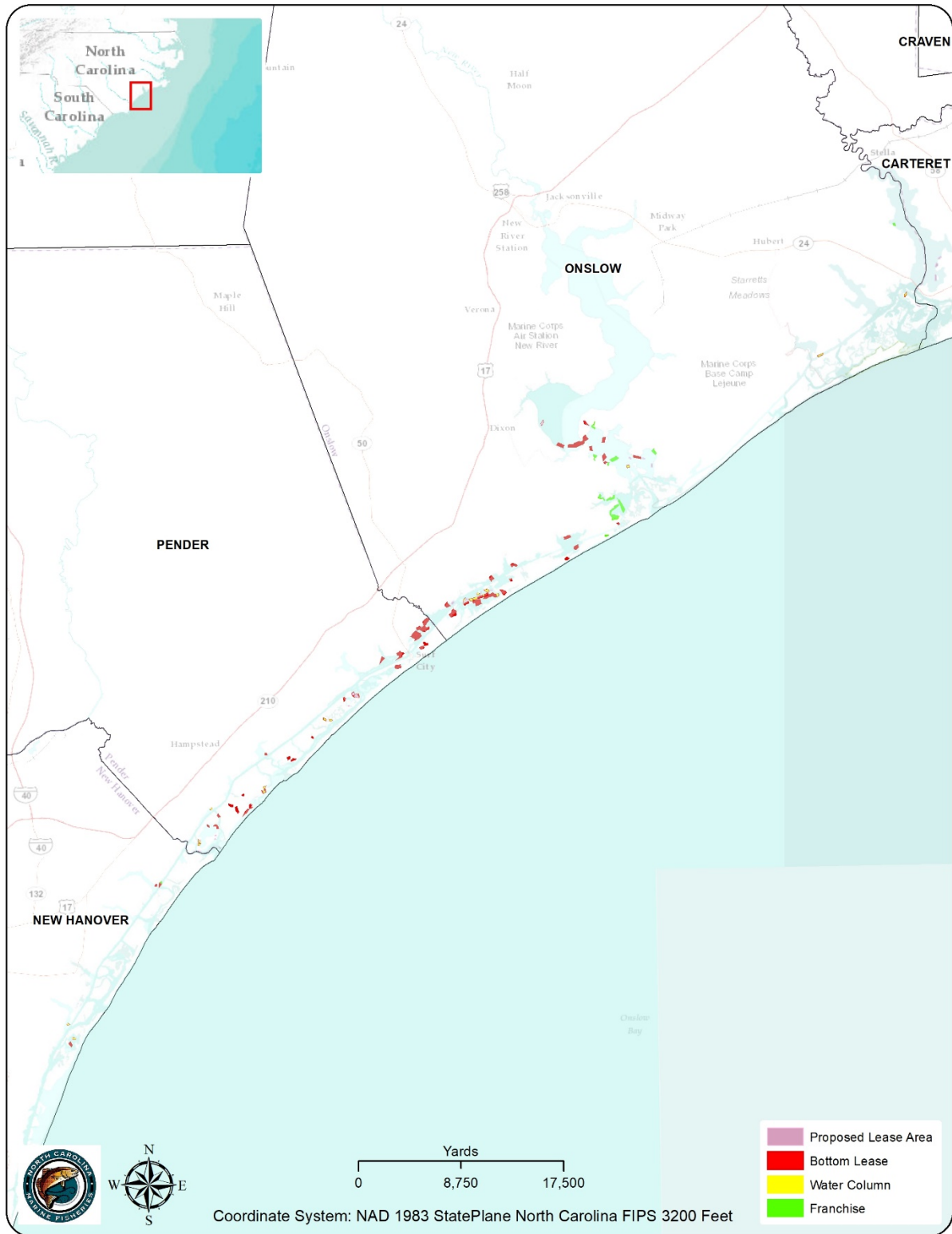


Figure 4. Active and proposed shellfish leases (bottom, water column, and franchise) in the southern region of the state.

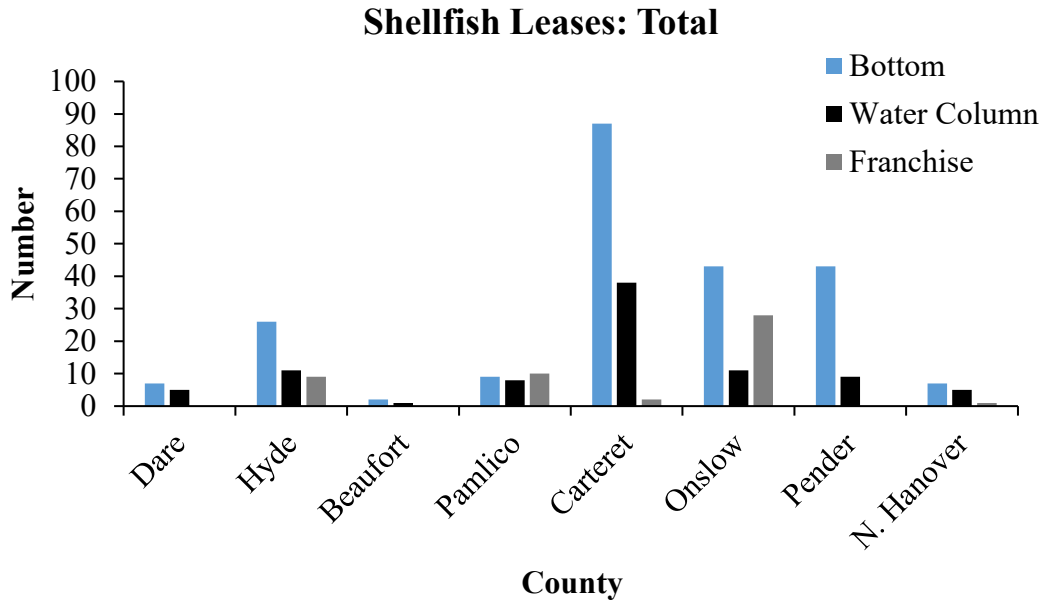


Figure 5. Total shellfish leases (bottom, water column, franchise) in North Carolina by county (north to south) and lease type.

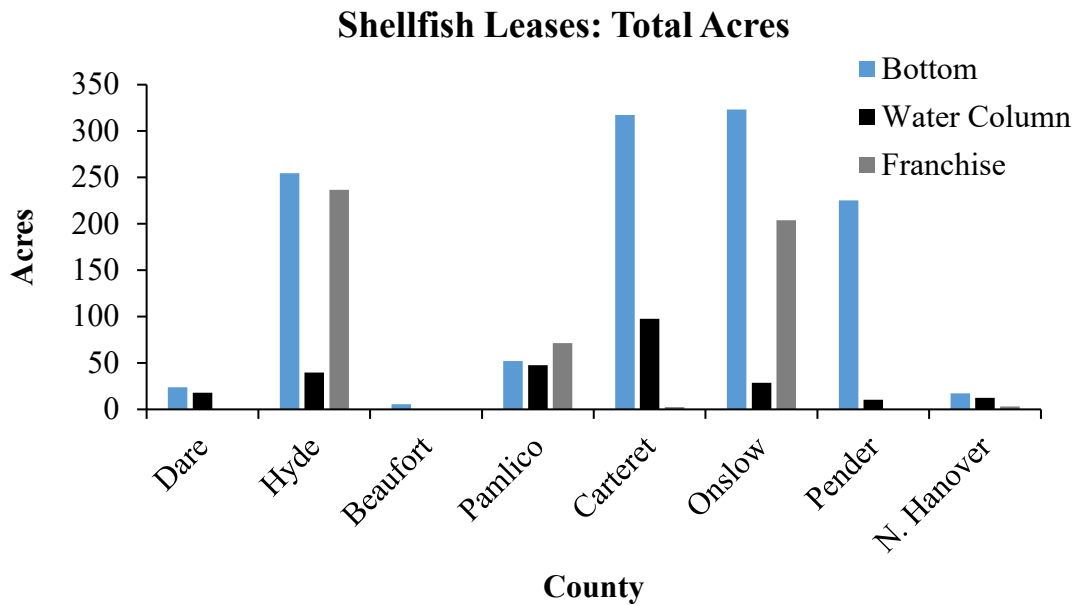


Figure 6. Total shellfish lease acres (bottom, water column, franchise) in North Carolina by county (north to south) and lease type.

DMF grants shellfish aquaculture leases in North Carolina in public trust waters. Public trust resources are land and water areas, whether publicly or privately owned, which are subject to Public Trust Rights as defined under North Carolina law. Public Trust Rights are held in trust by the state for the use and benefit of all citizens of North Carolina in common. Public Trust Rights include, but are not limited to, the right to “navigate, swim, hunt, fish, and enjoy all recreational activities in” North Carolina waters.⁴ Public Trust Rights cannot be conveyed in a manner that adversely affects public trust uses. The General Assembly charged NCDEQ with the stewardship of the public trust marine and estuarine resources of the state. The NCDEQ Secretary may delegate that authority to the DMF Director.⁵

B. Federal Permitting - U.S. Army Corps of Engineers’ Nationwide Permit 48

Permitting for shellfish aquaculture leasing is accomplished both by statute, in part under N.C.G.S. § 113-202, and through the U.S. Army Corps of Engineers’ (“USACE”) Nationwide Permit 48 (“NWP 48”) process - Commercial Shellfish Aquaculture Activities.⁶ The USACE re-issued NWP 48 in 2017. NWP 48 encompasses activities related to commercial shellfish aquaculture in waters of the United States. A recent federal court decision in the State of Washington could have an impact on future use of NWP 48 in North Carolina.⁷ NCDEQ’s Office of the General Counsel will continue to monitor the potential impacts of this decision and any related case law.

C. Increased Review of Shellfish Lease Applications and Resulting User Conflicts

A substantial increase in the number of user conflicts coincides with the recent expansion of the shellfish aquaculture industry and its use of intensive gear in water column leases (Table 2; Figure 1). The General Assembly promulgated several legislative changes affecting the Shellfish Lease Program in recent years in order to help address these conflicts.⁸ The MFC in 2018 also attempted to impose a moratorium for shellfish leases to pause processing of applications long enough to address user conflict issues related to navigation, waterbody carrying capacity, hunting, waterfront development, and applicant experience. Additionally, DMF increased its staff review of shellfish aquaculture lease applications, enlarged notice processes for public hearings on proposed leases, and directed more focus on possible conflicting uses in proposed lease areas. These efforts have resulted in more quality information, both in terms of technical facts and stakeholder opposition, reaching the DMF Director to better inform a decision on whether to grant a shellfish lease application.

The General Assembly’s legislative findings and declaration of policy for cultivation of shellfish in North Carolina states that “shellfish cultivation provides increased seafood production and long-term economic and employment opportunities” and “provides increased

⁴ N.C.G.S. § 1-45.1

⁵ N.C.G.S. § 113-131(b)

⁶ Nationwide Permit 48 - Commercial Shellfish Aquaculture Activities Effective Date: March 19, 2017; Expiration Date: March 18, 2022 (NWP Final Notice, 82 FR 1860)

⁷ The Coalition to Protect Puget Sound Habitat v. U.S. Army Corps of Engineers et al., No. 17-1209RSL, 2019 WL 5103309 (W.D. Wash. Oct. 10, 2019)

⁸ S.L. 2015-263; S.L. 2017-190; S.L. 2019-37

ecological benefits to the estuarine environment . . .”⁹ Further, to enhance shellfish cultivation, the policy of the State is to encourage the development of private, commercial shellfish cultivation in ways that are compatible with other public uses of marine and estuarine resources such as navigation, fishing, and recreation.¹⁰ Enhancing private shellfish cultivation includes granting shellfish cultivation leases that benefit the public interest.¹¹ Minimum standards for compatibility are provided to discern suitable areas for shellfish cultivation based on numerous factors, including but not limited to water quality, ability to cultivate shellfish, existing shellfish resources on the proposed lease, and other public trust uses in the area.¹² Shellfish aquaculture leases can often conflict with public trust uses, which makes balancing these issues and determining compatibility challenging and somewhat subjective.

D. Recent Increase in Legal Challenges to DMF’s Shellfish Lease Decisions

User conflict issues have resulted in an increase in contested cases filed by potentially aggrieved petitioners in the N.C. Office of Administrative Hearings (“OAH”), as well as other legal challenges. The N.C. Department of Justice represents DMF in defending DMF’s shellfish leasing decisions. Many user conflict cases brought by riparian owners adjacent to lease locations seem to be driven by a concern for impairment of view, also known as “viewshed.” Viewshed generally means the natural environment that can be seen from nearby riparian property. Viewshed is not a public trust right traditionally acknowledged under North Carolina common law. Discussion of several recent cases may be helpful in understanding user conflict concerns.

In 2016, a petitioner in Pender County challenged DMF’s denial of a bottom lease and associated water column lease based on findings by DMF that public trust user conflicts would result.¹³ The Administrative Law Judge’s (“ALJ”) decision states:

At issue in this particular contested case is whether or not the proposed shellfish lease is ‘compatible’ with the other uses of the area for navigation, fishing and recreation. Neither the general statutes nor associated Marine Fisheries Commission regulations define or indicate how much use within a proposed lease site must be present in order for the lease to warrant denial as being incompatible with those public uses. There is no definition to define what constitutes the area of the lease, or how it might actually impact navigation, fishing or recreational use. The evidence shows that certain areas close to the proposed site are more heavily used than the exact footprint of the proposed lease site. Fact that there is heavy traffic nearby the proposed lease does NOT necessarily make that area inappropriate for leasing . . . The law does not require an area to be traffic free to be approvable because it would not make any sense and would be an almost impossible requirement to meet. It is the policy of the State of North Carolina to encourage the development of private and commercial shellfish cultivation so long

⁹ N.C.G.S. § 113-201(a)

¹⁰ N.C.G.S. § 1-45.1

¹¹ N.C.G.S. § 113-202(a)

¹² *Id.*

¹³ Ronald Sheffield v. NCDEQ/DMF, 16 EHR 02397 (Pender County)

as it is done in a manner compatible with other public uses of the marine and estuarine resources.¹⁴

Ultimately, the ALJ overturned DMF's denial of the lease application. DMF contemplated appealing the decision to Superior Court, but after further consideration simply decided to issue the lease.

A second contested case was filed in 2018 by a Homeowner's Association ("HOA") located along a nearby shoreline. The appeal challenged DMF's issuance of a shellfish bottom lease and associated water column lease. The HOA alleged public trust user conflicts, though much of the witness testimony indicated that "viewshed" was the significant concern for the HOA's members. The ALJ noted that "[o]ne minimum statutory criteria of particular relevance to this case is that '[c]ultivation of shellfish in the leased area will be compatible with lawful utilization by the public of other marine and estuarine resources.'" ¹⁵ The ALJ went on to state that:

[t]he proper interpretation of a law or rule is a question of law, and an agency interpretation of a statute or rule is not binding on the undersigned. Nevertheless: It is a tenet of statutory construction that a reviewing court should defer to the agency's interpretation of a statute it administers 'so [] long as the agency's interpretation is reasonable and based on a permissible construction of the statute. The phrase 'compatible with' under N.C.G.S. § 113-202(a)(3) is not further defined by statute or regulation.' DMF does not interpret this standard to mean there can be no impact to other public uses. Instead, DMF interprets this minimum standard to mean that existing uses must be able to exist along with the shellfish lease within the general area at the same time.

Ultimately, in upholding DMF's granting of the shellfish lease, the ALJ stated "that DMF's interpretation of the phrase 'compatible with' is reasonable, is consistent with, and supported by the plain language of the statute and statutory framework." The ALJ then went further, finding that "[e]ven in the absence of deference, the undersigned independently adopts DMF's interpretation of this minimum standard. The DMF does not consider impacts on viewshed as a basis for denying a shellfish lease, as this is not a criterion in the relevant statutes or rules pertaining to shellfish leases."¹⁶

A group of riparian owners brought suit in OAH challenging a shellfish bottom lease and water column lease granted in Myrtle Grove Sound in 2018. The owners claimed the action was brought to "protect the right to a view they are entitled to as a result of their riparian property ownership."¹⁷ The complaint stated, among other things, that "[o]peration of the commercial shellfish cultivation in the area . . . also has caused significant deterioration in Plaintiffs' water

¹⁴ Ronald Sheffield v. NCDEQ/DMF, 16 EHR 02397 (Pender County)

¹⁵ 8.5 Marina Village John F Matthews VP v. NCDEQ and Samuel G. Boyd, 17 EHR 01382 (Carteret County)

¹⁶ Id.

¹⁷ Hormoze Goudarzi and wife, Suzanne Gourdarzi, Oak Forest Properties, LLC, Billy King and Barbara King v. NCDEQ et al., 18 CVS 1470 (New Hanover Superior Court)

views, resulting in substantial devaluation of Plaintiffs' properties."¹⁸ Ultimately, the dispute was resolved based on an unrelated submerged lands claim issue. As part of the case disposition, the grantee of the previously approved shellfish lease moved his operation to a newly approved lease area in Pender County.

Three additional petitions for contested cases were filed challenging the approval of two shellfish bottom leases and associated water column leases located near each other in Myrtle Grove Sound in 2019. The Petitioners claimed "the leases are incompatible with lawful utilization by the public of other marine and estuarine resources" and that "the right of the public to utilize marine and estuarine resources includes the right to view and enjoy species . . . whose habitat Petitioners believe may be threatened by operation of the shellfish leases."¹⁹ These cases were resolved by virtue of the New Hanover moratorium area established by S.L. 2019-37, Section 7, that went into effect July 1, 2019.

E. DMF's Shellfish Lease Program is Under-Resourced

North Carolina's shellfish aquaculture leasing program is implemented by DMF's Shellfish Lease Program which is currently staff and resources limited. A significantly increasing volume of work may require additional resources. By comparison, other states shellfish aquaculture programs have significant staff and operation funds for administration.

Virginia's shellfish lease program is staffed by eight dedicated employees, including two managers, one mapper and draftsman, one clerical position and four surveyors. The State of Maine has substantially fewer shellfish leases and acreage than North Carolina but has over six full time positions dedicated to administering its shellfish lease program. The State of Maryland has eight full time positions dedicated to administering its program. DMF believes the Shellfish Lease Program's small staff and low budget significantly inhibits the industry by increasing the time needed to evaluate whether to grant a lease or defend lease decision appeals. DMF staff believes this delay will be further exacerbated by the mandated but unfunded future studies and directives from the General Assembly in S.L. 2019-37.

¹⁸ Hormoze Goudarzi and wife, Suzanne Gourdarzi, Oak Forest Properties, LLC, Billy King and Barbara King v. NCDEQ et al., 18 CVS 1470 (New Hanover Superior Court)

¹⁹ Masonboro Island Club and Gary W. Ahlberg v. NCDEQ/DME, 19 EHR 00991; Sandra A. Fisher v. NCDEQ/DME, 19 EHR 00983; John A. Marriott v. NCDEQ/DME, 19 EHR 01057; The Tides Homeowners Association, Inc. v. NCDEQ/DME, 19 EHR 01055 (New Hanover County)

III. SOURCES OF INFORMATION CONCERNING USER CONFLICTS

A. Previous Legislative Studies

There have been previous legislative studies concerning shellfish aquaculture over the past few years in North Carolina. Each study has included recommendations for increased resources and positions, regulatory reform, program evaluations, and collaboration. While previous recommendations have been considered, many have not yet been adopted. Details of each report are outlined below.

1. 2016 - Shellfish Aquaculture Plan Report²⁰

The legislatively mandated 2016 Shellfish Aquaculture Plan Report recommended funding four full-time positions and recurring resources to adequately operate the Shellfish Lease Program. The report also included recommendations to form a taskforce comprised of diverse stakeholder and experts from industry, academia, and state agencies in order to develop a comprehensive North Carolina Shellfish Aquaculture Plan. Other recommendations from the report included:

- In partnership with N.C. Sea Grant (“NCSG”), develop a detailed proposal for a Shellfish Propagation and Aquaculture Training Program to be enacted with NCSG;
- Modify the initial shellfish bottom lease application fee from \$200 to \$400, which is non-refundable, to help offset the cost of lease administration, mapping and marking;
- Change statutes to allow rent, renewal and production notices to be mailed to lease holders in mid-April to allow previous year production reporting in the division trip ticket program to be finalized. Allow older leases expiring in April to be extended until June 30 to bring all shellfish leases into the same renewal period;
- To simplify the application process for shellfish growers, develop one application and combine the aquaculture permits and package with a shellfish lease;
- Strengthen statutes to increase the penalties for theft on shellfish leases;
- Policy and statutory changes needed to support the recommendations.

2. 2018 - N.C. Strategic Plan for Shellfish Mariculture: A Vision to 2030²¹

The North Carolina Policy Collaboratory (“Collaboratory”) was directed to convene stakeholder meetings in 2016 aimed at advancing efforts to bolster and promote North Carolina’s shellfish industry.²² Legislation was amended, adding a mandate for the Collaboratory to prepare a Shellfish Aquaculture Plan by December 31, 2018.²³ To fulfill the mandates laid out in Senate Bill 257, the Collaboratory formed the Shellfish Mariculture Advisory Committee (“SMAC”) to generate a report of findings and recommendations to the General Assembly. The final report was submitted on December 30, 2018.²⁴

²⁰ https://ncseagrant.ncsu.edu/ncseagrant_docs/oysters/DEQ%202016%20Shellfish%20Aquaculture%20Plan%20Report.pdf

²¹ <https://collaboratory.unc.edu/files/2019/01/NC-Strategic-Plan-for-Shellfish-Mariculture-Final-2018.pdf>

²² S.L. 2016-94, Section 14.11.(d)

²³ Senate Bill 257, Section 13.13.(b)

²⁴ North Carolina Strategic Plan for Shellfish Mariculture: A Vision to 2030 (Drs. Joel Fodrie, Charles Peterson, Christine Voss, and Christopher Baillie on behalf of the North Carolina Shellfish Mariculture Advisory Committee)

The SMAC's principal goal was to leverage a broad base of expertise to create a comprehensive plan for the shellfish aquaculture industry while balancing the needs of other citizens of North Carolina who utilize the public trust resources of the coast. The recommendations generated were intended to inform the General Assembly on possible legislative actions that could address many of the current user conflict issues in the industry. The report detailed 21 recommendations including, among others:

- Vision for industry development - Achieve \$100 million annual shellfish mariculture value (\$33 million dockside sales) by 2030;
- Appropriate recurring funding to establish a new section, the Shellfish Leasing Section, at the DMF. Defraying costs of Shellfish Leasing Section: Increase non-refundable shellfish lease application filing fee to \$500 dollars; establish a fee schedule for lease surveys payable to the DMF; shift financial responsibility for advertising for public scoping from agency to the applicant; and increase annual rent;
- Statutory changes - Amend North Carolina General Statute §113-202 to afford the Secretary of the NCDEQ substantial discretion in balancing public trust uses;
- The DMF should designate appropriate tracts as SEAs containing multiple, connected parcels available for shellfish mariculture and managed by the DMF;
- In Pamlico Sound, the Secretary of the NCDEQ should be granted discretion to grant up to three (total) 50-acre (each contiguous) water column or bottom leases, each obtained by a single lease application. These lease tracts must be separated from each other, and from shore, by at least 250 yards. Otherwise, current lease size maximums, including overall acreage possession limits for any single entity, should be retained throughout the state, and no more than three large water column or bottom leases may be established in Pamlico Sound until 2025;
- Increase utilization requirement and strictly monitor and enforce "use it or lose it" policy for shellfish leases;
- Institute higher minimum fines and mandatory restitution for those convicted of stealing or damaging property on shellfish leases. Elevate charges for theft from any contained culture (e.g. cages, bags) or free-on-bottom operation (including clams under netting) to a felony with a minimum fine of \$2,500 and mandatory restitution to the property owner. For those convicted who hold a commercial license, first offenses will result in a one-year loss of license, and second offenses will result in a permanent loss of license;
- Amend North Carolina General Statute §113-203 to allow nursery of shellfish in waters classified as prohibited.

The report addressed the need for further understanding of the ecological and societal implications of shellfish aquaculture which hinder the ability of government agencies to determine where shellfish aquaculture is most suitable. The report explains the need for regionally specific information on social carrying capacity of shellfish aquaculture and other tools to minimize user conflict. While research into the social effects of the expanding shellfish aquaculture industry cannot ensure there will be no user conflict issues, these inquiries can facilitate a better understanding of user conflicts and stakeholder perceptions which ultimately inform lawmakers on future legislation and policy.

Research efforts can help identify social sustainability and conflict resolution approaches that will be important to developing an overall understanding of the relationship of the shellfish aquaculture industry and the surrounding coastal communities. Social carrying capacity is inherently location specific and the amount of shellfish aquaculture that is socially acceptable within an area will vary among regions of the coast.

Another recommendation from the report included appropriate funding and positions for the Shellfish Lease Program. The report recommended recurring funding for three additional full-time equivalent positions for the Shellfish Lease Program. Additionally, the recommendation included increased recurring appropriations to the DMF for the purposes of administering shellfish leasing. The report concluded that additional positions will provide much needed assistance with field operations (e.g. mapping, sampling, and marking leases), a need that will continue to increase as the industry grows and as DMF develops and manages SEAs.

B. Collaboration and Public Outreach

DMF staff has collaborated closely with local stakeholders to help identify and address user conflicts, most recently through the 2018 SMAC process discussed above. DMF has also been working to address user conflict issues with the National Ocean and Atmospheric Administration - National Centers for Coastal Ocean Science specifically on the Bogue Sound Pilot Study which was completed this year. The result of this partnership was a spatial analysis tool and random sampling grids tool used for shellfish lease siting. The Shellfish Lease Program meets with internal DMF reviewers to ensure the lease review process is thorough and efficient. In 2015, DMF also began coordinating with the North Carolina Division of Coastal Management (“DCM”) as a review and commenting agency for shellfish lease applications, based on their expertise with user conflicts in coastal development. Finally, DMF collaborated with the USACE on the 2017 update of the NWP 48.²⁵

The University of North Carolina Wilmington (“UNCW”) created a tool in 2014 to assist new or current shellfish growers in siting areas for shellfish leases.²⁶ The online tool maintained by UNCW is designed as an interactive decision-support tool to provide information on site suitability when determining potential areas for shellfish leases. The data provided by the tool include salinity, depth, shellfish growing area classifications, boat access areas, surrounding land cover, and current shellfish aquaculture operations.

Public outreach takes place in a variety of ways including numerous presentations to local municipalities, educational institutions, and professional conferences to better inform stakeholder groups and interested parties about the Shellfish Lease Program. For example, DMF is currently collaborating with NCSG and the North Carolina Shellfish Growers Association on regional shellfish aquaculture workshops scheduled for December 3-5, 2019. These workshops are intended to solicit input from shellfish growers about their experiences including user conflicts issues.

²⁵ Nationwide Permit 48 - Commercial Shellfish Aquaculture Activities. Effective Date: March 19, 2017; Expiration Date: March 18, 2022. (NWP Final Notice, 82 FR 1860)

²⁶ <https://uncw.edu/benthic/sitingtool/>

DMF staff have also been working on new web-based solutions to more widely inform the public, shellfish growers, potential shellfish lease applicants, and other stakeholders about pending shellfish lease applications to allow for a more robust notification and comment process. DMF staff implemented new temporary marking requirements for proposed shellfish leases to increase visibility to ensure better notification to other area public trust users. DMF staff found that notification efforts beyond those required by the shellfish lease law were helpful in getting more information regarding objections and concerns to property owners and user groups near a proposed lease. Feedback, in turn, provides additional information for the DMF Director to consider as part of a shellfish lease decision.

C. User Conflict Information from Other States

Although the concept of public trust waters somewhat differs among states, the larger user conflict issues created by shellfish aquaculture seems to remain constant. Like North Carolina, most other states which permit shellfish aquaculture require that those operations not unreasonably interfere with other public trust uses. The National Sea Grant College Program in 2019 produced several case studies concerning impediments to shellfish aquaculture across the country.²⁷ DMF looks forward to examining these recent studies to determine if there are approaches and lessons learned elsewhere that could be applied in North Carolina.

1. Leasing Authorities

The leasing of public waters for aquaculture goes through an established public process in all states.²⁸ This public process ensures that concerned stakeholders receive both sufficient notification of proposed leases and an opportunity to raise and address their concerns publicly, though the specifics of these processes vary among states. There are various governmental frameworks among states created to manage the shellfish aquaculture industry. Some states have treated shellfish aquaculture as a form of agriculture, while other states include shellfish aquaculture in agencies managing natural resources.

Numerous states, including Florida, Maine, Maryland, New Jersey, and the Commonwealth of Virginia, have established aquaculture advisory councils which provide managers expert guidance through the council membership. In most states, shellfish applications are processed and decided by the same state-level agency, though Massachusetts and New York make lease decisions at the local level. For example, oyster aquaculture in New York is only approved on private lands or on submerged lands granted by the state to local municipalities which are then charged with developing and managing leasing programs. Similarly, in Massachusetts the city council or mayor of each municipality has authority to issue shellfish aquaculture licenses (or leases). While the aquaculture lease decisions in New York and Massachusetts are made by local

²⁷ Overcoming Impediments to Shellfish Aquaculture through Legal Research and Outreach: Case Studies (National Oceanic and Atmospheric Administration, U.S. Department of Commerce), 2019

²⁸ http://www.ct.gov/deep/cwp/view.asp?a=2705&q=431902&depNav_GID=1622; <https://www.freshfromflorida.com/Divisions-Offices/Aquaculture>; <https://www.maine.gov/dmr/aquaculture>; <http://dnr.maryland.gov/fisheries/pages/aquaculture/index.aspx>; <https://www.capecodextension.org/marine/semac/>; https://www.nj.gov/dep/fgw/pdf/marine/shellfish_leasing_policy_atlantic.pdf; http://assembly.state.ny.us/leg/?default_fld=&bn=A07120&term=2011&Summary=Y&Actions=Y&Votes=Y&Memo=Y&Text=Y; <http://www.shellfishri.com/ri-shellfish-initiative/>; http://www.mrc.state.va.us/Shellfish_Aquaculture.shtm

municipalities, state and federal statutory requirements are still a large component in determining the policy affecting the industry participants.²⁹

2. Siting Authorities

Siting authorities review proposed lease sites and are tasked with addressing and balancing potential conflicts during the shellfish aquaculture lease application review process.³⁰ Florida, Maryland, New Jersey, and Virginia manage siting bodies that, when reviewing applications, provide notice to applicants if potential issues are identified, and provide recommendations or set conditions on leases if issued. Some states, however, take a more proactive front-end approach, such as Maine and Rhode Island.

In Maine, the Department of Marine Resources mandates that applicants have a pre-application meeting to discuss proposed operations with the Department, harbor master, and/or the municipal officers of the town in which the applicant wishes to apply. Similarly, in Rhode Island, the Coastal Resources Management Council requires applicants to complete a Preliminary Determination process which involves meeting with regulating agencies, town officials, and the Rhode Island Department of Environmental Management to discuss proposed plans. In both states, meetings allow officials who are familiar with competing uses in the area to advise applicants of potential user conflict issues to give them an opportunity to modify applications before submittal.

3. The Permit Process

The permitting process for shellfish aquaculture leases can be complicated, lengthy and represent a considerable barrier to entry for some potential applicants.³¹ Many states have been dealing with similar issues much longer than North Carolina. To streamline the process, reduce the cost of permitting, and mitigate user conflict issues, states such as Maryland, Florida, Delaware, Massachusetts, New Jersey, New York, and California have established SEAs where state agencies perform aquaculture lease siting, including environmental and public trust suitability review, as well as acquisition of necessary Federal permits. These states then sub-lease smaller parcels within the SEA to shellfish growers. This makes the process more efficient on the back-end, where states only have to verify the suitability of an applicant and issue a permit to operate within those pre-approved SEAs.

Streamlined permitting encourages industry development by shifting the approval burden to the state, eases the state's lease back-end application burden, and helps mitigate user conflict issues. This process also gives individual states greater authority to regulate the activities conducted within the designated area.

²⁹ http://www.ct.gov/deep/cwp/view.asp?a=2705&q=431902&depNav_GID=1622; <https://www.freshfromflorida.com/Divisions-Offices/Aquaculture>; <https://www.maine.gov/dmr/aquaculture>; <http://dnr.maryland.gov/fisheries/pages/aquaculture/index.aspx>; <https://www.capecodextension.org/marine/semac/>; https://www.nj.gov/dep/fgw/pdf/marine/shellfish_leasing_policy_atlantic.pdf; http://assembly.state.ny.us/leg/?default_fld=&bn=A07120&term=2011&Summary=Y&Actions=Y&Votes=Y&Memo=Y&Text=Y; <http://www.shellfishri.com/ri-shellfish-initiative/>; http://www.mrc.state.va.us/Shellfish_Aquaculture.shtm

³⁰ *Id.*

³¹ *Id.*

4. Shellfish Lease Size and Acre Caps

A common component in user conflicts with shellfish aquaculture revolves around the fear that shellfish aquaculture will eventually take over the majority of a waterbody.³² In New York and Rhode Island, acreage caps have been used to curb fears in areas of high residency and water use. Suffolk County (New York) established an acreage cap of 60 acres that can be leased each year for new leases. In Rhode Island, a maximum of five percent of a coastal salt pond can be leased for shellfish aquaculture. In North Carolina, individual leases are restricted to 10 acres with no more than 50 acres held by an individual or corporation. Beyond size caps and residency requirements, leases are subject to a variety of parameters in different states that limit their expansion such as lease terms, physical restrictions, and other parameters.³³

5. Education

In North Carolina, Carteret Community College offers the Aquaculture Technology Program which provides courses in shellfish aquaculture along with hands on experience working on shellfish farms.³⁴ Currently, North Carolina requires shellfish lease applicants to complete an examination scoring a minimum of 70 percent based on an educational package provided by the DMF. DMF established the examination to demonstrate the applicant's knowledge of:

- Shellfish lease application process;
- Shellfish lease planting and production requirements;
- Lease marking requirements;
- Lease fees;
- Shellfish harvest area closures due to pollution;
- Safe handling practices;
- Lease contracts and renewals;
- Lease termination criteria;
- Shellfish cultivation techniques.

Many states have cooperative extension programs which provide classes and training that introduce potential applicants to the fundamentals of shellfish aquaculture.³⁵ The University of Florida IFAS Shellfish Aquaculture Extension Program, the University of Maryland Extension's Oyster Aquaculture and Education Program, and Southeastern Massachusetts' Aquaculture

³² http://www.ct.gov/deep/cwp/view.asp?a=2705&q=431902&depNav_GID=1622; <https://www.freshfromflorida.com/Divisions-Offices/Aquaculture>; <https://www.maine.gov/dmr/aquaculture>; <http://dnr.maryland.gov/fisheries/pages/aquaculture/index.aspx>; <https://www.capecodextension.org/marine/semac/>; https://www.nj.gov/dep/fgw/pdf/marine/shellfish_leasing_policy_atlantic.pdf; http://assembly.state.ny.us/leg/?default_fld=&bn=A07120&term=2011&Summary=Y&Actions=Y&Votes=Y&Memo=Y&Text=Y <http://www.shellfishri.com/ri-shellfish-initiative/>; http://www.mrc.state.va.us/Shellfish_Aquaculture.shtm

³³ Id.

³⁴ <https://www.carteret.edu/programs/aquaculture-technology/>

³⁵ http://www.ct.gov/deep/cwp/view.asp?a=2705&q=431902&depNav_GID=1622; <https://www.freshfromflorida.com/Divisions-Offices/Aquaculture>; <https://www.maine.gov/dmr/aquaculture>; <http://dnr.maryland.gov/fisheries/pages/aquaculture/index.aspx>; <https://www.capecodextension.org/marine/semac/>; https://www.nj.gov/dep/fgw/pdf/marine/shellfish_leasing_policy_atlantic.pdf; http://assembly.state.ny.us/leg/?default_fld=&bn=A07120&term=2011&Summary=Y&Actions=Y&Votes=Y&Memo=Y&Text=Y <http://www.shellfishri.com/ri-shellfish-initiative/>; http://www.mrc.state.va.us/Shellfish_Aquaculture.shtm

Center all offer online classes and/or in person workshops to educate potential applicants. These programs are federally funded through the Cooperative State Research, Education, and Extension Service and other federal agencies. Some states such as Virginia, Rhode Island, and Florida have developed mandatory training requirements. These requirements tend to focus on sanitation issues and harvest procedures as they help states comply with the National Shellfish Sanitation Program.³⁶

D. Future Studies and Directives

Future studies and directives mandated by S.L. 2019-37 include: the development of SEAs, potential SEAs in moratorium areas, and a Pamlico Sound Shellfish Aquaculture Pilot Project for a few larger-size leases. These studies require the development and implementation of new methods and procedures for the shellfish lease process. DMF is currently exploring possible ways to complete large-scale shellfish lease investigations required by both the SEA and Pamlico Sound Pilot studies.

Currently, a large-scale shellfish lease investigation would require the effort of the entire Shellfish Lease Program staff for approximately three months leaving no time to review lease applications or perform other work of the program. DMF is exploring the use of drone technology to aid in the lease investigation process and exploring Habitat Suitability Index modeling as a tool for siting shellfish aquaculture leases. DMF is also evaluating various sampling techniques including dredge sampling and using the spatial analysis from the Bogue Sound Pilot Project.

³⁶ Id.

IV. RECOMMENDATIONS

A multifaceted approach is required to address user conflict issues related to shellfish aquaculture leases in North Carolina. This approach envisions regulatory reform, program evaluation, collaboration, and resource assessment. Previous and current work should be built upon to avoid duplication and expending extra resources.

Existing shellfish lease and franchise statutes³⁷ and rules³⁸ require revisions to effect execution of the recommendations in this study. DMF is drafting suggested revisions to existing shellfish lease statutes and rules to address user conflict issues and incorporate mandated revisions from S.L. 2019-37. The deadline for adoption of rule revisions is March 1, 2021. In discussions with DCM and the North Carolina Coastal Resources Commission (“CRC”) regarding potential user conflict concerns specific to shellfish lease gear and navigation impacts, DMF intends to develop rule language to address these concerns. Recommendations will be made regarding rule revisions based off the findings in this study. Additional recommendations for statute and rule revisions addressing user conflict issues will be developed through the additional studies and directives mandated by S.L. 2019-37.

DMF will evaluate the Shellfish Lease Program and Aquaculture Permitting Program to identify challenges and inefficiencies and recommend ways to improve existing programs. DMF staff believes this focus will result in further modification of internal operating procedures. Areas for further collaboration were identified in this study along with likely participating partners.

Other directives mandated by S.L. 2019-37 include the development and implementation of SEAs similar to those employed by other states. One of the obstacles North Carolina shellfish regulators face is a limited ability to stay informed regarding the aquaculture efforts of other states. DMF recommends collaborating with other states to facilitate a joint interstate discussion. This effort will be of mutual benefit to participating states in compiling and evaluating information relevant to each states’ respective aquaculture regulation and permitting processes.

The Shellfish Lease Program is tasked with implementing the recommendations from this study. It is imperative that DMF have sufficient dedicated staff to manage the program. DMF may not be adequately funded or staffed to implement the recommendations in this study. The lack of funding and dedicated staff significantly inhibits the program’s administrative support for lease holders, drastically increases the time to acquire a lease, and impairs the DMF’s ability to address user conflict issues efficiently and effectively. The additional legislative mandates put further burden on the already limited amount of staff and resources of the Shellfish Lease Program. DMF will evaluate current staff and funding levels of the Shellfish Lease Program to estimate the resources needed for the program to implement the recommendations of this study.

³⁷ N.C.G.S. § 113-201 et seq.

³⁸ 15A NCAC 03O.0201.0211

A. Recommendation #1: Regulatory Reform

- Incorporate riparian area owner notification standards to include certified mail notification (15A NCAC 03O.0201);
- Add language to include MFC's authority to limit total acres leased in a waterbody (15A NCAC 03O.0201);
- Add a 250 feet setback requirement between any shellfish leases (15A NCAC 03O.0201(a));
- Modify the setback requirement of 100 feet from a developed shoreline to 250 feet to help alleviate user conflict with riparian owners (15A NCAC 03O.0201(a)(3));
- Modify marking requirements for shellfish leases and franchises to include a maximum of eight corner lease corner markers and additional requirements to ensure visibility to alleviate navigation concerns. More noticeable shellfish lease markings have been a safety concern (15A NCAC 03O.0202(b); 15A NCAC 03O.0204);
- Modify training requirements for shellfish lease applicants to include information about user conflicts and the public trust (15A NCAC 03O.0202(d));
- Add administrative remedy language from statute (15A NCAC 03O.0206);
- Add clearance requirement of three feet between the top of the cage and the water level at mean low tide to the amended shellfish leasing statute allowing the use of gear up to 18 inches off of the bottom (N.C.G.S. § 113-202(r)).

B. Recommendation #2: Program Evaluation

- Best management practices for the industry should be practiced and publicized, best available science should be incorporated into the permitting process, and stakeholders should work together to collect data and analyze facts to reach shared decisions on the user conflict issues;
- Synchronize all reporting and renewal requirements for shellfish leases and aquaculture permits.

C. Recommendation #3: Collaboration

- Form an interstate aquaculture workgroup and have an in-person meeting;
- Create an inventory with aquaculture information from each state, including site selection, permitting, public trust issues, business planning and economics, seed and nursery options, grow out methods and equipment, consumer safety and marketing;
- Develop a standing interstate aquaculture workgroup in partnership with NCSG with adequate funding and support;
- In partnership with NCSG, continue developing a Shellfish Aquaculture Training Program.

D. Recommendation #4: Resource Assessment

- Evaluate the Shellfish Lease Program's staff and funding levels to determine whether they are adequate to administer the current and increasing volume and complexity to similar levels of other state's aquaculture programs.



ROY COOPER
Governor

MICHAEL S. REGAN
Secretary

STEPHEN W. MURPHEY
Director

January 31, 2020

MEMORANDUM

TO: N.C. Marine Fisheries Commission
FROM: Jacob Boyd, Section Chief Habitat and Enhancement
SUBJECT: Relay Program Evaluation

Issue

A thorough evaluation of the Relay Program was undertaken by the division to determine if the current structure of the program is in line with the original concept and to propose solutions to issues identified in the process including:

- Sufficient staff and resources to implement current National Shellfish Sanitation Program (NSSP) requirements requiring the division to also observe relayed oyster transport and placement on shellfish leases which will need to be implemented in the coming 2020 relay season and will require more staff and resources.
- Concerns received related to the habitat/water quality benefits that are at least temporarily lost in one area, usually polluted, when relayed shellfish are removed and relayed onto a shellfish lease where the product is ultimately removed from the water after depuration.
- Concerns received related to the relay of public trust product for the benefit of a leaseholder.

Action Needed

The commission's input is sought on short- and long-term management options for the Relay Program based on the findings of the evaluation.

Findings

Based on the program evaluation, potential management options include:

- Shorter relay season, limited days per week
- Limited areas open for relay, rotational open areas
- Discontinuation of relay from polluted areas
- Evaluate potential relay from open areas
- No further action necessary

Overview

Summary

The relaying of shellfish from certain polluted areas is authorized by the Polluted Area Relay Permit and is explained in detail in the N.C. Oyster FMP Amendment 4. The oyster relay program continues as a small-scale relay project with the number of relay permits and relayed oysters declining considerably from 2002 – 2018. Clam relay requires the division to observe relayed clam transport

and placement on a shellfish lease which requires resources and efforts by Marine Patrol and other staff. Due to the increased burden of observing clam relay, the division developed policies which require at least five people in an area to be relaying before opening the area. In 2018, Hurricanes Florence and Michael caused damage to oyster populations which led to only a few areas being open for relay during the 2019 relay season. Since 2014, there have been a total of 190 unique participants (average 57 per season) in the relay program averaging 70 permits per season with some participants utilizing multiple shellfish leases.

A notable increasing trend has been documented for the number of seed import permits issued and amount of seed imported from 2009 – 2019. This may be indicative of the shift from extensive to intensive shellfish aquaculture techniques occurring over the last few years. Intensive shellfish aquaculture techniques utilize bottom or floating cages rather than historical cultch on bottom methods. Therefore, more growers are choosing to plant seed on their shellfish lease rather than cultch material for production requirements.

For more information, please refer to the full document that is included in this Briefing Book.

[Relay Program Evaluation Memo](#)



ROY COOPER
Governor

MICHAEL S. REGAN
Secretary

STEPHEN W. MURPHEY
Director

MEMORANDUM

TO: Stephen Murphey, Director; Dee Lupton, Deputy Director
FROM: Jacob Boyd, Section Chief Habitat and Enhancement
CC: Shannon Jenkins, Section Chief Shellfish Sanitation
DATE: September 11, 2019
SUBJECT: Relay Program Evaluation

Summary

The relaying of shellfish from certain polluted areas is authorized by the Polluted Area Relay Permit and is explained in detail in the N.C. Oyster FMP Amendment 4. The oyster relay program continues as a small-scale relay project with the number of relay permits and relayed oysters declining considerably from 2002 – 2018 (Figures 1 and 2). Clam relay requires the division to observe relayed clam transport and placement on a lease which requires resources and efforts by Marine Patrol and other staff. Due to the increased burden of observing clam relay, the division developed policies which require at least 5 people in an area to be relaying before we will allow relay of clams. In 2018, Hurricanes Florence and Michael caused damage to oyster populations which led to only a few areas open for relay during the 2019 relay season. While relayed product has been allowed to be used towards shellfish lease production, new legislation (S648, Session Law 2019-37) enacted on July 1, 2019 does not allow for relayed shellfish to be included in calculating lease production for leases granted or renewed after July 1, 2019.

Since 2014, there have been a total of 190 unique participants (average 57 per season) in the relay program averaging 70 permits per season with some participants utilizing multiple leases (Tables 1 and 2). Data were analyzed for lease holders previously participating in the relay program to determine a timeline for when new production requirements would begin based on when leases are up for renewal. The participants utilized 113 leases for relaying shellfish from 2014 – 2019. Of these 113 leases, 23 are up for renewal in 2020, 51 are up for renewal between 2024 and 2029, and 13 have been terminated (Table 2).

A notable increasing trend has been documented for the number of seed import permits issued and amount of seed imported from 2009 – 2019 (Figure 3). This may be indicative of the shift from extensive to intensive shellfish aquaculture techniques occurring over the last few years. Intensive shellfish aquaculture techniques utilize bottom or floating cages rather than historical cultch on bottom methods. Therefore, more growers are choosing to plant seed on their lease rather than cultch material for production requirements.

Issues

Current NSSP guidelines require the division to also observe relayed oyster transport and placement on leases which will need to be implemented in the coming 2020 relay season. This will take a tremendous amount of resources and staff to stay in compliance with the NSSP requirements. Another concern is the habitat/water quality benefits that are at least temporarily lost in one area, usually polluted, when relayed shellfish are removed and relayed onto a lease where the product is ultimately removed from the water. Like the lease areas themselves, the relay of public trust product for the benefit of a leaseholder has also had a lot of controversy. The division has had problems with permit holders reporting accurate information pertaining to their relaying activities in a timely manner.

Proposed Actions

A thorough evaluation of the relay program is recommended to determine if the current structure is in line with the original concept. The following are potential items for consideration for the evaluation process:

- NSSP requirements to observe all shellfish relay
 - Fiscal analysis of additional staff time and resources required for oyster relay
- New production requirements
- Relay study update
- Amount of closed areas
- Environmental effects
- Reporting issues/non-compliance
- Public trust issues
- Fiscal analysis based on resources needed to administer program, participation, economic value, spatial coverage needed, etc.

Based on the program evaluation, potential management options which should be considered include but are not limited to:

- Shorter season, limited days per week, rotational open areas
- Using existing clam relay permit requirements for oysters
- Termination of the relay program
- Relay using shellfish management area open to open (i.e., Cultch Program)

If rule changes are deemed necessary through the relay program evaluation, the evaluation will be used as a basis for any resulting issue papers. In order to make any changes for the upcoming 2020 relay season, it is important to begin work on the evaluation. Please let us know if you would like to discuss this further and how to move forward.

Table 1. Summary of the relay program showing the number of oysters (bu), participants, and permits per season from 2014 - 2018.

Year	Oysters (bu)	Participants ¹	Permits	Oysters (bu)	
				Per Participant	Per Permit
2014	12,335	60	102	206	121
2015	15,128	60	73	252	207
2016	8,130	60	67	136	121
2017	15,158	53	53	286	286
2018	5,335	52	55	103	97
Total	56,086	285	350	197	160

¹ Includes individuals participating multiple years with a total of 190 unique participants

Table 2. Total number and type of leases utilized for the relay program and when they are up for renewal from 2014 - 2019

Renewal	Total
2020	23
2024	1
2025	13
2026	10
2027	13
2028	13
2029	1
Franchise	16
Terminated	13
Transfer	10
Total	113

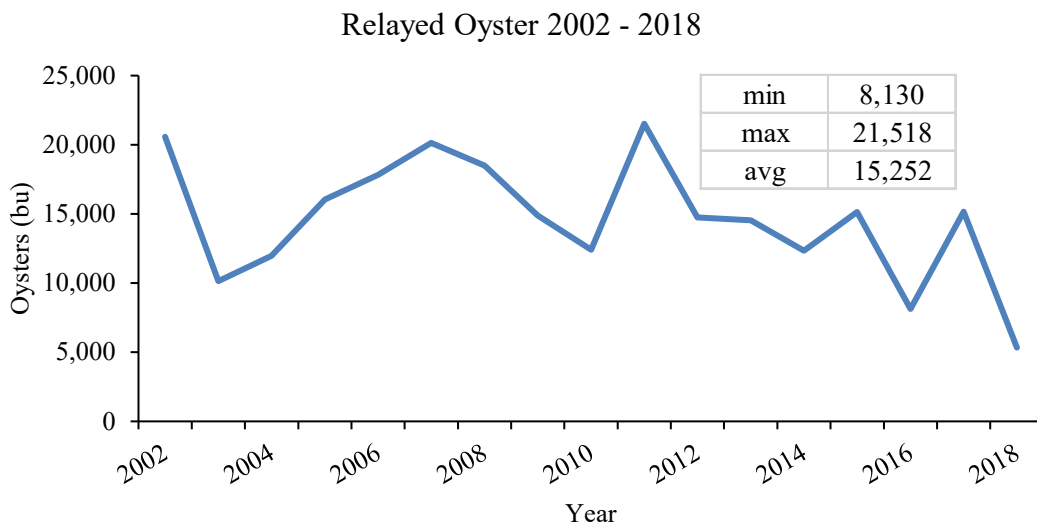


Figure 1. The number of oysters (bushels) relayed from 2002 – 2018.

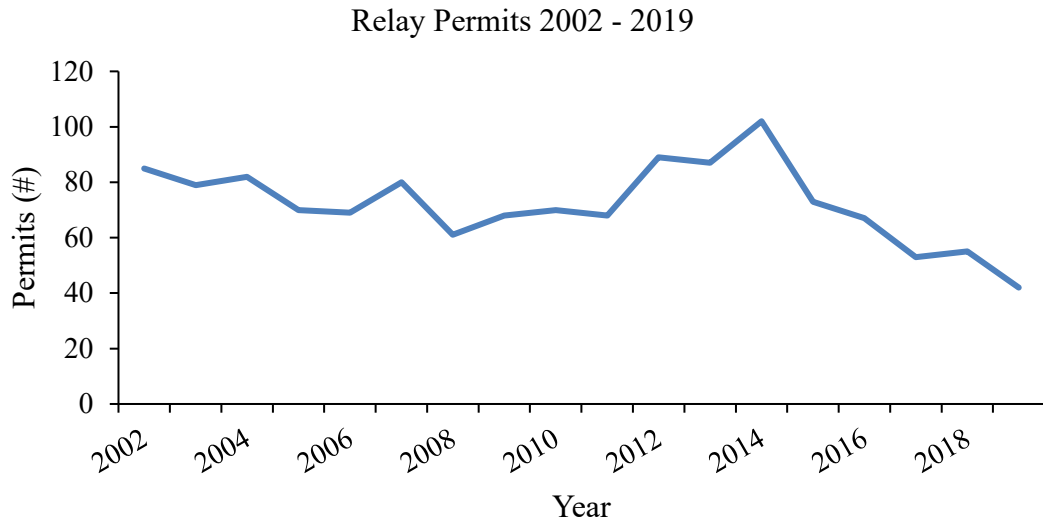


Figure 2. The number of relay permits issued from 2002 – 2019.

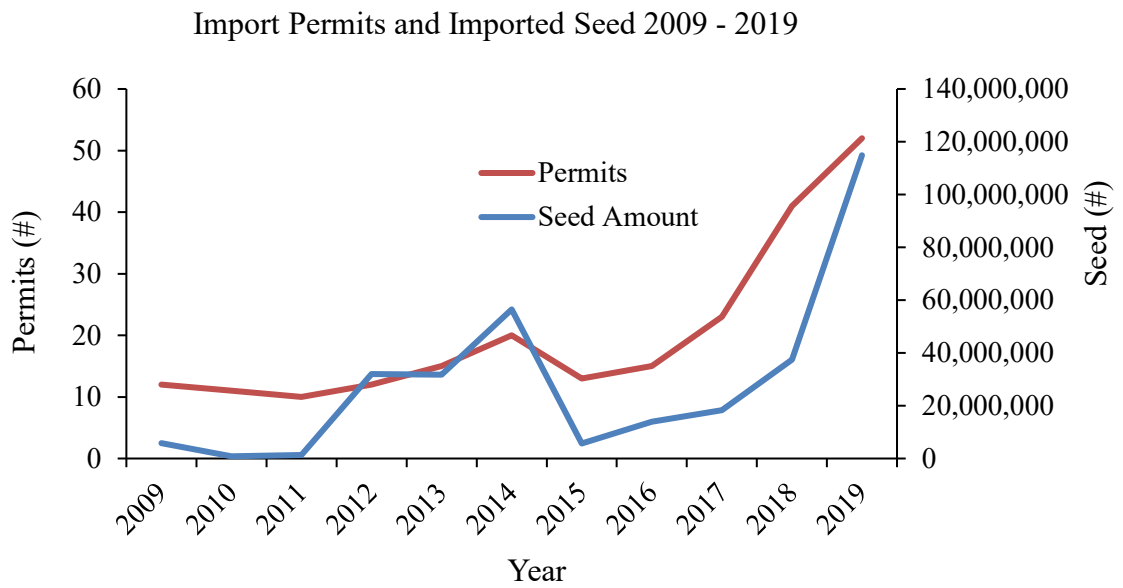


Figure 3. The number of import permits issued and amount of seed imported from 2009 – 2019.