



Southern Flounder Satellite Tagging Updates

DEPARTMENT OF ENVIRONMENTAL QUALITY

Marine Fisheries

Marine Fisheries Commission Meeting | Shelby B. White | February 2022



Objectives of Satellite Tagging Research

1. Identify potential offshore spawning areas used by southern flounder.
2. Identify movements prior to and after winter spawning.
3. Identify migration corridors and offshore habitat preferences.

Tagging Methods

- mrPAT (Mark-Report Pop-up Archival Tag).
- Detaches on a pre-determined date.
- Floats to surface and transmits data to satellites.

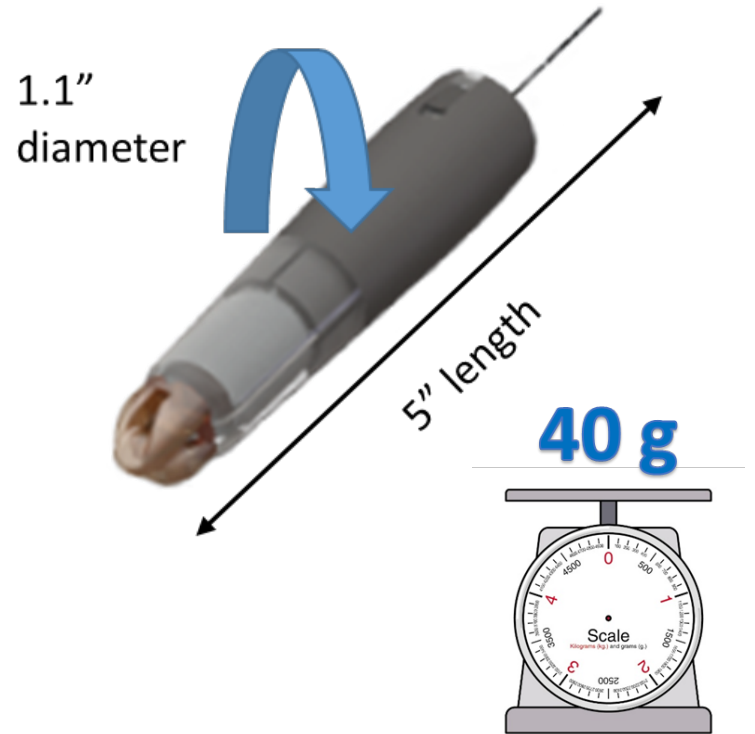

Tagging Methods



Tagging Methods



Tagging Methods



2020 Satellite Tagging Efforts – Year 1

- 100 southern flounder tagged.
- High reward tags.
- Programmed to release between January 1-March 15.
- Additional 30 tags released by UNCW in Core Sound.

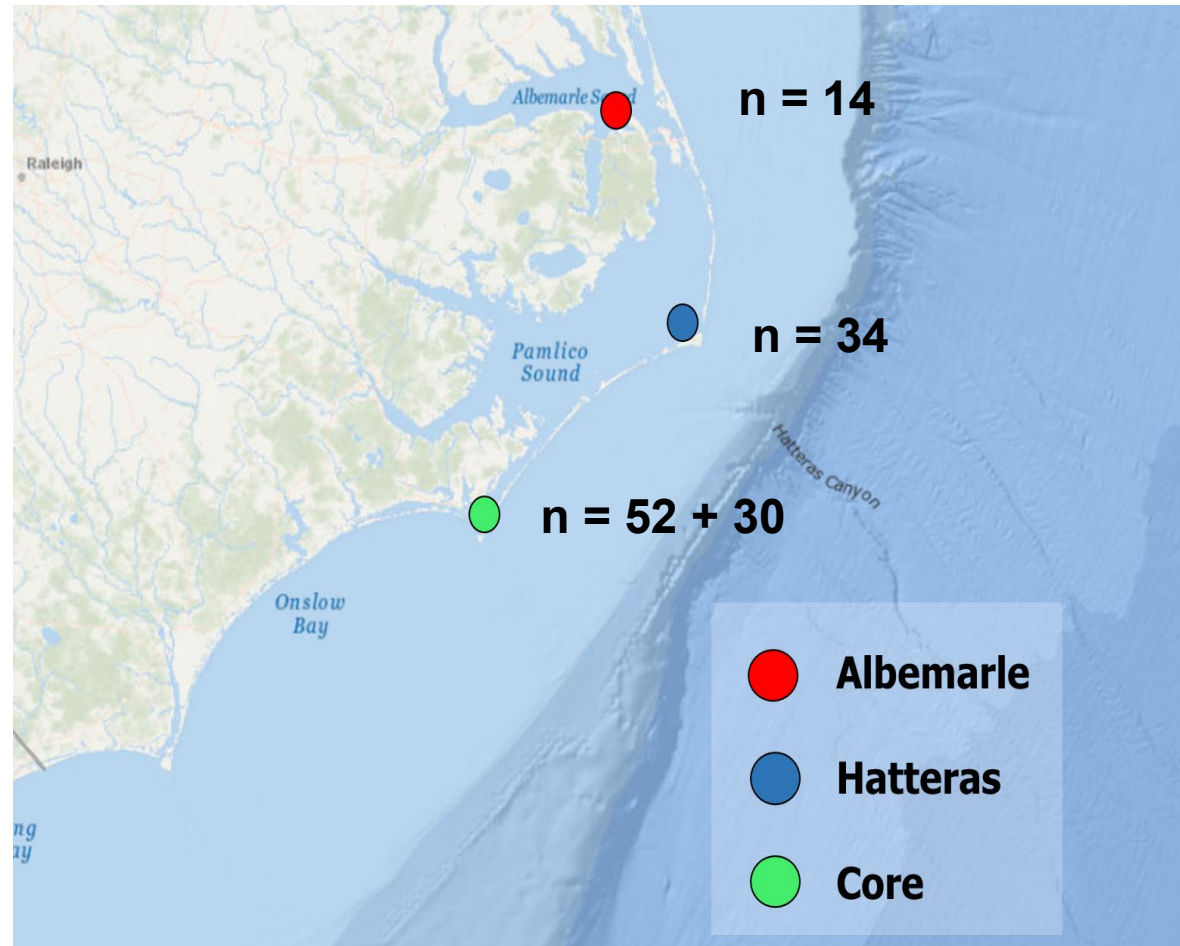

Pop-off Location by Area

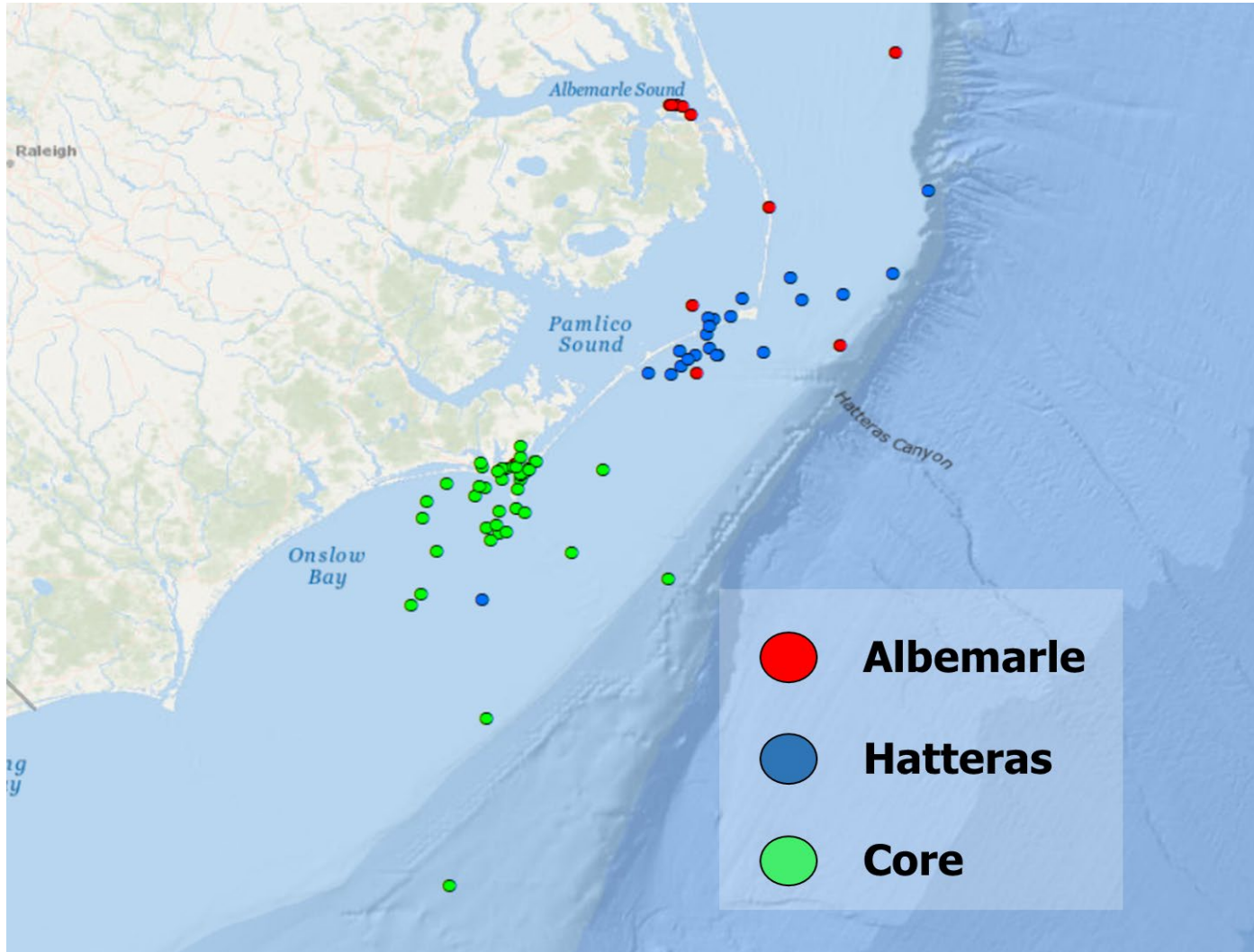

Temperature

Daily Min/Max Temperature

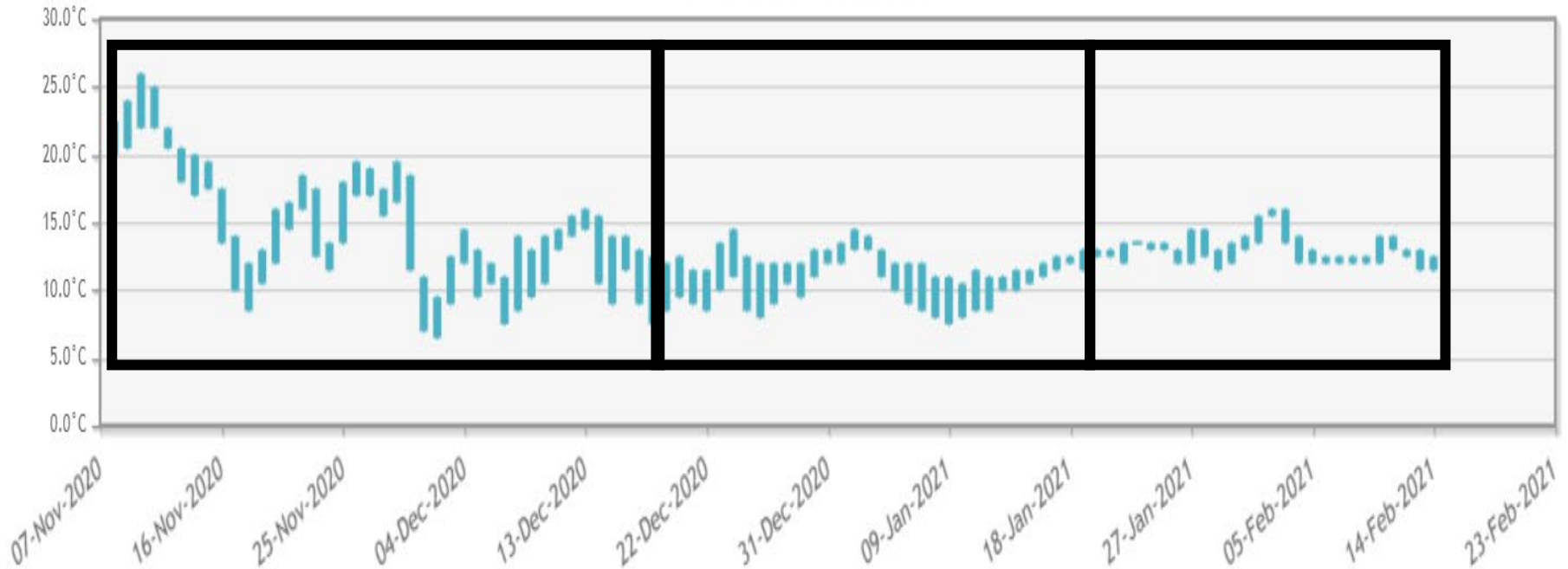

Pop-off Location by Month

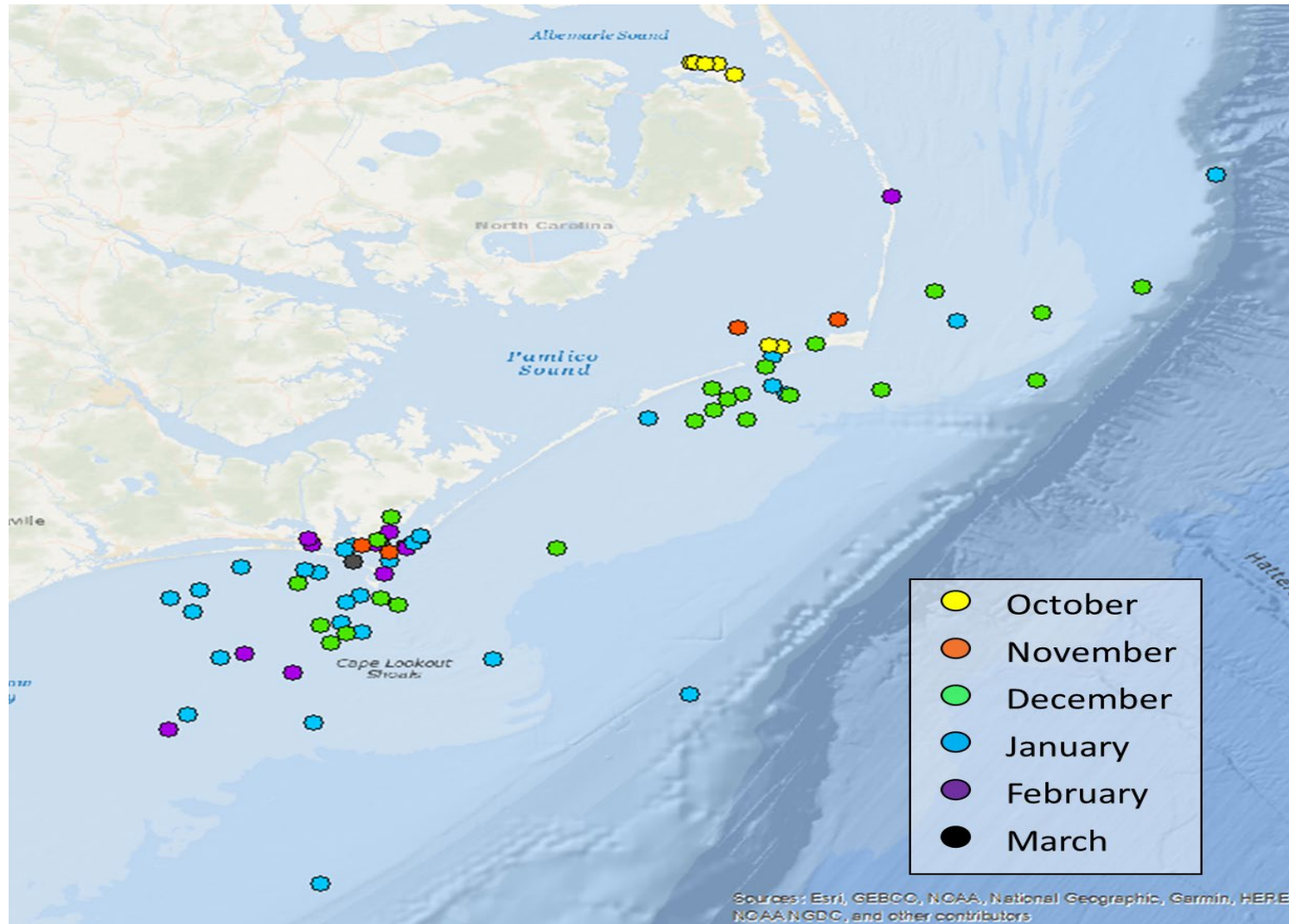

2021 Satellite Tagging Efforts – Year 2

- Adjusted release time to increase randomness.
- Expanded tagging efforts to South Carolina and Georgia.
- Continued collaboration with UNCW.



2021 Satellite Tagging Efforts – Year 2

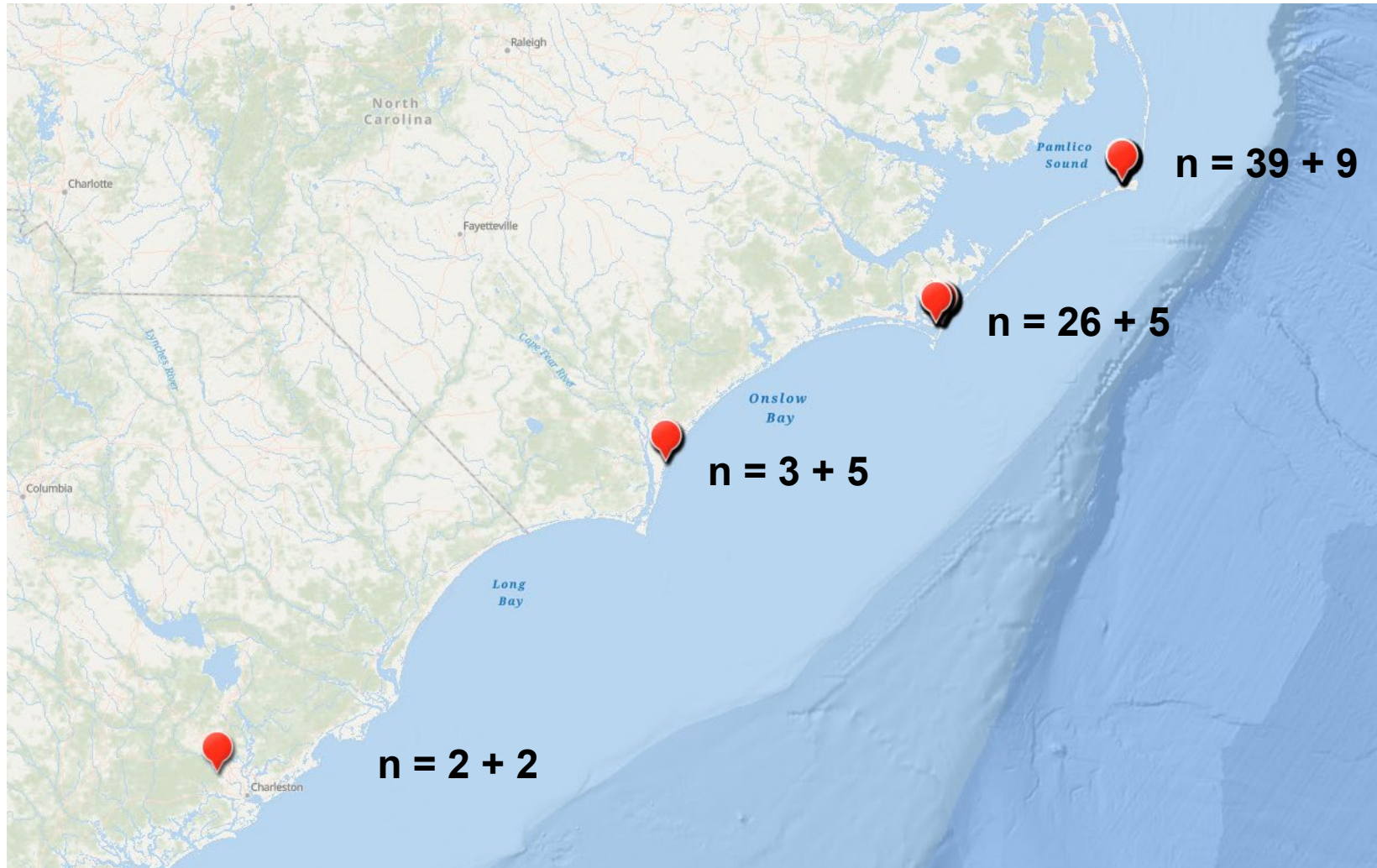

Pop-off Location by Area

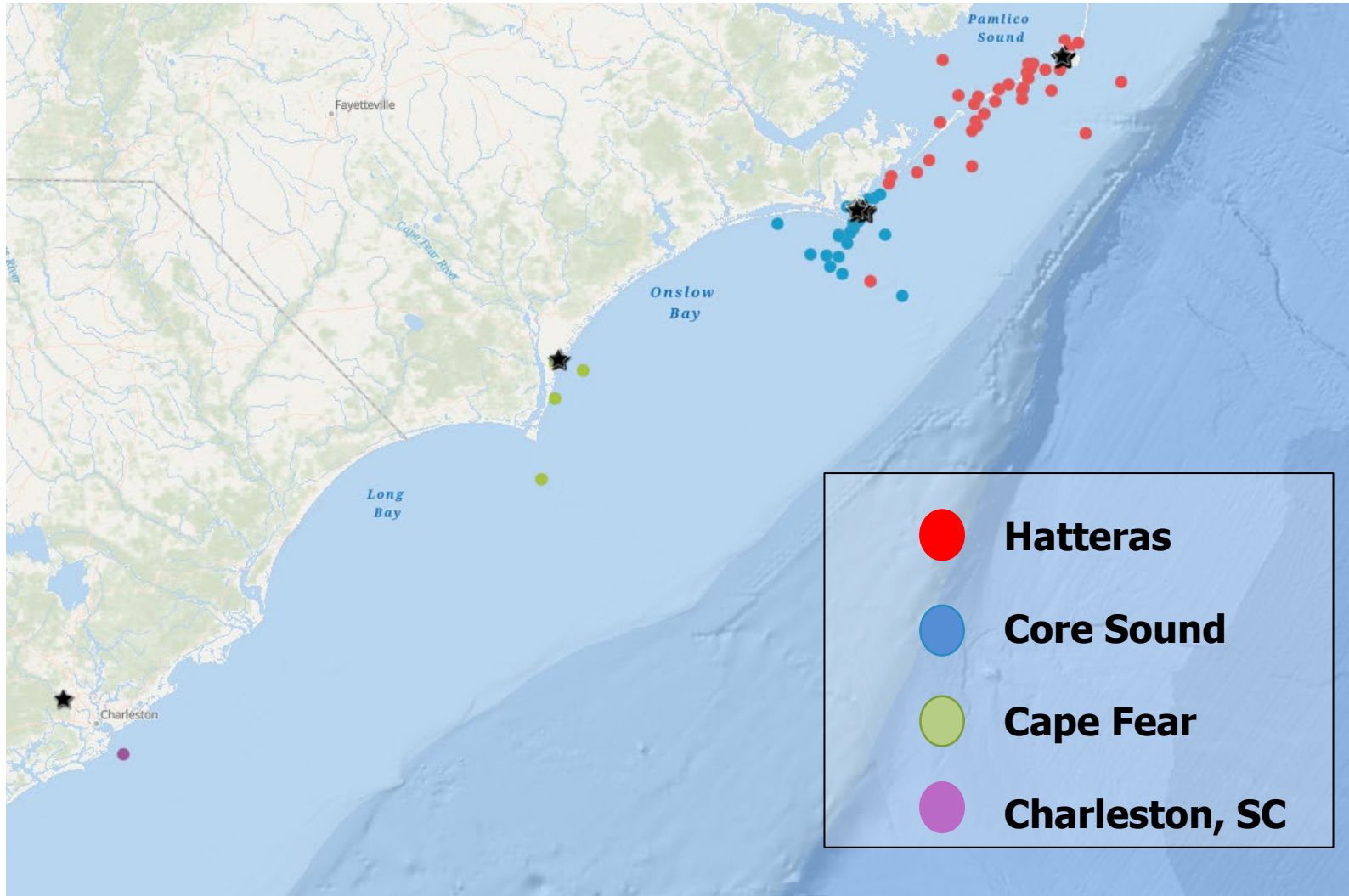

More Southern Flounder Research

East Carolina University

- Timing offshore migration with acoustic tagging.
- Locate possible spawning habitats.
- Larval sampling and pathways.
- Sex and maturity of adults offshore.
- Chemical cues in otoliths.

South Carolina Department of Natural Resources

- Genetic analysis of southern flounder – fin clips.

Gulf States Marine Fisheries Commission

- Symposium to discuss all things flounder.

Questions?

Southern Flounder Satellite Tagging:

Shelby B. White
Shelby.White@ncdenr.gov
252-381-6006

Southern Flounder FMP Co-Leads:

Michael S. Loeffler
Michael.Loeffler@ncdenr.gov
252-473-5734

Anne L. Markwith
Anne.Markwith@ncdenr.gov
910-796-7292

