



Digesters and Swine Manure Treatment

John Classen, PhD
October 12, 2021



Digesters are similar to lagoons - but different



Process - Lagoons

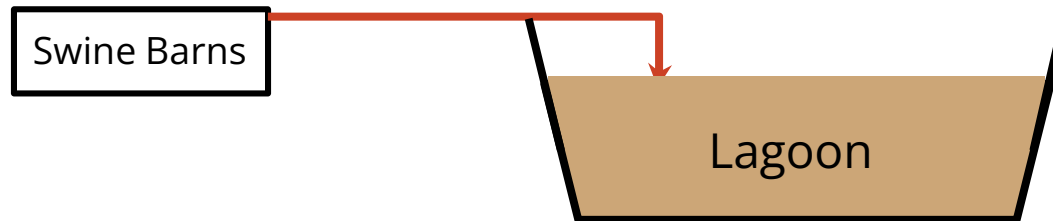

Process - Lagoons

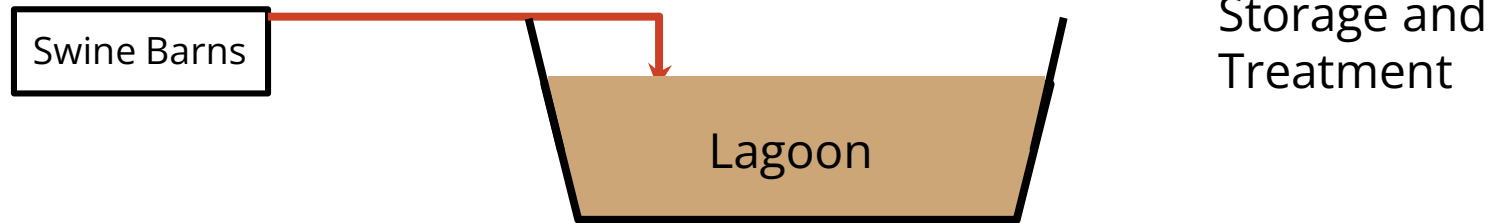

Process - Lagoons

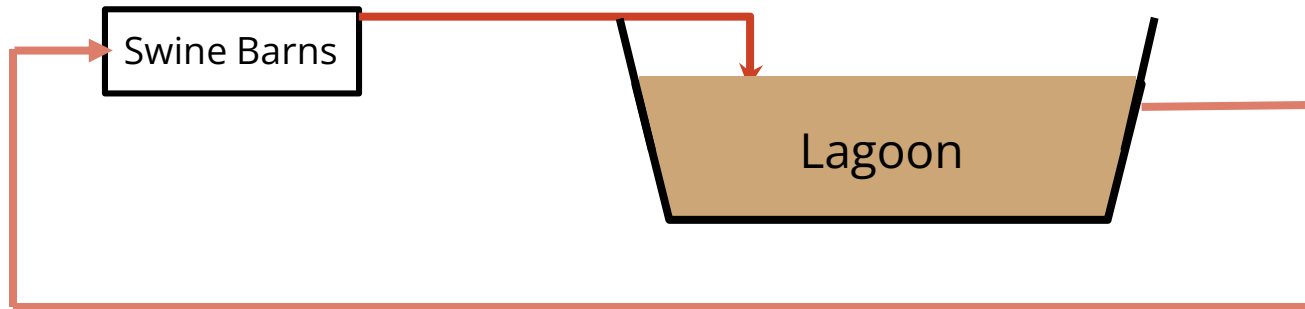

Process - Lagoons

Conditions:

- Unmixed
- Low DO at surface
- Anaerobic at deeper levels

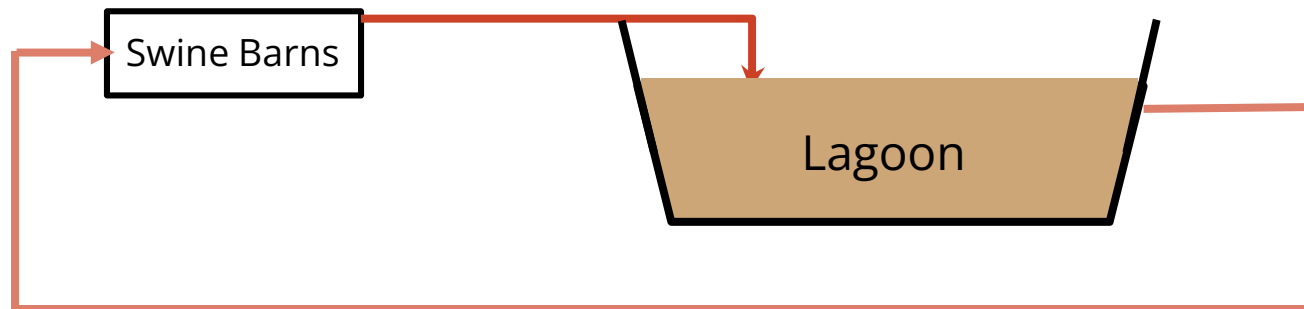

Process - Lagoons

Conditions:

- Unmixed
- Low DO at surface
- Anaerobic at deeper levels

Leads to

- Incomplete breakdown
- Low conversion to methane
- Residual organics and polymers

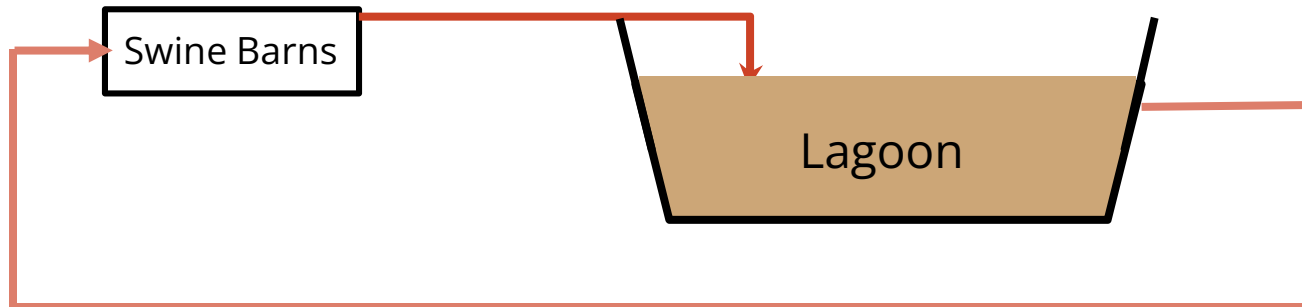

Process - Lagoons

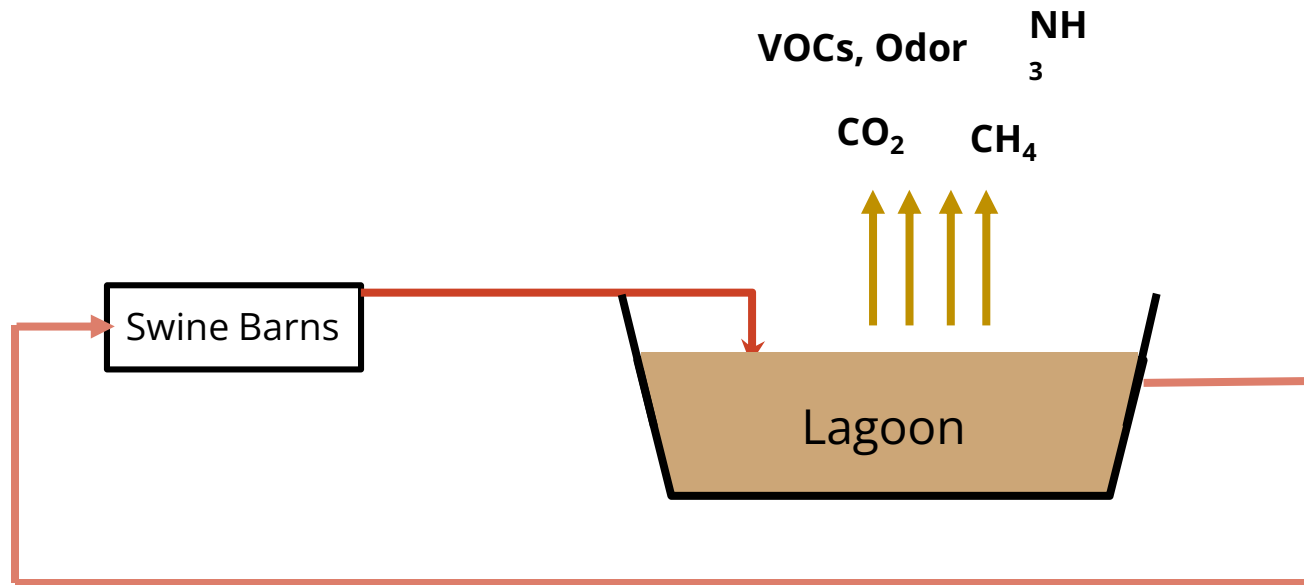

Process - Digesters

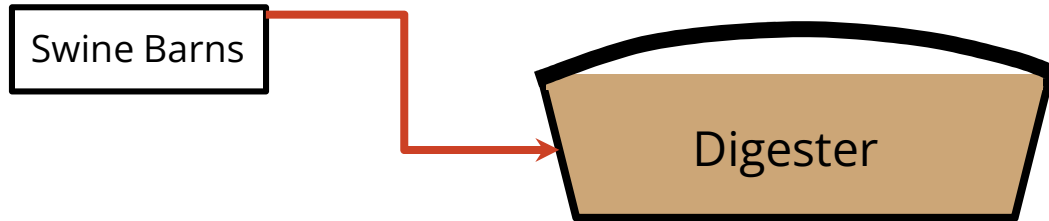

Process - Digesters

Conditions:

- No oxygen, fully anaerobic
- Mixed

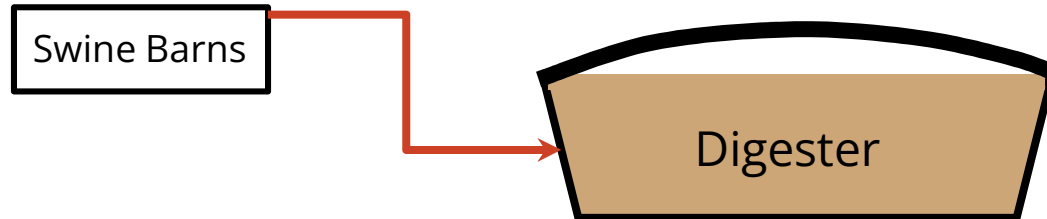

Process - Digesters

Conditions:

- No oxygen, fully anaerobic
- Mixed

Leads to

- More complete breakdown
- Higher conversion to methane

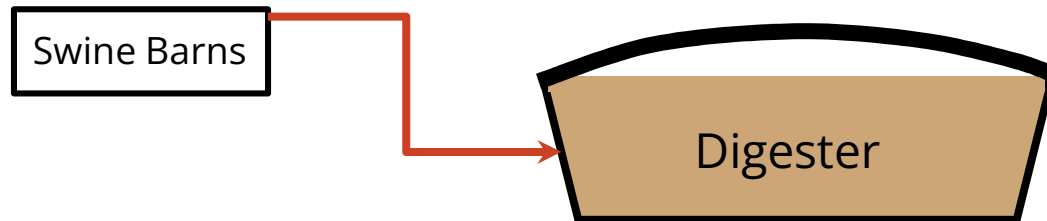

Process - Digesters

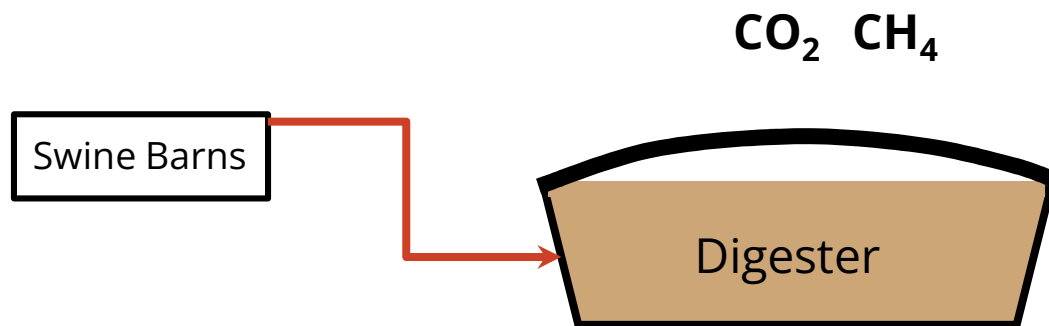

Process - Digesters

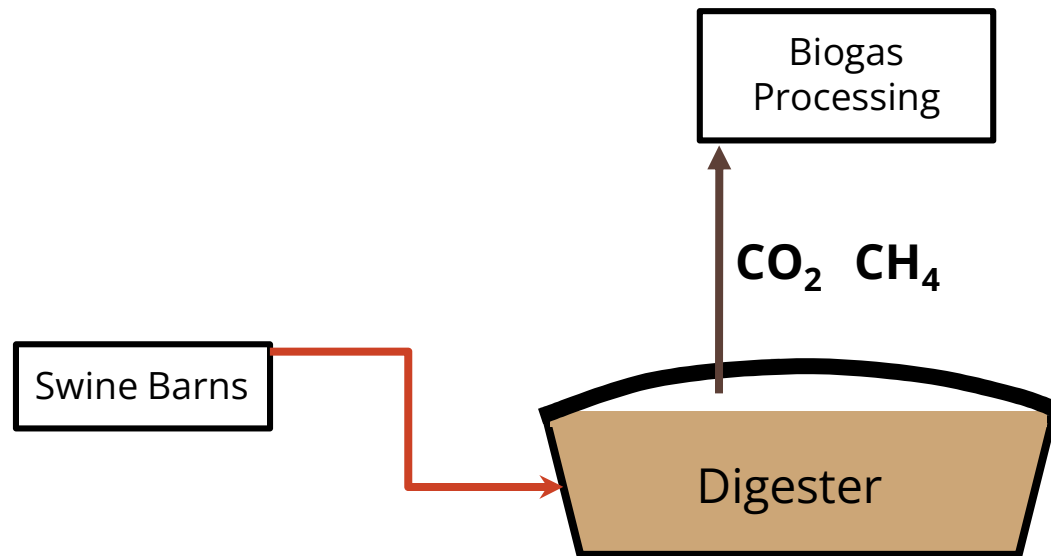

Process - Digesters

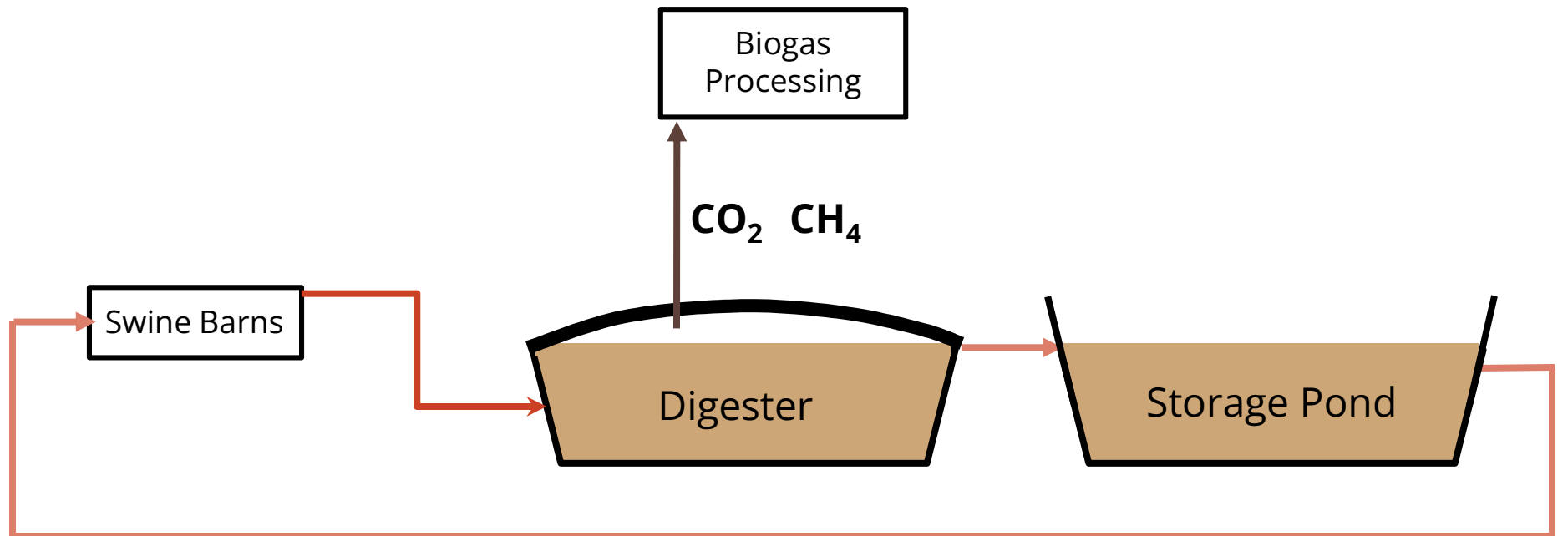

Process - Digesters

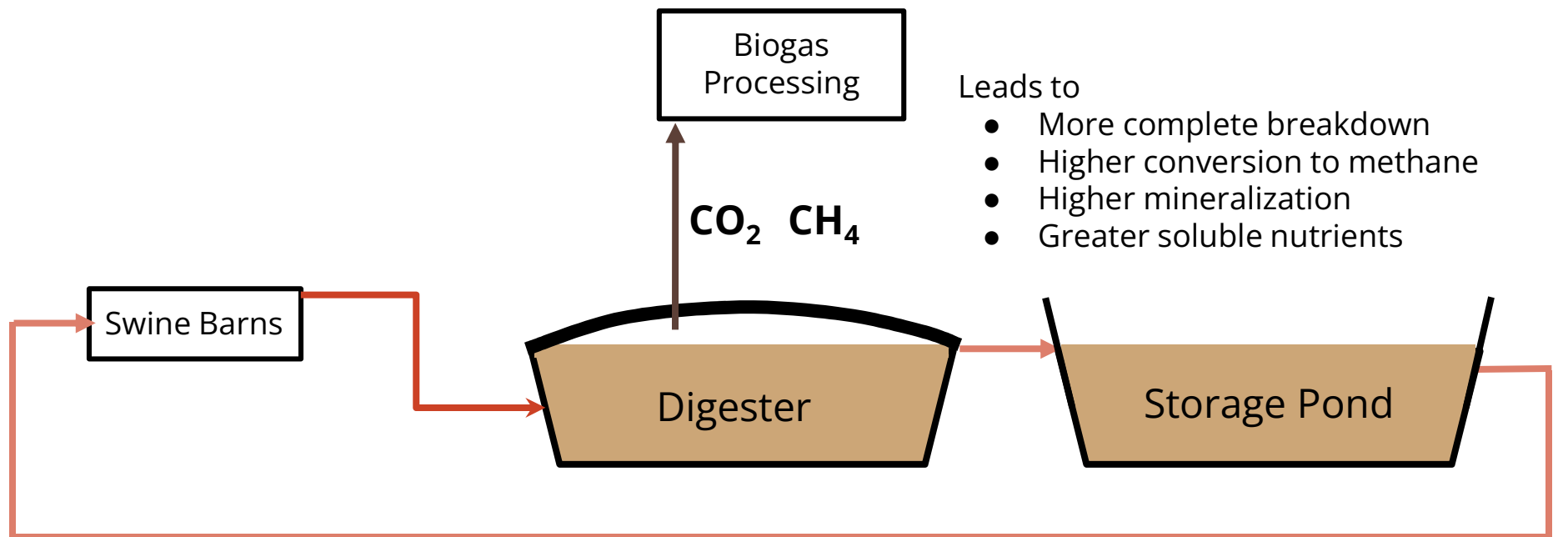

Leads to

- More complete breakdown
- Higher conversion to methane
- Higher mineralization
- Greater soluble nutrients

Process - Digesters

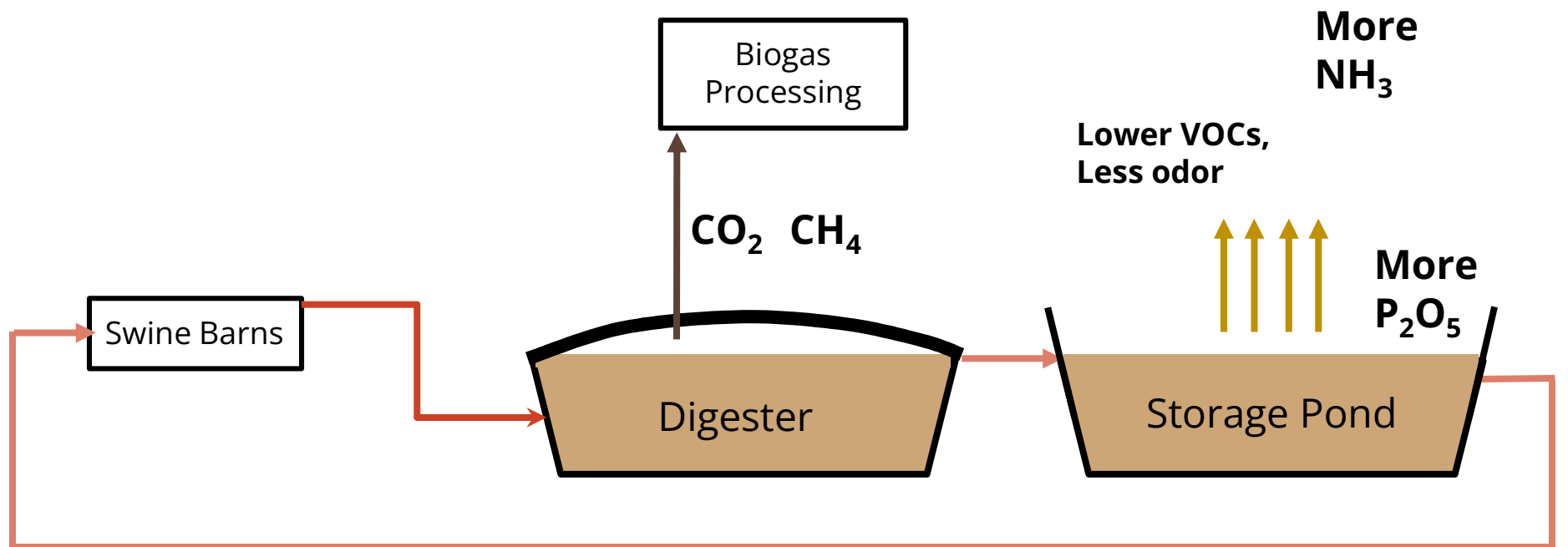

Questions

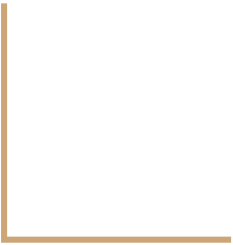



John Classen, PhD
Biological and Agricultural Engineering
NC State University
classen@ncsu.edu

