

**Jones Creek Mitigation Project  
Anson County, North Carolina  
DENR-EEP Contract No. D04020-1  
Year 3 Monitoring Report**



**Prepared for**  
Environmental Banc and Exchange, LLC  
909 Capability Drive, Suite 3100  
Raleigh, NC 27606

**Prepared by**  
WK Dickson and Co., Inc.  
720 Corporate Center Drive  
Raleigh, NC 27607  
(919) 782-0495

And

Ecosystem & Land Trust Monitoring  
PO Box 1492  
3674 Pine Swamp Road  
Sparta, NC 2867

**November 2008**

## **Table of Contents**

1.0	SUMMARY .....	1
2.0	INTRODUCTION .....	2
2.1	Project Description.....	2
2.2	Project Purpose.....	2
2.3	Project History & Schedule.....	5
3.0	HYDROLOGY .....	5
3.1	Hydrologic Success Criteria.....	5
3.2	Description of Hydrology Monitoring Efforts.....	5
3.3	Results of Hydrology Monitoring.....	7
3.3.1	Site Data.....	7
3.3.2	Reference Data.....	10
3.3.3	Climate Data.....	10
3.4	Hydrologic Conclusions.....	12
4.0	VEGETATION.....	12
4.1	Vegetation Success Criteria .....	12
4.2	Description of Species and Vegetation Monitoring.....	12
4.3	Results of Vegetation Monitoring.....	13
4.4	Vegetation Observations & Conclusions.....	14
5.0	STREAM MONITORING.....	14
5.1	Stream Success Criteria.....	14
5.2	Stream Morphology Monitoring Plan.....	15
5.2.1	Cross Sections.....	15
5.2.2	Longitudinal Profile.....	15
5.2.3	Hydrology .....	15
5.2.4	Photo Reference Stations .....	15
5.3	Stream Morphology Monitoring Results.....	16
5.3.1	Cross Sections.....	16
5.3.2	Longitudinal Profile.....	16
5.3.3	Hydrology .....	16
5.4	Stream Conclusions.....	19
6.0	CONCLUSIONS AND RECOMMENDATIONS .....	19

**List of Figures**

Figure 1. Vicinity Map.....	3
Figure 2. USGS Map .....	4
Figure 3. Monitoring Summary Map.....	6
Figure 4a. Groundwater Hydrographs 1-4.....	8
Figure 4b. Groundwater Hydrographs 5-8.....	8
Figure 4c. Groundwater Hydrographs 9-12.....	9
Figure 4d. Groundwater Hydrographs 13-14.....	9
Figure 5. Reference Hydrographs.....	10
Figure 6. 2008 Rainfall.....	11
Figure 7. Stream Problem Areas Map .....	18

**List of Tables**

Table 1. Project Mitigation Structure and Objectives.....	2
Table 2. Project Activity and Reporting History.....	5
Table 3. Project Contacts.....	5
Table 4. Hydrologic Monitoring Results.....	7
Table 5. Comparison of Normal Rainfall to Observed Rainfall.....	11
Table 6. Planted Tree Species.....	13
Table 7. 2008 Vegetation Monitoring Plot Species Composition.....	13
Table 8. Volunteer species within the Wetland Restoration Area.....	14
Table 9. Stream Areas Requiring Observation.....	16
Table 10. Crest Gauge Data.....	17
Table 11. Summary of Morphologic Monitoring Parameters.....	19

**APPENDICES**

Appendix A	As-Built Survey
Appendix B	2008 Profile and Cross Section Data
Appendix C	2008 Site Photos
Appendix D	2008Gauge Data

## **1.0 SUMMARY**

This Annual Report details the monitoring activities during the 2008 growing season at the Jones Creek Mitigation Site. The Jones Creek wetland and stream restoration site is located near the Town of Wadesboro in Anson County, North Carolina. Construction of the site was completed in December 2005. Baseline data on stream morphology and vegetation were collected immediately after construction and planting were completed. This As-Built survey information is documented in **Appendix A**. All restoration is being monitored for five years to document success. The 2008 data represents results from the third year of hydrology, vegetation, and stream stability monitoring.

Mitigation at the Jones Creek site involved stream restoration, stream preservation, wetland enhancement, and wetland restoration. Restoration of the site involved the restoration of a stable meandering channel. The channel was designed and constructed using natural channel design techniques. Restoration also involved raising the local water table by filling drainage ditches on site and creation of microtopography across the site. After construction, it was determined there was 3,068 feet of stream restoration, 5,150 feet of stream preservation, 25 acres of wetland restoration, and 2.71 acres of wetland enhancement.

This Annual Report presents the data from 14 hydrology monitoring stations, 13 vegetation monitoring plots, two crest gauges, a rain gauge, 6 stream cross sections, and photo reference locations, as required by the approved Restoration Plan for the site. All 14 hydrology monitoring stations are equipped with automated groundwater gauges.

Weather station data from the Wadesboro Weather Station were used in conjunction with a manual rain gauge located on the site to document precipitation amounts. The manual gauge is used to validate observations made at the automated station. During the 2008 growing season, the rainfall total through the end of October was generally within normal limits. Rainfall in August and September exceeded normal limits.

In 2008, twelve of fourteen hydrology monitoring gauges recorded hydroperiods of at least 7 percent of the growing season. JCAW6 met the 7 percent hydroperiod criteria within 25 inches of the soil surface and JCAW9 met the 7 percent hydroperiod criteria within 14 inches of the surface, and exhibited hydroperiods of 3 and 6 percent of the growing season, respectively. Although these two gauges failed to meet the hydrologic success criteria, they are within the range of conditions expected in undisturbed floodplain wetlands.

The three monitoring gauges at the reference wetland site recorded hydroperiods from 15 to 22 percent of the growing season. It is important to note that the hydrology of the targeted restored wetland system is highly responsive to rainfall and is expected to be variable across a given site, supporting the ecological and functional diversity that makes these systems so valuable.

This Annual Report documents vegetation survivability based on 13 vegetation monitoring plots, each 10 meters x 10 meters (0.025 acre) in size. They are located to represent the different zones within the project. The vegetation monitoring documented a survivability range of 480 to 680 stems per acre, with an overall average of 578 stems per acre. Overall, the site has met the initial vegetation success criteria of 320 stems per acre surviving after the third growing season and is on track to meet the final vegetative success criteria as specified in the Restoration Plan for the site.



During 2008, the restored stream channel remained stable and continued to provide the intended habitat and hydrologic functions. Three bankfull events were recorded during the year. All monitored cross sections show very little adjustment in stream dimension, and the site remains on track to achieve the stream stability success criteria specified in the Restoration Plan.

## **2.0 INTRODUCTION**

### **2.1 PROJECT DESCRIPTION**

The Jones Creek wetland and stream restoration site is located near the Town of Wadesboro in Anson County, North Carolina (**Figure 1** and **Figure 2**). The site has a past history of agricultural use. Ditches on the site were used to increase subsurface drainage. Construction of the site, including planting of trees, was completed in December 2005. Groundwater, surface water, and rain gauges were functional throughout 2008.

Mitigation at the Jones Creek site involved stream restoration, stream preservation, wetland enhancement, and wetland restoration. Restoration of the site involved the restoration of a stable meandering channel. The channel was designed and constructed using natural channel design techniques. Restoration also involved raising the local water table by filling drainage ditches on-site and creation of microtopography across the site. **Table 1** shows the as-built lengths and restoration type for each reach.

**Table 1. Project Mitigation Structure and Objectives**

<b>Reach Name</b>	<b>As-Built Length (ft)</b>	<b>Restoration Approach</b>
<b>Stream</b>		
Mill Branch	1855	Stream Restoration
UT1	1213	Stream Restoration
<b>Total</b>	<b>3068</b>	
South Fork Jones Creek	5150	Stream Preservation
<b>Wetland</b>		
	25.0 acres	Restoration
	2.7 acres	Enhancement

### **2.2 PROJECT PURPOSE**

Monitoring of the Jones Creek Site is required to demonstrate successful restoration based on the criteria found in the Restoration Plan and through a comparison to reference site conditions. Hydrologic, vegetation, and stream monitoring are conducted on an annual basis. Success criteria must be met for five consecutive years. This Annual Report details the results of the monitoring efforts for 2008 (Year 3) at the Jones Creek Mitigation Site.

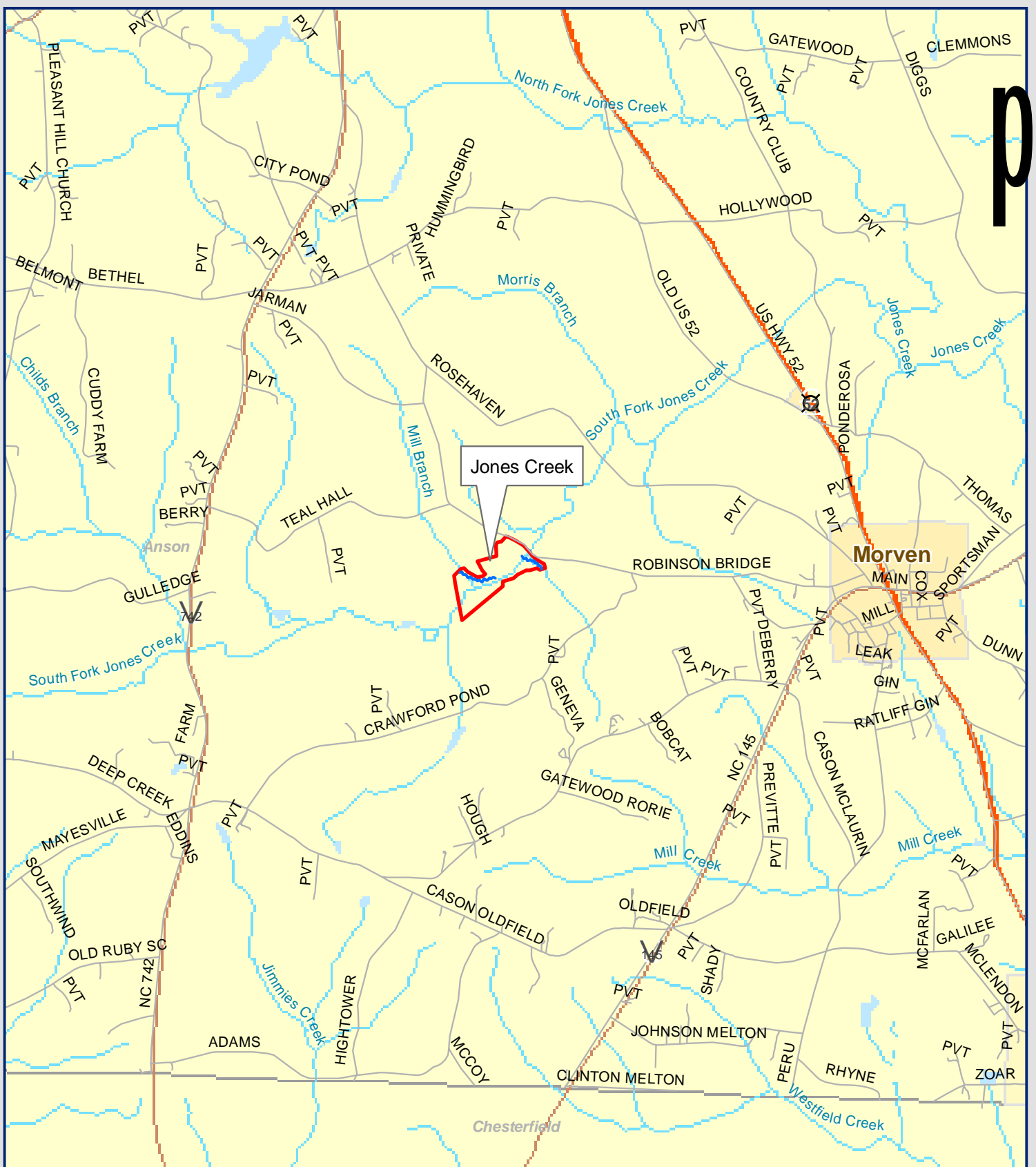
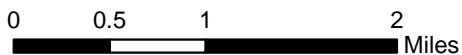
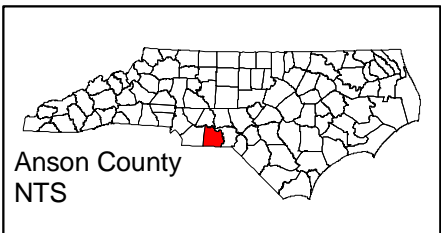

Figure 1  
 Jones Creek Site  
 Anson County  
 Vicinity Map



**Legend**

- Streams
- Roads
- Jones Creek Site





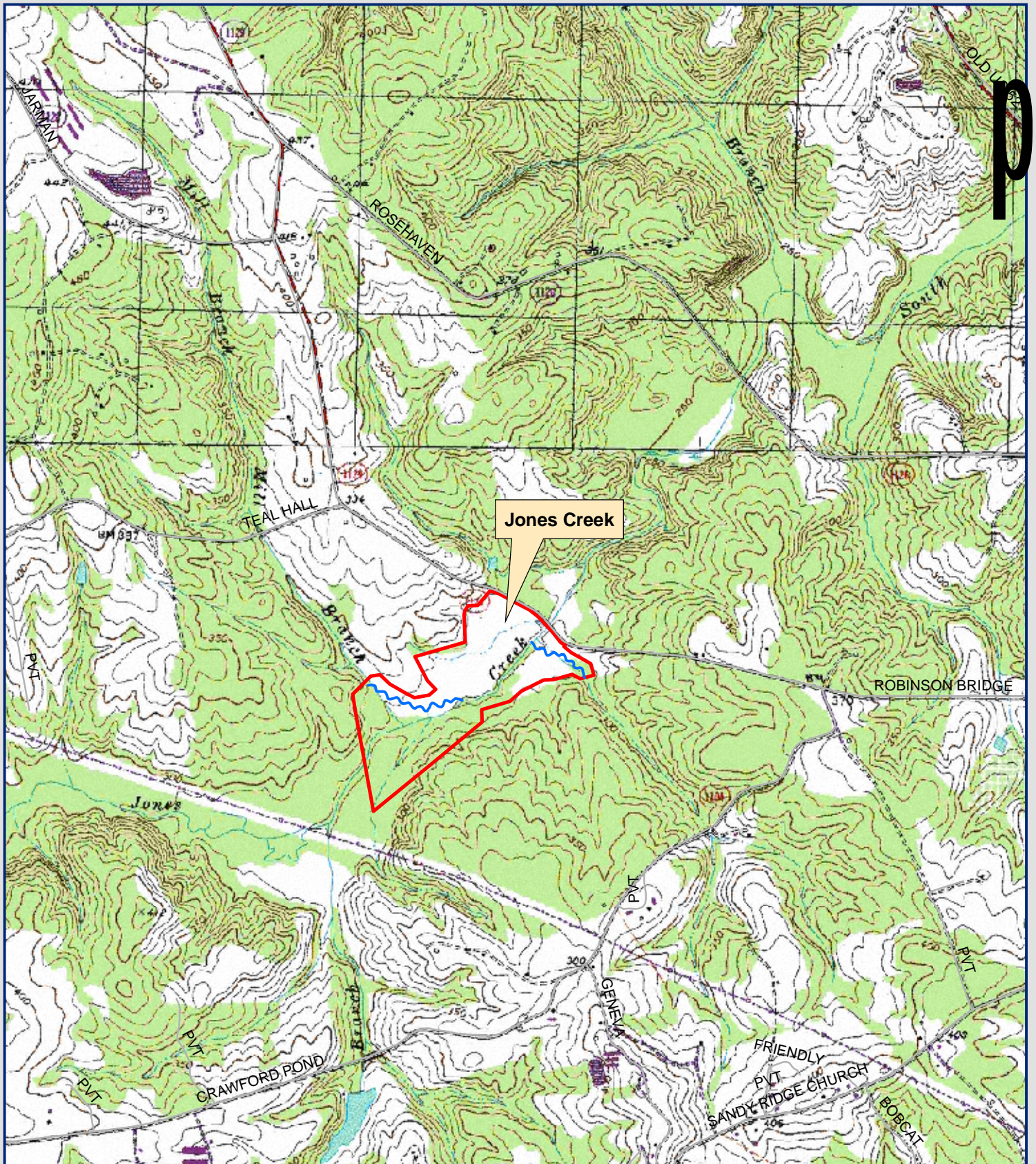

p



Figure 2  
 Jones Creek Site  
 Anson County  
 USGS Map

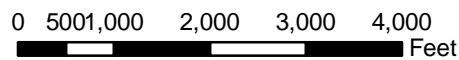

- Streams
- Roads
- Jones Creek Site



## 2.3 PROJECT HISTORY & SCHEDULE

**Table 2. Project Activity and Reporting History**

Month	Activity
December 2005	Construction Completed
March 2006	Post-restoration Monitoring Begins
November 2006	1st Annual Monitoring Report
November 2007	2nd Annual Monitoring Report
November 2008	3rd Annual Monitoring Report
November 2009 (scheduled)	4th Annual Monitoring Report
November 2010 (scheduled)	5th Annual Monitoring Report

**Table 3. Project Contacts**

Contact	Firm Information
<b>Project Manager</b> Norton Webster	EBX-Neuse 1, LLC (919) 608-9688
<b>Designer</b> Kevin Tweedy, PE	Buck Engineering PC (919) 463-5488
<b>Monitoring Contractor</b> Daniel Ingram	WK Dickson and Co., Inc (919) 782-0495

## 3.0 HYDROLOGY

### 3.1 HYDROLOGIC SUCCESS CRITERIA

As stated in the approved Restoration Plan, to meet the hydrologic success criteria the hydrology monitoring data must show that for each normal year of rainfall within the monitoring period the site has been inundated or saturated within 12 inches of the soil surface for a minimum of 7 percent of the growing season (16 days). The day counts are based on the growing season for Anson County, which is 225 days long (24 March– 5 November). Groundwater data are collected from 14 automated groundwater gauges. The Restoration Plan further specifies that precipitation must be within or below normal limits for the hydrologic data to be considered successful.

### 3.2 DESCRIPTION OF HYDROLOGY MONITORING EFFORTS

Fourteen automated groundwater gauges were installed to monitor hydrology during the 2007 growing season. **Figure 3** displays the gauge locations. The gauges are checked and the data downloaded monthly. During the monthly site visits all automated gauges, calibration gauges, crest gauges, and the rain gauge are read.

#### *Automated Gauges*

Automatic groundwater gauges record water table elevations twice daily at 08:00 and 20:00. Infinity gauges employ pressure sensors that record water elevation above the bottom of the sensor (with atmospheric pressure compensation). Immediately adjacent to each automatic gauge is a manual calibration gauge. The calibration water table depth is recorded at monthly downloads. To determine wetland hydroperiods, the automatically recorded data are compared to the calibration data to determine a standard correction factor between the calibration gauge and the automatic gauge for each location. The standard correction factor is applied to correct daily readings. The corrected daily readings are then used to determine wetland hydroperiods.



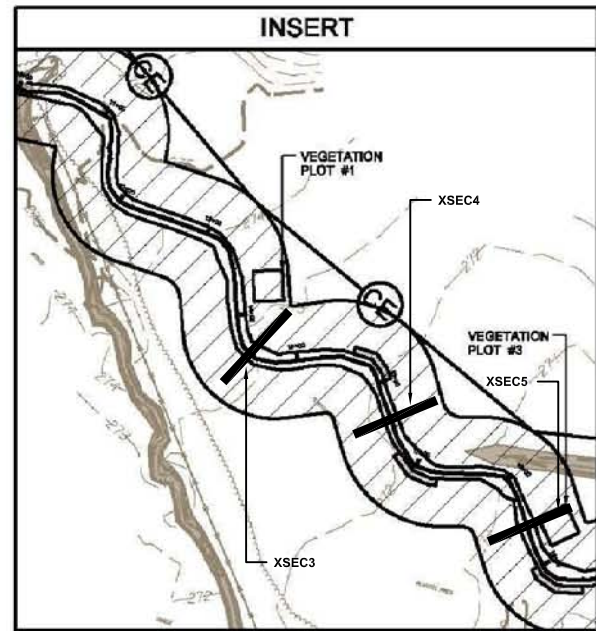

WETLAND HYDROPERIOD

- > 7 %
- ◐ 5-7 %
- < 5 %

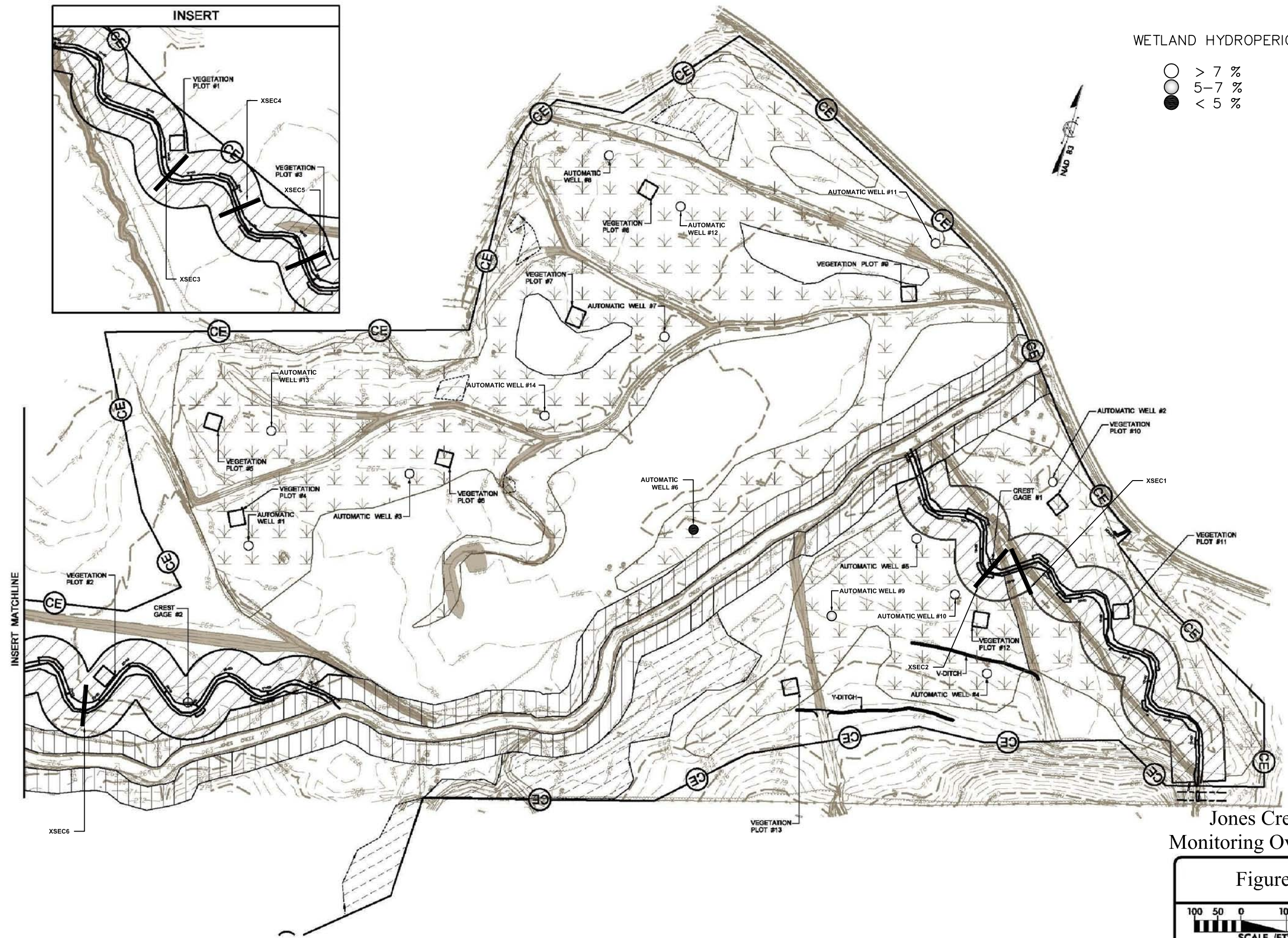

Jones Creek  
Monitoring Overview

Figure 3

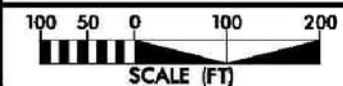



*Data Interpretation*

Wetland hydroperiods are calculated from twice daily water table depth elevations. A hydroperiod is calculated if the water table is equal to or less than -12 inches below ground surface for at least 24 hours. If a gauge falls below -12 inches for two consecutive readings (24 hours), then the hydroperiod ends at the last reading within -12 inches. If a gauge falls below -12 inches for only one reading then maintains a reading above -12 inches for a minimum of 24 hours, the hydroperiod is calculated continuously. This methodology accounts for minor technical malfunctions experienced by the automatic gauges.

**3.3 RESULTS OF HYDROLOGY MONITORING**

**3.3.1 Site Data**

The following hydroperiod statistics were calculated for each monitoring station during the growing season: 1) most consecutive days that the water table was within twelve inches of the soil surface; 2) cumulative number of days that the water table was within twelve inches of the soil surface; and 3) number of times that the water table rose to within twelve inches of the soil surface. The results of these calculations are presented in **Table 4**. The location of the groundwater and the stream gauges are shown in **Figures 3**. **Figures 4a-4d** provide charts of the water table depth for each of the monitoring gauges. **Appendix C** contains all the 2008 gauge data.

**Table 4. Hydrologic Monitoring Results**

Gauge	Consecutive		Cumulative		Occurrences
	Days	Percent of Growing Season	Days	Percent of Growing Season	
Jon AW1	32	14	104	46	16
Jon AW2	32	14	131	58	16
Jon AW3	17	7	99	44	15
Jon AW4	57	25	150	67	9
Jon AW5	55	24	153	68	9
Jon AW6	6	3	16	7	5
Jon AW7	85	38	173	77	5
Jon AW8	61	27	178	79	8
Jon AW9	14	6	57	25	10
Jon AW10	28	12	122	54	13
Jon AW11	61	27	170	76	8
Jon AW12	32	14	138	61	11
Jon AW13	32	14	126	56	13
Jon AW14	22	10	82	36	15
Jon RAW1	34	15	90	40	8
Jon RAW2	50	22	156	69	8
Jon RAW3	50	22	155	69	8

Figure 4a. Groundwater Hydrographs 1-4

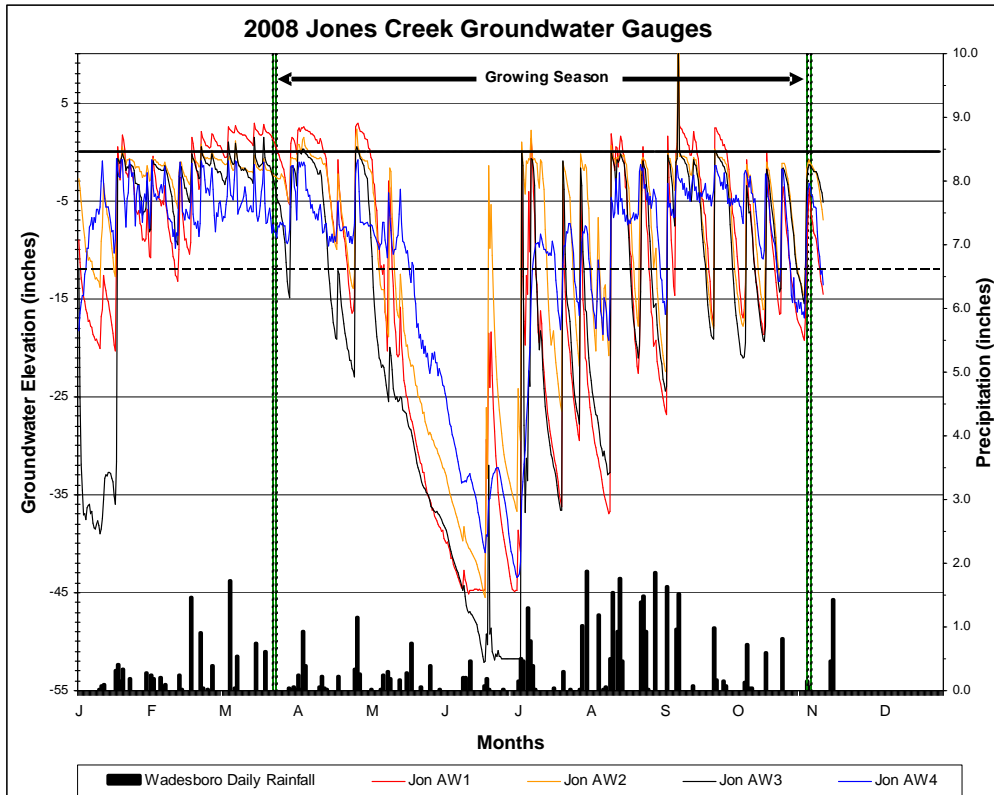

Figure 4b. Groundwater Hydrographs 5-8

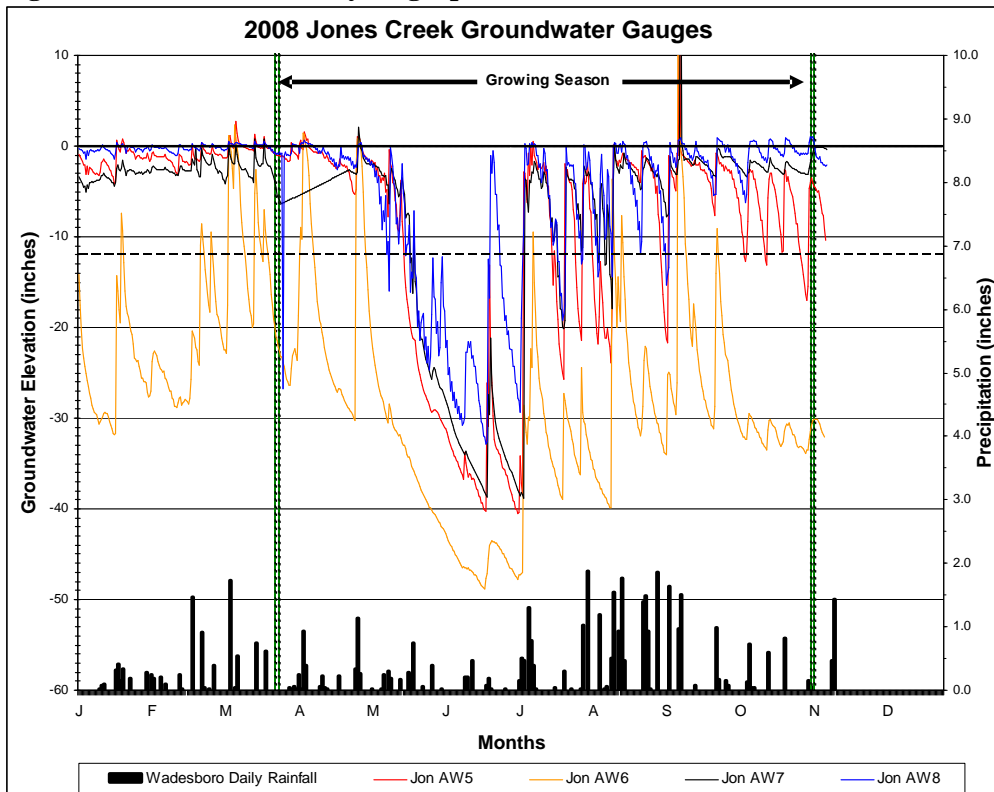

Figure 4c. Groundwater Hydrographs 9-12

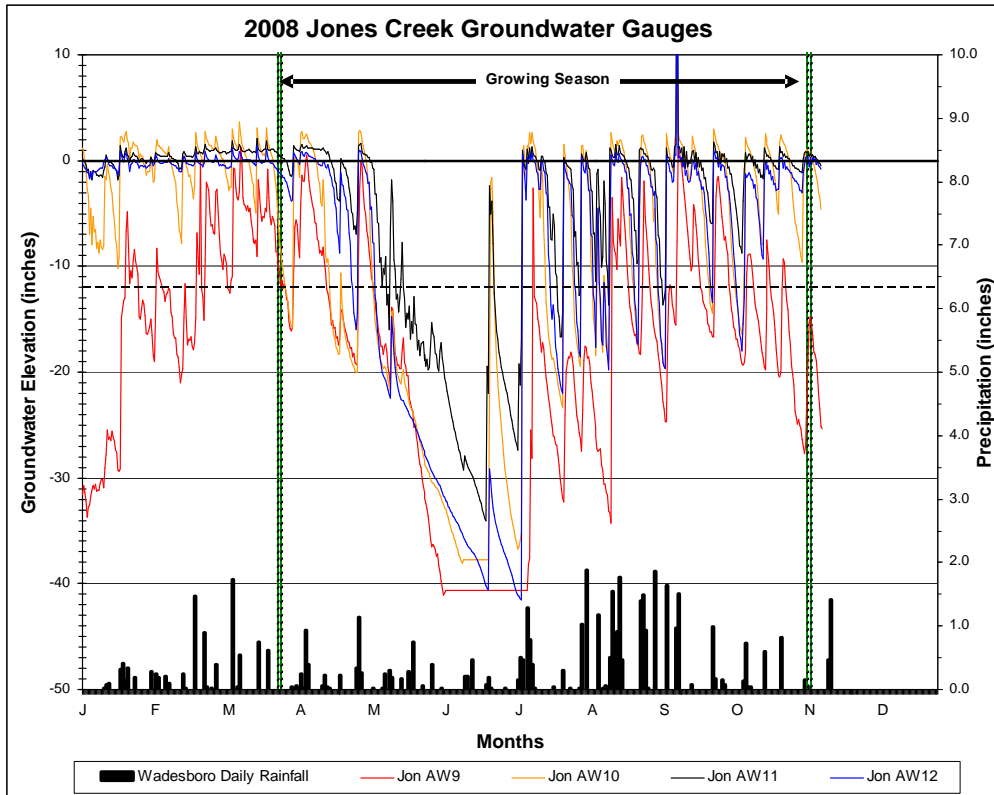
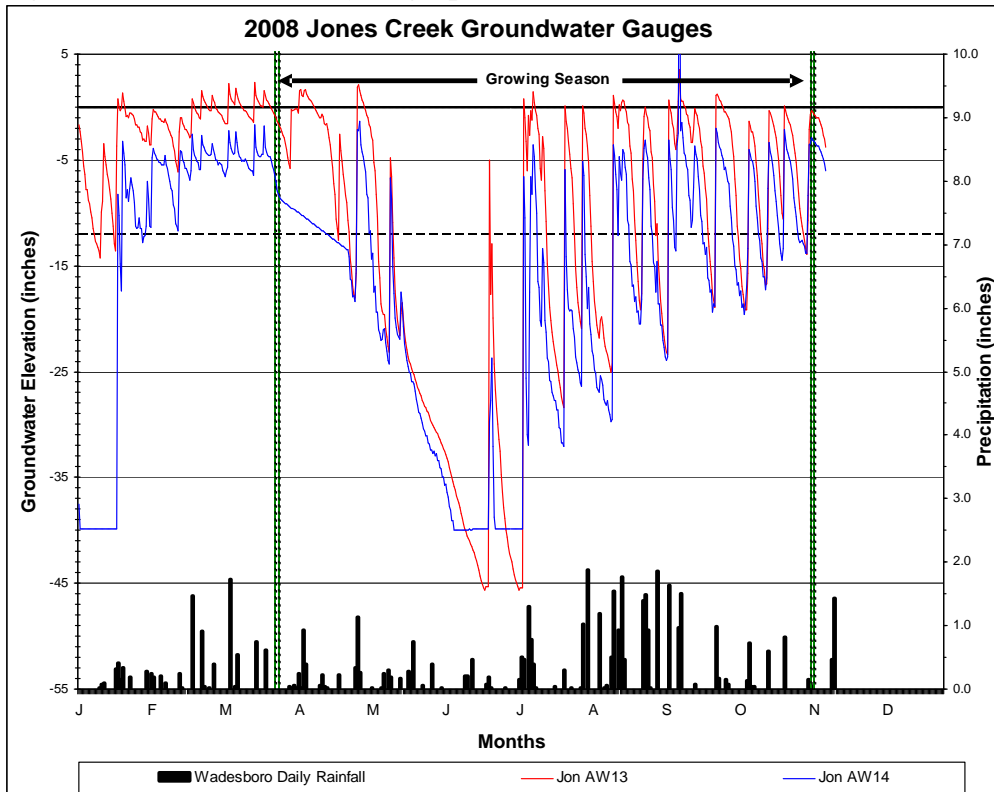

Figure 4d. Groundwater Hydrographs 13-14





### 3.3.2 Reference Data

The Restoration Plan provides that if rainfall for any monitoring year is outside of normal limits reference wetland data can be used to determine if there is a positive correlation between performance on the restoration site and the natural hydrology on the reference site.

Three reference gauges were installed in the Pee Dee National Wildlife Refuge in July 2006. The reference gauges are located in a wetland on the floodplain of Brown Creek. In September 2008, Reference Gauge AW1 experienced a maximum wetland hydroperiod of 15 percent of the growing season, and Reference Gauges AW2 and AW3 each experienced maximum hydroperiods of 22 percent of the growing season. **Figure 5** and **Table 4** present the reference gauge data.

**Figure 5. Reference Hydrographs**

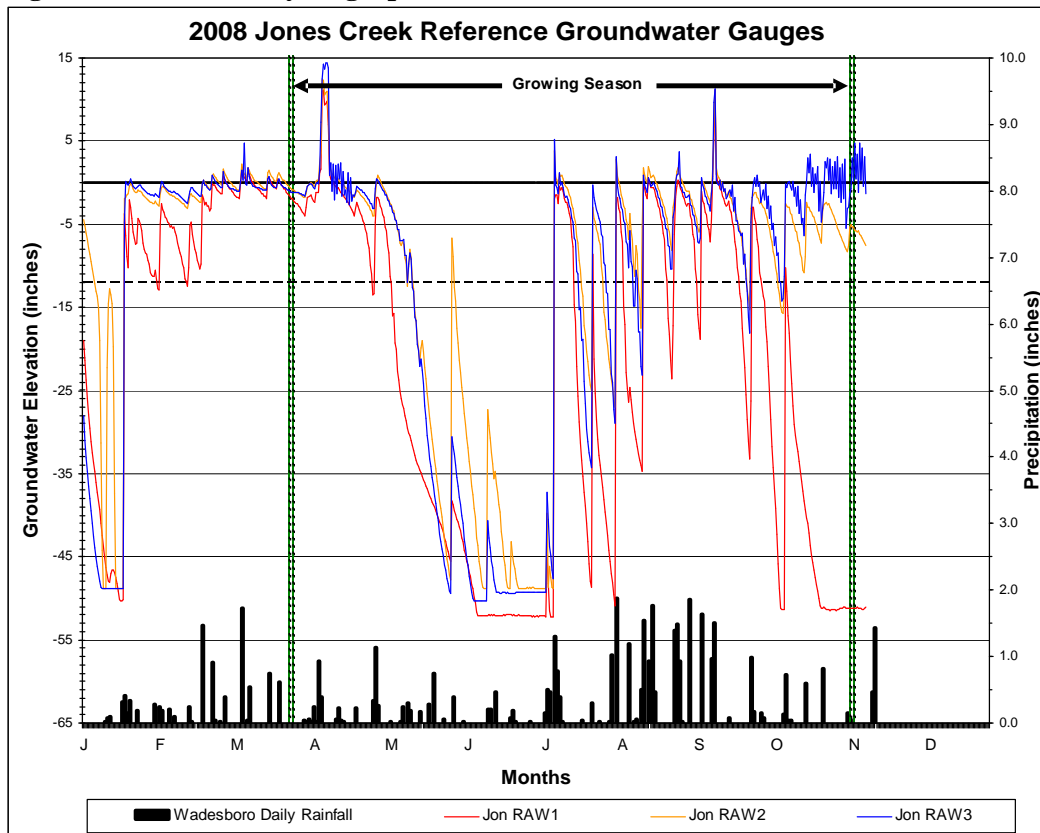

### 3.3.3 Climate Data

**Figure 5** is a comparison of the 2008 monthly rainfall to historical precipitation for Anson County (NRCS WETS Tables). Observed precipitation data were collected from the Wadesboro automated weather station and an on-site manual rain gauge. Rainfall data collected from the on-site rain gauge showed amounts slightly higher than those taken from the Wadesboro weather station, except in the months of April, August, and September. Rainfall amounts from both the on-site gauge and from the weather station show rainfall amounts near those of the historic average through July, and in October and November. August and September rainfall exceeded normal limits due to tropical rain events. Monthly rainfall amounts for December were not available at the time this report was prepared.

**Figure 6. 2008 Rainfall**

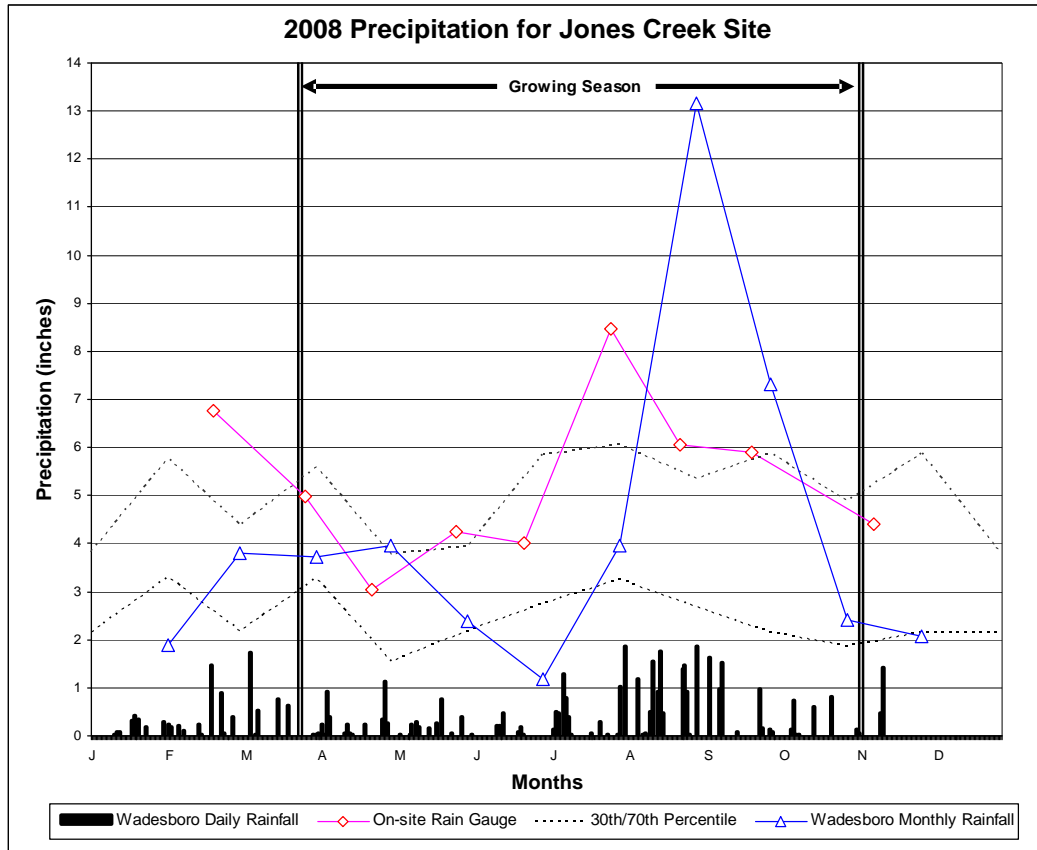

**Table 5. Comparison of Normal Rainfall to Observed Rainfall**

Month	Average	Normal Limits		Wadesboro Precipitation	On-Site Precipitation
		30 Percent	70 Percent		
January	4.66	3.31	5.78	1.88	---
February	3.56	2.18	4.37	3.79	6.76
March	4.61	3.28	5.58	3.71	4.97
April	2.94	1.54	3.78	3.96	3.03
May	3.44	2.18	3.93	2.39	4.26
June	4.56	2.74	5.84	1.19	4.00
July	5.26	3.26	6.06	3.95	8.47
August	4.41	2.67	5.36	13.16	6.05
September	4.25	2.15	5.87	7.32	5.90
October	3.66	1.85	4.87	2.41	*
November	3.10	2.14	3.86	2.07	4.40
December	3.28	2.16	3.83	---	---
<b>Total</b>	<b>47.73</b>	<b>29.46</b>	<b>59.13</b>	<b>45.83</b>	<b>47.84</b>

\*One reading was taken on Nov. 11, which reflects precipitation for October through early November.

### **3.4 HYDROLOGIC CONCLUSIONS**

Data collected from the groundwater gauges on the Jones Creek Mitigation Site indicate that 12 of 14 hydrology monitoring stations recorded a hydroperiod of at least 7 percent of the growing season. JCAW6 and JCAW9 monitoring gauges did not meet the 7 percent success criteria as defined in the Restoration Plan. However, JCAW6 met the 7 percent hydroperiod criteria within 25 inches of the soil surface and JCAW9 met the 7 percent hydroperiod criteria within 14 inches of the surface, and exhibited hydroperiods of 3 and 6 percent of the growing season, respectively. Based on the results of the first three years of groundwater monitoring, most of the site appears to be performing as designed, and the entire site is within the range of conditions expected in undisturbed floodplain wetlands.

## **4.0 VEGETATION**

### **4.1 VEGETATION SUCCESS CRITERIA**

The interim measure of vegetative success for the Jones Creek Mitigation Plan is the survival of at least 320 3-year old planted trees per acre at the end of year three of the monitoring period. The final vegetative success criteria will be the survival of 260 5-year old planted trees per acre at the end of year five of the monitoring period.

Up to 20 percent of the site species composition may be comprised of invaders. Remedial action may be required should these (i.e. loblolly pine, red maple, sweetgum, etc.) present a problem and exceed 20 percent composition.

### **4.2 DESCRIPTION OF SPECIES AND VEGETATION MONITORING**

The following monitoring protocol was designed to predict vegetative survivability. Thirteen plots were established on the Jones Creek Site to monitor approximately one percent of the site. Four plots are located adjacent to newly constructed streambeds to monitor the vegetation in the stream restoration buffer. The other nine plots are indiscriminately located to represent the range of conditions that exist on the site. The plots were randomly located within each zone and randomly oriented within the wetland restoration area.

Plot construction consists of metal fence posts at each of the four corners to clearly and permanently establish the area that was to be sampled. Then ropes were hung connecting all four corners to help in determining if trees close to the plot boundary were inside or outside of the plot. Trees right on the boundary and trees just outside of the boundary that appear to have greater than 50 percent of their canopy inside the boundary were counted inside the plot. A piece of white PVC pipe ten feet tall was placed over the metal post on one corner to facilitate visual location of site throughout the five-year monitoring period.

All of the planted stems inside the plot were flagged with orange flagging and marked with a three foot tall piece of half inch PVC to mark them as the planted stems (vs. any colonizers) and to help in locating them in the future. Each stem was then tagged with a permanent numbered aluminum tag. **Table 5** describes the planted tree species.

**Table 6. Planted Tree Species**

ID	Common Name	Scientific Name	FAC Status
1	Swamp Chestnut Oak	<i>Quercus michauxii</i>	FACW-
2	Willow Oak	<i>Quercus phellos</i>	FACW-
3	River Birch	<i>Betula nigra</i>	FACW
4	Sycamore	<i>Platanus occidentalis</i>	FACW-
5	Sugar Berry	<i>Celtis laevigata</i>	FACW
6	Yellow Poplar	<i>Liriodendron tulipifera</i>	FAC
7	Swamp Tupelo	<i>Nyssa biflora</i>	OBL
8	Overcup Oak	<i>Quercus lyrata</i>	OBL
9	Green Ash	<i>Fraxinus pennsylvanica</i>	FACW

### 4.3 RESULTS OF VEGETATION MONITORING

The following tables present stem counts for each of the monitoring plot. Each planted tree species is identified across the top row, and each plot is identified down the left column. The numbers on the top row correlate to the ID column of the previous table. Trees are flagged in the field on an as need basis before the flags degrade. Flags are utilized, because they will not interfere with the growth of the tree. Volunteers are also flagged during this process. Annual variation in stem count data can be attributed to mortality and regeneration from root stock of stems previously assessed to be dead.

**Table 7. 2008 Vegetation Monitoring Plot Species Composition**

Plot	1	2	3	4	5	6	7	8	9	Total	Stems per Acre
JO 1	0	0	1	3	7	1	0	0	4	16	640
JO 2	1	0	2	2	4	1	0	0	2	12	480
JO 3	0	1	1	6	0	0	0	3	2	13	520
JO 4	2	2	2	2	0	0	0	4	0	12	480
JO 5	0	1	1	8	2	1	0	3	1	17	680
JO 6	4	0	2	5	0	0	0	1	1	13	520
JO 7	4	2	0	3	0	0	4	0	3	16	640
JO 8	2	1	3	0	0	0	3	0	3	12	480
JO 9	5	3	2	0	0	0	3	0	4	17	680
JO 10	1	2	2	3	0	0	1	1	4	14	560
JO 11	2	0	0	4	1	2	1	0	6	16	640
JO 12	1	5	0	2	0	2	0	0	3	13	520
JO 13	1	2	0	3	0	0	6	1	4	17	680

Average Stems per Acre: 578

Range of Stems per Acre: 480-680

Volunteer species are also monitored throughout the five-year monitoring period. Below is a table of the most common woody volunteer species.

**Table 8. Volunteer species within the Wetland Restoration Area**

<b>ID</b>	<b>Scientific Name</b>	<b>Common Name</b>	<b>FAC Status</b>
A	<i>Liquidambar styraciflua</i>	Sweetgum	FAC+
B	<i>Diospyros virginiana</i>	Persimmon	FAC
C	<i>Pinus taeda</i>	Loblolly Pine	FAC

Very few volunteer woody species were observed in the vegetation plots, but many were found adjacent to the plugged irrigation ditches especially close to vegetation plots four and five. Regular maintenance of cutting and mowing will keep these woody volunteers from exceeding the acceptable amount of volunteers on the site. Sweetgum (*Liquidambar styraciflua*) is the most common volunteer.

#### **4.4 VEGETATION OBSERVATIONS & CONCLUSIONS**

After construction of the mitigation site, a permanent ground cover seed mixture of Virginia wild rye (*Elymus virginicus*), switch grass (*Panicum virgatum*), and fox sedge (*Carex vulpinoidea*) was broadcast on the site at a rate of 10 pounds per acre. These species are present on the site. Hydrophytic herbaceous vegetation, including rush (*Juncus effusus*), spikerush (*Eleocharis obtusa*), boxseed (*Ludwigia* spp.), false nettle (*Boehmeria cylindrica*), and sedge (*Carex* spp.), are observed across the site, particularly in areas of periodic inundation. There is a population of swamp thistle (*Cirsium muticus*) that is commonly found in boggy woodland and meadows the piedmont present throughout the site. The presence of these herbaceous wetland plants helps to confirm the presence of wetland hydrology on the site.

There are quite a few weedy species occurring on the site, though none seem to be posing any problems for the woody or herbaceous hydrophytic vegetation. Commonly seen weedy vegetation includes asters, goldenrod (*Solidago* spp.), broomsedge (*Andropogon* spp.), ragweed (*Ambrosia artemisiifolia*) and wild dill (*Foeniculum vulgare*). Any threatening weedy vegetation found in the future will be documented and discussed in tri-annual reports.

The site was planted in bottomland hardwood forest species in January 2006. There were thirteen vegetation-monitoring plots established throughout the planting areas. The data for 2008 documents that the site has achieved the initial success criteria of 320 trees per acre by the end of year three and is on track to achieve the final success criteria of 260 trees per acre by the end of year five.

## **5.0 STREAM MONITORING**

### **5.1 STREAM SUCCESS CRITERIA**

As stated in the approved Restoration Plan, the stream restoration success criteria for the site include the following:

- *Bankfull Events:* Two bankfull flow events must be documented within the five-year monitoring period.
- *Cross sections:* There should be little change in as-built cross sections. Cross sections shall be classified using the Rosgen stream classification method and all monitored cross sections should fall within the quantitative parameters defined for "E" or "C" type channels.

- *Longitudinal Profiles:* The longitudinal profiles should show that the bedform features are remaining stable, e.g. they are not aggrading or degrading. Bedforms observed should be consistent with those observed in "E" and "C" type channels.
- *Photo Reference Stations:* Photographs will be used to subjectively evaluate channel aggradation or degradation, bank erosion, success of riparian vegetation and effectiveness of erosion control measures.

## **5.2 STREAM MORPHOLOGY MONITORING PLAN**

To document the stated success criteria, the following monitoring program was instituted following construction completion on the Jones Creek Site:

### **5.2.1 Cross Sections**

Two permanent cross sections were installed per 1,000 linear feet of stream restoration work, with one of the locations being a riffle cross section and one location being a pool cross section. A total of 6 permanent cross sections were established across the mitigation site. Each cross section was marked on both banks with permanent pins to establish the exact transect used. Permanent cross section pins were surveyed and located relative to a common benchmark to facilitate easy comparison of year-to-year data. The annual cross section surveys include points measured at all breaks in slope, including top of bank, bankfull, inner berm, edge of water, and thalweg. Riffle cross sections are classified using the Rosgen stream classification system. Permanent cross sections for 2008 (Year 3) were surveyed in September 2008.

### **5.2.2 Longitudinal Profile**

A longitudinal profile of approximately 3,000 feet was surveyed along the restoration reach in Year 1. The longitudinal survey will take place in Years 3 and 5 as well. Measurements include thalweg, water surface, bankfull, and top of low bank. Each of these measurements is taken at the head of each feature, e.g. riffle, run, pool, and glide, and the max pool depth. A common benchmark will be used each year to facilitate comparison of year-to-year data. A longitudinal profile survey was conducted in September of 2008.

### **5.2.3 Hydrology**

Two crest gauges were installed on the site to document bankfull events (**Figure 3**). The gauges are checked monthly, and record the highest out-of-bank flow event that occurred during the past month.

### **5.2.4 Photo Reference Stations**

Photographs are used to visually document restoration success. Reference stations are marked with wooden stakes and Global Positioning Satellite (GPS) coordinates have been determined for each location. Reference photos are taken at each permanent cross section from both streambanks. The survey tape is centered in the photographs of the bank, and the water line is located in the lower edge of the frame with as much of the bank as possible included in each photo. In-stream structures (e.g., rock vanes, cross vanes, and constructed riffles) are also photographed. Photo reference stations will be photographed at least once per year for at least 5 years following construction.

### 5.3 STREAM MORPHOLOGY MONITORING RESULTS

#### 5.3.1 Cross Sections

The cross sections were surveyed during the monitoring setup, Year 1, Year 2, and in September 2008 for Year 3. The baseline data has been compared with the Year 1, Year 2, and Year 3 monitoring data in **Appendix B**. Compared to the documented data from the As-Built, Year 1, and Year 2 surveys, the Year 3 channel cross sections showed that overall stream dimensions remained stable during this third growing season. Some localized areas of bank erosion were noted; however, these adjustments are common and indicate a movement toward greater stability. There is very little difference between the baseline cross sections, and Years 1-3 cross sections.

#### 5.3.2 Longitudinal Profile

A longitudinal profile survey was conducted along two separate reaches of the restoration project, totaling approximately 3,000 linear feet. Survey was conducted for the entire length of both Mill Branch (STA 10+06.44 to STA 28+61.24), and UT1 (STA 10+00 to STA 22+12.76). The longitudinal profile information documents the elevations and locations of known streambed features and in-stream grade control structures according to the As-Built survey plans, as shown in **Appendix A**. The profile and cross sections show that there has been very little adjustment to stream profile or dimension since construction. **Table 9** summarizes stream areas requiring observation. **Figure 7** show the locations of the stream areas that require observation.

**Table 9. Stream Areas Requiring Observation**

SPA	Station	Description
1	UT1 20+25	Log wier undercut, bed appears stable
2	UT1 20+50	Left bank erosion; minor headcut
3	Mill Branch 11+60	Minor right bank erosion
4	Mill Branch 23+50	Beaver dam

#### 5.3.3 Hydrology

During the 2008 monitoring season, two crest gauges were monitored to determine if there were any out-of-bank flow events in the Mill Branch and UT1 stream channels. Between the months of February and September, three bankfull events have been documented during the monthly onsite visits (**Table 10**). Crest gauges 1 (in UT1) registered 2 out-of-bank flows, while crest gauge 2 (Mill Branch) registered one out-of-bank flow. The largest stream flow documented for Year 3 by the onsite crest gauges was a flow that occurred during September and was 1.5 feet above the bankfull stage. The hydrology success criteria have already been satisfied by bankfull events in previous monitoring years.

**Table 10. Crest Gauge Data**

<b>Month Recorded</b>	<b>Crest Gauge 1</b>	<b>Crest Gauge 2</b>
January	---	---
February	0.6	0.0
March	0.0	0.0
April	0.0	0.0
May	0.0	0.0
June	0.0	0.0
July	0.0	0.0
August	0.0	0.0
September	0.4	1.5
October	---	---
November	0.0	0.0
December	---	---



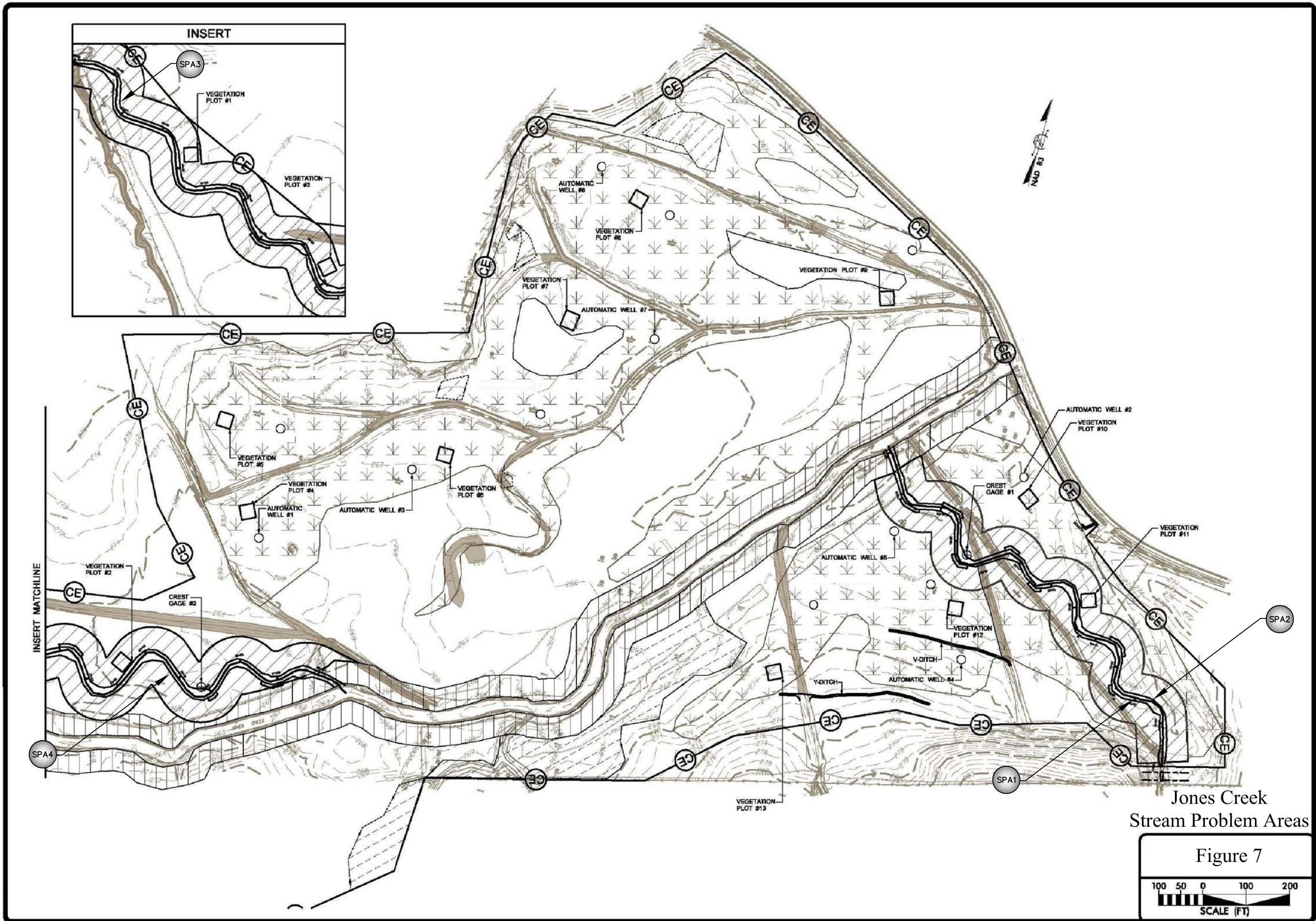

Jones Creek  
Stream Problem Areas

Figure 7

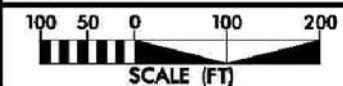



**Table 11. Summary of Morphologic Monitoring Parameters**

<b>Parameter</b>	<b>As-Built UT1</b>	<b>As-Built Mill Branch</b>	<b>Year 3 UT1</b>	<b>Year 3 Mill Branch</b>
Bankfull Xsec Area, Abkf (sq ft)	20.3	19.1	18.3	18.2
Avg. Bankfull Width, Wbkf (ft)	17.7	16.1	15.7	16.3
Bankfull W/D	15.4	13.5	13.4	14.7
Bankfull Mean Depth, Dbkf (ft)	1.1	1.2	1.2	1.1
Bankfull Max Depth, Dmax (ft)	2.0	2.1	2.0	2.1

#### **5.4 STREAM CONCLUSIONS**

In-stream structures installed within the restored stream included constructed riffles, log vanes, log weirs, rock step pools, J-hooks, rock cross vane, and root wads. Visual observations of structures throughout the 2008 growing season indicated that most structures are functioning as designed. One log weir on UT1 was washed out, a headcut has started to form just downstream of this structure and there is evidence of bank erosion. There is a beaver dam and one area of minor bank erosion in Mill Branch.

#### **6.0 CONCLUSIONS AND RECOMMENDATIONS**

- Third year hydrologic monitoring documented that suitable wetland hydrology conditions have been achieved on most of the site. Of the 14 hydrology monitoring gauges, twelve recorded hydroperiods of at least 7 percent of the growing season. The two remaining gauges recorded hydroperiods of 3 and 6 percent of the growing season. Based on the results of the first three years of monitoring, most of the site appears to be performing as designed.
- Stream morphology data collected during monitoring Year 3 and observations of conditions at the site indicate that the project continues to be successful. The stream morphology is generally stable. Most in-stream structures appear stable; however, the banks on either side of one log weir in UT1 are becoming washed out. It was concluded that the site continues to be on track to achieve the stream success criteria specified in the Restoration Plan.
- Vegetation monitoring efforts have calculated the average number of stems per acre on site to be 597, which is a survival rate of greater than 87 percent based on the initial planting count of 689 stems per acre. Vegetation survivability should remain excellent on site. The initial vegetative success criteria has been met and the site is on track to achieve the first vegetative success criteria at the end of monitoring year five. Some additional application of ground cover seed would help prevent soil erosion around Plots 11 and 12.
- Monitoring of wetland, stream and vegetation conditions will continue through the 2009 season (Year 4).

# **APPENDIX A**

## **As-Built Survey**

PROJECT: 0215R JONES CREEK

STREAM AND WETLAND RESTORATION PROJECT  
 EBX NEUSE - I, LLC  
 JONES CREEK AS-BUILT PLAN

STATE	BUCK PROJECT REFERENCE NO.	SHEET NO.	TOTAL SHEETS
NC	0215R	1	11
NO.	DATE	CHECKED BY	APPROVED BY
1	2/28/06	J. HUTTON	K. TWEEDY

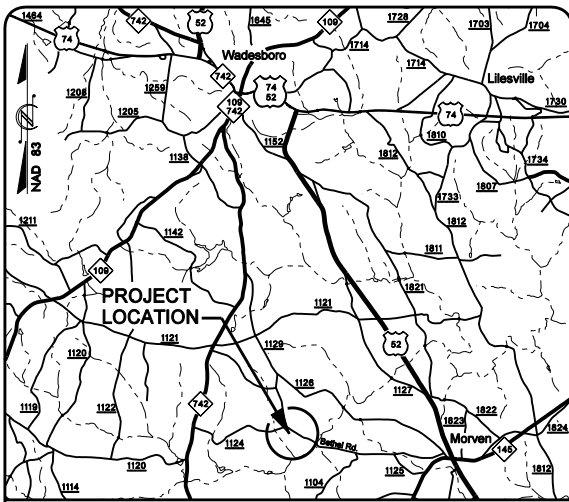

VICINITY MAP

**ANSON COUNTY**

LOCATION: 2 MILES WEST OF MORVEN OFF BETHEL RD.  
 (SR 1129; ROBINSON BRIDGE RD.)

- INDEX OF SHEETS**
- 1 ..... TITLE SHEET
  - 1-A ..... SYMBOLOGY - BUCK ENGINEERING VEGETATION SELECTION, AND STANDARD SPECIFICATIONS
  - 1-B ..... SYMBOLOGY - NCDOT
  - 2 THRU 2-C ..... STRUCTURE DETAILS
  - 3 THRU 4 ..... PLAN SHEETS
  - 5 ..... WETLAND AND MONITORING OVERVIEW
  - 6 ..... REVEGETATION

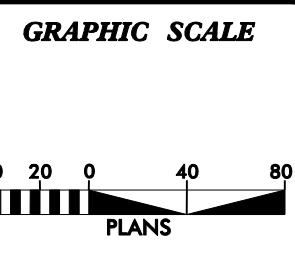
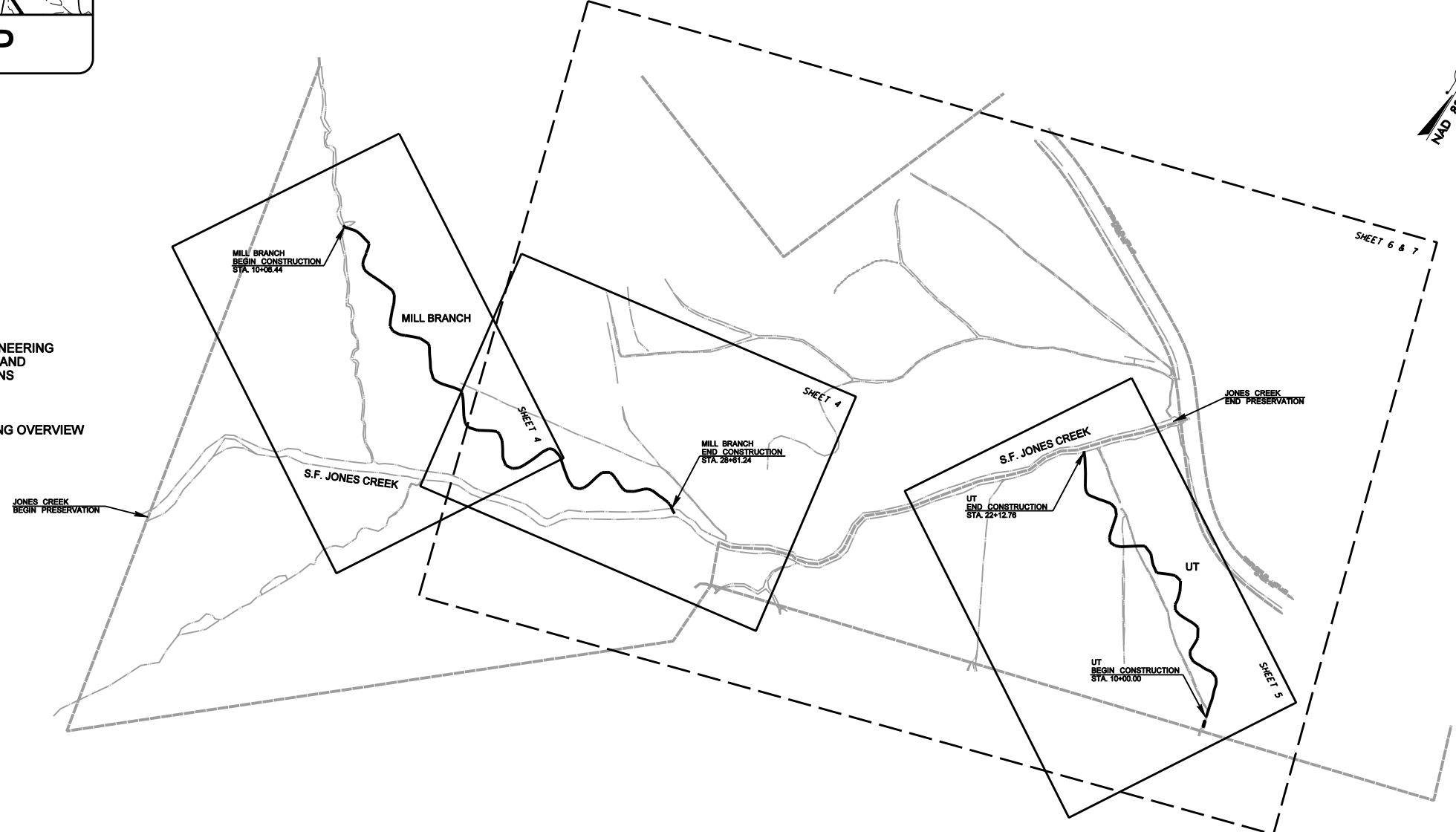

**PROJECT SUMMARY**

EXISTING STREAM LENGTH	=	1825 FEET
RESTORED MILL BRANCH LENGTH	=	1855 FEET
RESTORED UT LENGTH	=	1213 FEET
RESTORED STREAM LENGTH	=	3068 FEET
PRESERVATION STREAM LENGTH	=	5150 FEET
RESTORED WETLAND AREA	=	25.0 ACRES
ENHANCED WETLAND AREA	=	2.7 ACRES

PREPARED FOR THE OFFICE OF:  
**EBX NEUSE - I, LLC**



2530 MERIDIAN PARKWAY, SUITE 200  
 DURHAM, NORTH CAROLINA 27713

**EBX CONTACT:**  
**THOMAS L. RINKER**  
 PROJECT MANAGER

PREPARED IN THE OFFICE OF:  
**BUCK ENGINEERING**

8000 Regency Parkway, Suite 200  
 Cary, North Carolina 27511  
 Phone: 919-463-5488  
 Fax: 919-463-5490

DECEMBER 2005  
 COMPLETION DATE:

**KEVIN TWEEDY, PE**  
 PROJECT ENGINEER /MANAGER













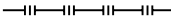







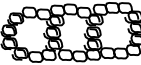



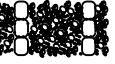

**PROJECT ENGINEER**

THIS DOCUMENT ORIGINALLY ISSUED AND SEALED BY:  
 KEVIN L. TWEEDY  
 027337  
 APRIL 4, 2006

THIS MEDIA SHALL NOT BE CONSIDERED A CERTIFIED DOCUMENT

SIGNATURE: \_\_\_\_\_ P.E.

STREAM CONVENTIONAL SYMBOLS  
SUPERCEDES SHEET 1B

	LOG VANE		BOULDER CLUSTER
	LOG WEIR		SILT FENCE
	ROOT WAD		SAFETY FENCE
	LOG CROSS VANE		CONSERVATION EASEMENT
	J-HOOK		TRANSPLANTED VEGETATION
	ROCK VANE		ROCK STEP POOL
	TEMPORARY SILT CHECK		TREE REMOVAL
	FOOT BRIDGE		TREE PROTECTION
	TEMPORARY STREAM CROSSING		PLAY GROUND EQUIPMENT
	PERMANENT STREAM CROSSING		CONSTRUCTED RIFFLE
	ROCK CROSS VANE		TRANSPLANTS
	WING DEFLECTOR		FILL EXISTING CHANNEL
	DOUBLE WING DEFLECTOR		CONTROL POINT
	DOUBLE DROP CROSS VANE		

STANDARD SPECIFICATIONS

EROSION AND SEDIMENT CONTROL PLANNING AND DESIGN MANUAL  
DECEMBER 1993

- 6.60 TEMPORARY SEDIMENT TRAP
- 6.06 CONSTRUCTION ACCESS
- 6.62 SILT FENCE
- 6.70 TEMPORARY (FORD) STREAM CROSSING

PROJECT REFERENCE NO. <b>0215R</b>	SHEET NO. <b>1-A</b>
PROJECT ENGINEER	
THIS DOCUMENT ORIGINALLY ISSUED AND SEALED BY:	
KEVIN L. TWEEDY 027337 APRIL 4, 2006	
THIS MEDIA SHALL NOT BE CONSIDERED A CERTIFIED DOCUMENT	
 8000 Regency Parkway Suite 200 Cary, North Carolina 27511 Phone: 919-463-5488 Fax: 919-463-5490	

GENERAL NOTES

- The Contractor is required to install instream structures using a track hoe with a hydraulic thumb of sufficient size to move boulders 3ft X 3ft X 2ft (approximately 2 tons).
- The Contractor will be required to provide, at a minimum, two operators at all times during construction of the new stream channel. In general, one operator will cut the new channel with a track hoe, while the other operator follows and installs instream structures, bank stabilization practices, and transplants. During construction of the new stream channel, the contractor will be required to have two track hoes and one loader on-site.

VEGETATION SELECTION

BARE ROOT VEGETATION		
ZONE 1 (Wetland Restoration and Enhancement Areas)		
COMMON NAME	SCIENTIFIC NAME	PERCENT PLANTED BY SPECIES
SWAMP CHESTNUT OAK	<i>Quercus michauxii</i>	14 %
BLACK WILLOW	<i>Salix nigra</i>	5 %
GREEN ASH	<i>Fraxinus pennsylvanica</i>	13 %
RIVER BIRCH	<i>Betula nigra</i>	14 %
BLACK GUM	<i>Nyssa sylvatica</i>	14 %
WILLOW OAK	<i>Quercus phellos</i>	20 %
SYCAMORE	<i>Platanus occidentalis</i>	20 %
ZONE 2 and 3 (Stream Restoration Buffer)		
SYCAMORE	<i>Platanus occidentalis</i>	21 %
RIVER BIRCH	<i>Betula nigra</i>	21 %
HACKBERRY	<i>Celtis laevigata</i>	13 %
SWAMP CHESTNUT OAK	<i>Quercus michauxii</i>	13 %
GREEN ASH	<i>Fraxinus pennsylvanica</i>	21 %
TULIP POPLAR	<i>Liriodendron tulipifera</i>	11 %

LIVE STAKE VEGETATION		
NOTE: Live stakes were installed randomly 2 to 3 feet apart along the streambanks from the toe of the bank to the top of the bank.		
COMMON NAME	SCIENTIFIC NAME	NUMBER PLANTED
SILKY DOGWOOD	<i>Cornus Amomum</i>	900
BLACK WILLOW	<i>Salix nigra</i>	900
ELDERBERRY	<i>Sambucus canadensis</i>	900

PERMANENT SEED MIXTURE				
ZONE 1, 2, and 3				
COMMON NAME	SCIENTIFIC NAME	PERCENT OF MIXTURE	SEEDING DENSITY (lbs/acre)	WETNESS TOLERANCE
REDTOP	<i>Agrostis alba</i>	10 %	1.5	FACW
VIRGINIA WILDRYE	<i>Elymus virginicus</i>	15 %	2.25	FAC
SWITCHGRASS	<i>Panicum virgatum</i>	15 %	2.25	FAC+
EASTERN GAMMA GRASS	<i>Tripsicum dactyloides</i>	5 %	0.75	FAC+
PENNSYLVANIA SMARTWEED	<i>Polygonum pennsylvanicum</i>	5 %	0.75	FACW
LITTLE BLUE STEM	<i>Schizachyrium scoparium</i>	5 %	0.75	FACU
SOFT RUSH	<i>Juncus effusus</i>	5 %	0.75	FACW+
BEGGARS TICK	<i>Bidens frondosa (or aristosa)</i>	10 %	1.5	FACW
LANCE-LEAVED TICK SEED	<i>Coreopsis lanceolata</i>	10 %	1.5	FACU
TIOGA DEER TONGUE	<i>Panicum clandestinum</i>	10 %	1.5	FAC
BIG BLUE STEM	<i>Andropogon gerardii</i>	5 %	0.75	FAC
INDIAN GRASS	<i>Sorghastrum nutans</i>	5 %	0.75	FACU
TEMPORARY SEED MIXTURE				
NOTE: Temporary seeding were applied to all disturbed areas of the site that were susceptible to erosion. These areas included constructed streambanks, access roads, side-slopes, spoil piles, etc. Rye grain was used and applied at a rate of 130 lbs/acre.				

STATE OF NORTH CAROLINA  
DIVISION OF HIGHWAYS

\*S.U.E = SUBSURFACE UTILITY ENGINEER

CONVENTIONAL SYMBOLS

ROADS & RELATED ITEMS

Edge of Pavement	----
Curb	====
Prop. Slope Stakes Cut	---C---
Prop. Slope Stakes Fill	---F---
Prop. Woven Wire Fence	○-○
Prop. Chain Link Fence	□-□
Prop. Barbed Wire Fence	◇-◇
Prop. Wheelchair Ramp	WCR
Curb Cut for Future Wheelchair Ramp	CCFR
Exist. Guardrail	+
Prop. Guardrail	+
Equality Symbol	⊕
Pavement Removal	XXXX

RIGHT OF WAY

Baseline Control Point	◆
Existing Right of Way Marker	△
Exist. Right of Way Line w/Marker	—△—
Prop. Right of Way Line with Proposed	—▲—
R/W Marker (Iron Pin & Cap)	▲
Prop. Right of Way Line with Proposed (Concrete or Granite) R/W Marker	●
Exist. Control of Access Line	⊙
Prop. Control of Access Line	⊙
Exist. Easement Line	—E—
Prop. Temp. Construction Easement Line	—E—
Prop. Temp. Drainage Easement Line	—TDE—
Prop. Perm. Drainage Easement Line	—PDE—

HYDROLOGY

Stream or Body of Water	~~~~~
River Basin Buffer	—RBB—
Flow Arrow	→
Disappearing Stream	Y
Spring	⊙
Swamp Marsh	⌵
Shoreline	----
Falls, Rapids	—t—
Prop Lateral, Tail, Head Ditches	← FLOW

STRUCTURES

MAJOR Bridge, Tunnel, or Box Culvert	—CONC—
Bridge Wing Wall, Head Wall and End Wall	)CONC WW(

MINOR Head & End Wall	—CONC HW—
Pipe Culvert	====
Footbridge	—>—<—
Drainage Boxes	□ CB
Paved Ditch Gutter	—

UTILITIES

Exist. Pole	●
Exist. Power Pole	⊙
Prop. Power Pole	⊙
Exist. Telephone Pole	⊙
Prop. Telephone Pole	⊙
Exist. Joint Use Pole	⊕
Prop. Joint Use Pole	⊕
Telephone Pedestal	⊠
UG Telephone Cable Hand Hold	⊠
Cable TV Pedestal	⊠
UG TV Cable Hand Hold	⊠
UG Power Cable Hand Hold	⊠
Hydrant	⊕
Satellite Dish	⊕
Exist. Water Valve	⊕
Sewer Clean Out	⊕
Power Manhole	⊕
Telephone Booth	⊠
Cellular Telephone Tower	⊠
Water Manhole	⊕
Light Pole	⊕
H-Frame Pole	⊕
Power Line Tower	⊕
Pole with Base	⊕
Gas Valve	⊕
Gas Meter	⊕
Telephone Manhole	⊕
Power Transformer	⊕
Sanitary Sewer Manhole	⊕
Storm Sewer Manhole	⊕
Tank; Water, Gas, Oil	⊕
Water Tank With Legs	⊕
Traffic Signal Junction Box	⊕
Fiber Optic Splice Box	⊕
Television or Radio Tower	⊕
Utility Power Line Connects to Traffic Signal Lines Cut Into the Pavement	—TS—TS—

Recorded Water Line	—■—■—
Designated Water Line (S.U.E.*)	—■—■—
Sanitary Sewer	—SS—SS—
Recorded Sanitary Sewer Force Main	—FSS—FSS—
Designated Sanitary Sewer Force Main(S.U.E.*)	—FSS—FSS—
Recorded Gas Line	—G—G—
Designated Gas Line (S.U.E.*)	—G—G—
Storm Sewer	—S—S—
Recorded Power Line	—P—P—
Designated Power Line (S.U.E.*)	—P—P—
Recorded Telephone Cable	—T—T—
Designated Telephone Cable (S.U.E.*)	—T—T—
Recorded U/G Telephone Conduit	—TC—TC—
Designated U/G Telephone Conduit (S.U.E.*)	—TC—TC—
Unknown Utility (S.U.E.*)	—?UTL—?UTL—
Recorded Television Cable	—TV—TV—
Designated Television Cable (S.U.E.*)	—TV—TV—
Recorded Fiber Optics Cable	—FO—FO—
Designated Fiber Optics Cable (S.U.E.*)	—FO—FO—
Exist. Water Meter	⊙
UG Test Hole (S.U.E.*)	⊕
Abandoned According to U/G Record	ATTUR
End of Information	E.O.I.

BOUNDARIES & PROPERTIES

State Line	—
County Line	—
Township Line	—
City Line	—
Reservation Line	—
Property Line	—
Property Line Symbol	⊕
Exist. Iron Pin	⊕
Property Corner	⊕
Property Monument	⊕
Property Number	123
Parcel Number	6
Fence Line	—X—X—X—
Existing Wetland Boundaries	—WW & ISBW—
High Quality Wetland Boundary	—HO WLB—
Medium Quality Wetland Boundaries	—MO WLB—
Low Quality Wetland Boundaries	—LO WLB—
Proposed Wetland Boundaries	—WLB—
Existing Endangered Animal Boundaries	—EAB—
Existing Endangered Plant Boundaries	—EPB—

BUILDINGS & OTHER CULTURE

Buildings	⊠
Foundations	⊠
Area Outline	⊠
Gate	⊠
Gas Pump Vent or U/G Tank Cap	⊕
Church	⊠
School	⊠
Park	⊠
Cemetery	⊠
Dam	⊠
Sign	⊕
Well	⊕
Small Mine	⊕
Swimming Pool	⊠

TOPOGRAPHY

Loose Surface	----
Hard Surface	----
Change in Road Surface	----
Curb	----
Right of Way Symbol	R/W
Guard Post	⊕ GP
Paved Walk	----
Bridge	⊠
Box Culvert or Tunnel	⊠
Ferry	⊠
Culvert	⊠
Footbridge	⊠
Trail, Footpath	⊠
Light House	⊠

VEGETATION

Single Tree	⊕
Single Shrub	⊕
Hedge	⊠
Woods Line	⊠
Orchard	⊠
Vineyard	⊠

RAILROADS

Standard Gauge	⊠
RR Signal Milepost	⊕
Switch	⊕

2/26/03

### TYPICAL STRUCTURE PLACEMENT

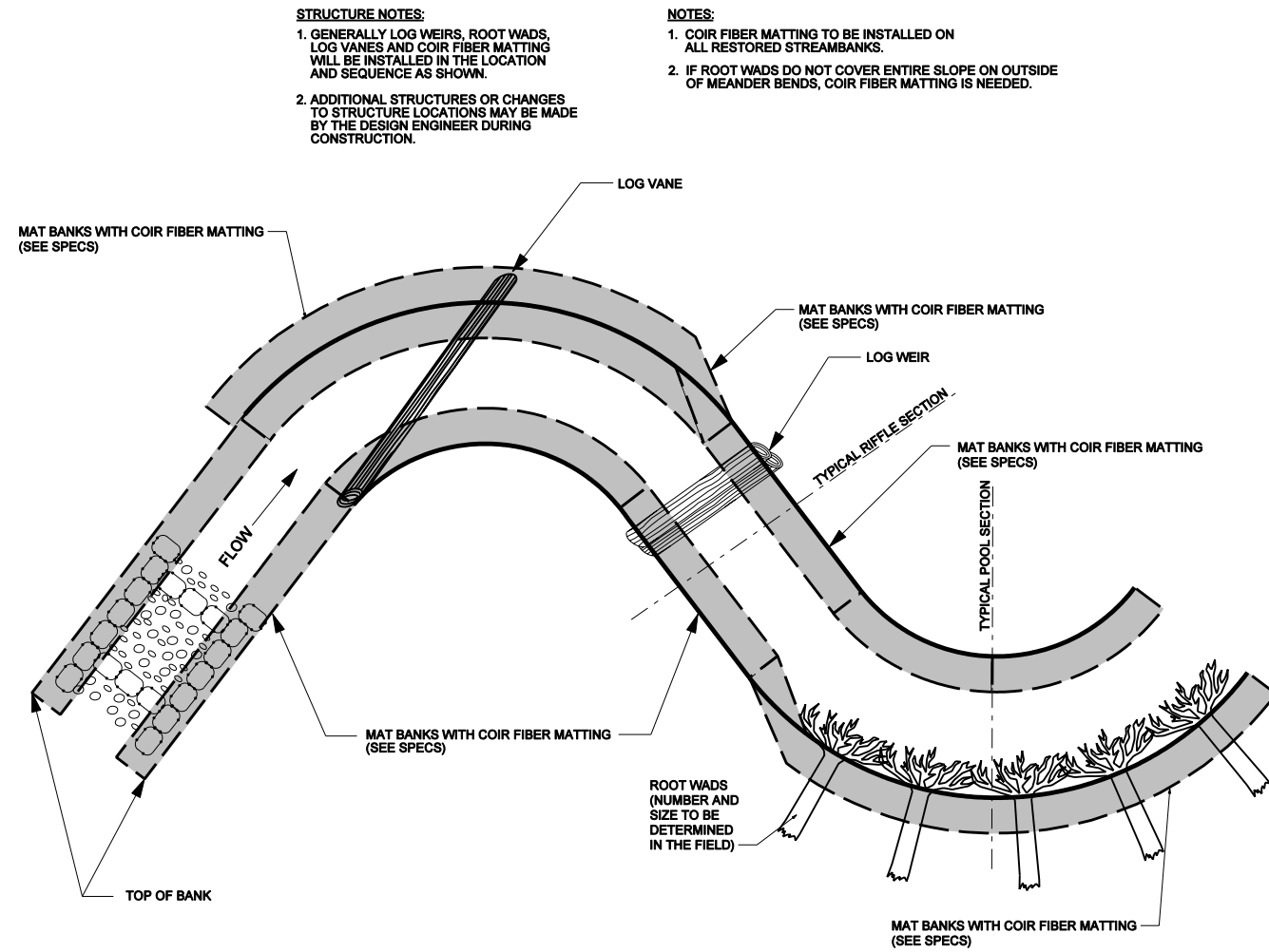

**STRUCTURE NOTES:**

1. GENERALLY LOG WEIRS, ROOT WADS, LOG VANES AND COIR FIBER MATTING WILL BE INSTALLED IN THE LOCATION AND SEQUENCE AS SHOWN.
2. ADDITIONAL STRUCTURES OR CHANGES TO STRUCTURE LOCATIONS MAY BE MADE BY THE DESIGN ENGINEER DURING CONSTRUCTION.

**NOTES:**

1. COIR FIBER MATTING TO BE INSTALLED ON ALL RESTORED STREAMBANKS.
2. IF ROOT WADS DO NOT COVER ENTIRE SLOPE ON OUTSIDE OF MEANDER BENDS, COIR FIBER MATTING IS NEEDED.

### LOG WEIR

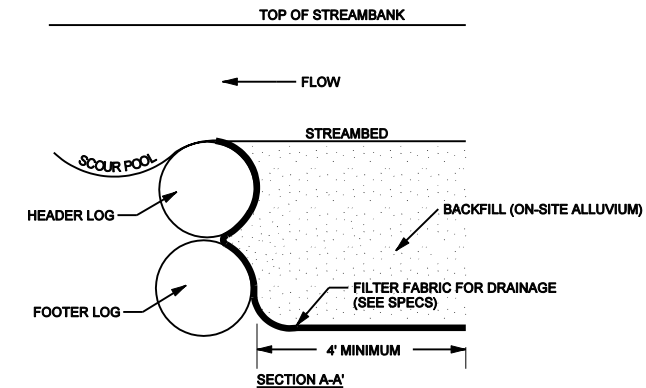
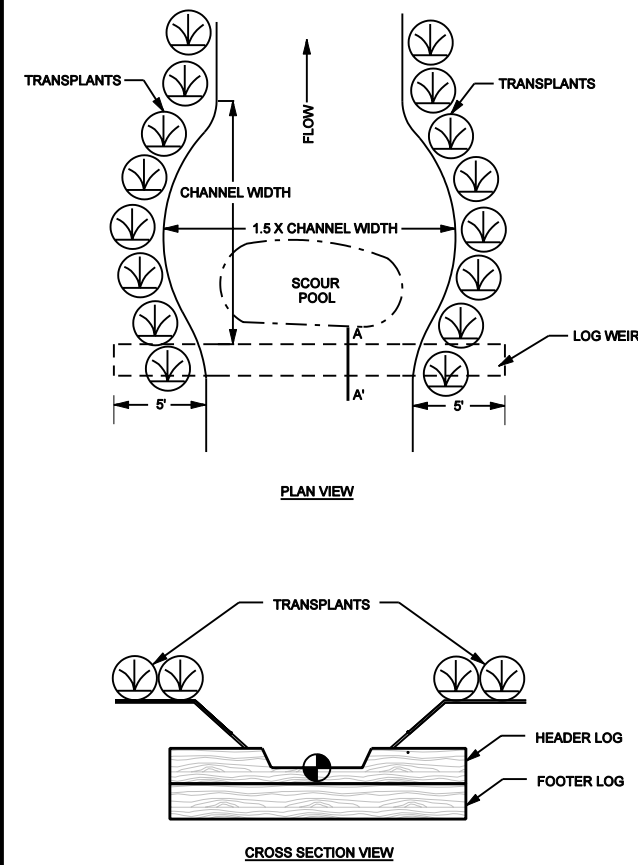

**NOTES:**

1. LOGS SHOULD BE AT LEAST 12 INCHES IN DIAMETER, RELATIVELY STRAIGHT, HARDWOOD, AND RECENTLY HARVESTED.
2. LOGS >24 INCHES IN DIAMETER MAY BE USED ALONE WITHOUT AN ADDITIONAL LOG. FILTER FABRIC SHOULD STILL BE USED TO SEAL AROUND LOG.
3. PLACE FOOTER LOGS FIRST AND THEN HEADER (TOP) LOG. SET HEADER LOG APPROXIMATELY 3 INCHES ABOVE THE INVERT ELEVATION.
4. CUT A NOTCH IN THE HEADER LOG APPROXIMATELY 50 PERCENT OF THE CHANNEL BOTTOM WIDTH AND EXTENDING DOWN TO THE INVERT ELEVATION.
5. USE FILTER FABRIC FOR DRAINAGE TO SEAL GAPS BETWEEN LOGS.
6. PLACE TRANSPLANTS FROM TOE OF STREAMBANK TO TOP OF STREAMBANK.

PROJECT REFERENCE NO. <b>0215R</b>	SHEET NO. <b>2</b>
PROJECT ENGINEER	
THIS DOCUMENT ORIGINALLY ISSUED AND SEALED BY:	
KEVIN L. TWEEDY 027337 APRIL 4, 2006	
THIS MEDIA SHALL NOT BE CONSIDERED A CERTIFIED DOCUMENT	
<b>BUCK ENGINEERING</b>	
8000 Regency Parkway Suite 200 Cary, North Carolina 27511 Phone: 919-463-5488 Fax: 919-463-5490	

### TYPICAL RIFFLE, POOL, AND BANKFULL BENCH CROSS SECTIONS

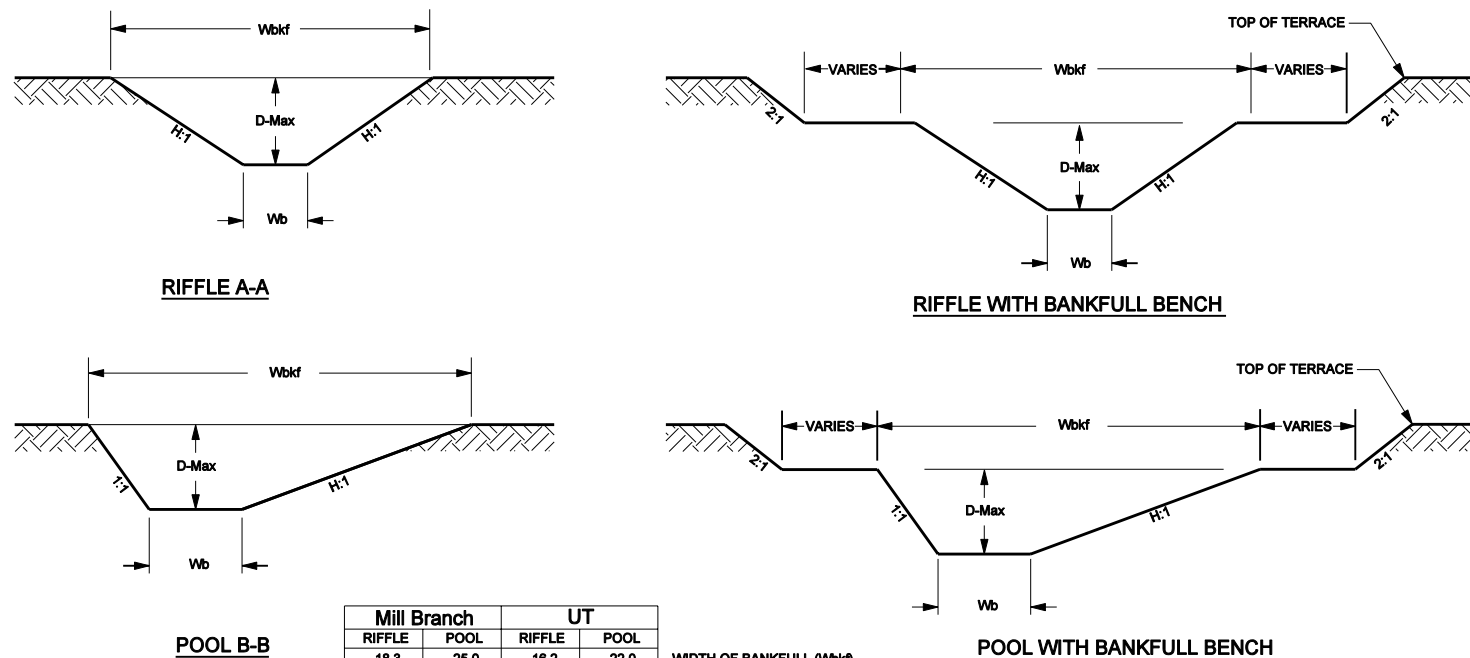

Mill Branch		UT	
RIFFLE	POOL	RIFFLE	POOL
18.3	25.0	16.2	22.0
1.5	2.1	1.4	1.8
2.1	3.6	1.9	3.1
12.0	11.9	12.0	12.3
28.0	52.4	22.0	39.4
8.9	4.1	6.6	3.4
2.3	4.8	2.5	5.0

WIDTH OF BANKFULL (Wbkf)  
AVERAGE DEPTH (D)  
MAXIMUM DEPTH (D-Max)  
WIDTH TO DEPTH RATIO (Wbkf / D)  
BANKFULL AREA (Abkf)  
BOTTOM WIDTH (Wb)  
H (HORIZONTAL)

**NOTES:**

1. DURING CONSTRUCTION CORNERS OF DESIGN CHANNEL WILL BE ROUNDED AND A THALWEG WILL BE SHAPED PER DIRECTION OF ENGINEER.
2. POOLS SHOWN ABOVE ARE LEFT POOLS ONLY.

### LOG VANE

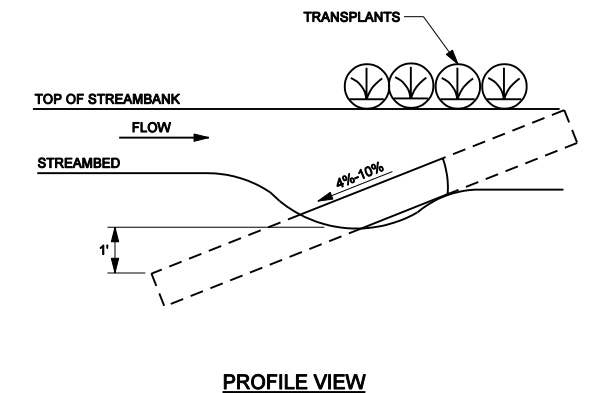
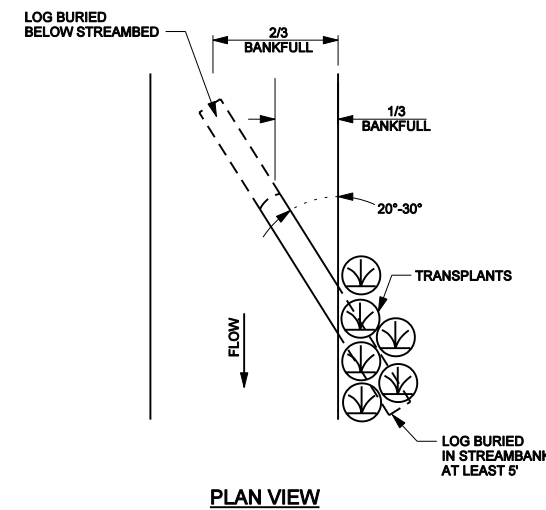

**NOTES:**

1. LOGS SHOULD BE AT LEAST 10" IN DIAMETER, RELATIVELY STRAIGHT, HARDWOOD, AND RECENTLY HARVESTED.
2. SOIL SHOULD BE COMPACTED WELL AROUND BURIED PORTIONS OF LOG.
3. TRANSPLANTS ARE PLACED ALONG THE TOP OF THE BANK OVER THE BURIED LOG VANE TO PROTECT AGAINST EROSION DURING HIGH FLOWS.

4/12/2006  
F:\215R\Design\As\_Buil\0215\_EBX\_PSH\_AB\_2.dgn

### TRANSPLANTED VEGETATION

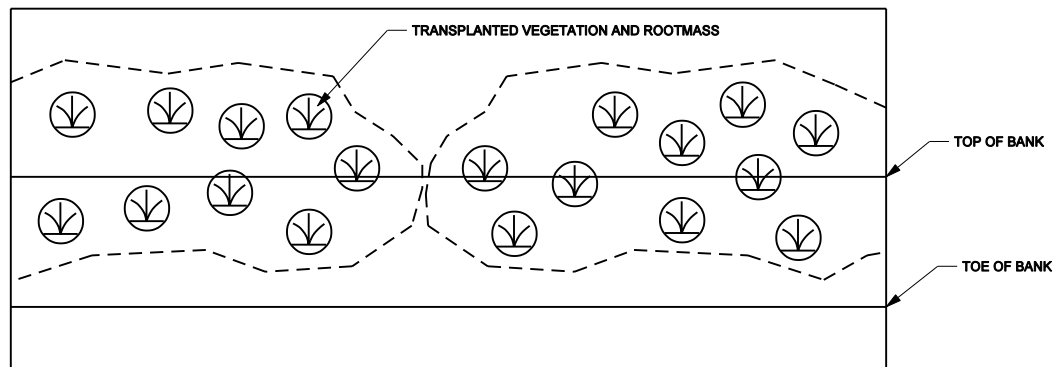

PLAN VIEW

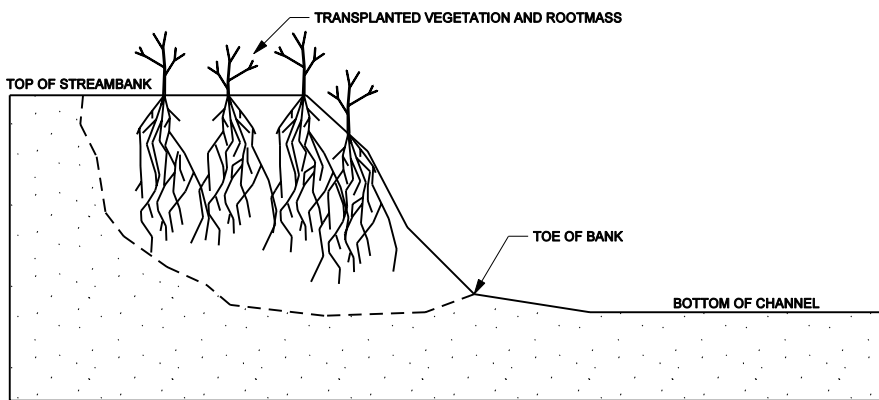

CROSS SECTION VIEW

- NOTES:**
1. EXCAVATE A HOLE IN THE BANK TO BE STABILIZED THAT WILL ACCOMMODATE THE SIZE OF TRANSPLANT TO BE PLACED. BEGIN EXCAVATION AT THE TOE OF THE BANK.
  2. EXCAVATE TRANSPLANT USING A FRONT END LOADER. EXCAVATE THE ENTIRE ROOT MASS AND AS MUCH ADDITIONAL SOIL MATERIAL AS POSSIBLE. IF ENTIRE ROOT MASS CANNOT BE EXCAVATED IN ONE BUCKET LOAD, THE TRANSPLANT IS TOO LARGE AND ANOTHER SHOULD BE SELECTED.
  3. PLACE TRANSPLANT IN THE BANK TO BE STABILIZED SO THAT VEGETATION IS ORIENTATED VERTICALLY.
  4. FILL IN ANY HOLES AROUND THE TRANSPLANT AND COMPACT.
  5. ANY LOOSE SOIL LEFT IN THE STREAM SHOULD BE REMOVED.
  6. PLACE MULTIPLE TRANSPLANTS CLOSE TOGETHER SUCH THAT THEY TOUCH.

### CONSTRUCTED RIFFLE

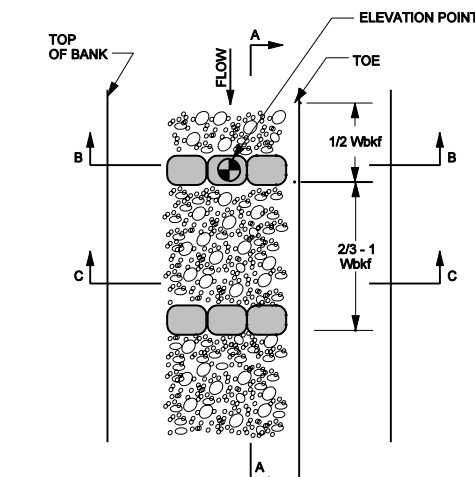

PLAN VIEW

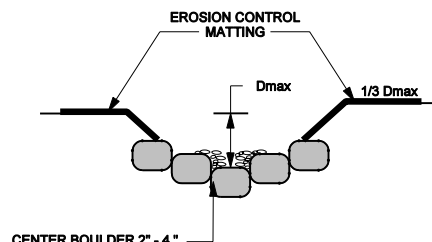

SECTION B - B

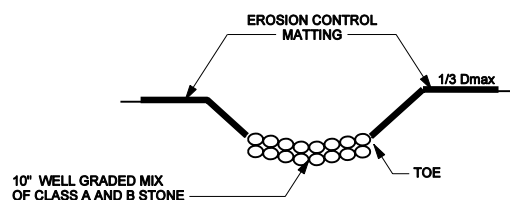

SECTION C - C

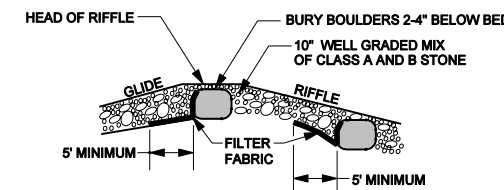

PROFILE A - A

REACH	Mill Branch	UT
Wbkf (ft)	18.3	16.2
Dmax (ft)	2.1	1.9

### ROOT WADS WITHOUT TRANSPLANTS

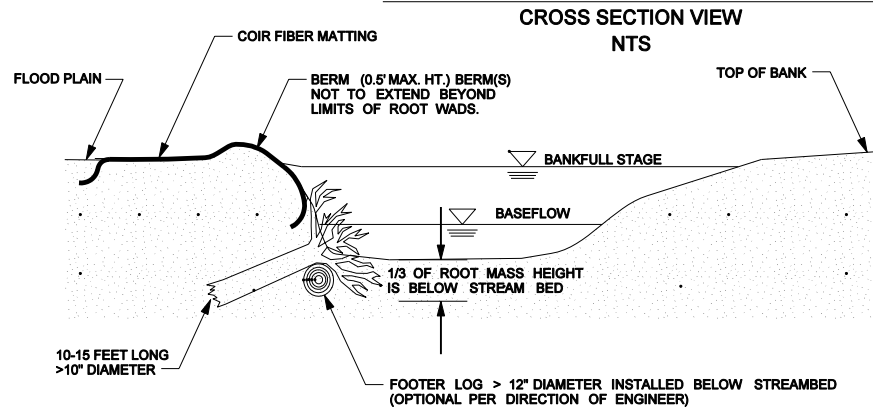

### ROOT WADS WITH TRANSPLANTS

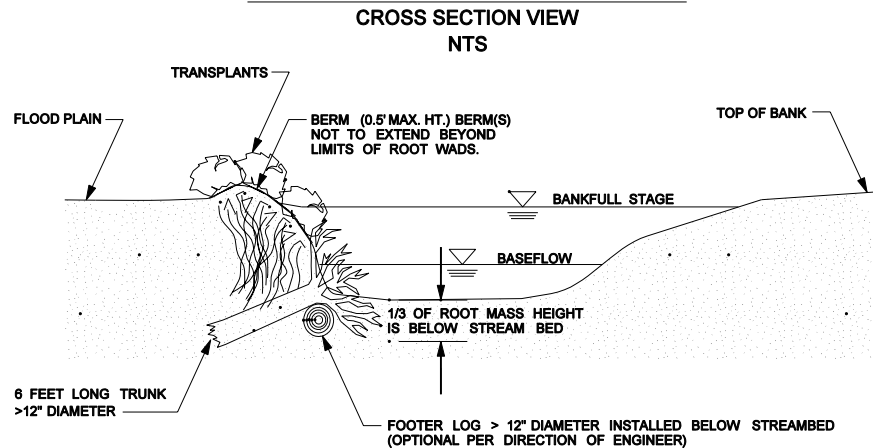

### ROOT WADS

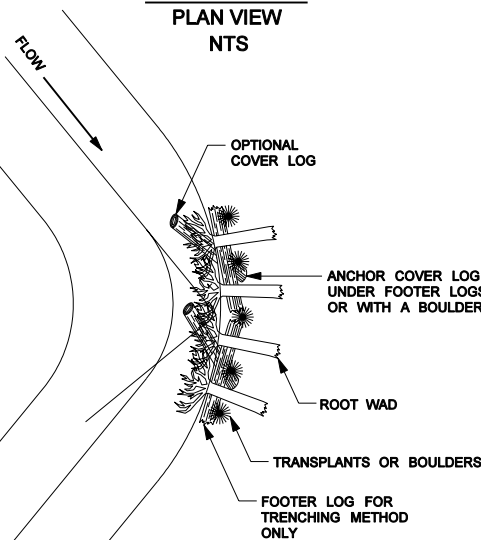

- NOTES:**
- TRENCHING METHOD:**  
IF THE ROOT WAD CANNOT BE DRIVEN INTO THE BANK OR THE BANK NEEDS TO BE RECONSTRUCTED THE TRENCHING METHOD SHOULD BE USED. THIS METHOD REQUIRES THAT A TRENCH BE EXCAVATED FOR THE LOG PORTION OF THE ROOT WAD. IN THIS CASE, A FOOTER LOG SHOULD BE INSTALLED UNDERNEATH THE ROOT WAD IN A TRENCH EXCAVATED PARALLEL TO THE BANK AND WELL BELOW THE STREAMBED. ONE-THIRD OF THE ROOT WAD SHOULD REMAIN BELOW NORMAL BASE FLOW CONDITIONS.
- DRIVE POINT METHOD:**  
SHARPEN THE END OF THE LOG WITH A CHAINSAW BEFORE "DRIVING" IT INTO THE BANK. ORIENT ROOT WADS UPSTREAM SO THAT THE STREAM FLOW MEETS THE ROOT WAD AT A 90-DEGREE ANGLE, DEFLECTING THE WATER AWAY FROM THE BANK. A TRANSPLANT OR BOULDER SHOULD BE PLACED ON THE DOWNSTREAM SIDE OF THE ROOT WAD IF A BACK EDDY IS FORMED BY THE ROOT WAD. THE BOULDER SHALL BE APPROXIMATELY 4' X 2'.

### DOUBLE DROP ROCK CROSS VANE

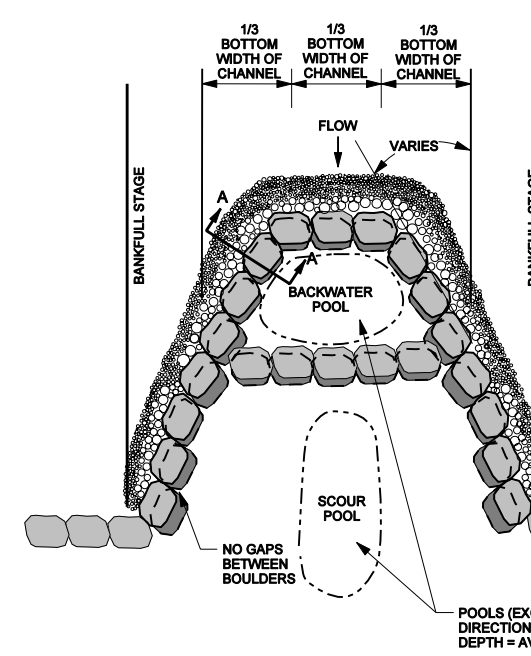

PLAN VIEW

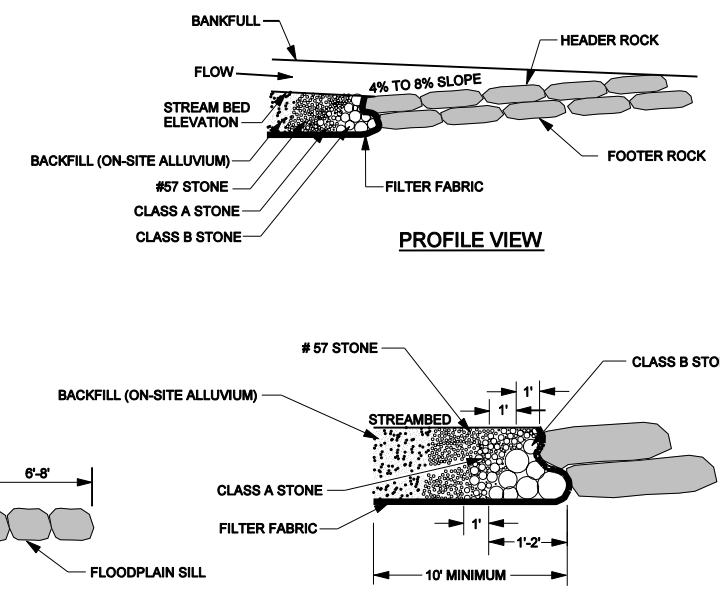

SECTION A - A

1. BOULDERS MUST BE AT LEAST 2' x 2' x 3'.
2. INSTALL FILTER FABRIC FOR DRAINAGE BEGINNING AT THE MIDDLE OF THE HEADER ROCKS AND EXTEND DOWNWARD TO THE DEPTH OF THE BOTTOM FOOTER ROCK, AND THEN UPSTREAM TO A MINIMUM OF TEN FEET.
3. DIG A TRENCH BELOW THE BED FOR FOOTER ROCKS AND PLACE FILL ON UPSTREAM SIDE OF VANE ARM, BETWEEN THE ARM AND STREAM BANK.
4. START AT BANKFULL AND PLACE FOOTER ROCKS FIRST AND THEN HEADER (TOP) ROCK.
5. CONTINUE WITH STRUCTURE, FOLLOWING ANGLE AND SLOPE SPECIFICATIONS.
6. AN EXTRA BOULDER CAN BE PLACED IN SCOUR POOL FOR HABITAT IMPROVEMENT.
7. USE CLASS B STONE TO FILL GAPS ON UPSTREAM SIDE OF BOULDERS, AND CLASS A STONE TO FILL GAPS ON DOWNSTREAM SIDE OF BOULDERS.
8. AFTER ALL STONE HAS BEEN PLACED, FILL IN THE UPSTREAM SIDE OF THE STRUCTURE WITH ON-SITE ALLUVIUM TO THE ELEVATION OF THE TOP OF THE HEADER ROCK.

2/26/03  
4/12/2006  
F:\0215R\Design\As\_Buil\0215\_EBX\_PSH\_AB\_2A.dgn



### DITCH PLUG

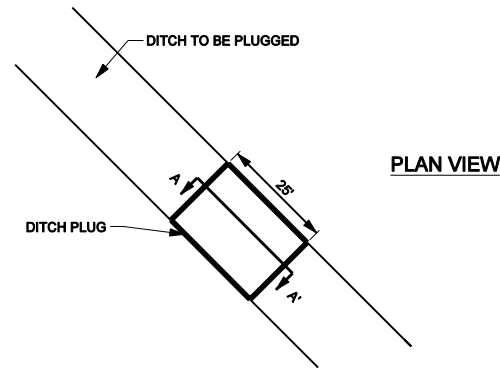

**NOTE:**  
COMPACT BACKFILL USING ON-SITE HEAVY EQUIPMENT  
IN 10 INCH LIFTS.

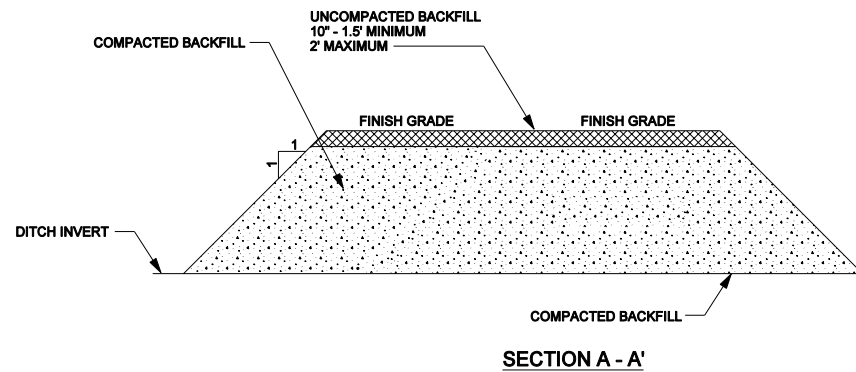

### STANDARD "V" DITCH

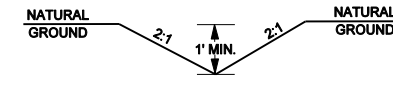

#### STANDARD 'V' DITCH (TYPE B)

- NOTES:**
- BANKS OF TYPE B DITCHES PROTECTED WITH STRAW, TEMPORARY AND PERMANENT SEEDING.
  - TYPE B DITCHES TO BE CONSTRUCTED WITH AS LITTLE SLOPE AS POSSIBLE.
  - SPOIL FROM DITCHES TO BE USED IN FILLING OLD CHANNEL OR SPREAD EVENLY OVER UPSLOPE AREAS.

### LIVE STAKING

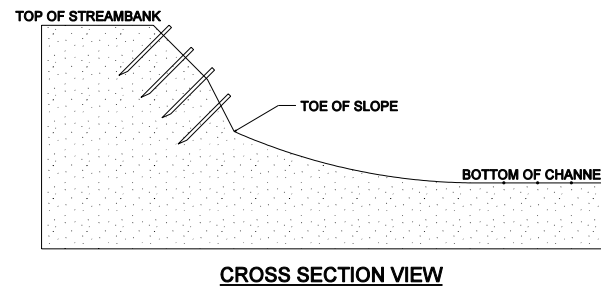

CROSS SECTION VIEW

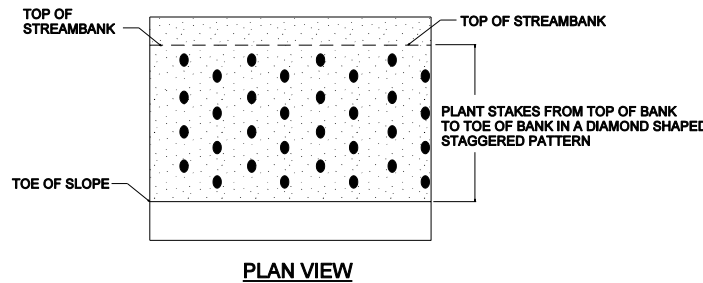

PLAN VIEW

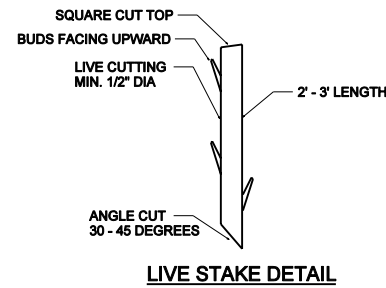

LIVE STAKE DETAIL

- NOTES:**
- STAKES SHOULD BE CUT AND INSTALLED ON THE SAME DAY.
  - DO NOT INSTALL STAKES THAT HAVE BEEN SPLIT.
  - STAKES MUST BE INSTALLED WITH BUDS POINTING UPWARDS.
  - STAKES SHOULD BE INSTALLED PERPENDICULAR TO BANK.
  - STAKES SHOULD BE 1/2 TO 2 INCHES IN DIAMETER AND 2 TO 3 FT LONG.
  - STAKES SHOULD BE INSTALLED LEAVING 1/5 OF STAKE ABOVE GROUND.

### SILT CHECK

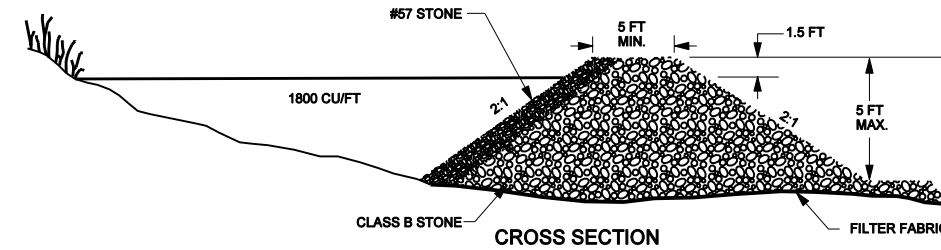

CROSS SECTION

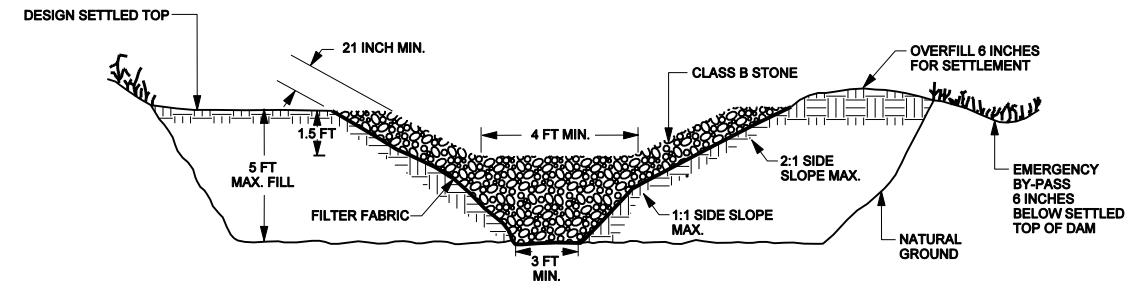

STONE SECTION

- CONSTRUCTION SPECIFICATIONS:**
- CLEAR, GRUB, AND STRIP THE AREA UNDER THE EMBANKMENT OF ALL VEGETATION AND ROOT MATERIAL. REMOVE ALL SURFACE SOIL CONTAINING HIGH AMOUNTS OF ORGANIC MATTER AND STOCKPILE OR DISPOSE OF IT PROPERLY. HAUL ALL OBJECTIONABLE MATERIAL TO THE DESIGNATED DISPOSAL AREA.
  - ENSURE ALL FILL MATERIAL FOR THE EMBANKMENT IS FREE OF ROOTS, WOODY VEGETATION, ORGANIC MATTER, AND OTHER OBJECTIONABLE MATERIAL. PLACE THE FILL IN LIFTS NOT TO EXCEED 9 INCHES AND MACHINE COMPACT IT. OVER FILL THE EMBANKMENT 6 INCHES TO ALLOW FOR SETTLEMENT.
  - CONSTRUCT THE OUTLET SECTION IN THE EMBANKMENT. PROTECT THE CONNECTION BETWEEN THE RIPRAP AND THE SOIL FROM THE PIPING BY USING FILTER FABRIC OR A KEYWAY CUTOFF TRENCH BETWEEN THE RIPRAP STRUCTURE AND THE SOIL.
    - PLACE THE FILTER FABRIC BETWEEN THE RIPRAP AND SOIL. EXTEND THE FABRIC ACROSS THE SPILLWAY FOUNDATION AND SIDES TO THE TOP OF THE DAM; OR
    - EXCAVATE A KEYWAY TRENCH ALONG THE CENTERLINE OF THE SPILLWAY FOUNDATION EXTENDING UP THE SIDES TO THE HEIGHT OF THE DAM. THE TRENCH SHOULD BE AT LEAST 2 FEET DEEP AND 2 FEET WIDE WITH A 1:1 SLOPE.
  - CLEAR THE POND AREA BELOW THE ELEVATION OF THE CREST OF THE SPILLWAY TO FACILITATE SEDIMENT CLEANOUT.
  - ALL CUT AND FILL SLOPES SHOULD BE 2:1 OR FLATTER.
  - ENSURE THAT ALL STONE (DRAINAGE) SECTION OF THE EMBANKMENT HAS A MINIMUM BOTTOM WIDTH OF 3 FEET AND A MAXIMUM SIDE SLOPE OF 1:1 THAT EXTEND THE BOTTOM OF THE SPILLWAY.
  - CONSTRUCT A MINIMUM FINISHED STONE SPILLWAY BOTTOM WIDTH AS SHOWN, ON THE PLANS, WITH 2:1 SIDE SLOPES EXTENDING TO THE TOP OF THE OVER FILLED EMBANKMENT. KEEP THICKNESS OF THE SIDES TO THE SPILLWAY OUTLET STRUCTURE AT A MINIMUM OF 21 INCHES. THE WEIR MUST BE LEVEL AND CONSTRUCTED TO GRADE TO ASSURE DESIGN CAPACITY.
  - MATERIAL USED IN THE STONE SECTION SHOULD BE A WELL GRADED MIXTURE OF STONE WITH A #50 SIZE OF 9 INCHES (CLASS B EROSION CONTROL STONE IS RECOMMENDED) AND A MAXIMUM STONE SIZE OF 14 INCHES. THE STONE MAY BE MACHINED PLACED AND THE SMALLER STONESWORKED INTO THE VOIDS OF THE LARGER STONES. THE STONE SHOULD BE HARD, ANGULAR, AND HIGHLY WEATHER-RESISTANT.

2/26/03  
4/2/2006  
F:\215R\Design\As\_Buil\0215\_EBX\_PSH\_AB\_2B.dgn

THIS DOCUMENT  
ORIGINALLY ISSUED AND  
SEALED BY:  
KEVIN L. TWEEDY  
027337  
APRIL 4, 2006  
THIS MEDIA SHALL NOT BE CONSIDERED  
A CERTIFIED DOCUMENT

**TEMPORARY SILT FENCE**

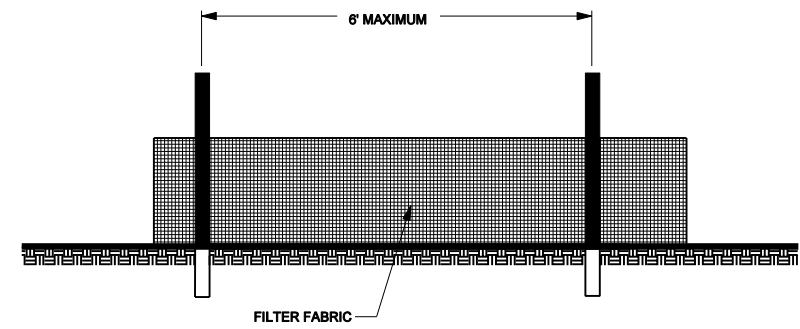

**NOTES:**

1. USE FILTER FABRIC A MINIMUM OF 36" IN WIDTH AND FASTEN ADEQUATELY TO THE WIRE AS DIRECTED BY THE ENGINEER.
2. PROVIDE 5" STEEL POST OF THE SELF-FASTENER ANGLE STEEL TYPE.

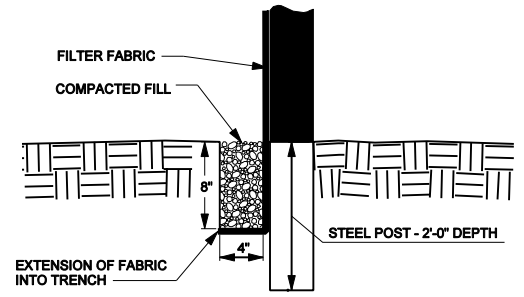

**TEMPORARY GRAVEL CONSTRUCTION ENTRANCE**

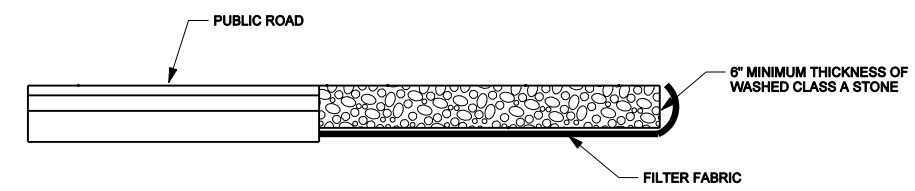
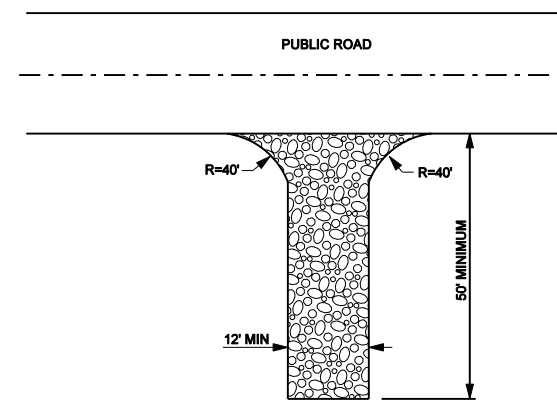

**NOTES:**

SPECIFICATION NO. 6.06 - CONSTRUCTION ACCESS "N.C. EROSION AND SEDIMENT CONTROL PLANNING AND DESIGN MANUAL DECEMBER 1993"

**EROSION CONTROL MATTING**

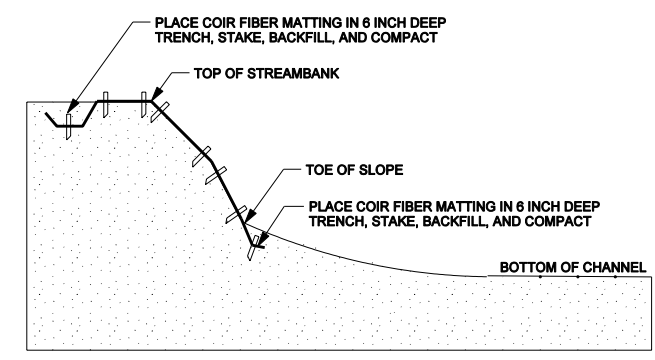

**CROSS SECTION VIEW**

**NOTES:**

1. BANKS SHOULD BE SEEDED PRIOR TO PLACEMENT OF MATTING.
2. PLACE COIR FIBER MATTING ACCORDING TO MANUFACTURER RECOMMENDATIONS.
3. MATTING STAKES SHOULD BE PLACED IN A DIAMOND SHAPED PATTERN.

THE WOOD STAKE SHALL BE THE NORTH AMERICAN GREEN ECO-STAKE OR APPROVED EQUAL WITH THE FOLLOWING DIMENSIONS:

LEG LENGTH	11.00 IN (27.94 CM)
HEAD WIDTH	1.25 IN (3.18 CM)
HEAD THICKNESS	0.40 IN (1.02 CM)
LEG WIDTH	0.80 IN (1.52 CM) (TAPERED TO POINT)
LEG THICKNESS	0.40 IN (1.02 CM)
TOTAL LENGTH	12.00 IN (30.48 CM)

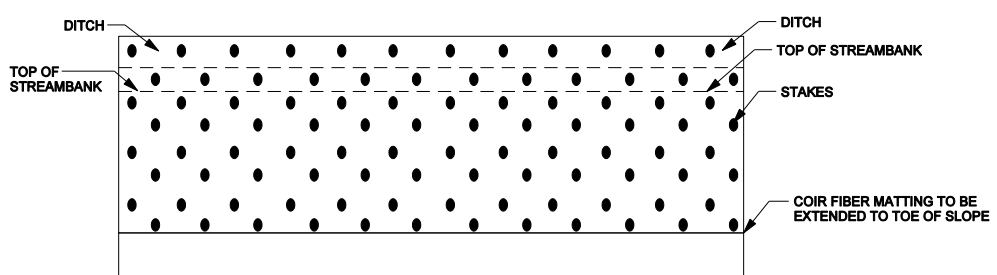

**PLAN VIEW**

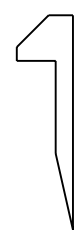

**TYPICAL MATTING STAKE**

**FORD STREAM CROSSING**

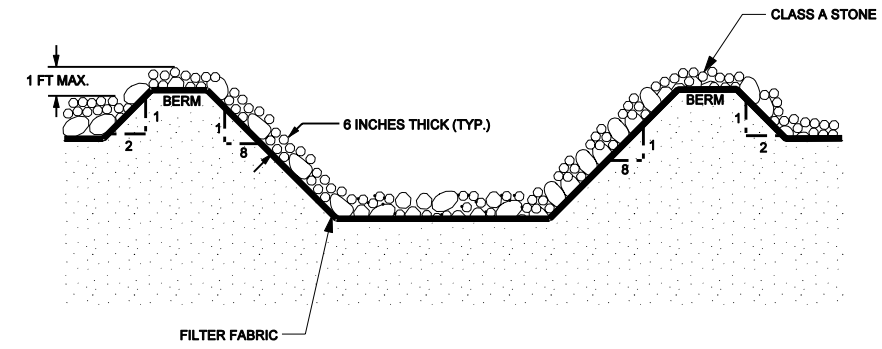

**NOTES:**

1. CONSTRUCT STREAM CROSSING WHEN FLOW IS LOW.
2. HAVE ALL NECESSARY MATERIALS AND EQUIPMENT ON-SITE BEFORE WORK BEGINS.
3. MINIMIZE CLEARING AND EXCAVATION OF STREAMBANKS. DO NOT EXCAVATE CHANNEL BOTTOM. COMPLETE ONE SIDE BEFORE STARTING ON THE OTHER SIDE.
4. INSTALL STREAM CROSSING AT RIGHT ANGLE TO THE FLOW.
5. GRADE SLOPES TO A 8:1 SLOPE. TRANSPLANT SOD FROM ORIGINAL STREAMBANK ONTO SIDE SLOPES.
6. MAINTAIN CROSSING SO THAT RUNOFF IN THE CONSTRUCTION ROAD DOES NOT ENTER EXISTING CHANNEL.
7. A STABILIZED PAD OF CLASS A STONE, 6 INCHES THICK, LINED WITH FILTER FABRIC FOR DRAINAGE SHALL BE USED OVER THE BERM AND ACCESS SLOPES.
8. WIDTH OF THE CROSSING SHALL BE SUFFICIENT TO ACCOMMODATE THE LARGEST VEHICLE CROSSING THE CHANNEL.
9. CONTRACTOR SHALL DETERMINE AN APPROPRIATE RAMP ANGLE ACCORDING TO EQUIPMENT UTILIZED.

2/26/03

4/2/2006  
F:\0215R\Design\As\_Buil\0215\_EBX\_PSH\_AB\_2C.dgn

THIS DOCUMENT  
ORIGINALLY ISSUED AND  
SEALED BY:

KEVIN L. TWEEDY  
027337  
APRIL 4, 2006

THIS MEDIA SHALL NOT BE CONSIDERED  
A CERTIFIED DOCUMENT



2/26/03

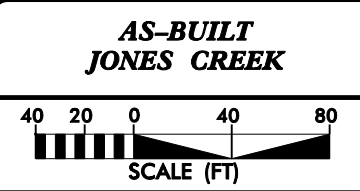
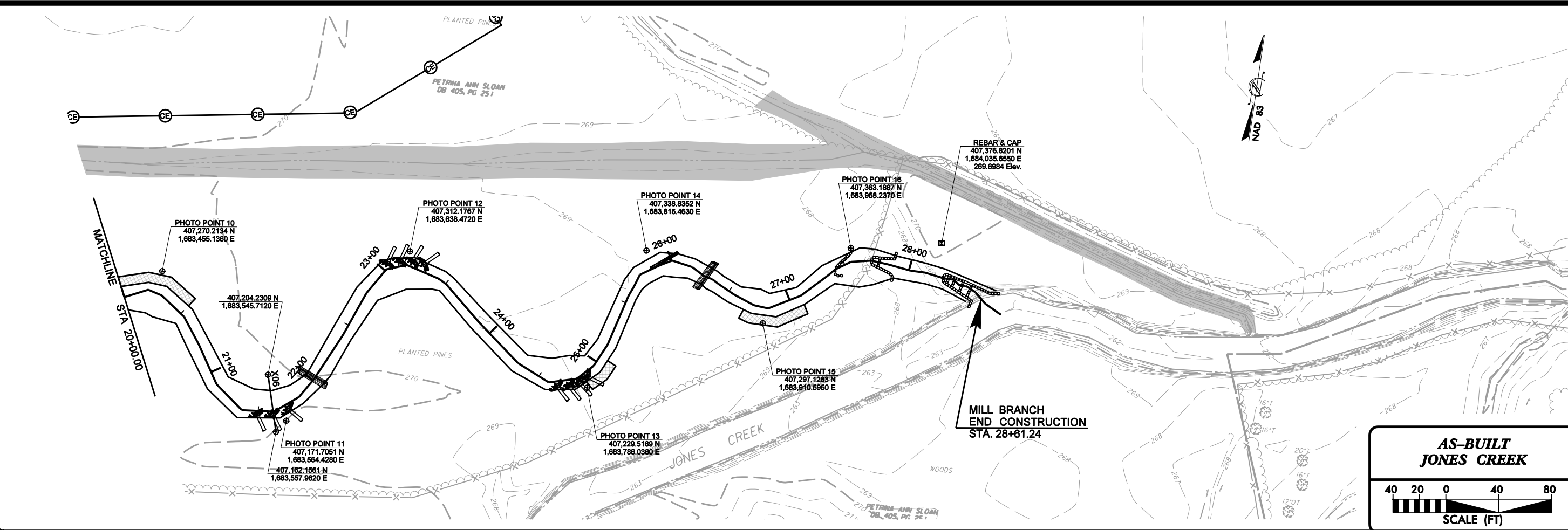
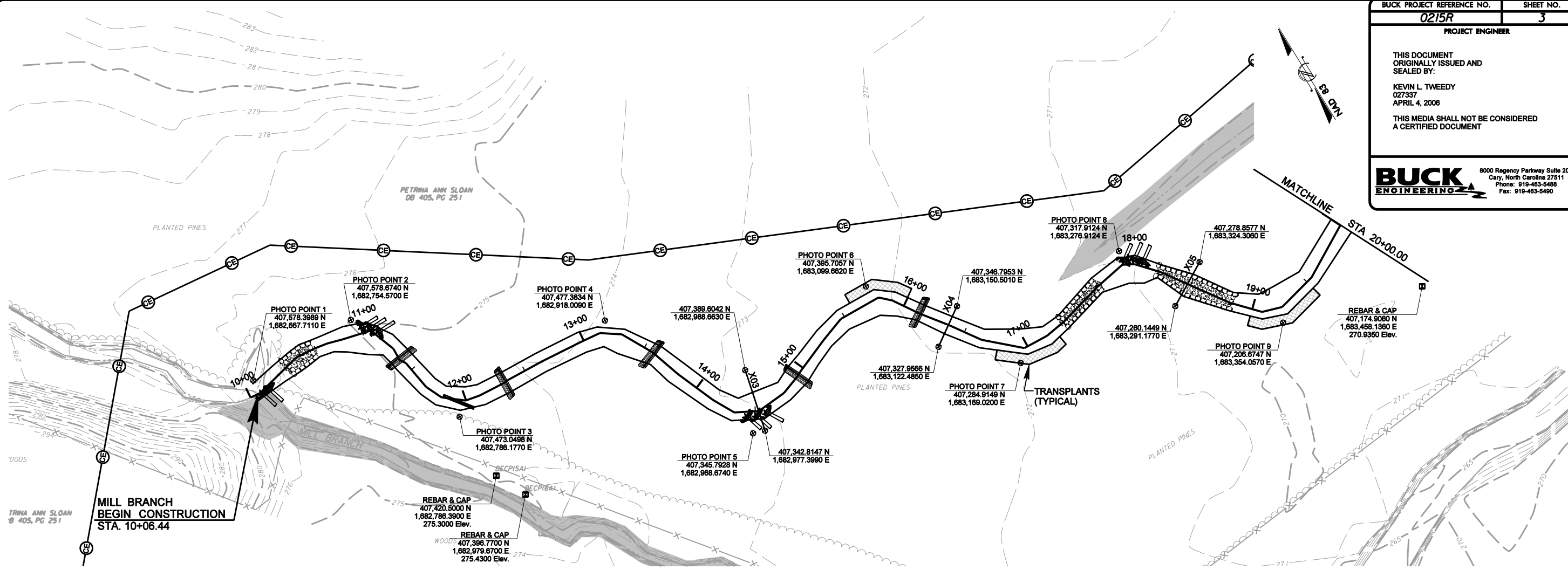

4/2/2006  
F:\0215R\Design\As\_Built\0215R\_EBX\_PSH\_AB\_03.dgn

THIS DOCUMENT  
ORIGINALLY ISSUED AND  
SEALED BY:

KEVIN L. TWEEDY  
027337  
APRIL 4, 2006

THIS MEDIA SHALL NOT BE CONSIDERED  
A CERTIFIED DOCUMENT



2/26/03

4/12/2006  
F:\0215R\Design\As-Built\0215R\_EBX\_PSH\_AB\_04.dgn

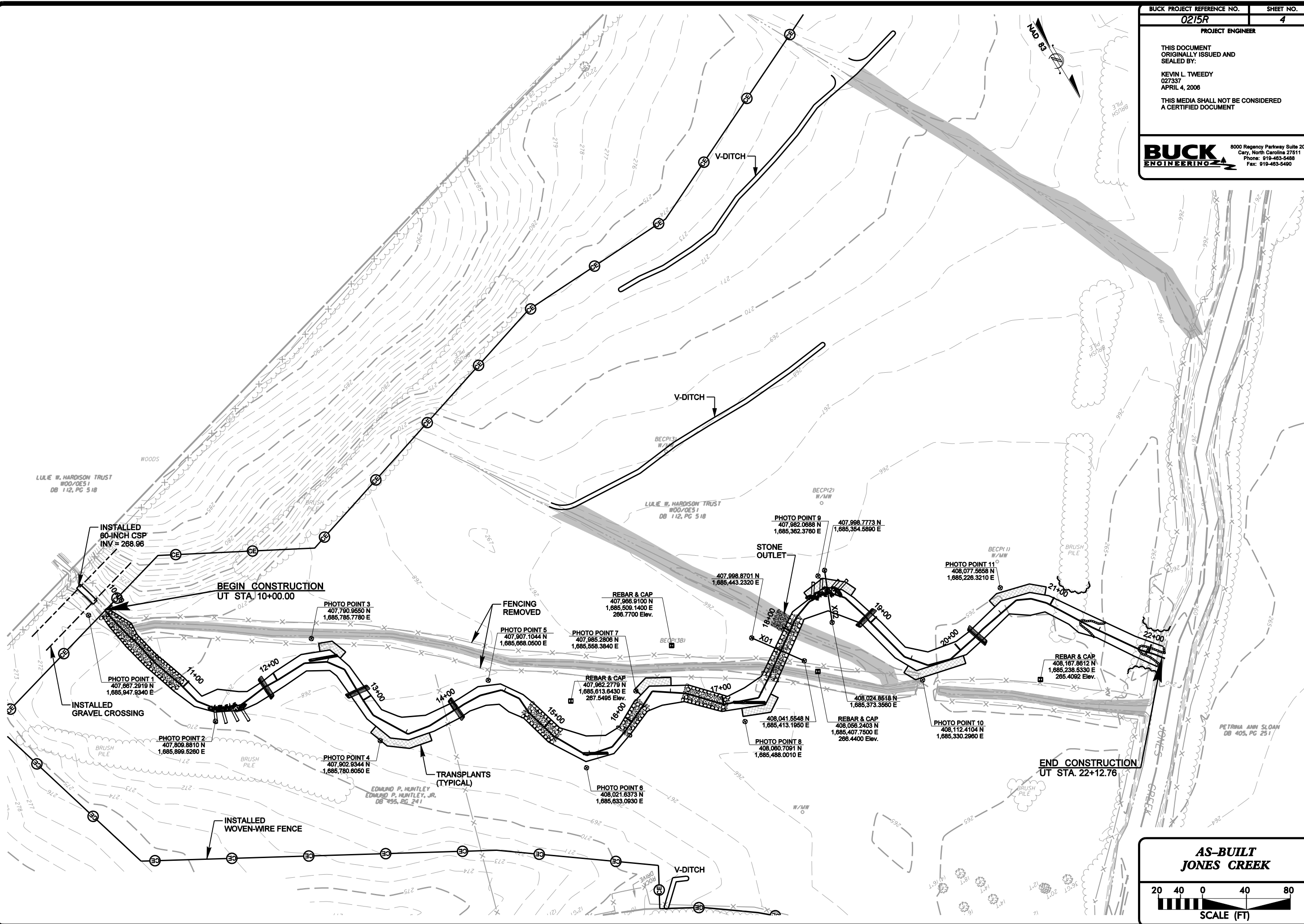

**AS-BUILT  
JONES CREEK**

20 40 0 40 80  
SCALE (FT)





THIS DOCUMENT  
ORIGINALLY ISSUED AND  
SEALED BY:

KEVIN L. TWEEDY  
027337  
APRIL 4, 2006

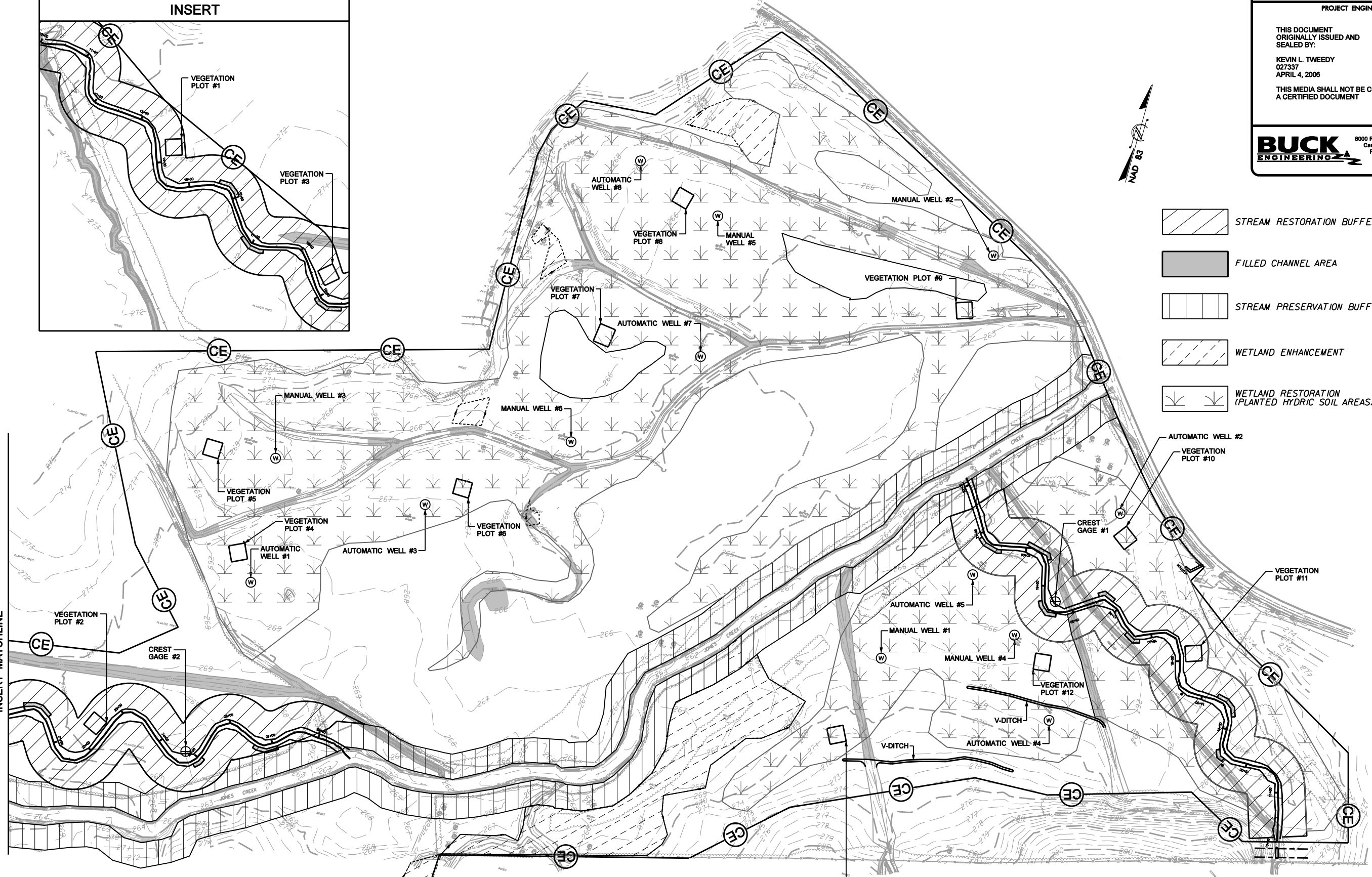
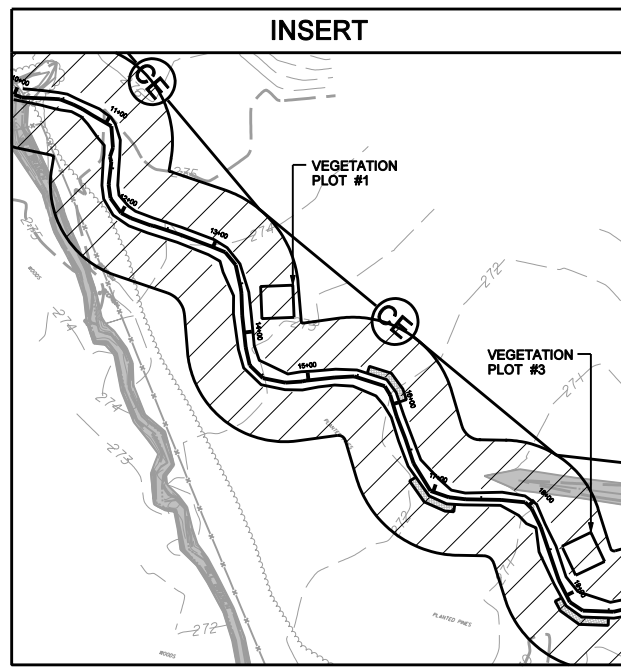
THIS MEDIA SHALL NOT BE CONSIDERED  
A CERTIFIED DOCUMENT

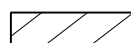
**BUCK**  
ENGINEERING  
8000 Regency Parkway Suite 200  
Cary, North Carolina 27511  
Phone: 919-463-5488  
Fax: 919-463-5490

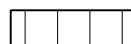
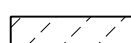

-  STREAM RESTORATION BUFFER
-  FILLED CHANNEL AREA
-  STREAM PRESERVATION BUFFER
-  WETLAND ENHANCEMENT
-  WETLAND RESTORATION (PLANTED HYDRIC SOIL AREAS)

INSERT MATCHLINE

TOTAL ACRES	
STREAM RESTORATION BUFFER	• 6.67 ACRES
STREAM PRESERVATION BUFFER	• 11.62 ACRES
WETLAND ENHANCEMENT	• 2.71
WETLAND RESTORATION (PLANTED HYDRIC SOIL AREAS)	• 25 ACRES

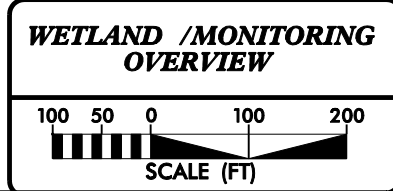

4/12/2006 F:\215R\Design\As\_Buil\0215\_EBX\_PSH\_AB\_wet\_05.dgn





THIS DOCUMENT  
ORIGINALLY ISSUED AND  
SEALED BY:

KEVIN L. TWEEDY  
027337  
APRIL 4, 2006

THIS MEDIA SHALL NOT BE CONSIDERED  
A CERTIFIED DOCUMENT

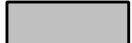
**BUCK**  
ENGINEERING  
8000 Regency Parkway Suite 200  
Cary, North Carolina 27511  
Phone: 919-463-5488  
Fax: 919-463-5490

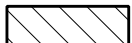
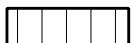
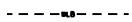
-  CONSERVATION EASEMENT
-  FILLED CHANNEL AREA
-  ZONE 1
-  ZONE 2
-  ZONE 3
-  EXISTING WETLAND BOUNDARY

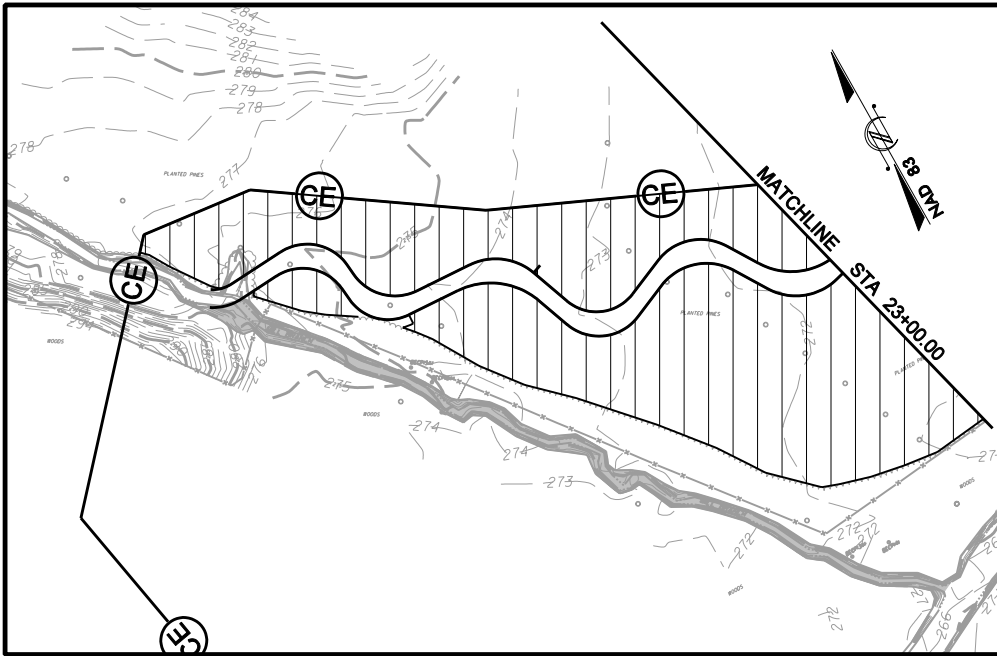

NOTE:  
PLACE LIVE STAKES ALONG THE BANKS OF MILL BRANCH  
AND UT TO SOUTH FORK JONES CREEK. PLANT ACCORDING  
TO DETAIL ON SHEET 2-A.

TOTAL PLANTED ACREAGE	
ZONE 1	= 47.3 Ac
ZONE 2	= 2.5 Ac.
ZONE 3	= 6.2 Ac.

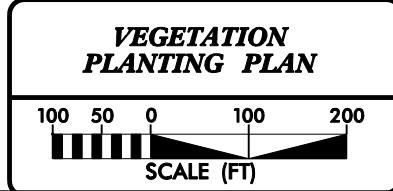

2/26/03  
 4/12/2006  
 F:\0215R\Design\As\_Built\0215\_EBX\_PSH\_AB\_veg\_06.dgn

# **APPENDIX B**

## **2008 Profile and Cross Section Data**

**Jones Creek Mill Branch 2008 Profile**

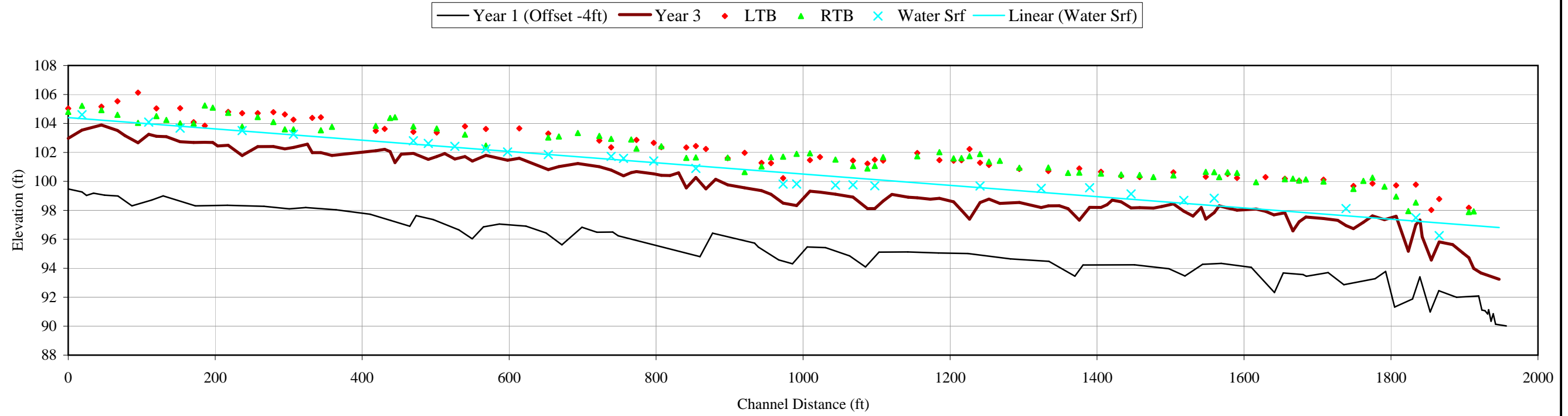

**Jones Creek UT 2008 Profile**

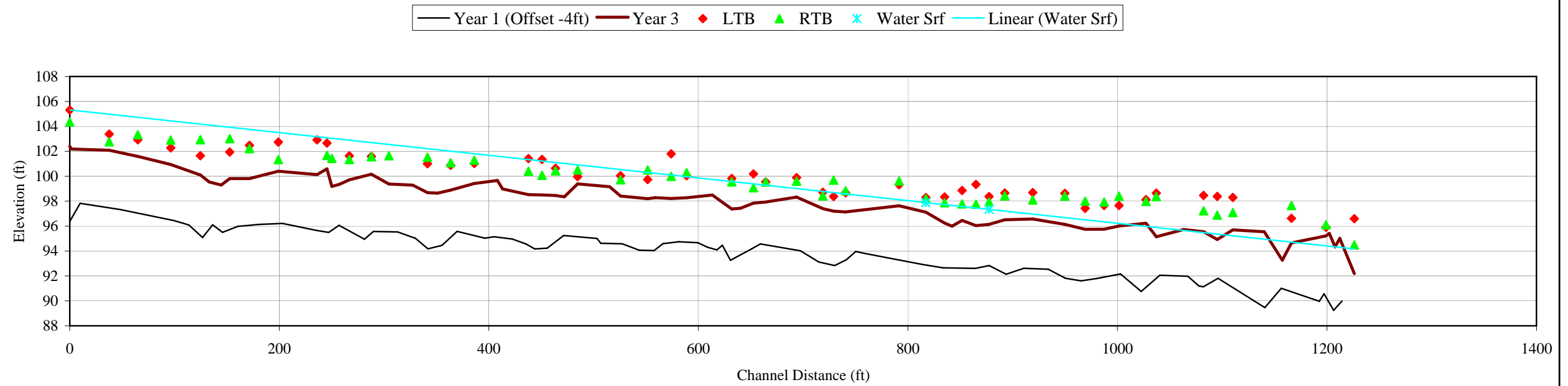





Looking at left bank.



Looking at right bank.





Looking at left bank.



Looking at right bank.

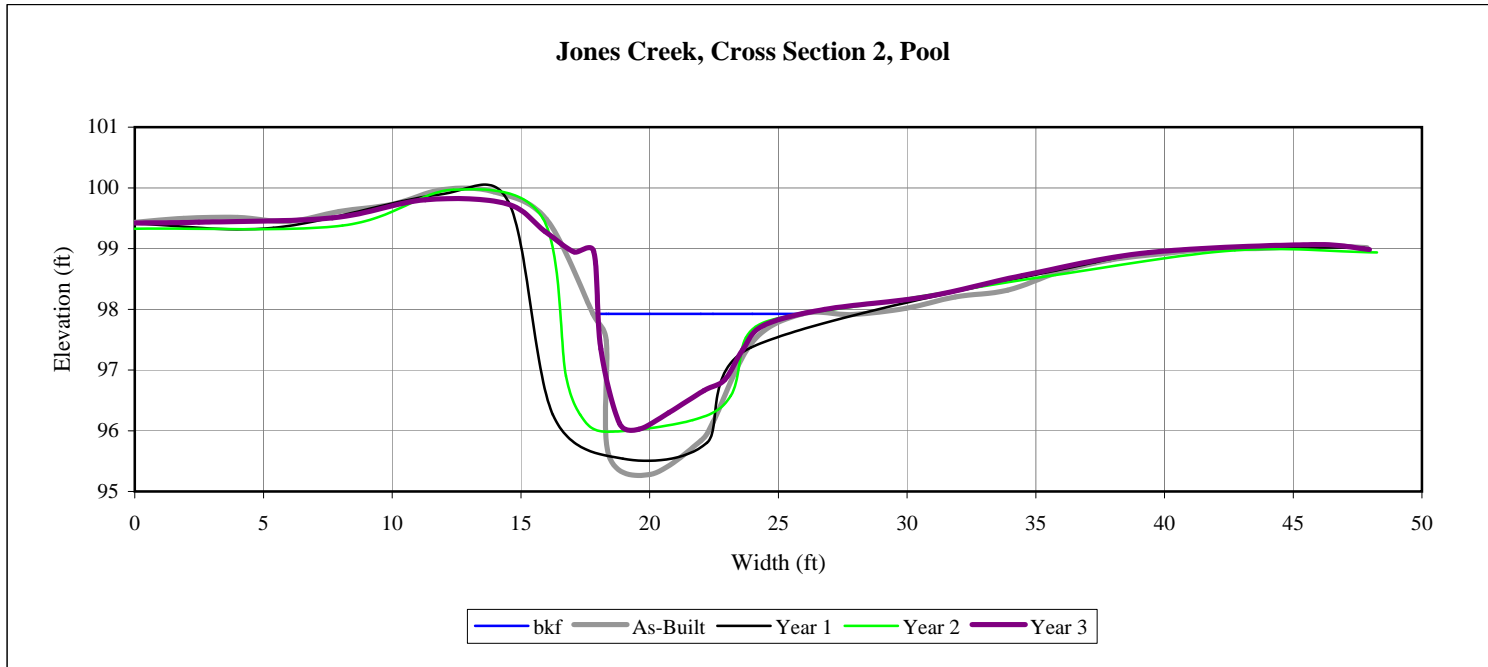



Looking at left bank.



Looking at right bank.

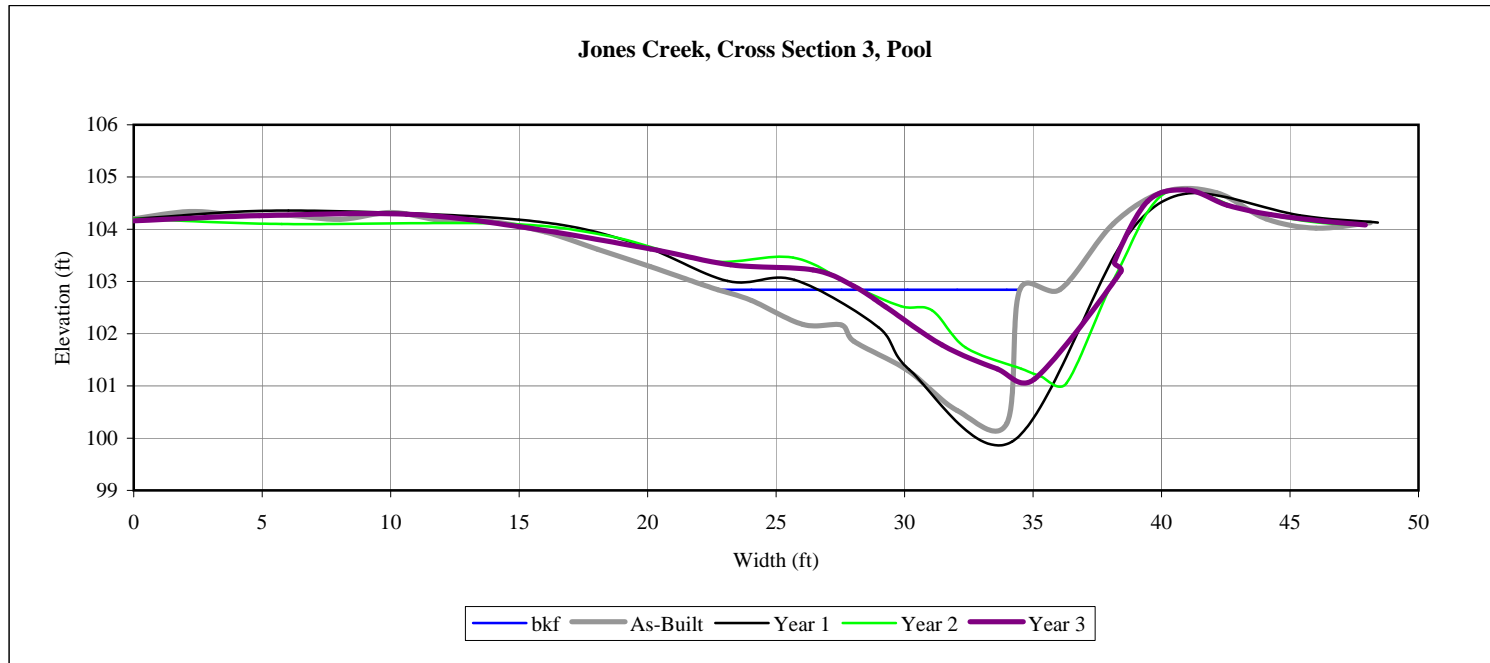





Looking at left bank.



Looking at right bank.

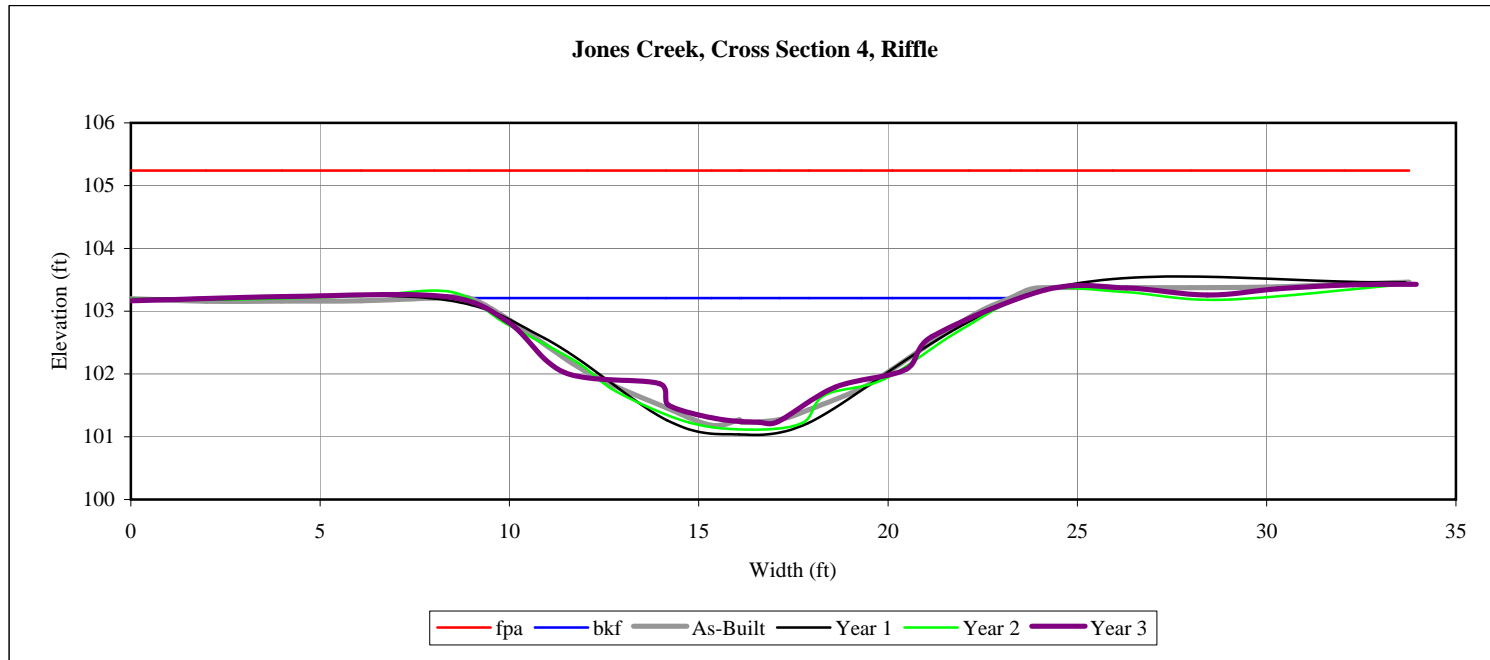



Looking at left bank.



Looking at right bank.

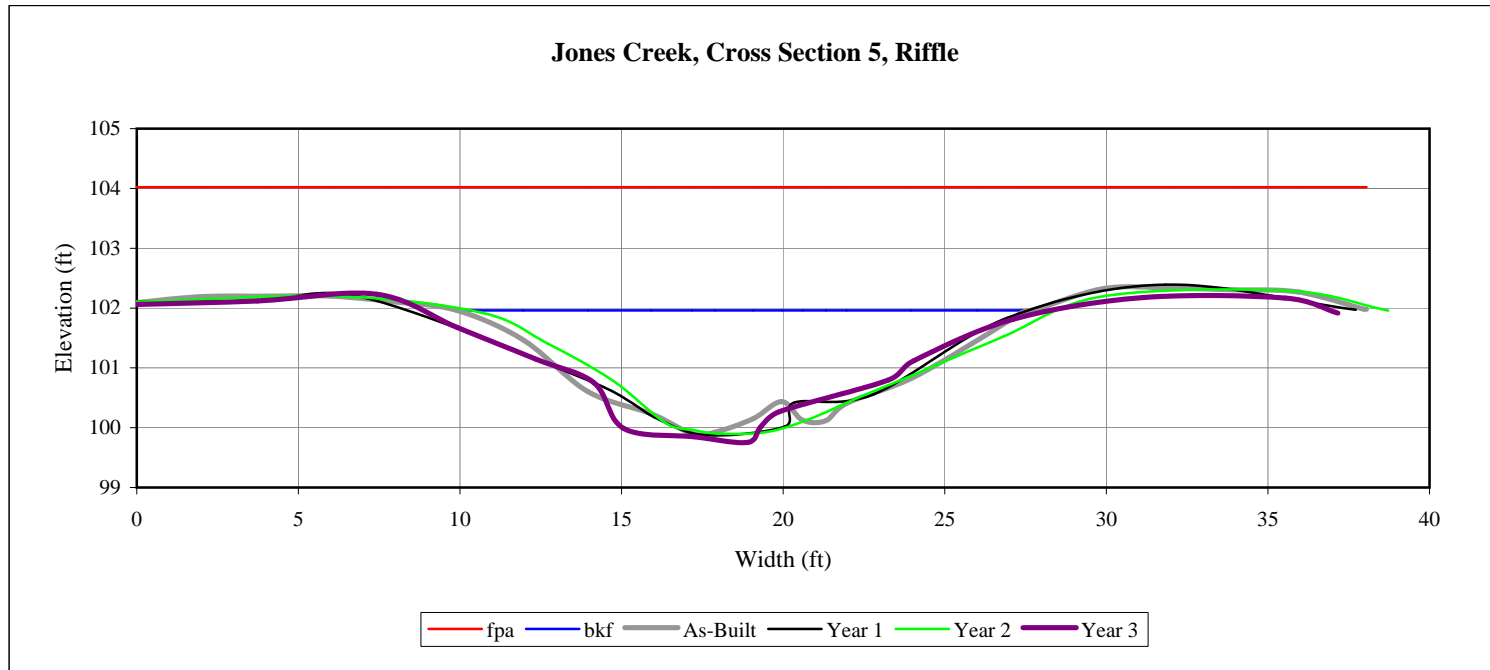





Looking at left bank.



Looking at right bank.

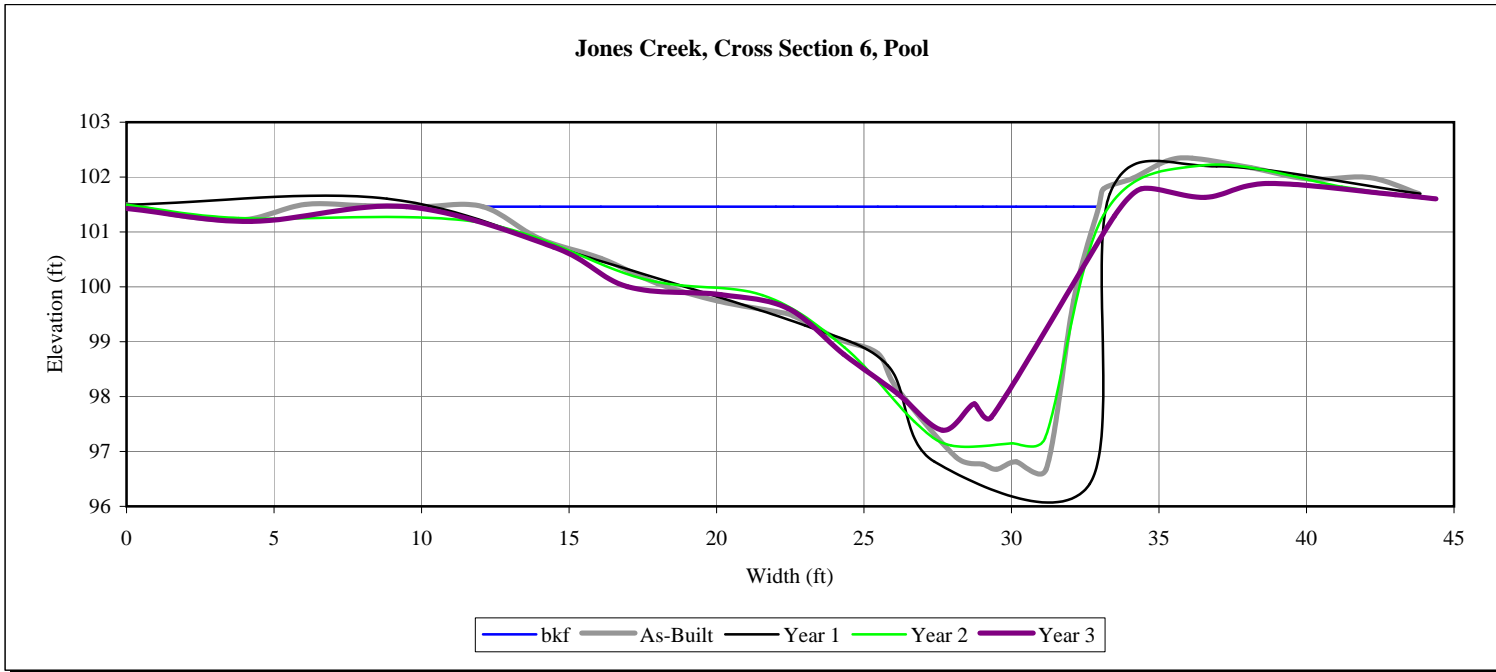

# **APPENDIX C**

## **2008 Site Photos**





**SPA 1, UT1 Station 20+25 – Log weir washed out**



**SPA 2, UT1 Station 20+50 – Left bank erosion; headcut**





**SPA 3, Mill Branch Station 11+60 – Right bank erosion**



**SPA 4, Mill Branch Station 23+50 – Beaver dam**





**Typical stream conditions**



**Constructed riffle facing downstream (typ.)**





**Typical stream conditions**



**Log weir facing downstream (typ.)**





**Rock cross vane facing downstream (typ.)**



**Rock cross vane facing upstream (typ.)**





**Root wad facing right bank (typ.)**



**Root wad facing left bank (typ.)**





**Log vane facing left bank (typ.)**



**Downstream limits of Mill Branch reach**





**Vegetation Plot 1**



**Vegetation Plot 2**



**Vegetation Plot 3**



**Vegetation Plot 4**





**Vegetation Plot 5**



**Vegetation Plot 6**





**Vegetation Plot 7**



**Vegetation Plot 8**



**Vegetation Plot 9**



**Vegetation Plot 10**





**Vegetation Plot 11**



**Vegetation Plot 12**



**Vegetation Plot 13**



# **APPENDIX D**

## **2008 Gauge Data**

Date	Time	Water Level (inches)					
dd-mmm-yyyy	hh:mm:ss	Jon AW1	Jon AW2	Jon AW3	Jon AW4	Jon AW5	Jon AW6
01-Jan-2008	08:00:00	-9.04	-2.80	-11.92	-18.25	-0.88	-14.12
01-Jan-2008	20:00:00	-11.31	-3.74	-25.11	-16.49	-1.18	-17.52
02-Jan-2008	08:00:00	-12.91	-5.12	-31.87	-15.41	-1.43	-20.21
02-Jan-2008	20:00:00	-13.88	-6.53	-34.52	-14.70	-1.64	-22.29
03-Jan-2008	08:00:00	-14.77	-7.82	-37.04	-14.68	-2.10	-23.37
03-Jan-2008	20:00:00	-15.25	-8.77	-36.97	-12.46	-2.02	-24.32
04-Jan-2008	08:00:00	-16.18	-10.27	-37.56	-11.97	-3.06	-25.03
04-Jan-2008	20:00:00	-16.51	-10.25	-36.33	-9.90	-2.18	-25.80
05-Jan-2008	08:00:00	-17.34	-11.03	-36.06	-9.80	-3.15	-26.52
05-Jan-2008	20:00:00	-17.26	-10.85	-35.96	-7.68	-2.32	-27.26
06-Jan-2008	08:00:00	-17.78	-11.17	-36.89	-7.46	-2.53	-27.77
06-Jan-2008	20:00:00	-17.93	-11.23	-36.66	-6.75	-2.63	-28.52
07-Jan-2008	08:00:00	-18.63	-12.09	-37.88	-7.91	-2.90	-28.95
07-Jan-2008	20:00:00	-18.91	-12.45	-38.45	-6.76	-2.95	-29.32
08-Jan-2008	08:00:00	-19.30	-13.02	-38.57	-7.25	-3.08	-29.46
08-Jan-2008	20:00:00	-19.16	-12.92	-38.02	-5.88	-3.03	-29.64
09-Jan-2008	08:00:00	-19.45	-13.10	-37.69	-5.83	-3.09	-30.09
09-Jan-2008	20:00:00	-19.68	-13.26	-38.17	-6.33	-3.30	-30.59
10-Jan-2008	08:00:00	-20.14	-13.81	-38.96	-5.70	-2.87	-30.42
10-Jan-2008	20:00:00	-16.83	-9.15	-38.55	-3.04	-1.78	-30.18
11-Jan-2008	08:00:00	-16.15	-7.68	-37.43	-0.98	-1.74	-29.87
11-Jan-2008	20:00:00	-12.63	-3.24	-35.48	-3.27	-1.42	-29.54
12-Jan-2008	08:00:00	-13.61	-4.47	-33.28	-4.76	-1.70	-29.33
12-Jan-2008	20:00:00	-14.18	-5.22	-33.03	-5.64	-1.82	-29.44
13-Jan-2008	08:00:00	-15.06	-6.35	-33.15	-5.61	-2.02	-29.45
13-Jan-2008	20:00:00	-15.28	-6.70	-32.68	-5.68	-2.18	-29.92
14-Jan-2008	08:00:00	-16.11	-7.72	-32.78	-6.37	-2.54	-30.34
14-Jan-2008	20:00:00	-16.85	-8.46	-32.89	-7.17	-2.78	-30.78
15-Jan-2008	08:00:00	-17.69	-9.84	-33.28	-8.20	-3.23	-31.14
15-Jan-2008	20:00:00	-18.58	-10.86	-33.72	-8.11	-3.42	-31.73
16-Jan-2008	08:00:00	-19.75	-12.28	-35.18	-10.36	-4.20	-31.83
16-Jan-2008	20:00:00	-20.28	-12.74	-35.97	-8.99	-3.85	-31.67
17-Jan-2008	08:00:00	-10.02	-2.36	-31.62	-0.73	0.63	-14.23
17-Jan-2008	20:00:00	0.43	-0.76	-0.72	-1.93	0.19	-15.95
18-Jan-2008	08:00:00	-1.17	-0.89	-0.91	-2.51	-0.36	-18.09
18-Jan-2008	20:00:00	-2.83	-1.01	-1.15	-2.65	-0.65	-19.52
19-Jan-2008	08:00:00	-1.12	-0.80	-0.73	-0.80	0.30	-7.45
19-Jan-2008	20:00:00	1.73	0.47	-0.24	-0.80	0.80	-9.33
20-Jan-2008	08:00:00	1.18	-0.36	-0.63	-3.99	0.34	-12.88
20-Jan-2008	20:00:00	0.19	-0.76	-0.95	-5.28	-0.12	-15.96
21-Jan-2008	08:00:00	-2.21	-1.31	-1.90	-7.71	-0.83	-17.67
21-Jan-2008	20:00:00	-2.24	-0.89	-1.60	-4.80	-0.56	-18.41
22-Jan-2008	08:00:00	-2.67	-0.89	-1.73	-4.21	-0.51	-18.77
22-Jan-2008	20:00:00	-1.31	-0.76	-1.26	-0.87	-0.26	-19.56
23-Jan-2008	08:00:00	-1.46	-0.78	-1.31	-1.69	-0.55	-20.36
23-Jan-2008	20:00:00	-2.17	-0.86	-1.46	-2.54	-0.71	-20.84
24-Jan-2008	08:00:00	-2.64	-0.91	-1.57	-2.16	-0.71	-21.76
24-Jan-2008	20:00:00	-3.67	-1.10	-1.97	-4.38	-0.94	-23.34
25-Jan-2008	08:00:00	-5.92	-1.69	-3.19	-7.59	-1.37	-23.46

Date	Time	Water Level (inches)					
dd-mmm-yyyy	hh:mm:ss	Jon AW1	Jon AW2	Jon AW3	Jon AW4	Jon AW5	Jon AW6
25-Jan-2008	20:00:00	-6.12	-1.56	-3.26	-4.33	-1.18	-23.71
26-Jan-2008	08:00:00	-6.43	-1.61	-3.41	-3.47	-1.09	-23.62
26-Jan-2008	20:00:00	-6.05	-1.60	-3.36	-3.50	-1.04	-24.30
27-Jan-2008	08:00:00	-7.29	-1.98	-4.39	-6.22	-1.26	-24.83
27-Jan-2008	20:00:00	-7.57	-2.01	-4.70	-5.09	-1.25	-25.64
28-Jan-2008	08:00:00	-9.06	-2.58	-6.48	-7.16	-1.49	-25.62
28-Jan-2008	20:00:00	-8.86	-2.38	-6.11	-5.02	-1.35	-26.04
29-Jan-2008	08:00:00	-9.15	-2.46	-6.13	-4.34	-1.27	-25.92
29-Jan-2008	20:00:00	-8.94	-2.44	-5.74	-5.07	-1.29	-26.15
30-Jan-2008	08:00:00	-5.91	-1.42	-3.04	-2.16	-0.84	-27.17
30-Jan-2008	20:00:00	-8.46	-2.08	-4.86	-5.88	-1.36	-27.72
31-Jan-2008	08:00:00	-10.75	-3.02	-8.21	-7.84	-1.63	-27.54
31-Jan-2008	20:00:00	-10.83	-2.87	-7.92	-6.15	-1.49	-27.07
01-Feb-2008	08:00:00	-3.28	-0.98	-1.45	-0.83	-0.72	-23.71
01-Feb-2008	20:00:00	-0.52	-0.74	-0.95	-3.42	-0.70	-22.88
02-Feb-2008	08:00:00	-1.90	-0.83	-1.30	-4.54	-1.00	-22.54
02-Feb-2008	20:00:00	-2.48	-0.84	-1.37	-4.38	-1.02	-22.86
03-Feb-2008	08:00:00	-3.72	-1.05	-1.58	-4.94	-1.12	-23.16
03-Feb-2008	20:00:00	-4.03	-1.12	-1.66	-4.53	-1.13	-23.79
04-Feb-2008	08:00:00	-4.81	-1.29	-1.80	-4.74	-1.15	-24.20
04-Feb-2008	20:00:00	-4.94	-1.31	-1.82	-3.67	-1.14	-24.59
05-Feb-2008	08:00:00	-5.48	-1.42	-1.91	-3.39	-1.15	-24.63
05-Feb-2008	20:00:00	-5.09	-1.38	-1.87	-4.24	-1.21	-24.88
06-Feb-2008	08:00:00	-5.46	-1.45	-1.89	-3.22	-1.20	-24.76
06-Feb-2008	20:00:00	-3.46	-1.07	-1.50	-1.58	-0.93	-25.54
07-Feb-2008	08:00:00	-5.56	-1.55	-1.94	-5.04	-1.35	-25.78
07-Feb-2008	20:00:00	-6.24	-1.75	-2.24	-6.06	-1.45	-26.16
08-Feb-2008	08:00:00	-7.71	-2.19	-2.90	-6.82	-1.59	-26.67
08-Feb-2008	20:00:00	-8.32	-2.39	-3.44	-6.80	-1.62	-26.99
09-Feb-2008	08:00:00	-9.13	-2.75	-4.14	-7.04	-1.68	-26.99
09-Feb-2008	20:00:00	-9.38	-2.91	-4.52	-7.20	-1.82	-27.84
10-Feb-2008	08:00:00	-10.69	-3.65	-6.16	-8.61	-2.15	-27.89
10-Feb-2008	20:00:00	-11.07	-3.88	-6.64	-7.89	-2.33	-28.65
11-Feb-2008	08:00:00	-12.63	-5.00	-9.19	-9.88	-2.80	-28.68
11-Feb-2008	20:00:00	-12.78	-5.25	-9.09	-8.29	-2.93	-28.83
12-Feb-2008	08:00:00	-13.18	-5.73	-9.46	-8.55	-3.14	-28.36
12-Feb-2008	20:00:00	-9.94	-2.19	-4.15	-2.54	-0.97	-27.86
13-Feb-2008	08:00:00	-2.70	-1.02	-1.55	-1.07	-0.99	-27.65
13-Feb-2008	20:00:00	-2.63	-1.07	-1.59	-2.68	-1.17	-28.63
14-Feb-2008	08:00:00	-6.40	-1.83	-2.48	-6.11	-1.64	-28.36
14-Feb-2008	20:00:00	-7.64	-2.10	-2.90	-6.31	-1.70	-28.19
15-Feb-2008	08:00:00	-9.04	-2.57	-3.68	-6.99	-1.82	-27.89
15-Feb-2008	20:00:00	-8.96	-2.54	-3.68	-5.83	-1.73	-28.04
16-Feb-2008	08:00:00	-9.69	-2.86	-4.34	-6.22	-1.83	-28.18
16-Feb-2008	20:00:00	-9.98	-3.08	-4.83	-6.76	-2.02	-28.41
17-Feb-2008	08:00:00	-10.47	-3.37	-5.22	-6.89	-2.13	-27.74
17-Feb-2008	20:00:00	-9.30	-2.84	-3.91	-5.21	-1.98	-25.72
18-Feb-2008	08:00:00	1.49	-0.57	-0.27	-1.25	0.19	-20.45
18-Feb-2008	20:00:00	0.81	-0.74	-0.70	-6.32	-0.95	-20.75

Date	Time	Water Level (inches)					
dd-mmm-yyyy	hh:mm:ss	Jon AW1	Jon AW2	Jon AW3	Jon AW4	Jon AW5	Jon AW6
19-Feb-2008	08:00:00	-0.06	-0.81	-0.95	-7.46	-1.26	-21.21
19-Feb-2008	20:00:00	-0.90	-0.86	-1.45	-7.26	-1.39	-22.24
20-Feb-08	08:00:00	-1.91	-1.11	-1.95	-7.82	-1.49	-22.45
20-Feb-08	20:00:00	-2.46	-1.20	-2.09	-7.13	-1.55	-23.76
21-Feb-08	08:00:00	-3.87	-1.52	-2.71	-8.67	-1.70	-24.22
21-Feb-08	20:00:00	-3.37	-1.44	-2.70	-7.31	-1.42	-10.90
22-Feb-08	08:00:00	2.05	0.73	0.49	-0.98	0.35	-8.59
22-Feb-08	20:00:00	1.45	-0.07	-0.35	-1.53	-0.16	-10.32
23-Feb-08	08:00:00	1.20	-0.44	-0.59	-1.48	-0.38	-11.74
23-Feb-08	20:00:00	0.94	-0.59	-0.88	-2.89	-0.58	-13.58
24-Feb-08	08:00:00	0.65	-0.65	-1.15	-4.21	-0.75	-15.00
24-Feb-08	20:00:00	0.60	-0.64	-1.23	-3.70	-0.76	-16.40
25-Feb-08	08:00:00	0.49	-0.70	-1.37	-3.88	-0.81	-17.48
25-Feb-08	20:00:00	0.39	-0.70	-1.42	-4.42	-0.88	-18.32
26-Feb-08	08:00:00	0.46	-0.69	-1.23	-2.99	-0.75	-9.45
26-Feb-08	20:00:00	1.86	0.19	-0.23	-1.63	-0.06	-11.56
27-Feb-08	08:00:00	1.63	-0.38	-0.76	-3.78	-0.46	-13.22
27-Feb-08	20:00:00	1.36	-0.61	-1.22	-6.46	-0.72	-15.43
28-Feb-08	08:00:00	1.04	-0.75	-1.78	-8.12	-0.94	-17.10
28-Feb-08	20:00:00	0.93	-0.74	-1.86	-6.27	-0.97	-18.59
29-Feb-08	08:00:00	0.65	-0.81	-2.22	-6.64	-1.04	-18.82
29-Feb-08	20:00:00	0.64	-0.79	-2.07	-5.29	-0.96	-19.53
1-Mar-08	08:00:00	0.57	-0.78	-2.10	-5.01	-0.96	-20.12
1-Mar-08	20:00:00	0.34	-0.85	-2.31	-6.17	-1.10	-21.20
2-Mar-08	08:00:00	-0.03	-1.04	-2.87	-7.08	-1.24	-21.79
2-Mar-08	20:00:00	-0.31	-1.15	-3.02	-6.61	-1.29	-22.48
3-Mar-08	08:00:00	-0.60	-1.33	-3.41	-6.78	-1.31	-22.48
3-Mar-08	20:00:00	-0.56	-1.27	-2.82	-5.45	-1.24	-22.84
4-Mar-08	08:00:00	-0.48	-1.24	-2.51	-4.62	-1.15	-17.50
4-Mar-08	20:00:00	2.58	-0.80	1.01	-0.94	0.85	1.14
5-Mar-08	08:00:00	2.34	-0.52	-0.20	-2.84	1.13	0.18
5-Mar-08	20:00:00	2.13	-1.24	-0.73	-4.45	0.41	-0.69
6-Mar-08	08:00:00	2.02	-1.62	-1.06	-4.53	0.03	-2.41
6-Mar-08	20:00:00	1.93	-1.86	-1.26	-4.88	-0.21	-4.68
7-Mar-08	08:00:00	1.91	-1.82	-1.18	-2.84	-0.17	2.39
7-Mar-08	20:00:00	2.60	1.10	0.83	-0.98	2.75	0.95
8-Mar-08	08:00:00	2.34	-0.21	-0.16	-1.10	1.44	0.00
8-Mar-08	20:00:00	2.10	-0.99	-1.03	-6.31	0.66	-1.07
9-Mar-08	08:00:00	1.96	-1.43	-1.43	-5.93	0.22	-2.98
9-Mar-08	20:00:00	1.85	-1.52	-1.62	-5.65	0.13	-6.45
10-Mar-08	08:00:00	1.77	-1.67	-1.89	-5.34	-0.02	-8.44
10-Mar-08	20:00:00	1.72	-1.66	-1.83	-4.99	-0.01	-10.05
11-Mar-08	08:00:00	1.68	-1.73	-1.94	-4.55	-0.08	-11.02
11-Mar-08	20:00:00	1.65	-1.74	-1.74	-3.65	-0.09	-12.23
12-Mar-08	08:00:00	1.58	-1.85	-1.98	-4.50	-0.20	-13.80
12-Mar-08	20:00:00	1.35	-1.92	-2.22	-6.02	-0.27	-15.75
13-Mar-08	08:00:00	1.22	-2.03	-2.64	-6.15	-0.38	-16.93
13-Mar-08	20:00:00	1.08	-2.02	-2.67	-5.80	-0.37	-18.16
14-Mar-08	08:00:00	1.00	-2.03	-2.79	-5.47	-0.38	-18.75



Date	Time	Water Level (inches)					
dd-mmm-yyyy	hh:mm:ss	Jon AW1	Jon AW2	Jon AW3	Jon AW4	Jon AW5	Jon AW6
14-Mar-08	20:00:00	0.85	-2.06	-2.83	-6.07	-0.41	-20.03
15-Mar-08	08:00:00	0.64	-2.13	-3.25	-6.14	-0.48	-19.59
15-Mar-08	20:00:00	2.88	-0.35	1.51	-1.32	1.30	-5.16
16-Mar-08	08:00:00	2.34	-1.19	-0.55	-3.97	0.46	-2.65
16-Mar-08	20:00:00	2.14	-1.52	-0.98	-6.48	0.13	-5.15
17-Mar-08	08:00:00	2.00	-1.73	-1.37	-7.03	-0.08	-8.38
17-Mar-08	20:00:00	1.82	-1.79	-1.52	-6.60	-0.14	-10.05
18-Mar-08	08:00:00	1.73	-1.86	-1.49	-5.55	-0.21	-10.92
18-Mar-08	20:00:00	1.75	-1.79	-1.29	-4.02	-0.14	-11.95
19-Mar-08	08:00:00	1.77	-1.86	-1.25	-3.27	-0.21	-12.73
19-Mar-08	20:00:00	2.73	-0.65	1.45	-1.05	1.00	-7.08
20-Mar-08	08:00:00	2.28	-1.48	-0.63	-5.31	0.17	-9.20
20-Mar-08	20:00:00	2.05	-1.75	-1.09	-7.32	-0.10	-10.69
21-Mar-08	08:00:00	1.98	-1.93	-1.38	-7.23	-0.28	-11.65
21-Mar-08	20:00:00	1.88	-1.96	-1.46	-6.42	-0.31	-12.85
22-Mar-08	08:00:00	1.84	-1.96	-1.47	-5.75	-0.31	-14.12
22-Mar-08	20:00:00	1.63	-2.09	-1.77	-6.85	-0.44	-16.41
23-Mar-08	08:00:00	1.46	-2.30	-2.33	-8.30	-0.65	-17.60
23-Mar-08	20:00:00	1.20	-2.35	-2.66	-7.40	-0.70	-19.05
24-Mar-08	08:00:00	1.01	-2.46	-3.22	-8.23	-0.81	-19.85
24-Mar-08	20:00:00	0.66	-2.54	-3.78	-8.34	-0.89	-21.09
25-Mar-08	08:00:00	0.27	-2.66	-4.70	-8.82	-1.01	-21.47
25-Mar-08	20:00:00	-0.13	-2.73	-5.03	-7.53	-1.08	-22.23
26-Mar-08	08:00:00	-0.38	-2.71	-5.28	-7.73	-1.06	-22.57
26-Mar-08	20:00:00	-0.78	-2.78	-5.53	-7.23	-1.13	-23.20
27-Mar-08	08:00:00	-1.07	-2.30	-6.62	-7.47	-1.10	-23.31
27-Mar-08	20:00:00	-1.61	-2.54	-7.19	-7.24	-1.19	-23.86
28-Mar-08	08:00:00	-1.84	-2.69	-8.46	-7.55	-1.14	-24.27
28-Mar-08	20:00:00	-2.59	-3.21	-9.21	-7.52	-1.38	-25.01
29-Mar-08	08:00:00	-3.49	-3.80	-11.30	-9.08	-1.47	-25.70
29-Mar-08	20:00:00	-4.47	-4.48	-13.26	-9.32	-1.67	-26.04
30-Mar-08	08:00:00	-5.13	-5.00	-14.29	-9.06	-1.74	-26.40
30-Mar-08	20:00:00	-5.38	-5.25	-14.89	-7.90	-1.62	-26.38
31-Mar-08	08:00:00	0.81	-0.74	-5.63	-1.52	0.40	-24.60
31-Mar-08	20:00:00	1.40	-0.62	-1.58	-1.40	-0.46	-23.11
1-Apr-08	08:00:00	1.33	-0.66	-1.53	-1.47	-0.72	-22.39
1-Apr-08	20:00:00	1.03	-0.68	-1.75	-3.59	-0.91	-22.94
2-Apr-08	08:00:00	0.65	-0.75	-2.24	-4.14	-1.05	-23.63
2-Apr-08	20:00:00	-0.25	-0.97	-3.49	-7.00	-1.42	-18.71
3-Apr-08	08:00:00	2.22	0.70	0.05	-2.18	0.23	-12.29
3-Apr-08	20:00:00	2.38	0.74	0.17	-1.11	0.69	-8.96
4-Apr-08	08:00:00	2.07	0.27	-0.15	-1.52	-0.26	-10.25
4-Apr-08	20:00:00	2.39	0.03	-0.27	-1.10	-0.41	1.39
5-Apr-08	08:00:00	2.47	1.26	0.20	-1.40	1.52	1.31
5-Apr-08	20:00:00	2.54	1.49	0.28	-1.06	1.14	0.31
6-Apr-08	08:00:00	2.34	0.64	-0.06	-1.49	0.69	-0.41
6-Apr-08	20:00:00	2.21	0.32	-0.29	-3.97	0.82	-1.55
7-Apr-08	08:00:00	2.17	0.22	-0.41	-3.82	-0.08	-3.29
7-Apr-08	20:00:00	2.05	-0.04	-0.56	-4.55	-0.21	-6.32

Date	Time	Water Level (inches)					
dd-mmm-yyyy	hh:mm:ss	Jon AW1	Jon AW2	Jon AW3	Jon AW4	Jon AW5	Jon AW6
8-Apr-08	08:00:00	2.04	-0.11	-0.61	-4.48	-0.44	-8.60
8-Apr-08	20:00:00	1.85	-0.30	-0.73	-5.72	-0.53	-10.20
9-Apr-08	08:00:00	1.84	-0.41	-0.84	-5.42	-0.60	-11.81
9-Apr-08	20:00:00	1.66	-0.50	-1.03	-6.24	-0.62	-13.33
10-Apr-08	08:00:00	1.53	-0.56	-1.20	-6.09	-0.64	-15.18
10-Apr-08	20:00:00	1.26	-0.63	-1.58	-6.89	-0.74	-17.17
11-Apr-08	08:00:00	1.19	-0.67	-1.81	-6.37	-0.69	-18.07
11-Apr-08	20:00:00	0.85	-0.74	-2.25	-6.92	-0.76	-19.22
12-Apr-08	08:00:00	0.90	-0.68	-2.33	-5.84	-0.67	-19.55
12-Apr-08	20:00:00	1.31	-0.58	-1.92	-5.37	-0.69	-20.52
13-Apr-08	08:00:00	1.02	-0.67	-2.52	-6.55	-0.88	-21.20
13-Apr-08	20:00:00	0.35	-1.16	-4.26	-8.35	-1.34	-22.22
14-Apr-08	08:00:00	-0.07	-1.28	-5.44	-8.18	-1.26	-22.86
14-Apr-08	20:00:00	-0.18	-1.18	-6.57	-7.42	-1.08	-23.55
15-Apr-08	08:00:00	-0.69	-1.62	-7.72	-7.34	-1.32	-24.06
15-Apr-08	20:00:00	-2.37	-2.54	-9.81	-8.67	-1.69	-24.73
16-Apr-08	08:00:00	-3.41	-3.13	-12.33	-9.66	-1.68	-25.01
16-Apr-08	20:00:00	-4.59	-4.45	-13.53	-8.69	-1.90	-25.48
17-Apr-08	08:00:00	-5.16	-5.16	-15.12	-9.16	-1.91	-25.80
17-Apr-08	20:00:00	-6.57	-6.80	-16.03	-8.36	-2.19	-26.25
18-Apr-08	08:00:00	-7.26	-7.59	-17.45	-9.25	-2.17	-26.56
18-Apr-08	20:00:00	-8.57	-9.12	-18.09	-8.63	-2.52	-26.95
19-Apr-08	08:00:00	-8.94	-9.64	-19.05	-9.17	-2.39	-27.18
19-Apr-08	20:00:00	-9.39	-9.97	-19.14	-7.80	-2.40	-26.74
20-Apr-08	08:00:00	-0.78	-2.30	-12.15	-5.00	-1.37	-26.73
20-Apr-08	20:00:00	-3.44	-3.69	-12.57	-7.48	-1.99	-26.93
21-Apr-08	08:00:00	-4.95	-4.69	-14.30	-8.10	-2.02	-27.46
21-Apr-08	20:00:00	-6.71	-6.09	-15.74	-8.00	-2.27	-27.66
22-Apr-08	08:00:00	-7.35	-6.86	-16.66	-7.91	-2.13	-28.00
22-Apr-08	20:00:00	-8.63	-7.80	-17.58	-7.72	-2.33	-28.34
23-Apr-08	08:00:00	-9.20	-8.29	-18.55	-7.74	-2.26	-28.51
23-Apr-08	20:00:00	-10.62	-9.37	-19.10	-7.68	-2.67	-28.81
24-Apr-08	08:00:00	-11.59	-10.29	-20.08	-8.61	-2.85	-28.96
24-Apr-08	20:00:00	-13.45	-11.61	-20.34	-8.23	-3.59	-29.26
25-Apr-08	08:00:00	-14.42	-12.33	-21.27	-9.25	-3.84	-29.37
25-Apr-08	20:00:00	-15.90	-13.14	-21.36	-8.70	-4.91	-29.67
26-Apr-08	08:00:00	-16.51	-13.74	-22.11	-9.40	-5.22	-29.94
26-Apr-08	20:00:00	-16.20	-14.01	-22.36	-8.56	-5.29	-30.20
27-Apr-08	08:00:00	-14.92	-12.51	-22.98	-7.48	-4.79	-2.12
27-Apr-08	20:00:00	2.55	1.33	0.05	-2.17	1.00	0.76
28-Apr-08	08:00:00	2.78	2.27	0.45	-1.14	0.93	0.88
28-Apr-08	20:00:00	2.85	0.51	0.10	-0.89	0.72	0.61
29-Apr-08	08:00:00	2.36	0.08	-0.23	-4.13	0.28	-0.43
29-Apr-08	20:00:00	2.11	-0.44	-0.66	-7.19	-0.36	-2.26
30-Apr-08	08:00:00	2.06	-0.57	-0.84	-7.19	-0.79	-5.12
30-Apr-08	20:00:00	1.98	-0.78	-1.19	-7.26	-1.09	-9.10
1-May-08	08:00:00	1.84	-0.79	-1.50	-7.48	-1.22	-11.63
1-May-08	20:00:00	1.32	-0.90	-2.27	-7.34	-1.39	-13.36
2-May-08	08:00:00	1.15	-0.90	-2.82	-7.23	-1.43	-15.83

Date	Time	Water Level (inches)					
dd-mmm-yyyy	hh:mm:ss	Jon AW1	Jon AW2	Jon AW3	Jon AW4	Jon AW5	Jon AW6
2-May-08	20:00:00	0.42	-1.73	-5.02	-7.63	-1.53	-18.24
3-May-08	08:00:00	0.22	-1.84	-6.40	-7.52	-1.87	-19.79
3-May-08	20:00:00	-0.63	-2.08	-8.75	-7.45	-1.60	-21.20
4-May-08	08:00:00	-0.85	-2.32	-10.75	-7.53	-1.68	-22.32
4-May-08	20:00:00	-3.07	-4.20	-13.86	-8.08	-1.98	-23.29
5-May-08	08:00:00	-3.41	-4.84	-15.71	-8.54	-1.79	-24.17
5-May-08	20:00:00	-5.43	-7.11	-17.36	-8.81	-2.81	-25.00
6-May-08	08:00:00	-5.97	-8.08	-18.91	-9.18	-2.32	-25.75
6-May-08	20:00:00	-9.16	-10.94	-19.79	-9.48	-3.44	-26.44
7-May-08	08:00:00	-9.44	-12.13	-21.05	-10.03	-3.31	-26.99
7-May-08	20:00:00	-12.08	-13.59	-21.29	-9.52	-4.08	-27.48
8-May-08	08:00:00	-11.72	-14.11	-22.08	-9.42	-3.50	-27.84
8-May-08	20:00:00	-12.52	-14.13	-21.76	-7.19	-3.74	-28.20
9-May-08	08:00:00	-11.57	-14.02	-22.05	-7.26	-3.03	-28.95
9-May-08	20:00:00	-16.31	-16.06	-22.88	-9.02	-5.09	-29.44
10-May-08	08:00:00	-17.23	-16.99	-23.82	-9.79	-4.87	-30.13
10-May-08	20:00:00	-20.36	-18.46	-24.73	-10.83	-7.86	-30.51
11-May-08	08:00:00	-3.05	-18.83	-25.46	-4.26	-0.43	-28.40
11-May-08	20:00:00	-3.71	-1.63	-20.00	-6.45	-1.94	-28.92
12-May-08	08:00:00	-6.87	-2.05	-20.80	-8.05	-2.31	-29.86
12-May-08	20:00:00	-11.82	-6.32	-22.26	-9.76	-3.97	-30.69
13-May-08	08:00:00	-13.73	-8.38	-24.16	-10.48	-4.13	-31.03
13-May-08	20:00:00	-17.41	-12.13	-24.79	-10.00	-5.93	-31.27
14-May-08	08:00:00	-18.47	-14.00	-25.29	-9.99	-6.44	-31.45
14-May-08	20:00:00	-20.64	-16.12	-25.02	-8.76	-9.03	-31.64
15-May-08	08:00:00	-20.92	-16.76	-25.47	-8.54	-9.34	-31.89
15-May-08	20:00:00	-20.68	-17.00	-25.43	-6.36	-7.69	-31.79
16-May-08	08:00:00	-15.85	-12.53	-25.05	-3.89	-3.83	-32.21
16-May-08	20:00:00	-19.69	-14.25	-25.16	-7.36	-8.29	-32.79
17-May-08	08:00:00	-21.13	-16.03	-26.37	-9.10	-10.32	-32.95
17-May-08	20:00:00	-23.35	-18.29	-26.52	-9.20	-13.72	-33.05
18-May-08	08:00:00	-23.96	-18.78	-26.61	-9.71	-15.58	-33.36
18-May-08	20:00:00	-24.91	-19.86	-26.71	-10.28	-16.95	-33.98
19-May-08	08:00:00	-25.11	-19.70	-27.48	-10.11	-17.81	-34.35
19-May-08	20:00:00	-26.16	-20.88	-28.06	-11.26	-18.92	-34.30
20-May-08	08:00:00	-26.66	-21.30	-28.29	-12.54	-19.82	-34.70
20-May-08	20:00:00	-27.33	-21.95	-28.42	-13.30	-20.67	-35.29
21-May-08	08:00:00	-27.62	-21.72	-29.06	-11.27	-21.17	-35.58
21-May-08	20:00:00	-28.18	-21.88	-29.57	-11.66	-21.35	-35.87
22-May-08	08:00:00	-28.75	-22.91	-30.34	-14.62	-21.45	-36.27
22-May-08	20:00:00	-29.50	-23.77	-30.97	-15.47	-22.81	-36.52
23-May-08	08:00:00	-30.06	-24.00	-31.75	-17.87	-23.88	-36.90
23-May-08	20:00:00	-30.67	-25.03	-32.22	-17.56	-24.68	-37.15
24-May-08	08:00:00	-31.23	-25.08	-32.67	-19.06	-25.24	-37.52
24-May-08	20:00:00	-31.79	-25.50	-33.12	-18.62	-25.87	-37.88
25-May-08	08:00:00	-31.84	-25.73	-33.65	-20.09	-26.42	-38.14
25-May-08	20:00:00	-32.75	-26.65	-34.02	-19.20	-26.95	-38.38
26-May-08	08:00:00	-32.71	-26.58	-34.36	-20.61	-27.30	-38.65
26-May-08	20:00:00	-33.69	-27.51	-34.48	-19.87	-27.60	-38.97



Date	Time	Water Level (inches)					
dd-mmm-yyyy	hh:mm:ss	Jon AW1	Jon AW2	Jon AW3	Jon AW4	Jon AW5	Jon AW6
27-May-08	08:00:00	-34.30	-27.88	-34.74	-20.96	-27.91	-39.18
27-May-08	20:00:00	-34.99	-28.35	-34.86	-20.62	-28.19	-39.51
28-May-08	08:00:00	-35.32	-28.83	-35.19	-21.85	-28.55	-39.87
28-May-08	20:00:00	-35.48	-28.67	-35.68	-22.60	-29.08	-39.89
29-May-08	08:00:00	-35.88	-28.83	-36.17	-21.77	-29.33	-40.13
29-May-08	20:00:00	-36.57	-29.40	-36.36	-20.60	-29.19	-40.38
30-May-08	08:00:00	-36.46	-29.53	-36.59	-21.13	-29.07	-40.47
30-May-08	20:00:00	-37.16	-29.94	-36.67	-20.51	-29.15	-40.69
31-May-08	08:00:00	-37.41	-30.20	-36.82	-21.53	-29.27	-40.88
31-May-08	20:00:00	-37.68	-30.31	-36.74	-21.54	-29.36	-41.17
1-Jun-08	08:00:00	-37.99	-30.81	-36.91	-22.85	-29.66	-41.48
1-Jun-08	20:00:00	-38.30	-31.10	-37.01	-22.08	-29.97	-41.53
2-Jun-08	08:00:00	-38.39	-31.45	-37.30	-22.57	-30.20	-41.95
2-Jun-08	20:00:00	-38.76	-31.80	-37.56	-22.93	-30.56	-42.02
3-Jun-08	08:00:00	-38.68	-32.21	-37.94	-23.79	-30.78	-42.26
3-Jun-08	20:00:00	-39.43	-32.42	-38.13	-23.95	-31.05	-42.45
4-Jun-08	08:00:00	-39.67	-32.74	-38.38	-24.64	-31.20	-42.76
4-Jun-08	20:00:00	-39.96	-33.10	-38.58	-25.10	-31.59	-43.09
5-Jun-08	08:00:00	-39.88	-33.76	-39.13	-26.25	-32.04	-43.47
5-Jun-08	20:00:00	-40.36	-34.30	-39.67	-26.84	-32.62	-43.73
6-Jun-08	08:00:00	-40.65	-34.89	-40.35	-27.74	-33.04	-44.03
6-Jun-08	20:00:00	-41.48	-35.26	-40.83	-28.07	-33.44	-44.15
7-Jun-08	08:00:00	-41.38	-35.77	-41.34	-28.82	-33.70	-44.50
7-Jun-08	20:00:00	-42.13	-36.09	-41.62	-29.23	-34.10	-44.68
8-Jun-08	08:00:00	-42.44	-36.50	-42.03	-29.88	-34.24	-45.01
8-Jun-08	20:00:00	-42.75	-36.89	-42.33	-30.38	-34.71	-45.19
9-Jun-08	08:00:00	-43.09	-37.34	-42.69	-31.08	-34.85	-45.47
9-Jun-08	20:00:00	-43.40	-37.80	-43.02	-31.69	-35.34	-45.71
10-Jun-08	08:00:00	-43.82	-38.21	-43.47	-32.40	-35.54	-46.02
10-Jun-08	20:00:00	-44.20	-38.64	-43.77	-32.90	-35.95	-46.26
11-Jun-08	08:00:00	-44.53	-39.20	-44.26	-33.80	-36.23	-46.51
11-Jun-08	20:00:00	-44.47	-39.65	-44.74	-33.71	-36.74	-46.36
12-Jun-08	08:00:00	-42.75	-38.28	-44.31	-33.73	-33.83	-46.44
12-Jun-08	20:00:00	-43.73	-39.23	-45.42	-33.61	-34.88	-46.53
13-Jun-08	08:00:00	-44.06	-39.83	-46.36	-33.73	-35.66	-46.65
13-Jun-08	20:00:00	-44.80	-40.12	-46.78	-33.15	-36.44	-46.54
14-Jun-08	08:00:00	-45.13	-40.42	-47.03	-33.08	-36.06	-46.77
14-Jun-08	20:00:00	-44.75	-40.55	-47.00	-32.89	-36.21	-46.78
15-Jun-08	08:00:00	-44.76	-40.83	-47.18	-33.41	-36.70	-46.94
15-Jun-08	20:00:00	-44.74	-41.01	-47.30	-33.80	-36.59	-47.00
16-Jun-08	08:00:00	-44.74	-41.25	-47.59	-34.37	-36.79	-47.25
16-Jun-08	20:00:00	-44.68	-41.49	-47.78	-34.80	-37.23	-47.28
17-Jun-08	08:00:00	-44.70	-41.80	-48.03	-35.30	-37.85	-47.41
17-Jun-08	20:00:00	-44.63	-42.11	-48.30	-35.82	-37.88	-47.75
18-Jun-08	08:00:00	-44.73	-42.58	-48.95	-36.86	-38.60	-47.98
18-Jun-08	20:00:00	-44.64	-42.95	-49.34	-37.30	-38.67	-48.17
19-Jun-08	08:00:00	-44.75	-43.45	-50.13	-38.28	-39.34	-48.42
19-Jun-08	20:00:00	-44.74	-44.02	-50.78	-38.99	-39.30	-48.55
20-Jun-08	08:00:00	-44.74	-44.65	-51.57	-39.89	-40.05	-48.72

Date	Time	Water Level (inches)					
dd-mmm-yyyy	hh:mm:ss	Jon AW1	Jon AW2	Jon AW3	Jon AW4	Jon AW5	Jon AW6
20-Jun-08	20:00:00	-44.72	-45.11	-52.09	-40.46	-40.09	-48.80
21-Jun-08	08:00:00	-44.69	-45.52	-51.99	-40.93	-40.30	-47.62
21-Jun-08	20:00:00	-29.37	-26.08	-49.26	-39.05	-26.14	-47.15
22-Jun-08	08:00:00	-32.15	-33.35	-50.34	-39.22	-30.97	-45.51
22-Jun-08	20:00:00	-18.56	-1.43	-32.06	-35.58	-13.17	-44.06
23-Jun-08	08:00:00	-24.03	-9.88	-49.26	-35.41	-23.34	-43.80
23-Jun-08	20:00:00	-18.47	-5.36	-48.66	-34.28	-26.05	-43.51
24-Jun-08	08:00:00	-22.85	-10.54	-51.05	-33.36	-29.70	-43.63
24-Jun-08	20:00:00	-26.21	-14.85	-51.44	-32.86	-32.38	-43.66
25-Jun-08	08:00:00	-28.50	-18.34	-51.91	-32.70	-32.93	-43.76
25-Jun-08	20:00:00	-31.03	-20.94	-51.27	-32.34	-33.39	-43.79
26-Jun-08	08:00:00	-32.55	-23.21	-51.49	-32.26	-33.53	-44.08
26-Jun-08	20:00:00	-34.74	-24.92	-50.86	-32.19	-33.84	-44.10
27-Jun-08	08:00:00	-36.03	-26.33	-51.49	-32.66	-34.05	-44.41
27-Jun-08	20:00:00	-37.04	-27.52	-51.57	-33.24	-34.75	-44.58
28-Jun-08	08:00:00	-38.03	-28.76	-51.73	-33.95	-35.46	-44.90
28-Jun-08	20:00:00	-38.83	-29.91	-51.73	-34.60	-35.62	-44.98
29-Jun-08	08:00:00	-39.57	-30.90	-51.74	-35.25	-35.73	-45.27
29-Jun-08	20:00:00	-40.26	-31.66	-51.74	-35.80	-36.20	-45.44
30-Jun-08	08:00:00	-41.01	-32.29	-51.73	-36.68	-36.40	-45.80
30-Jun-08	20:00:00	-41.69	-32.81	-51.73	-37.54	-37.08	-46.09
1-Jul-08	08:00:00	-42.50	-33.38	-51.74	-38.93	-37.62	-46.47
1-Jul-08	20:00:00	-43.27	-33.84	-51.74	-39.80	-38.38	-46.65
2-Jul-08	08:00:00	-44.03	-34.37	-51.73	-40.82	-39.07	-46.93
2-Jul-08	20:00:00	-44.65	-34.84	-51.73	-41.19	-39.23	-47.13
3-Jul-08	08:00:00	-44.81	-35.34	-51.73	-42.03	-39.97	-47.41
3-Jul-08	20:00:00	-44.84	-35.79	-51.73	-42.32	-40.00	-47.58
4-Jul-08	08:00:00	-44.83	-36.28	-51.71	-43.04	-40.58	-47.82
4-Jul-08	20:00:00	-44.73	-36.69	-51.73	-43.39	-40.33	-47.23
5-Jul-08	08:00:00	-38.59	-24.16	-51.73	-43.38	-34.22	-47.33
5-Jul-08	20:00:00	-39.90	-28.07	-51.71	-43.13	-37.09	-47.16
6-Jul-08	08:00:00	-40.75	-29.47	-51.72	-41.83	-38.44	-47.07
6-Jul-08	20:00:00	-0.11	1.02	0.01	-35.51	-2.92	-28.53
7-Jul-08	08:00:00	-12.77	-1.13	-1.42	-33.73	-3.01	-30.00
7-Jul-08	20:00:00	-17.29	-2.84	-27.90	-31.87	-4.41	-31.60
8-Jul-08	08:00:00	-19.70	-4.34	-36.82	-30.47	-6.24	-32.83
8-Jul-08	20:00:00	-12.61	-0.91	-31.29	-27.39	-0.82	-29.86
9-Jul-08	08:00:00	-14.51	-1.21	-33.63	-25.45	-3.24	-30.31
9-Jul-08	20:00:00	-4.07	-0.67	-22.36	-22.33	-0.08	-22.32
10-Jul-08	08:00:00	-10.22	-0.88	-23.92	-19.93	-2.03	-24.48
10-Jul-08	20:00:00	1.38	2.12	-0.68	-15.03	0.50	-9.49
11-Jul-08	08:00:00	-0.33	-0.52	-0.79	-12.18	-1.00	-15.10
11-Jul-08	20:00:00	-4.14	-0.77	-1.68	-10.94	-1.48	-18.31
12-Jul-08	08:00:00	-6.47	-0.69	-3.44	-10.07	-1.86	-21.89
12-Jul-08	20:00:00	-12.50	-1.08	-11.81	-9.41	-2.62	-23.31
13-Jul-08	08:00:00	-13.57	-1.23	-14.29	-9.32	-2.10	-25.61
13-Jul-08	20:00:00	-18.42	-2.93	-17.69	-9.26	-2.31	-26.77
14-Jul-08	08:00:00	-19.54	-3.71	-20.16	-9.70	-2.48	-27.31
14-Jul-08	20:00:00	-16.25	-0.84	-18.30	-8.43	-2.24	-27.93

Date	Time	Water Level (inches)					
dd-mmm-yyyy	hh:mm:ss	Jon AW1	Jon AW2	Jon AW3	Jon AW4	Jon AW5	Jon AW6
15-Jul-08	08:00:00	-17.58	-1.02	-19.31	-8.90	-1.84	-29.44
15-Jul-08	20:00:00	-21.14	-2.78	-22.32	-9.48	-2.93	-30.16
16-Jul-08	08:00:00	-22.48	-3.87	-24.20	-10.02	-2.23	-31.51
16-Jul-08	20:00:00	-24.23	-7.96	-26.05	-9.93	-4.42	-32.00
17-Jul-08	08:00:00	-25.20	-10.19	-27.07	-10.39	-4.47	-33.15
17-Jul-08	20:00:00	-26.66	-13.47	-28.24	-10.24	-7.62	-33.56
18-Jul-08	08:00:00	-27.49	-16.24	-29.12	-10.56	-8.48	-34.40
18-Jul-08	20:00:00	-28.58	-18.22	-30.00	-10.36	-11.99	-34.82
19-Jul-08	08:00:00	-29.27	-19.75	-30.95	-10.61	-15.29	-35.38
19-Jul-08	20:00:00	-30.09	-18.99	-31.30	-9.15	-11.61	-35.65
20-Jul-08	08:00:00	-30.68	-18.27	-32.19	-9.72	-13.23	-36.36
20-Jul-08	20:00:00	-31.52	-20.07	-32.55	-10.43	-17.09	-36.59
21-Jul-08	08:00:00	-32.06	-21.48	-33.06	-13.08	-19.13	-37.43
21-Jul-08	20:00:00	-32.87	-22.67	-34.07	-14.27	-21.78	-37.80
22-Jul-08	08:00:00	-33.70	-23.66	-35.15	-16.24	-22.99	-38.40
22-Jul-08	20:00:00	-35.00	-24.91	-35.81	-16.91	-24.15	-38.64
23-Jul-08	08:00:00	-35.61	-25.86	-36.55	-18.11	-25.04	-39.01
23-Jul-08	20:00:00	-36.18	-26.52	-36.53	-16.41	-25.66	-27.27
24-Jul-08	08:00:00	-3.39	-1.11	-0.91	-11.32	-1.94	-28.10
24-Jul-08	20:00:00	-11.70	-1.69	-3.83	-9.58	-3.15	-28.91
25-Jul-08	08:00:00	-14.27	-2.08	-10.50	-9.57	-2.54	-29.96
25-Jul-08	20:00:00	-17.27	-2.78	-14.53	-8.13	-3.66	-30.44
26-Jul-08	08:00:00	-18.39	-3.53	-15.63	-8.29	-4.07	-30.95
26-Jul-08	20:00:00	-19.72	-4.12	-16.20	-7.35	-3.99	-31.39
27-Jul-08	08:00:00	-20.51	-4.74	-17.34	-7.39	-4.81	-32.31
27-Jul-08	20:00:00	-22.59	-8.24	-19.52	-7.94	-7.08	-32.84
28-Jul-08	08:00:00	-23.54	-10.13	-21.53	-9.22	-8.11	-34.03
28-Jul-08	20:00:00	-25.19	-13.60	-23.64	-10.33	-12.81	-34.41
29-Jul-08	08:00:00	-26.07	-15.70	-24.97	-13.19	-15.61	-34.99
29-Jul-08	20:00:00	-27.16	-17.74	-25.74	-13.83	-17.94	-35.32
30-Jul-08	08:00:00	-27.89	-19.19	-26.47	-15.27	-19.36	-36.00
30-Jul-08	20:00:00	-28.94	-20.61	-27.00	-15.38	-20.34	-36.28
31-Jul-08	08:00:00	-29.54	-21.89	-27.83	-16.70	-21.43	-24.48
31-Jul-08	20:00:00	-3.32	-0.19	-1.72	-12.11	-4.21	-29.39
1-Aug-08	08:00:00	-8.64	-0.98	-3.43	-9.28	-3.27	-30.34
1-Aug-08	20:00:00	-15.19	-1.67	-10.27	-8.15	-4.15	-30.68
2-Aug-08	08:00:00	-16.57	-1.96	-12.30	-8.27	-3.95	-31.88
2-Aug-08	20:00:00	-21.07	-1.35	-16.14	-7.53	-1.85	-32.36
3-Aug-08	08:00:00	-21.48	-1.71	-16.42	-7.73	-3.70	-33.41
3-Aug-08	20:00:00	-23.67	-4.83	-19.09	-8.43	-6.94	-33.79
4-Aug-08	08:00:00	-24.58	-5.80	-21.07	-10.90	-7.33	-34.50
4-Aug-08	20:00:00	-26.08	-10.30	-22.50	-11.82	-11.54	-34.70
5-Aug-08	08:00:00	-26.84	-12.03	-23.40	-14.12	-13.72	-35.57
5-Aug-08	20:00:00	-28.08	-15.20	-24.50	-14.64	-16.95	-35.76
6-Aug-08	08:00:00	-28.72	-16.92	-25.33	-16.22	-18.54	-36.55
6-Aug-08	20:00:00	-29.69	-18.80	-26.13	-16.72	-20.65	-36.81
7-Aug-08	08:00:00	-30.22	-20.35	-26.81	-18.06	-21.85	-37.04
7-Aug-08	20:00:00	-30.90	-13.10	-26.97	-15.23	-18.83	-37.15
8-Aug-08	08:00:00	-31.35	-6.70	-27.68	-11.10	-12.67	-37.78



Date	Time	Water Level (inches)					
dd-mmm-yyyy	hh:mm:ss	Jon AW1	Jon AW2	Jon AW3	Jon AW4	Jon AW5	Jon AW6
8-Aug-08	20:00:00	-32.09	-11.72	-28.64	-12.68	-15.42	-37.84
9-Aug-08	08:00:00	-32.60	-13.87	-29.91	-16.24	-17.29	-38.36
9-Aug-08	20:00:00	-33.42	-17.40	-30.36	-16.92	-20.00	-38.47
10-Aug-08	08:00:00	-34.32	-19.25	-31.00	-18.65	-21.17	-38.69
10-Aug-08	20:00:00	-34.98	-13.91	-30.58	-14.90	-21.23	-38.83
11-Aug-08	08:00:00	-35.50	-13.61	-31.41	-15.34	-20.10	-39.30
11-Aug-08	20:00:00	-36.04	-16.73	-31.91	-16.30	-21.25	-39.44
12-Aug-08	08:00:00	-36.48	-19.14	-33.02	-18.80	-22.09	-39.82
12-Aug-08	20:00:00	-36.97	-20.82	-32.89	-19.28	-23.91	-39.85
13-Aug-08	08:00:00	-36.73	-16.27	-32.72	-14.96	-17.14	-3.58
13-Aug-08	20:00:00	1.83	0.64	0.06	-4.64	0.15	-6.65
14-Aug-08	08:00:00	0.75	-0.49	-0.56	-5.34	-1.07	-12.32
14-Aug-08	20:00:00	-1.04	-0.69	-1.08	-6.78	-1.61	-15.16
15-Aug-08	08:00:00	-1.92	-0.65	-1.55	-6.26	-1.72	-19.98
15-Aug-08	20:00:00	0.54	-1.16	-3.73	-2.80	-2.26	-14.44
16-Aug-08	08:00:00	0.34	-0.57	-0.81	-5.09	-1.58	-17.48
16-Aug-08	20:00:00	-1.61	-0.58	-1.07	-6.33	-1.77	-19.30
17-Aug-08	08:00:00	0.40	-0.43	-0.84	-2.15	-1.27	-7.69
17-Aug-08	20:00:00	1.55	-0.33	-0.24	-5.03	-0.73	-10.60
18-Aug-08	08:00:00	1.13	-0.40	-0.56	-4.82	-0.98	-14.47
18-Aug-08	20:00:00	-0.07	-0.49	-0.95	-6.37	-1.25	-16.86
19-Aug-08	08:00:00	-0.46	-0.39	-1.21	-5.85	-1.39	-20.34
19-Aug-08	20:00:00	-3.55	-1.06	-2.46	-7.10	-1.61	-21.72
20-Aug-08	08:00:00	-3.82	-1.30	-3.14	-6.52	-1.60	-23.93
20-Aug-08	20:00:00	-7.16	-3.04	-6.91	-7.46	-1.92	-24.82
21-Aug-08	08:00:00	-7.47	-3.77	-8.81	-7.02	-1.83	-26.26
21-Aug-08	20:00:00	-10.18	-6.32	-11.58	-7.31	-2.14	-26.97
22-Aug-08	08:00:00	-10.69	-7.34	-13.73	-6.90	-2.02	-28.23
22-Aug-08	20:00:00	-14.50	-10.29	-15.94	-6.75	-2.38	-28.61
23-Aug-08	08:00:00	-15.78	-11.36	-17.34	-6.27	-2.32	-29.57
23-Aug-08	20:00:00	-19.18	-13.90	-18.12	-6.92	-2.60	-30.01
24-Aug-08	08:00:00	-20.08	-15.26	-19.34	-6.42	-2.58	-30.98
24-Aug-08	20:00:00	-21.88	-17.01	-20.02	-6.90	-3.75	-31.28
25-Aug-08	08:00:00	-22.60	-17.82	-21.08	-6.34	-3.99	-31.96
25-Aug-08	20:00:00	-20.18	-8.97	-19.88	-1.98	-0.55	-31.15
26-Aug-08	08:00:00	-12.20	-1.98	-14.37	-1.26	-1.27	-28.73
26-Aug-08	20:00:00	-3.96	-0.83	-2.40	-1.93	-1.20	-23.68
27-Aug-08	08:00:00	0.47	-0.64	-0.94	-1.72	-1.02	-22.03
27-Aug-08	20:00:00	-2.94	-0.77	-1.54	-3.67	-1.56	-22.29
28-Aug-08	08:00:00	-4.18	-0.93	-1.85	-3.37	-1.71	-24.12
28-Aug-08	20:00:00	-7.58	-1.56	-3.46	-4.89	-2.00	-25.04
29-Aug-08	08:00:00	-8.42	-1.77	-4.36	-4.21	-2.10	-26.45
29-Aug-08	20:00:00	-11.94	-3.65	-7.57	-5.40	-2.79	-27.09
30-Aug-08	08:00:00	-13.12	-4.35	-9.12	-4.57	-2.31	-28.09
30-Aug-08	20:00:00	-16.33	-7.67	-11.92	-5.79	-3.48	-28.62
31-Aug-08	08:00:00	-17.02	-8.80	-13.79	-5.04	-3.39	-29.48
31-Aug-08	20:00:00	-19.81	-11.94	-15.88	-3.78	-5.17	-29.88
1-Sep-08	08:00:00	-19.23	-9.80	-15.51	-4.80	-4.41	-30.51
1-Sep-08	20:00:00	-21.42	-13.97	-17.72	-7.74	-7.50	-30.63

Date	Time	Water Level (inches)					
dd-mmm-yyyy	hh:mm:ss	Jon AW1	Jon AW2	Jon AW3	Jon AW4	Jon AW5	Jon AW6
2-Sep-08	08:00:00	-22.17	-15.53	-19.09	-9.07	-8.50	-31.52
2-Sep-08	20:00:00	-23.19	-17.39	-19.93	-10.49	-11.84	-31.75
3-Sep-08	08:00:00	-23.71	-18.59	-21.07	-12.83	-13.89	-32.67
3-Sep-08	20:00:00	-24.49	-19.78	-21.72	-13.07	-16.37	-32.93
4-Sep-08	08:00:00	-25.11	-20.77	-23.17	-15.35	-18.33	-33.74
4-Sep-08	20:00:00	-25.90	-21.64	-23.68	-15.22	-20.07	-33.85
5-Sep-08	08:00:00	-26.43	-22.40	-24.43	-16.59	-21.32	-34.06
5-Sep-08	20:00:00	-26.84	-22.54	-23.96	-15.12	-21.71	-25.20
6-Sep-08	08:00:00	1.55	0.03	-0.31	-3.19	-1.09	-24.97
6-Sep-08	20:00:00	-2.62	-0.72	-0.95	-5.68	-2.55	-25.16
7-Sep-08	08:00:00	-5.24	-0.71	-1.27	-5.23	-2.71	-26.72
7-Sep-08	20:00:00	-9.08	-1.45	-2.51	-6.46	-3.36	-27.47
8-Sep-08	08:00:00	-10.80	-1.75	-3.49	-5.84	-3.50	-28.35
8-Sep-08	20:00:00	-13.66	-3.12	-6.33	-6.69	-4.55	-28.76
9-Sep-08	08:00:00	-14.66	-4.01	-7.60	-6.55	-4.92	-29.56
9-Sep-08	20:00:00	-0.13	-0.45	-1.03	-2.77	-0.76	-26.12
10-Sep-08	08:00:00	0.82	-0.46	-0.66	-1.43	-1.02	30.99
10-Sep-08	20:00:00	10.32	24.19	10.54	-2.58	20.08	2.57
11-Sep-08	08:00:00	2.69	-0.44	-0.01	-2.85	-0.36	-0.50
11-Sep-08	20:00:00	2.38	-0.50	-0.38	-3.12	-0.85	-1.60
12-Sep-08	08:00:00	2.24	-0.48	-0.54	-2.77	-1.01	-3.43
12-Sep-08	20:00:00	1.94	-0.49	-0.73	-3.86	-1.18	-5.77
13-Sep-08	08:00:00	1.87	-0.41	-0.80	-3.26	-1.24	-10.73
13-Sep-08	20:00:00	1.39	-0.63	-1.16	-4.50	-1.44	-12.44
14-Sep-08	08:00:00	1.38	-0.62	-1.34	-3.73	-1.71	-15.21
14-Sep-08	20:00:00	0.70	-1.11	-2.10	-4.86	-1.88	-16.88
15-Sep-08	08:00:00	0.66	-1.33	-2.52	-4.04	-1.94	-19.78
15-Sep-08	20:00:00	-0.40	-2.31	-4.35	-5.06	-2.22	-21.12
16-Sep-08	08:00:00	-0.41	-2.45	-5.01	-3.83	-2.07	-22.02
16-Sep-08	20:00:00	0.20	-1.78	-3.42	-2.82	-1.93	-17.41
17-Sep-08	08:00:00	2.06	-0.58	-0.88	-2.36	-1.54	-18.81
17-Sep-08	20:00:00	1.26	-0.78	-1.26	-3.91	-2.08	-20.30
18-Sep-08	08:00:00	0.94	-0.88	-1.47	-3.57	-2.14	-22.49
18-Sep-08	20:00:00	-0.18	-1.64	-2.23	-4.96	-2.13	-23.55
19-Sep-08	08:00:00	-0.67	-2.07	-2.85	-4.20	-1.77	-24.83
19-Sep-08	20:00:00	-2.52	-3.72	-4.66	-5.11	-2.59	-25.48
20-Sep-08	08:00:00	-2.90	-4.62	-5.77	-4.21	-2.64	-26.48
20-Sep-08	20:00:00	-4.76	-6.91	-7.98	-4.61	-2.68	-27.03
21-Sep-08	08:00:00	-4.98	-7.65	-9.22	-4.07	-2.54	-27.88
21-Sep-08	20:00:00	-6.27	-9.18	-10.65	-3.82	-3.00	-28.01
22-Sep-08	08:00:00	-6.46	-9.47	-11.58	-3.29	-2.96	-28.84
22-Sep-08	20:00:00	-8.95	-12.10	-13.85	-4.84	-3.66	-29.22
23-Sep-08	08:00:00	-9.92	-13.36	-15.63	-4.30	-3.89	-29.77
23-Sep-08	20:00:00	-12.30	-14.56	-16.79	-4.88	-3.99	-30.02
24-Sep-08	08:00:00	-13.29	-15.62	-17.90	-4.43	-4.64	-30.74
24-Sep-08	20:00:00	-16.12	-17.01	-18.83	-5.49	-6.30	-30.88
25-Sep-08	08:00:00	-16.85	-17.58	-19.06	-4.73	-6.78	-31.22
25-Sep-08	20:00:00	-17.87	-18.03	-19.11	-4.01	-7.64	-28.74
26-Sep-08	08:00:00	2.44	0.21	-0.13	-1.42	-0.72	-14.09

Date	Time	Water Level (inches)					
dd-mmm-yyyy	hh:mm:ss	Jon AW1	Jon AW2	Jon AW3	Jon AW4	Jon AW5	Jon AW6
26-Sep-08	20:00:00	2.39	-0.05	-0.01	-1.38	-0.94	-9.12
27-Sep-08	08:00:00	2.11	-0.39	-0.31	-2.02	-1.36	-12.16
27-Sep-08	20:00:00	1.76	-0.54	-0.63	-2.45	-1.90	-14.02
28-Sep-08	08:00:00	1.66	-0.55	-0.76	-2.59	-1.88	-17.12
28-Sep-08	20:00:00	1.24	-0.59	-0.97	-3.43	-2.18	-18.71
29-Sep-08	08:00:00	1.18	-0.57	-1.05	-3.06	-2.12	-20.74
29-Sep-08	20:00:00	0.64	-0.82	-1.50	-3.84	-2.75	-21.69
30-Sep-08	08:00:00	0.78	-0.86	-1.62	-2.13	-2.18	-22.95
30-Sep-08	20:00:00	0.25	-1.18	-2.07	-3.67	-2.75	-23.68
1-Oct-08	08:00:00	0.15	-1.34	-2.32	-3.35	-2.62	-24.85
1-Oct-08	20:00:00	-0.98	-2.06	-3.54	-5.33	-2.94	-25.89
2-Oct-08	08:00:00	-1.84	-2.71	-4.87	-4.77	-2.67	-26.94
2-Oct-08	20:00:00	-3.69	-4.82	-7.45	-5.48	-3.63	-27.56
3-Oct-08	08:00:00	-4.38	-6.08	-9.23	-4.84	-3.70	-28.46
3-Oct-08	20:00:00	-6.22	-8.79	-11.77	-5.35	-4.50	-29.00
4-Oct-08	08:00:00	-6.77	-10.16	-13.48	-4.79	-4.64	-29.67
4-Oct-08	20:00:00	-8.31	-12.32	-15.37	-5.11	-5.71	-30.10
5-Oct-08	08:00:00	-8.88	-13.11	-16.67	-4.47	-5.71	-30.58
5-Oct-08	20:00:00	-10.69	-14.43	-17.61	-5.07	-7.28	-30.86
6-Oct-08	08:00:00	-11.98	-15.09	-18.65	-4.82	-7.72	-31.39
6-Oct-08	20:00:00	-14.10	-16.31	-19.56	-5.56	-9.42	-31.71
7-Oct-08	08:00:00	-15.04	-16.94	-20.70	-5.66	-10.08	-32.04
7-Oct-08	20:00:00	-16.58	-17.57	-20.82	-6.64	-12.22	-32.12
8-Oct-08	08:00:00	-17.02	-17.79	-21.11	-7.31	-12.79	-32.30
8-Oct-08	20:00:00	-16.08	-17.18	-20.95	-2.30	-11.69	-32.37
9-Oct-08	08:00:00	-13.44	-14.60	-19.45	-1.94	-8.28	-30.69
9-Oct-08	20:00:00	-0.78	-1.28	-3.48	-2.30	-2.66	-29.50
10-Oct-08	08:00:00	-3.33	-1.91	-4.64	-2.85	-2.56	-29.70
10-Oct-08	20:00:00	-5.37	-2.66	-6.24	-3.55	-2.89	-29.86
11-Oct-08	08:00:00	-5.47	-2.45	-6.14	-2.53	-2.71	-30.20
11-Oct-08	20:00:00	-7.10	-3.15	-7.42	-4.20	-3.67	-30.48
12-Oct-08	08:00:00	-8.40	-3.95	-8.77	-4.35	-3.61	-31.08
12-Oct-08	20:00:00	-10.77	-6.13	-10.98	-5.19	-4.58	-31.20
13-Oct-08	08:00:00	-11.79	-7.42	-12.19	-4.84	-5.05	-31.57
13-Oct-08	20:00:00	-13.20	-9.44	-13.37	-6.10	-6.19	-31.60
14-Oct-08	08:00:00	-13.87	-10.50	-14.31	-7.30	-6.91	-32.05
14-Oct-08	20:00:00	-15.22	-12.36	-15.61	-8.51	-8.15	-32.26
15-Oct-08	08:00:00	-15.81	-13.20	-16.62	-9.47	-8.20	-32.73
15-Oct-08	20:00:00	-17.13	-14.57	-17.66	-9.90	-10.00	-32.84
16-Oct-08	08:00:00	-17.62	-15.13	-18.40	-10.77	-11.07	-33.10
16-Oct-08	20:00:00	-18.70	-16.13	-19.11	-10.97	-12.55	-33.29
17-Oct-08	08:00:00	-18.63	-16.01	-19.36	-10.15	-13.06	-33.47
17-Oct-08	20:00:00	-13.46	-10.65	-17.77	-2.22	-5.66	-31.35
18-Oct-08	08:00:00	0.03	-1.03	-1.84	-2.65	-3.68	-30.27
18-Oct-08	20:00:00	-2.61	-1.66	-2.36	-4.55	-3.00	-30.08
19-Oct-08	08:00:00	-4.98	-1.96	-3.03	-5.06	-2.94	-30.52
19-Oct-08	20:00:00	-7.20	-2.90	-4.27	-6.93	-4.05	-30.73
20-Oct-08	08:00:00	-8.53	-3.74	-5.54	-7.98	-4.33	-30.86
20-Oct-08	20:00:00	-9.77	-4.95	-6.39	-8.63	-4.83	-31.01



Date	Time	Water Level (inches)					
dd-mmm-yyyy	hh:mm:ss	Jon AW1	Jon AW2	Jon AW3	Jon AW4	Jon AW5	Jon AW6
21-Oct-08	08:00:00	-10.74	-5.85	-7.36	-9.19	-5.56	-31.48
21-Oct-08	20:00:00	-12.20	-7.51	-8.74	-9.51	-6.57	-32.03
22-Oct-08	08:00:00	-13.33	-8.79	-10.39	-10.93	-7.35	-32.48
22-Oct-08	20:00:00	-14.66	-10.72	-12.03	-12.30	-8.84	-32.87
23-Oct-08	08:00:00	-15.62	-11.93	-13.51	-13.17	-9.76	-33.10
23-Oct-08	20:00:00	-16.56	-12.99	-14.28	-13.23	-11.64	-32.91
24-Oct-08	08:00:00	-16.51	-12.74	-13.98	-11.88	-11.55	-32.55
24-Oct-08	20:00:00	-5.18	-1.24	-1.78	-1.80	-2.54	-31.38
25-Oct-08	08:00:00	-3.57	-1.15	-1.73	-1.86	-2.69	-30.95
25-Oct-08	20:00:00	-4.73	-1.17	-1.94	-3.30	-3.96	-30.66
26-Oct-08	08:00:00	-6.94	-1.61	-2.42	-5.24	-3.41	-30.73
26-Oct-08	20:00:00	-8.36	-2.25	-2.92	-6.84	-4.21	-30.55
27-Oct-08	08:00:00	-9.04	-2.70	-3.32	-8.02	-4.86	-31.02
27-Oct-08	20:00:00	-10.86	-3.71	-4.43	-10.53	-5.24	-31.26
28-Oct-08	08:00:00	-11.77	-4.55	-5.26	-11.42	-5.60	-31.81
28-Oct-08	20:00:00	-13.07	-6.08	-6.74	-14.64	-6.52	-31.83
29-Oct-08	08:00:00	-13.72	-7.09	-7.67	-15.38	-7.43	-32.14
29-Oct-08	20:00:00	-14.42	-8.29	-8.59	-12.92	-8.52	-32.70
30-Oct-08	08:00:00	-15.56	-9.79	-10.45	-15.43	-8.59	-33.15
30-Oct-08	20:00:00	-16.42	-11.04	-11.49	-15.36	-10.47	-33.21
31-Oct-08	08:00:00	-17.08	-11.91	-12.45	-16.37	-11.38	-33.16
31-Oct-08	20:00:00	-17.40	-12.48	-12.67	-15.16	-12.34	-33.10
1-Nov-08	08:00:00	-17.71	-12.88	-13.09	-16.05	-13.07	-33.30
1-Nov-08	20:00:00	-17.98	-13.41	-13.53	-15.34	-14.20	-33.34
2-Nov-08	08:00:00	-18.40	-13.80	-14.27	-16.65	-15.26	-33.70
2-Nov-08	20:00:00	-18.84	-14.52	-15.06	-16.41	-16.43	-33.84
3-Nov-08	08:00:00	-19.21	-14.70	-15.53	-16.97	-17.07	-33.56
3-Nov-08	20:00:00	-16.69	-11.30	-11.51	-14.09	-15.41	-33.48
4-Nov-08	08:00:00	-11.34	-1.78	-2.86	-6.79	-4.66	-32.35
4-Nov-08	20:00:00	-7.12	-1.17	-1.81	-4.13	-3.99	-31.44
5-Nov-08	08:00:00	-3.70	-0.87	-1.37	-3.29	-3.53	-30.72
5-Nov-08	20:00:00	-5.17	-1.14	-1.50	-3.59	-4.08	-30.27
6-Nov-08	08:00:00	-6.63	-1.36	-1.67	-4.41	-4.41	-30.17
6-Nov-08	20:00:00	-7.22	-1.56	-1.81	-4.61	-4.52	-30.19
7-Nov-08	08:00:00	-8.29	-1.78	-2.00	-5.62	-4.77	-30.17
7-Nov-08	20:00:00	-8.59	-2.05	-2.06	-5.67	-5.02	-30.09
8-Nov-08	08:00:00	-8.92	-2.10	-2.08	-5.80	-4.97	-30.33
8-Nov-08	20:00:00	-9.86	-2.65	-2.33	-8.14	-5.73	-30.69
9-Nov-08	08:00:00	-11.15	-3.31	-2.72	-9.94	-6.47	-31.13
9-Nov-08	20:00:00	-11.97	-4.10	-3.11	-10.74	-7.41	-31.55
10-Nov-08	08:00:00	-13.21	-5.20	-3.83	-12.46	-7.72	-31.78
10-Nov-08	20:00:00	-13.67	-5.94	-4.18	-12.19	-9.28	-32.12
11-Nov-08	08:00:00	-14.61	-7.00	-5.23	-13.57	-10.42	
11-Nov-08	20:00:00						
12-Nov-08	08:00:00						
12-Nov-08	20:00:00						
13-Nov-08	08:00:00						
13-Nov-08	20:00:00						
14-Nov-08	08:00:00						

Date	Time						
dd-mmm-yyyy	hh:mm:ss	Jon AW7	Jon AW8	Jon AW9	Jon AW10	Jon AW11	Jon AW12
01-Jan-2008	08:00:00	-3.38	-0.21	-31.55	1.22	0.16	-0.31
01-Jan-2008	20:00:00	-3.62	-0.33	-30.75	0.73	0.00	-0.50
02-Jan-2008	08:00:00	-3.86	-0.43	-31.35	-0.10	-0.17	-0.66
02-Jan-2008	20:00:00	-4.10	-0.57	-32.18	-0.90	-0.36	-0.81
03-Jan-2008	08:00:00	-4.52	-0.84	-33.69	-2.73	-0.89	-1.10
03-Jan-2008	20:00:00	-4.38	-0.66	-32.76	-3.28	-0.85	-1.01
04-Jan-2008	08:00:00	-5.08	-1.41	-32.58	-6.91	-1.66	-1.71
04-Jan-2008	20:00:00	-4.25	-0.52	-31.69	-4.45	-0.99	-1.12
05-Jan-2008	08:00:00	-4.72	-1.04	-31.11	-7.98	-1.78	-1.73
05-Jan-2008	20:00:00	-4.02	-0.46	-30.75	-5.27	-0.91	-1.07
06-Jan-2008	08:00:00	-4.00	-0.44	-31.05	-6.74	-1.06	-1.09
06-Jan-2008	20:00:00	-3.91	-0.51	-30.63	-6.53	-1.09	-1.04
07-Jan-2008	08:00:00	-3.96	-0.53	-31.30	-8.28	-1.36	-1.06
07-Jan-2008	20:00:00	-3.87	-0.63	-31.16	-7.75	-1.41	-0.95
08-Jan-2008	08:00:00	-3.87	-0.55	-31.13	-8.77	-1.51	-0.87
08-Jan-2008	20:00:00	-3.76	-0.47	-30.46	-7.48	-1.37	-0.73
09-Jan-2008	08:00:00	-3.73	-0.44	-30.10	-8.23	-1.41	-0.69
09-Jan-2008	20:00:00	-3.72	-0.52	-30.10	-8.35	-1.56	-0.70
10-Jan-2008	08:00:00	-3.68	-0.34	-30.97	-8.02	-0.88	-0.19
10-Jan-2008	20:00:00	-3.19	-0.16	-29.08	-1.46	-0.61	0.03
11-Jan-2008	08:00:00	-3.21	0.12	-27.82	-1.86	0.47	0.35
11-Jan-2008	20:00:00	-2.94	-0.11	-25.50	-0.36	0.17	0.20
12-Jan-2008	08:00:00	-3.22	-0.23	-26.40	-1.02	0.00	-0.26
12-Jan-2008	20:00:00	-3.38	-0.40	-26.14	-1.60	-0.11	-0.44
13-Jan-2008	08:00:00	-3.51	-0.38	-26.47	-2.58	-0.15	-0.49
13-Jan-2008	20:00:00	-3.57	-0.49	-25.55	-3.04	-0.23	-0.53
14-Jan-2008	08:00:00	-3.68	-0.54	-26.13	-4.74	-0.35	-0.66
14-Jan-2008	20:00:00	-3.80	-0.81	-26.46	-5.64	-0.54	-0.69
15-Jan-2008	08:00:00	-3.96	-0.95	-27.31	-7.37	-0.84	-0.86
15-Jan-2008	20:00:00	-4.00	-0.98	-27.55	-8.09	-1.01	-0.88
16-Jan-2008	08:00:00	-4.39	-1.45	-29.27	-10.16	-1.79	-1.32
16-Jan-2008	20:00:00	-4.06	-0.73	-29.41	-9.15	-1.35	-0.94
17-Jan-2008	08:00:00	-2.53	0.40	-29.16	2.20	1.38	0.82
17-Jan-2008	20:00:00	-2.05	0.07	-14.84	2.25	0.73	0.51
18-Jan-2008	08:00:00	-2.58	-0.04	-14.01	1.92	0.41	0.10
18-Jan-2008	20:00:00	-2.71	-0.11	-13.22	1.69	0.31	-0.10
19-Jan-2008	08:00:00	-2.47	0.13	-12.97	2.37	0.84	0.52
19-Jan-2008	20:00:00	-1.61	0.25	-6.70	2.79	1.15	0.76
20-Jan-2008	08:00:00	-2.27	0.02	-4.86	2.02	0.55	0.23
20-Jan-2008	20:00:00	-2.65	-0.08	-8.14	1.58	0.36	-0.17
21-Jan-2008	08:00:00	-3.23	-0.83	-11.64	0.20	-0.12	-1.05
21-Jan-2008	20:00:00	-2.79	-0.12	-10.39	1.22	0.27	-0.36
22-Jan-2008	08:00:00	-2.79	0.00	-11.04	1.17	0.36	-0.25
22-Jan-2008	20:00:00	-2.61	0.04	-9.35	1.76	0.74	0.09
23-Jan-2008	08:00:00	-2.65	-0.09	-8.36	1.52	0.49	0.04
23-Jan-2008	20:00:00	-2.73	-0.14	-9.46	1.45	0.42	-0.12
24-Jan-2008	08:00:00	-2.75	-0.17	-10.12	1.46	0.41	-0.17
24-Jan-2008	20:00:00	-2.86	-0.29	-10.77	1.12	0.21	-0.36
25-Jan-2008	08:00:00	-3.14	-0.61	-14.77	0.17	-0.11	-0.72

Date	Time						
dd-mmm-yyyy	hh:mm:ss	Jon AW7	Jon AW8	Jon AW9	Jon AW10	Jon AW11	Jon AW12
25-Jan-2008	20:00:00	-3.00	-0.37	-14.94	0.58	0.13	-0.52
26-Jan-2008	08:00:00	-2.94	-0.27	-14.09	0.43	0.16	-0.47
26-Jan-2008	20:00:00	-2.90	-0.22	-13.17	0.35	0.21	-0.44
27-Jan-2008	08:00:00	-2.96	-0.39	-13.57	-0.36	-0.01	-0.61
27-Jan-2008	20:00:00	-2.91	-0.36	-14.67	-0.38	0.00	-0.53
28-Jan-2008	08:00:00	-3.07	-0.67	-16.32	-1.43	-0.29	-0.74
28-Jan-2008	20:00:00	-2.94	-0.37	-16.46	-1.01	-0.06	-0.54
29-Jan-2008	08:00:00	-2.84	-0.27	-16.09	-1.04	0.02	-0.44
29-Jan-2008	20:00:00	-2.84	-0.29	-15.66	-1.10	0.01	-0.43
30-Jan-2008	08:00:00	-2.60	-0.04	-14.97	0.35	0.34	0.13
30-Jan-2008	20:00:00	-2.75	-0.26	-16.55	-0.65	0.09	-0.18
31-Jan-2008	08:00:00	-2.93	-0.58	-18.48	-2.07	-0.20	-0.50
31-Jan-2008	20:00:00	-2.87	-0.44	-18.95	-1.78	0.06	-0.30
01-Feb-2008	08:00:00	-2.39	0.12	-14.04	0.87	0.70	0.47
01-Feb-2008	20:00:00	-2.15	0.03	-8.29	2.00	0.66	0.35
02-Feb-2008	08:00:00	-2.40	-0.07	-10.47	1.44	0.50	-0.05
02-Feb-2008	20:00:00	-2.50	-0.07	-10.93	1.42	0.50	-0.10
03-Feb-2008	08:00:00	-2.58	-0.16	-11.26	1.17	0.41	-0.24
03-Feb-2008	20:00:00	-2.59	-0.19	-11.69	1.14	0.41	-0.22
04-Feb-2008	08:00:00	-2.61	-0.22	-12.19	0.96	0.37	-0.22
04-Feb-2008	20:00:00	-2.59	-0.16	-12.45	0.89	0.37	-0.18
05-Feb-2008	08:00:00	-2.61	-0.20	-13.29	0.75	0.39	-0.17
05-Feb-2008	20:00:00	-2.56	-0.20	-12.67	0.68	0.40	-0.16
06-Feb-2008	08:00:00	-2.55	-0.22	-12.55	0.58	0.46	-0.10
06-Feb-2008	20:00:00	-2.40	0.01	-12.11	1.28	0.70	0.16
07-Feb-2008	08:00:00	-2.57	-0.22	-12.15	0.31	0.40	-0.11
07-Feb-2008	20:00:00	-2.64	-0.42	-14.30	0.00	0.37	-0.22
08-Feb-2008	08:00:00	-2.76	-0.49	-14.75	-0.76	0.24	-0.39
08-Feb-2008	20:00:00	-2.81	-0.63	-16.37	-1.14	0.18	-0.41
09-Feb-2008	08:00:00	-2.84	-0.59	-16.72	-1.69	0.13	-0.49
09-Feb-2008	20:00:00	-2.88	-0.76	-16.73	-2.09	0.03	-0.53
10-Feb-2008	08:00:00	-3.01	-0.77	-18.29	-3.94	-0.20	-0.73
10-Feb-2008	20:00:00	-3.04	-0.97	-18.58	-4.73	-0.31	-0.74
11-Feb-2008	08:00:00	-3.21	-1.04	-19.53	-6.67	-0.78	-1.00
11-Feb-2008	20:00:00	-3.17	-1.00	-20.95	-6.95	-0.72	-1.01
12-Feb-2008	08:00:00	-3.19	-0.75	-20.19	-7.84	-0.79	-1.06
12-Feb-2008	20:00:00	-2.67	0.09	-19.61	-0.27	0.64	0.09
13-Feb-2008	08:00:00	-2.25	0.11	-14.85	0.38	0.83	0.38
13-Feb-2008	20:00:00	-2.26	0.03	-11.65	0.32	0.68	0.23
14-Feb-2008	08:00:00	-2.56	-0.14	-15.18	-0.47	0.41	-0.22
14-Feb-2008	20:00:00	-2.64	-0.33	-17.43	-0.79	0.44	-0.30
15-Feb-2008	08:00:00	-2.74	-0.39	-16.92	-1.51	0.40	-0.41
15-Feb-2008	20:00:00	-2.71	-0.37	-16.98	-1.37	0.44	-0.37
16-Feb-2008	08:00:00	-2.75	-0.37	-16.63	-2.09	0.39	-0.41
16-Feb-2008	20:00:00	-2.77	-0.56	-17.51	-2.66	0.33	-0.46
17-Feb-2008	08:00:00	-2.79	-0.44	-17.85	-3.63	0.37	-0.44
17-Feb-2008	20:00:00	-2.70	-0.37	-17.21	-2.37	0.58	-0.31
18-Feb-2008	08:00:00	-1.48	0.28	-14.85	2.66	1.31	0.78
18-Feb-2008	20:00:00	-1.79	0.02	-6.82	1.62	0.75	0.19



Date	Time						
dd-mmm-yyyy	hh:mm:ss	Jon AW7	Jon AW8	Jon AW9	Jon AW10	Jon AW11	Jon AW12
19-Feb-2008	08:00:00	-2.03	-0.08	-9.16	1.16	0.63	-0.13
19-Feb-2008	20:00:00	#REF!	-0.26	-10.74	0.95	0.87	-0.26
20-Feb-08	08:00:00	-2.66	-0.29	#REF!	0.57	0.80	-0.37
20-Feb-08	20:00:00	-2.80	-0.45	-12.17	0.24	0.77	-0.42
21-Feb-08	08:00:00	-3.42	-0.46	-12.90	-0.39	0.58	-0.56
21-Feb-08	20:00:00	-3.41	-0.25	-15.12	-0.22	0.94	-0.27
22-Feb-08	08:00:00	-0.22	0.38	-9.40	2.73	1.54	0.80
22-Feb-08	20:00:00	-1.07	0.20	-2.00	2.12	1.13	0.37
23-Feb-08	08:00:00	-1.31	0.14	-2.33	1.85	1.09	0.22
23-Feb-08	20:00:00	-1.59	0.07	-2.84	1.54	1.01	0.10
24-Feb-08	08:00:00	-1.86	0.01	-4.89	1.44	0.91	-0.04
24-Feb-08	20:00:00	-1.94	-0.02	-6.13	1.41	0.97	-0.07
25-Feb-08	08:00:00	-2.08	-0.04	-6.05	1.23	0.94	-0.12
25-Feb-08	20:00:00	-2.13	-0.12	-6.85	1.11	0.97	-0.15
26-Feb-08	08:00:00	-1.94	-0.05	-7.00	1.21	1.09	-0.06
26-Feb-08	20:00:00	-0.95	0.25	-2.91	2.25	1.22	0.53
27-Feb-08	08:00:00	-1.47	0.15	-2.71	1.79	1.02	0.18
27-Feb-08	20:00:00	-1.93	-0.01	-4.82	1.22	0.86	-0.11
28-Feb-08	08:00:00	-2.49	-0.20	-7.03	0.62	0.75	-0.45
28-Feb-08	20:00:00	-2.57	-0.17	-8.84	0.62	0.74	-0.39
29-Feb-08	08:00:00	-2.93	-0.17	-9.41	0.17	0.69	-0.51
29-Feb-08	20:00:00	-2.78	-0.19	-10.24	0.15	0.86	-0.40
1-Mar-08	08:00:00	-2.81	-0.16	-8.88	-0.17	0.86	-0.43
1-Mar-08	20:00:00	-3.02	-0.33	-9.21	-0.67	0.81	-0.53
2-Mar-08	08:00:00	-3.58	-0.33	-9.77	-1.57	0.68	-0.68
2-Mar-08	20:00:00	-3.73	-0.49	-12.03	-1.78	0.70	-0.70
3-Mar-08	08:00:00	-4.12	-0.37	-12.20	-2.86	0.71	-0.76
3-Mar-08	20:00:00	-3.53	-0.41	-12.47	-2.49	0.81	-0.65
4-Mar-08	08:00:00	-3.22	-0.21	-11.35	-2.50	0.87	-0.57
4-Mar-08	20:00:00	0.29	0.46	-10.93	2.98	1.81	1.15
5-Mar-08	08:00:00	-0.91	0.32	-0.71	2.16	1.18	0.54
5-Mar-08	20:00:00	-1.45	0.26	-0.84	1.78	1.03	0.27
6-Mar-08	08:00:00	-1.77	0.22	-2.59	1.49	0.97	0.15
6-Mar-08	20:00:00	-1.97	0.18	-3.44	1.22	0.98	0.10
7-Mar-08	08:00:00	-1.89	0.21	-3.70	1.31	1.09	0.17
7-Mar-08	20:00:00	0.11	0.45	-2.99	3.60	1.53	0.83
8-Mar-08	08:00:00	-0.88	0.36	1.32	2.53	1.31	0.60
8-Mar-08	20:00:00	-1.74	0.24	0.35	1.59	0.95	0.25
9-Mar-08	08:00:00	-2.14	0.23	-3.44	1.25	0.89	0.09
9-Mar-08	20:00:00	-2.33	0.20	-4.15	0.95	0.88	0.10
10-Mar-08	08:00:00	-2.60	0.19	-4.31	0.49	0.85	0.02
10-Mar-08	20:00:00	-2.54	0.18	-4.69	0.32	0.93	0.08
11-Mar-08	08:00:00	-2.65	0.16	-4.32	-0.08	0.93	0.06
11-Mar-08	20:00:00	-2.45	0.15	-4.85	-0.06	1.03	0.11
12-Mar-08	08:00:00	-2.69	0.11	-4.53	-0.75	0.96	0.04
12-Mar-08	20:00:00	-2.93	0.06	-5.71	-1.29	0.87	-0.08
13-Mar-08	08:00:00	-3.35	0.01	-6.45	-2.06	0.79	-0.16
13-Mar-08	20:00:00	-3.38	-0.09	-7.69	-2.29	0.85	-0.25
14-Mar-08	08:00:00	-3.50	-0.06	-7.39	-3.33	0.86	-0.28

Date	Time						
dd-mmm-yyyy	hh:mm:ss	Jon AW7	Jon AW8	Jon AW9	Jon AW10	Jon AW11	Jon AW12
14-Mar-08	20:00:00	-3.54	-0.26	-7.84	-3.90	0.88	-0.36
15-Mar-08	08:00:00	-3.96	-0.23	-7.56	-4.95	0.78	-0.46
15-Mar-08	20:00:00	0.79	0.58	-9.06	3.10	2.06	1.39
16-Mar-08	08:00:00	-1.26	0.28	-1.80	1.87	1.08	0.45
16-Mar-08	20:00:00	-1.70	0.19	-3.17	1.51	0.92	0.11
17-Mar-08	08:00:00	-2.08	0.16	-4.74	1.09	0.87	-0.11
17-Mar-08	20:00:00	-2.23	0.13	-5.74	0.78	0.90	-0.22
18-Mar-08	08:00:00	-2.20	0.08	-5.31	0.55	0.95	-0.20
18-Mar-08	20:00:00	-2.00	0.10	-5.37	0.59	1.06	-0.12
19-Mar-08	08:00:00	-1.96	0.09	-4.55	0.46	1.07	-0.02
19-Mar-08	20:00:00	0.73	0.52	-4.80	3.08	1.85	1.12
20-Mar-08	08:00:00	-1.34	0.23	-0.77	1.77	1.05	0.42
20-Mar-08	20:00:00	-1.80	0.09	-3.46	1.38	0.97	0.00
21-Mar-08	08:00:00	-2.09	0.06	-5.25	0.99	0.98	-0.14
21-Mar-08	20:00:00	-2.17	-0.20	-6.01	0.64	1.03	-0.26
22-Mar-08	08:00:00	-2.18	-0.02	-5.27	0.30	1.11	-0.24
22-Mar-08	20:00:00	-2.48	-0.47	-5.65	-0.44	1.04	-0.42
23-Mar-08	08:00:00	-3.04	-0.39	-6.20	-1.54	0.89	-0.56
23-Mar-08	20:00:00	-3.37	-0.74	-8.67	-2.37	0.88	-0.69
24-Mar-08	08:00:00	-3.93	-0.59	-8.59	-3.92	0.73	-0.84
24-Mar-08	20:00:00	-4.49	-0.86	-10.08	-5.83	0.62	-1.01
25-Mar-08	08:00:00	-5.41	-0.72	-10.48	-7.59	0.45	-1.11
25-Mar-08	20:00:00	-5.74	-0.96	-12.00	-8.51	0.38	-1.29
26-Mar-08	08:00:00	-5.99	-0.67	-11.32	-9.62	0.35	-1.39
26-Mar-08	20:00:00	-6.24	-0.97	-12.07	-10.44	0.16	-1.57
27-Mar-08	08:00:00	-6.36	-0.72	-11.66	-11.32	0.19	-1.65
27-Mar-08	20:00:00	-6.29	-26.69	-12.10	-12.03	-0.02	-1.95
28-Mar-08	08:00:00	-6.23	-1.02	-13.09	-12.62	-0.02	-2.00
28-Mar-08	20:00:00	-6.16	-0.71	-13.28	-13.29	-0.47	-2.45
29-Mar-08	08:00:00	-6.10	-1.06	-15.18	-14.32	-0.96	-2.93
29-Mar-08	20:00:00	-6.03	-0.95	-15.88	-15.21	-1.32	-3.40
30-Mar-08	08:00:00	-5.96	-1.09	-16.14	-15.71	-1.54	-3.81
30-Mar-08	20:00:00	-5.90	-1.01	-15.71	-15.79	-1.24	-3.68
31-Mar-08	08:00:00	-5.83	-0.77	-10.49	-1.66	1.45	0.79
31-Mar-08	20:00:00	-5.76	0.31	-6.23	0.34	1.18	0.48
1-Apr-08	08:00:00	-5.70	0.19	-5.60	0.20	1.06	0.27
1-Apr-08	20:00:00	-5.63	0.16	-6.03	-0.01	1.01	0.06
2-Apr-08	08:00:00	-5.56	0.01	-7.81	-0.46	0.96	-0.09
2-Apr-08	20:00:00	-5.50	-0.04	-9.23	-1.65	0.82	-0.41
3-Apr-08	08:00:00	-5.43	-0.74	-4.00	2.53	1.31	0.76
3-Apr-08	20:00:00	-5.36	0.31	-1.40	2.77	1.50	0.85
4-Apr-08	08:00:00	-5.30	0.41	-1.90	2.03	1.15	0.49
4-Apr-08	20:00:00	-5.23	0.26	-1.96	2.03	1.18	0.36
5-Apr-08	08:00:00	-5.17	0.65	-0.34	2.34	1.26	0.71
5-Apr-08	20:00:00	-5.10	0.35	0.49	2.56	1.37	0.78
6-Apr-08	08:00:00	-5.03	0.39	-0.44	2.05	1.20	0.60
6-Apr-08	20:00:00	-4.97	0.28	-1.95	1.76	1.14	0.42
7-Apr-08	08:00:00	-4.90	0.24	-2.91	1.59	1.14	0.38
7-Apr-08	20:00:00	-4.83	0.21	-3.47	1.39	1.15	0.35

Date	Time						
dd-mmm-yyyy	hh:mm:ss	Jon AW7	Jon AW8	Jon AW9	Jon AW10	Jon AW11	Jon AW12
8-Apr-08	08:00:00	-4.77	0.15	-4.27	1.21	1.16	0.33
8-Apr-08	20:00:00	-4.70	0.15	-4.59	0.85	1.11	0.24
9-Apr-08	08:00:00	-4.63	-0.10	-5.80	0.45	1.10	0.14
9-Apr-08	20:00:00	-4.57	-0.07	-6.00	-0.12	1.08	-0.01
10-Apr-08	08:00:00	-4.50	-0.44	-7.35	-0.69	1.07	-0.09
10-Apr-08	20:00:00	-4.43	-0.31	-7.66	-1.86	1.03	-0.33
11-Apr-08	08:00:00	-4.37	-0.76	-8.75	-2.14	1.09	-0.32
11-Apr-08	20:00:00	-4.30	-0.48	-8.46	-3.96	0.92	-0.52
12-Apr-08	08:00:00	-4.24	-0.81	-8.95	-4.32	1.03	-0.46
12-Apr-08	20:00:00	-4.17	-0.52	-8.23	-1.82	1.15	-0.20
13-Apr-08	08:00:00	-4.10	-0.15	-9.49	-4.40	1.01	-0.18
13-Apr-08	20:00:00	-4.04	-0.50	-10.48	-8.89	0.83	-0.59
14-Apr-08	08:00:00	-3.97	-0.79	-12.16	-9.68	0.68	-0.67
14-Apr-08	20:00:00	-3.90	-0.87	-12.55	-9.29	0.91	-0.37
15-Apr-08	08:00:00	-3.84	-0.70	-13.19	-10.60	0.52	-0.86
15-Apr-08	20:00:00	-3.77	-0.89	-13.96	-13.33	-0.03	-1.42
16-Apr-08	08:00:00	-3.70	-1.48	-15.49	-14.82	-0.19	-1.65
16-Apr-08	20:00:00	-3.64	-1.25	-15.09	-15.62	-0.57	-2.34
17-Apr-08	08:00:00	-3.57	-1.70	-15.90	-16.50	-0.77	-2.58
17-Apr-08	20:00:00	-3.50	-1.43	-15.80	-16.91	-1.94	-4.02
18-Apr-08	08:00:00	-3.44	-2.20	-16.74	-17.62	-2.21	-4.45
18-Apr-08	20:00:00	-3.37	-1.86	-16.68	-17.87	-3.64	-6.76
19-Apr-08	08:00:00	-3.31	-2.61	-17.45	-18.33	-3.70	-7.32
19-Apr-08	20:00:00	-3.24	-2.04	-16.88	-18.25	-3.86	-8.79
20-Apr-08	08:00:00	-3.17	-2.23	-14.29	-10.65	0.20	-1.15
20-Apr-08	20:00:00	-3.11	-0.02	-14.06	-13.54	-0.15	-2.27
21-Apr-08	08:00:00	-3.04	-1.28	-14.97	-15.11	-0.32	-2.38
21-Apr-08	20:00:00	-2.97	-1.10	-15.65	-16.09	-0.68	-3.32
22-Apr-08	08:00:00	-2.91	-1.39	-16.07	-16.77	-0.74	-3.44
22-Apr-08	20:00:00	-2.84	-1.17	-16.53	-17.30	-1.42	-4.58
23-Apr-08	08:00:00	-2.77	-1.39	-17.14	-17.75	-1.58	-4.75
23-Apr-08	20:00:00	-2.71	-1.21	-17.23	-18.05	-2.59	-6.81
24-Apr-08	08:00:00	-2.64	-1.56	-17.81	-18.70	-3.26	-7.89
24-Apr-08	20:00:00	-2.67	-1.36	-17.63	-18.84	-4.78	-11.28
25-Apr-08	08:00:00	-2.81	-2.07	-18.58	-19.36	-5.02	-12.13
25-Apr-08	20:00:00	-2.86	-1.72	-18.23	-19.46	-6.47	-14.37
26-Apr-08	08:00:00	-2.98	-2.41	-19.14	-19.90	-6.21	-15.06
26-Apr-08	20:00:00	-3.01	-2.02	-19.26	-20.04	-6.92	-16.02
27-Apr-08	08:00:00	-3.07	-2.29	-19.37	-19.97	-4.99	-14.39
27-Apr-08	20:00:00	-2.89	-1.44	-8.91	2.67	1.36	0.77
28-Apr-08	08:00:00	2.11	0.19	-2.53	2.87	1.52	0.99
28-Apr-08	20:00:00	0.81	0.26	-0.16	2.64	1.60	0.81
29-Apr-08	08:00:00	-0.23	0.39	-0.64	1.86	0.83	0.21
29-Apr-08	20:00:00	-0.50	0.03	-2.98	1.32	0.63	-0.40
30-Apr-08	08:00:00	-1.27	-1.21	-4.44	0.88	0.66	-0.56
30-Apr-08	20:00:00	-1.61	-1.08	-5.05	0.17	0.54	-1.01
1-May-08	08:00:00	-1.81	-1.49	-6.56	-0.52	0.52	-1.22
1-May-08	20:00:00	-1.90	-1.24	-7.28	-1.79	0.31	-2.13
2-May-08	08:00:00	-1.98	-1.74	-8.65	-2.54	0.30	-2.08



Date	Time						
dd-mmm-yyyy	hh:mm:ss	Jon AW7	Jon AW8	Jon AW9	Jon AW10	Jon AW11	Jon AW12
2-May-08	20:00:00	-1.99	-1.43	-9.68	-7.41	-0.16	-4.64
3-May-08	08:00:00	-2.07	-2.12	-11.05	-9.22	-0.04	-4.35
3-May-08	20:00:00	-2.01	-1.66	-11.50	-12.05	-0.65	-7.69
4-May-08	08:00:00	-2.03	-2.30	-12.60	-12.85	-0.77	-7.89
4-May-08	20:00:00	-1.99	-2.01	-13.44	-15.19	-3.18	-12.80
5-May-08	08:00:00	-2.16	-3.33	-14.55	-15.99	-3.19	-13.48
5-May-08	20:00:00	-2.17	-2.67	-15.13	-16.92	-5.79	-16.14
6-May-08	08:00:00	-2.33	-4.07	-16.22	-17.72	-5.97	-16.93
6-May-08	20:00:00	-2.40	-3.35	-16.60	-18.36	-9.67	-18.55
7-May-08	08:00:00	-2.77	-6.32	-17.59	-19.03	-9.19	-19.25
7-May-08	20:00:00	-2.87	-5.55	-17.54	-19.30	-11.86	-19.95
8-May-08	08:00:00	-3.27	-9.17	-18.30	-19.66	-10.21	-20.39
8-May-08	20:00:00	-3.30	-7.10	-17.50	-19.42	-10.79	-20.57
9-May-08	08:00:00	-3.44	-8.37	-17.31	-19.64	-9.08	-20.83
9-May-08	20:00:00	-3.29	-5.50	-18.12	-20.15	-13.67	-21.20
10-May-08	08:00:00	-4.27	-11.89	-19.56	-20.76	-12.68	-21.64
10-May-08	20:00:00	-4.34	-10.51	-20.19	-21.39	-16.03	-22.09
11-May-08	08:00:00	-6.31	-15.93	-21.33	-21.78	-6.41	-22.45
11-May-08	20:00:00	-3.11	-0.07	-13.88	-14.30	-1.87	-14.74
12-May-08	08:00:00	-2.53	-1.06	-14.07	-14.22	-3.83	-16.36
12-May-08	20:00:00	-2.81	-2.26	-15.83	-16.93	-9.42	-18.27
13-May-08	08:00:00	-3.50	-4.19	-18.18	-18.60	-10.33	-19.58
13-May-08	20:00:00	-3.74	-4.72	-18.67	-19.50	-13.12	-20.48
14-May-08	08:00:00	-4.57	-8.51	-19.36	-20.19	-12.62	-21.25
14-May-08	20:00:00	-4.86	-7.86	-19.31	-20.57	-14.28	-21.75
15-May-08	08:00:00	-5.61	-10.82	-19.64	-20.89	-12.95	-22.22
15-May-08	20:00:00	-5.36	-8.76	-19.63	-21.08	-11.22	-22.54
16-May-08	08:00:00	-4.14	-5.02	-17.89	-20.09	-7.73	-22.67
16-May-08	20:00:00	-3.56	-1.98	-16.71	-19.73	-11.93	-22.71
17-May-08	08:00:00	-4.71	-5.22	-19.13	-20.85	-13.04	-23.03
17-May-08	20:00:00	-5.31	-6.33	-19.42	-21.41	-15.81	-23.24
18-May-08	08:00:00	-7.98	-12.08	-20.37	-21.80	-14.37	-23.45
18-May-08	20:00:00	-7.57	-10.92	-20.35	-22.24	-14.93	-23.64
19-May-08	08:00:00	-7.40	-10.80	-22.45	-22.89	-13.75	-23.99
19-May-08	20:00:00	-7.67	-8.69	-22.91	-23.36	-16.88	-24.23
20-May-08	08:00:00	-12.81	-16.16	-23.45	-23.50	-15.25	-24.40
20-May-08	20:00:00	-12.28	-13.93	-23.63	-23.88	-16.28	-24.59
21-May-08	08:00:00	-16.29	-14.56	-25.24	-24.28	-12.85	-24.87
21-May-08	20:00:00	-9.35	-7.14	-24.89	-24.54	-15.39	-25.10
22-May-08	08:00:00	-14.89	-13.95	-26.03	-25.06	-15.52	-25.43
22-May-08	20:00:00	-15.86	-14.49	-26.83	-25.58	-17.86	-25.72
23-May-08	08:00:00	-18.75	-19.81	-27.95	-26.03	-17.04	-26.06
23-May-08	20:00:00	-19.36	-18.13	-28.70	-26.57	-18.48	-26.35
24-May-08	08:00:00	-20.70	-21.48	-29.01	-26.90	-17.32	-26.62
24-May-08	20:00:00	-21.24	-19.48	-30.17	-27.33	-17.17	-26.89
25-May-08	08:00:00	-21.25	-18.88	-30.79	-27.87	-17.08	-27.22
25-May-08	20:00:00	-22.04	-18.40	-31.41	-28.37	-18.89	-27.50
26-May-08	08:00:00	-22.89	-22.45	-31.93	-28.67	-18.32	-27.81
26-May-08	20:00:00	-23.50	-21.01	-32.33	-28.91	-19.46	-28.02

Date	Time						
dd-mmm-yyyy	hh:mm:ss	Jon AW7	Jon AW8	Jon AW9	Jon AW10	Jon AW11	Jon AW12
27-May-08	08:00:00	-23.93	-23.95	-32.99	-29.10	-18.77	-28.30
27-May-08	20:00:00	-24.33	-22.11	-33.55	-29.42	-19.81	-28.45
28-May-08	08:00:00	-24.83	-24.63	-34.64	-29.64	-19.59	-28.77
28-May-08	20:00:00	-25.29	-23.22	-35.74	-30.10	-17.60	-29.10
29-May-08	08:00:00	-25.74	-18.51	-36.46	-30.36	-15.28	-29.38
29-May-08	20:00:00	-24.80	-12.29	-36.23	-30.48	-16.34	-29.59
30-May-08	08:00:00	-24.47	-16.60	-36.46	-30.58	-16.66	-29.84
30-May-08	20:00:00	-24.68	-16.83	-36.74	-30.81	-18.17	-30.01
31-May-08	08:00:00	-25.30	-20.71	-37.45	-30.90	-18.29	-30.20
31-May-08	20:00:00	-25.75	-19.31	-37.14	-31.07	-19.53	-30.34
1-Jun-08	08:00:00	-26.17	-23.14	-38.28	-31.29	-19.89	-30.55
1-Jun-08	20:00:00	-26.59	-22.16	-38.84	-31.61	-17.95	-30.72
2-Jun-08	08:00:00	-26.72	-15.09	-39.70	-31.87	-17.21	-31.05
2-Jun-08	20:00:00	-26.90	-12.16	-40.38	-32.26	-18.66	-31.33
3-Jun-08	08:00:00	-27.33	-17.64	-41.03	-32.46	-19.49	-31.69
3-Jun-08	20:00:00	-27.62	-18.16	-40.82	-32.78	-20.60	-31.84
4-Jun-08	08:00:00	-28.04	-22.21	-40.59	-32.93	-20.98	-32.11
4-Jun-08	20:00:00	-28.40	-21.40	-40.58	-33.36	-21.73	-32.29
5-Jun-08	08:00:00	-28.82	-25.25	-40.59	-33.73	-22.29	-32.66
5-Jun-08	20:00:00	-29.31	-24.40	-40.60	-34.29	-23.04	-32.85
6-Jun-08	08:00:00	-29.85	-26.99	-40.59	-34.60	-23.59	-33.13
6-Jun-08	20:00:00	-30.34	-25.94	-40.59	-35.08	-24.26	-33.30
7-Jun-08	08:00:00	-30.83	-28.00	-40.58	-35.30	-24.70	-33.56
7-Jun-08	20:00:00	-31.28	-27.13	-40.60	-35.76	-25.34	-33.71
8-Jun-08	08:00:00	-31.68	-28.81	-40.60	-35.92	-25.72	-33.94
8-Jun-08	20:00:00	-32.06	-27.89	-40.59	-36.53	-26.37	-34.11
9-Jun-08	08:00:00	-32.37	-29.53	-40.59	-36.70	-26.70	-34.33
9-Jun-08	20:00:00	-32.67	-28.72	-40.59	-37.29	-27.32	-34.55
10-Jun-08	08:00:00	-32.94	-30.09	-40.59	-37.51	-27.63	-34.80
10-Jun-08	20:00:00	-33.22	-29.44	-40.59	-37.82	-28.30	-35.03
11-Jun-08	08:00:00	-33.46	-30.74	-40.60	-38.07	-28.67	-35.31
11-Jun-08	20:00:00	-33.76	-30.54	-40.59	-37.72	-29.29	-35.59
12-Jun-08	08:00:00	-34.06	-29.87	-40.60	-37.73	-27.90	-35.86
12-Jun-08	20:00:00	-33.67	-22.74	-40.59	-37.72	-28.33	-36.06
13-Jun-08	08:00:00	-34.06	-22.73	-40.61	-37.72	-28.70	-36.32
13-Jun-08	20:00:00	-34.40	-21.61	-40.59	-37.72	-29.00	-36.48
14-Jun-08	08:00:00	-34.66	-22.24	-40.61	-37.72	-29.20	-36.65
14-Jun-08	20:00:00	-34.96	-21.58	-40.61	-37.71	-29.47	-36.76
15-Jun-08	08:00:00	-35.20	-23.32	-40.61	-37.71	-29.67	-36.92
15-Jun-08	20:00:00	-35.49	-23.16	-40.61	-37.71	-29.97	-37.07
16-Jun-08	08:00:00	-35.72	-24.28	-40.60	-37.72	-30.22	-37.22
16-Jun-08	20:00:00	-35.98	-24.24	-40.60	-37.71	-30.65	-37.44
17-Jun-08	08:00:00	-36.22	-26.14	-40.59	-37.71	-30.91	-37.61
17-Jun-08	20:00:00	-36.48	-26.21	-40.60	-37.72	-31.35	-37.88
18-Jun-08	08:00:00	-36.74	-28.01	-40.61	-37.72	-31.66	-38.15
18-Jun-08	20:00:00	-37.02	-28.70	-40.59	-37.71	-32.10	-38.45
19-Jun-08	08:00:00	-37.29	-30.33	-40.61	-37.71	-32.43	-38.71
19-Jun-08	20:00:00	-37.59	-30.69	-40.60	-37.72	-33.03	-39.08
20-Jun-08	08:00:00	-37.86	-31.95	-40.61	-37.72	-33.36	-39.39

Date	Time						
dd-mmm-yyyy	hh:mm:ss	Jon AW7	Jon AW8	Jon AW9	Jon AW10	Jon AW11	Jon AW12
20-Jun-08	20:00:00	-38.17	-32.02	-40.60	-37.71	-33.88	-39.80
21-Jun-08	08:00:00	-38.44	-32.83	-40.61	-37.70	-34.09	-40.14
21-Jun-08	20:00:00	-38.72	-32.64	-40.60	-37.71	-19.41	-40.45
22-Jun-08	08:00:00	-27.46	-12.49	-40.61	-37.71	-22.00	-40.64
22-Jun-08	20:00:00	-29.58	-16.75	-40.61	-23.18	-2.41	-29.10
23-Jun-08	08:00:00	-21.22	-1.02	-40.61	-2.07	-5.05	-30.21
23-Jun-08	20:00:00	-26.32	-3.04	-40.61	-1.62	-3.78	-31.73
24-Jun-08	08:00:00	-27.85	-0.55	-40.61	-4.92	-7.88	-32.77
24-Jun-08	20:00:00	-29.25	-1.85	-40.60	-12.66	-12.55	-33.50
25-Jun-08	08:00:00	-30.39	-5.33	-40.61	-16.05	-14.31	-34.11
25-Jun-08	20:00:00	-31.16	-5.26	-40.61	-19.04	-16.15	-34.65
26-Jun-08	08:00:00	-31.70	-9.16	-40.60	-20.84	-16.91	-35.03
26-Jun-08	20:00:00	-32.17	-8.69	-40.61	-22.42	-18.13	-35.48
27-Jun-08	08:00:00	-32.55	-13.08	-40.60	-23.72	-18.65	-35.80
27-Jun-08	20:00:00	-32.95	-13.23	-40.61	-25.13	-19.60	-36.23
28-Jun-08	08:00:00	-33.32	-16.77	-40.61	-26.36	-20.02	-36.51
28-Jun-08	20:00:00	-33.73	-16.76	-40.61	-27.85	-20.72	-36.90
29-Jun-08	08:00:00	-34.11	-19.18	-40.61	-29.11	-21.06	-37.15
29-Jun-08	20:00:00	-34.48	-18.73	-40.61	-29.98	-21.66	-37.52
30-Jun-08	08:00:00	-34.85	-20.82	-40.62	-30.70	-22.02	-37.76
30-Jun-08	20:00:00	-35.20	-20.40	-40.60	-31.59	-22.74	-38.14
1-Jul-08	08:00:00	-35.58	-22.31	-40.60	-32.45	-23.26	-38.46
1-Jul-08	20:00:00	-35.97	-22.52	-40.60	-33.44	-24.10	-38.89
2-Jul-08	08:00:00	-36.36	-24.28	-40.61	-33.98	-24.61	-39.19
2-Jul-08	20:00:00	-36.74	-24.24	-40.61	-34.46	-25.39	-39.66
3-Jul-08	08:00:00	-37.13	-26.06	-40.60	-35.09	-25.81	-40.04
3-Jul-08	20:00:00	-37.51	-26.24	-40.61	-35.73	-26.47	-40.50
4-Jul-08	08:00:00	-37.88	-27.75	-40.62	-36.23	-26.82	-40.84
4-Jul-08	20:00:00	-38.21	-28.02	-40.62	-36.77	-27.40	-41.07
5-Jul-08	08:00:00	-38.56	-29.29	-40.61	-36.47	-19.18	-41.23
5-Jul-08	20:00:00	-38.17	-18.91	-40.60	-35.94	-21.28	-41.41
6-Jul-08	08:00:00	-38.49	-13.24	-40.61	-35.11	-17.10	-41.57
6-Jul-08	20:00:00	-38.83	-9.24	-40.62	0.87	0.96	0.65
7-Jul-08	08:00:00	-3.63	0.30	-40.60	1.37	-0.15	-0.44
7-Jul-08	20:00:00	-3.74	-0.24	-40.61	0.09	-0.61	-1.74
8-Jul-08	08:00:00	-5.79	-2.02	-40.61	-1.47	-0.85	-3.74
8-Jul-08	20:00:00	-7.23	-1.92	-40.61	1.46	1.11	0.25
9-Jul-08	08:00:00	-3.77	0.31	-38.15	1.23	0.16	-0.25
9-Jul-08	20:00:00	-3.97	-0.16	-37.63	2.59	1.17	0.55
10-Jul-08	08:00:00	-2.81	0.33	-25.41	1.62	0.35	-0.08
10-Jul-08	20:00:00	-3.01	-0.02	-28.14	2.66	1.25	0.74
11-Jul-08	08:00:00	-1.72	0.28	-2.63	1.88	0.58	0.13
11-Jul-08	20:00:00	-1.98	0.09	-12.84	1.38	0.37	-0.16
12-Jul-08	08:00:00	-2.63	-1.04	-13.22	1.08	0.37	-0.27
12-Jul-08	20:00:00	-2.88	-1.08	-13.49	-0.14	-0.02	-1.01
13-Jul-08	08:00:00	-3.61	-2.28	-15.00	-0.79	-0.07	-1.22
13-Jul-08	20:00:00	-3.60	-1.91	-15.63	-3.43	-0.82	-2.69
14-Jul-08	08:00:00	-4.69	-4.04	-16.92	-5.38	-0.95	-2.76
14-Jul-08	20:00:00	-4.45	-3.41	-18.12	-0.59	0.46	0.03

Date	Time						
dd-mmm-yyyy	hh:mm:ss	Jon AW7	Jon AW8	Jon AW9	Jon AW10	Jon AW11	Jon AW12
15-Jul-08	08:00:00	-2.83	-0.21	-17.20	-1.45	0.44	-0.13
15-Jul-08	20:00:00	-3.06	-0.82	-17.81	-6.64	-0.09	-0.90
16-Jul-08	08:00:00	-4.03	-2.71	-19.36	-9.24	-0.18	-1.17
16-Jul-08	20:00:00	-4.17	-2.57	-20.60	-13.38	-1.14	-3.02
17-Jul-08	08:00:00	-5.71	-5.60	-21.31	-14.72	-1.34	-3.22
17-Jul-08	20:00:00	-5.80	-5.51	-22.43	-16.56	-4.35	-8.93
18-Jul-08	08:00:00	-8.64	-9.01	-23.13	-17.22	-4.41	-10.17
18-Jul-08	20:00:00	-7.93	-8.42	-24.25	-18.18	-7.44	-13.69
19-Jul-08	08:00:00	-10.48	-10.85	-25.01	-18.77	-7.55	-15.02
19-Jul-08	20:00:00	-9.69	-10.35	-26.05	-18.70	-5.09	-13.65
20-Jul-08	08:00:00	-8.19	-7.99	-26.18	-19.08	-6.15	-14.83
20-Jul-08	20:00:00	-8.73	-8.45	-26.77	-19.86	-10.63	-17.50
21-Jul-08	08:00:00	-14.45	-12.73	-26.87	-20.28	-10.92	-18.31
21-Jul-08	20:00:00	-14.30	-12.76	-27.78	-21.16	-14.15	-19.64
22-Jul-08	08:00:00	-17.94	-16.49	-28.80	-21.66	-14.76	-20.30
22-Jul-08	20:00:00	-18.02	-16.29	-30.10	-22.36	-16.67	-21.13
23-Jul-08	08:00:00	-20.02	-19.20	-31.05	-22.86	-16.70	-21.64
23-Jul-08	20:00:00	-20.12	-18.53	-31.97	-23.32	-14.27	-22.06
24-Jul-08	08:00:00	-19.18	-17.53	-32.23	1.52	0.25	0.06
24-Jul-08	20:00:00	-2.39	-0.12	-24.07	0.51	-0.18	-0.80
25-Jul-08	08:00:00	-3.22	-2.10	-19.86	-0.30	-0.27	-1.17
25-Jul-08	20:00:00	-3.45	-1.78	-19.16	-1.38	-0.47	-1.66
26-Jul-08	08:00:00	-3.71	-2.16	-18.60	-2.14	-0.60	-1.87
26-Jul-08	20:00:00	-3.69	-2.04	-18.64	-3.49	-0.69	-2.19
27-Jul-08	08:00:00	-3.74	-2.19	-18.05	-4.99	-0.77	-2.30
27-Jul-08	20:00:00	-3.74	-2.03	-18.59	-9.77	-2.43	-5.15
28-Jul-08	08:00:00	-4.70	-3.98	-19.40	-11.45	-2.74	-5.42
28-Jul-08	20:00:00	-4.83	-4.17	-21.24	-15.12	-7.13	-11.59
29-Jul-08	08:00:00	-6.99	-8.11	-22.59	-16.17	-6.69	-12.46
29-Jul-08	20:00:00	-6.42	-7.49	-24.15	-17.22	-9.82	-15.35
30-Jul-08	08:00:00	-8.04	-10.11	-24.72	-17.94	-9.65	-16.07
30-Jul-08	20:00:00	-7.48	-9.34	-25.72	-18.84	-12.74	-18.08
31-Jul-08	08:00:00	-11.51	-12.99	-26.24	-19.41	-12.30	-18.54
31-Jul-08	20:00:00	-11.22	-12.46	-27.45	1.44	0.59	0.41
1-Aug-08	08:00:00	-2.22	0.07	-23.61	1.40	0.35	-0.15
1-Aug-08	20:00:00	-2.57	-0.12	-18.91	0.43	-0.02	-0.93
2-Aug-08	08:00:00	-3.19	-2.61	-17.49	-0.09	-0.06	-1.12
2-Aug-08	20:00:00	-3.31	-2.23	-17.67	0.92	0.79	-0.12
3-Aug-08	08:00:00	-2.82	-0.59	-18.67	-0.36	0.07	-1.22
3-Aug-08	20:00:00	-3.22	-1.60	-18.52	-2.32	-0.65	-2.78
4-Aug-08	08:00:00	-4.17	-4.17	-19.26	-3.51	-0.85	-2.87
4-Aug-08	20:00:00	-4.30	-4.08	-20.97	-9.48	-2.74	-6.93
5-Aug-08	08:00:00	-5.84	-7.38	-21.77	-11.10	-2.90	-7.15
5-Aug-08	20:00:00	-5.85	-6.97	-22.99	-14.75	-7.00	-12.69
6-Aug-08	08:00:00	-8.11	-10.94	-23.99	-15.78	-6.79	-13.43
6-Aug-08	20:00:00	-7.47	-9.98	-25.25	-17.55	-11.40	-17.15
7-Aug-08	08:00:00	-12.81	-14.47	-26.01	-18.39	-11.23	-17.63
7-Aug-08	20:00:00	-11.65	-13.62	-27.28	-12.36	-1.24	-9.00
8-Aug-08	08:00:00	-4.73	-3.17	-27.44	-4.68	-0.78	-4.55



Date	Time						
dd-mmm-yyyy	hh:mm:ss	Jon AW7	Jon AW8	Jon AW9	Jon AW10	Jon AW11	Jon AW12
8-Aug-08	20:00:00	-4.19	-0.89	-27.41	-11.95	-4.40	-11.57
9-Aug-08	08:00:00	-6.93	-4.34	-27.28	-14.42	-5.28	-13.04
9-Aug-08	20:00:00	-7.82	-5.41	-28.76	-16.94	-10.12	-17.01
10-Aug-08	08:00:00	-13.15	-10.23	-29.29	-18.13	-9.04	-17.42
10-Aug-08	20:00:00	-13.00	-9.69	-30.56	-10.88	-1.97	-11.53
11-Aug-08	08:00:00	-6.50	-2.62	-30.64	-12.10	-4.03	-13.31
11-Aug-08	20:00:00	-7.80	-3.38	-31.35	-16.03	-9.51	-17.58
12-Aug-08	08:00:00	-14.14	-8.83	-31.64	-17.71	-10.49	-18.43
12-Aug-08	20:00:00	-14.68	-9.66	-33.15	-19.03	-13.62	-19.82
13-Aug-08	08:00:00	-17.93	-14.41	-33.29	-11.77	1.23	-8.10
13-Aug-08	20:00:00	-3.65	-0.07	-34.22	2.67	0.92	0.49
14-Aug-08	08:00:00	0.23	0.37	-3.47	1.86	0.52	0.08
14-Aug-08	20:00:00	-1.54	0.20	-7.65	1.28	0.31	-0.34
15-Aug-08	08:00:00	-2.33	-0.78	-8.55	1.01	0.35	-0.53
15-Aug-08	20:00:00	-2.57	-0.83	-8.89	0.03	1.47	0.75
16-Aug-08	08:00:00	-3.02	0.15	-10.32	1.88	0.58	0.11
16-Aug-08	20:00:00	-2.04	0.21	-5.52	1.41	0.49	-0.17
17-Aug-08	08:00:00	-2.36	-0.65	-7.02	1.82	1.40	0.61
17-Aug-08	20:00:00	-2.42	0.46	-8.12	1.97	0.74	0.16
18-Aug-08	08:00:00	-0.82	0.25	-1.61	1.71	0.63	0.07
18-Aug-08	20:00:00	-1.45	0.18	-3.24	1.16	0.47	-0.27
19-Aug-08	08:00:00	-1.90	-1.28	-5.17	0.83	0.46	-0.33
19-Aug-08	20:00:00	-1.92	-1.02	-6.63	-0.20	0.09	-1.08
20-Aug-08	08:00:00	-2.12	-2.43	-8.51	-0.60	0.00	-1.15
20-Aug-08	20:00:00	-2.14	-1.83	-10.63	-2.33	-0.58	-2.55
21-Aug-08	08:00:00	-2.51	-4.12	-12.35	-3.26	-0.73	-2.57
21-Aug-08	20:00:00	-2.57	-3.26	-13.83	-7.02	-1.74	-5.17
22-Aug-08	08:00:00	-2.89	-5.34	-14.47	-8.28	-1.81	-5.11
22-Aug-08	20:00:00	-2.91	-4.65	-15.44	-11.00	-3.44	-8.78
23-Aug-08	08:00:00	-3.23	-6.59	-16.02	-11.82	-3.58	-9.24
23-Aug-08	20:00:00	-3.29	-5.99	-16.59	-14.14	-6.57	-13.17
24-Aug-08	08:00:00	-3.90	-9.28	-16.45	-15.08	-6.65	-14.04
24-Aug-08	20:00:00	-3.97	-8.29	-17.30	-16.46	-9.77	-16.99
25-Aug-08	08:00:00	-4.82	-11.90	-17.41	-17.11	-9.41	-17.32
25-Aug-08	20:00:00	-4.72	-10.50	-18.25	-8.44	0.93	-4.62
26-Aug-08	08:00:00	-2.57	-0.11	-18.28	-0.16	1.18	-0.45
26-Aug-08	20:00:00	-2.39	0.43	-15.10	2.30	1.03	0.25
27-Aug-08	08:00:00	-1.82	0.41	-10.04	2.41	1.03	0.46
27-Aug-08	20:00:00	-1.27	0.51	-1.88	1.74	0.66	0.11
28-Aug-08	08:00:00	-1.37	-0.12	-5.29	1.47	0.64	0.04
28-Aug-08	20:00:00	-1.57	-0.33	-6.68	0.91	0.37	-0.46
29-Aug-08	08:00:00	-2.10	-1.52	-8.29	0.60	0.41	-0.51
29-Aug-08	20:00:00	-2.35	-1.19	-10.24	-0.21	0.01	-1.27
30-Aug-08	08:00:00	-2.77	-2.36	-11.93	-0.64	-0.07	-1.36
30-Aug-08	20:00:00	-2.81	-1.88	-13.46	-2.00	-0.79	-2.50
31-Aug-08	08:00:00	-3.12	-3.43	-14.24	-2.43	-0.91	-2.46
31-Aug-08	20:00:00	-3.07	-2.71	-15.48	-5.71	-0.71	-3.28
1-Sep-08	08:00:00	-3.33	-2.69	-16.15	-4.48	-0.90	-2.90
1-Sep-08	20:00:00	-3.05	-2.09	-16.73	-9.66	-3.21	-7.39

Date	Time						
dd-mmm-yyyy	hh:mm:ss	Jon AW7	Jon AW8	Jon AW9	Jon AW10	Jon AW11	Jon AW12
2-Sep-08	08:00:00	-3.54	-5.16	-17.11	-11.11	-3.50	-7.91
2-Sep-08	20:00:00	-3.86	-4.98	-18.34	-14.09	-7.08	-12.47
3-Sep-08	08:00:00	-4.70	-8.46	-19.05	-15.27	-7.38	-13.48
3-Sep-08	20:00:00	-4.83	-7.78	-20.38	-16.75	-10.94	-16.64
4-Sep-08	08:00:00	-6.07	-11.60	-21.18	-17.82	-11.29	-17.34
4-Sep-08	20:00:00	-6.20	-10.79	-22.73	-18.73	-13.67	-19.06
5-Sep-08	08:00:00	-7.81	-15.38	-23.44	-19.45	-13.09	-19.42
5-Sep-08	20:00:00	-7.67	-14.09	-24.65	-19.70	-12.30	-19.64
6-Sep-08	08:00:00	-7.35	-13.31	-24.64	2.54	1.14	0.56
6-Sep-08	20:00:00	-1.13	0.43	-16.77	1.48	0.34	-0.17
7-Sep-08	08:00:00	-2.24	-0.59	-12.65	1.12	0.32	-0.35
7-Sep-08	20:00:00	-2.46	-0.73	-11.70	0.46	-0.01	-1.05
8-Sep-08	08:00:00	-2.77	-1.83	-12.03	0.06	-0.06	-1.16
8-Sep-08	20:00:00	-2.87	-1.28	-13.62	-0.68	-0.57	-2.03
9-Sep-08	08:00:00	-3.09	-2.29	-14.23	-1.13	-0.63	-1.93
9-Sep-08	20:00:00	-3.10	-1.77	-15.26	1.94	1.35	0.54
10-Sep-08	08:00:00	-1.62	0.60	-15.53	2.58	1.47	0.56
10-Sep-08	20:00:00	-1.49	0.69	-7.62	10.13	26.31	22.13
11-Sep-08	08:00:00	31.56	0.86	1.36	2.58	1.22	0.28
11-Sep-08	20:00:00	0.23	0.39	0.80	1.95	1.26	0.37
12-Sep-08	08:00:00	-0.46	0.27	0.21	1.76	0.72	0.01
12-Sep-08	20:00:00	-1.57	0.32	-0.60	1.47	1.23	0.32
13-Sep-08	08:00:00	-1.39	-0.39	-1.81	1.26	-0.08	-0.60
13-Sep-08	20:00:00	-1.37	-0.31	-3.08	0.62	1.25	-0.01
14-Sep-08	08:00:00	-1.41	-0.92	-4.19	0.37	-0.68	-1.33
14-Sep-08	20:00:00	-1.47	-0.72	-5.51	-0.27	0.81	-0.97
15-Sep-08	08:00:00	-1.75	-1.34	-6.71	-0.66	-0.61	-1.80
15-Sep-08	20:00:00	-1.84	-1.05	-8.05	-1.71	-0.01	-2.03
16-Sep-08	08:00:00	-2.08	-1.59	-9.30	-1.68	-0.30	-1.92
16-Sep-08	20:00:00	-2.05	-1.12	-10.41	-0.75	0.25	-1.25
17-Sep-08	08:00:00	-1.91	-0.50	-9.86	2.28	0.81	0.08
17-Sep-08	20:00:00	-1.17	0.46	-4.17	1.65	0.99	0.01
18-Sep-08	08:00:00	-1.23	-0.52	-4.75	1.21	-0.14	-0.81
18-Sep-08	20:00:00	-1.25	-0.61	-6.10	0.61	0.76	-0.31
19-Sep-08	08:00:00	-1.43	-1.18	-7.44	0.02	-0.60	-1.40
19-Sep-08	20:00:00	-1.57	-0.98	-9.38	-0.80	0.32	-1.06
20-Sep-08	08:00:00	-1.72	-1.46	-10.64	-1.50	-0.63	-1.77
20-Sep-08	20:00:00	-1.80	-1.23	-12.04	-2.39	-0.04	-1.91
21-Sep-08	08:00:00	-1.95	-1.78	-12.34	-3.10	-0.93	-2.68
21-Sep-08	20:00:00	-2.03	-1.64	-13.26	-4.57	-0.73	-2.46
22-Sep-08	08:00:00	-2.13	-1.86	-13.69	-5.13	-1.70	-3.08
22-Sep-08	20:00:00	-2.17	-1.53	-13.95	-7.86	-1.59	-4.56
23-Sep-08	08:00:00	-2.43	-2.61	-14.09	-9.22	-2.73	-5.66
23-Sep-08	20:00:00	-2.57	-2.56	-15.46	-10.67	-3.03	-7.39
24-Sep-08	08:00:00	-2.75	-3.47	-15.60	-11.67	-4.27	-8.75
24-Sep-08	20:00:00	-2.86	-3.23	-16.26	-13.59	-5.71	-11.34
25-Sep-08	08:00:00	-3.20	-5.44	-16.16	-14.02	-6.00	-12.60
25-Sep-08	20:00:00	-3.29	-5.28	-16.66	-14.39	-6.00	-13.46
26-Sep-08	08:00:00	-3.40	-5.37	-16.62	3.00	1.75	1.00

Date	Time						
dd-mmm-yyyy	hh:mm:ss	Jon AW7	Jon AW8	Jon AW9	Jon AW10	Jon AW11	Jon AW12
26-Sep-08	20:00:00	-0.48	0.88	-10.04	2.56	1.46	0.63
27-Sep-08	08:00:00	-0.28	0.76	-3.34	1.90	0.76	0.16
27-Sep-08	20:00:00	-0.35	0.62	-1.83	1.53	0.90	0.27
28-Sep-08	08:00:00	-0.95	0.48	-1.51	1.25	-0.25	-0.59
28-Sep-08	20:00:00	-1.16	0.50	-2.72	0.88	0.82	0.09
29-Sep-08	08:00:00	-1.29	0.00	-3.89	0.59	-0.27	-0.96
29-Sep-08	20:00:00	-1.22	0.16	-5.30	0.23	0.68	-0.41
30-Sep-08	08:00:00	-1.23	-0.61	-6.27	0.64	0.40	-0.49
30-Sep-08	20:00:00	-1.13	0.14	-7.48	-0.13	0.61	-0.65
1-Oct-08	08:00:00	-1.16	-0.65	-7.21	-0.41	-0.16	-1.64
1-Oct-08	20:00:00	-1.12	-0.31	-8.30	-1.30	0.16	-1.47
2-Oct-08	08:00:00	-1.33	-1.14	-8.88	-2.12	-0.72	-2.71
2-Oct-08	20:00:00	-1.50	-1.11	-11.76	-3.73	-0.54	-2.92
3-Oct-08	08:00:00	-1.67	-1.61	-12.68	-5.82	-1.25	-4.10
3-Oct-08	20:00:00	-1.77	-1.44	-13.94	-8.05	-1.29	-5.45
4-Oct-08	08:00:00	-1.93	-2.18	-14.67	-9.41	-2.23	-7.03
4-Oct-08	20:00:00	-2.04	-1.98	-15.71	-10.91	-2.72	-8.90
5-Oct-08	08:00:00	-2.20	-2.97	-16.02	-11.84	-3.76	-10.07
5-Oct-08	20:00:00	-2.30	-2.72	-16.83	-12.84	-4.51	-11.71
6-Oct-08	08:00:00	-2.46	-4.03	-16.92	-13.65	-5.55	-13.35
6-Oct-08	20:00:00	-2.59	-3.76	-17.50	-14.70	-6.49	-14.61
7-Oct-08	08:00:00	-2.82	-5.31	-17.77	-15.59	-8.08	-16.41
7-Oct-08	20:00:00	-3.01	-4.90	-18.61	-16.01	-8.14	-16.86
8-Oct-08	08:00:00	-3.24	-6.19	-19.23	-16.45	-8.71	-17.94
8-Oct-08	20:00:00	-3.39	-5.34	-19.34	-14.60	-3.81	-15.46
9-Oct-08	08:00:00	-3.03	-1.81	-19.12	-9.81	-0.80	-13.01
9-Oct-08	20:00:00	-2.91	-0.29	-18.06	2.21	0.74	-1.28
10-Oct-08	08:00:00	-1.60	0.57	-10.72	1.63	0.05	-1.56
10-Oct-08	20:00:00	-1.80	0.53	-8.99	1.26	0.46	-1.34
11-Oct-08	08:00:00	-1.82	0.49	-8.79	1.12	0.68	-1.14
11-Oct-08	20:00:00	-1.70	0.61	-8.86	0.81	0.52	-1.35
12-Oct-08	08:00:00	-1.73	0.51	-9.56	0.49	0.06	-1.78
12-Oct-08	20:00:00	-1.77	0.47	-10.71	-0.04	0.45	-1.77
13-Oct-08	08:00:00	-1.91	-0.12	-12.07	-0.46	-0.44	-2.60
13-Oct-08	20:00:00	-1.97	-0.04	-13.42	-0.94	0.11	-2.32
14-Oct-08	08:00:00	-2.08	-0.71	-14.04	-1.50	-0.71	-3.55
14-Oct-08	20:00:00	-2.16	-0.72	-14.63	-2.37	-0.40	-3.75
15-Oct-08	08:00:00	-2.33	-1.29	-15.21	-3.71	-1.16	-5.02
15-Oct-08	20:00:00	-2.40	-1.16	-16.26	-5.62	-0.82	-6.10
16-Oct-08	08:00:00	-2.58	-1.57	-17.15	-6.72	-1.63	-7.87
16-Oct-08	20:00:00	-2.67	-1.35	-18.06	-7.99	-1.41	-9.01
17-Oct-08	08:00:00	-2.81	-1.78	-18.71	-7.84	-1.73	-9.30
17-Oct-08	20:00:00	-2.81	-1.31	-19.50	0.09	1.16	-1.55
18-Oct-08	08:00:00	-2.19	0.63	-19.79	2.50	0.81	0.01
18-Oct-08	20:00:00	-1.34	0.80	-14.03	1.92	0.50	-0.19
19-Oct-08	08:00:00	-1.81	0.62	-7.50	1.55	0.40	-0.79
19-Oct-08	20:00:00	-2.04	0.48	-8.75	1.17	0.48	-0.53
20-Oct-08	08:00:00	-2.26	-0.21	-10.05	0.80	0.28	-1.28
20-Oct-08	20:00:00	-2.41	-0.18	-11.99	0.50	0.35	-0.96

Date	Time						
dd-mmm-yyyy	hh:mm:ss	Jon AW7	Jon AW8	Jon AW9	Jon AW10	Jon AW11	Jon AW12
21-Oct-08	08:00:00	-2.47	-0.42	-12.96	0.08	-0.05	-1.79
21-Oct-08	20:00:00	-2.53	-0.32	-13.63	-0.35	-0.05	-1.47
22-Oct-08	08:00:00	-2.61	-0.64	-14.52	-1.05	-0.51	-2.29
22-Oct-08	20:00:00	-2.72	-0.62	-15.97	-1.81	-0.44	-2.11
23-Oct-08	08:00:00	-2.90	-1.07	-17.75	-2.94	-0.70	-2.79
23-Oct-08	20:00:00	-3.03	-0.97	-19.14	-4.49	-0.77	-2.73
24-Oct-08	08:00:00	-3.10	-1.15	-20.33	-5.01	-0.86	-2.74
24-Oct-08	20:00:00	-3.04	-0.82	-20.46	1.72	1.30	0.30
25-Oct-08	08:00:00	-1.77	0.85	-20.00	2.36	0.75	0.20
25-Oct-08	20:00:00	-1.70	0.80	-12.19	2.02	0.89	0.30
26-Oct-08	08:00:00	-1.83	0.70	-9.25	1.69	0.37	-0.71
26-Oct-08	20:00:00	-2.08	0.61	-9.60	1.47	0.65	-0.07
27-Oct-08	08:00:00	-2.26	0.21	-11.90	1.26	0.32	-0.87
27-Oct-08	20:00:00	-2.33	0.16	-13.29	0.84	0.42	-0.64
28-Oct-08	08:00:00	-2.45	-0.25	-14.05	0.51	0.18	-0.86
28-Oct-08	20:00:00	-2.50	-0.06	-16.26	0.03	0.14	-0.90
29-Oct-08	08:00:00	-2.61	-0.61	-17.29	-0.99	-0.08	-1.11
29-Oct-08	20:00:00	-2.66	-0.47	-19.31	-1.87	-0.13	-1.20
30-Oct-08	08:00:00	-2.74	-0.78	-20.22	-3.47	-0.46	-1.65
30-Oct-08	20:00:00	-2.81	-0.73	-21.26	-4.61	-0.51	-1.68
31-Oct-08	08:00:00	-2.90	-0.99	-23.69	-5.81	-0.70	-1.95
31-Oct-08	20:00:00	-2.94	-0.81	-24.21	-6.15	-0.66	-1.97
1-Nov-08	08:00:00	-2.97	-0.93	-24.96	-6.95	-0.82	-2.18
1-Nov-08	20:00:00	-2.99	-0.73	-24.49	-7.39	-0.78	-2.27
2-Nov-08	08:00:00	-3.03	-0.89	-25.01	-8.32	-1.00	-2.82
2-Nov-08	20:00:00	-3.06	-0.77	-25.33	-9.02	-1.00	-2.78
3-Nov-08	08:00:00	-3.15	-0.96	-26.36	-9.60	-1.18	-3.08
3-Nov-08	20:00:00	-3.12	-0.72	-27.02	-2.64	0.22	-1.09
4-Nov-08	08:00:00	-2.49	0.43	-27.69	0.28	0.79	-0.48
4-Nov-08	20:00:00	-1.86	1.04	-26.94	0.74	0.82	0.26
5-Nov-08	08:00:00	-1.43	0.97	-22.27	1.10	0.76	0.28
5-Nov-08	20:00:00	-0.75	0.99	-18.66	0.89	0.81	0.33
6-Nov-08	08:00:00	-0.27	0.52	-15.33	0.70	0.40	-0.58
6-Nov-08	20:00:00	-0.17	-0.38	-14.78	0.49	0.68	0.28
7-Nov-08	08:00:00	-0.14	-1.19	-15.58	0.10	0.36	-0.40
7-Nov-08	20:00:00	-0.13	-1.27	-16.57	-0.18	0.55	0.26
8-Nov-08	08:00:00	-0.15	-1.47	-18.05	-0.34	0.25	0.06
8-Nov-08	20:00:00	-0.10	-1.23	-18.30	-0.89	0.42	0.17
9-Nov-08	08:00:00	-0.12	-1.82	-18.87	-1.51	0.20	-0.37
9-Nov-08	20:00:00	-0.13	-1.81	-20.25	-2.06	0.10	-0.16
10-Nov-08	08:00:00	-0.17	-2.03	-22.08	-3.10	-0.18	-0.47
10-Nov-08	20:00:00	-0.22	-2.01	-23.40	-3.54	-0.25	-0.54
11-Nov-08	08:00:00	-0.25	-2.19	-25.10	-4.64	-0.52	-0.82
11-Nov-08	20:00:00	-0.33	-2.08	-25.35			
12-Nov-08	08:00:00						
12-Nov-08	20:00:00						
13-Nov-08	08:00:00						
13-Nov-08	20:00:00						
14-Nov-08	08:00:00						



Date	Time					
dd-mmm-yyyy	hh:mm:ss	Jon AW13	Jon AW14	Jon RAW1	Jon RAW2	Jon RAW3
01-Jan-2008	08:00:00	-1.72	-37.47	-18.99	-4.37	-28.10
01-Jan-2008	20:00:00	-2.31	-39.86	-21.36	-5.19	-30.96
02-Jan-2008	08:00:00	-3.21	-39.86	-23.72	-6.03	-33.12
02-Jan-2008	20:00:00	-4.26	-39.89	-26.01	-6.87	-34.79
03-Jan-2008	08:00:00	-5.60	-39.85	-27.87	-7.81	-36.48
03-Jan-2008	20:00:00	-6.32	-39.84	-29.55	-8.66	-38.02
04-Jan-2008	08:00:00	-7.81	-39.85	-31.19	-9.53	-39.40
04-Jan-2008	20:00:00	-7.78	-39.83	-32.55	-10.37	-40.88
05-Jan-2008	08:00:00	-8.84	-39.84	-33.62	-11.32	-42.54
05-Jan-2008	20:00:00	-9.15	-39.83	-34.75	-12.13	-43.95
06-Jan-2008	08:00:00	-9.86	-39.84	-36.01	-13.01	-45.14
06-Jan-2008	20:00:00	-10.44	-39.82	-37.23	-13.64	-46.09
07-Jan-2008	08:00:00	-11.46	-39.83	-38.29	-15.00	-47.05
07-Jan-2008	20:00:00	-12.03	-39.83	-39.31	-18.98	-47.99
08-Jan-2008	08:00:00	-12.74	-39.83	-40.94	-31.31	-48.73
08-Jan-2008	20:00:00	-12.89	-39.81	-42.47	-44.25	-48.78
09-Jan-2008	08:00:00	-13.20	-39.82	-43.83	-48.78	-48.79
09-Jan-2008	20:00:00	-13.59	-39.83	-45.05	-48.77	-48.81
10-Jan-2008	08:00:00	-14.28	-39.83	-46.26	-48.78	-48.80
10-Jan-2008	20:00:00	-9.92	-39.84	-47.20	-22.28	-48.79
11-Jan-2008	08:00:00	-8.89	-39.83	-48.00	-14.58	-48.81
11-Jan-2008	20:00:00	-3.49	-39.83	-48.09	-12.71	-48.80
12-Jan-2008	08:00:00	-4.68	-39.84	-47.00	-13.47	-48.80
12-Jan-2008	20:00:00	-5.44	-39.84	-46.56	-14.59	-48.83
13-Jan-2008	08:00:00	-6.40	-39.82	-46.64	-19.70	-48.82
13-Jan-2008	20:00:00	-6.93	-39.84	-46.91	-37.38	-48.83
14-Jan-2008	08:00:00	-7.81	-39.85	-47.53	-48.80	-48.81
14-Jan-2008	20:00:00	-8.64	-39.84	-48.24	-48.81	-48.82
15-Jan-2008	08:00:00	-10.06	-39.85	-49.15	-48.80	-48.80
15-Jan-2008	20:00:00	-11.30	-39.84	-50.22	-48.80	-48.82
16-Jan-2008	08:00:00	-12.92	-39.85	-50.32	-48.80	-48.82
16-Jan-2008	20:00:00	-13.59	-39.85	-50.32	-48.84	-48.85
17-Jan-2008	08:00:00	-3.66	-39.83	-50.21	-48.80	-48.83
17-Jan-2008	20:00:00	0.73	-8.19	-3.77	-1.94	-4.76
18-Jan-2008	08:00:00	0.03	-10.28	-6.39	-1.84	0.23
18-Jan-2008	20:00:00	-0.39	-14.79	-8.92	-1.50	-0.19
19-Jan-2008	08:00:00	-0.16	-17.36	-10.23	-1.33	-0.31
19-Jan-2008	20:00:00	1.30	-3.27	-2.00	-0.48	0.03
20-Jan-2008	08:00:00	0.59	-4.39	-2.93	-0.16	0.53
20-Jan-2008	20:00:00	-0.07	-5.46	-4.33	-0.29	0.00
21-Jan-2008	08:00:00	-0.95	-8.56	-5.88	-0.76	-0.41
21-Jan-2008	20:00:00	-0.76	-7.84	-6.69	-1.00	-0.59
22-Jan-2008	08:00:00	-1.00	-8.86	-7.34	-1.21	-0.75
22-Jan-2008	20:00:00	-0.58	-7.69	-7.21	-1.16	-0.65
23-Jan-2008	08:00:00	-0.54	-6.65	-4.31	-0.85	-0.47
23-Jan-2008	20:00:00	-0.70	-7.40	-4.62	-1.01	-0.28
24-Jan-2008	08:00:00	-0.84	-7.90	-5.02	-1.08	-0.34
24-Jan-2008	20:00:00	-1.13	-9.04	-5.79	-1.25	-0.56
25-Jan-2008	08:00:00	-1.67	-11.27	-7.24	-1.53	-0.77

Date	Time					
dd-mmm-yyyy	hh:mm:ss	Jon AW13	Jon AW14	Jon RAW1	Jon RAW2	Jon RAW3
25-Jan-2008	20:00:00	-1.72	-11.47	-7.93	-1.67	-0.92
26-Jan-2008	08:00:00	-1.86	-11.39	-8.49	-1.82	-1.07
26-Jan-2008	20:00:00	-1.92	-10.47	-8.61	-1.90	-1.16
27-Jan-2008	08:00:00	-2.34	-11.50	-9.36	-2.05	-1.28
27-Jan-2008	20:00:00	-2.45	-11.47	-9.80	-2.17	-1.35
28-Jan-2008	08:00:00	-3.12	-12.83	-10.80	-2.32	-1.45
28-Jan-2008	20:00:00	-2.98	-12.25	-11.06	-2.41	-1.51
29-Jan-2008	08:00:00	-3.21	-12.16	-11.33	-2.47	-1.54
29-Jan-2008	20:00:00	-3.26	-11.20	-11.26	-2.54	-1.58
30-Jan-2008	08:00:00	-1.76	-7.02	-10.53	-2.15	-1.27
30-Jan-2008	20:00:00	-2.45	-8.70	-11.73	-2.45	-1.46
31-Jan-2008	08:00:00	-3.54	-11.30	-12.77	-2.65	-1.62
31-Jan-2008	20:00:00	-3.54	-11.31	-12.95	-2.76	-1.70
01-Feb-2008	08:00:00	-1.11	-4.75	-4.94	-1.31	-0.69
01-Feb-2008	20:00:00	-0.20	-3.87	-2.46	-0.61	0.13
02-Feb-2008	08:00:00	-0.40	-4.33	-3.30	-0.46	-0.04
02-Feb-2008	20:00:00	-0.50	-4.55	-3.56	-0.57	-0.36
03-Feb-2008	08:00:00	-0.73	-4.88	-4.10	-0.80	-0.56
03-Feb-2008	20:00:00	-0.87	-5.01	-4.29	-1.00	-0.76
04-Feb-2008	08:00:00	-1.07	-5.25	-4.69	-1.17	-0.89
04-Feb-2008	20:00:00	-1.16	-5.29	-4.93	-1.31	-0.99
05-Feb-2008	08:00:00	-1.30	-5.45	-5.26	-1.44	-1.08
05-Feb-2008	20:00:00	-1.36	-5.45	-5.24	-1.51	-1.12
06-Feb-2008	08:00:00	-1.43	-5.48	-5.42	-1.60	-1.15
06-Feb-2008	20:00:00	-1.13	-4.52	-5.30	-1.61	-1.09
07-Feb-2008	08:00:00	-1.48	-5.48	-5.96	-1.74	-1.19
07-Feb-2008	20:00:00	-1.69	-5.77	-6.39	-1.85	-1.28
08-Feb-2008	08:00:00	-2.07	-6.47	-7.20	-1.97	-1.39
08-Feb-2008	20:00:00	-2.31	-6.98	-7.78	-2.08	-1.50
09-Feb-2008	08:00:00	-2.70	-7.72	-8.49	-2.19	-1.62
09-Feb-2008	20:00:00	-2.92	-7.88	-8.83	-2.29	-1.74
10-Feb-2008	08:00:00	-3.71	-9.21	-9.84	-2.44	-1.89
10-Feb-2008	20:00:00	-4.10	-9.55	-10.27	-2.57	-2.02
11-Feb-2008	08:00:00	-5.09	-11.04	-11.51	-2.76	-2.20
11-Feb-2008	20:00:00	-5.53	-11.23	-11.90	-2.91	-2.35
12-Feb-2008	08:00:00	-6.15	-11.66	-12.50	-3.04	-2.48
12-Feb-2008	20:00:00	-2.32	-5.89	-10.25	-2.30	-1.80
13-Feb-2008	08:00:00	-1.06	-4.11	-5.19	-1.50	-1.08
13-Feb-2008	20:00:00	-1.02	-4.21	-4.80	-1.36	-0.64
14-Feb-2008	08:00:00	-1.61	-5.04	-6.28	-1.59	-0.62
14-Feb-2008	20:00:00	-1.79	-5.24	-7.08	-1.68	-0.85
15-Feb-2008	08:00:00	-2.15	-5.75	-8.05	-1.81	-1.08
15-Feb-2008	20:00:00	-2.13	-5.76	-8.48	-1.89	-1.24
16-Feb-2008	08:00:00	-2.38	-6.15	-9.35	-2.01	-1.38
16-Feb-2008	20:00:00	-2.60	-6.51	-9.76	-2.18	-1.53
17-Feb-2008	08:00:00	-2.93	-6.92	-10.38	-2.29	-1.62
17-Feb-2008	20:00:00	-2.67	-6.01	-9.81	-2.29	-1.63
18-Feb-2008	08:00:00	0.78	-2.61	-1.43	-0.14	-0.17
18-Feb-2008	20:00:00	0.49	-4.02	-1.92	0.27	0.29

Date	Time					
dd-mmm-yyyy	hh:mm:ss	Jon AW13	Jon AW14	Jon RAW1	Jon RAW2	Jon RAW3
19-Feb-2008	08:00:00	-0.02	-4.52	-2.62	0.07	-0.21
19-Feb-2008	20:00:00	-0.30	-4.74	-2.37	-0.14	-0.32
20-Feb-08	08:00:00	-0.56	-5.15	-2.78	-0.43	-0.55
20-Feb-08	20:00:00	-0.70	-5.29	-2.84	-0.64	-0.74
21-Feb-08	08:00:00	-1.00	-5.91	-3.37	-0.87	-0.93
21-Feb-08	20:00:00	-1.08	-5.90	-3.14	-0.80	-0.80
22-Feb-08	08:00:00	1.60	-2.71	-0.16	0.73	0.86
22-Feb-08	20:00:00	0.94	-3.56	-0.24	0.99	0.66
23-Feb-08	08:00:00	0.69	-3.80	-0.35	0.78	0.25
23-Feb-08	20:00:00	0.48	-4.08	-0.51	0.58	0.01
24-Feb-08	08:00:00	0.18	-4.35	-0.83	0.34	-0.18
24-Feb-08	20:00:00	-0.05	-4.43	-0.96	0.12	-0.32
25-Feb-08	08:00:00	-0.23	-4.57	-1.18	-0.06	-0.44
25-Feb-08	20:00:00	-0.31	-4.62	-1.26	-0.21	-0.51
26-Feb-08	08:00:00	-0.36	-4.43	-1.35	-0.32	-0.54
26-Feb-08	20:00:00	1.08	-3.44	0.71	1.60	1.40
27-Feb-08	08:00:00	0.71	-3.96	0.44	1.23	0.49
27-Feb-08	20:00:00	0.41	-4.42	0.17	0.88	0.06
28-Feb-08	08:00:00	-0.11	-4.98	-0.18	0.59	-0.19
28-Feb-08	20:00:00	-0.26	-5.06	-0.43	0.37	-0.39
29-Feb-08	08:00:00	-0.49	-5.42	-0.72	0.13	-0.54
29-Feb-08	20:00:00	-0.52	-5.27	-0.78	-0.05	-0.66
1-Mar-08	08:00:00	-0.62	-5.30	-1.00	-0.20	-0.72
1-Mar-08	20:00:00	-0.82	-5.51	-1.16	-0.36	-0.79
2-Mar-08	08:00:00	-1.13	-6.07	-1.41	-0.50	-0.87
2-Mar-08	20:00:00	-1.29	-6.22	-1.55	-0.65	-0.94
3-Mar-08	08:00:00	-1.52	-6.61	-1.78	-0.81	-1.01
3-Mar-08	20:00:00	-1.51	-6.02	-1.81	-0.91	-1.05
4-Mar-08	08:00:00	-1.55	-5.71	-1.91	-0.97	-1.02
4-Mar-08	20:00:00	2.18	-2.20	-0.02	0.35	0.12
5-Mar-08	08:00:00	1.26	-3.40	1.75	2.31	1.56
5-Mar-08	20:00:00	0.81	-3.94	0.98	1.38	0.30
6-Mar-08	08:00:00	0.59	-4.26	0.60	1.04	4.78
6-Mar-08	20:00:00	0.42	-4.46	0.42	0.87	-0.10
7-Mar-08	08:00:00	0.27	-4.38	0.22	0.66	-0.31
7-Mar-08	20:00:00	1.75	-2.38	1.28	1.83	1.76
8-Mar-08	08:00:00	1.17	-3.37	1.07	1.54	0.69
8-Mar-08	20:00:00	0.73	-4.23	0.58	1.12	0.17
9-Mar-08	08:00:00	0.46	-4.63	0.23	0.83	-0.17
9-Mar-08	20:00:00	0.26	-4.82	-0.02	0.56	-0.38
10-Mar-08	08:00:00	-0.03	-5.09	-0.30	0.36	-0.49
10-Mar-08	20:00:00	-0.16	-5.03	-0.41	0.21	-0.59
11-Mar-08	08:00:00	-0.30	-5.14	-0.65	0.10	-0.61
11-Mar-08	20:00:00	-0.35	-4.94	-0.70	-0.02	-0.62
12-Mar-08	08:00:00	-0.45	-5.18	-0.91	-0.15	-0.63
12-Mar-08	20:00:00	-0.62	-5.42	-1.07	-0.29	-0.70
13-Mar-08	08:00:00	-0.85	-5.84	-1.34	-0.43	-0.77
13-Mar-08	20:00:00	-1.00	-5.87	-1.36	-0.63	-0.85
14-Mar-08	08:00:00	-1.14	-5.99	-1.58	-0.73	-0.87

Date	Time					
dd-mmm-yyyy	hh:mm:ss	Jon AW13	Jon AW14	Jon RAW1	Jon RAW2	Jon RAW3
14-Mar-08	20:00:00	-1.26	-6.03	-1.58	-0.79	-0.89
15-Mar-08	08:00:00	-1.49	-6.45	-1.88	-0.88	-0.93
15-Mar-08	20:00:00	2.29	-1.70	0.58	1.17	0.53
16-Mar-08	08:00:00	1.11	-3.75	0.64	1.55	0.73
16-Mar-08	20:00:00	0.75	-4.19	0.34	1.08	0.02
17-Mar-08	08:00:00	0.53	-4.57	-0.02	0.78	-0.26
17-Mar-08	20:00:00	0.34	-4.72	-0.25	0.54	-0.44
18-Mar-08	08:00:00	0.16	-4.69	-0.50	0.37	-0.53
18-Mar-08	20:00:00	0.05	-4.49	-0.55	0.23	-0.58
19-Mar-08	08:00:00	-0.04	-4.45	-0.73	0.13	-0.53
19-Mar-08	20:00:00	1.59	-1.76	0.41	0.97	0.19
20-Mar-08	08:00:00	1.08	-3.83	0.31	1.18	0.47
20-Mar-08	20:00:00	0.70	-4.29	-0.02	0.88	-0.06
21-Mar-08	08:00:00	0.52	-4.58	-0.31	0.64	-0.30
21-Mar-08	20:00:00	0.33	-4.66	-0.41	0.36	-0.46
22-Mar-08	08:00:00	0.16	-4.67	-0.66	0.24	-0.54
22-Mar-08	20:00:00	-0.08	-4.97	-0.78	0.09	-0.61
23-Mar-08	08:00:00	-0.32	-5.53	-1.12	-0.11	-0.72
23-Mar-08	20:00:00	-0.56	-5.86	-1.26	-0.27	-0.84
24-Mar-08	08:00:00	-0.75	-6.42	-1.51	-0.43	-0.93
24-Mar-08	20:00:00	-1.00	-6.98	-1.67	-0.57	-1.04
25-Mar-08	08:00:00	-1.31	-7.90	-1.91	-0.73	-1.10
25-Mar-08	20:00:00	-1.55	-8.23	-1.99	-0.84	-1.17
26-Mar-08	08:00:00	-1.80	-8.48	-2.25	-0.95	-1.19
26-Mar-08	20:00:00	-2.05	-8.73	-2.29	-1.04	-1.22
27-Mar-08	08:00:00	-2.34	-8.85	-2.54	-1.13	-1.21
27-Mar-08	20:00:00	-2.63	-8.94	-2.53	-1.19	-1.24
28-Mar-08	08:00:00	-2.93	-9.02	-2.83	-1.32	-1.22
28-Mar-08	20:00:00	-3.41	-9.11	-2.91	-1.39	-1.25
29-Mar-08	08:00:00	-4.05	-9.19	-3.29	-1.49	-1.32
29-Mar-08	20:00:00	-4.76	-9.28	-3.53	-1.63	-1.45
30-Mar-08	08:00:00	-5.38	-9.36	-3.77	-1.73	-1.54
30-Mar-08	20:00:00	-5.83	-9.45	-4.00	-1.81	-1.56
31-Mar-08	08:00:00	-0.21	-9.53	-2.92	-1.28	-1.04
31-Mar-08	20:00:00	-0.29	-9.62	-1.73	-0.48	-0.39
1-Apr-08	08:00:00	-0.18	-9.70	-1.56	-0.19	-0.12
1-Apr-08	20:00:00	-0.16	-9.79	-1.51	-0.02	-0.13
2-Apr-08	08:00:00	-0.28	-9.87	-1.91	-0.09	-0.33
2-Apr-08	20:00:00	-0.53	-9.96	-2.14	-0.32	-0.57
3-Apr-08	08:00:00	1.56	-10.04	-2.36	-0.42	-0.66
3-Apr-08	20:00:00	1.69	-10.13	-1.15	0.20	-0.12
4-Apr-08	08:00:00	1.13	-10.21	-1.23	0.28	0.02
4-Apr-08	20:00:00	0.98	-10.30	-1.21	0.31	-0.09
5-Apr-08	08:00:00	1.53	-10.38	1.27	2.43	1.46
5-Apr-08	20:00:00	1.61	-10.47	1.59	3.51	7.26
6-Apr-08	08:00:00	1.17	-10.55	11.03	12.31	12.43
6-Apr-08	20:00:00	0.94	-10.64	11.13	12.32	14.26
7-Apr-08	08:00:00	0.82	-10.72	9.41	10.62	13.64
7-Apr-08	20:00:00	0.68	-10.81	9.56	10.85	14.41



Date	Time					
dd-mmm-yyyy	hh:mm:ss	Jon AW13	Jon AW14	Jon RAW1	Jon RAW2	Jon RAW3
8-Apr-08	08:00:00	0.58	-10.89	9.81	11.06	14.35
8-Apr-08	20:00:00	0.38	-10.98	6.95	8.08	13.81
9-Apr-08	08:00:00	0.14	-11.06	1.11	2.02	0.92
9-Apr-08	20:00:00	-0.13	-11.15	0.52	1.44	2.32
10-Apr-08	08:00:00	-0.30	-11.24	0.15	1.01	-1.07
10-Apr-08	20:00:00	-0.58	-11.32	-0.05	0.91	2.25
11-Apr-08	08:00:00	-0.74	-11.41	-0.35	0.64	-2.12
11-Apr-08	20:00:00	-0.96	-11.49	-0.49	0.52	2.02
12-Apr-08	08:00:00	-0.98	-11.58	-0.66	0.37	-1.32
12-Apr-08	20:00:00	-0.65	-11.66	-0.63	0.42	2.18
13-Apr-08	08:00:00	-0.95	-11.75	-0.94	0.20	0.39
13-Apr-08	20:00:00	-1.53	-11.83	-1.18	0.07	2.45
14-Apr-08	08:00:00	-1.68	-11.92	-1.33	-0.10	-1.65
14-Apr-08	20:00:00	-1.62	-12.00	-1.53	-0.21	1.39
15-Apr-08	08:00:00	-2.09	-12.09	-1.76	-0.42	-1.45
15-Apr-08	20:00:00	-2.86	-12.17	-1.96	-0.51	-0.83
16-Apr-08	08:00:00	-3.52	-12.26	-2.26	-0.77	-2.42
16-Apr-08	20:00:00	-4.73	-12.34	-2.43	-0.83	1.22
17-Apr-08	08:00:00	-5.64	-12.43	-2.72	-1.09	-2.67
17-Apr-08	20:00:00	-7.26	-12.51	-2.91	-1.14	0.64
18-Apr-08	08:00:00	-8.29	-12.60	-3.25	-1.41	-2.18
18-Apr-08	20:00:00	-10.55	-12.68	-3.60	-1.55	-1.54
19-Apr-08	08:00:00	-11.47	-12.77	-3.94	-1.75	-1.58
19-Apr-08	20:00:00	-12.53	-12.85	-3.05	-1.35	-1.11
20-Apr-08	08:00:00	-2.58	-12.94	-2.41	-0.81	-0.46
20-Apr-08	20:00:00	-4.07	-13.02	-2.87	-1.02	-0.62
21-Apr-08	08:00:00	-5.08	-13.11	-3.26	-1.20	-0.71
21-Apr-08	20:00:00	-6.39	-13.19	-3.74	-1.42	-0.91
22-Apr-08	08:00:00	-7.23	-13.28	-4.06	-1.63	-0.95
22-Apr-08	20:00:00	-8.30	-13.36	-4.66	-1.83	-1.15
23-Apr-08	08:00:00	-9.07	-13.45	-4.95	-1.95	-1.24
23-Apr-08	20:00:00	-10.70	-13.53	-5.62	-2.15	-1.45
24-Apr-08	08:00:00	-11.83	-14.10	-6.07	-2.33	-1.57
24-Apr-08	20:00:00	-14.34	-16.23	-7.26	-2.61	-1.92
25-Apr-08	08:00:00	-15.33	-16.36	-7.92	-2.81	-2.05
25-Apr-08	20:00:00	-16.97	-17.96	-9.97	-3.20	-2.44
26-Apr-08	08:00:00	-17.68	-17.77	-10.91	-3.42	-2.57
26-Apr-08	20:00:00	-18.05	-18.42	-13.48	-3.95	-3.03
27-Apr-08	08:00:00	-15.72	-15.33	-13.36	-4.00	-3.07
27-Apr-08	20:00:00	1.92	-2.07	-4.71	-1.45	-0.77
28-Apr-08	08:00:00	2.15	-2.25	-1.73	-0.04	0.48
28-Apr-08	20:00:00	1.59	-1.37	-1.78	0.87	0.32
29-Apr-08	08:00:00	1.16	-3.53	-2.07	0.64	0.00
29-Apr-08	20:00:00	0.69	-4.27	-2.81	0.26	-0.34
30-Apr-08	08:00:00	0.46	-4.67	-3.09	-0.09	-0.56
30-Apr-08	20:00:00	-0.05	-5.48	-3.83	-0.40	-0.92
1-May-08	08:00:00	-0.38	-6.13	-4.16	-0.70	-1.02
1-May-08	20:00:00	-0.83	-8.26	-5.28	-1.05	-1.41
2-May-08	08:00:00	-1.04	-8.59	-5.77	-1.29	-1.51

Date	Time					
dd-mmm-yyyy	hh:mm:ss	Jon AW13	Jon AW14	Jon RAW1	Jon RAW2	Jon RAW3
2-May-08	20:00:00	-1.73	-11.97	-7.63	-1.77	-2.07
3-May-08	08:00:00	-1.93	-11.69	-8.40	-2.05	-2.18
3-May-08	20:00:00	-2.75	-14.35	-11.32	-2.49	-2.77
4-May-08	08:00:00	-3.12	-13.84	-12.13	-2.72	-2.87
4-May-08	20:00:00	-5.21	-17.52	-16.06	-3.32	-3.59
5-May-08	08:00:00	-6.03	-16.97	-15.70	-3.45	-3.68
5-May-08	20:00:00	-8.28	-19.40	-19.28	-4.24	-4.37
6-May-08	08:00:00	-10.32	-19.34	-20.08	-4.59	-4.52
6-May-08	20:00:00	-14.62	-21.08	-22.68	-5.61	-5.56
7-May-08	08:00:00	-16.20	-21.42	-23.75	-6.04	-5.68
7-May-08	20:00:00	-18.56	-22.06	-25.11	-7.19	-6.93
8-May-08	08:00:00	-19.21	-21.99	-26.01	-7.56	-6.92
8-May-08	20:00:00	-19.64	-21.06	-26.67	-7.09	-6.97
9-May-08	08:00:00	-19.55	-20.89	-27.18	-7.44	-6.86
9-May-08	20:00:00	-20.93	-22.30	-28.04	-9.04	-8.77
10-May-08	08:00:00	-21.73	-23.08	-28.67	-9.70	-8.75
10-May-08	20:00:00	-22.60	-23.96	-29.50	-12.46	-12.01
11-May-08	08:00:00	-23.14	-24.23	-30.09	-10.11	-9.78
11-May-08	20:00:00	-4.76	-6.64	-30.39	-8.04	-8.43
12-May-08	08:00:00	-6.61	-8.65	-31.01	-9.01	-9.21
12-May-08	20:00:00	-10.96	-15.19	-31.66	-11.52	-12.66
13-May-08	08:00:00	-14.26	-17.62	-32.22	-12.68	-13.02
13-May-08	20:00:00	-17.33	-19.88	-32.81	-15.62	-16.20
14-May-08	08:00:00	-18.84	-20.77	-33.31	-16.56	-16.61
14-May-08	20:00:00	-20.13	-21.51	-33.77	-18.68	-19.39
15-May-08	08:00:00	-20.94	-21.67	-34.16	-20.06	-20.15
15-May-08	20:00:00	-21.57	-21.95	-34.58	-21.63	-22.05
16-May-08	08:00:00	-19.45	-17.49	-34.89	-19.85	-21.16
16-May-08	20:00:00	-18.54	-18.56	-35.29	-19.01	-22.52
17-May-08	08:00:00	-20.03	-20.72	-35.72	-20.29	-24.21
17-May-08	20:00:00	-21.37	-22.37	-36.12	-22.21	-26.85
18-May-08	08:00:00	-22.28	-23.14	-36.53	-23.61	-28.38
18-May-08	20:00:00	-22.97	-23.93	-36.75	-25.34	-30.45
19-May-08	08:00:00	-23.61	-24.46	-37.20	-26.67	-31.58
19-May-08	20:00:00	-24.02	-25.07	-37.65	-28.31	-33.20
20-May-08	08:00:00	-24.31	-25.16	-37.98	-29.49	-34.17
20-May-08	20:00:00	-24.69	-25.90	-38.45	-30.90	-35.50
21-May-08	08:00:00	-25.05	-25.98	-38.74	-32.04	-36.38
21-May-08	20:00:00	-25.31	-26.19	-39.01	-33.44	-37.66
22-May-08	08:00:00	-25.74	-26.81	-39.44	-34.49	-38.54
22-May-08	20:00:00	-26.06	-27.63	-39.91	-35.96	-39.80
23-May-08	08:00:00	-26.47	-28.15	-40.30	-36.98	-40.63
23-May-08	20:00:00	-26.74	-28.80	-40.77	-38.30	-42.23
24-May-08	08:00:00	-27.04	-28.99	-41.09	-39.17	-43.13
24-May-08	20:00:00	-27.33	-29.39	-41.52	-40.26	-44.12
25-May-08	08:00:00	-27.69	-29.87	-41.95	-41.50	-44.84
25-May-08	20:00:00	-27.96	-30.45	-42.68	-43.01	-45.94
26-May-08	08:00:00	-28.26	-30.61	-43.22	-43.91	-46.58
26-May-08	20:00:00	-28.44	-31.07	-43.96	-45.25	-47.60

Date	Time					
dd-mmm-yyyy	hh:mm:ss	Jon AW13	Jon AW14	Jon RAW1	Jon RAW2	Jon RAW3
27-May-08	08:00:00	-28.72	-31.10	-44.41	-46.02	-48.23
27-May-08	20:00:00	-28.84	-31.69	-45.09	-47.17	-49.09
28-May-08	08:00:00	-29.19	-31.87	-45.56	-47.85	-49.41
28-May-08	20:00:00	-29.59	-32.35	-38.29	-6.70	-30.60
29-May-08	08:00:00	-29.89	-32.45	-38.77	-8.88	-31.79
29-May-08	20:00:00	-30.05	-32.72	-39.47	-12.62	-32.71
30-May-08	08:00:00	-30.32	-32.55	-39.88	-14.27	-33.94
30-May-08	20:00:00	-30.52	-33.01	-40.44	-17.49	-35.49
31-May-08	08:00:00	-30.72	-32.77	-40.86	-19.22	-36.49
31-May-08	20:00:00	-30.87	-33.37	-41.38	-21.35	-37.85
1-Jun-08	08:00:00	-31.16	-33.43	-41.85	-22.87	-38.78
1-Jun-08	20:00:00	-31.39	-34.02	-42.66	-24.68	-40.08
2-Jun-08	08:00:00	-31.70	-34.14	-43.22	-25.99	-41.00
2-Jun-08	20:00:00	-31.98	-34.96	-44.17	-27.80	-42.89
3-Jun-08	08:00:00	-32.31	-34.99	-44.72	-29.09	-43.87
3-Jun-08	20:00:00	-32.54	-35.70	-45.48	-30.74	-45.24
4-Jun-08	08:00:00	-32.81	-35.60	-46.02	-31.89	-46.07
4-Jun-08	20:00:00	-33.13	-36.36	-46.85	-33.60	-47.35
5-Jun-08	08:00:00	-33.56	-36.80	-47.37	-34.71	-48.17
5-Jun-08	20:00:00	-34.03	-37.78	-48.31	-36.45	-49.29
6-Jun-08	08:00:00	-34.52	-38.06	-48.83	-37.53	-49.96
6-Jun-08	20:00:00	-35.00	-39.10	-49.80	-39.16	-50.29
7-Jun-08	08:00:00	-35.39	-39.07	-50.41	-40.18	-50.29
7-Jun-08	20:00:00	-35.84	-39.95	-51.57	-42.74	-50.33
8-Jun-08	08:00:00	-36.22	-39.98	-52.11	-43.61	-50.25
8-Jun-08	20:00:00	-36.70	-39.95	-52.02	-45.54	-50.34
9-Jun-08	08:00:00	-37.08	-39.95	-52.11	-46.39	-50.27
9-Jun-08	20:00:00	-37.46	-39.93	-52.07	-47.99	-50.34
10-Jun-08	08:00:00	-37.83	-39.94	-52.08	-48.67	-50.23
10-Jun-08	20:00:00	-38.36	-39.94	-52.02	-48.82	-50.33
11-Jun-08	08:00:00	-38.88	-39.95	-52.08	-48.81	-50.24
11-Jun-08	20:00:00	-39.42	-39.94	-52.04	-48.82	-50.33
12-Jun-08	08:00:00	-39.81	-39.94	-52.07	-27.32	-40.66
12-Jun-08	20:00:00	-40.11	-39.93	-51.98	-29.25	-42.78
13-Jun-08	08:00:00	-40.49	-39.94	-52.05	-30.72	-43.89
13-Jun-08	20:00:00	-40.75	-39.93	-51.97	-32.54	-45.48
14-Jun-08	08:00:00	-40.99	-39.91	-52.05	-33.78	-46.36
14-Jun-08	20:00:00	-41.28	-39.92	-51.95	-35.55	-47.81
15-Jun-08	08:00:00	-41.55	-39.92	-52.05	-34.75	-48.56
15-Jun-08	20:00:00	-41.84	-39.88	-52.03	-36.23	-49.29
16-Jun-08	08:00:00	-42.06	-39.88	-52.10	-37.23	-49.32
16-Jun-08	20:00:00	-42.52	-39.88	-52.03	-38.77	-49.33
17-Jun-08	08:00:00	-42.84	-39.88	-52.10	-39.68	-49.34
17-Jun-08	20:00:00	-43.33	-39.88	-52.03	-41.95	-49.34
18-Jun-08	08:00:00	-43.79	-39.89	-52.12	-43.16	-49.30
18-Jun-08	20:00:00	-44.28	-39.88	-51.97	-45.04	-49.33
19-Jun-08	08:00:00	-44.73	-39.88	-52.06	-45.99	-49.32
19-Jun-08	20:00:00	-45.09	-39.88	-51.93	-47.80	-49.34
20-Jun-08	08:00:00	-45.37	-39.89	-52.00	-48.66	-49.33

Date	Time					
dd-mmm-yyyy	hh:mm:ss	Jon AW13	Jon AW14	Jon RAW1	Jon RAW2	Jon RAW3
20-Jun-08	20:00:00	-45.67	-39.87	-51.97	-48.85	-49.34
21-Jun-08	08:00:00	-45.31	-39.87	-52.00	-48.85	-49.34
21-Jun-08	20:00:00	-45.32	-39.89	-51.98	-43.22	-49.35
22-Jun-08	08:00:00	-45.32	-39.88	-52.01	-44.76	-49.35
22-Jun-08	20:00:00	-5.03	-29.76	-51.98	-45.80	-49.34
23-Jun-08	08:00:00	-17.75	-27.68	-52.04	-46.50	-49.36
23-Jun-08	20:00:00	-12.95	-23.76	-52.01	-47.60	-49.26
24-Jun-08	08:00:00	-19.97	-32.06	-52.06	-48.41	-49.27
24-Jun-08	20:00:00	-24.30	-38.76	-52.00	-48.78	-49.27
25-Jun-08	08:00:00	-26.73	-39.90	-52.09	-48.79	-49.27
25-Jun-08	20:00:00	-28.49	-39.88	-52.04	-48.78	-49.27
26-Jun-08	08:00:00	-29.92	-39.90	-52.10	-48.77	-49.28
26-Jun-08	20:00:00	-31.38	-39.88	-52.02	-48.77	-49.28
27-Jun-08	08:00:00	-32.46	-39.89	-52.10	-48.76	-49.27
27-Jun-08	20:00:00	-34.70	-39.87	-52.06	-48.75	-49.28
28-Jun-08	08:00:00	-36.37	-39.88	-52.10	-48.73	-49.28
28-Jun-08	20:00:00	-37.88	-39.88	-52.04	-48.75	-49.28
29-Jun-08	08:00:00	-38.88	-39.88	-52.12	-48.74	-49.29
29-Jun-08	20:00:00	-39.97	-39.88	-52.07	-48.75	-49.26
30-Jun-08	08:00:00	-40.63	-39.89	-52.16	-48.74	-49.28
30-Jun-08	20:00:00	-41.57	-39.87	-52.05	-48.74	-49.27
1-Jul-08	08:00:00	-42.21	-39.88	-52.16	-48.77	-49.26
1-Jul-08	20:00:00	-43.01	-39.87	-52.10	-48.76	-49.27
2-Jul-08	08:00:00	-43.67	-39.89	-52.19	-48.76	-49.25
2-Jul-08	20:00:00	-44.24	-39.88	-52.01	-48.76	-49.26
3-Jul-08	08:00:00	-44.70	-39.89	-52.07	-48.80	-49.26
3-Jul-08	20:00:00	-45.02	-39.88	-52.02	-48.79	-49.27
4-Jul-08	08:00:00	-45.27	-39.89	-52.13	-48.77	-49.28
4-Jul-08	20:00:00	-45.60	-39.88	-52.07	-48.76	-49.27
5-Jul-08	08:00:00	-45.42	-39.89	-52.16	-48.77	-49.27
5-Jul-08	20:00:00	-45.40	-39.87	-44.80	-39.80	-37.23
6-Jul-08	08:00:00	-45.40	-39.88	-48.16	-48.73	-40.57
6-Jul-08	20:00:00	0.76	-6.52	-51.55	-46.13	-43.71
7-Jul-08	08:00:00	-1.00	-10.52	-52.17	-47.54	-44.87
7-Jul-08	20:00:00	-3.23	-25.57	-52.16	-48.73	-46.52
8-Jul-08	08:00:00	-6.07	-30.94	-52.16	-48.77	-47.58
8-Jul-08	20:00:00	-0.81	-31.92	-1.97	3.89	5.14
9-Jul-08	08:00:00	-2.72	-17.46	-1.50	0.57	-0.35
9-Jul-08	20:00:00	-0.36	-6.60	-1.47	0.31	-0.57
10-Jul-08	08:00:00	-1.25	-8.27	-2.45	-0.34	-1.35
10-Jul-08	20:00:00	1.42	-3.55	-0.38	1.11	1.18
11-Jul-08	08:00:00	0.43	-4.71	-0.93	0.78	-0.22
11-Jul-08	20:00:00	-0.30	-7.76	-0.51	0.97	0.07
12-Jul-08	08:00:00	-0.78	-10.08	-1.09	0.45	-0.57
12-Jul-08	20:00:00	-2.05	-16.45	-1.98	-0.14	-1.41
13-Jul-08	08:00:00	-2.60	-17.08	-2.41	-0.47	-1.70
13-Jul-08	20:00:00	-5.84	-20.17	-2.37	-0.56	-1.59
14-Jul-08	08:00:00	-6.88	-20.74	-2.97	-0.92	-2.07
14-Jul-08	20:00:00	-2.79	-13.40	-3.68	-1.47	-2.79



Date	Time					
dd-mmm-yyyy	hh:mm:ss	Jon AW13	Jon AW14	Jon RAW1	Jon RAW2	Jon RAW3
15-Jul-08	08:00:00	-3.86	-14.75	-4.23	-1.78	-3.08
15-Jul-08	20:00:00	-7.86	-20.20	-6.55	-2.67	-4.30
16-Jul-08	08:00:00	-10.78	-21.24	-7.77	-3.05	-4.67
16-Jul-08	20:00:00	-14.82	-23.72	-14.71	-4.21	-6.61
17-Jul-08	08:00:00	-16.88	-24.04	-16.55	-4.79	-7.03
17-Jul-08	20:00:00	-18.95	-25.78	-22.05	-6.53	-10.69
18-Jul-08	08:00:00	-20.12	-25.95	-25.62	-7.27	-11.04
18-Jul-08	20:00:00	-21.32	-26.96	-28.74	-9.30	-15.25
19-Jul-08	08:00:00	-22.17	-27.23	-31.26	-10.46	-15.05
19-Jul-08	20:00:00	-22.95	-27.69	-33.41	-12.75	-18.92
20-Jul-08	08:00:00	-23.57	-27.69	-35.27	-13.59	-18.91
20-Jul-08	20:00:00	-24.39	-28.66	-37.20	-17.14	-23.83
21-Jul-08	08:00:00	-24.95	-28.64	-38.89	-18.29	-26.61
21-Jul-08	20:00:00	-25.87	-30.32	-40.93	-20.37	-29.60
22-Jul-08	08:00:00	-26.55	-30.44	-43.13	-21.56	-31.10
22-Jul-08	20:00:00	-27.35	-31.70	-45.90	-23.18	-32.52
23-Jul-08	08:00:00	-27.93	-31.68	-47.98	-24.27	-33.31
23-Jul-08	20:00:00	-28.39	-32.06	-48.67	-25.00	-34.24
24-Jul-08	08:00:00	0.08	-5.94	-8.61	-2.97	-0.33
24-Jul-08	20:00:00	-1.29	-14.12	-21.18	-4.26	-1.81
25-Jul-08	08:00:00	-2.02	-17.23	-25.39	-4.72	-2.44
25-Jul-08	20:00:00	-3.39	-19.08	-28.48	-5.58	-3.24
26-Jul-08	08:00:00	-4.49	-19.28	-30.82	-6.00	-3.65
26-Jul-08	20:00:00	-5.74	-19.16	-32.73	-6.90	-4.33
27-Jul-08	08:00:00	-6.71	-19.29	-34.02	-7.46	-4.68
27-Jul-08	20:00:00	-9.16	-20.97	-35.37	-10.13	-6.16
28-Jul-08	08:00:00	-12.05	-21.70	-36.66	-11.45	-6.56
28-Jul-08	20:00:00	-15.31	-23.62	-38.20	-15.59	-9.58
29-Jul-08	08:00:00	-17.08	-24.13	-39.59	-16.47	-10.00
29-Jul-08	20:00:00	-18.45	-24.79	-40.91	-18.48	-13.14
30-Jul-08	08:00:00	-19.37	-25.16	-42.38	-19.53	-13.32
30-Jul-08	20:00:00	-20.26	-26.06	-44.25	-21.15	-17.65
31-Jul-08	08:00:00	-20.93	-26.40	-45.61	-22.26	-17.68
31-Jul-08	20:00:00	0.11	-5.09	-47.05	-23.60	-23.01
1-Aug-08	08:00:00	-0.60	-6.46	-48.15	-24.62	-24.08
1-Aug-08	20:00:00	-1.97	-13.90	-49.60	-25.97	-27.35
2-Aug-08	08:00:00	-2.62	-16.03	-50.89	-26.96	-28.94
2-Aug-08	20:00:00	-3.73	-19.01	-2.58	2.76	3.16
3-Aug-08	08:00:00	-5.20	-17.04	-1.75	0.78	-0.38
3-Aug-08	20:00:00	-8.30	-20.49	-3.14	0.20	-1.45
4-Aug-08	08:00:00	-11.26	-21.47	-3.57	-0.36	-1.86
4-Aug-08	20:00:00	-14.58	-23.10	-5.98	-1.46	-3.00
5-Aug-08	08:00:00	-16.45	-23.49	-7.17	-1.87	-3.30
5-Aug-08	20:00:00	-18.34	-24.87	-15.04	-2.77	-4.53
6-Aug-08	08:00:00	-19.43	-25.17	-17.01	-3.16	-4.83
6-Aug-08	20:00:00	-20.59	-26.47	-22.90	-4.50	-7.10
7-Aug-08	08:00:00	-21.32	-26.70	-24.76	-5.10	-7.42
7-Aug-08	20:00:00	-21.88	-26.98	-26.47	-6.78	-10.24
8-Aug-08	08:00:00	-20.13	-25.36	-24.68	-3.71	-5.84

Date	Time					
dd-mmm-yyyy	hh:mm:ss	Jon AW13	Jon AW14	Jon RAW1	Jon RAW2	Jon RAW3
8-Aug-08	20:00:00	-19.85	-25.71	-26.16	-5.79	-9.53
9-Aug-08	08:00:00	-20.62	-26.28	-27.56	-6.76	-10.09
9-Aug-08	20:00:00	-21.82	-27.64	-28.88	-9.94	-14.76
10-Aug-08	08:00:00	-22.57	-27.95	-29.95	-11.30	-14.82
10-Aug-08	20:00:00	-23.10	-28.13	-30.93	-7.61	-10.48
11-Aug-08	08:00:00	-23.35	-27.72	-31.75	-8.65	-11.54
11-Aug-08	20:00:00	-23.90	-28.57	-32.64	-12.95	-17.98
12-Aug-08	08:00:00	-24.51	-29.03	-33.43	-14.12	-17.95
12-Aug-08	20:00:00	-25.05	-29.74	-33.99	-17.50	-22.16
13-Aug-08	08:00:00	-24.24	-29.55	-34.68	-5.30	-23.20
13-Aug-08	20:00:00	1.14	-3.58	-0.12	1.75	0.96
14-Aug-08	08:00:00	0.36	-4.53	-0.68	0.86	-0.22
14-Aug-08	20:00:00	-0.50	-6.40	-1.45	0.25	-0.77
15-Aug-08	08:00:00	-0.87	-7.75	-1.89	-0.06	-1.17
15-Aug-08	20:00:00	-2.05	-12.17	0.66	1.89	0.62
16-Aug-08	08:00:00	0.25	-4.65	-0.04	1.29	0.15
16-Aug-08	20:00:00	-0.33	-6.21	-0.64	0.63	-0.39
17-Aug-08	08:00:00	0.43	-6.87	-0.64	0.77	-0.24
17-Aug-08	20:00:00	0.69	-4.00	-0.62	0.85	0.04
18-Aug-08	08:00:00	0.52	-4.34	-0.92	0.57	-0.34
18-Aug-08	20:00:00	-0.12	-5.66	-1.60	0.07	-0.80
19-Aug-08	08:00:00	-0.45	-6.39	-2.00	-0.18	-1.09
19-Aug-08	20:00:00	-1.45	-10.67	-2.77	-0.79	-1.82
20-Aug-08	08:00:00	-1.72	-11.09	-3.06	-1.05	-1.91
20-Aug-08	20:00:00	-3.63	-14.59	-4.10	-1.74	-2.82
21-Aug-08	08:00:00	-4.34	-14.90	-4.68	-2.00	-3.02
21-Aug-08	20:00:00	-6.76	-16.90	-6.13	-2.66	-3.96
22-Aug-08	08:00:00	-7.91	-16.78	-6.88	-2.94	-4.22
22-Aug-08	20:00:00	-10.71	-18.38	-10.43	-3.87	-5.44
23-Aug-08	08:00:00	-12.54	-17.97	-11.67	-4.22	-5.67
23-Aug-08	20:00:00	-14.75	-19.39	-16.31	-5.47	-7.60
24-Aug-08	08:00:00	-16.47	-19.25	-18.30	-5.94	-7.77
24-Aug-08	20:00:00	-18.21	-20.47	-21.41	-7.44	-10.31
25-Aug-08	08:00:00	-19.19	-20.46	-23.66	-8.08	-10.44
25-Aug-08	20:00:00	-17.63	-18.17	-17.21	-2.92	-4.16
26-Aug-08	08:00:00	-4.91	-6.85	-6.15	-2.03	-3.32
26-Aug-08	20:00:00	-0.89	-3.89	-1.73	-0.29	0.05
27-Aug-08	08:00:00	-0.02	-3.08	-0.40	1.42	0.87
27-Aug-08	20:00:00	-0.66	-4.29	0.29	1.76	1.01
28-Aug-08	08:00:00	-0.96	-4.75	-0.19	1.08	3.65
28-Aug-08	20:00:00	-1.94	-6.72	-0.78	0.58	-0.42
29-Aug-08	08:00:00	-2.24	-7.77	-1.04	0.35	-0.62
29-Aug-08	20:00:00	-4.25	-11.25	-1.57	-0.13	-1.10
30-Aug-08	08:00:00	-4.81	-12.01	-1.91	-0.36	-1.19
30-Aug-08	20:00:00	-7.37	-14.73	-2.58	-0.89	-1.74
31-Aug-08	08:00:00	-8.95	-15.09	-2.86	-1.10	-1.82
31-Aug-08	20:00:00	-12.17	-17.44	-2.47	-1.03	-1.65
1-Sep-08	08:00:00	-11.04	-14.62	-2.55	-0.96	-1.43
1-Sep-08	20:00:00	-14.50	-18.55	-4.00	-1.89	-2.63

Date	Time					
dd-mmm-yyyy	hh:mm:ss	Jon AW13	Jon AW14	Jon RAW1	Jon RAW2	Jon RAW3
2-Sep-08	08:00:00	-16.21	-18.56	-4.49	-2.13	-2.83
2-Sep-08	20:00:00	-18.28	-20.65	-6.16	-2.80	-3.78
3-Sep-08	08:00:00	-19.44	-20.61	-6.85	-3.07	-4.01
3-Sep-08	20:00:00	-20.76	-22.10	-10.43	-3.90	-5.10
4-Sep-08	08:00:00	-21.66	-22.69	-11.66	-4.27	-5.36
4-Sep-08	20:00:00	-22.55	-23.58	-15.82	-5.49	-7.06
5-Sep-08	08:00:00	-23.11	-23.97	-17.53	-5.93	-7.23
5-Sep-08	20:00:00	-23.39	-23.62	-18.81	-5.27	-6.63
6-Sep-08	08:00:00	0.69	-3.13	-1.00	0.02	0.64
6-Sep-08	20:00:00	-0.10	-4.96	-2.28	0.23	-0.35
7-Sep-08	08:00:00	-0.58	-5.88	-2.53	-0.11	-0.78
7-Sep-08	20:00:00	-1.59	-9.42	-3.53	-0.77	-1.57
8-Sep-08	08:00:00	-1.99	-10.72	-3.87	-1.03	-1.73
8-Sep-08	20:00:00	-3.44	-13.29	-5.16	-1.65	-2.44
9-Sep-08	08:00:00	-4.03	-13.60	-5.67	-1.91	-2.66
9-Sep-08	20:00:00	-2.66	-3.54	-7.09	-2.39	-3.33
10-Sep-08	08:00:00	0.59	-2.48	-4.66	-1.12	-1.31
10-Sep-08	20:00:00	3.59	21.25	0.71	1.71	0.52
11-Sep-08	08:00:00	0.81	-2.27	5.22	6.59	9.70
11-Sep-08	20:00:00	0.60	-1.43	10.05	11.07	11.27
12-Sep-08	08:00:00	0.53	-2.89	0.98	1.86	0.30
12-Sep-08	20:00:00	0.16	-4.35	0.13	0.94	-0.18
13-Sep-08	08:00:00	-0.05	-4.56	-0.09	0.65	-0.33
13-Sep-08	20:00:00	-0.62	-5.52	-0.67	0.26	0.24
14-Sep-08	08:00:00	-0.83	-5.93	-0.94	0.03	-0.88
14-Sep-08	20:00:00	-1.62	-8.31	-1.63	-0.46	-0.03
15-Sep-08	08:00:00	-1.90	-8.78	-1.92	-0.70	-1.03
15-Sep-08	20:00:00	-3.33	-11.36	-2.55	-1.24	-0.69
16-Sep-08	08:00:00	-3.39	-10.67	-2.85	-1.49	-1.95
16-Sep-08	20:00:00	-2.13	-7.55	-2.69	-1.41	-1.68
17-Sep-08	08:00:00	-0.07	-3.68	-2.21	-1.09	-1.15
17-Sep-08	20:00:00	-0.52	-4.50	-3.25	-1.76	-0.81
18-Sep-08	08:00:00	-0.81	-4.89	-3.58	-1.96	-1.66
18-Sep-08	20:00:00	-1.57	-6.59	-4.73	-2.55	-0.28
19-Sep-08	08:00:00	-2.05	-7.82	-5.30	-2.83	-3.45
19-Sep-08	20:00:00	-3.19	-10.29	-7.05	-3.48	-1.81
20-Sep-08	08:00:00	-3.78	-10.82	-7.95	-3.81	-4.66
20-Sep-08	20:00:00	-5.60	-12.89	-10.30	-4.66	-4.53
21-Sep-08	08:00:00	-6.28	-12.79	-11.34	-4.99	-5.82
21-Sep-08	20:00:00	-7.65	-13.93	-13.30	-5.76	-5.92
22-Sep-08	08:00:00	-8.70	-13.28	-14.25	-6.10	-6.44
22-Sep-08	20:00:00	-11.51	-16.14	-17.49	-7.54	-6.08
23-Sep-08	08:00:00	-13.11	-16.42	-19.87	-8.14	-9.74
23-Sep-08	20:00:00	-14.64	-17.50	-22.28	-9.61	-8.60
24-Sep-08	08:00:00	-15.83	-17.28	-25.47	-10.54	-11.63
24-Sep-08	20:00:00	-17.55	-19.35	-28.42	-12.97	-13.10
25-Sep-08	08:00:00	-18.26	-18.57	-31.10	-13.98	-16.19
25-Sep-08	20:00:00	-18.92	-18.85	-33.22	-15.24	-18.05
26-Sep-08	08:00:00	1.14	-1.96	-26.31	-3.12	-4.76

Date	Time					
dd-mmm-yyyy	hh:mm:ss	Jon AW13	Jon AW14	Jon RAW1	Jon RAW2	Jon RAW3
26-Sep-08	20:00:00	1.26	-2.51	-2.95	-1.81	-1.75
27-Sep-08	08:00:00	0.97	-3.38	-3.01	-1.41	-0.08
27-Sep-08	20:00:00	0.68	-3.79	-4.27	-1.20	0.64
28-Sep-08	08:00:00	0.55	-3.99	-4.92	-1.18	-0.38
28-Sep-08	20:00:00	0.23	-4.61	-6.85	-1.81	0.86
29-Sep-08	08:00:00	0.01	-4.89	-7.74	-1.93	-0.42
29-Sep-08	20:00:00	-0.40	-5.89	-10.89	-2.48	-0.03
30-Sep-08	08:00:00	-0.41	-5.72	-11.51	-2.36	-2.29
30-Sep-08	20:00:00	-0.91	-6.97	-13.61	-2.94	-0.85
1-Oct-08	08:00:00	-1.11	-7.25	-14.31	-3.12	-2.02
1-Oct-08	20:00:00	-1.81	-9.37	-17.28	-3.74	-0.20
2-Oct-08	08:00:00	-2.40	-10.47	-19.11	-4.15	-3.11
2-Oct-08	20:00:00	-3.73	-12.51	-22.08	-5.10	-1.55
3-Oct-08	08:00:00	-4.69	-13.12	-25.23	-5.49	-4.31
3-Oct-08	20:00:00	-6.83	-15.01	-28.52	-6.56	-2.79
4-Oct-08	08:00:00	-8.39	-15.39	-31.78	-7.04	-5.69
4-Oct-08	20:00:00	-11.20	-16.81	-34.32	-8.27	-4.85
5-Oct-08	08:00:00	-12.38	-16.55	-36.76	-8.89	-7.60
5-Oct-08	20:00:00	-14.39	-17.81	-39.24	-10.22	-6.59
6-Oct-08	08:00:00	-15.26	-17.33	-42.32	-10.98	-8.71
6-Oct-08	20:00:00	-16.95	-18.95	-45.83	-12.65	-8.48
7-Oct-08	08:00:00	-17.73	-18.57	-48.80	-13.36	-11.81
7-Oct-08	20:00:00	-18.73	-19.58	-51.26	-14.90	-12.04
8-Oct-08	08:00:00	-19.15	-18.58	-51.31	-15.55	-14.24
8-Oct-08	20:00:00	-19.18	-16.89	-51.28	-15.79	-13.97
9-Oct-08	08:00:00	-15.75	-13.40	-51.31	-13.17	-11.34
9-Oct-08	20:00:00	-1.39	-3.98	-10.16	-2.52	-0.18
10-Oct-08	08:00:00	-1.77	-4.42	-12.99	-2.82	-0.53
10-Oct-08	20:00:00	-2.35	-5.01	-16.04	-3.01	0.04
11-Oct-08	08:00:00	-2.33	-5.12	-18.13	-2.90	0.22
11-Oct-08	20:00:00	-2.92	-5.85	-21.52	-3.64	-0.43
12-Oct-08	08:00:00	-3.63	-6.99	-24.16	-3.89	-0.90
12-Oct-08	20:00:00	-5.25	-9.41	-26.91	-4.77	0.16
13-Oct-08	08:00:00	-6.44	-10.52	-29.14	-4.99	-1.67
13-Oct-08	20:00:00	-8.41	-12.07	-30.34	-5.73	-0.58
14-Oct-08	08:00:00	-9.76	-12.61	-31.40	-5.98	-2.74
14-Oct-08	20:00:00	-11.96	-14.20	-32.31	-6.93	-0.45
15-Oct-08	08:00:00	-12.95	-14.56	-33.49	-7.31	-3.64
15-Oct-08	20:00:00	-14.79	-16.04	-34.67	-8.61	-2.13
16-Oct-08	08:00:00	-15.41	-16.01	-35.97	-9.09	-4.87
16-Oct-08	20:00:00	-16.85	-17.28	-37.08	-10.52	-4.31
17-Oct-08	08:00:00	-16.73	-16.12	-38.25	-10.83	-6.42
17-Oct-08	20:00:00	-11.43	-7.72	-39.36	-8.85	-1.42
18-Oct-08	08:00:00	-0.32	-3.39	-40.31	-2.37	0.20
18-Oct-08	20:00:00	-0.54	-4.22	-41.00	-2.99	2.98
19-Oct-08	08:00:00	-0.85	-4.63	-42.19	-2.91	1.15
19-Oct-08	20:00:00	-1.33	-5.49	-43.60	-3.44	3.41
20-Oct-08	08:00:00	-1.77	-6.46	-44.83	-3.51	-0.47
20-Oct-08	20:00:00	-2.30	-7.93	-45.71	-3.93	1.81



Date	Time					
dd-mmm-yyyy	hh:mm:ss	Jon AW13	Jon AW14	Jon RAW1	Jon RAW2	Jon RAW3
21-Oct-08	08:00:00	-2.90	-8.92	-46.66	-4.08	-1.19
21-Oct-08	20:00:00	-3.85	-10.29	-47.44	-4.67	1.12
22-Oct-08	08:00:00	-4.92	-11.35	-48.39	-4.98	-0.19
22-Oct-08	20:00:00	-6.59	-12.87	-49.18	-5.79	2.00
23-Oct-08	08:00:00	-8.37	-13.76	-50.07	-6.17	-3.43
23-Oct-08	20:00:00	-10.04	-14.44	-50.96	-6.89	0.22
24-Oct-08	08:00:00	-10.53	-13.31	-51.26	-7.19	-4.73
24-Oct-08	20:00:00	0.09	-2.16	-51.13	-3.42	-3.09
25-Oct-08	08:00:00	-0.34	-3.09	-51.09	-2.73	-1.15
25-Oct-08	20:00:00	-0.74	-4.01	-51.20	-2.52	2.57
26-Oct-08	08:00:00	-1.10	-4.37	-51.36	-2.41	1.80
26-Oct-08	20:00:00	-1.43	-4.82	-51.37	-2.67	3.04
27-Oct-08	08:00:00	-1.68	-5.11	-51.37	-2.44	0.32
27-Oct-08	20:00:00	-2.24	-5.96	-51.42	-2.98	2.87
28-Oct-08	08:00:00	-2.72	-6.76	-51.41	-3.18	-1.33
28-Oct-08	20:00:00	-3.55	-8.56	-51.39	-3.76	1.94
29-Oct-08	08:00:00	-4.37	-9.48	-51.41	-4.04	-0.75
29-Oct-08	20:00:00	-5.25	-10.32	-51.40	-4.50	2.55
30-Oct-08	08:00:00	-6.72	-11.58	-51.45	-4.90	-0.80
30-Oct-08	20:00:00	-8.16	-12.45	-51.36	-5.44	3.09
31-Oct-08	08:00:00	-9.60	-12.82	-51.28	-5.77	-1.79
31-Oct-08	20:00:00	-10.44	-12.74	-51.14	-6.23	1.74
1-Nov-08	08:00:00	-11.22	-12.60	-51.21	-6.51	-2.29
1-Nov-08	20:00:00	-11.91	-12.95	-51.19	-6.93	2.20
2-Nov-08	08:00:00	-12.63	-13.19	-51.06	-7.22	-1.97
2-Nov-08	20:00:00	-13.41	-13.81	-51.11	-7.75	2.87
3-Nov-08	08:00:00	-13.88	-13.76	-51.22	-8.06	-5.48
3-Nov-08	20:00:00	-10.72	-8.39	-51.18	-8.23	-3.11
4-Nov-08	08:00:00	-2.10	-3.61	-51.18	-7.53	-2.97
4-Nov-08	20:00:00	-0.71	-3.50	-51.16	-5.34	-1.36
5-Nov-08	08:00:00	-0.36	-2.92	-51.16	-5.00	-0.80
5-Nov-08	20:00:00	-0.49	-3.10	-51.14	-5.32	3.02
6-Nov-08	08:00:00	-0.66	-3.28	-51.19	-5.37	0.19
6-Nov-08	20:00:00	-0.75	-3.36	-51.15	-5.71	4.79
7-Nov-08	08:00:00	-0.96	-3.54	-51.20	-5.74	0.52
7-Nov-08	20:00:00	-1.03	-3.69	-51.11	-5.98	3.49
8-Nov-08	08:00:00	-1.06	-3.72	-51.15	-5.81	-1.10
8-Nov-08	20:00:00	-1.32	-3.99	-51.14	-6.20	4.81
9-Nov-08	08:00:00	-1.70	-4.27	-51.25	-6.44	0.29
9-Nov-08	20:00:00	-2.03	-4.53	-51.28	-6.73	4.15
10-Nov-08	08:00:00	-2.64	-4.92	-51.31	-7.02	-0.45
10-Nov-08	20:00:00	-3.00	-5.30	-51.25	-7.20	3.15
11-Nov-08	08:00:00	-3.80	-6.00	-51.09	-7.53	-1.32
11-Nov-08	20:00:00					
12-Nov-08	08:00:00					
12-Nov-08	20:00:00					
13-Nov-08	08:00:00					
13-Nov-08	20:00:00					
14-Nov-08	08:00:00					

					Weatherstation Rainfall Data	
Date	Time			On-site Raingauge	Wadesboro Daily Rainfall	Wadesboro Monthly Rainfall
dd-mmm-yyyy	hh:mm:ss	CG1	CG2		Wadesboro Daily Rainfall	Wadesboro Monthly Rainfall
01-Jan-2008	08:00:00				0	
01-Jan-2008	20:00:00					
02-Jan-2008	08:00:00				0	
02-Jan-2008	20:00:00					
03-Jan-2008	08:00:00				0	
03-Jan-2008	20:00:00					
04-Jan-2008	08:00:00				0	
04-Jan-2008	20:00:00					
05-Jan-2008	08:00:00				0	
05-Jan-2008	20:00:00					
06-Jan-2008	08:00:00				0	
06-Jan-2008	20:00:00					
07-Jan-2008	08:00:00				0	
07-Jan-2008	20:00:00					
08-Jan-2008	08:00:00				0	
08-Jan-2008	20:00:00					
09-Jan-2008	08:00:00				0	
09-Jan-2008	20:00:00					
10-Jan-2008	08:00:00				0.02	
10-Jan-2008	20:00:00					
11-Jan-2008	08:00:00				0.08	
11-Jan-2008	20:00:00					
12-Jan-2008	08:00:00				0.09	
12-Jan-2008	20:00:00					
13-Jan-2008	08:00:00				0	
13-Jan-2008	20:00:00					
14-Jan-2008	08:00:00				0	
14-Jan-2008	20:00:00					
15-Jan-2008	08:00:00				0	
15-Jan-2008	20:00:00					
16-Jan-2008	08:00:00				0	
16-Jan-2008	20:00:00					
17-Jan-2008	08:00:00				0.32	
17-Jan-2008	20:00:00					
18-Jan-2008	08:00:00				0.41	
18-Jan-2008	20:00:00					
19-Jan-2008	08:00:00				0.15	
19-Jan-2008	20:00:00					
20-Jan-2008	08:00:00				0.34	
20-Jan-2008	20:00:00					
21-Jan-2008	08:00:00				0	
21-Jan-2008	20:00:00					
22-Jan-2008	08:00:00				0	
22-Jan-2008	20:00:00					
23-Jan-2008	08:00:00				0.19	
23-Jan-2008	20:00:00					
24-Jan-2008	08:00:00				0	
24-Jan-2008	20:00:00					
25-Jan-2008	08:00:00				0	

					Weatherstation Rainfall Data	
Date	Time			On-site Raingauge	Wadesboro Daily Rainfall	Wadesboro Monthly Rainfall
dd-mmm-yyyy	hh:mm:ss	CG1	CG2		Wadesboro Daily Rainfall	Wadesboro Monthly Rainfall
25-Jan-2008	20:00:00					
26-Jan-2008	08:00:00				0	
26-Jan-2008	20:00:00					
27-Jan-2008	08:00:00				0	
27-Jan-2008	20:00:00					
28-Jan-2008	08:00:00				0	
28-Jan-2008	20:00:00					
29-Jan-2008	08:00:00				0	
29-Jan-2008	20:00:00					
30-Jan-2008	08:00:00				0.28	
30-Jan-2008	20:00:00					
31-Jan-2008	08:00:00				0	
31-Jan-2008	20:00:00					1.88
01-Feb-2008	08:00:00				0.24	
01-Feb-2008	20:00:00					
02-Feb-2008	08:00:00				0.18	
02-Feb-2008	20:00:00					
03-Feb-2008	08:00:00				0	
03-Feb-2008	20:00:00					
04-Feb-2008	08:00:00				0	
04-Feb-2008	20:00:00					
05-Feb-2008	08:00:00				0.2	
05-Feb-2008	20:00:00					
06-Feb-2008	08:00:00				0	
06-Feb-2008	20:00:00					
07-Feb-2008	08:00:00				0.1	
07-Feb-2008	20:00:00					
08-Feb-2008	08:00:00				0	
08-Feb-2008	20:00:00					
09-Feb-2008	08:00:00				0	
09-Feb-2008	20:00:00					
10-Feb-2008	08:00:00				0	
10-Feb-2008	20:00:00					
11-Feb-2008	08:00:00				0	
11-Feb-2008	20:00:00					
12-Feb-2008	08:00:00				0	
12-Feb-2008	20:00:00					
13-Feb-2008	08:00:00				0.24	
13-Feb-2008	20:00:00					
14-Feb-2008	08:00:00				0.02	
14-Feb-2008	20:00:00					
15-Feb-2008	08:00:00				0	
15-Feb-2008	20:00:00					
16-Feb-2008	08:00:00				0	
16-Feb-2008	20:00:00					
17-Feb-2008	08:00:00				0	
17-Feb-2008	20:00:00					
18-Feb-2008	08:00:00				1.47	
18-Feb-2008	20:00:00					

					Weatherstation Rainfall Data	
Date	Time			On-site Raingauge	Wadesboro Daily Rainfall	Wadesboro Monthly Rainfall
dd-mmm-yyyy	hh:mm:ss	CG1	CG2		Wadesboro Daily Rainfall	Wadesboro Monthly Rainfall
19-Feb-2008	08:00:00	0.6	0	6.76	0	
19-Feb-2008	20:00:00					
20-Feb-08	08:00:00				0	
20-Feb-08	20:00:00					
21-Feb-08	08:00:00				0	
21-Feb-08	20:00:00					
22-Feb-08	08:00:00				0.9	
22-Feb-08	20:00:00					
23-Feb-08	08:00:00				0.04	
23-Feb-08	20:00:00					
24-Feb-08	08:00:00				0	
24-Feb-08	20:00:00					
25-Feb-08	08:00:00				0.01	
25-Feb-08	20:00:00					
26-Feb-08	08:00:00				0	
26-Feb-08	20:00:00					
27-Feb-08	08:00:00				0.39	
27-Feb-08	20:00:00					
28-Feb-08	08:00:00				0	
28-Feb-08	20:00:00					
29-Feb-08	08:00:00				0	
29-Feb-08	20:00:00					3.79
1-Mar-08	08:00:00					
1-Mar-08	20:00:00					
2-Mar-08	08:00:00				0	
2-Mar-08	20:00:00					
3-Mar-08	08:00:00				0	
3-Mar-08	20:00:00					
4-Mar-08	08:00:00				0	
4-Mar-08	20:00:00					
5-Mar-08	08:00:00				1.73	
5-Mar-08	20:00:00					
6-Mar-08	08:00:00				0	
6-Mar-08	20:00:00					
7-Mar-08	08:00:00				0.03	
7-Mar-08	20:00:00					
8-Mar-08	08:00:00				0.53	
8-Mar-08	20:00:00					
9-Mar-08	08:00:00				0	
9-Mar-08	20:00:00					
10-Mar-08	08:00:00				0	
10-Mar-08	20:00:00					
11-Mar-08	08:00:00				0	
11-Mar-08	20:00:00					
12-Mar-08	08:00:00				0	
12-Mar-08	20:00:00					
13-Mar-08	08:00:00				0	
13-Mar-08	20:00:00					
14-Mar-08	08:00:00				0	



					Weatherstation Rainfall Data	
Date	Time			On-site Raingauge	Wadesboro Daily Rainfall	Wadesboro Monthly Rainfall
dd-mmm-yyyy	hh:mm:ss	CG1	CG2		Wadesboro Daily Rainfall	Wadesboro Monthly Rainfall
14-Mar-08	20:00:00					
15-Mar-08	08:00:00				0	
15-Mar-08	20:00:00					
16-Mar-08	08:00:00				0.75	
16-Mar-08	20:00:00					
17-Mar-08	08:00:00				0	
17-Mar-08	20:00:00					
18-Mar-08	08:00:00				0	
18-Mar-08	20:00:00					
19-Mar-08	08:00:00				0	
19-Mar-08	20:00:00					
20-Mar-08	08:00:00				0.62	
20-Mar-08	20:00:00					
21-Mar-08	08:00:00				0	
21-Mar-08	20:00:00					
22-Mar-08	08:00:00				0	
22-Mar-08	20:00:00					
23-Mar-08	08:00:00				0	
23-Mar-08	20:00:00					
24-Mar-08	08:00:00				0	
24-Mar-08	20:00:00					
25-Mar-08	08:00:00				0	
25-Mar-08	20:00:00					
26-Mar-08	08:00:00				0	
26-Mar-08	20:00:00					
27-Mar-08	08:00:00	0	0	4.97	0	
27-Mar-08	20:00:00					
28-Mar-08	08:00:00				0	
28-Mar-08	20:00:00					
29-Mar-08	08:00:00				0	
29-Mar-08	20:00:00					
30-Mar-08	08:00:00				0.03	
30-Mar-08	20:00:00					
31-Mar-08	08:00:00				0.02	
31-Mar-08	20:00:00					3.71
1-Apr-08	08:00:00				0.05	
1-Apr-08	20:00:00					
2-Apr-08	08:00:00				0.02	
2-Apr-08	20:00:00					
3-Apr-08	08:00:00				0.24	
3-Apr-08	20:00:00					
4-Apr-08	08:00:00				0.02	
4-Apr-08	20:00:00					
5-Apr-08	08:00:00				0.93	
5-Apr-08	20:00:00					
6-Apr-08	08:00:00				0.39	
6-Apr-08	20:00:00					
7-Apr-08	08:00:00				0	
7-Apr-08	20:00:00					

					Weatherstation Rainfall Data	
Date	Time			On-site Raingauge	Wadesboro Daily Rainfall	Wadesboro Monthly Rainfall
dd-mmm-yyyy	hh:mm:ss	CG1	CG2		Wadesboro Daily Rainfall	Wadesboro Monthly Rainfall
8-Apr-08	08:00:00				0	
8-Apr-08	20:00:00					
9-Apr-08	08:00:00				0	
9-Apr-08	20:00:00					
10-Apr-08	08:00:00				0	
10-Apr-08	20:00:00					
11-Apr-08	08:00:00				0	
11-Apr-08	20:00:00					
12-Apr-08	08:00:00				0.05	
12-Apr-08	20:00:00					
13-Apr-08	08:00:00				0.23	
13-Apr-08	20:00:00					
14-Apr-08	08:00:00				0.04	
14-Apr-08	20:00:00					
15-Apr-08	08:00:00				0.02	
15-Apr-08	20:00:00					
16-Apr-08	08:00:00				0	
16-Apr-08	20:00:00					
17-Apr-08	08:00:00				0	
17-Apr-08	20:00:00					
18-Apr-08	08:00:00				0	
18-Apr-08	20:00:00					
19-Apr-08	08:00:00				0	
19-Apr-08	20:00:00					
20-Apr-08	08:00:00				0.23	
20-Apr-08	20:00:00					
21-Apr-08	08:00:00				0	
21-Apr-08	20:00:00					
22-Apr-08	08:00:00				0	
22-Apr-08	20:00:00					
23-Apr-08	08:00:00	0	0	3.03	0	
23-Apr-08	20:00:00					
24-Apr-08	08:00:00				0	
24-Apr-08	20:00:00					
25-Apr-08	08:00:00				0	
25-Apr-08	20:00:00					
26-Apr-08	08:00:00				0	
26-Apr-08	20:00:00					
27-Apr-08	08:00:00				0.34	
27-Apr-08	20:00:00					
28-Apr-08	08:00:00				1.14	
28-Apr-08	20:00:00					
29-Apr-08	08:00:00				0.26	
29-Apr-08	20:00:00					
30-Apr-08	08:00:00				0	
30-Apr-08	20:00:00					3.96
1-May-08	08:00:00				0	
1-May-08	20:00:00					
2-May-08	08:00:00				0	

					Weatherstation Rainfall Data	
Date	Time			On-site Raingauge	Wadesboro Daily Rainfall	Wadesboro Monthly Rainfall
dd-mmm-yyyy	hh:mm:ss	CG1	CG2			
2-May-08	20:00:00					
3-May-08	08:00:00				0	
3-May-08	20:00:00					
4-May-08	08:00:00				0.02	
4-May-08	20:00:00					
5-May-08	08:00:00				0	
5-May-08	20:00:00					
6-May-08	08:00:00				0	
6-May-08	20:00:00					
7-May-08	08:00:00				0	
7-May-08	20:00:00					
8-May-08	08:00:00				0.02	
8-May-08	20:00:00					
9-May-08	08:00:00				0.24	
9-May-08	20:00:00					
10-May-08	08:00:00				0	
10-May-08	20:00:00					
11-May-08	08:00:00				0.29	
11-May-08	20:00:00					
12-May-08	08:00:00				0.19	
12-May-08	20:00:00					
13-May-08	08:00:00				0	
13-May-08	20:00:00					
14-May-08	08:00:00				0	
14-May-08	20:00:00					
15-May-08	08:00:00				0	
15-May-08	20:00:00					
16-May-08	08:00:00				0.17	
16-May-08	20:00:00					
17-May-08	08:00:00				0	
17-May-08	20:00:00					
18-May-08	08:00:00				0	
18-May-08	20:00:00					
19-May-08	08:00:00				0.27	
19-May-08	20:00:00					
20-May-08	08:00:00				0	
20-May-08	20:00:00					
21-May-08	08:00:00				0.75	
21-May-08	20:00:00					
22-May-08	08:00:00				0	
22-May-08	20:00:00					
23-May-08	08:00:00				0	
23-May-08	20:00:00					
24-May-08	08:00:00				0	
24-May-08	20:00:00					
25-May-08	08:00:00				0.05	
25-May-08	20:00:00					
26-May-08	08:00:00				0	
26-May-08	20:00:00					

					Weatherstation Rainfall Data	
Date	Time			On-site Raingauge	Wadesboro Daily Rainfall	Wadesboro Monthly Rainfall
dd-mmm-yyyy	hh:mm:ss	CG1	CG2		Wadesboro Daily Rainfall	Wadesboro Monthly Rainfall
27-May-08	08:00:00	0	0	4.26	0	
27-May-08	20:00:00					
28-May-08	08:00:00				0	
28-May-08	20:00:00					
29-May-08	08:00:00				0.39	
29-May-08	20:00:00					
30-May-08	08:00:00				0	
30-May-08	20:00:00					
31-May-08	08:00:00				0	
31-May-08	20:00:00					2.39
1-Jun-08	08:00:00				0	
1-Jun-08	20:00:00					
2-Jun-08	08:00:00				0.02	
2-Jun-08	20:00:00					
3-Jun-08	08:00:00				0	
3-Jun-08	20:00:00					
4-Jun-08	08:00:00				0	
4-Jun-08	20:00:00					
5-Jun-08	08:00:00				0	
5-Jun-08	20:00:00					
6-Jun-08	08:00:00				0	
6-Jun-08	20:00:00					
7-Jun-08	08:00:00				0	
7-Jun-08	20:00:00					
8-Jun-08	08:00:00				0	
8-Jun-08	20:00:00					
9-Jun-08	08:00:00				0	
9-Jun-08	20:00:00					
10-Jun-08	08:00:00				0	
10-Jun-08	20:00:00					
11-Jun-08	08:00:00				0	
11-Jun-08	20:00:00					
12-Jun-08	08:00:00				0.21	
12-Jun-08	20:00:00					
13-Jun-08	08:00:00				0.2	
13-Jun-08	20:00:00					
14-Jun-08	08:00:00				0	
14-Jun-08	20:00:00					
15-Jun-08	08:00:00				0.47	
15-Jun-08	20:00:00					
16-Jun-08	08:00:00				0	
16-Jun-08	20:00:00					
17-Jun-08	08:00:00				0	
17-Jun-08	20:00:00					
18-Jun-08	08:00:00				0	
18-Jun-08	20:00:00					
19-Jun-08	08:00:00				0	
19-Jun-08	20:00:00					
20-Jun-08	08:00:00				0	



					Weatherstation Rainfall Data	
Date	Time			On-site Raingauge	Wadesboro Daily Rainfall	Wadesboro Monthly Rainfall
dd-mmm-yyyy	hh:mm:ss	CG1	CG2		Wadesboro Daily Rainfall	Wadesboro Monthly Rainfall
20-Jun-08	20:00:00					
21-Jun-08	08:00:00				0.08	
21-Jun-08	20:00:00					
22-Jun-08	08:00:00				0.18	
22-Jun-08	20:00:00					
23-Jun-08	08:00:00	0	0	4	0.02	
23-Jun-08	20:00:00					
24-Jun-08	08:00:00				0	
24-Jun-08	20:00:00					
25-Jun-08	08:00:00				0	
25-Jun-08	20:00:00					
26-Jun-08	08:00:00				0	
26-Jun-08	20:00:00					
27-Jun-08	08:00:00				0	
27-Jun-08	20:00:00					
28-Jun-08	08:00:00				0	
28-Jun-08	20:00:00					
29-Jun-08	08:00:00				0.01	
29-Jun-08	20:00:00					
30-Jun-08	08:00:00				0	
30-Jun-08	20:00:00					1.19
1-Jul-08	08:00:00				0	
1-Jul-08	20:00:00					
2-Jul-08	08:00:00				0	
2-Jul-08	20:00:00					
3-Jul-08	08:00:00				0	
3-Jul-08	20:00:00					
4-Jul-08	08:00:00				0	
4-Jul-08	20:00:00					
5-Jul-08	08:00:00				0.14	
5-Jul-08	20:00:00					
6-Jul-08	08:00:00				0.5	
6-Jul-08	20:00:00					
7-Jul-08	08:00:00				0.46	
7-Jul-08	20:00:00					
8-Jul-08	08:00:00				0	
8-Jul-08	20:00:00					
9-Jul-08	08:00:00				1.29	
9-Jul-08	20:00:00					
10-Jul-08	08:00:00				0.78	
10-Jul-08	20:00:00					
11-Jul-08	08:00:00				0.39	
11-Jul-08	20:00:00					
12-Jul-08	08:00:00				0.02	
12-Jul-08	20:00:00					
13-Jul-08	08:00:00				0	
13-Jul-08	20:00:00					
14-Jul-08	08:00:00				0	
14-Jul-08	20:00:00					

					Weatherstation Rainfall Data	
Date	Time			On-site Raingauge	Wadesboro Daily Rainfall	Wadesboro Monthly Rainfall
dd-mmm-yyyy	hh:mm:ss	CG1	CG2		Wadesboro Daily Rainfall	Wadesboro Monthly Rainfall
15-Jul-08	08:00:00				0	
15-Jul-08	20:00:00					
16-Jul-08	08:00:00				0	
16-Jul-08	20:00:00					
17-Jul-08	08:00:00				0	
17-Jul-08	20:00:00					
18-Jul-08	08:00:00				0	
18-Jul-08	20:00:00					
19-Jul-08	08:00:00				0	
19-Jul-08	20:00:00					
20-Jul-08	08:00:00				0.04	
20-Jul-08	20:00:00					
21-Jul-08	08:00:00				0	
21-Jul-08	20:00:00					
22-Jul-08	08:00:00				0	
22-Jul-08	20:00:00					
23-Jul-08	08:00:00				0	
23-Jul-08	20:00:00					
24-Jul-08	08:00:00				0.29	
24-Jul-08	20:00:00					
25-Jul-08	08:00:00				0	
25-Jul-08	20:00:00					
26-Jul-08	08:00:00				0	
26-Jul-08	20:00:00					
27-Jul-08	08:00:00				0.02	
27-Jul-08	20:00:00					
28-Jul-08	08:00:00	0	0	8.47	0	
28-Jul-08	20:00:00					
29-Jul-08	08:00:00				0	
29-Jul-08	20:00:00					
30-Jul-08	08:00:00				0	
30-Jul-08	20:00:00					
31-Jul-08	08:00:00				0.02	
31-Jul-08	20:00:00					3.95
1-Aug-08	08:00:00				1.02	
1-Aug-08	20:00:00					
2-Aug-08	08:00:00				0	
2-Aug-08	20:00:00					
3-Aug-08	08:00:00				1.87	
3-Aug-08	20:00:00					
4-Aug-08	08:00:00				0	
4-Aug-08	20:00:00					
5-Aug-08	08:00:00				0	
5-Aug-08	20:00:00					
6-Aug-08	08:00:00				0	
6-Aug-08	20:00:00					
7-Aug-08	08:00:00				0	
7-Aug-08	20:00:00					
8-Aug-08	08:00:00				1.18	

					Weatherstation Rainfall Data	
Date	Time			On-site Raingauge	Wadesboro Daily Rainfall	Wadesboro Monthly Rainfall
dd-mmm-yyyy	hh:mm:ss	CG1	CG2		Wadesboro Daily Rainfall	Wadesboro Monthly Rainfall
8-Aug-08	20:00:00					
9-Aug-08	08:00:00				0	
9-Aug-08	20:00:00					
10-Aug-08	08:00:00				0.02	
10-Aug-08	20:00:00					
11-Aug-08	08:00:00				0.06	
11-Aug-08	20:00:00					
12-Aug-08	08:00:00				0	
12-Aug-08	20:00:00					
13-Aug-08	08:00:00				0.5	
13-Aug-08	20:00:00					
14-Aug-08	08:00:00				1.54	
14-Aug-08	20:00:00					
15-Aug-08	08:00:00				0	
15-Aug-08	20:00:00					
16-Aug-08	08:00:00				0.92	
16-Aug-08	20:00:00					
17-Aug-08	08:00:00				1.76	
17-Aug-08	20:00:00					
18-Aug-08	08:00:00				0.47	
18-Aug-08	20:00:00					
19-Aug-08	08:00:00				0	
19-Aug-08	20:00:00					
20-Aug-08	08:00:00				0	
20-Aug-08	20:00:00					
21-Aug-08	08:00:00				0	
21-Aug-08	20:00:00					
22-Aug-08	08:00:00				0	
22-Aug-08	20:00:00					
23-Aug-08	08:00:00				0	
23-Aug-08	20:00:00					
24-Aug-08	08:00:00				0	
24-Aug-08	20:00:00					
25-Aug-08	08:00:00	0	0	6.05	0	
25-Aug-08	20:00:00					
26-Aug-08	08:00:00				1.39	
26-Aug-08	20:00:00					
27-Aug-08	08:00:00				1.48	
27-Aug-08	20:00:00					
28-Aug-08	08:00:00				0.93	
28-Aug-08	20:00:00					
29-Aug-08	08:00:00				0.02	
29-Aug-08	20:00:00					
30-Aug-08	08:00:00				0	
30-Aug-08	20:00:00					
31-Aug-08	08:00:00				0	
31-Aug-08	20:00:00					13.16
1-Sep-08	08:00:00				1.85	
1-Sep-08	20:00:00					

					Weatherstation Rainfall Data	
Date	Time			On-site Raingauge	Wadesboro Daily Rainfall	Wadesboro Monthly Rainfall
dd-mmm-yyyy	hh:mm:ss	CG1	CG2			
2-Sep-08	08:00:00				0	
2-Sep-08	20:00:00					
3-Sep-08	08:00:00				0	
3-Sep-08	20:00:00					
4-Sep-08	08:00:00				0	
4-Sep-08	20:00:00					
5-Sep-08	08:00:00				0	
5-Sep-08	20:00:00					
6-Sep-08	08:00:00				1.63	
6-Sep-08	20:00:00					
7-Sep-08	08:00:00				0	
7-Sep-08	20:00:00					
8-Sep-08	08:00:00				0	
8-Sep-08	20:00:00					
9-Sep-08	08:00:00				0	
9-Sep-08	20:00:00					
10-Sep-08	08:00:00				0.96	
10-Sep-08	20:00:00					
11-Sep-08	08:00:00				1.51	
11-Sep-08	20:00:00					
12-Sep-08	08:00:00				0	
12-Sep-08	20:00:00					
13-Sep-08	08:00:00				0	
13-Sep-08	20:00:00					
14-Sep-08	08:00:00				0	
14-Sep-08	20:00:00					
15-Sep-08	08:00:00				0	
15-Sep-08	20:00:00					
16-Sep-08	08:00:00				0	
16-Sep-08	20:00:00					
17-Sep-08	08:00:00				0.08	
17-Sep-08	20:00:00					
18-Sep-08	08:00:00				0	
18-Sep-08	20:00:00					
19-Sep-08	08:00:00				0	
19-Sep-08	20:00:00					
20-Sep-08	08:00:00				0	
20-Sep-08	20:00:00					
21-Sep-08	08:00:00				0	
21-Sep-08	20:00:00					
22-Sep-08	08:00:00				0	
22-Sep-08	20:00:00					
23-Sep-08	08:00:00	0.4	1.5	5.9	0	
23-Sep-08	20:00:00					
24-Sep-08	08:00:00				0	
24-Sep-08	20:00:00					
25-Sep-08	08:00:00				0	
25-Sep-08	20:00:00					
26-Sep-08	08:00:00				0.98	



					Weatherstation Rainfall Data	
Date	Time			On-site Raingauge	Wadesboro Daily Rainfall	Wadesboro Monthly Rainfall
dd-mmm-yyyy	hh:mm:ss	CG1	CG2			
26-Sep-08	20:00:00					
27-Sep-08	08:00:00				0.17	
27-Sep-08	20:00:00					
28-Sep-08	08:00:00				0	
28-Sep-08	20:00:00					
29-Sep-08	08:00:00				0	
29-Sep-08	20:00:00					
30-Sep-08	08:00:00				0.14	
30-Sep-08	20:00:00					7.32
1-Oct-08	08:00:00				0.08	
1-Oct-08	20:00:00					
2-Oct-08	08:00:00				0	
2-Oct-08	20:00:00					
3-Oct-08	08:00:00				0	
3-Oct-08	20:00:00					
4-Oct-08	08:00:00				0	
4-Oct-08	20:00:00					
5-Oct-08	08:00:00				0	
5-Oct-08	20:00:00					
6-Oct-08	08:00:00				0	
6-Oct-08	20:00:00					
7-Oct-08	08:00:00				0	
7-Oct-08	20:00:00					
8-Oct-08	08:00:00				0	
8-Oct-08	20:00:00					
9-Oct-08	08:00:00				0.13	
9-Oct-08	20:00:00					
10-Oct-08	08:00:00				0.73	
10-Oct-08	20:00:00					
11-Oct-08	08:00:00				0.03	
11-Oct-08	20:00:00					
12-Oct-08	08:00:00				0.03	
12-Oct-08	20:00:00					
13-Oct-08	08:00:00				0	
13-Oct-08	20:00:00					
14-Oct-08	08:00:00				0	
14-Oct-08	20:00:00					
15-Oct-08	08:00:00				0	
15-Oct-08	20:00:00					
16-Oct-08	08:00:00				0	
16-Oct-08	20:00:00					
17-Oct-08	08:00:00				0	
17-Oct-08	20:00:00					
18-Oct-08	08:00:00				0.59	
18-Oct-08	20:00:00					
19-Oct-08	08:00:00				0	
19-Oct-08	20:00:00					
20-Oct-08	08:00:00				0	
20-Oct-08	20:00:00					

					Weatherstation Rainfall Data	
Date	Time			On-site Raingauge	Wadesboro Daily Rainfall	Wadesboro Monthly Rainfall
dd-mmm-yyyy	hh:mm:ss	CG1	CG2			
21-Oct-08	08:00:00				0	
21-Oct-08	20:00:00					
22-Oct-08	08:00:00				0	
22-Oct-08	20:00:00					
23-Oct-08	08:00:00				0	
23-Oct-08	20:00:00					
24-Oct-08	08:00:00				0	
24-Oct-08	20:00:00					
25-Oct-08	08:00:00				0.82	
25-Oct-08	20:00:00					
26-Oct-08	08:00:00				0	
26-Oct-08	20:00:00					
27-Oct-08	08:00:00				0	
27-Oct-08	20:00:00					
28-Oct-08	08:00:00				0	
28-Oct-08	20:00:00					
29-Oct-08	08:00:00				0	
29-Oct-08	20:00:00					
30-Oct-08	08:00:00				0	
30-Oct-08	20:00:00					
31-Oct-08	08:00:00				0	
31-Oct-08	20:00:00					2.41
1-Nov-08	08:00:00				0	
1-Nov-08	20:00:00					
2-Nov-08	08:00:00					
2-Nov-08	20:00:00					
3-Nov-08	08:00:00					
3-Nov-08	20:00:00					
4-Nov-08	08:00:00				0.14	
4-Nov-08	20:00:00					
5-Nov-08	08:00:00				0.05	
5-Nov-08	20:00:00					
6-Nov-08	08:00:00				0	
6-Nov-08	20:00:00					
7-Nov-08	08:00:00				0	
7-Nov-08	20:00:00					
8-Nov-08	08:00:00				0	
8-Nov-08	20:00:00					
9-Nov-08	08:00:00				0	
9-Nov-08	20:00:00					
10-Nov-08	08:00:00				0	
10-Nov-08	20:00:00					
11-Nov-08	08:00:00	0.0	0.0	4.4	0	
11-Nov-08	20:00:00					
12-Nov-08	08:00:00				0	
12-Nov-08	20:00:00					
13-Nov-08	08:00:00				0	
13-Nov-08	20:00:00					
14-Nov-08	08:00:00				0.46	