

**Jones Creek Mitigation Project
Anson County, North Carolina
DENR-EEP Contract No. D04020-1
Year 4 Monitoring Report**



Prepared for
Environmental Banc and Exchange, LLC
909 Capability Drive, Suite 3100
Raleigh, NC 27606

Prepared by
WK Dickson and Co., Inc.
720 Corporate Center Drive
Raleigh, NC 27607
(919) 782-0495

And

Ecosystem & Land Trust Monitoring
PO Box 1492
3674 Pine Swamp Road
Sparta, NC 2867

November 2009

Table of Contents

1.0	SUMMARY.....	1
2.0	INTRODUCTION.....	2
2.1	Project Description.....	2
2.2	Project Purpose.....	5
2.3	Project History & Schedule.....	5
3.0	HYDROLOGY.....	5
3.1	Hydrologic Success Criteria.....	5
3.2	Description of Hydrology Monitoring Efforts.....	5
3.3	Results of Hydrology Monitoring.....	7
3.3.1	Site Data.....	7
3.3.2	Reference Data.....	11
3.3.3	Climate Data.....	12
3.4	Hydrologic Conclusions.....	14
4.0	VEGETATION.....	14
4.1	Vegetation Success Criteria.....	14
4.2	Description of Species and Vegetation Monitoring.....	14
4.3	Results of Vegetation Monitoring.....	15
4.4	Vegetation Observations & Conclusions.....	16
5.0	STREAM MONITORING.....	16
5.1	Stream Success Criteria.....	16
5.2	Stream Morphology Monitoring Plan.....	17
5.2.1	Cross Sections.....	17
5.2.2	Longitudinal Profile.....	17
5.2.3	Hydrology.....	17
5.2.4	Photo Reference Stations.....	17
5.3	Stream Morphology Monitoring Results.....	17
5.3.1	Cross Sections.....	17
5.3.2	Longitudinal Profile.....	18
5.3.3	Hydrology.....	18
5.4	Stream Conclusions.....	21
6.0	CONCLUSIONS AND RECOMMENDATIONS.....	21

List of Figures

Figure 1. Vicinity Map	3
Figure 2. USGS Map	4
Figure 3. Monitoring Summary Map.....	6
Figure 4a. Groundwater Hydrographs 1-4.....	9
Figure 4b. Groundwater Hydrographs 5-8	9
Figure 4c. Groundwater Hydrographs 9-12.....	10
Figure 4d. Groundwater Hydrographs 13-14	10
Figure 4e. Groundwater Hydrographs 15-19.....	11
Figure 5. Reference Hydrographs.....	12
Figure 6. 2009 Rainfall.....	13
Figure 7. Stream Problem Areas Map	20

List of Tables

Table 1. Project Mitigation Structure and Objectives	2
Table 2. Project Activity and Reporting History	5
Table 3. Project Contacts.....	5
Table 4. Hydrologic Monitoring Results.....	8
Table 5. Comparison of Normal Rainfall to Observed Rainfall	13
Table 6. Planted Tree Species	15
Table 7. 2009 Vegetation Monitoring Plot Species Composition	15
Table 8. Volunteer species within the Wetland Restoration Area.....	16
Table 9. Stream Areas Requiring Observation.....	18
Table 10. Crest Gauge Data.....	19
Table 11. Summary of Morphologic Monitoring Parameters	21

APPENDICES

Appendix A	As-Built Survey
Appendix B	2008 Profile and Cross Section Data
Appendix C	2008 Site Photos
Appendix D	2008Gauge Data

1.0 SUMMARY

This Annual Report details the monitoring activities during the 2009 growing season at the Jones Creek Mitigation Site. The Jones Creek wetland and stream restoration site is located near the Town of Wadesboro in Anson County, North Carolina. Construction of the site was completed in December 2005. Baseline data on stream morphology and vegetation were collected immediately after construction and planting were completed. As-Built survey information is documented in **Appendix A**. All restoration is being monitored for five years to document success. The 2009 data represents results from the fourth year of hydrology, vegetation, and stream stability monitoring.

Mitigation at the Jones Creek site involved stream restoration, stream preservation, wetland enhancement, and wetland restoration. The stream restoration channel was designed and constructed using natural channel design techniques. Wetland restoration involved raising the local water table by filling drainage ditches on-site and creation of microtopography across the site. After construction, it was determined there was 3,068 feet of stream restoration, 5,150 feet of stream preservation, 25 acres of wetland restoration, and 2.7 acres of wetland enhancement. In the fall of 2008 additional work at the site was completed. This involved minor repairs to ditch plugs, sub-surface ripping, and repairs to a damaged level spreader. These remedial actions addressed concentrated runoff from an adjacent upland area. The disturbed areas were stabilized and re-planted.

During the 2009 Growing Season a hydrologic and hydric soil assessment was conducted on Jones Creek site. This assessment identified 1.73 acres of additional restored wetlands within the conservation easement. These areas had hydric soils and indicators of wetland hydrology. The additional wetland restoration areas are included in the figures and results presented in this annual monitoring report.

This Annual Report presents the data from 19 hydrology monitoring stations, 13 vegetation monitoring plots, two crest gauges, a manual rain gauge, an auto-logging rain gauge, 6 stream cross sections, and photo reference locations, as required by the approved Restoration Plan for the site. Five hydrology monitoring stations and auto-logging rain gauge were added prior to the 2009 growing season. All 19 hydrology monitoring stations are equipped with automated groundwater gauges.

Weather station data from the Wadesboro Weather Station were used in conjunction with a manual rain gauge and an auto-logging rain gauge located on the site to document precipitation amounts. During the 2009 growing season, the rainfall total through the end of August was generally within normal limits. On-site rainfall in June and July were below normal limits.

In 2009, 17 of 19 hydrology monitoring gauges recorded hydroperiods of at least 7 percent of the growing season. All of these 17 hydrology monitoring gauges recorded hydroperiods of 12 percent or greater during the 2009 Year 4 growing season. Although AW6 and AW17 recorded hydroperiods of less than 7 percent of the growing season, the depths at which a 7 percent hydroperiod was recorded were 22 and 26 inches. The three monitoring gauges at the reference site recorded hydroperiods from 15 to 27 percent of the growing season. It is important to note that the hydrology of the targeted wetland system is highly responsive to rainfall and is expected to be variable across a given site, supporting the ecological and functional diversity that makes these systems so valuable. Overall, the site was within the range of hydrologic conditions expected in undisturbed floodplain wetlands.

This Annual Report documents vegetation survivability based on 13 vegetation-monitoring plots, as specified in the approved Mitigation Plan for this site. They are randomly located to represent the different zones within the project. The vegetation monitoring documented a density range of 440 stems per acre to 680 stems per acre with an average of 560 stems per acre. Overall, the site has met the initial vegetation survival criteria of 320 stems per acre surviving after the third growing season and is on track to meet the final survival criteria of 280 trees per acre after Year 5.

Throughout the Year 4 monitoring season, the restored stream channel remained stable and continued to provide the intended habitat and hydrologic functions. All monitored cross sections show very little adjustment in stream dimension, and the site remains on track to achieve the stream stability success criteria specified in the Restoration Plan.

2.0 INTRODUCTION

2.1 PROJECT DESCRIPTION

The Jones Creek wetland and stream restoration site is located near the Town of Wadesboro in Anson County, North Carolina (**Figure 1** and **Figure 2**). The site has a past history of agricultural use. Ditches on the site were used to increase subsurface drainage. Construction of the site, including planting of trees, was completed in December 2005. Groundwater, surface water, and rain gauges were functional throughout 2009.

Mitigation at the Jones Creek site involved stream restoration, stream preservation, wetland enhancement, and wetland restoration. Restoration of the site involved the restoration of a stable meandering channel. The channel was designed and constructed using natural channel design techniques. Restoration also involved raising the local water table by filling drainage ditches on-site and creation of microtopography across the site. **Table 1** shows the as-built lengths and restoration type for each reach.

Table 1. Project Mitigation Structure and Objectives

Reach Name	As-Built	Mitigation Units	Restoration Approach
Stream			
Mill Branch	1855 lf	1855	Stream Restoration
UT1	1213 lf	1213	Stream Restoration
South Fork Jones Creek	5150 lf	1030	Stream Preservation
Total	8218 lf	4098	
Wetland			
	25.0 ac	25.0	Restoration
	2.7 ac	1.4	Enhancement
2009 Hydrologic Assessment	1.7 ac	1.7	Additional Restoration
Total	29.4 ac	28.1	

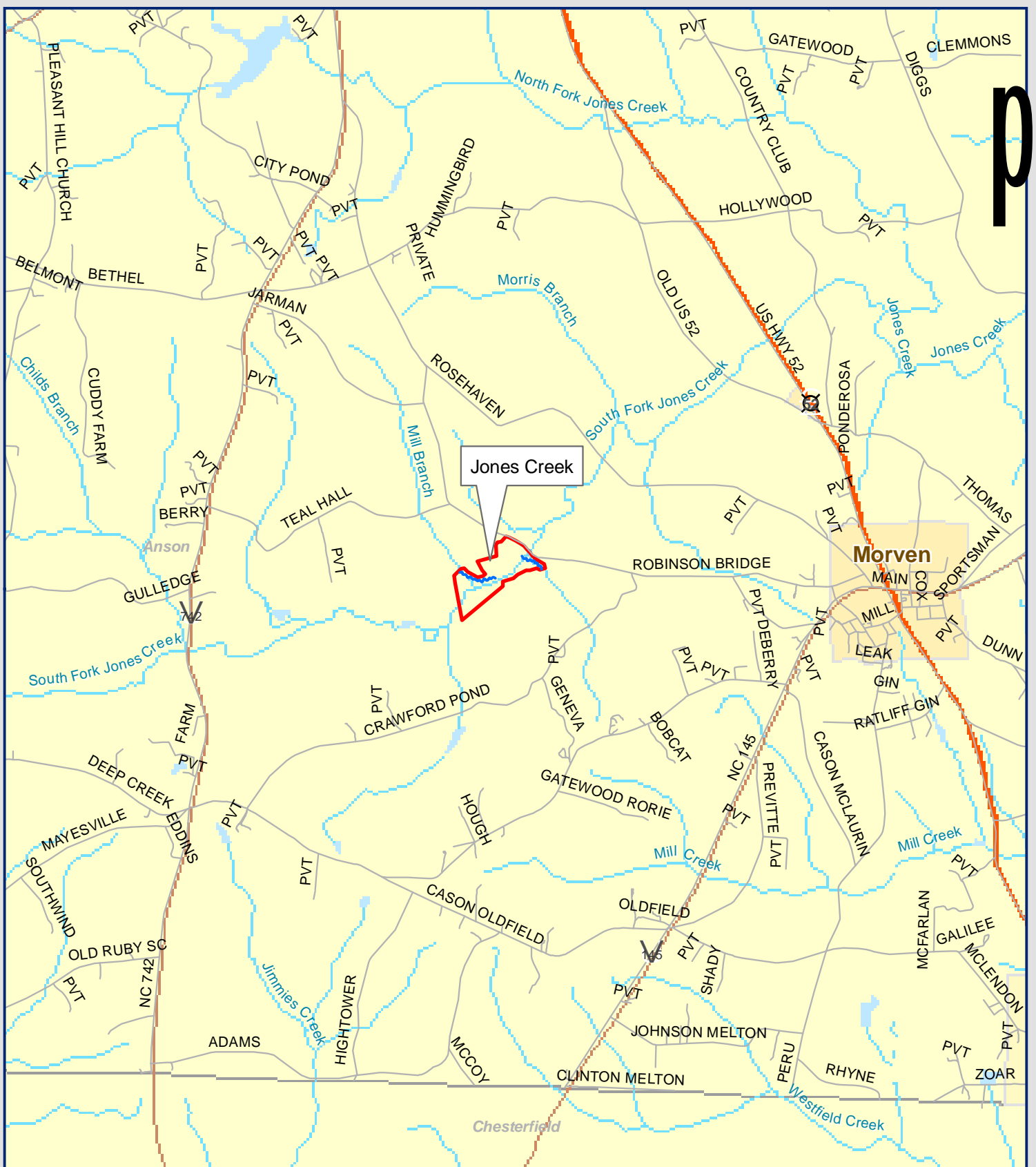
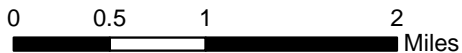
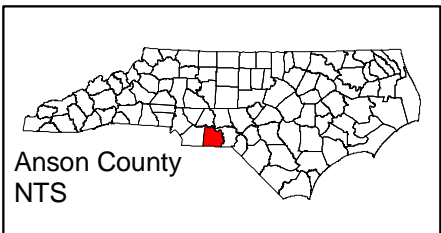

Figure 1
 Jones Creek Site
 Anson County
 Vicinity Map



Legend

- Streams
- Roads
- Jones Creek Site



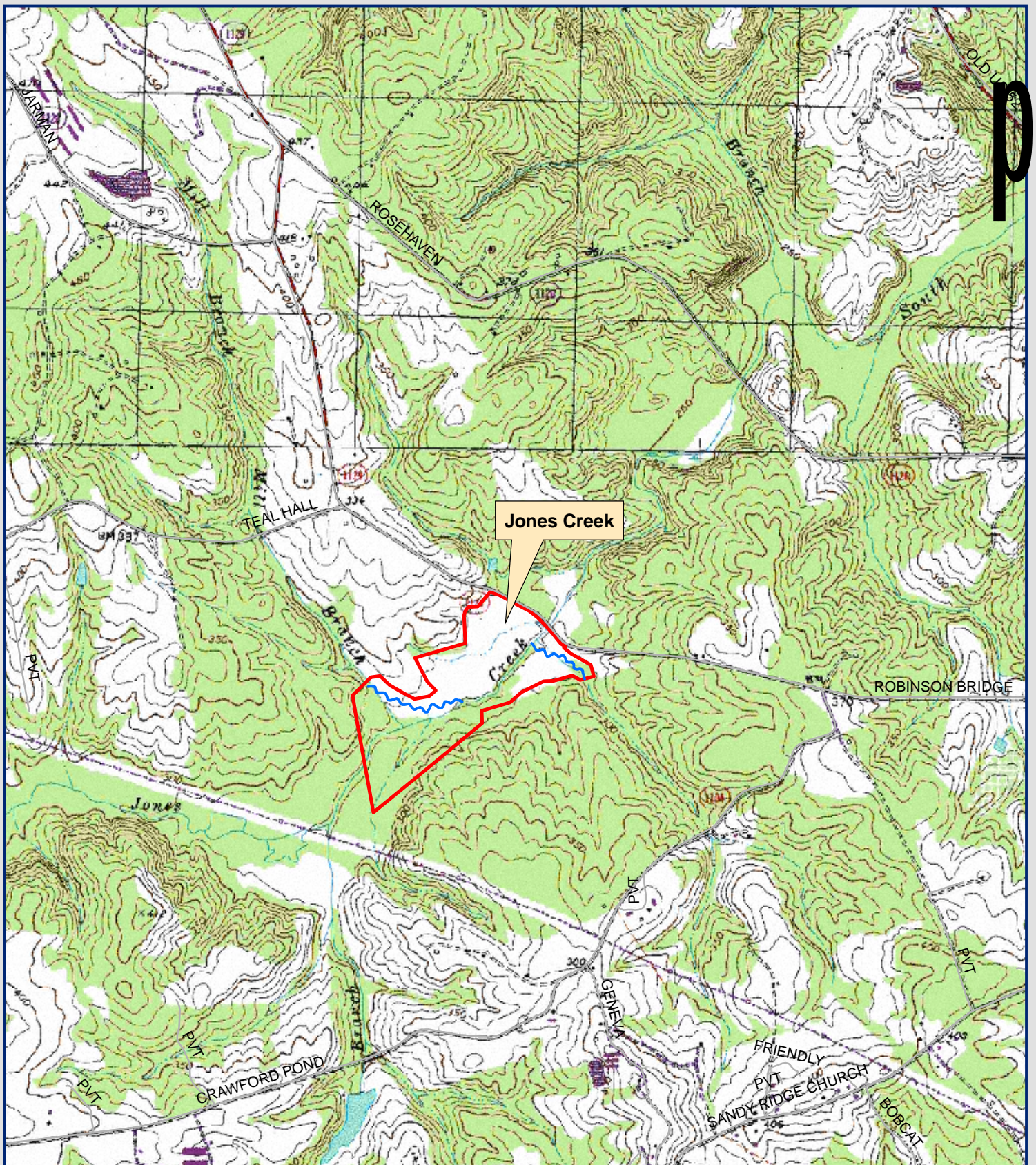

Figure 2
 Jones Creek Site
 Anson County
 USGS Map



0 500 1,000 2,000 3,000 4,000
 Feet

- Streams
- Roads
- Jones Creek Site

2.2 PROJECT PURPOSE

Monitoring of the Jones Creek Site is required to demonstrate successful restoration based on the criteria found in the Restoration Plan and through a comparison to reference site conditions. Hydrologic, vegetation, and stream monitoring are conducted on an annual basis. Success criteria must be met for five consecutive years. This Annual Report details the results of the monitoring efforts for 2009 (Year 4) at the Jones Creek Mitigation Site.

2.3 PROJECT HISTORY & SCHEDULE

Table 2. Project Activity and Reporting History

Month	Activity
December 2005	Construction Completed
March 2006	Post-restoration Monitoring Begins
November 2006	1st Annual Monitoring Report
November 2007	2nd Annual Monitoring Report
November 2008	3rd Annual Monitoring Report
November 2009	4th Annual Monitoring Report
November 2010 (scheduled)	5th Annual Monitoring Report

Table 3. Project Contacts

Contact	Firm Information
Project Manager Norton Webster	EBX-Neuse 1, LLC (919) 608-9688
Designer Kevin Tweedy, PE	Buck Engineering PC (919) 463-5488
Monitoring Contractor Daniel Ingram	WK Dickson and Co., Inc (919) 782-0495

3.0 HYDROLOGY

3.1 HYDROLOGIC SUCCESS CRITERIA

As stated in the approved Restoration Plan, to meet the hydrologic success criteria the hydrology monitoring data must show that for each normal year of rainfall within the monitoring period the site has been inundated or saturated within 12 inches of the soil surface for a minimum of 7 percent of the growing season (16 days). The day counts are based on the growing season for Anson County, which is 225 days long (24 March – 5 November). Groundwater data are collected from 14 automated groundwater gauges. The Restoration Plan further specifies that precipitation must be within or below normal limits for the hydrologic data to be considered successful.

3.2 DESCRIPTION OF HYDROLOGY MONITORING EFFORTS

A total of 19 groundwater gauges are installed on-site to monitor hydrology. **Figure 3** displays the gauge locations. Fourteen groundwater gauges (seven manual and seven automated) were installed following construction. During April 2007, all seven manual groundwater gauges were converted to automated gauges. Five automated groundwater gauges were added during October 2008 to further document wetland restoration and define potential areas of concern. The gauges are checked and the data downloaded monthly. During the monthly site visits all automated gauges, calibration gauges, crest gauges, and the rain gauge are read.

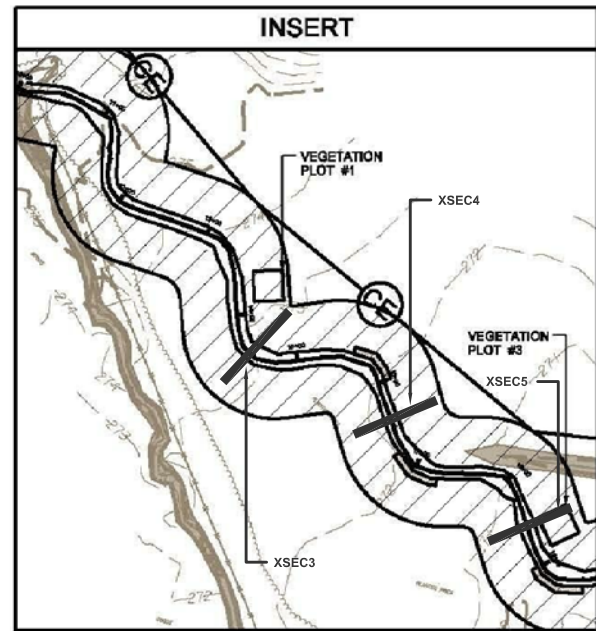

WETLAND HYDROPERIOD

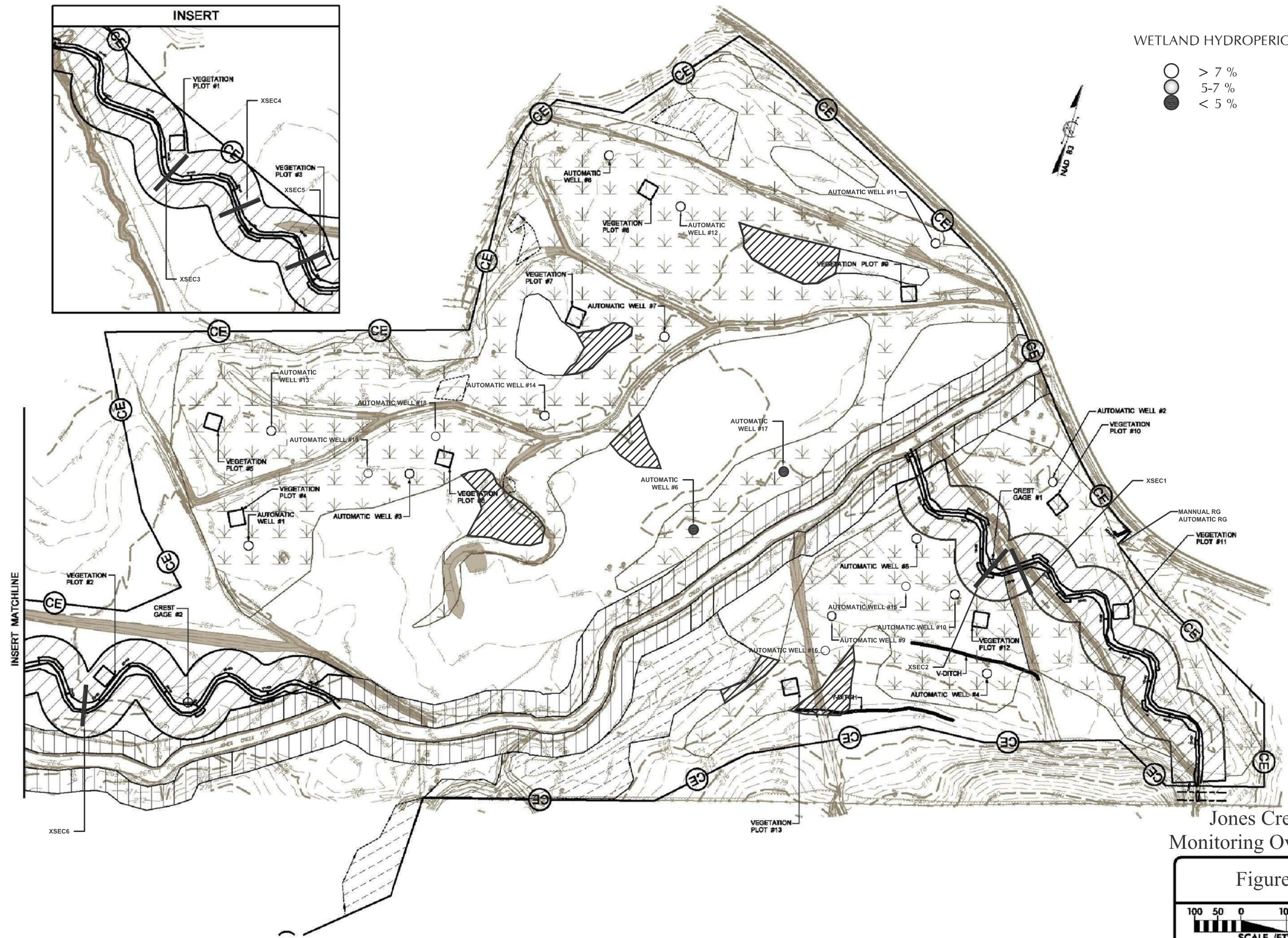
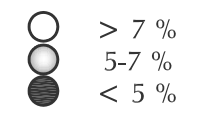

Jones Creek
Monitoring Overview

Figure 3

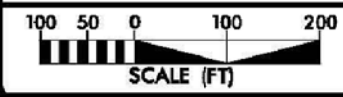

Automated Gauges

Automatic groundwater gauges record water table elevations twice daily at 08:00 and 20:00. Infinities gauges employ pressure sensors that record water elevation above the bottom of the sensor (with atmospheric pressure compensation). Immediately adjacent to each automatic gauge is a manual calibration gauge. The calibration water table depth is recorded at monthly downloads. To determine wetland hydroperiods, the automatically recorded data are compared to the calibration data to determine a standard correction factor between the calibration gauge and the automatic gauge for each location. The standard correction factor is applied to correct daily readings. The corrected daily readings are then used to determine wetland hydroperiods.

Data Interpretation

Wetland hydroperiods are calculated from twice daily water table depth elevations. A hydroperiod is calculated if the water table is equal to or less than -12 inches below ground surface for at least 24 hours. If a gauge falls below -12 inches for two consecutive readings (24 hours), then the hydroperiod ends at the last reading within -12 inches. If a gauge falls below -12 inches for only one reading then maintains a reading above -12 inches for a minimum of 24 hours, the hydroperiod is calculated continuously. This methodology accounts for minor technical malfunctions experienced by the automatic gauges.

3.3 RESULTS OF HYDROLOGY MONITORING

3.3.1 Site Data

The following hydroperiod statistics were calculated for each monitoring station during the growing season: 1) most consecutive days that the water table was within twelve inches of the soil surface; 2) cumulative number of days that the water table was within twelve inches of the soil surface; and 3) number of times that the water table rose to within twelve inches of the soil surface. The results of these calculations are presented in **Table 4**. The location of the groundwater and the stream gauges are shown in **Figures 3**. **Figures 4a-4e** provides charts of the water table depth for each of the monitoring gauges. **Appendix C** contains all the 2009 gauge data.

Table 4. Hydrologic Monitoring Results

Gauge	Consecutive		Cumulative		Occurrences
	Days	Percent of Growing Season	Days	Percent of Growing Season	
Jon AW1	35	16	61	27	5
Jon AW2	36	16	71	32	3
Jon AW3	35	16	69	31	3
Jon AW4	47	21	67	30	4
Jon AW5	34	15	60	27	7
Jon AW6	5	2	9	4	3
Jon AW7	83	37	85	38	3
Jon AW8	43	19	87	39	7
Jon AW9	26	12	32	14	3
Jon AW10	33	15	60	27	6
Jon AW11	42	19	81	36	5
Jon AW12	35	16	67	30	4
Jon AW13	38	17	74	33	3
Jon AW14	32	14	47	21	6
Jon AW15	31	14	48	21	7
Jon AW16	26	12	32	14	4
Jon AW17	2	1	5	2	3
Jon AW18	32	14	43	19	6
Jon AW19	34	15	63	28	5
Jon RAW1	34	15	34	15	1
Jon RAW2	51	23	71	32	4
Jon RAW3	60	27	80	36	3

Figure 4a. Groundwater Hydrographs 1-4

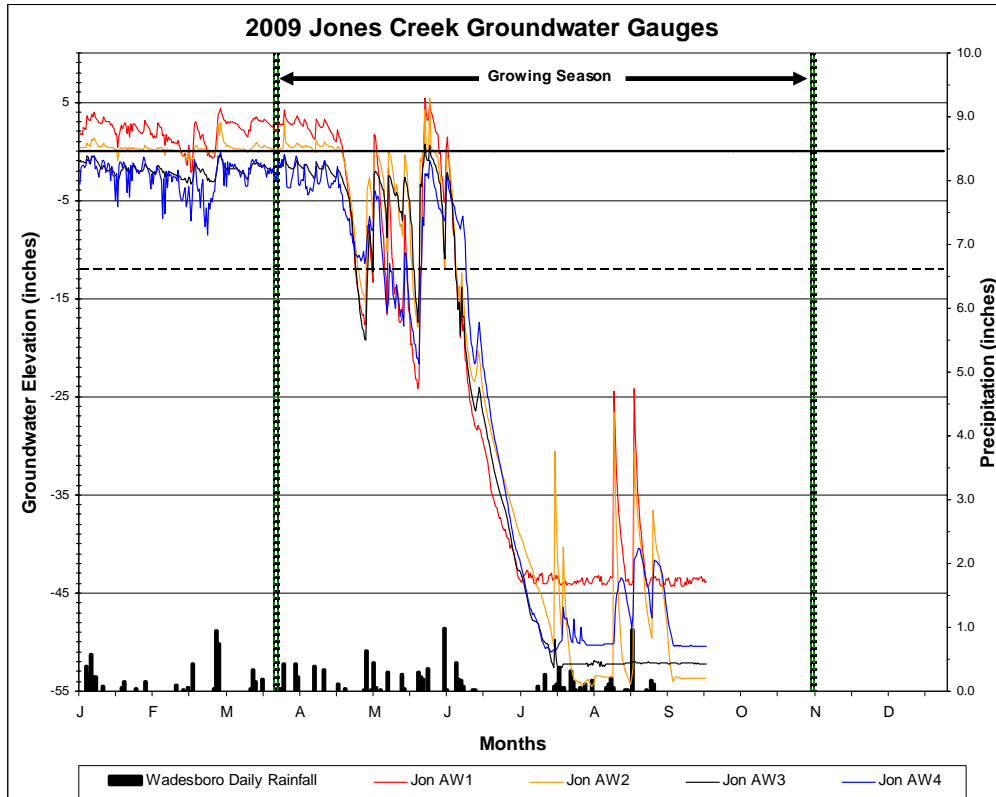

Figure 4b. Groundwater Hydrographs 5-8

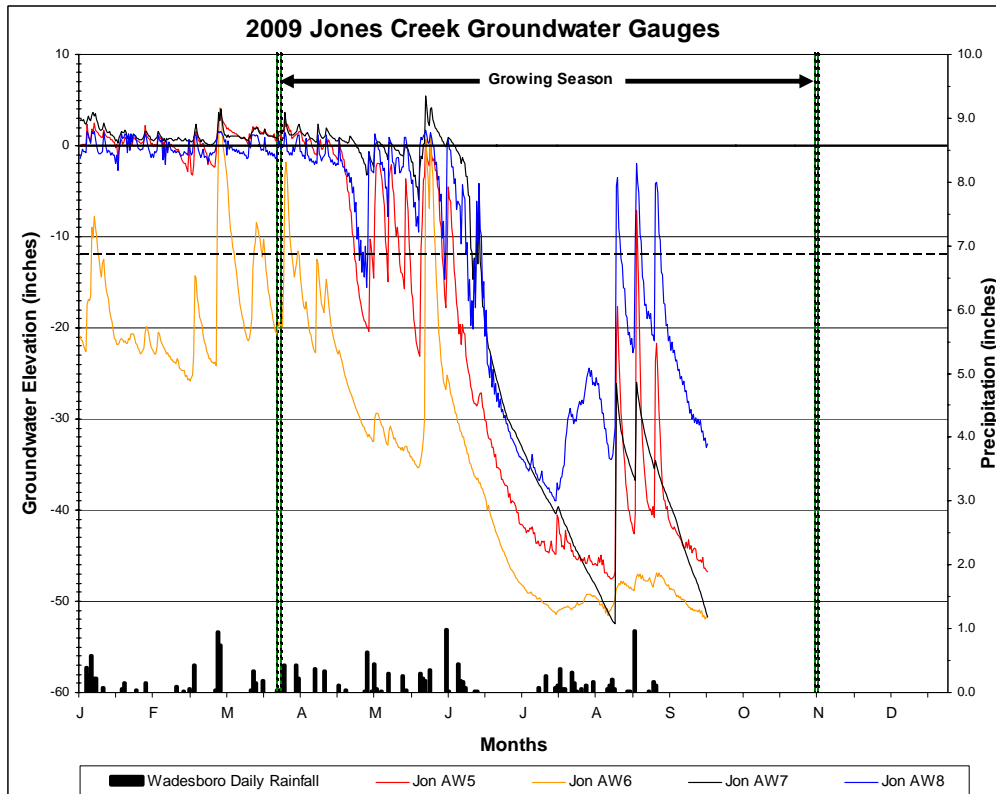

Figure 4c. Groundwater Hydrographs 9-12

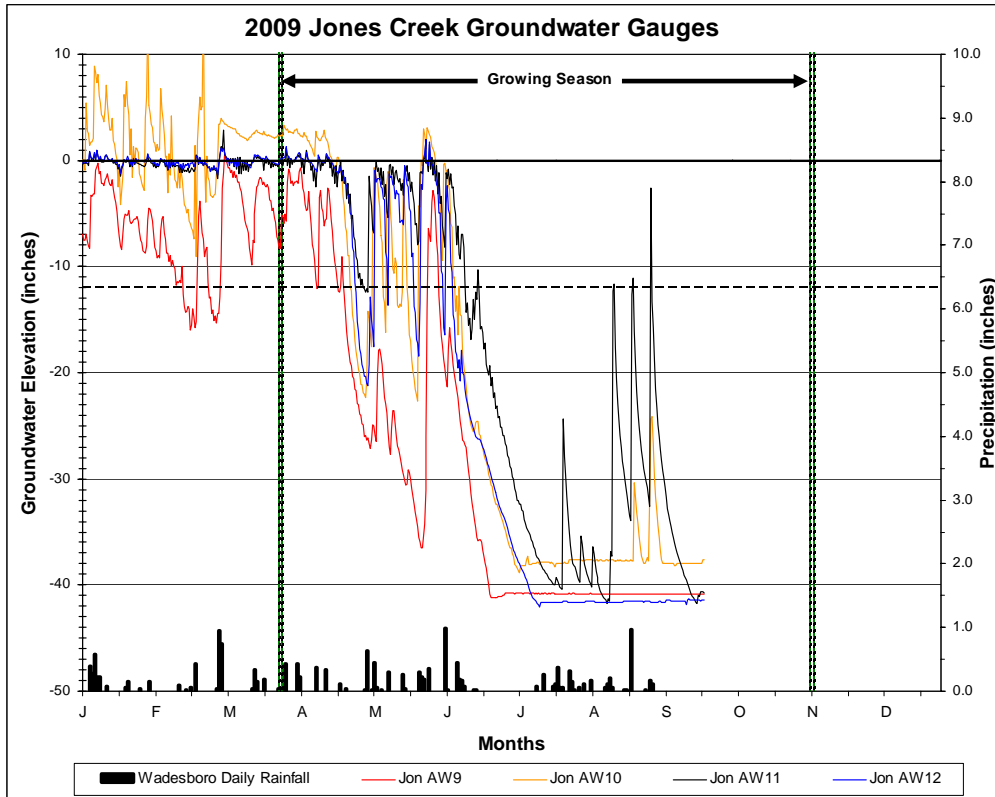

Figure 4d. Groundwater Hydrographs 13-14

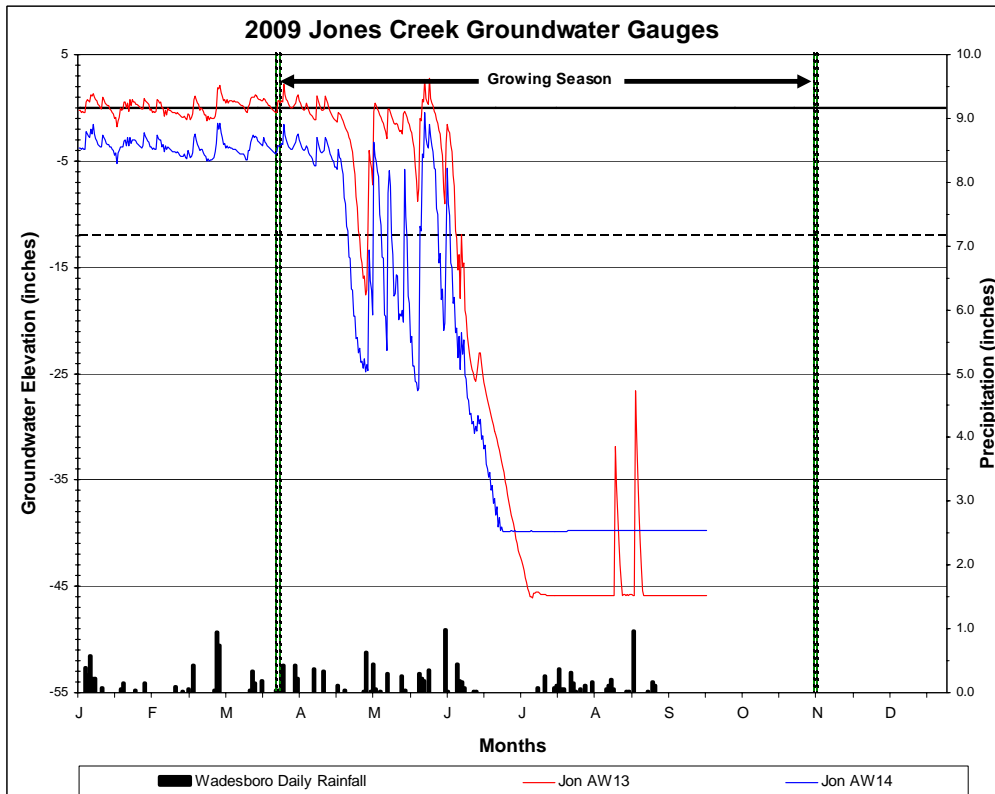
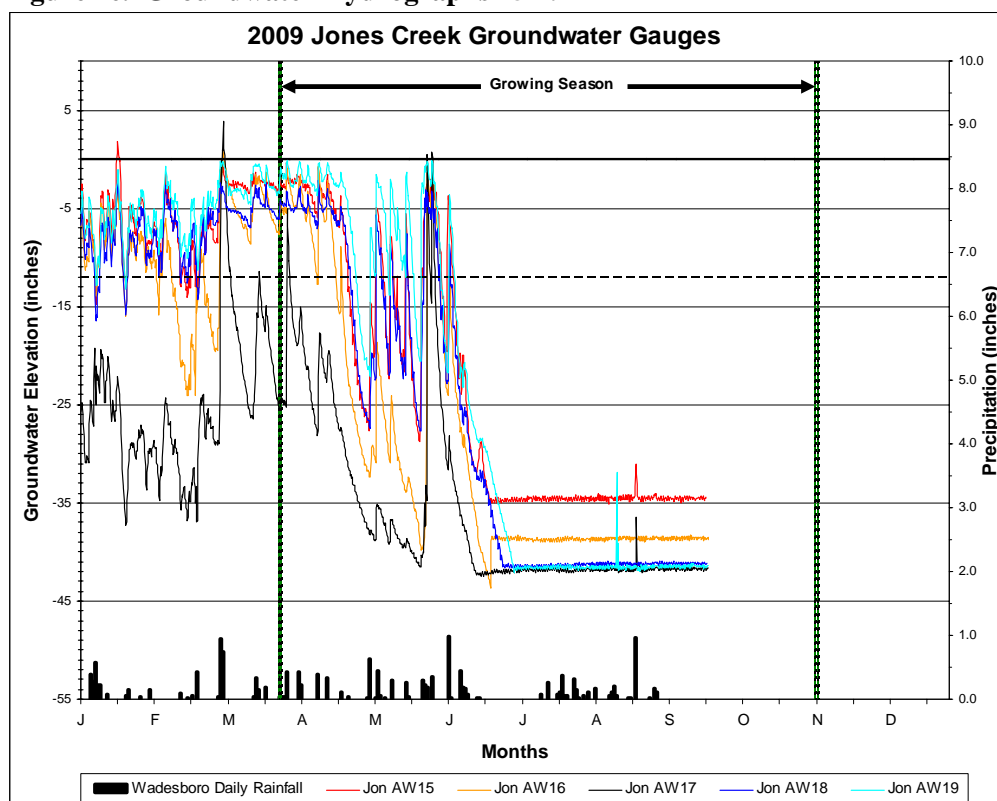

Figure 4e. Groundwater Hydrographs 15-19



3.3.2 Reference Data

The Restoration Plan provides that if rainfall for any monitoring year is outside of normal limits reference wetland data can be used to determine if there is a positive correlation between performance on the restoration site and the natural hydrology on the reference site.

Three reference gauges were installed in the Pee Dee National Wildlife Refuge in July 2006. The reference gauges are located in a wetland on the floodplain of Brown Creek. In late March thru the end of April, Reference Gauges AW1, AW2, and AW3 experienced maximum wetland hydroperiods of 15, 23 and 27 percent of the growing season, respectively. **Figure 5** and **Table 4** present the reference gauge data.

Figure 5. Reference Hydrographs

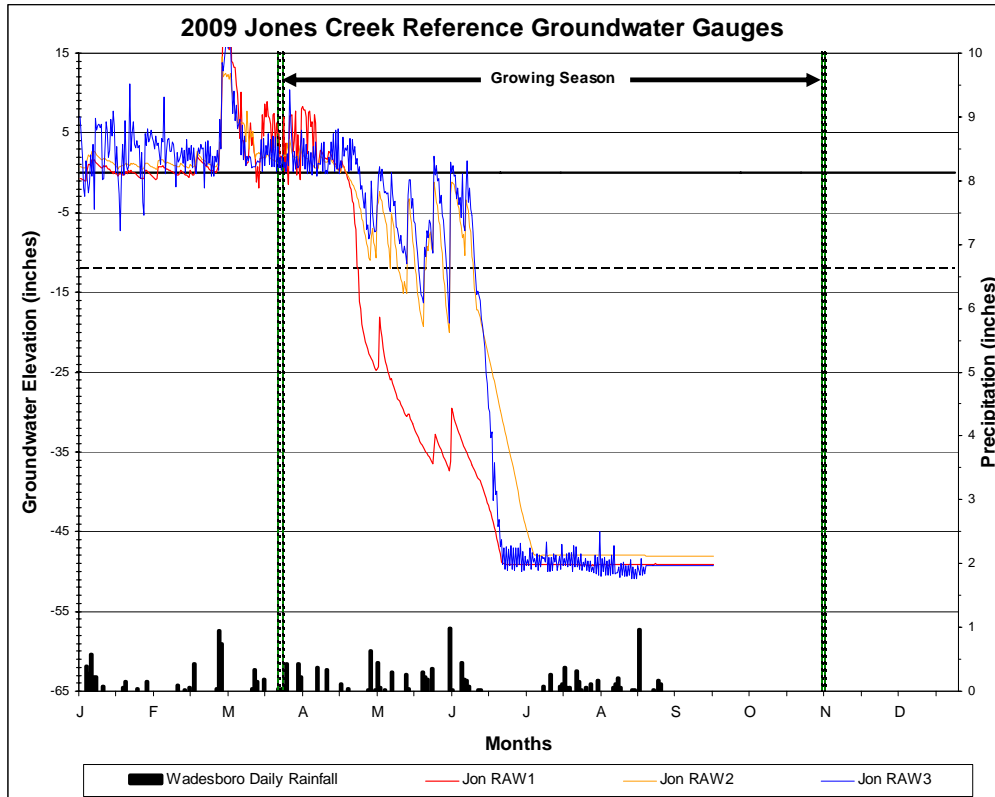

3.3.3 Climate Data

Figure 5 is a comparison of the 2009 monthly rainfall to historical precipitation for Anson County (NRCS WETS Tables). Observed precipitation data were collected from the Wadesboro automated weather station and an on-site manual rain gauge. Rainfall data collected from the on-site rain gauge showed amounts slightly higher than those taken from the Wadesboro weather station. Rainfall amounts from both the on-site gauge and from the weather station show rainfall amounts are below the historic average during every month except May and August.

Figure 6. 2009 Rainfall

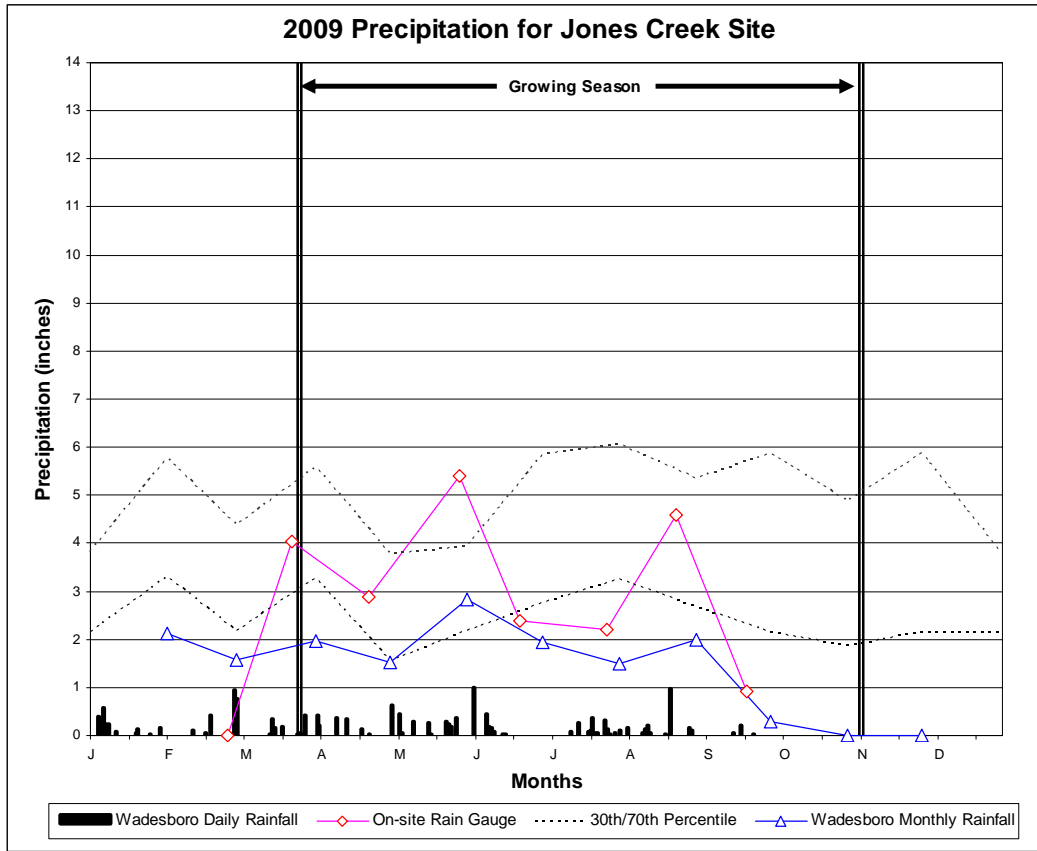

Table 5. Comparison of Normal Rainfall to Observed Rainfall

Month	Average	Normal Limits		Wadesboro Precipitation	On-Site Precipitation
		30 Percent	70 Percent		
January	4.66	3.31	5.78	2.13	---
February	3.56	2.18	4.37	1.57	---
March	4.61	3.28	5.58	1.21	4.05
April	2.94	1.54	3.78	1.51	2.88
May	3.44	2.18	3.93	2.82	5.39
June	4.56	2.74	5.84	1.93	2.38
July	5.26	3.26	6.06	1.50	2.19
August	4.41	2.67	5.36	1.98	4.60
September	4.25	2.15	5.87	---	0.92
October	3.66	1.85	4.87	---	---
November	3.10	2.14	3.86	---	---
December	3.28	2.16	3.83	---	---
Total	47.72	43.21	50.80	14.65	22.41

3.4 HYDROLOGIC CONCLUSIONS

Data collected from the groundwater gauges on the Jones Creek Mitigation Site indicate that 17 of 19 hydrology monitoring stations recorded a hydroperiod of at least 7 percent of the growing season. All of these 17 hydrology monitoring gauges recorded hydroperiods of 12 percent or greater during the 2009 Year 4 growing season. Jon AW6 and Jon AW17 monitoring gauges did not meet the 7 percent success criteria as defined in the Restoration Plan. Although AW6 and AW17 recorded hydroperiods of less than 7 percent of the growing season, the depths at which a 7 percent hydroperiod was recorded were 22 and 26 inches. Overall, the site is within the range of hydrologic conditions expected in undisturbed floodplain wetlands. Based on the results of the first four years of groundwater monitoring, most of the site appears to be performing as designed, and the entire site is within the range of conditions expected in undisturbed floodplain wetlands.

During 2009, an additional 1.73 acres of wetland restoration was located outside the original wetland restoration boundary. Most of these additional restoration areas are in low topographic positions or depressions features similar to the adjacent restored wetland. The vegetation is hydrophytic and the soils have hydric indicators within five to eight inches. The typical sandy textured surface is dark grayish brown (10YR 4/2) with many strong brown redoxomorphic concentration mottles. A field boundary for each area was determined utilizing hydric soil indicators, topography, and vegetation and was mapped with sub-meter GPS. These areas of additional restoration were not included in the pre-construction hydric soil delineation likely due to the loss of hydric indicators from artificial drainage. Following restoration the soils have regained hydric indicators and should be considered restoration.

4.0 VEGETATION

4.1 VEGETATION SUCCESS CRITERIA

The interim measure of vegetative success for the Jones Creek Mitigation Plan is the survival of at least 320 3-year old planted trees per acre at the end of year three of the monitoring period. The final vegetative success criteria will be the survival of 260 5-year old planted trees per acre at the end of year five of the monitoring period.

Up to 20 percent of the site species composition may be comprised of invaders. Remedial action may be required should these (i.e. loblolly pine, red maple, sweetgum, etc.) present a problem and exceed 20 percent composition.

4.2 DESCRIPTION OF SPECIES AND VEGETATION MONITORING

The following monitoring protocol was designed to demonstrate vegetation density. Thirteen plots were established on the Jones Creek Site to monitor approximately one percent of the site. Four plots are located adjacent to newly constructed streambeds to monitor the vegetation in the stream restoration buffer. The other nine plots are randomly located each zone and randomly oriented within the wetland restoration area.

Plot construction consists of metal fence posts at each of the four corners to clearly and permanently establish the area that was to be sampled. Then ropes were hung connecting all four corners to help in determining if trees close to the plot boundary were inside or outside of the plot. Trees right on the boundary and trees just outside of the boundary that appear to have greater than 50 percent of their canopy inside the boundary were counted inside the plot. A piece of white PVC pipe ten feet tall was placed over the metal post on one corner to facilitate visual location of site throughout the five-year monitoring period.

All of the planted stems inside the plot were flagged with orange flagging and marked with a three foot tall piece of half inch PVC to mark them as the planted stems (vs. any colonizers) and to help in locating them in the future. Each stem was then tagged with a permanent numbered aluminum tag. **Table 6** describes the planted tree species.

Table 6. Planted Tree Species

ID	Common Name	Scientific Name	FAC Status
1	Swamp Chestnut Oak	<i>Quercus michauxii</i>	FACW-
2	Willow Oak	<i>Quercus phellos</i>	FACW-
3	River Birch	<i>Betula nigra</i>	FACW
4	Sycamore	<i>Platanus occidentalis</i>	FACW-
5	Sugar Berry	<i>Celtis laevigata</i>	FACW
6	Yellow Poplar	<i>Liriodendron tulipifera</i>	FAC
7	Swamp Tupelo	<i>Nyssa biflora</i>	OBL
8	Overcup Oak	<i>Quercus lyrata</i>	OBL
9	Green Ash	<i>Fraxinus pennsylvanica</i>	FACW

4.3 RESULTS OF VEGETATION MONITORING

The following tables present stem counts for each of the monitoring plot. Each planted tree species is identified across the top row, and each plot is identified down the left column. The numbers on the top row correlate to the ID column of the previous table. Trees are flagged in the field on an as need basis before the flags degrade. Flags are utilized, because they will not interfere with the growth of the tree. Volunteers are also flagged during this process. Annual variation in stem count data can be attributed to mortality and regeneration from root stock of stems previously assessed to be dead.

Table 7. 2009 Vegetation Monitoring Plot Species Composition

Plot	1	2	3	4	5	6	7	8	9	Total	Stems per Acre
JO 1	0	0	1	3	7	1	0	0	4	16	640
JO 2	1	0	2	2	4	1	0	0	3	13	520
JO 3	0	1	0	6	0	0	0	3	1	12	440
JO 4	2	2	3	2	0	0	0	4	0	13	520
JO 5	0	1	0	8	2	1	0	3	1	16	640
JO 6	4	0	2	5	0	0	0	1	1	13	520
JO 7	4	2	0	3	0	0	2	0	2	13	520
JO 8	0	2	3	0	0	0	3	0	3	11	440
JO 9	5	3	2	0	0	0	2	0	4	16	640
JO 10	1	2	2	3	0	0	1	1	4	14	560
JO 11	2	0	0	4	1	2	1	0	6	16	640
JO 12	1	5	0	2	0	2	0	0	3	13	520
JO 13	1	2	0	3	0	0	6	1	4	17	680

Average Stems per Acre: 560

Range of Stems per Acre: 440-680

Volunteer species are also monitored throughout the five-year monitoring period. Below is a table of the most common woody volunteer species.

Table 8. Volunteer species within the Wetland Restoration Area

ID	Scientific Name	Common Name	FAC Status
A	<i>Liquidambar styraciflua</i>	Sweetgum	FAC+
B	<i>Diospyros virginiana</i>	Persimmon	FAC
C	<i>Pinus taeda</i>	Loblolly Pine	FAC

Very few volunteer woody species were observed in the vegetation plots, but many were found adjacent to the plugged irrigation ditches, especially close to vegetation plots four and five. Regular maintenance of cutting and mowing will keep these woody volunteers from exceeding the acceptable amount of volunteers on the site. Sweetgum (*Liquidambar styraciflua*) is the most common volunteer.

4.4 VEGETATION OBSERVATIONS & CONCLUSIONS

After construction of the mitigation site, a permanent ground cover seed mixture of Virginia wild rye (*Elymus virginicus*), switch grass (*Panicum virgatum*), and fox sedge (*Carex vulpinoidea*) was broadcast on the site at a rate of 10 pounds per acre. These species are present on the site. Hydrophytic herbaceous vegetation, including rush (*Juncus effusus*), spike-rush (*Eleocharis obtusa*), boxseed (*Ludwigia spp.*), false nettle (*Boehmeria cylindrica*), and sedge (*Carex spp.*), are observed across the site, particularly in areas of periodic inundation. There is a population of swamp thistle (*Cirsium muticus*) that is commonly found in boggy woodland and meadows the piedmont present throughout the site. The presence of these herbaceous wetland plants helps to confirm the presence of wetland hydrology on the site.

There are quite a few weedy species occurring on the site, though none seem to be posing any problems for the woody or herbaceous hydrophytic vegetation. Commonly seen weedy vegetation includes asters, goldenrod (*Solidago spp.*), broomsedge (*Andropogon spp.*), ragweed (*Ambrosia artemisiifolia*) and wild dill (*Foeniculum vulgare*). Any threatening weedy vegetation found in the future will be documented and discussed in future reports.

The site was planted in bottomland hardwood forest species in January 2006. There were thirteen vegetation-monitoring plots established throughout the planting areas. The data for Year 4 (2009) documents that the site has a density of surviving planted stems of 440 to 680 stems per acre and is on track to achieve the final success criteria of 260 trees per acre by the end of year five.

5.0 STREAM MONITORING

5.1 STREAM SUCCESS CRITERIA

As stated in the approved Restoration Plan, the stream restoration success criteria for the site includes the following:

- *Bankfull Events:* Two bankfull flow events must be documented within the five-year monitoring period.
- *Cross sections:* There should be little change in as-built cross sections. Cross sections shall be classified using the Rosgen stream classification method and all monitored cross sections should fall within the quantitative parameters defined for "E" or "C" type channels.

- *Longitudinal Profiles:* The longitudinal profiles should show that the bedform features are remaining stable, e.g. they are not aggrading or degrading. Bedforms observed should be consistent with those observed in "E" and "C" type channels.
- *Photo Reference Stations:* Photographs will be used to subjectively evaluate channel aggradation or degradation, bank erosion, success of riparian vegetation and effectiveness of erosion control measures.

5.2 STREAM MORPHOLOGY MONITORING PLAN

To document the stated success criteria, the following monitoring program was instituted following construction completion on the Jones Creek Site:

5.2.1 Cross Sections

Two permanent cross sections were installed per 1,000 linear feet of stream restoration work, with one of the locations being a riffle cross section and one location being a pool cross section. A total of 6 permanent cross sections were established across the mitigation site. Each cross section was marked on both banks with permanent pins to establish the exact transect used. Permanent cross section pins were surveyed and located relative to a common benchmark to facilitate easy comparison of year-to-year data. The annual cross section surveys include points measured at all breaks in slope, including top of bank, bankfull, inner berm, edge of water, and thalweg. Riffle cross sections are classified using the Rosgen stream classification system. Permanent cross sections for 2009 (Year 4) were surveyed in September 2009.

5.2.2 Longitudinal Profile

A longitudinal profile of approximately 3,000 feet was surveyed along the restoration reaches in Year 1. The longitudinal survey will take place in Years 3, 4, and 5 as well. Measurements include thalweg, water surface, bankfull, and top of low bank. Each of these measurements is taken at the head of each feature, e.g. riffle, run, pool, and glide, and the max pool depth. A common benchmark will be used each year to facilitate comparison of year-to-year data. A longitudinal profile survey was conducted in September of 2009.

5.2.3 Hydrology

Two crest gauges were installed on the site to document bankfull events (**Figure 3**). The gauges are checked monthly, and record the highest out-of-bank flow event that occurred during the past month.

5.2.4 Photo Reference Stations

Photographs are used to visually document restoration success. Reference stations are marked with wooden stakes and Global Positioning Satellite (GPS) coordinates have been determined for each location. Reference photos are taken at each permanent cross section from both streambanks. The survey tape is centered in the photographs of the bank, and the water line is located in the lower edge of the frame with as much of the bank as possible included in each photo. In-stream structures (e.g., rock vanes, cross vanes, and constructed riffles) are also photographed. Photo reference stations will be photographed at least once per year for at least 5 years following construction.

5.3 STREAM MORPHOLOGY MONITORING RESULTS

5.3.1 Cross Sections

The cross sections were surveyed during the monitoring set-up, Year 1, Year 2, Year 3, and in September 2009 for Year 4. The baseline data has been compared with the Year 1, Year 2, Year 3, and Year 4 monitoring data in **Appendix B**. Compared to the documented data from the As-

Built and Years 1-3, the Year 4 channel cross sections showed that overall stream dimensions remained stable during the fourth growing season. Very little bank erosion was noted in Year 4; however, noticeable sediment accumulation was present in the pools on Mill Branch.

Cross Section 3 and Cross Section 6 on Mill Branch have aggraded approximately 1 foot from their as-built conditions. All other cross sections are stable and have reached equilibrium. Both aggrading cross sections continue to provide pool habitat and are not vegetated. Cross Section 3 aggraded approximately 1 foot between Year 1 and Year 2. From Year 2 to Year 4, Cross Section 3 aggradation slowed and totaled approximately 0.5 feet. Cross Section 6 aggradation has also slowed and the Year 4 survey shows only 0.2 feet of aggradation from Year 3. Both of these pools are dynamic and have shown scour and deposition over the four year monitoring period. That dynamic activity is expected and will continue as deposition occurs between larger storms that then scour the pool features. The aggradation in Mill Branch is minor and is not a threat to the integrity of the stream restoration.

5.3.2 Longitudinal Profile

A longitudinal profile survey was conducted along two separate reaches of the restoration project, totaling approximately 3,000 linear feet. Survey was conducted for the entire length of both Mill Branch (STA 10+06.44 to STA 28+61.24), and UT1 (STA 10+00 to STA 22+12.76). The longitudinal profile information documents the elevations and locations of known streambed features and in-stream grade control structures according to the As-Built survey plans, as shown in **Appendix A**. The profile and cross sections show that there has been very little adjustment to stream profile or dimension since construction. **Table 9** summarizes stream areas requiring observation. **Figure 7** show the locations of the stream areas that require observation.

Table 9. Stream Areas Requiring Observation

SPA	Station	Description/Recommendation
1	UT1 20+25	Left and Right bank erosion around Log Weir; minor headcut, bank repair is recommended to prevent future erosion.

5.3.3 Hydrology

During the 2009 monitoring season, two crest gauges were monitored to determine if there were any out-of-bank flow events in the Mill Branch and UT1 stream channels. No bankfull events occurred between the months of February and September for the Year 4 monitoring season (**Table 10**). The hydrology success criteria have already been satisfied by bankfull events in previous monitoring years.

Table 10. Crest Gauge Data

Month Recorded	Crest Gauge 1	Crest Gauge 2
January	---	---
February	0.0	0.0
March	0.0	0.0
April	0.0	0.0
May	0.0	0.0
June	0.0	0.0
July	0.0	0.0
August	0.0	0.0
September	0.0	0.0
October		
November		
December		

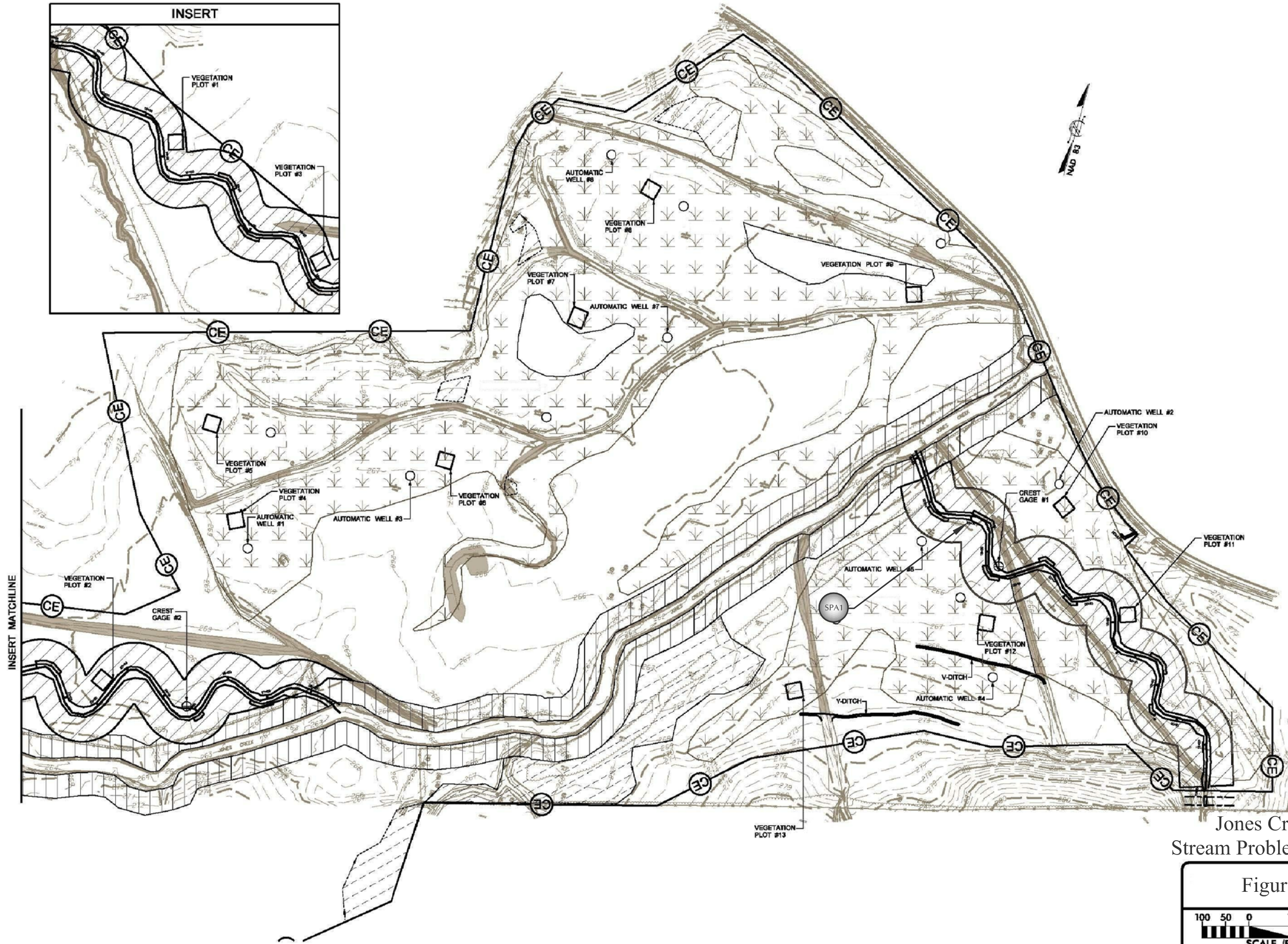
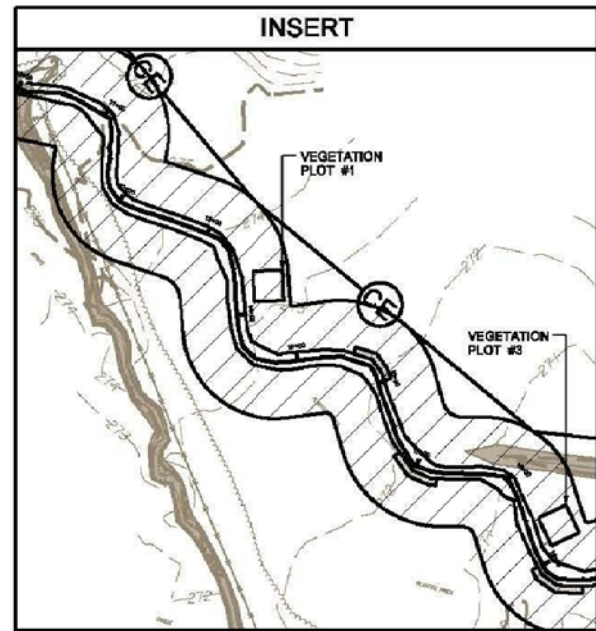

Jones Creek
Stream Problem Areas

Figure 7

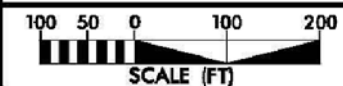

Table 11. Summary of Morphologic Monitoring Parameters

Parameter	As-Built UT1	As-Built Mill Branch	Year 4 UT1	Year 4 Mill Branch
Bankfull Xsec Area, Abkf (sq ft)	20.3	19.1	24.4	20.2
Avg. Bankfull Width, Wbkf (ft)	17.7	16.1	17.2	20.1
Bankfull W/D	15.4	13.5	12.2	20.3
Bankfull Mean Depth, Dbkf (ft)	1.1	1.2	1.4	1.0
Bankfull Max Depth, Dmax (ft)	2.0	2.1	2.1	2.3

5.4 STREAM CONCLUSIONS

In-stream structures installed within the restored stream included constructed riffles, log vanes, log weirs, rock step pools, J-hooks, rock cross vane, and root wads. Visual observations of structures throughout the 2009 growing season indicated that most structures are functioning as designed. One log weir on UT1 has continued to wash out. A headcut has formed just downstream of this structure and there is evidence of bank erosion on both banks. It is recommended that the banks be repaired to prevent future erosion at the log weir.

6.0 CONCLUSIONS AND RECOMMENDATIONS

- Fourth year hydrologic monitoring documented that exceptionally wetland hydrology conditions have been achieved on most of the site. Of the 19 hydrology monitoring gauges, 17 recorded hydroperiods of at least 7 percent of the growing season. The two remaining gauges recorded hydroperiods of 1 and 2 percent of the growing season. Based on the results of the past four years of monitoring, the site appears to be performing as designed and within the range of conditions expected in the floodplain wetlands.
- A 2009 hydrology assessment identified 1.73 acres of additional restored wetlands located within the conservation easement. These areas contained hydrophytic vegetation, hydric soils, and indicators of wetland hydrology.
- Stream morphology data collected during monitoring Year 4 and observations of conditions at the site indicate that the project continues to be successful. The stream morphology is relatively stable. Most in-stream structures appear stable; however, the left and right banks on of one log weir in UT1 (Sta. 20+25) are becoming washed out. It was concluded that the site continues to be on track to achieve the stream success criteria specified in the Restoration Plan.
- Vegetation monitoring efforts have documented the average number of stems per acre on site to be 560, which is a survival rate of greater than 81 percent based on the initial planting count of 689 stems per acre. The range of density of surviving planted stems is 440 to 680 stems per acre. Vegetation survivability should remain excellent on site. The initial vegetative success criteria has been met and the site is on track to achieve the first vegetative success criteria at the end of monitoring year five.
- Monitoring of wetland, stream and vegetation conditions will continue through the 2010 season (Year 5).

APPENDIX A

As-Built Survey

PROJECT: 0215R JONES CREEK

STREAM AND WETLAND RESTORATION PROJECT
 EBX NEUSE - I, LLC
 JONES CREEK AS-BUILT PLAN

STATE	BUCK PROJECT REFERENCE NO.	SHEET NO.	TOTAL SHEETS
NC	0215R	1	11
NO.	DATE	CHECKED BY	APPROVED BY
1	2/28/06	J. HUTTON	K. TWEEDY

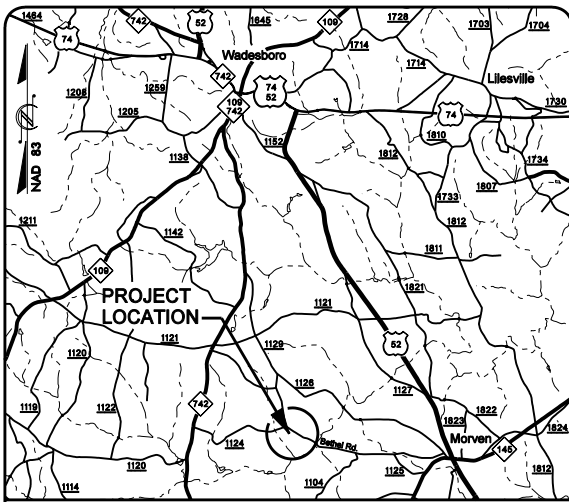

VICINITY MAP

ANSON COUNTY

LOCATION: 2 MILES WEST OF MORVEN OFF BETHEL RD.
 (SR 1129; ROBINSON BRIDGE RD.)

- INDEX OF SHEETS**
- 1 TITLE SHEET
 - 1-A SYMBOLOGY - BUCK ENGINEERING VEGETATION SELECTION, AND STANDARD SPECIFICATIONS
 - 1-B SYMBOLOGY - NCDOT
 - 2 THRU 2-C STRUCTURE DETAILS
 - 3 THRU 4 PLAN SHEETS
 - 5 WETLAND AND MONITORING OVERVIEW
 - 6 REVEGETATION

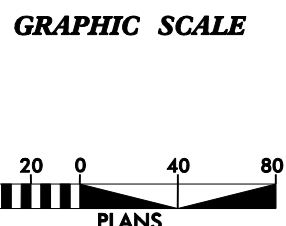
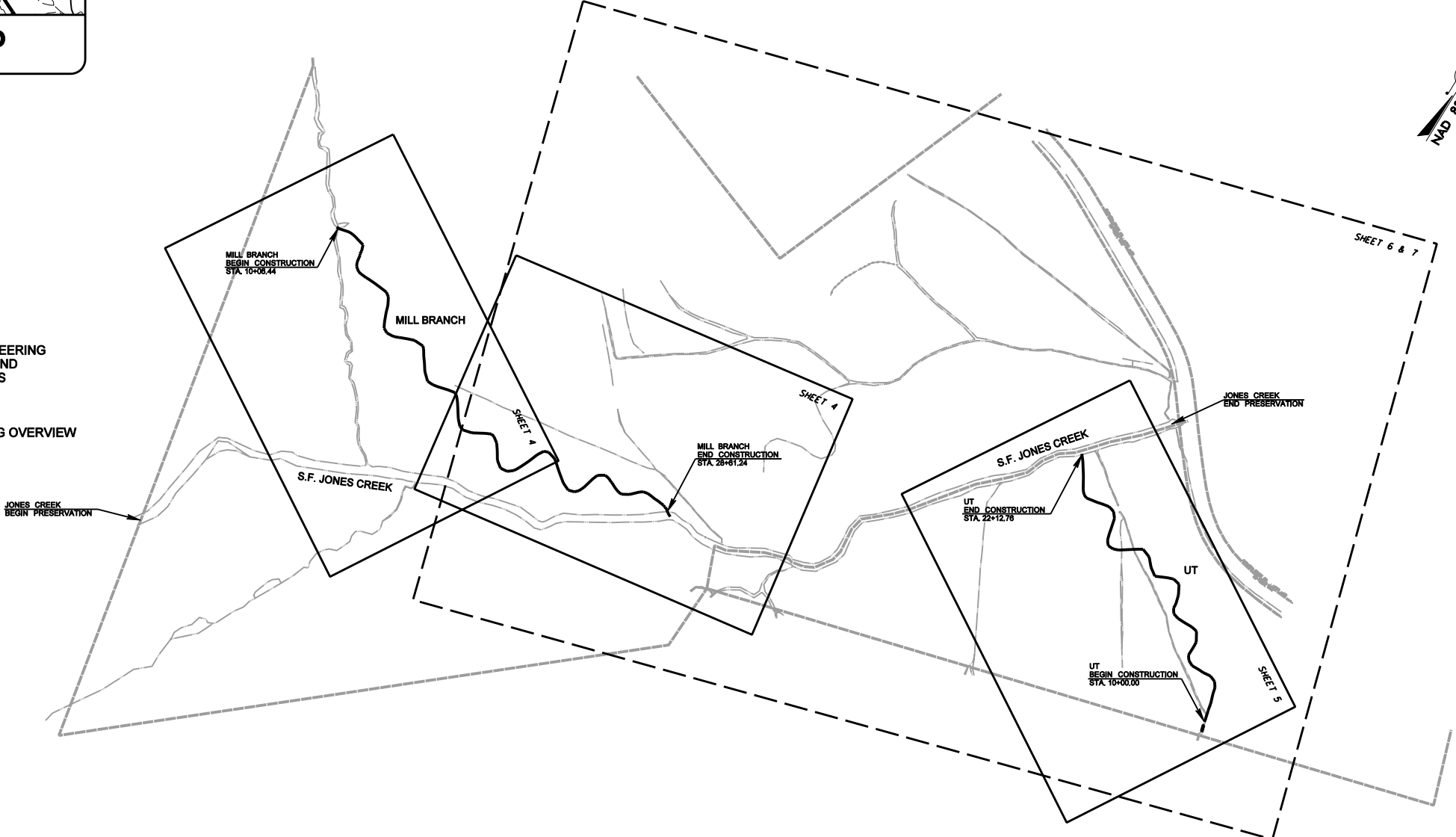

PROJECT SUMMARY

EXISTING STREAM LENGTH	=	1825 FEET
RESTORED MILL BRANCH LENGTH	=	1855 FEET
RESTORED UT LENGTH	=	1213 FEET
RESTORED STREAM LENGTH	=	3068 FEET
PRESERVATION STREAM LENGTH	=	5150 FEET
RESTORED WETLAND AREA	=	25.0 ACRES
ENHANCED WETLAND AREA	=	2.7 ACRES

PREPARED FOR THE OFFICE OF:
EBX NEUSE - I, LLC

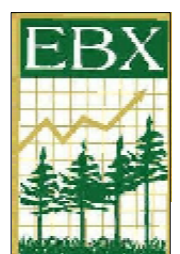

2530 MERIDIAN PARKWAY, SUITE 200
 DURHAM, NORTH CAROLINA 27713

EBX CONTACT:
THOMAS L. RINKER
 PROJECT MANAGER

PREPARED IN THE OFFICE OF:
BUCK ENGINEERING

8000 Regency Parkway, Suite 200
 Cary, North Carolina 27511
 Phone: 919-463-5488
 Fax: 919-463-5490

DECEMBER 2005
 COMPLETION DATE:

KEVIN TWEEDY, PE
 PROJECT ENGINEER /MANAGER













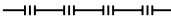







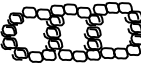



PROJECT ENGINEER

THIS DOCUMENT ORIGINALLY ISSUED AND SEALED BY:
 KEVIN L. TWEEDY
 027337
 APRIL 4, 2006

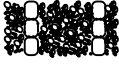
THIS MEDIA SHALL NOT BE CONSIDERED A CERTIFIED DOCUMENT

SIGNATURE: _____ P.E.

STREAM CONVENTIONAL SYMBOLS
SUPERCEDES SHEET 1B

	LOG VANE		BOULDER CLUSTER
	LOG WEIR		SILT FENCE
	ROOT WAD		SAFETY FENCE
	LOG CROSS VANE		CONSERVATION EASEMENT
	J-HOOK		TRANSPLANTED VEGETATION
	ROCK VANE		ROCK STEP POOL
	TEMPORARY SILT CHECK		TREE REMOVAL
	FOOT BRIDGE		TREE PROTECTION
	TEMPORARY STREAM CROSSING		PLAY GROUND EQUIPMENT
	PERMANENT STREAM CROSSING		
	ROCK CROSS VANE		CONSTRUCTED RIFFLE
	WING DEFLECTOR		TRANSPLANTS
	DOUBLE WING DEFLECTOR		FILL EXISTING CHANNEL
	DOUBLE DROP CROSS VANE		CONTROL POINT

STANDARD SPECIFICATIONS

EROSION AND SEDIMENT CONTROL PLANNING AND DESIGN MANUAL
DECEMBER 1993

- 6.60 TEMPORARY SEDIMENT TRAP
- 6.06 CONSTRUCTION ACCESS
- 6.62 SILT FENCE
- 6.70 TEMPORARY (FORD) STREAM CROSSING

PROJECT REFERENCE NO. 0215R	SHEET NO. 1-A
PROJECT ENGINEER	
THIS DOCUMENT ORIGINALLY ISSUED AND SEALED BY:	
KEVIN L. TWEEDY 027337 APRIL 4, 2006	
THIS MEDIA SHALL NOT BE CONSIDERED A CERTIFIED DOCUMENT	
	
8000 Regency Parkway Suite 200 Cary, North Carolina 27511 Phone: 919-463-5488 Fax: 919-463-5490	

GENERAL NOTES

- The Contractor is required to install instream structures using a track hoe with a hydraulic thumb of sufficient size to move boulders 3ft X 3ft X 2ft (approximately 2 tons).
- The Contractor will be required to provide, at a minimum, two operators at all times during construction of the new stream channel. In general, one operator will cut the new channel with a track hoe, while the other operator follows and installs instream structures, bank stabilization practices, and transplants. During construction of the new stream channel, the contractor will be required to have two track hoes and one loader on-site.

VEGETATION SELECTION

BARE ROOT VEGETATION		
ZONE 1 (Wetland Restoration and Enhancement Areas)		
COMMON NAME	SCIENTIFIC NAME	PERCENT PLANTED BY SPECIES
SWAMP CHESTNUT OAK	<i>Quercus michauxii</i>	14 %
BLACK WILLOW	<i>Salix nigra</i>	5 %
GREEN ASH	<i>Fraxinus pennsylvanica</i>	13 %
RIVER BIRCH	<i>Betula nigra</i>	14 %
BLACK GUM	<i>Nyssa sylvatica</i>	14 %
WILLOW OAK	<i>Quercus phellos</i>	20 %
SYCAMORE	<i>Platanus occidentalis</i>	20 %
ZONE 2 and 3 (Stream Restoration Buffer)		
SYCAMORE	<i>Platanus occidentalis</i>	21 %
RIVER BIRCH	<i>Betula nigra</i>	21 %
HACKBERRY	<i>Celtis laevigata</i>	13 %
SWAMP CHESTNUT OAK	<i>Quercus michauxii</i>	13 %
GREEN ASH	<i>Fraxinus pennsylvanica</i>	21 %
TULIP POPLAR	<i>Liriodendron tulipifera</i>	11 %

LIVE STAKE VEGETATION		
NOTE: Live stakes were installed randomly 2 to 3 feet apart along the streambanks from the toe of the bank to the top of the bank.		
COMMON NAME	SCIENTIFIC NAME	NUMBER PLANTED
SILKY DOGWOOD	<i>Cornus Amomum</i>	900
BLACK WILLOW	<i>Salix nigra</i>	900
ELDERBERRY	<i>Sambucus canadensis</i>	900

PERMANENT SEED MIXTURE				
ZONE 1, 2, and 3				
COMMON NAME	SCIENTIFIC NAME	PERCENT OF MIXTURE	SEEDING DENSITY (lbs/acre)	WETNESS TOLERANCE
REDTOP	<i>Agrostis alba</i>	10 %	1.5	FACW
VIRGINIA WILDRYE	<i>Elymus virginicus</i>	15 %	2.25	FAC
SWITCHGRASS	<i>Panicum virgatum</i>	15 %	2.25	FAC+
EASTERN GAMMA GRASS	<i>Tripsicum dactyloides</i>	5 %	0.75	FAC+
PENNSYLVANIA SMARTWEED	<i>Polygonum pennsylvanicum</i>	5 %	0.75	FACW
LITTLE BLUE STEM	<i>Schizachyrium scoparium</i>	5 %	0.75	FACU
SOFT RUSH	<i>Juncus effusus</i>	5 %	0.75	FACW+
BEGGARS TICK	<i>Bidens frondosa (or aristosa)</i>	10 %	1.5	FACW
LANCE-LEAVED TICK SEED	<i>Coreopsis lanceolata</i>	10 %	1.5	FACU
TIOGA DEER TONGUE	<i>Panicum clandestinum</i>	10 %	1.5	FAC
BIG BLUE STEM	<i>Andropogon gerardii</i>	5 %	0.75	FAC
INDIAN GRASS	<i>Sorghastrum nutans</i>	5 %	0.75	FACU
TEMPORARY SEED MIXTURE				
NOTE: Temporary seeding were applied to all disturbed areas of the site that were susceptible to erosion. These areas included constructed streambanks, access roads, side-slopes, spoil piles, etc. Rye grain was used and applied at a rate of 130 lbs/acre.				

TYPICAL STRUCTURE PLACEMENT

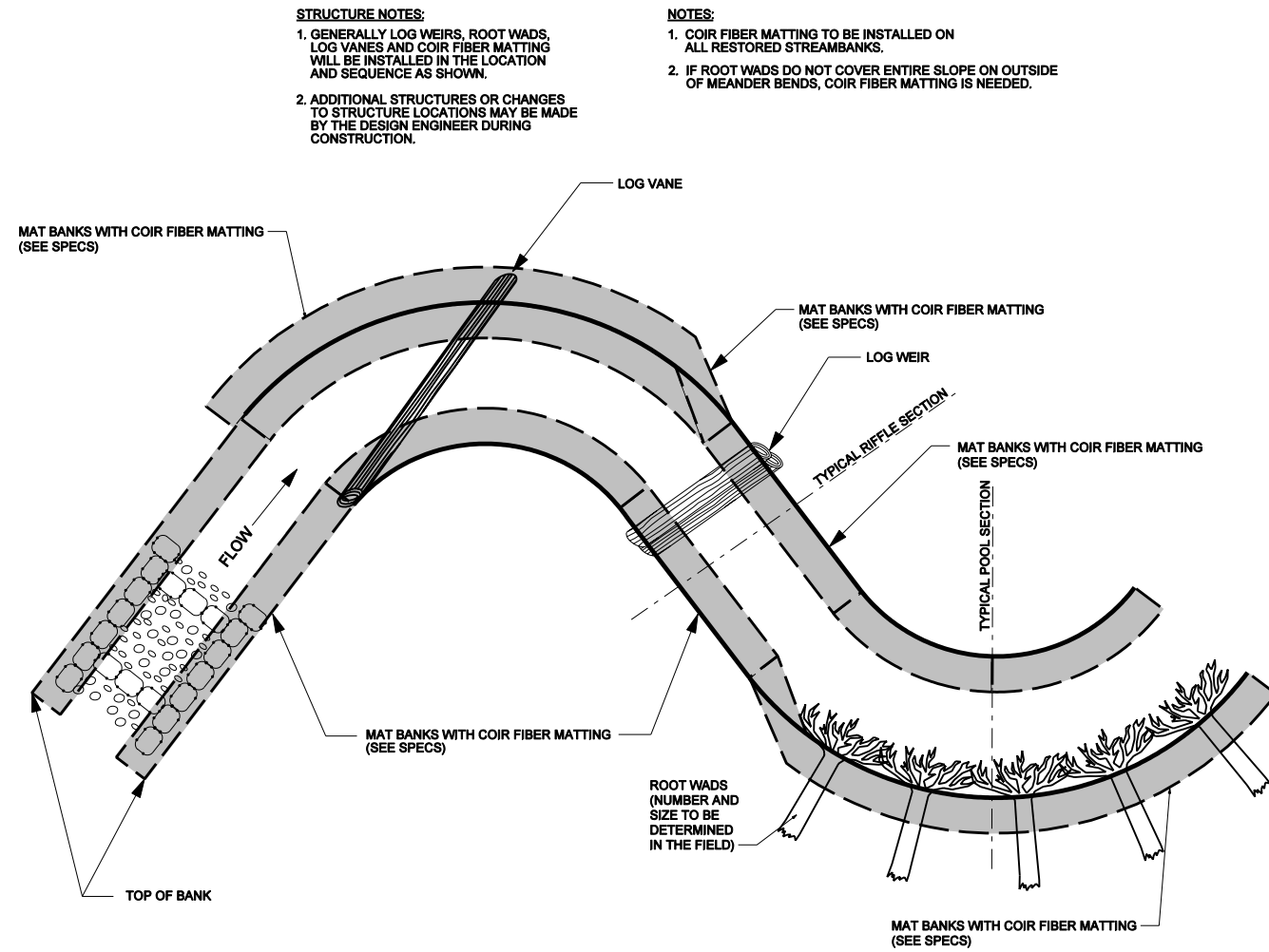

LOG WEIR

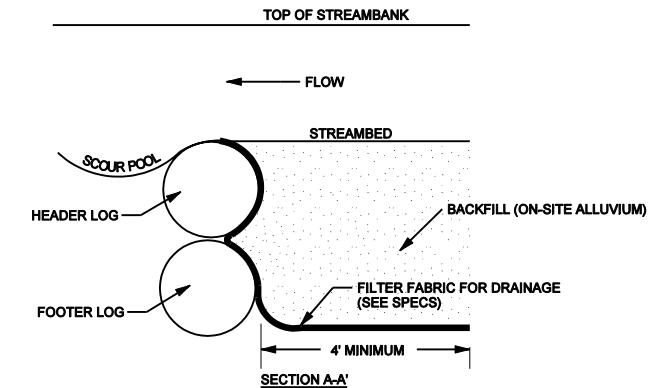
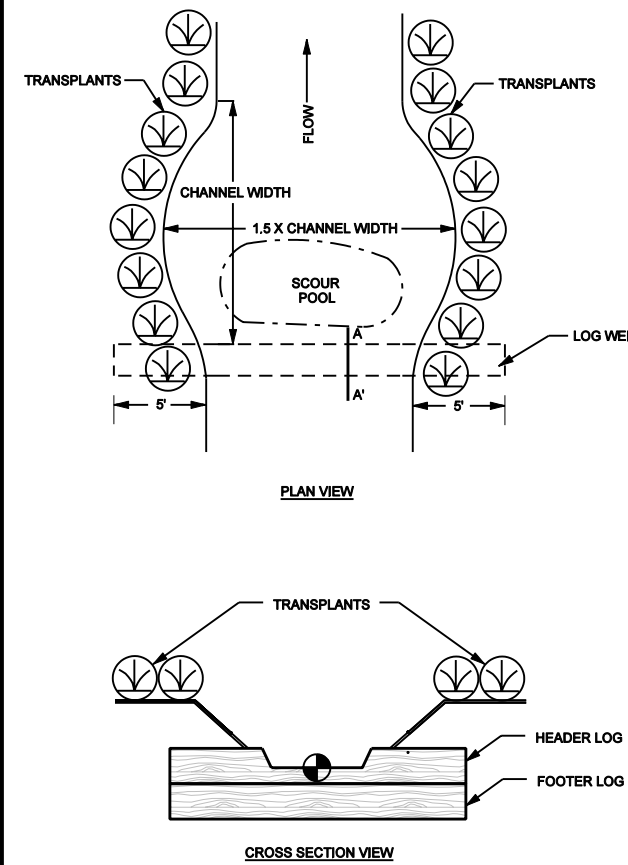

- NOTES:**
- LOGS SHOULD BE AT LEAST 12 INCHES IN DIAMETER, RELATIVELY STRAIGHT, HARDWOOD, AND RECENTLY HARVESTED.
 - LOGS >24 INCHES IN DIAMETER MAY BE USED ALONE WITHOUT AN ADDITIONAL LOG. FILTER FABRIC SHOULD STILL BE USED TO SEAL AROUND LOG.
 - PLACE FOOTER LOGS FIRST AND THEN HEADER (TOP) LOG. SET HEADER LOG APPROXIMATELY 3 INCHES ABOVE THE INVERT ELEVATION.
 - CUT A NOTCH IN THE HEADER LOG APPROXIMATELY 50 PERCENT OF THE CHANNEL BOTTOM WIDTH AND EXTENDING DOWN TO THE INVERT ELEVATION.
 - USE FILTER FABRIC FOR DRAINAGE TO SEAL GAPS BETWEEN LOGS.
 - PLACE TRANSPLANTS FROM TOE OF STREAMBANK TO TOP OF STREAMBANK.

TYPICAL RIFFLE, POOL, AND BANKFULL BENCH CROSS SECTIONS

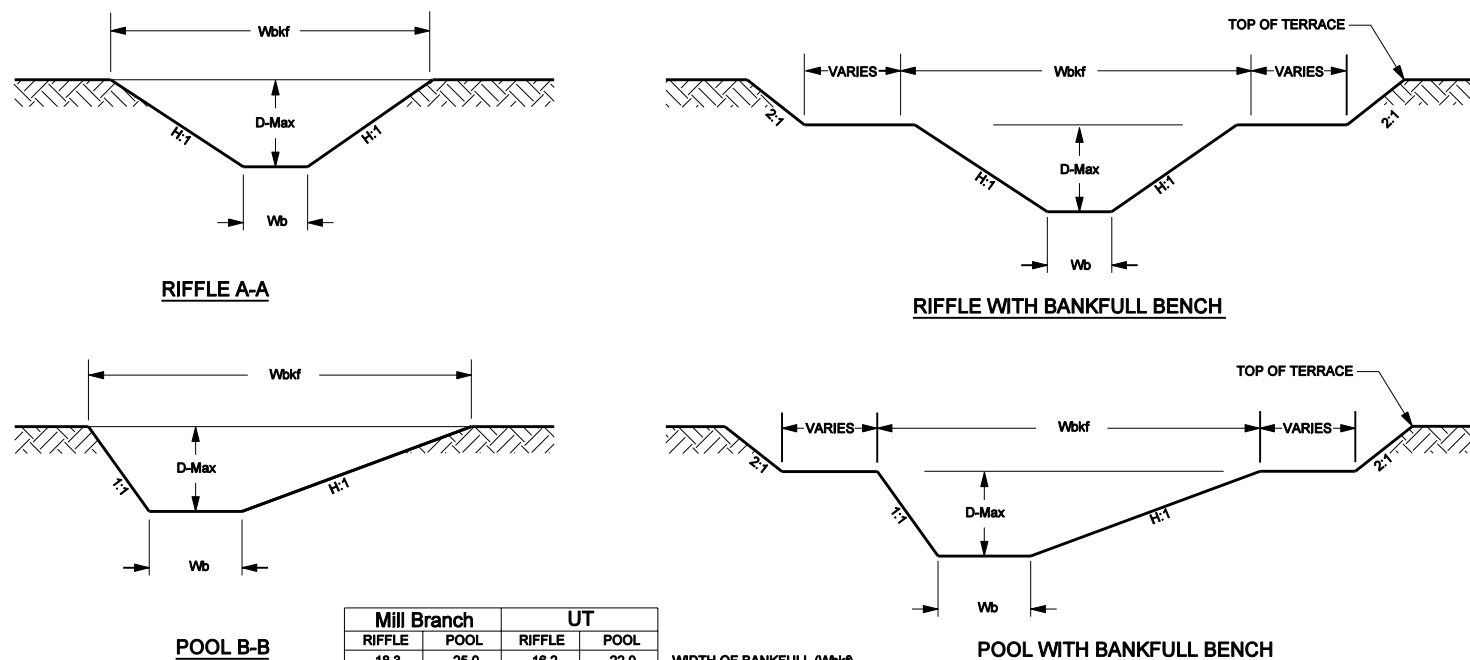

Mill Branch		UT	
RIFFLE	POOL	RIFFLE	POOL
18.3	25.0	16.2	22.0
1.5	2.1	1.4	1.8
2.1	3.6	1.9	3.1
12.0	11.9	12.0	12.3
28.0	52.4	22.0	39.4
8.9	4.1	6.6	3.4
2.3	4.8	2.5	5.0

- NOTES:**
- DURING CONSTRUCTION CORNERS OF DESIGN CHANNEL WILL BE ROUNDED AND A THALWEG WILL BE SHAPED PER DIRECTION OF ENGINEER.
 - POOLS SHOWN ABOVE ARE LEFT POOLS ONLY.

LOG VANE

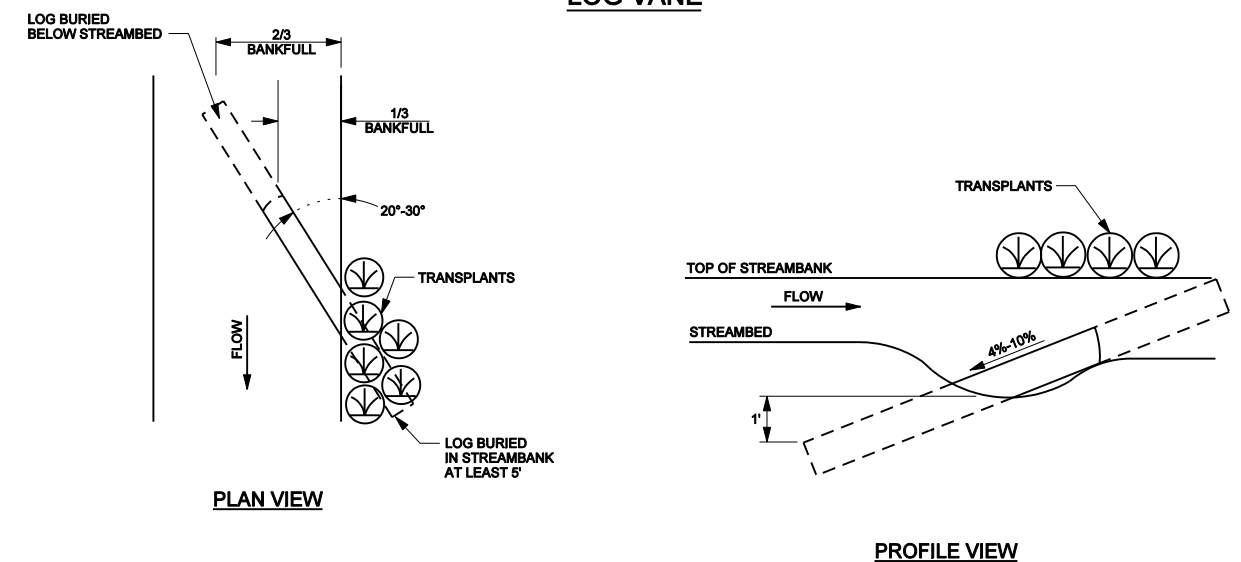

- NOTES:**
- LOGS SHOULD BE AT LEAST 10" IN DIAMETER, RELATIVELY STRAIGHT, HARDWOOD, AND RECENTLY HARVESTED.
 - SOIL SHOULD BE COMPACTED WELL AROUND BURIED PORTIONS OF LOG.
 - TRANSPLANTS ARE PLACED ALONG THE TOP OF THE BANK OVER THE BURIED LOG VANE TO PROTECT AGAINST EROSION DURING HIGH FLOWS.

2/26/03
 4/12/2006
 F:\215R\Design\As_Buil\0215_EBX_PSH_AB_2.dgn

TRANSPLANTED VEGETATION

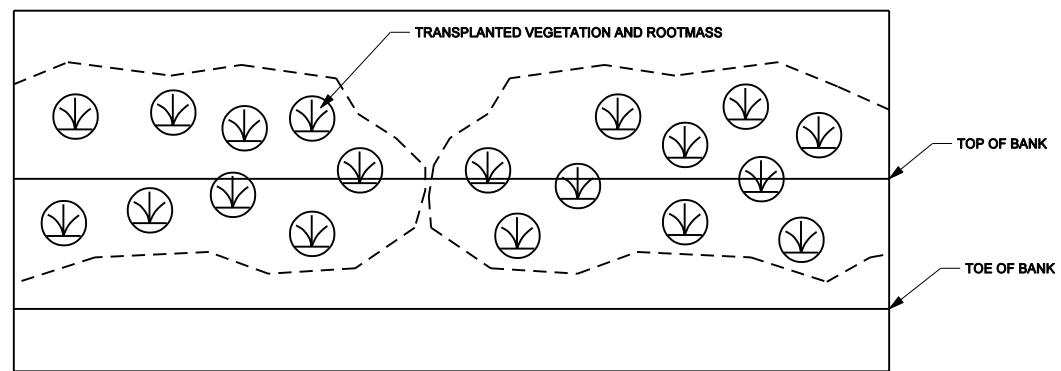

PLAN VIEW

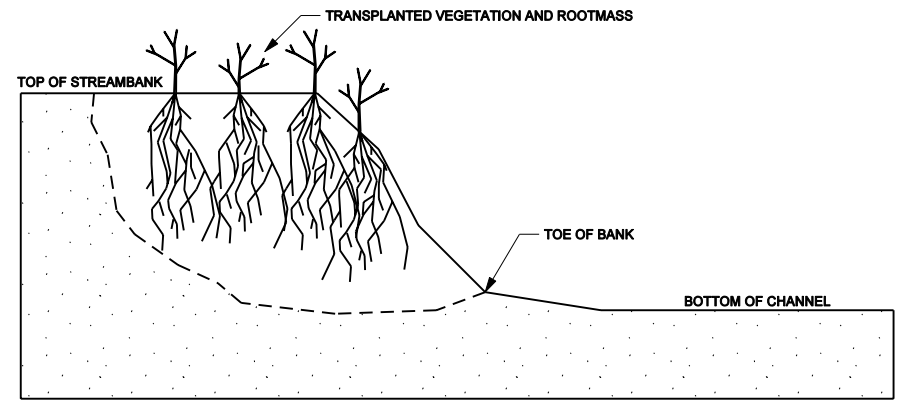

CROSS SECTION VIEW

- NOTES:**
1. EXCAVATE A HOLE IN THE BANK TO BE STABILIZED THAT WILL ACCOMMODATE THE SIZE OF TRANSPLANT TO BE PLACED. BEGIN EXCAVATION AT THE TOE OF THE BANK.
 2. EXCAVATE TRANSPLANT USING A FRONT END LOADER. EXCAVATE THE ENTIRE ROOT MASS AND AS MUCH ADDITIONAL SOIL MATERIAL AS POSSIBLE. IF ENTIRE ROOT MASS CANNOT BE EXCAVATED IN ONE BUCKET LOAD, THE TRANSPLANT IS TOO LARGE AND ANOTHER SHOULD BE SELECTED.
 3. PLACE TRANSPLANT IN THE BANK TO BE STABILIZED SO THAT VEGETATION IS ORIENTATED VERTICALLY.
 4. FILL IN ANY HOLES AROUND THE TRANSPLANT AND COMPACT.
 5. ANY LOOSE SOIL LEFT IN THE STREAM SHOULD BE REMOVED.
 6. PLACE MULTIPLE TRANSPLANTS CLOSE TOGETHER SUCH THAT THEY TOUCH.

CONSTRUCTED RIFFLE

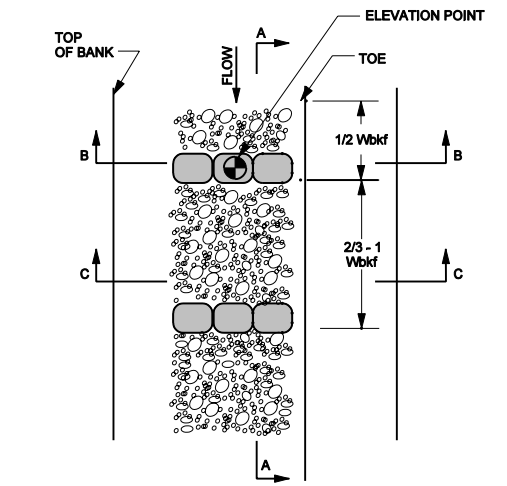

PLAN VIEW

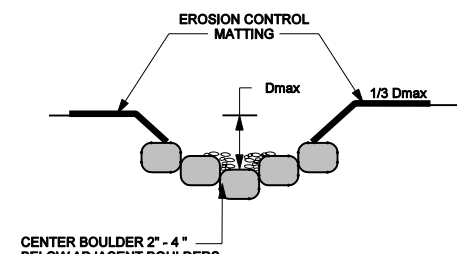

SECTION B - B

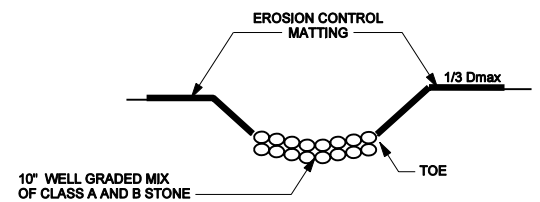

SECTION C - C

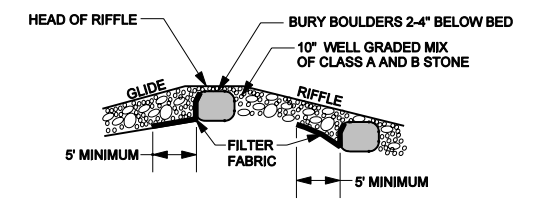

PROFILE A - A

REACH	Mill Branch	UT
Wbkf (ft)	18.3	16.2
Dmax (ft)	2.1	1.9

ROOT WADS WITHOUT TRANSPLANTS

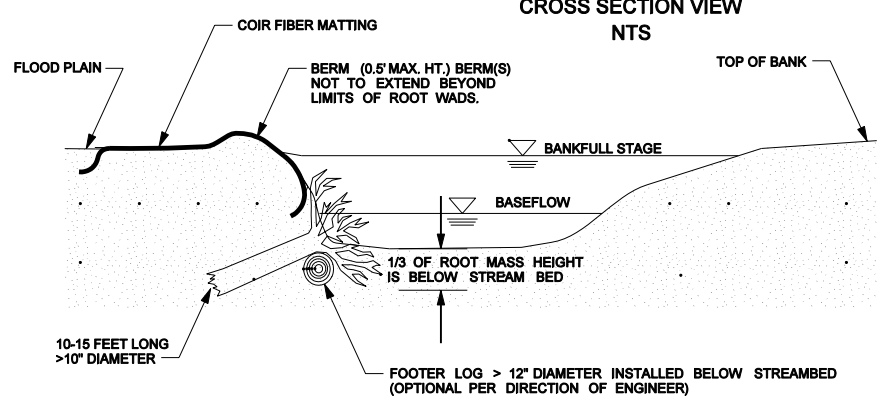

ROOT WADS WITH TRANSPLANTS

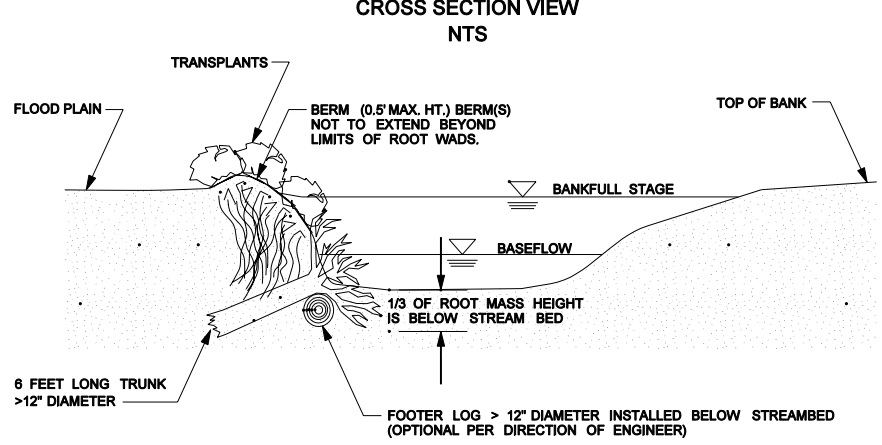

ROOT WADS

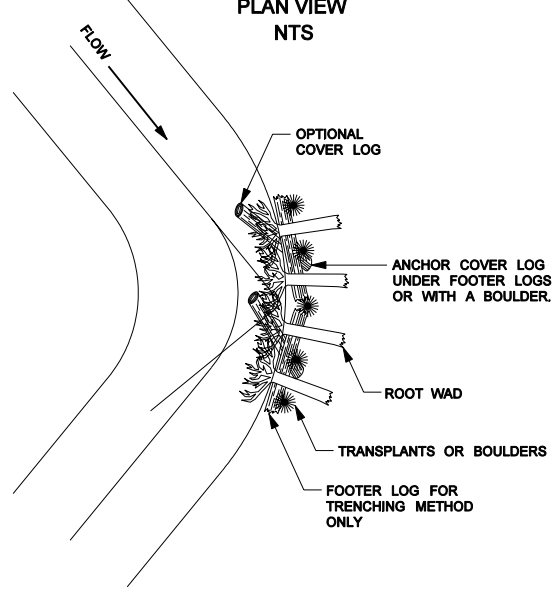

- NOTES:**
- TRENCHING METHOD:**
IF THE ROOT WAD CANNOT BE DRIVEN INTO THE BANK OR THE BANK NEEDS TO BE RECONSTRUCTED THE TRENCHING METHOD SHOULD BE USED. THIS METHOD REQUIRES THAT A TRENCH BE EXCAVATED FOR THE LOG PORTION OF THE ROOT WAD. IN THIS CASE, A FOOTER LOG SHOULD BE INSTALLED UNDERNEATH THE ROOT WAD IN A TRENCH EXCAVATED PARALLEL TO THE BANK AND WELL BELOW THE STREAMBED. ONE-THIRD OF THE ROOT WAD SHOULD REMAIN BELOW NORMAL BASE FLOW CONDITIONS.
- DRIVE POINT METHOD:**
SHARPEN THE END OF THE LOG WITH A CHAINSAW BEFORE "DRIVING" IT INTO THE BANK. ORIENT ROOT WADS UPSTREAM SO THAT THE STREAM FLOW MEETS THE ROOT WAD AT A 90-DEGREE ANGLE, DEFLECTING THE WATER AWAY FROM THE BANK. A TRANSPLANT OR BOULDER SHOULD BE PLACED ON THE DOWNSTREAM SIDE OF THE ROOT WAD IF A BACK EDDY IS FORMED BY THE ROOT WAD. THE BOULDER SHALL BE APPROXIMATELY 4' X 2'.

DOUBLE DROP ROCK CROSS VANE

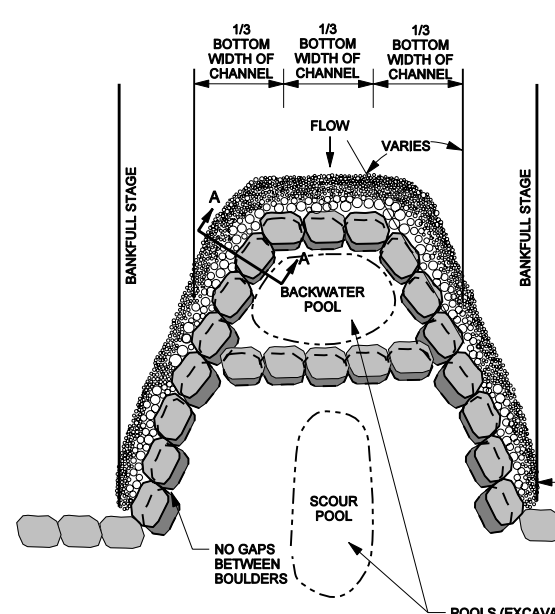

PLAN VIEW

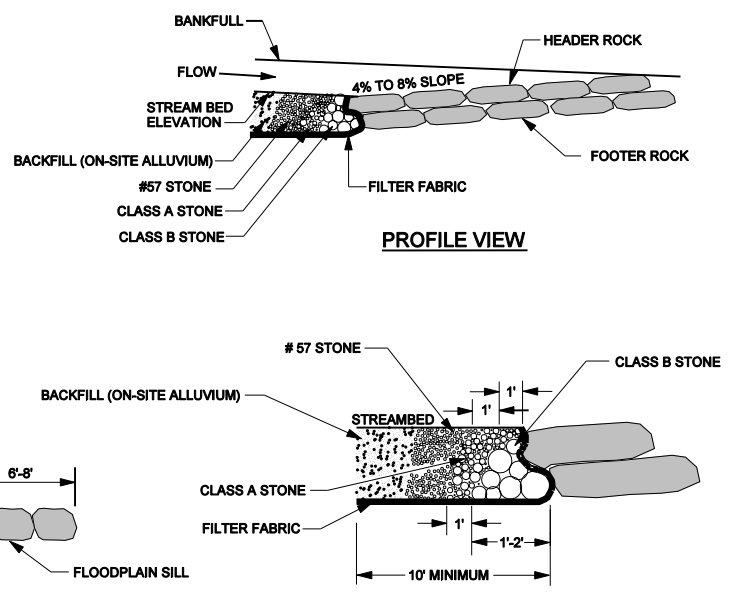

SECTION A - A

1. BOULDERS MUST BE AT LEAST 2' x 2' x 3'.
2. INSTALL FILTER FABRIC FOR DRAINAGE BEGINNING AT THE MIDDLE OF THE HEADER ROCKS AND EXTEND DOWNWARD TO THE DEPTH OF THE BOTTOM FOOTER ROCK, AND THEN UPSTREAM TO A MINIMUM OF TEN FEET.
3. DIG A TRENCH BELOW THE BED FOR FOOTER ROCKS AND PLACE FILL ON UPSTREAM SIDE OF VANE ARM, BETWEEN THE ARM AND STREAM BANK.
4. START AT BANKFULL AND PLACE FOOTER ROCKS FIRST AND THEN HEADER (TOP) ROCK.
5. CONTINUE WITH STRUCTURE, FOLLOWING ANGLE AND SLOPE SPECIFICATIONS.
6. AN EXTRA BOULDER CAN BE PLACED IN SCOUR POOL FOR HABITAT IMPROVEMENT.
7. USE CLASS B STONE TO FILL GAPS ON UPSTREAM SIDE OF BOULDERS, AND CLASS A STONE TO FILL GAPS ON DOWNSTREAM SIDE OF CLASS B STONE.
8. AFTER ALL STONE HAS BEEN PLACED, FILL IN THE UPSTREAM SIDE OF THE STRUCTURE WITH ON-SITE ALLUVIUM TO THE ELEVATION OF THE TOP OF THE HEADER ROCK.

2/26/03

4/12/2006 Design_Vas_Bu11\0215_EBX_PSH_AB_2A.dgn

DITCH PLUG

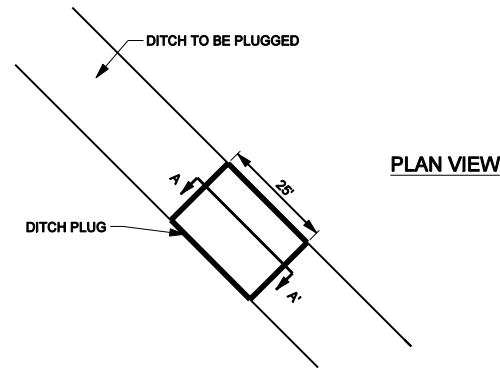

NOTE:
COMPACT BACKFILL USING ON-SITE HEAVY EQUIPMENT
IN 10 INCH LIFTS.

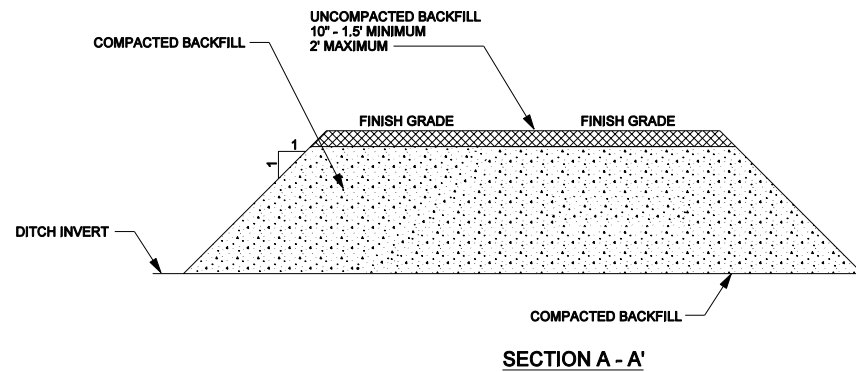

STANDARD "V" DITCH

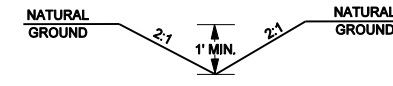

STANDARD 'V' DITCH (TYPE B)

- NOTES:**
1. BANKS OF TYPE B DITCHES PROTECTED WITH STRAW, TEMPORARY AND PERMANENT SEEDING.
 2. TYPE B DITCHES TO BE CONSTRUCTED WITH AS LITTLE SLOPE AS POSSIBLE.
 3. SPOIL FROM DITCHES TO BE USED IN FILLING OLD CHANNEL OR SPREAD EVENLY OVER UPSLOPE AREAS.

LIVE STAKING

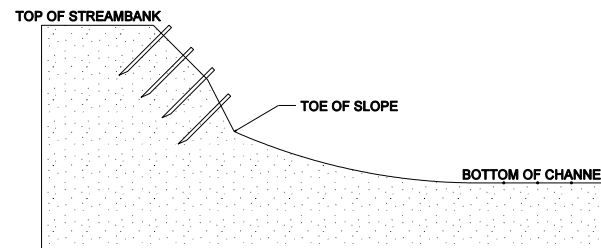

CROSS SECTION VIEW

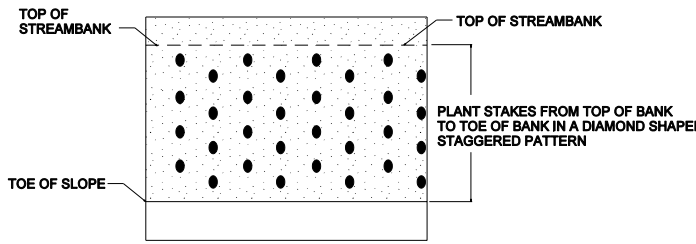

PLAN VIEW

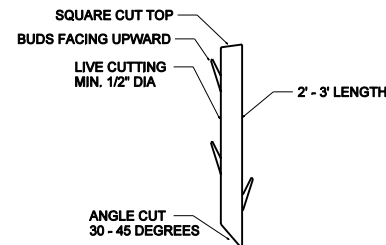

LIVE STAKE DETAIL

- NOTES:**
1. STAKES SHOULD BE CUT AND INSTALLED ON THE SAME DAY.
 2. DO NOT INSTALL STAKES THAT HAVE BEEN SPLIT.
 3. STAKES MUST BE INSTALLED WITH BUDS POINTING UPWARDS.
 4. STAKES SHOULD BE INSTALLED PERPENDICULAR TO BANK.
 5. STAKES SHOULD BE 1/2 TO 2 INCHES IN DIAMETER AND 2 TO 3 FT LONG.
 6. STAKES SHOULD BE INSTALLED LEAVING 1/5 OF STAKE ABOVE GROUND.

SILT CHECK

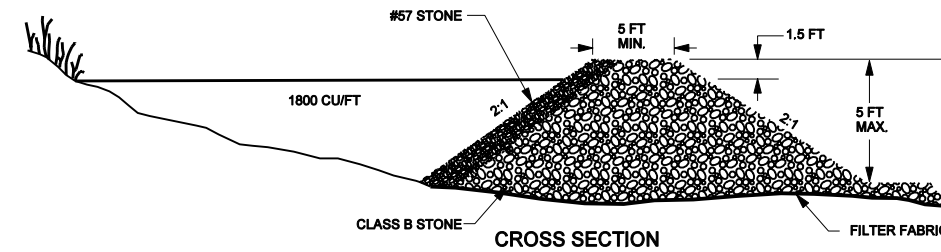

CROSS SECTION

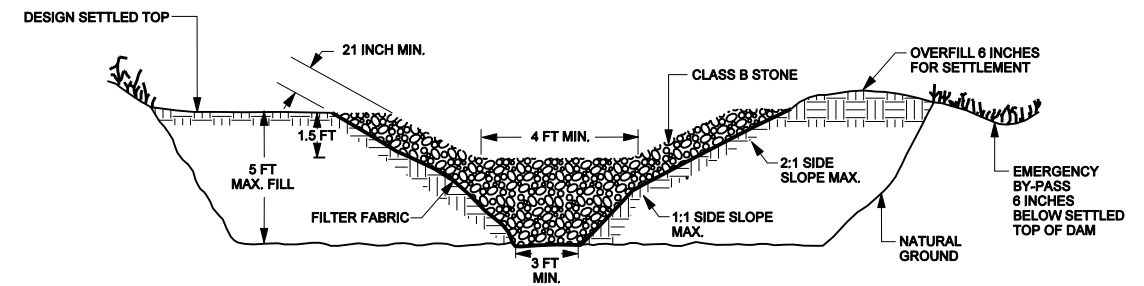

STONE SECTION

- CONSTRUCTION SPECIFICATIONS:**
1. CLEAR, GRUB, AND STRIP THE AREA UNDER THE EMBANKMENT OF ALL VEGETATION AND ROOT MATERIAL. REMOVE ALL SURFACE SOIL CONTAINING HIGH AMOUNTS OF ORGANIC MATTER AND STOCKPILE OR DISPOSE OF IT PROPERLY. HAUL ALL OBJECTIONABLE MATERIAL TO THE DESIGNATED DISPOSAL AREA.
 2. ENSURE ALL FILL MATERIAL FOR THE EMBANKMENT IS FREE OF ROOTS, WOODY VEGETATION, ORGANIC MATTER, AND OTHER OBJECTIONABLE MATERIAL. PLACE THE FILL IN LIFTS NOT TO EXCEED 9 INCHES AND MACHINE COMPACT IT. OVER FILL THE EMBANKMENT 6 INCHES TO ALLOW FOR SETTLEMENT.
 3. CONSTRUCT THE OUTLET SECTION IN THE EMBANKMENT. PROTECT THE CONNECTION BETWEEN THE RIPRAP AND THE SOIL FROM THE PIPING BY USING FILTER FABRIC OR A KETWAY CUTOFF TRENCH BETWEEN THE RIPRAP STRUCTURE AND THE SOIL.
 - PLACE THE FILTER FABRIC BETWEEN THE RIPRAP AND SOIL. EXTEND THE FABRIC ACROSS THE SPILLWAY FOUNDATION AND SIDES TO THE TOP OF THE DAM; OR
 - EXCAVATE A KETWAY TRENCH ALONG THE CENTERLINE OF THE SPILLWAY FOUNDATION EXTENDING UP THE SIDES TO THE HEIGHT OF THE DAM. THE TRENCH SHOULD BE AT LEAST 2 FEET DEEP AND 2 FEET WIDE WITH A 1:1 SLOPE.
 4. CLEAR THE POND AREA BELOW THE ELEVATION OF THE CREST OF THE SPILLWAY TO FACILITATE SEDIMENT CLEANOUT.
 5. ALL CUT AND FILL SLOPES SHOULD BE 2:1 OR FLATTER.
 6. ENSURE THAT ALL STONE (DRAINAGE) SECTION OF THE EMBANKMENT HAS A MINIMUM BOTTOM WIDTH OF 3 FEET AND A MAXIMUM SIDE SLOPE OF 1:1 THAT EXTEND THE BOTTOM OF THE SPILLWAY.
 7. CONSTRUCT A MINIMUM FINISHED STONE SPILLWAY BOTTOM WIDTH AS SHOWN, ON THE PLANS, WITH 2:1 SIDE SLOPES EXTENDING TO THE TOP OF THE OVER FILLED EMBANKMENT. KEEP THICKNESS OF THE SIDES TO THE SPILLWAY OUTLET STRUCTURE AT A MINIMUM OF 21 INCHES. THE WEIR MUST BE LEVEL AND CONSTRUCTED TO GRADE TO ASSURE DESIGN CAPACITY.
 8. MATERIAL USED IN THE STONE SECTION SHOULD BE A WELL GRADED MIXTURE OF STONE WITH A #50 SIZE OF 9 INCHES (CLASS B EROSION CONTROL STONE IS RECOMMENDED) AND A MAXIMUM STONE SIZE OF 14 INCHES. THE STONE MAY BE MACHINED PLACED AND THE SMALLER STONESWORKED INTO THE VOIDS OF THE LARGER STONES. THE STONE SHOULD BE HARD, ANGULAR, AND HIGHLY WEATHER-RESISTANT.

2/26/03
4/2/2006
F:\215R\Design\As_Buil\0215_EBX_PSH_AB_2B.dgn

THIS DOCUMENT
ORIGINALLY ISSUED AND
SEALED BY:

KEVIN L. TWEEDY
027337
APRIL 4, 2006

THIS MEDIA SHALL NOT BE CONSIDERED
A CERTIFIED DOCUMENT

TEMPORARY SILT FENCE

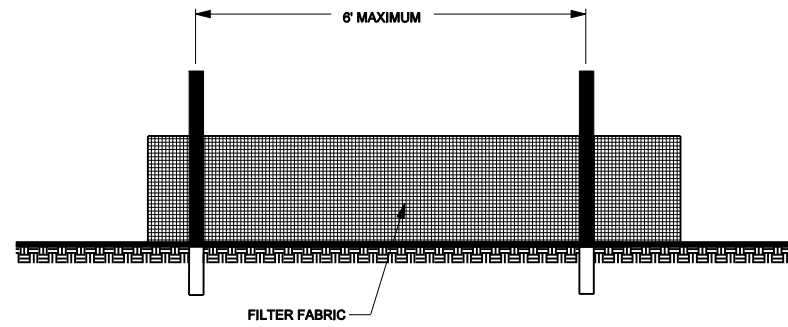

NOTES:

1. USE FILTER FABRIC A MINIMUM OF 36" IN WIDTH AND FASTEN ADEQUATELY TO THE WIRE AS DIRECTED BY THE ENGINEER.
2. PROVIDE 5" STEEL POST OF THE SELF-FASTENER ANGLE STEEL TYPE.

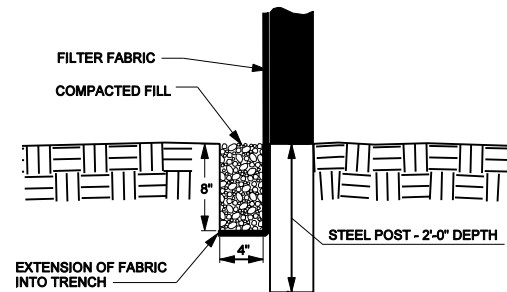

TEMPORARY GRAVEL CONSTRUCTION ENTRANCE

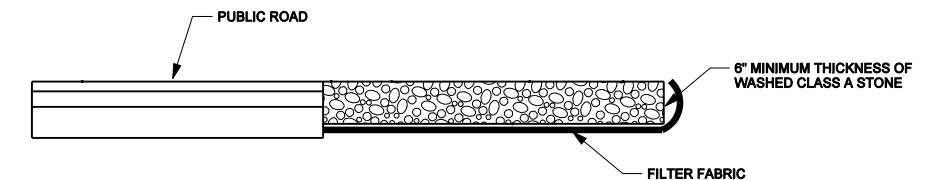
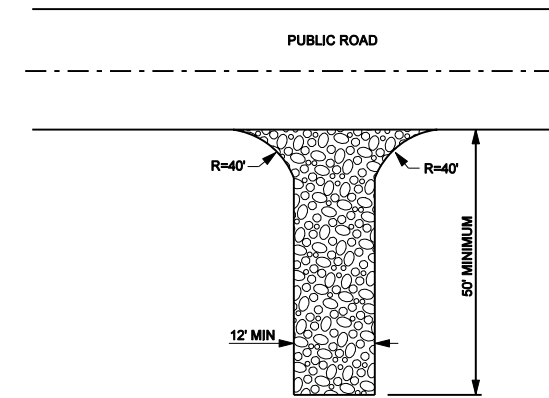

NOTES:

SPECIFICATION NO. 6.06 - CONSTRUCTION ACCESS "N.C. EROSION AND SEDIMENT CONTROL PLANNING AND DESIGN MANUAL DECEMBER 1993"

EROSION CONTROL MATTING

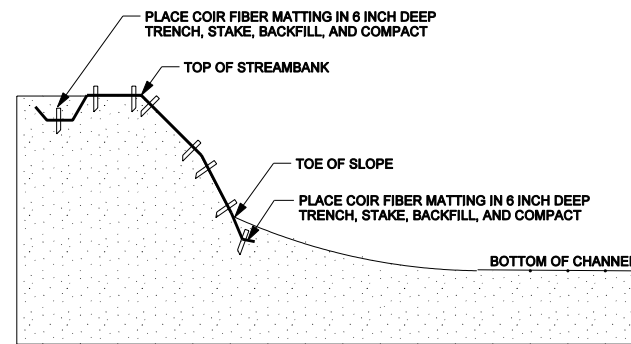

CROSS SECTION VIEW

NOTES:

1. BANKS SHOULD BE SEED PRIOR TO PLACEMENT OF MATTING.
2. PLACE COIR FIBER MATTING ACCORDING TO MANUFACTURER RECOMMENDATIONS.
3. MATTING STAKES SHOULD BE PLACED IN A DIAMOND SHAPED PATTERN.

THE WOOD STAKE SHALL BE THE NORTH AMERICAN GREEN ECO-STAKE OR APPROVED EQUAL WITH THE FOLLOWING DIMENSIONS:

LEG LENGTH	11.00 IN (27.94 CM)
HEAD WIDTH	1.25 IN (3.18 CM)
HEAD THICKNESS	0.40 IN (1.02 CM)
LEG WIDTH	0.80 IN (1.52 CM) (TAPERED TO POINT)
LEG THICKNESS	0.40 IN (1.02 CM)
TOTAL LENGTH	12.00 IN (30.48 CM)

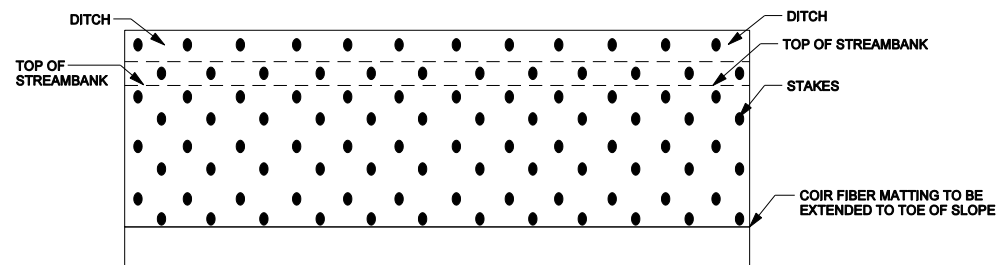

PLAN VIEW

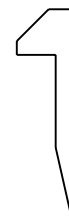

TYPICAL MATTING STAKE

FORD STREAM CROSSING

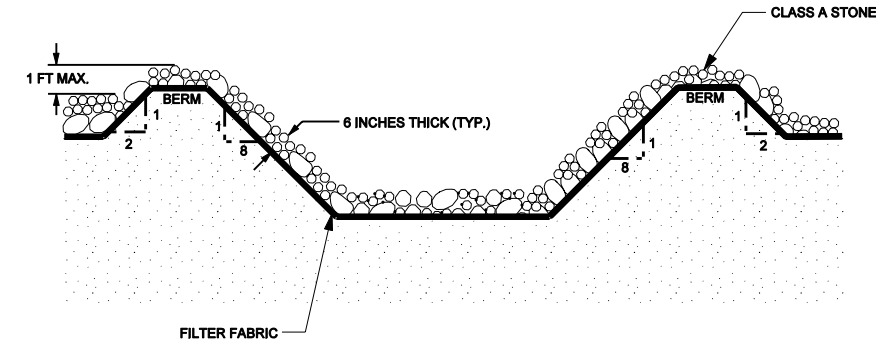

NOTES:

1. CONSTRUCT STREAM CROSSING WHEN FLOW IS LOW.
2. HAVE ALL NECESSARY MATERIALS AND EQUIPMENT ON-SITE BEFORE WORK BEGINS.
3. MINIMIZE CLEARING AND EXCAVATION OF STREAMBANKS. DO NOT EXCAVATE CHANNEL BOTTOM. COMPLETE ONE SIDE BEFORE STARTING ON THE OTHER SIDE.
4. INSTALL STREAM CROSSING AT RIGHT ANGLE TO THE FLOW.
5. GRADE SLOPES TO A 8:1 SLOPE. TRANSPLANT SOD FROM ORIGINAL STREAMBANK ONTO SIDE SLOPES.
6. MAINTAIN CROSSING SO THAT RUNOFF IN THE CONSTRUCTION ROAD DOES NOT ENTER EXISTING CHANNEL.
7. A STABILIZED PAD OF CLASS A STONE, 6 INCHES THICK, LINED WITH FILTER FABRIC FOR DRAINAGE SHALL BE USED OVER THE BERM AND ACCESS SLOPES.
8. WIDTH OF THE CROSSING SHALL BE SUFFICIENT TO ACCOMMODATE THE LARGEST VEHICLE CROSSING THE CHANNEL.
9. CONTRACTOR SHALL DETERMINE AN APPROPRIATE RAMP ANGLE ACCORDING TO EQUIPMENT UTILIZED.

2/26/03

4/12/2006
F:\0215R\Design\As_Buil\0215_EBX_PSH_AB_2C.dgn

THIS DOCUMENT
ORIGINALLY ISSUED AND
SEALED BY:

KEVIN L. TWEEDY
027337
APRIL 4, 2006

THIS MEDIA SHALL NOT BE CONSIDERED
A CERTIFIED DOCUMENT



2/26/03

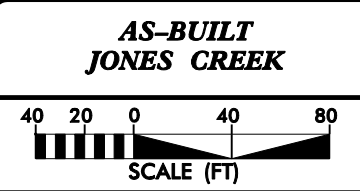
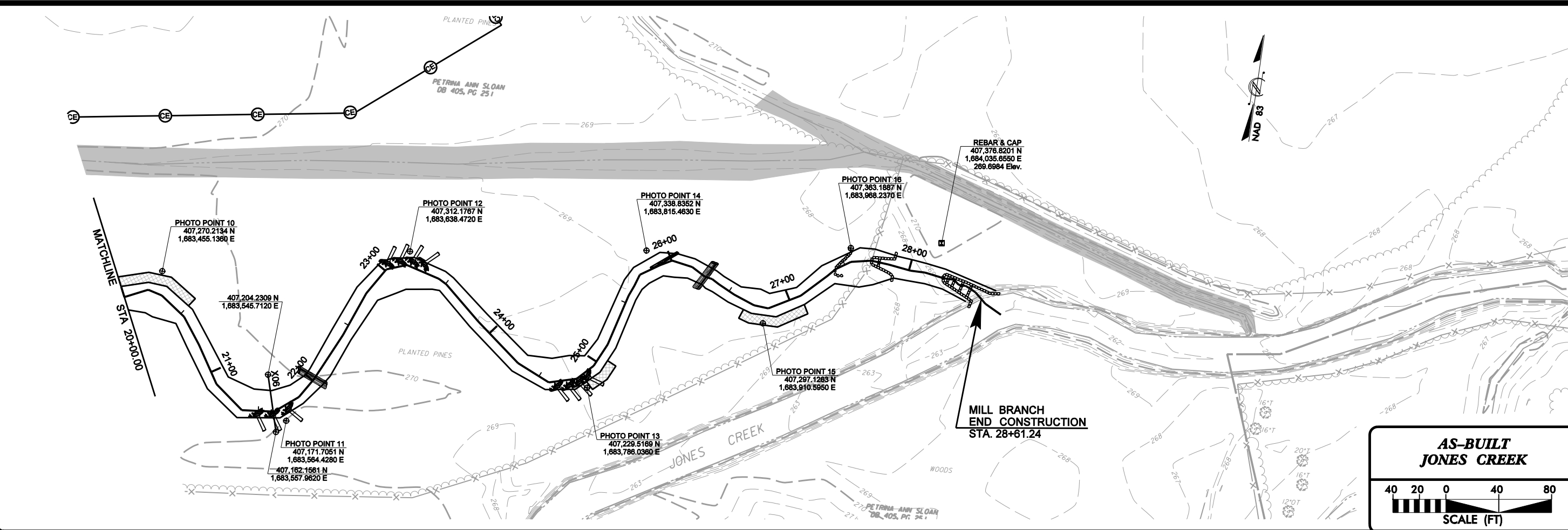
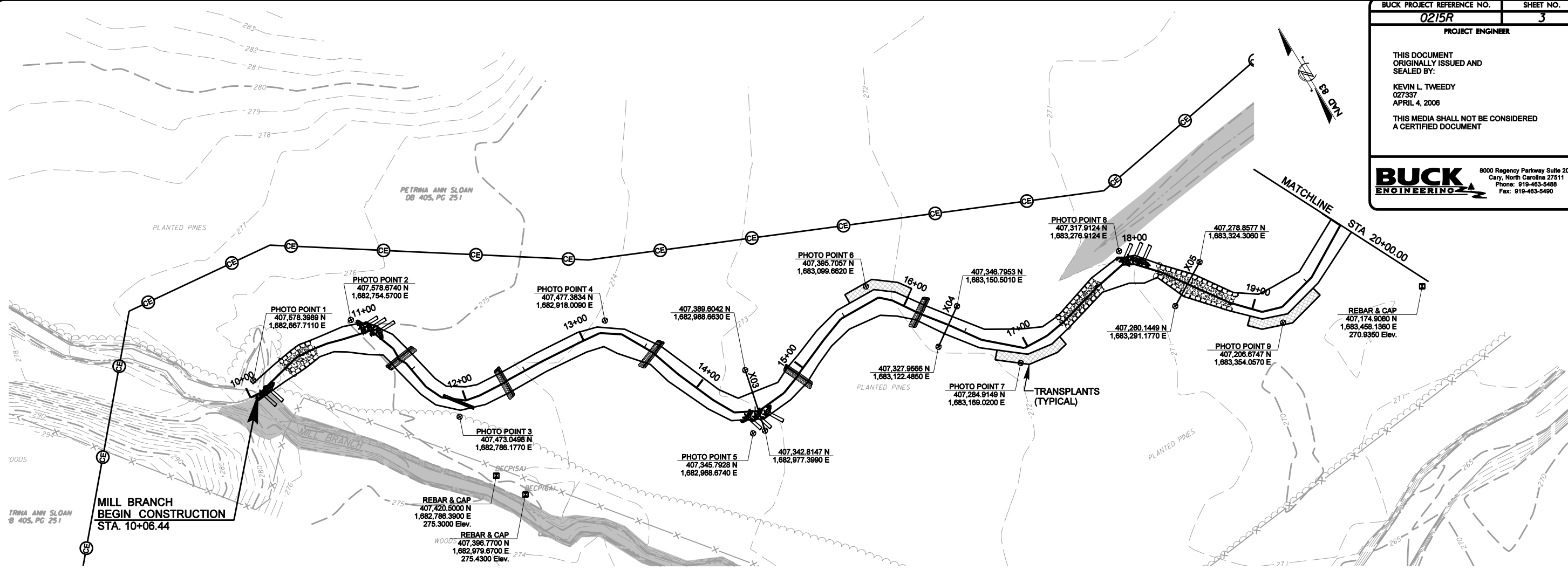

4/2/2006
F:\0215R\Design\As-Built\0215R_EBX_PSH_AB_03.dgn

THIS DOCUMENT
ORIGINALLY ISSUED AND
SEALED BY:

KEVIN L. TWEEDY
027337
APRIL 4, 2006

THIS MEDIA SHALL NOT BE CONSIDERED
A CERTIFIED DOCUMENT

2/26/03

4/12/2006
F:\0215R\Design\As-Built\0215R_EBX_PSH_AB_04.dgn

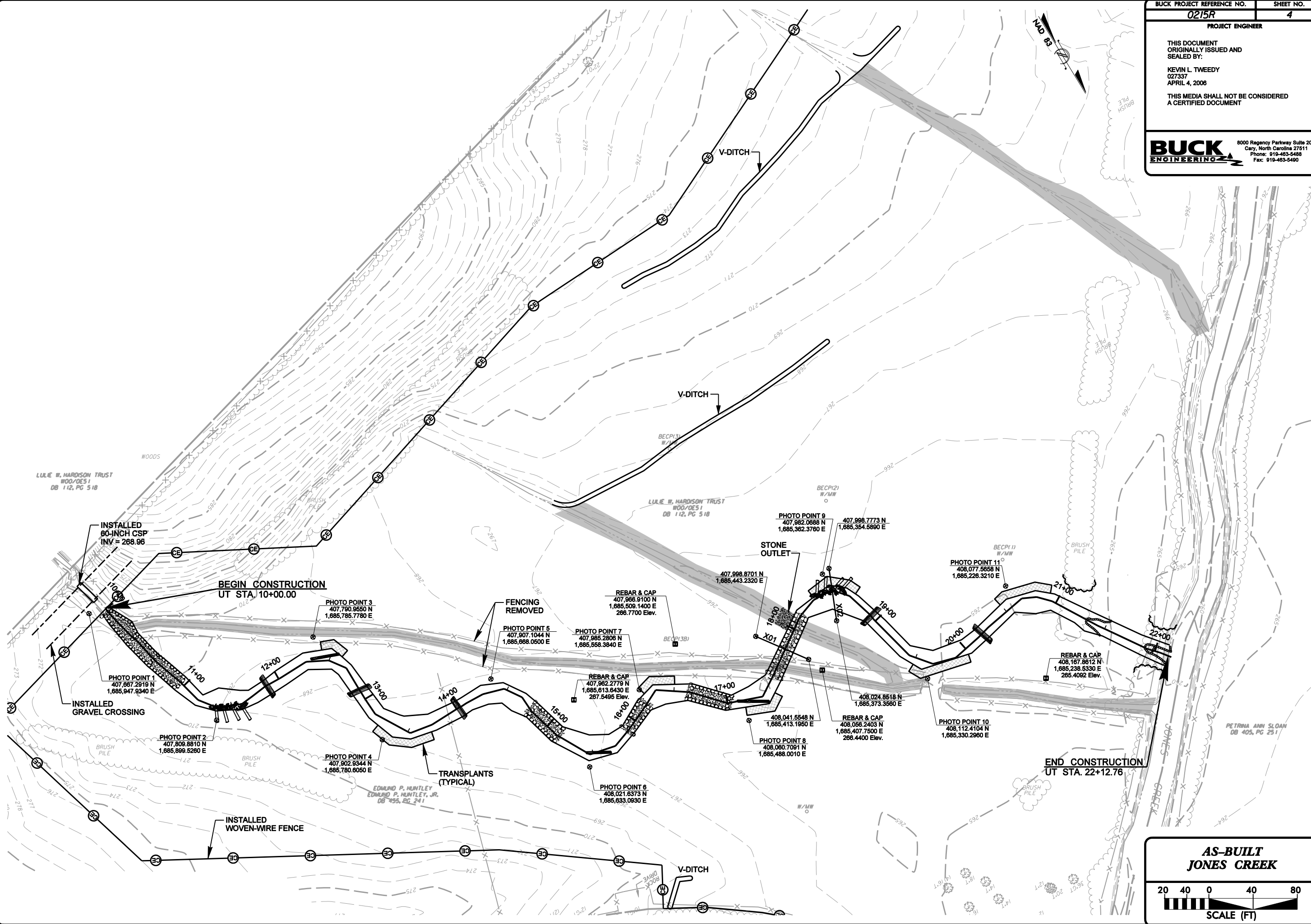





THIS DOCUMENT
ORIGINALLY ISSUED AND
SEALED BY:

KEVIN L. TWEEDY
027337
APRIL 4, 2006

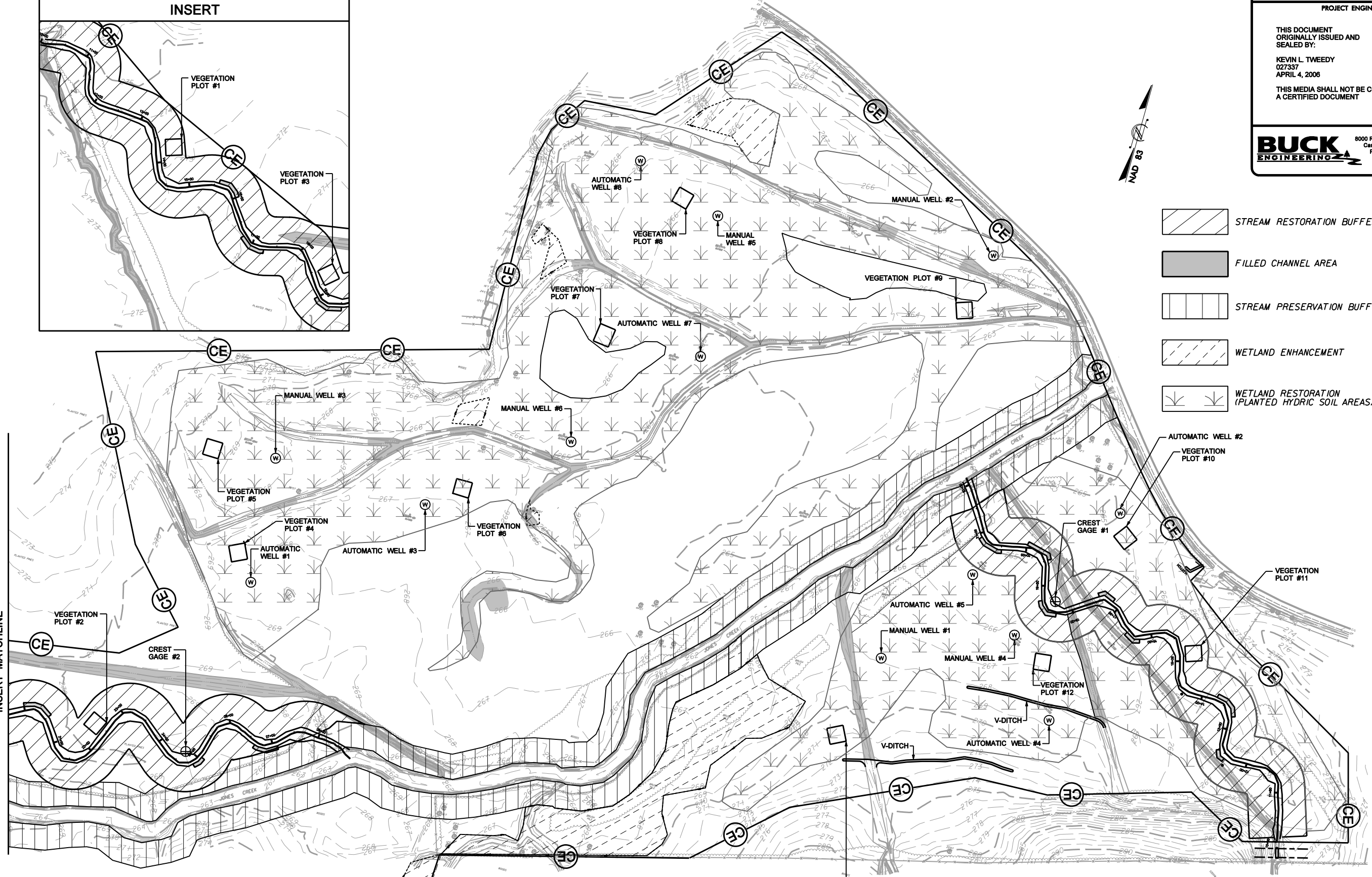
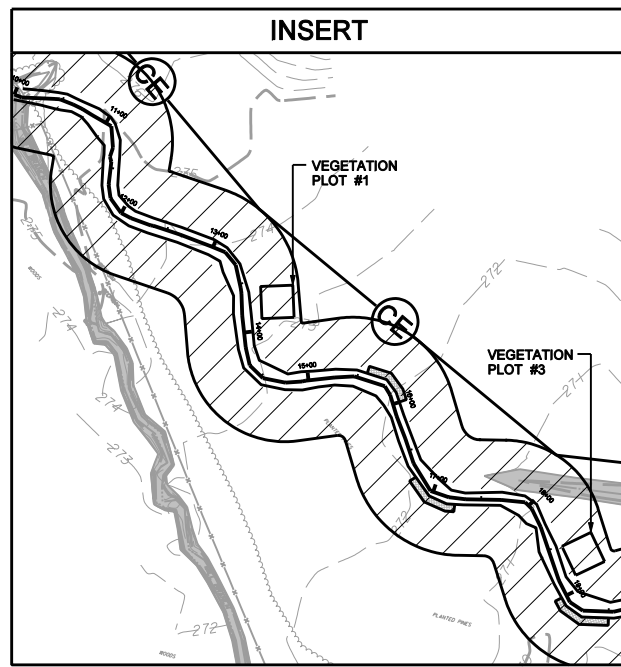
THIS MEDIA SHALL NOT BE CONSIDERED
A CERTIFIED DOCUMENT

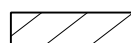
BUCK
ENGINEERING
8000 Regency Parkway Suite 200
Cary, North Carolina 27511
Phone: 919-463-5488
Fax: 919-463-5490

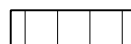
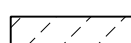

-  STREAM RESTORATION BUFFER
-  FILLED CHANNEL AREA
-  STREAM PRESERVATION BUFFER
-  WETLAND ENHANCEMENT
-  WETLAND RESTORATION (PLANTED HYDRIC SOIL AREAS)

INSERT MATCHLINE

TOTAL ACRES	
STREAM RESTORATION BUFFER	• 6.67 ACRES
STREAM PRESERVATION BUFFER	• 11.62 ACRES
WETLAND ENHANCEMENT	• 2.71
WETLAND RESTORATION (PLANTED HYDRIC SOIL AREAS)	• 25 ACRES

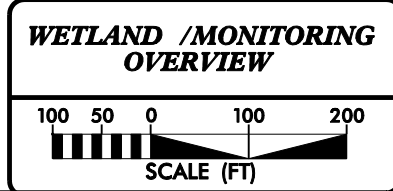

4/12/2006 F:\215\Design\As_Buil\0215_EBX_PSH_AB_wet_05.dgn

THIS DOCUMENT
ORIGINALLY ISSUED AND
SEALED BY:
KEVIN L. TWEEDY
027337
APRIL 4, 2006
THIS MEDIA SHALL NOT BE CONSIDERED
A CERTIFIED DOCUMENT



- CONSERVATION EASEMENT
- FILLED CHANNEL AREA
- ZONE 1
- ZONE 2
- ZONE 3
- EXISTING WETLAND BOUNDARY

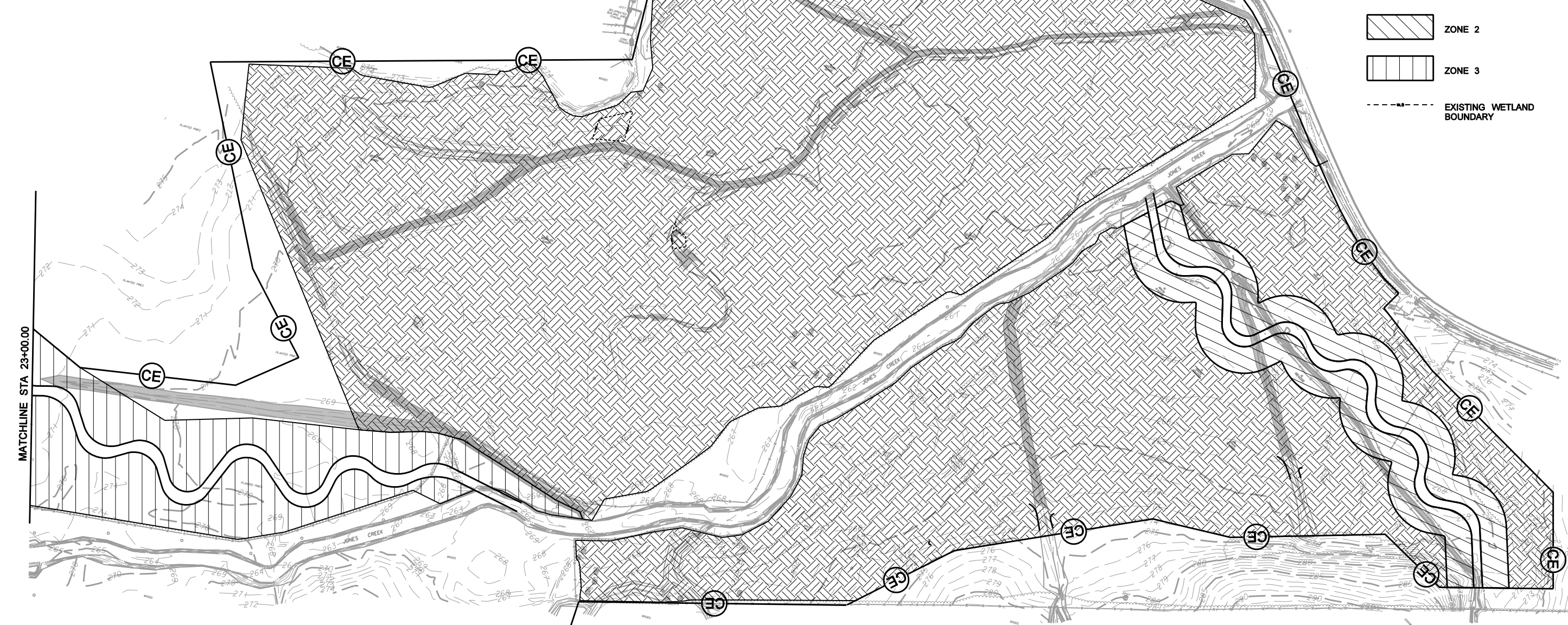
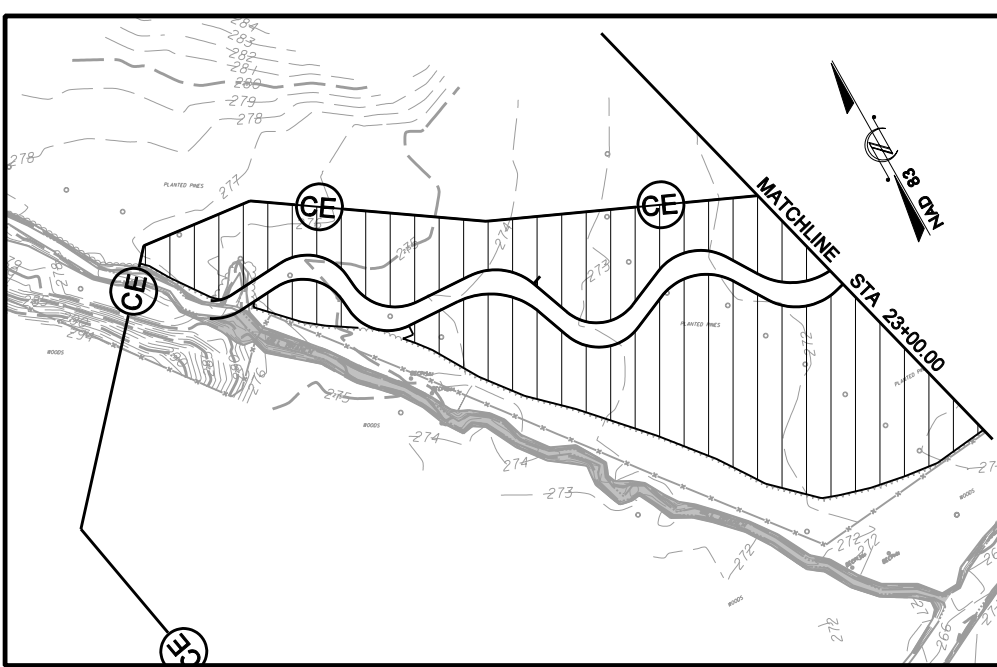

MATCHLINE STA 23+00.00

MATCHLINE STA 23+00.00

NOTE:
PLACE LIVE STAKES ALONG THE BANKS OF MILL BRANCH
AND UT TO SOUTH FORK JONES CREEK. PLANT ACCORDING
TO DETAIL ON SHEET 2-A.

TOTAL PLANTED ACREAGE	
ZONE 1	= 47.3 Ac
ZONE 2	= 2.5 Ac.
ZONE 3	= 6.2 Ac.

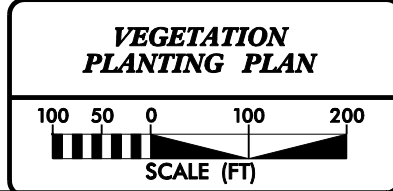

4/12/2006 Design\As_Buil\0215_EBX_PSH_AB_veg_06.dgn

APPENDIX B

2008 Profile and Cross Section Data

Jones Creek Mill Branch 2009 Profile

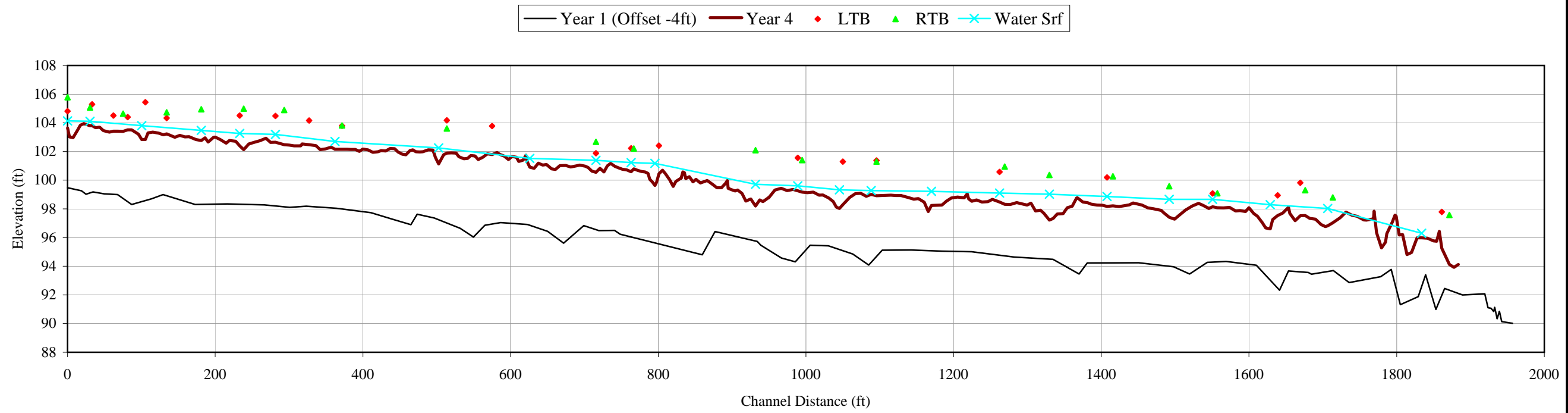

Jones Creek UT 2009 Profile

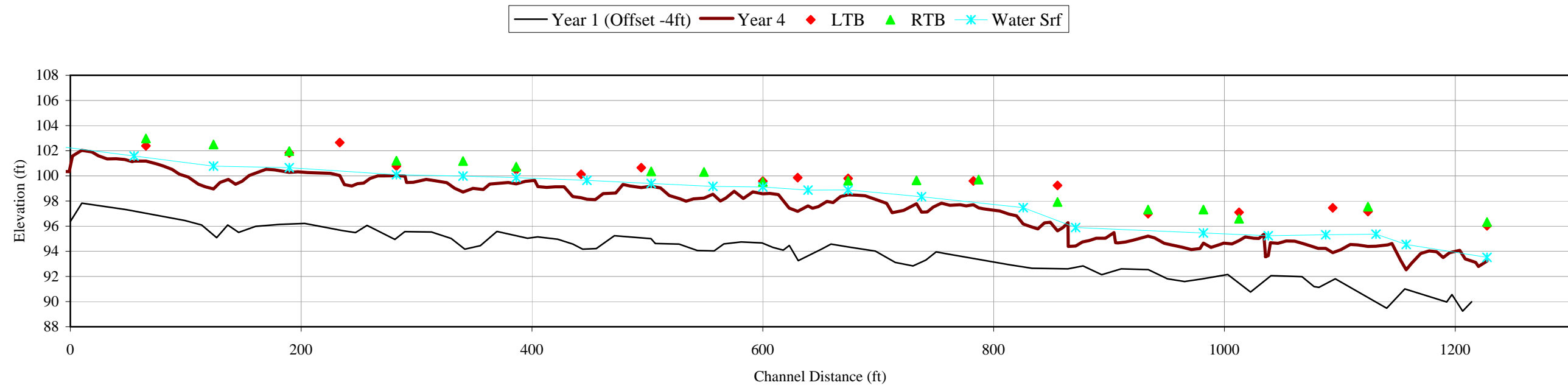



Looking at left bank.



Looking at right bank.

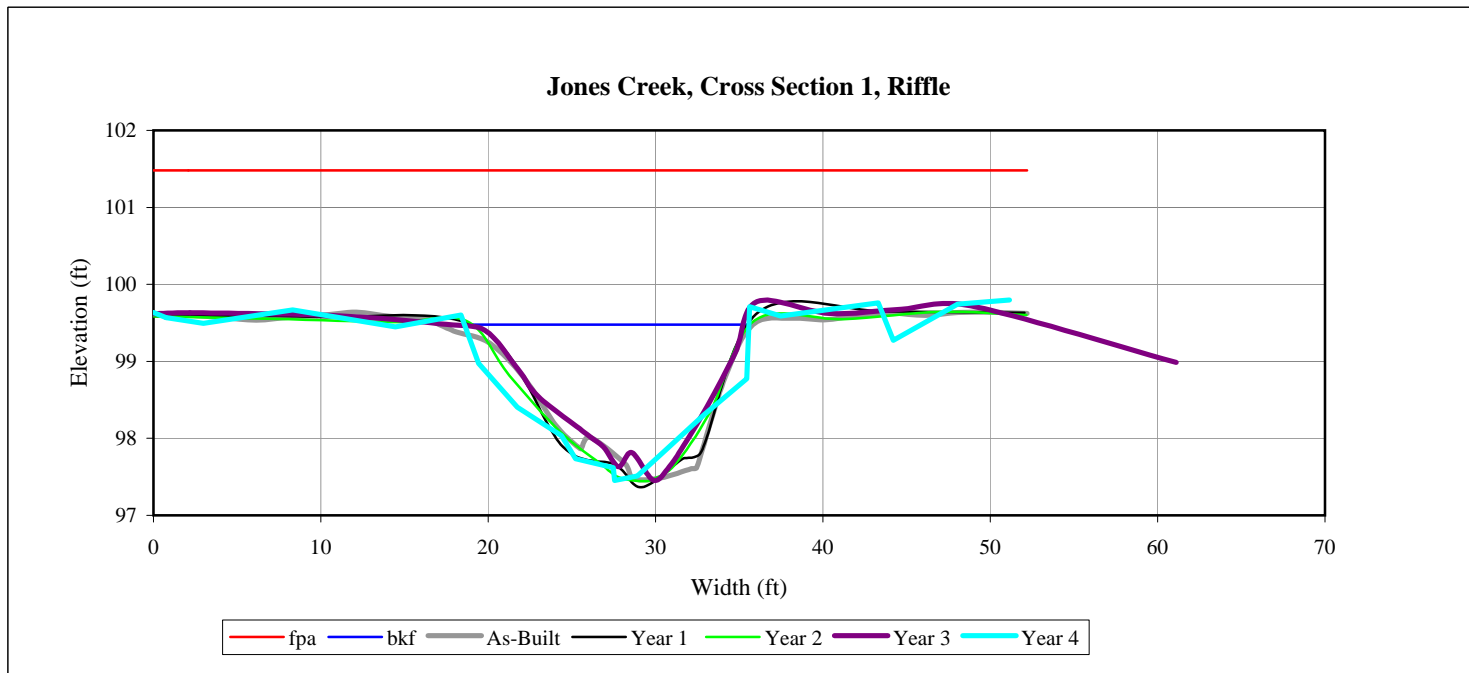



Looking at left bank.



Looking at right bank.

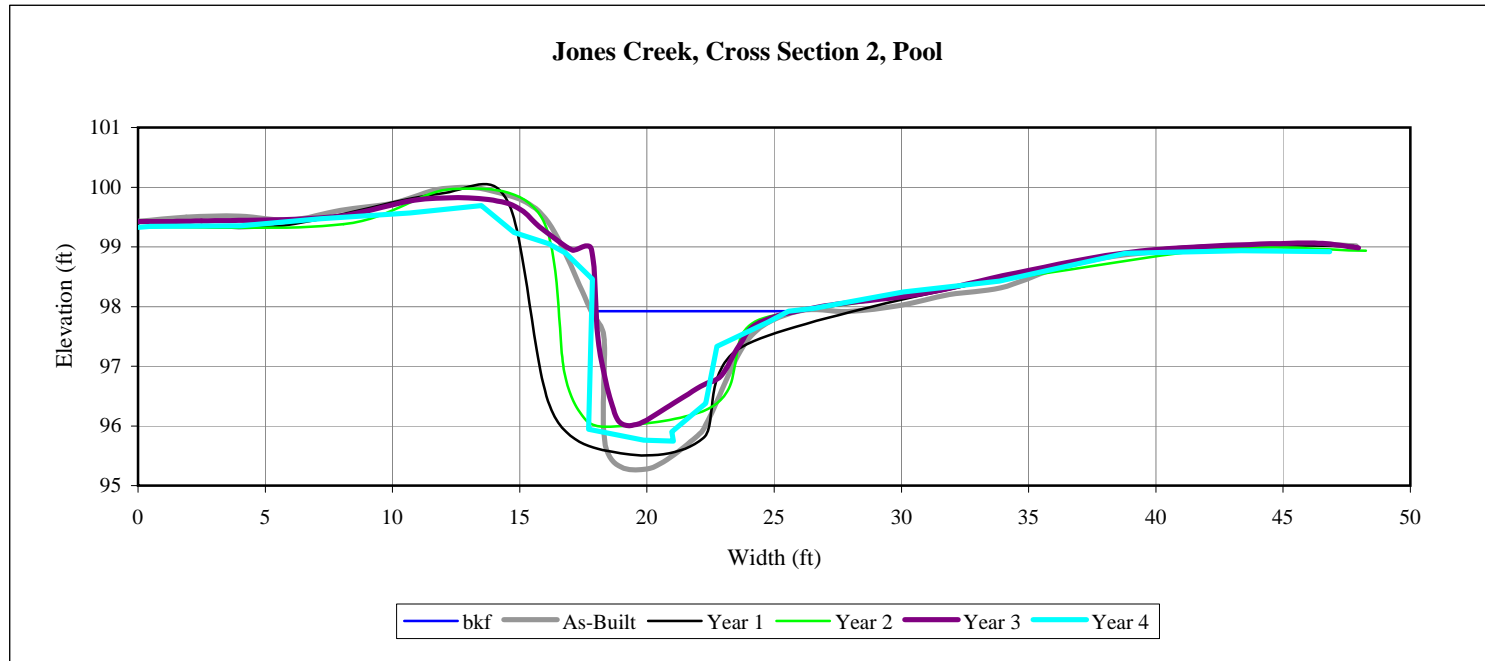



Looking at left bank.



Looking at right bank.

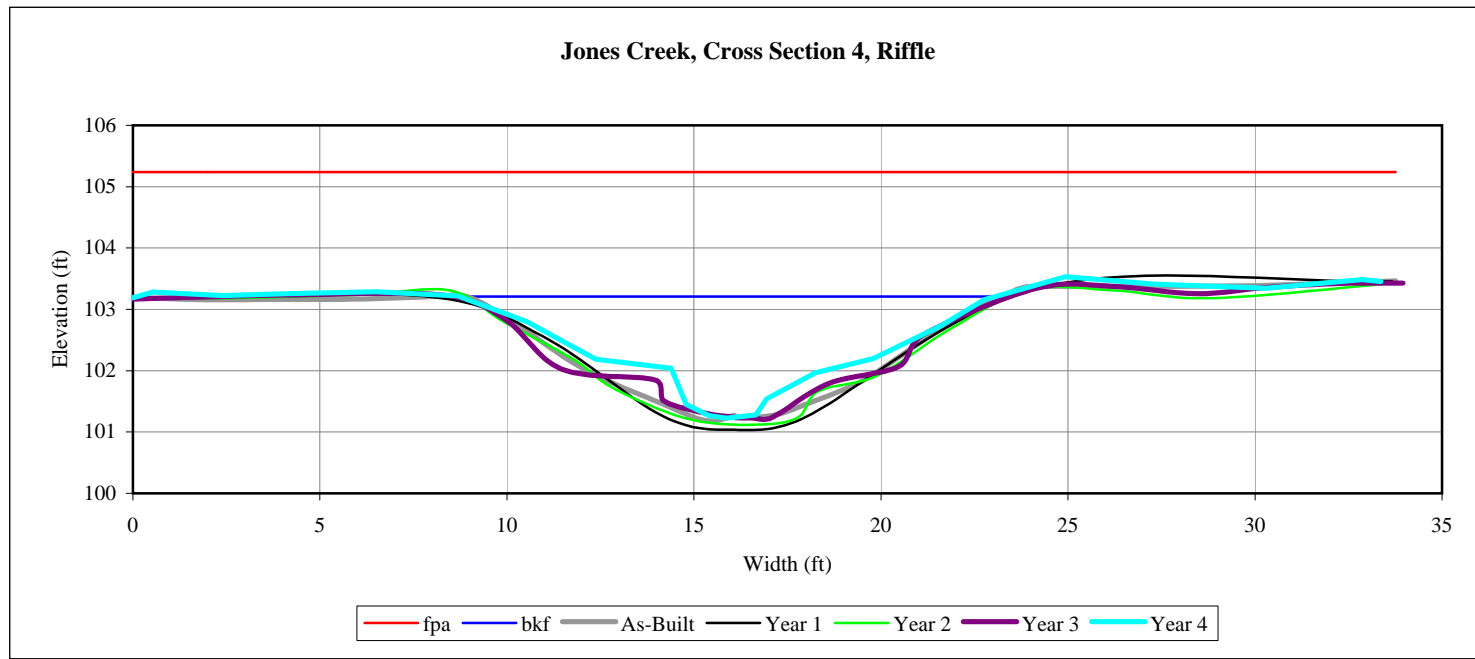

APPENDIX C

2008 Site Photos



SPA 1, UT1 Station 20+25 – Log weir washed out; left and right bank erosion.



Typical stream conditions (Mill Branch)



Constructed riffle facing upstream (typ.)



Typical stream conditions (UT 1)



Log weir facing downstream (typ.)



Rock cross vane facing downstream (typ.)



Rock cross vane facing upstream (typ.)



Root wad facing right bank (typ.)



Root wad facing left bank (typ.)



Log vane facing left bank (typ.)



Downstream limits of Mill Branch reach



Vegetation Plot 1



Vegetation Plot 2



Vegetation Plot 3



Vegetation Plot 4



Vegetation Plot 5



Vegetation Plot 6



Vegetation Plot 7



Vegetation Plot 8



Vegetation Plot 9



Vegetation Plot 10



Vegetation Plot 11



Vegetation Plot 12



Vegetation Plot 13

APPENDIX D

2008 Gauge Data

Date	Time	Water Level (inches)					
		Jon AW1	Jon AW2	Jon AW3	Jon AW4	Jon AW5	Jon AW6
01-Jan-2009	08:00:00	1.65	0.34	-1.09	-3.42	-0.05	-20.94
01-Jan-2009	20:00:00	1.77	0.36	-1.05	-1.72	0.05	-21.24
02-Jan-2009	08:00:00	1.75	0.37	-1.11	-1.45	0.09	-21.41
02-Jan-2009	20:00:00	2.46	0.39	-1.08	-1.39	0.12	-22.01
03-Jan-2009	08:00:00	2.33	0.35	-1.17	-1.67	0.10	-22.29
03-Jan-2009	20:00:00	2.23	0.35	-1.22	-1.46	0.10	-22.58
04-Jan-2009	08:00:00	3.61	0.80	-0.52	-0.85	2.36	-17.41
04-Jan-2009	20:00:00	3.23	0.64	-0.61	-0.98	0.96	-16.90
05-Jan-2009	08:00:00	3.11	0.58	-1.17	-1.01	0.72	-16.96
05-Jan-2009	20:00:00	3.12	0.54	-1.27	-0.91	0.54	-16.53
06-Jan-2009	08:00:00	3.79	1.17	-0.43	-0.61	1.81	-9.00
06-Jan-2009	20:00:00	3.55	1.10	-0.61	-0.62	1.53	-10.14
07-Jan-2009	08:00:00	3.96	1.34	-0.47	-0.46	2.43	-7.80
07-Jan-2009	20:00:00	3.46	1.06	-0.72	-1.79	1.63	-8.97
08-Jan-2009	08:00:00	3.27	0.80	-0.97	-1.57	1.53	-9.84
08-Jan-2009	20:00:00	3.13	0.62	-1.10	-1.99	1.43	-11.51
09-Jan-2009	08:00:00	2.88	0.48	-1.34	-2.60	1.11	-12.38
09-Jan-2009	20:00:00	2.86	0.46	-1.54	-1.85	1.04	-13.58
10-Jan-2009	08:00:00	2.78	0.44	-1.78	-1.75	0.94	-14.43
10-Jan-2009	20:00:00	2.94	0.44	-1.74	-0.95	0.95	-12.88
11-Jan-2009	08:00:00	3.50	0.84	-1.41	-0.91	1.64	-12.48
11-Jan-2009	20:00:00	3.28	0.64	-1.59	-1.20	1.30	-14.37
12-Jan-2009	08:00:00	3.05	0.49	-1.86	-2.11	1.06	-15.72
12-Jan-2009	20:00:00	2.97	0.44	-1.94	-1.64	0.93	-16.35
13-Jan-2009	08:00:00	3.01	0.40	-1.98	-1.19	0.90	-16.72
13-Jan-2009	20:00:00	2.99	0.42	-1.97	-1.40	0.91	-18.12
14-Jan-2009	08:00:00	2.63	0.36	-1.85	-2.96	0.69	-18.78
14-Jan-2009	20:00:00	2.72	0.38	-1.81	-1.56	0.66	-19.36
15-Jan-2009	08:00:00	2.38	0.33	-2.00	-2.54	0.37	-20.32
15-Jan-2009	20:00:00	2.34	0.31	-2.12	-2.51	0.40	-21.22
16-Jan-2009	08:00:00	1.64	-0.01	-2.56	-5.01	-0.32	-21.33
16-Jan-2009	20:00:00	1.79	0.22	-2.53	-2.28	0.18	-21.88
17-Jan-2009	08:00:00	0.41	-0.95	-3.35	-5.62	-1.55	-21.83
17-Jan-2009	20:00:00	1.52	-0.04	-2.79	-1.40	-0.06	-21.63
18-Jan-2009	08:00:00	2.05	0.29	-2.36	-1.07	0.47	-21.35
18-Jan-2009	20:00:00	2.65	0.35	-1.88	-1.17	0.70	-21.18
19-Jan-2009	08:00:00	2.34	0.24	-1.88	-1.65	0.19	-21.33
19-Jan-2009	20:00:00	2.57	0.30	-1.71	-1.13	0.42	-21.59
20-Jan-2009	08:00:00	2.90	0.43	-1.41	-1.39	0.94	-21.46
20-Jan-2009	20:00:00	2.71	0.36	-1.56	-1.89	0.81	-21.63
21-Jan-2009	08:00:00	1.85	0.11	-2.08	-4.24	-0.23	-21.71
21-Jan-2009	20:00:00	2.56	0.37	-1.72	-1.86	0.99	-21.19
22-Jan-2009	08:00:00	1.45	0.10	-2.22	-4.64	-0.43	-21.29
22-Jan-2009	20:00:00	2.78	0.38	-1.52	-1.41	1.09	-20.70
23-Jan-2009	08:00:00	2.04	0.30	-1.90	-2.97	0.01	-20.61
23-Jan-2009	20:00:00	2.80	0.35	-1.47	-1.20	0.97	-20.59
24-Jan-2009	08:00:00	2.72	0.28	-1.59	-1.48	0.74	-21.05
24-Jan-2009	20:00:00	2.60	0.27	-1.74	-1.50	0.69	-21.63
25-Jan-2009	08:00:00	2.39	0.23	-1.86	-2.15	0.51	-21.84
25-Jan-2009	20:00:00	2.23	0.21	-1.89	-1.95	0.49	-22.24
26-Jan-2009	08:00:00	2.06	0.21	-1.99	-2.25	0.40	-22.50
26-Jan-2009	20:00:00	1.92	0.20	-2.06	-2.01	0.32	-22.81

Date	Time	Water Level (inches)					
		Jon AW1	Jon AW2	Jon AW3	Jon AW4	Jon AW5	Jon AW6
27-Jan-2009	08:00:00	1.83	0.18	-2.07	-1.91	0.30	-22.67
27-Jan-2009	20:00:00	1.83	0.17	-2.00	-1.28	0.36	-22.45
28-Jan-2009	08:00:00	2.09	0.20	-1.84	-0.63	0.58	-22.17
28-Jan-2009	20:00:00	3.10	0.61	-1.32	-0.95	2.18	-20.52
29-Jan-2009	08:00:00	2.82	0.37	-1.47	-1.55	1.22	-19.93
29-Jan-2009	20:00:00	2.66	0.32	-1.62	-1.65	0.97	-20.10
30-Jan-2009	08:00:00	2.44	0.28	-1.75	-2.06	0.74	-20.60
30-Jan-2009	20:00:00	2.29	0.26	-1.81	-2.39	0.59	-21.45
31-Jan-2009	08:00:00	1.72	0.18	-2.07	-3.82	0.10	-22.02
31-Jan-2009	20:00:00	1.86	0.21	-2.02	-2.29	0.28	-22.39
01-Feb-2009	08:00:00	1.37	0.13	-2.28	-3.40	-0.09	-22.54
01-Feb-2009	20:00:00	1.62	0.18	-2.13	-2.06	0.18	-22.89
02-Feb-2009	08:00:00	1.35	0.10	-2.28	-2.45	-0.05	-22.80
02-Feb-2009	20:00:00	1.60	0.13	-2.14	-1.57	0.16	-22.05
03-Feb-2009	08:00:00	2.85	0.39	-1.48	-1.85	1.22	-20.47
03-Feb-2009	20:00:00	2.64	0.30	-1.60	-1.88	0.91	-20.69
04-Feb-2009	08:00:00	2.40	0.32	-1.80	-2.49	0.75	-21.29
04-Feb-2009	20:00:00	2.40	0.34	-1.81	-3.03	0.90	-21.66
05-Feb-2009	08:00:00	1.56	0.13	-2.17	-6.86	-0.19	-21.92
05-Feb-2009	20:00:00	1.70	0.22	-2.05	-2.80	0.40	-22.27
06-Feb-2009	08:00:00	0.60	-0.36	-2.59	-6.38	-1.25	-22.48
06-Feb-2009	20:00:00	1.67	0.21	-2.13	-2.09	0.45	-22.82
07-Feb-2009	08:00:00	0.99	0.10	-2.51	-3.69	-0.46	-22.75
07-Feb-2009	20:00:00	1.44	0.18	-2.08	-2.06	0.27	-23.07
08-Feb-2009	08:00:00	1.22	0.14	-2.12	-2.48	0.07	-23.18
08-Feb-2009	20:00:00	1.16	0.16	-2.11	-2.34	0.08	-23.53
09-Feb-2009	08:00:00	0.90	0.13	-2.29	-3.15	-0.08	-23.54
09-Feb-2009	20:00:00	0.95	0.08	-2.32	-2.54	-0.16	-23.81
10-Feb-2009	08:00:00	0.86	0.04	-2.40	-2.62	-0.27	-23.70
10-Feb-2009	20:00:00	0.84	0.00	-2.40	-2.61	-0.41	-23.90
11-Feb-2009	08:00:00	0.70	-0.03	-2.46	-2.95	-0.54	-23.36
11-Feb-2009	20:00:00	1.11	-0.02	-2.25	-1.93	-0.39	-23.59
12-Feb-2009	08:00:00	0.61	-0.01	-2.46	-3.70	-0.73	-24.35
12-Feb-2009	20:00:00	0.20	-0.17	-2.67	-4.66	-1.15	-24.60
13-Feb-2009	08:00:00	-0.26	-0.36	-2.87	-5.06	-1.58	-24.64
13-Feb-2009	20:00:00	-0.42	-0.51	-2.88	-4.88	-1.88	-24.67
14-Feb-2009	08:00:00	-0.44	-0.55	-2.87	-4.16	-1.93	-24.68
14-Feb-2009	20:00:00	-0.24	-0.47	-2.74	-3.73	-1.89	-25.38
15-Feb-2009	08:00:00	-1.28	-0.73	-3.16	-5.68	-2.48	-25.22
15-Feb-2009	20:00:00	-1.46	-0.88	-3.20	-5.01	-2.85	-25.65
16-Feb-2009	08:00:00	0.56	-0.15	-2.58	-3.55	-0.30	-25.52
16-Feb-2009	20:00:00	-0.54	-0.43	-2.78	-4.92	-1.27	-25.83
17-Feb-2009	08:00:00	-2.15	-0.97	-3.30	-7.04	-3.07	-25.41
17-Feb-2009	20:00:00	-1.87	-0.84	-3.07	-4.92	-3.19	-25.18
18-Feb-2009	08:00:00	0.77	-0.54	-2.74	-1.94	-2.15	-23.03
18-Feb-2009	20:00:00	2.72	0.22	-1.55	-0.78	0.98	-14.29
19-Feb-2009	08:00:00	3.06	0.64	-1.19	-1.71	1.57	-14.60
19-Feb-2009	20:00:00	2.61	0.44	-1.58	-3.35	1.07	-16.60
20-Feb-2009	08:00:00	2.09	0.30	-1.74	-4.07	0.57	-17.57
20-Feb-2009	20:00:00	1.89	0.28	-1.79	-3.79	0.47	-18.84
21-Feb-2009	08:00:00	1.25	0.21	-2.10	-5.77	-0.19	-19.27
21-Feb-2009	20:00:00	1.57	0.24	-1.92	-3.49	0.18	-19.60

Date	Time	Water Level (inches)					
		Jon AW1	Jon AW2	Jon AW3	Jon AW4	Jon AW5	Jon AW6
22-Feb-2009	08:00:00	1.65	0.24	-1.85	-2.87	0.30	-20.73
22-Feb-2009	20:00:00	1.01	0.21	-2.11	-6.54	-0.28	-21.53
23-Feb-2009	08:00:00	0.56	0.18	-2.40	-7.70	-0.70	-21.84
23-Feb-2009	20:00:00	0.45	0.15	-2.45	-5.75	-0.93	-22.55
24-Feb-2009	08:00:00	-0.48	-0.19	-2.97	-8.53	-2.04	-22.83
24-Feb-2009	20:00:00	-0.03	0.08	-2.71	-5.27	-1.39	-23.32
25-Feb-2009	08:00:00	-0.63	-0.06	-3.08	-5.93	-1.86	-23.38
25-Feb-2009	20:00:00	-0.51	-0.05	-2.99	-4.83	-2.06	-23.82
26-Feb-2009	08:00:00	-0.74	-0.13	-3.13	-5.13	-2.25	-23.75
26-Feb-2009	20:00:00	-0.58	-0.20	-3.12	-4.20	-2.30	-23.93
27-Feb-2009	08:00:00	-0.56	-0.26	-3.05	-4.13	-2.31	-23.80
27-Feb-2009	20:00:00	0.51	0.01	-2.58	-2.45	-0.78	-24.11
28-Feb-2009	08:00:00	2.10	0.22	-1.96	-1.71	1.54	-7.81
28-Feb-2009	20:00:00	3.76	2.80	-0.49	-1.06	2.70	0.71
01-Mar-2009	08:00:00	3.94	1.61	-0.60	-0.50	2.90	4.18
01-Mar-2009	20:00:00	4.38	2.95	-0.31	-0.16	3.41	4.01
02-Mar-2009	08:00:00	3.91	2.09	-0.80	-0.72	2.88	1.33
02-Mar-2009	20:00:00	3.52	1.29	-1.21	-0.94	2.63	-0.27
03-Mar-2009	08:00:00	3.09	0.85	-1.65	-3.54	2.37	-1.11
03-Mar-2009	20:00:00	3.14	0.81	-1.54	-1.21	2.26	-2.24
04-Mar-2009	08:00:00	2.76	0.55	-1.95	-3.56	1.85	-3.28
04-Mar-2009	20:00:00	3.04	0.65	-1.70	-1.08	1.94	-4.98
05-Mar-2009	08:00:00	2.91	0.50	-1.93	-2.41	1.69	-7.44
05-Mar-2009	20:00:00	2.95	0.47	-1.78	-1.18	1.66	-9.17
06-Mar-2009	08:00:00	2.97	0.40	-1.84	-1.59	1.58	-9.92
06-Mar-2009	20:00:00	2.99	0.35	-1.80	-1.26	1.45	-11.16
07-Mar-2009	08:00:00	2.92	0.31	-1.83	-1.63	1.41	-11.63
07-Mar-2009	20:00:00	2.86	0.28	-1.81	-1.26	1.31	-12.80
08-Mar-2009	08:00:00	2.81	0.27	-1.83	-1.66	1.27	-13.70
08-Mar-2009	20:00:00	2.76	0.24	-1.83	-1.71	1.11	-15.07
09-Mar-2009	08:00:00	2.65	0.25	-1.88	-2.00	1.02	-16.16
09-Mar-2009	20:00:00	2.47	0.24	-1.96	-2.15	0.90	-17.44
10-Mar-2009	08:00:00	2.30	0.23	-2.10	-2.67	0.85	-18.08
10-Mar-2009	20:00:00	2.23	0.16	-2.17	-2.13	0.79	-18.78
11-Mar-2009	08:00:00	2.22	0.16	-2.22	-1.92	0.81	-19.16
11-Mar-2009	20:00:00	2.06	0.19	-2.31	-2.23	0.72	-20.19
12-Mar-2009	08:00:00	1.84	0.17	-2.53	-3.49	0.61	-20.64
12-Mar-2009	20:00:00	1.58	0.06	-2.73	-3.55	0.36	-21.17
13-Mar-2009	08:00:00	1.43	-0.07	-2.84	-3.50	0.18	-21.46
13-Mar-2009	20:00:00	2.21	0.16	-2.24	-1.68	1.25	-21.18
14-Mar-2009	08:00:00	2.01	0.15	-2.26	-1.87	0.79	-20.33
14-Mar-2009	20:00:00	2.97	0.29	-1.59	-1.13	1.47	-18.92
15-Mar-2009	08:00:00	3.14	0.40	-1.35	-0.86	2.03	-13.45
15-Mar-2009	20:00:00	3.40	0.52	-1.19	-1.05	1.83	-11.44
16-Mar-2009	08:00:00	3.28	0.64	-1.32	-1.13	1.76	-10.61
16-Mar-2009	20:00:00	3.47	0.80	-1.15	-0.85	2.07	-8.47
17-Mar-2009	08:00:00	3.36	0.88	-1.20	-1.21	1.91	-9.00
17-Mar-2009	20:00:00	3.19	0.66	-1.42	-1.24	1.69	-9.80
18-Mar-2009	08:00:00	3.10	0.52	-1.58	-1.44	1.60	-10.20
18-Mar-2009	20:00:00	3.09	0.37	-1.57	-1.15	1.43	-11.41
19-Mar-2009	08:00:00	3.05	0.32	-1.58	-1.63	1.38	-12.16
19-Mar-2009	20:00:00	3.00	0.32	-1.61	-1.39	1.30	-10.30

Date	Time	Water Level (inches)					
		Jon AW1	Jon AW2	Jon AW3	Jon AW4	Jon AW5	Jon AW6
20-Mar-2009	08:00:00	3.31	0.64	-1.26	-1.50	1.83	-11.55
20-Mar-2009	20:00:00	3.10	0.47	-1.51	-2.07	1.47	-13.61
21-Mar-2009	08:00:00	2.97	0.42	-1.73	-2.63	1.34	-14.57
21-Mar-2009	20:00:00	2.86	0.36	-1.77	-1.95	1.19	-15.92
22-Mar-2009	08:00:00	2.78	0.33	-1.84	-2.32	1.09	-16.53
22-Mar-2009	20:00:00	2.69	0.23	-1.81	-1.67	1.02	-17.55
23-Mar-2009	08:00:00	2.55	0.24	-1.88	-2.25	0.98	-18.23
23-Mar-2009	20:00:00	2.48	0.19	-1.95	-1.79	0.96	-19.14
24-Mar-2009	08:00:00	2.34	0.22	-2.14	-2.43	1.35	-19.71
24-Mar-2009	20:00:00	2.17	0.14	-2.24	-2.57	0.52	-20.33
25-Mar-2009	08:00:00	2.08	0.09	-2.34	-2.98	0.51	-20.62
25-Mar-2009	20:00:00	2.23	0.14	-2.30	-1.77	0.87	-19.84
26-Mar-2009	08:00:00	2.81	0.29	-1.70	-1.20	1.01	-19.31
26-Mar-2009	20:00:00	2.73	0.27	-1.64	-1.10	1.13	-19.71
27-Mar-2009	08:00:00	2.63	0.27	-1.60	-1.62	0.84	-19.64
27-Mar-2009	20:00:00	2.79	0.31	-1.45	-0.86	0.94	-19.88
28-Mar-2009	08:00:00	2.70	0.34	-1.51	-1.42	0.73	-14.15
28-Mar-2009	20:00:00	4.21	2.88	-0.35	-0.37	2.67	-3.41
29-Mar-2009	08:00:00	3.51	1.01	-0.94	-0.85	2.08	-1.81
29-Mar-2009	20:00:00	3.18	0.79	-1.27	-3.60	2.33	-3.47
30-Mar-2009	08:00:00	3.02	0.68	-1.49	-3.68	2.10	-6.62
30-Mar-2009	20:00:00	2.84	0.52	-1.64	-3.67	1.57	-9.72
31-Mar-2009	08:00:00	2.73	0.51	-1.73	-3.76	1.73	-11.21
31-Mar-2009	20:00:00	2.67	0.36	-1.76	-3.00	0.81	-12.12
01-Apr-2009	08:00:00	2.78	0.38	-1.80	-2.57	0.91	-13.22
01-Apr-2009	20:00:00	2.76	0.36	-1.72	-1.77	1.09	-14.36
02-Apr-2009	08:00:00	3.15	0.53	-1.53	-1.09	1.29	-12.71
02-Apr-2009	20:00:00	3.40	0.73	-1.06	-0.50	1.32	-11.50
03-Apr-2009	08:00:00	3.57	0.89	-0.86	-0.88	1.59	-11.91
03-Apr-2009	20:00:00	3.20	0.66	-1.26	-3.40	1.56	-14.15
04-Apr-2009	08:00:00	3.00	0.57	-1.49	-3.53	1.34	-15.59
04-Apr-2009	20:00:00	2.79	0.44	-1.57	-3.04	0.46	-16.80
05-Apr-2009	08:00:00	2.66	0.42	-1.67	-2.90	0.46	-17.62
05-Apr-2009	20:00:00	2.56	0.46	-1.75	-2.97	0.15	-17.87
06-Apr-2009	08:00:00	3.31	0.53	-1.61	-1.26	0.45	-17.15
06-Apr-2009	20:00:00	2.97	0.62	-1.33	-3.87	0.52	-18.54
07-Apr-2009	08:00:00	2.72	0.54	-1.48	-3.65	0.67	-19.55
07-Apr-2009	20:00:00	2.35	0.49	-1.71	-4.49	0.72	-20.54
08-Apr-2009	08:00:00	2.17	0.45	-2.02	-4.16	0.49	-20.84
08-Apr-2009	20:00:00	2.03	0.40	-2.10	-3.69	-0.15	-21.56
09-Apr-2009	08:00:00	1.79	0.32	-2.37	-3.93	-0.37	-22.17
09-Apr-2009	20:00:00	1.44	0.13	-2.56	-4.03	-0.91	-22.63
10-Apr-2009	08:00:00	1.30	-0.03	-2.70	-3.41	-0.91	-22.76
10-Apr-2009	20:00:00	1.18	-0.14	-2.65	-2.53	-1.09	-12.42
11-Apr-2009	08:00:00	3.27	1.11	-1.12	-1.55	0.84	-13.00
11-Apr-2009	20:00:00	2.99	0.77	-1.45	-3.20	0.15	-14.84
12-Apr-2009	08:00:00	2.75	0.60	-1.66	-3.37	0.60	-16.07
12-Apr-2009	20:00:00	2.48	0.51	-1.74	-3.22	-0.33	-17.42
13-Apr-2009	08:00:00	2.44	0.53	-1.84	-2.66	-0.34	-17.84
13-Apr-2009	20:00:00	2.41	0.55	-1.79	-1.57	0.07	-18.27
14-Apr-2009	08:00:00	2.48	0.53	-1.74	-1.43	-0.04	-16.26
14-Apr-2009	20:00:00	3.26	1.01	-0.98	-0.90	0.82	-14.68

Date	Time	Water Level (inches)					
		Jon AW1	Jon AW2	Jon AW3	Jon AW4	Jon AW5	Jon AW6
15-Apr-2009	08:00:00	3.05	0.76	-1.28	-1.85	0.29	-15.78
15-Apr-2009	20:00:00	2.80	0.66	-1.43	-2.68	0.61	-17.41
16-Apr-2009	08:00:00	2.59	0.58	-1.61	-3.31	0.32	-18.56
16-Apr-2009	20:00:00	2.25	0.51	-1.82	-3.76	-0.19	-19.74
17-Apr-2009	08:00:00	2.03	0.49	-2.08	-3.68	-0.03	-20.37
17-Apr-2009	20:00:00	1.77	0.44	-2.25	-3.23	-0.92	-20.99
18-Apr-2009	08:00:00	1.64	0.39	-2.40	-3.36	-1.00	-21.60
18-Apr-2009	20:00:00	1.26	0.23	-2.50	-3.03	-1.20	-22.12
19-Apr-2009	08:00:00	1.10	0.09	-2.58	-3.08	-1.38	-22.54
19-Apr-2009	20:00:00	0.94	-0.02	-2.60	-2.50	-1.52	-22.81
20-Apr-2009	08:00:00	2.22	0.44	-1.84	-1.53	0.63	-22.52
20-Apr-2009	20:00:00	1.61	0.34	-2.01	-3.71	-0.45	-23.10
21-Apr-2009	08:00:00	1.31	0.26	-2.21	-3.31	-0.71	-23.48
21-Apr-2009	20:00:00	0.80	0.04	-2.48	-4.22	-1.44	-24.18
22-Apr-2009	08:00:00	0.43	-0.21	-2.78	-4.49	-1.58	-24.79
22-Apr-2009	20:00:00	-0.48	-0.84	-3.18	-6.01	-2.98	-25.27
23-Apr-2009	08:00:00	-1.02	-1.25	-3.49	-5.88	-3.37	-25.76
23-Apr-2009	20:00:00	-2.43	-1.95	-3.82	-6.50	-4.93	-26.18
24-Apr-2009	08:00:00	-2.91	-2.39	-4.08	-6.70	-5.25	-26.61
24-Apr-2009	20:00:00	-4.31	-3.32	-4.61	-7.04	-7.00	-26.95
25-Apr-2009	08:00:00	-4.66	-3.72	-4.87	-6.91	-7.26	-27.32
25-Apr-2009	20:00:00	-6.39	-4.94	-5.91	-8.49	-9.75	-27.68
26-Apr-2009	08:00:00	-7.06	-5.55	-6.52	-8.41	-10.00	-28.08
26-Apr-2009	20:00:00	-9.02	-7.05	-8.46	-9.40	-12.45	-28.45
27-Apr-2009	08:00:00	-9.98	-7.75	-9.33	-9.30	-12.81	-28.86
27-Apr-2009	20:00:00	-12.09	-9.44	-11.47	-10.59	-14.80	-29.15
28-Apr-2009	08:00:00	-13.04	-10.32	-12.39	-10.56	-15.51	-29.53
28-Apr-2009	20:00:00	-14.06	-11.64	-14.01	-10.84	-16.68	-29.78
29-Apr-2009	08:00:00	-14.52	-12.23	-14.83	-10.58	-17.28	-30.18
29-Apr-2009	20:00:00	-15.59	-13.17	-16.33	-10.82	-18.09	-30.51
30-Apr-2009	08:00:00	-16.09	-13.78	-17.25	-11.16	-18.67	-30.73
30-Apr-2009	20:00:00	-16.73	-14.44	-18.08	-10.77	-19.26	-30.97
01-May-2009	08:00:00	-16.63	-14.40	-18.23	-10.27	-19.31	-31.30
01-May-2009	20:00:00	-17.69	-15.26	-19.10	-11.45	-19.83	-31.50
02-May-2009	08:00:00	-17.55	-15.22	-19.19	-10.81	-20.03	-31.96
02-May-2009	20:00:00	-7.53	-3.94	-13.73	-8.87	-20.34	-31.72
03-May-2009	08:00:00	-8.68	-2.61	-7.46	-6.56	-10.20	-31.95
03-May-2009	20:00:00	-10.59	-3.78	-9.36	-7.40	-11.11	-32.07
04-May-2009	08:00:00	-11.92	-4.92	-10.40	-8.09	-12.75	-32.49
04-May-2009	20:00:00	-13.35	-6.84	-12.31	-8.09	-14.55	-32.49
05-May-2009	08:00:00	1.75	0.14	-2.35	-4.06	-6.84	-29.93
05-May-2009	20:00:00	1.63	-0.05	-2.00	-4.13	-2.29	-29.32
06-May-2009	08:00:00	0.28	-0.17	-2.14	-4.96	-1.98	-29.31
06-May-2009	20:00:00	-1.30	-0.37	-2.41	-4.58	-1.95	-29.52
07-May-2009	08:00:00	-2.35	-0.56	-2.64	-4.87	-1.99	-29.99
07-May-2009	20:00:00	-4.80	-1.17	-3.16	-7.57	-2.90	-30.33
08-May-2009	08:00:00	-6.05	-1.59	-3.41	-9.31	-3.80	-30.77
08-May-2009	20:00:00	-8.01	-2.34	-3.81	-10.56	-5.37	-30.93
09-May-2009	08:00:00	-8.64	-2.79	-4.00	-11.99	-6.69	-31.72
09-May-2009	20:00:00	-12.27	-5.59	-5.24	-13.49	-10.48	-32.18
10-May-2009	08:00:00	-12.81	-6.92	-5.94	-15.49	-11.65	-32.72
10-May-2009	20:00:00	-16.65	-10.27	-8.75	-16.19	-14.93	-32.85

Date	Time	Water Level (inches)					
		Jon AW1	Jon AW2	Jon AW3	Jon AW4	Jon AW5	Jon AW6
11-May-2009	08:00:00	-1.77	0.09	-2.57	-15.36	-3.55	-31.24
11-May-2009	20:00:00	-4.77	-0.23	-2.57	-11.38	-2.59	-30.82
12-May-2009	08:00:00	-6.84	-0.57	-2.77	-12.30	-2.13	-31.22
12-May-2009	20:00:00	-10.66	-1.37	-3.30	-12.26	-4.55	-31.52
13-May-2009	08:00:00	-11.70	-2.01	-3.67	-14.64	-5.36	-32.16
13-May-2009	20:00:00	-14.60	-3.44	-4.31	-15.19	-8.38	-32.13
14-May-2009	08:00:00	-13.81	-4.26	-4.60	-16.03	-9.81	-32.55
14-May-2009	20:00:00	-13.85	-3.33	-4.21	-13.54	-8.99	-32.71
15-May-2009	08:00:00	-14.44	-4.19	-4.51	-14.82	-10.26	-33.12
15-May-2009	20:00:00	-17.30	-6.82	-5.82	-15.40	-13.02	-33.15
16-May-2009	08:00:00	-17.44	-7.68	-6.26	-16.89	-13.93	-33.42
16-May-2009	20:00:00	-17.18	-7.41	-6.10	-16.18	-14.05	-33.14
17-May-2009	08:00:00	-16.62	-8.70	-7.10	-16.49	-14.74	-33.56
17-May-2009	20:00:00	-13.39	-3.99	-3.30	-17.79	-15.69	-33.12
18-May-2009	08:00:00	-6.53	-0.35	-2.60	-10.35	-3.65	-33.02
18-May-2009	20:00:00	-10.49	-1.26	-3.28	-10.49	-5.48	-32.95
19-May-2009	08:00:00	-11.87	-2.30	-3.63	-13.22	-7.17	-33.58
19-May-2009	20:00:00	-15.95	-4.99	-4.60	-14.29	-10.80	-33.66
20-May-2009	08:00:00	-16.59	-6.75	-5.04	-16.44	-12.72	-34.09
20-May-2009	20:00:00	-19.73	-10.60	-7.10	-17.03	-16.12	-34.10
21-May-2009	08:00:00	-19.58	-11.43	-7.62	-18.09	-16.82	-34.48
21-May-2009	20:00:00	-21.45	-14.14	-11.66	-18.38	-19.03	-34.60
22-May-2009	08:00:00	-21.65	-15.04	-12.30	-19.67	-20.09	-34.97
22-May-2009	20:00:00	-23.18	-16.50	-15.08	-19.78	-21.53	-35.04
23-May-2009	08:00:00	-23.23	-17.16	-15.79	-21.00	-22.26	-35.34
23-May-2009	20:00:00	-24.16	-17.92	-17.45	-21.02	-22.71	-35.38
24-May-2009	08:00:00	-23.19	-17.43	-14.18	-21.60	-23.18	-35.07
24-May-2009	20:00:00	-11.81	-0.76	-3.40	-14.82	-11.36	-34.34
25-May-2009	08:00:00	-11.79	-1.07	-3.58	-11.26	-8.69	-33.53
25-May-2009	20:00:00	-1.46	-0.12	-1.71	-6.71	-3.75	-32.04
26-May-2009	08:00:00	0.47	-0.56	-1.20	-7.61	-3.37	-30.00
26-May-2009	20:00:00	5.37	4.28	0.71	-2.26	0.62	0.62
27-May-2009	08:00:00	3.96	0.39	-0.55	-2.57	-1.27	-1.91
27-May-2009	20:00:00	3.19	0.02	-0.93	-2.33	-1.76	-3.55
28-May-2009	08:00:00	3.23	0.04	-1.01	-2.77	-2.27	-6.89
28-May-2009	20:00:00	5.09	5.48	0.60	-0.93	1.08	1.29
29-May-2009	08:00:00	4.02	0.55	-0.44	-1.33	-1.00	-1.65
29-May-2009	20:00:00	3.68	0.10	-0.72	-1.71	-1.63	-3.34
30-May-2009	08:00:00	3.27	0.17	-0.87	-2.87	-1.38	-8.49
30-May-2009	20:00:00	2.61	-0.08	-1.27	-3.57	-2.68	-11.40
31-May-2009	08:00:00	2.04	-0.07	-1.42	-3.87	-2.75	-14.84
31-May-2009	20:00:00	1.87	-0.53	-2.02	-4.74	-4.44	-17.12
01-Jun-2009	08:00:00	1.68	-0.72	-2.25	-5.30	-4.94	-20.51
01-Jun-2009	20:00:00	-0.20	-1.98	-3.17	-5.92	-8.14	-21.73
02-Jun-2009	08:00:00	-0.10	-2.55	-3.36	-5.86	-8.91	-23.72
02-Jun-2009	20:00:00	-2.56	-5.64	-5.03	-6.28	-12.32	-24.37
03-Jun-2009	08:00:00	-2.78	-6.56	-5.81	-6.49	-13.47	-25.82
03-Jun-2009	20:00:00	-5.22	-11.06	-10.15	-6.89	-16.44	-26.41
04-Jun-2009	08:00:00	-5.13	-11.89	-10.95	-7.13	-17.78	-26.76
04-Jun-2009	20:00:00	0.33	-0.69	-2.53	-3.10	-12.45	-25.21
05-Jun-2009	08:00:00	1.44	-0.53	-2.13	-2.48	-4.55	-25.67
05-Jun-2009	20:00:00	-0.81	-1.08	-2.87	-3.77	-5.82	-26.05

Date	Time	Water Level (inches)					
		Jon AW1	Jon AW2	Jon AW3	Jon AW4	Jon AW5	Jon AW6
06-Jun-2009	08:00:00	-2.00	-1.45	-3.16	-4.16	-6.14	-27.21
06-Jun-2009	20:00:00	-4.75	-2.94	-4.31	-4.83	-8.92	-27.50
07-Jun-2009	08:00:00	-5.37	-3.95	-4.90	-5.16	-10.28	-28.18
07-Jun-2009	20:00:00	-8.42	-6.82	-7.79	-5.43	-13.69	-28.52
08-Jun-2009	08:00:00	-8.79	-7.80	-8.54	-5.64	-14.80	-29.31
08-Jun-2009	20:00:00	-12.24	-11.65	-12.87	-6.50	-17.24	-29.53
09-Jun-2009	08:00:00	-13.03	-12.52	-13.46	-7.03	-18.19	-30.44
09-Jun-2009	20:00:00	-15.95	-14.83	-16.15	-7.16	-20.62	-30.52
10-Jun-2009	08:00:00	-15.46	-13.68	-15.37	-7.55	-19.56	-31.31
10-Jun-2009	20:00:00	-19.05	-16.73	-18.72	-7.93	-21.77	-31.42
11-Jun-2009	08:00:00	-15.63	-12.39	-13.80	-7.11	-19.66	-32.00
11-Jun-2009	20:00:00	-18.23	-15.02	-16.86	-6.65	-20.58	-31.99
12-Jun-2009	08:00:00	-17.72	-15.24	-16.81	-7.84	-20.71	-32.81
12-Jun-2009	20:00:00	-21.27	-17.93	-19.94	-9.11	-23.17	-32.94
13-Jun-2009	08:00:00	-21.41	-18.86	-20.69	-13.09	-23.88	-33.75
13-Jun-2009	20:00:00	-23.61	-20.20	-21.89	-13.99	-24.86	-33.94
14-Jun-2009	08:00:00	-23.95	-20.84	-22.77	-16.80	-25.22	-34.76
14-Jun-2009	20:00:00	-25.46	-21.91	-23.59	-17.68	-26.56	-34.95
15-Jun-2009	08:00:00	-25.90	-22.47	-24.41	-19.47	-26.86	-35.49
15-Jun-2009	20:00:00	-26.84	-23.13	-25.00	-20.02	-27.96	-35.70
16-Jun-2009	08:00:00	-27.18	-23.37	-25.62	-21.03	-28.31	-36.19
16-Jun-2009	20:00:00	-27.95	-23.45	-26.17	-21.60	-28.37	-36.31
17-Jun-2009	08:00:00	-28.15	-22.96	-26.46	-21.38	-28.55	-36.61
17-Jun-2009	20:00:00	-28.43	-22.02	-25.49	-19.99	-28.35	-36.50
18-Jun-2009	08:00:00	-27.95	-20.29	-24.88	-18.51	-27.52	-37.01
18-Jun-2009	20:00:00	-28.28	-20.82	-24.10	-17.43	-27.18	-36.99
19-Jun-2009	08:00:00	-28.38	-22.02	-24.89	-19.10	-27.18	-37.53
19-Jun-2009	20:00:00	-29.11	-23.49	-25.93	-20.17	-28.71	-37.60
20-Jun-2009	08:00:00	-29.44	-24.39	-26.70	-21.87	-28.93	-38.19
20-Jun-2009	20:00:00	-30.08	-25.12	-27.25	-22.21	-30.18	-38.38
21-Jun-2009	08:00:00	-30.42	-25.72	-27.79	-23.19	-30.20	-39.00
21-Jun-2009	20:00:00	-31.11	-26.35	-28.41	-23.95	-31.39	-39.99
22-Jun-2009	08:00:00	-31.48	-27.10	-29.22	-25.07	-32.09	-39.50
22-Jun-2009	20:00:00	-32.65	-27.50	-29.58	-25.40	-32.18	-40.15
23-Jun-2009	08:00:00	-33.51	-28.01	-30.24	-26.38	-32.18	-40.70
23-Jun-2009	20:00:00	-34.64	-28.61	-30.91	-27.26	-33.09	-41.02
24-Jun-2009	08:00:00	-35.01	-29.10	-31.57	-28.07	-33.13	-41.49
24-Jun-2009	20:00:00	-35.43	-29.61	-32.13	-28.61	-34.13	-41.83
25-Jun-2009	08:00:00	-35.81	-30.05	-32.79	-29.42	-33.95	-42.30
25-Jun-2009	20:00:00	-36.27	-30.59	-33.21	-29.84	-35.32	-42.59
26-Jun-2009	08:00:00	-36.34	-31.00	-33.71	-30.50	-35.31	-43.02
26-Jun-2009	20:00:00	-36.90	-31.40	-34.13	-31.06	-35.44	-43.28
27-Jun-2009	08:00:00	-37.42	-31.81	-34.61	-31.67	-35.53	-43.70
27-Jun-2009	20:00:00	-37.36	-32.24	-35.04	-32.17	-36.69	-43.99
28-Jun-2009	08:00:00	-37.97	-32.65	-35.54	-32.88	-36.67	-44.38
28-Jun-2009	20:00:00	-38.43	-33.12	-35.89	-33.38	-36.97	-44.57
29-Jun-2009	08:00:00	-38.63	-33.43	-36.21	-34.01	-37.25	-44.94
29-Jun-2009	20:00:00	-38.46	-33.83	-36.60	-34.60	-37.31	-45.22
30-Jun-2009	08:00:00	-39.25	-34.25	-37.10	-35.33	-37.44	-45.58
30-Jun-2009	20:00:00	-39.47	-34.72	-37.64	-35.89	-38.52	-45.88
01-Jul-2009	08:00:00	-39.49	-35.15	-38.34	-36.83	-38.16	-46.23
01-Jul-2009	20:00:00	-40.48	-35.60	-38.87	-37.25	-39.27	-46.46

Date	Time	Water Level (inches)					
		Jon AW1	Jon AW2	Jon AW3	Jon AW4	Jon AW5	Jon AW6
02-Jul-2009	08:00:00	-40.10	-35.98	-39.63	-38.20	-38.93	-46.64
02-Jul-2009	20:00:00	-40.61	-36.41	-40.26	-38.73	-39.28	-47.05
03-Jul-2009	08:00:00	-40.83	-36.83	-40.93	-39.59	-39.57	-47.35
03-Jul-2009	20:00:00	-41.43	-37.29	-41.52	-39.99	-40.32	-47.54
04-Jul-2009	08:00:00	-41.76	-37.74	-42.13	-40.58	-40.32	-47.81
04-Jul-2009	20:00:00	-42.96	-38.25	-42.44	-40.81	-41.48	-47.95
05-Jul-2009	08:00:00	-43.41	-38.64	-42.70	-41.31	-41.55	-48.09
05-Jul-2009	20:00:00	-43.55	-38.99	-42.77	-41.51	-41.62	-48.15
06-Jul-2009	08:00:00	-43.82	-39.24	-42.95	-42.14	-41.72	-48.37
06-Jul-2009	20:00:00	-43.91	-39.54	-43.29	-42.60	-41.97	-48.47
07-Jul-2009	08:00:00	-43.24	-39.88	-43.73	-43.10	-41.98	-48.72
07-Jul-2009	20:00:00	-43.23	-40.31	-44.17	-43.61	-42.42	-48.89
08-Jul-2009	08:00:00	-43.09	-40.70	-44.71	-44.33	-42.24	-49.07
08-Jul-2009	20:00:00	-42.78	-41.10	-45.19	-44.84	-42.39	-49.04
09-Jul-2009	08:00:00	-42.70	-41.43	-45.80	-45.50	-41.98	-49.07
09-Jul-2009	20:00:00	-43.45	-41.76	-46.48	-46.05	-42.14	-48.94
10-Jul-2009	08:00:00	-43.02	-42.04	-47.07	-46.56	-41.87	-49.23
10-Jul-2009	20:00:00	-43.44	-42.38	-47.39	-46.67	-42.65	-49.31
11-Jul-2009	08:00:00	-43.20	-42.66	-47.73	-47.17	-42.49	-49.40
11-Jul-2009	20:00:00	-43.98	-43.11	-47.74	-47.00	-43.65	-49.52
12-Jul-2009	08:00:00	-44.06	-43.55	-47.84	-47.44	-43.66	-49.68
12-Jul-2009	20:00:00	-44.06	-43.96	-47.84	-47.61	-43.42	-49.78
13-Jul-2009	08:00:00	-43.47	-44.36	-47.97	-48.05	-43.86	-49.67
13-Jul-2009	20:00:00	-43.68	-44.58	-48.10	-48.24	-43.96	-49.71
14-Jul-2009	08:00:00	-43.08	-44.85	-48.57	-48.87	-43.35	-50.03
14-Jul-2009	20:00:00	-43.21	-45.18	-49.04	-49.31	-43.52	-50.15
15-Jul-2009	08:00:00	-43.01	-45.46	-49.60	-49.93	-43.37	-50.24
15-Jul-2009	20:00:00	-43.99	-45.88	-49.84	-50.07	-44.43	-50.21
16-Jul-2009	08:00:00	-44.08	-46.28	-49.98	-50.42	-44.54	-50.43
16-Jul-2009	20:00:00	-44.08	-46.68	-50.07	-50.67	-44.58	-50.36
17-Jul-2009	08:00:00	-44.04	-47.19	-50.13	-50.60	-44.74	-50.63
17-Jul-2009	20:00:00	-43.76	-47.50	-50.24	-50.56	-44.16	-50.76
18-Jul-2009	08:00:00	-43.21	-47.98	-50.77	-50.63	-43.36	-50.97
18-Jul-2009	20:00:00	-43.16	-48.51	-51.34	-50.88	-44.42	-51.10
19-Jul-2009	08:00:00	-43.00	-49.13	-51.94	-51.00	-44.51	-51.20
19-Jul-2009	20:00:00	-43.68	-49.80	-52.28	-50.87	-44.75	-51.14
20-Jul-2009	08:00:00	-43.59	-50.46	-52.56	-50.83	-44.82	-51.40
20-Jul-2009	20:00:00	-43.53	-30.59	-49.75	-50.82	-40.57	-51.20
21-Jul-2009	08:00:00	-43.25	-37.26	-51.70	-50.83	-40.88	-51.05
21-Jul-2009	20:00:00	-43.57	-41.05	-52.46	-50.53	-42.65	-50.95
22-Jul-2009	08:00:00	-43.27	-43.33	-53.01	-50.34	-42.79	-50.90
22-Jul-2009	20:00:00	-44.05	-46.16	-52.53	-50.10	-43.97	-50.76
23-Jul-2009	08:00:00	-44.11	-48.04	-52.53	-49.97	-43.91	-50.84
23-Jul-2009	20:00:00	-44.07	-49.27	-52.54	-49.87	-44.24	-50.70
24-Jul-2009	08:00:00	-43.96	-40.32	-52.25	-46.47	-42.26	-50.70
24-Jul-2009	20:00:00	-44.06	-43.67	-52.22	-47.54	-43.20	-50.66
25-Jul-2009	08:00:00	-43.84	-46.66	-52.24	-47.68	-43.47	-50.57
25-Jul-2009	20:00:00	-44.11	-48.34	-52.24	-47.56	-43.67	-50.65
26-Jul-2009	08:00:00	-44.05	-49.55	-52.24	-48.22	-43.64	-50.76
26-Jul-2009	20:00:00	-44.07	-50.85	-52.24	-48.65	-44.56	-50.88
27-Jul-2009	08:00:00	-44.03	-52.06	-52.25	-49.51	-44.48	-50.74
27-Jul-2009	20:00:00	-44.11	-52.85	-52.24	-49.89	-45.04	-50.67

Date	Time	Water Level (inches)					
		Jon AW1	Jon AW2	Jon AW3	Jon AW4	Jon AW5	Jon AW6
28-Jul-2009	08:00:00	-44.09	-53.37	-52.25	-50.02	-45.09	-50.62
28-Jul-2009	20:00:00	-43.93	-53.71	-52.25	-47.67	-45.33	-50.43
29-Jul-2009	08:00:00	-43.78	-53.88	-52.25	-49.46	-45.40	-50.18
29-Jul-2009	20:00:00	-44.09	-53.96	-52.27	-49.57	-45.38	-50.33
30-Jul-2009	08:00:00	-43.71	-54.05	-52.26	-50.07	-44.92	-50.36
30-Jul-2009	20:00:00	-43.87	-54.15	-52.28	-50.10	-45.53	-50.22
31-Jul-2009	08:00:00	-43.79	-53.98	-52.26	-50.21	-45.30	-50.27
31-Jul-2009	20:00:00	-43.67	-54.23	-52.27	-48.45	-45.62	-50.09
01-Aug-2009	08:00:00	-43.48	-54.30	-52.25	-49.81	-45.23	-49.70
01-Aug-2009	20:00:00	-44.04	-54.29	-52.24	-49.78	-45.90	-49.42
02-Aug-2009	08:00:00	-44.17	-54.23	-52.23	-49.99	-45.88	-49.19
02-Aug-2009	20:00:00	-43.77	-54.03	-52.23	-50.18	-45.33	-49.20
03-Aug-2009	08:00:00	-43.50	-53.87	-52.16	-50.26	-44.98	-49.20
03-Aug-2009	20:00:00	-43.76	-53.81	-52.47	-50.27	-45.55	-49.28
04-Aug-2009	08:00:00	-43.93	-54.02	-52.26	-50.31	-45.54	-49.40
04-Aug-2009	20:00:00	-44.04	-54.27	-52.40	-50.31	-45.98	-49.52
05-Aug-2009	08:00:00	-44.06	-54.51	-52.14	-50.32	-46.00	-49.40
05-Aug-2009	20:00:00	-43.69	-54.39	-52.33	-50.25	-45.85	-49.45
06-Aug-2009	08:00:00	-43.45	-54.16	-51.90	-50.26	-46.03	-49.57
06-Aug-2009	20:00:00	-43.38	-53.46	-51.99	-50.29	-46.13	-49.75
07-Aug-2009	08:00:00	-43.30	-53.40	-52.02	-50.32	-45.14	-49.85
07-Aug-2009	20:00:00	-43.42	-53.45	-52.13	-50.31	-45.73	-50.37
08-Aug-2009	08:00:00	-43.24	-53.42	-52.02	-50.27	-45.00	-50.41
08-Aug-2009	20:00:00	-43.84	-53.48	-52.43	-50.28	-45.98	-50.21
09-Aug-2009	08:00:00	-43.33	-53.47	-52.03	-50.25	-45.44	-50.84
09-Aug-2009	20:00:00	-44.11	-53.55	-52.49	-50.31	-46.86	-50.55
10-Aug-2009	08:00:00	-44.07	-53.58	-52.39	-50.33	-46.94	-51.28
10-Aug-2009	20:00:00	-44.10	-53.58	-52.46	-50.24	-46.89	-50.73
11-Aug-2009	08:00:00	-44.12	-53.56	-52.24	-50.23	-47.22	-51.51
11-Aug-2009	20:00:00	-44.01	-53.58	-52.23	-50.19	-47.24	-51.03
12-Aug-2009	08:00:00	-43.84	-53.55	-52.22	-50.17	-47.48	-51.10
12-Aug-2009	20:00:00	-43.72	-53.60	-52.22	-50.19	-47.55	-50.67
13-Aug-2009	08:00:00	-43.35	-53.52	-52.23	-50.18	-47.43	-50.46
13-Aug-2009	20:00:00	-43.40	-53.56	-52.25	-50.20	-47.33	-50.12
14-Aug-2009	08:00:00	-43.32	-53.52	-52.25	-50.21	-46.82	-49.58
14-Aug-2009	20:00:00	-24.38	-26.63	-52.22	-50.09	-21.28	-48.60
15-Aug-2009	08:00:00	-28.86	-34.00	-52.24	-46.77	-17.61	-48.48
15-Aug-2009	20:00:00	-32.62	-38.70	-52.25	-45.34	-22.95	-47.99
16-Aug-2009	08:00:00	-35.00	-42.58	-52.25	-44.75	-25.95	-48.12
16-Aug-2009	20:00:00	-36.83	-46.37	-52.28	-43.93	-29.34	-47.84
17-Aug-2009	08:00:00	-37.97	-48.30	-52.27	-43.76	-31.04	-48.06
17-Aug-2009	20:00:00	-39.56	-50.27	-52.25	-43.49	-33.42	-47.76
18-Aug-2009	08:00:00	-40.36	-51.64	-52.24	-43.59	-34.83	-48.17
18-Aug-2009	20:00:00	-41.76	-52.26	-52.20	-43.81	-37.11	-48.09
19-Aug-2009	08:00:00	-42.44	-52.72	-52.21	-44.46	-38.09	-48.35
19-Aug-2009	20:00:00	-43.81	-53.03	-52.12	-44.99	-39.88	-48.32
20-Aug-2009	08:00:00	-43.71	-53.43	-52.16	-45.84	-40.11	-48.55
20-Aug-2009	20:00:00	-43.60	-53.73	-52.10	-46.42	-41.20	-48.50
21-Aug-2009	08:00:00	-44.12	-54.00	-52.10	-47.11	-41.37	-48.68
21-Aug-2009	20:00:00	-44.21	-54.27	-52.05	-47.68	-42.26	-48.70
22-Aug-2009	08:00:00	-44.18	-53.64	-52.05	-48.46	-42.60	-48.86
22-Aug-2009	20:00:00	-43.71	-52.65	-52.04	-47.29	-40.40	-47.97

Date	Time	Water Level (inches)					
		Jon AW1	Jon AW2	Jon AW3	Jon AW4	Jon AW5	Jon AW6
23-Aug-2009	08:00:00	-24.16	-30.64	-51.97	-41.61	-7.20	-47.30
23-Aug-2009	20:00:00	-28.97	-33.80	-51.98	-41.43	-11.47	-46.98
24-Aug-2009	08:00:00	-31.61	-35.41	-52.06	-41.16	-16.29	-47.24
24-Aug-2009	20:00:00	-34.82	-37.18	-52.08	-40.66	-23.54	-46.99
25-Aug-2009	08:00:00	-36.13	-38.46	-52.16	-40.45	-29.21	-47.47
25-Aug-2009	20:00:00	-37.98	-39.57	-52.13	-40.56	-32.41	-47.15
26-Aug-2009	08:00:00	-38.76	-40.38	-52.21	-41.14	-34.40	-47.63
26-Aug-2009	20:00:00	-40.50	-41.27	-52.12	-41.62	-36.01	-47.68
27-Aug-2009	08:00:00	-41.25	-42.61	-52.14	-42.30	-37.54	-47.85
27-Aug-2009	20:00:00	-42.55	-44.53	-52.10	-43.07	-38.95	-47.78
28-Aug-2009	08:00:00	-43.62	-45.96	-52.10	-43.68	-39.52	-47.65
28-Aug-2009	20:00:00	-44.26	-46.86	-52.05	-44.11	-39.99	-47.41
29-Aug-2009	08:00:00	-44.25	-47.64	-52.04	-44.54	-39.82	-47.73
29-Aug-2009	20:00:00	-44.00	-48.37	-52.05	-45.44	-40.52	-48.18
30-Aug-2009	08:00:00	-43.52	-49.00	-52.05	-46.76	-39.65	-48.41
30-Aug-2009	20:00:00	-43.41	-49.59	-52.05	-47.55	-40.80	-47.83
31-Aug-2009	08:00:00	-43.37	-36.53	-52.08	-43.70	-23.58	-47.36
31-Aug-2009	20:00:00	-43.40	-38.29	-52.10	-41.66	-21.72	-46.91
01-Sep-2009	08:00:00	-43.37	-39.49	-52.14	-41.75	-25.11	-47.32
01-Sep-2009	20:00:00	-43.67	-40.55	-52.14	-41.81	-29.06	-46.94
02-Sep-2009	08:00:00	-43.53	-41.42	-52.19	-42.07	-31.83	-47.31
02-Sep-2009	20:00:00	-44.20	-42.34	-52.13	-42.25	-35.26	-47.18
03-Sep-2009	08:00:00	-44.27	-43.18	-52.11	-42.70	-37.39	-47.36
03-Sep-2009	20:00:00	-44.26	-44.32	-52.08	-43.26	-38.84	-47.50
04-Sep-2009	08:00:00	-44.01	-45.42	-52.10	-44.26	-38.95	-47.87
04-Sep-2009	20:00:00	-44.13	-46.37	-52.10	-45.16	-39.93	-48.12
05-Sep-2009	08:00:00	-43.52	-47.46	-52.16	-46.21	-39.58	-48.34
05-Sep-2009	20:00:00	-43.68	-48.47	-52.16	-47.06	-40.94	-48.12
06-Sep-2009	08:00:00	-43.42	-50.27	-52.22	-47.98	-41.27	-48.72
06-Sep-2009	20:00:00	-43.88	-51.85	-52.18	-48.67	-41.68	-48.59
07-Sep-2009	08:00:00	-44.27	-52.65	-52.14	-49.16	-41.97	-48.73
07-Sep-2009	20:00:00	-44.29	-53.43	-52.09	-49.59	-42.12	-48.73
08-Sep-2009	08:00:00	-44.14	-54.09	-52.09	-50.25	-41.81	-48.86
08-Sep-2009	20:00:00	-44.23	-53.62	-52.09	-50.41	-42.25	-49.27
09-Sep-2009	08:00:00	-43.42	-53.57	-52.16	-50.35	-42.44	-49.44
09-Sep-2009	20:00:00	-43.77	-53.60	-52.12	-50.41	-42.72	-49.41
10-Sep-2009	08:00:00	-43.39	-53.52	-52.22	-50.33	-42.90	-49.67
10-Sep-2009	20:00:00	-43.44	-53.60	-52.22	-50.37	-43.17	-49.43
11-Sep-2009	08:00:00	-43.39	-53.63	-52.24	-50.36	-43.34	-49.84
11-Sep-2009	20:00:00	-44.29	-53.71	-52.12	-50.41	-43.86	-49.70
12-Sep-2009	08:00:00	-44.34	-53.76	-52.13	-50.42	-44.05	-49.90
12-Sep-2009	20:00:00	-44.27	-53.70	-52.07	-50.37	-44.13	-49.92
13-Sep-2009	08:00:00	-43.91	-53.67	-52.11	-50.39	-43.51	-50.28
13-Sep-2009	20:00:00	-44.12	-53.68	-52.08	-50.37	-44.14	-50.37
14-Sep-2009	08:00:00	-43.47	-53.64	-52.13	-50.39	-43.31	-50.69
14-Sep-2009	20:00:00	-43.99	-53.70	-52.10	-50.37	-44.23	-50.65
15-Sep-2009	08:00:00	-43.71	-53.70	-52.12	-50.38	-43.90	-50.86
15-Sep-2009	20:00:00	-44.04	-53.71	-52.10	-50.36	-44.63	-50.75
16-Sep-2009	08:00:00	-43.67	-53.68	-52.12	-50.37	-44.25	-51.03
16-Sep-2009	20:00:00	-43.45	-53.70	-52.13	-50.38	-44.15	-50.89
17-Sep-2009	08:00:00	-43.40	-53.67	-52.17	-50.37	-44.23	-51.10
17-Sep-2009	20:00:00	-43.51	-53.69	-52.16	-50.38	-45.36	-51.01

Date	Time						
dd-mmm-yyyy	hh:mm:ss	Jon AW7	Jon AW8	Jon AW9	Jon AW10	Jon AW11	Jon AW12
01-Jan-2009	08:00:00	2.77	-1.38	-6.94	0.04	-0.40	-0.22
01-Jan-2009	20:00:00	2.82	-1.06	-7.46	-0.33	-0.27	-0.11
02-Jan-2009	08:00:00	2.73	-0.45	-7.52	-0.95	-0.29	-0.18
02-Jan-2009	20:00:00	2.86	-0.61	-6.94	5.48	-0.30	-0.25
03-Jan-2009	08:00:00	2.49	-0.68	-7.59	2.77	-0.25	0.03
03-Jan-2009	20:00:00	2.36	-0.80	-8.06	2.55	-0.43	-0.15
04-Jan-2009	08:00:00	2.67	1.59	-8.30	1.45	0.70	0.82
04-Jan-2009	20:00:00	3.19	1.19	-3.29	1.71	0.25	0.31
05-Jan-2009	08:00:00	2.81	0.67	-3.33	1.80	0.01	0.14
05-Jan-2009	20:00:00	2.77	0.21	-3.17	2.11	0.10	0.19
06-Jan-2009	08:00:00	3.42	1.51	-3.21	8.86	0.68	0.78
06-Jan-2009	20:00:00	3.59	1.26	-0.88	8.29	0.13	0.06
07-Jan-2009	08:00:00	3.19	1.61	-0.64	7.35	0.96	1.00
07-Jan-2009	20:00:00	3.47	0.84	-0.29	8.08	0.42	0.40
08-Jan-2009	08:00:00	2.85	0.05	-1.26	6.11	0.08	0.08
08-Jan-2009	20:00:00	2.51	-0.62	-1.09	5.48	0.21	0.46
09-Jan-2009	08:00:00	1.93	-0.93	-2.10	4.26	-0.11	0.03
09-Jan-2009	20:00:00	1.74	-0.89	-2.12	4.04	-0.12	0.08
10-Jan-2009	08:00:00	1.63	-0.84	-2.35	3.59	-0.20	-0.01
10-Jan-2009	20:00:00	1.76	-0.64	-1.87	4.86	0.40	0.44
11-Jan-2009	08:00:00	2.42	1.38	-1.65	7.15	0.47	0.57
11-Jan-2009	20:00:00	2.08	0.68	-1.22	5.31	0.30	0.34
12-Jan-2009	08:00:00	1.64	-0.30	-1.89	3.85	-0.01	0.05
12-Jan-2009	20:00:00	1.43	-0.74	-2.25	2.91	-0.03	0.13
13-Jan-2009	08:00:00	1.48	-0.46	-2.43	2.88	-0.04	0.00
13-Jan-2009	20:00:00	1.57	-0.62	-1.87	3.95	-0.02	0.15
14-Jan-2009	08:00:00	1.23	-1.10	-2.72	1.88	-0.25	-0.10
14-Jan-2009	20:00:00	1.22	-0.80	-3.54	1.57	-0.17	0.01
15-Jan-2009	08:00:00	1.06	-1.10	-3.92	0.65	-0.39	-0.23
15-Jan-2009	20:00:00	0.91	-0.98	-4.88	0.05	-0.34	-0.15
16-Jan-2009	08:00:00	0.51	-1.96	-6.21	-2.46	-0.83	-0.58
16-Jan-2009	20:00:00	0.70	-1.09	-7.14	-0.72	-0.62	-0.33
17-Jan-2009	08:00:00	0.28	-2.68	-8.01	-4.15	-1.45	-1.23
17-Jan-2009	20:00:00	0.86	-0.53	-8.37	-2.92	-0.82	-0.54
18-Jan-2009	08:00:00	1.14	0.21	-6.80	-1.41	-0.45	-0.32
18-Jan-2009	20:00:00	1.55	1.32	-5.53	6.20	0.05	0.12
19-Jan-2009	08:00:00	1.45	0.74	-5.00	5.13	-0.18	-0.04
19-Jan-2009	20:00:00	1.48	0.93	-5.14	7.38	-0.11	0.12
20-Jan-2009	08:00:00	1.71	1.29	-5.15	5.34	0.10	0.36
20-Jan-2009	20:00:00	1.41	1.15	-4.77	4.28	-0.03	0.13
21-Jan-2009	08:00:00	0.77	-0.73	-5.69	0.47	-0.56	-0.32
21-Jan-2009	20:00:00	1.12	1.29	-5.91	2.99	-0.04	0.11
22-Jan-2009	08:00:00	0.67	-0.50	-5.86	-1.62	-0.57	-0.49
22-Jan-2009	20:00:00	1.14	1.32	-5.58	1.26	0.12	0.15
23-Jan-2009	08:00:00	0.91	0.33	-5.47	-0.42	-0.37	-0.24
23-Jan-2009	20:00:00	1.17	1.32	-5.51	1.20	0.05	0.22
24-Jan-2009	08:00:00	1.14	1.17	-5.25	1.11	-0.27	-0.02
24-Jan-2009	20:00:00	1.00	0.80	-5.75	0.79	-0.21	0.12
25-Jan-2009	08:00:00	0.76	0.36	-6.74	-1.28	-0.33	-0.02
25-Jan-2009	20:00:00	0.77	-0.23	-7.47	-1.64	-0.38	0.02
26-Jan-2009	08:00:00	0.63	-0.37	-7.77	-2.17	-0.47	-0.08
26-Jan-2009	20:00:00	0.63	-0.47	-8.47	-2.49	-0.45	-0.03

Date	Time						
dd-mmm-yyyy	hh:mm:ss	Jon AW7	Jon AW8	Jon AW9	Jon AW10	Jon AW11	Jon AW12
27-Jan-2009	08:00:00	0.60	-0.38	-8.59	-2.82	-0.61	-0.15
27-Jan-2009	20:00:00	0.79	-0.34	-8.74	3.98	-0.44	0.08
28-Jan-2009	08:00:00	1.02	0.48	-8.02	5.95	-0.09	-0.04
28-Jan-2009	20:00:00	1.60	1.29	-5.62	12.75	0.39	0.63
29-Jan-2009	08:00:00	1.52	0.93	-4.48	5.23	-0.01	0.26
29-Jan-2009	20:00:00	1.25	0.10	-4.59	4.44	-0.07	0.17
30-Jan-2009	08:00:00	1.09	-0.42	-5.05	3.47	-0.28	0.02
30-Jan-2009	20:00:00	1.00	-0.76	-5.70	3.14	-0.25	-0.04
31-Jan-2009	08:00:00	0.71	-1.34	-6.91	1.76	-0.57	-0.33
31-Jan-2009	20:00:00	0.69	-0.89	-8.18	1.59	-0.42	-0.14
01-Feb-2009	08:00:00	0.57	-1.24	-8.47	0.83	-0.68	-0.47
01-Feb-2009	20:00:00	0.67	-0.70	-9.16	1.53	-0.45	-0.24
02-Feb-2009	08:00:00	0.72	-0.81	-9.00	0.92	-0.64	-0.44
02-Feb-2009	20:00:00	0.87	-0.50	-9.18	1.06	-0.40	-0.11
03-Feb-2009	08:00:00	1.53	1.12	-6.57	6.75	-0.01	0.17
03-Feb-2009	20:00:00	1.34	0.60	-5.46	4.74	-0.03	0.09
04-Feb-2009	08:00:00	1.10	0.43	-5.30	3.87	-0.18	-0.02
04-Feb-2009	20:00:00	0.94	0.79	-6.81	2.41	-0.14	0.04
05-Feb-2009	08:00:00	0.55	-1.56	-7.35	0.34	-0.62	-0.52
05-Feb-2009	20:00:00	0.73	-0.16	-8.73	0.46	-0.35	-0.18
06-Feb-2009	08:00:00	0.44	-2.05	-8.75	-3.08	-0.92	-0.85
06-Feb-2009	20:00:00	0.77	0.54	-9.52	0.66	-0.19	-0.12
07-Feb-2009	08:00:00	0.64	-0.84	-8.92	-1.33	-0.65	-0.57
07-Feb-2009	20:00:00	0.76	0.36	-9.91	4.20	-0.14	0.04
08-Feb-2009	08:00:00	0.76	-0.13	-9.35	-0.39	-0.55	-0.32
08-Feb-2009	20:00:00	0.76	-0.47	-9.91	-0.41	-0.32	-0.10
09-Feb-2009	08:00:00	0.64	-0.56	-10.17	-1.83	-0.61	-0.46
09-Feb-2009	20:00:00	0.58	-0.72	-11.71	-2.03	-0.44	-0.19
10-Feb-2009	08:00:00	0.59	-0.53	-11.43	-2.59	-0.53	-0.27
10-Feb-2009	20:00:00	0.66	-0.73	-11.52	-0.46	-0.43	-0.15
11-Feb-2009	08:00:00	0.70	-0.61	-11.30	-2.61	-1.12	-0.65
11-Feb-2009	20:00:00	0.87	-0.65	-11.54	-0.83	-0.43	-0.36
12-Feb-2009	08:00:00	0.75	-0.82	-9.95	-1.71	-1.10	-0.86
12-Feb-2009	20:00:00	0.64	-1.22	-12.68	-2.90	-0.74	-0.26
13-Feb-2009	08:00:00	0.55	-0.98	-13.76	-4.17	-1.04	-0.68
13-Feb-2009	20:00:00	0.55	-1.10	-14.33	-4.39	-0.90	-0.37
14-Feb-2009	08:00:00	0.62	-0.68	-14.15	-4.94	-0.99	-0.45
14-Feb-2009	20:00:00	0.73	-0.74	-13.78	-4.62	-0.76	-0.26
15-Feb-2009	08:00:00	0.53	-0.90	-13.99	-5.72	-1.19	-0.70
15-Feb-2009	20:00:00	0.50	-1.01	-15.95	-5.95	-1.04	-0.31
16-Feb-2009	08:00:00	0.64	0.59	-15.49	-6.41	-0.75	-0.26
16-Feb-2009	20:00:00	0.57	-0.51	-13.92	-6.66	-0.77	-0.20
17-Feb-2009	08:00:00	0.37	-1.09	-14.78	-7.39	-1.03	-0.56
17-Feb-2009	20:00:00	0.48	-0.82	-15.75	1.38	-0.81	-0.28
18-Feb-2009	08:00:00	0.60	0.95	-15.18	-9.04	0.48	0.37
18-Feb-2009	20:00:00	1.72	1.18	-9.88	1.91	0.33	0.39
19-Feb-2009	08:00:00	2.29	1.11	-5.32	4.00	-0.33	-0.29
19-Feb-2009	20:00:00	1.41	0.24	-3.83	5.94	0.24	0.27
20-Feb-2009	08:00:00	0.92	-0.53	-5.40	4.73	-0.24	-0.22
20-Feb-2009	20:00:00	0.77	-0.95	-6.82	5.10	-0.22	-0.08
21-Feb-2009	08:00:00	0.44	-1.30	-7.36	14.36	-0.48	-0.50
21-Feb-2009	20:00:00	0.59	-0.89	-9.05	0.64	-0.28	-0.19

Date	Time						
dd-mmm-yyyy	hh:mm:ss	Jon AW7	Jon AW8	Jon AW9	Jon AW10	Jon AW11	Jon AW12
22-Feb-2009	08:00:00	0.69	-0.45	-8.44	-3.91	-0.37	-0.23
22-Feb-2009	20:00:00	0.41	-1.30	-8.18	0.39	-0.45	-0.34
23-Feb-2009	08:00:00	0.21	-1.13	-11.49	-1.56	-0.67	-0.71
23-Feb-2009	20:00:00	0.25	-1.35	-13.01	-1.91	-0.59	-0.55
24-Feb-2009	08:00:00	-0.01	-1.82	-12.90	-3.25	-1.06	-1.05
24-Feb-2009	20:00:00	0.11	-1.11	-14.38	-3.35	-0.70	-0.65
25-Feb-2009	08:00:00	0.02	-0.81	-14.04	-3.52	-0.96	-0.85
25-Feb-2009	20:00:00	0.13	-1.02	-15.14	-3.32	-0.65	-0.52
26-Feb-2009	08:00:00	0.15	-0.75	-14.66	-3.16	-0.94	-0.80
26-Feb-2009	20:00:00	0.26	-0.82	-15.31	-1.36	-0.95	-0.69
27-Feb-2009	08:00:00	0.34	-0.62	-14.46	0.11	-1.71	-1.39
27-Feb-2009	20:00:00	0.61	0.01	-14.38	3.39	-0.60	-0.24
28-Feb-2009	08:00:00	0.90	1.32	-12.89	3.39	0.49	0.44
28-Feb-2009	20:00:00	3.69	1.51	-9.26	3.97	1.34	1.23
01-Mar-2009	08:00:00	2.69	1.41	-2.63	3.77	0.96	0.81
01-Mar-2009	20:00:00	4.04	1.56	-1.17	3.62	2.85	1.17
02-Mar-2009	08:00:00	2.77	1.29	0.76	3.45	0.56	0.59
02-Mar-2009	20:00:00	1.82	1.10	0.14	3.38	0.36	0.33
03-Mar-2009	08:00:00	1.13	0.33	-0.26	3.27	0.14	-0.18
03-Mar-2009	20:00:00	1.22	0.66	-0.68	3.25	0.20	0.15
04-Mar-2009	08:00:00	0.90	-1.05	-0.74	3.15	-0.01	-0.44
04-Mar-2009	20:00:00	1.12	0.50	-1.18	3.12	0.17	0.13
05-Mar-2009	08:00:00	0.94	-0.41	-0.94	3.09	-0.10	-0.27
05-Mar-2009	20:00:00	1.01	-0.16	-1.57	3.01	0.15	0.10
06-Mar-2009	08:00:00	0.99	-0.18	-1.06	2.98	-0.58	-0.47
06-Mar-2009	20:00:00	1.04	-0.51	-1.62	2.94	0.22	0.18
07-Mar-2009	08:00:00	1.02	-0.38	-1.34	2.59	-0.79	-0.60
07-Mar-2009	20:00:00	1.06	-0.67	-2.01	2.49	0.31	0.24
08-Mar-2009	08:00:00	1.06	-0.43	-1.99	2.48	-1.26	-0.51
08-Mar-2009	20:00:00	1.06	-0.81	-2.64	2.33	0.27	-0.08
09-Mar-2009	08:00:00	1.02	-0.52	-2.95	2.29	-1.27	-0.09
09-Mar-2009	20:00:00	0.93	-0.97	-3.83	2.15	-0.02	-0.20
10-Mar-2009	08:00:00	0.83	-0.79	-4.47	2.22	-0.96	-0.24
10-Mar-2009	20:00:00	0.81	-0.97	-5.60	2.05	-0.14	-0.30
11-Mar-2009	08:00:00	0.86	-0.63	-6.04	2.07	-0.88	-0.25
11-Mar-2009	20:00:00	0.88	-1.06	-6.43	1.85	-0.20	-0.35
12-Mar-2009	08:00:00	0.67	-1.08	-6.81	1.97	-1.07	-0.40
12-Mar-2009	20:00:00	0.61	-1.45	-8.33	2.22	-0.34	-0.58
13-Mar-2009	08:00:00	0.53	-1.27	-9.03	2.17	-0.51	-0.65
13-Mar-2009	20:00:00	0.85	0.49	-9.80	2.39	-0.16	-0.23
14-Mar-2009	08:00:00	1.02	-0.22	-7.53	2.52	-0.10	-0.17
14-Mar-2009	20:00:00	1.48	1.17	-7.78	2.61	0.28	0.41
15-Mar-2009	08:00:00	1.56	1.22	-5.08	2.55	0.26	0.47
15-Mar-2009	20:00:00	2.01	1.20	-3.83	2.77	0.43	0.47
16-Mar-2009	08:00:00	1.82	1.06	-2.48	2.82	0.21	0.37
16-Mar-2009	20:00:00	1.92	1.20	-2.34	2.68	0.43	0.57
17-Mar-2009	08:00:00	1.90	1.09	-1.84	2.67	0.21	0.43
17-Mar-2009	20:00:00	1.50	0.50	-1.57	2.53	0.27	0.26
18-Mar-2009	08:00:00	1.32	-0.02	-1.72	2.54	0.02	0.20
18-Mar-2009	20:00:00	1.28	-0.46	-2.22	2.45	0.22	0.18
19-Mar-2009	08:00:00	1.25	-0.44	-1.99	2.72	-0.98	0.14
19-Mar-2009	20:00:00	1.28	-0.53	-2.43	2.46	0.03	0.10

Date	Time						
dd-mmm-yyyy	hh:mm:ss	Jon AW7	Jon AW8	Jon AW9	Jon AW10	Jon AW11	Jon AW12
20-Mar-2009	08:00:00	1.84	0.91	-2.44	2.43	-0.26	0.41
20-Mar-2009	20:00:00	1.36	-0.62	-2.25	2.35	0.18	0.18
21-Mar-2009	08:00:00	1.11	-0.58	-2.61	2.40	-0.42	0.06
21-Mar-2009	20:00:00	1.04	-0.98	-3.73	2.31	-0.04	-0.02
22-Mar-2009	08:00:00	0.99	-0.71	-3.80	2.29	-0.66	-0.06
22-Mar-2009	20:00:00	1.01	-1.06	-4.77	2.20	-0.07	-0.10
23-Mar-2009	08:00:00	1.00	-0.83	-4.50	2.24	-0.58	-0.13
23-Mar-2009	20:00:00	1.03	-1.13	-5.36	2.03	-0.22	-0.25
24-Mar-2009	08:00:00	0.97	-0.96	-5.83	2.17	-0.50	-0.28
24-Mar-2009	20:00:00	0.86	-1.37	-7.14	2.22	-0.36	-0.35
25-Mar-2009	08:00:00	0.79	-1.27	-7.52	2.41	-0.60	-0.38
25-Mar-2009	20:00:00	0.93	-0.17	-8.26	2.36	-0.24	-0.25
26-Mar-2009	08:00:00	1.52	0.47	-8.26	2.31	-0.20	0.12
26-Mar-2009	20:00:00	1.56	-0.18	-5.41	2.38	0.53	0.17
27-Mar-2009	08:00:00	1.46	-0.37	-5.16	2.29	-0.44	0.17
27-Mar-2009	20:00:00	1.66	0.12	-5.99	3.36	0.13	0.31
28-Mar-2009	08:00:00	1.58	-0.19	-5.02	3.10	-0.09	0.25
28-Mar-2009	20:00:00	3.63	1.49	-5.69	2.87	1.23	1.25
29-Mar-2009	08:00:00	2.55	1.07	-2.02	2.93	-0.43	0.55
29-Mar-2009	20:00:00	1.78	-0.66	-0.76	2.69	0.45	0.26
30-Mar-2009	08:00:00	1.39	-0.67	-1.16	2.71	-0.70	0.17
30-Mar-2009	20:00:00	1.22	-1.04	-2.18	2.60	0.15	0.05
31-Mar-2009	08:00:00	1.12	-0.83	-1.94	2.66	-0.39	0.01
31-Mar-2009	20:00:00	1.11	-0.98	-2.41	2.55	-0.04	-0.02
01-Apr-2009	08:00:00	1.18	-0.09	-2.07	2.84	-0.13	0.11
01-Apr-2009	20:00:00	1.35	-0.66	-2.08	2.84	0.34	0.08
02-Apr-2009	08:00:00	1.56	0.62	-1.98	2.92	0.33	0.34
02-Apr-2009	20:00:00	2.05	1.13	-2.13	2.52	0.51	0.60
03-Apr-2009	08:00:00	2.37	1.20	-1.09	2.54	0.27	0.69
03-Apr-2009	20:00:00	1.79	-0.62	-0.68	2.30	0.58	0.33
04-Apr-2009	08:00:00	1.45	-0.70	-1.26	2.35	-0.65	0.22
04-Apr-2009	20:00:00	1.29	-1.18	-2.62	2.22	0.16	0.09
05-Apr-2009	08:00:00	1.15	-0.98	-3.07	2.61	-1.25	0.04
05-Apr-2009	20:00:00	1.07	-1.44	-4.21	2.27	0.12	-0.10
06-Apr-2009	08:00:00	1.26	0.82	-4.75	2.25	0.94	0.74
06-Apr-2009	20:00:00	1.47	-0.98	-4.58	1.91	0.40	0.22
07-Apr-2009	08:00:00	1.15	-1.13	-2.92	1.88	-0.18	0.13
07-Apr-2009	20:00:00	0.95	-1.64	-4.73	1.57	-0.01	-0.10
08-Apr-2009	08:00:00	0.81	-1.45	-5.98	1.30	-0.91	-0.19
08-Apr-2009	20:00:00	0.73	-1.83	-7.98	1.03	-0.45	-0.39
09-Apr-2009	08:00:00	0.59	-1.67	-8.40	0.62	-1.94	-0.48
09-Apr-2009	20:00:00	0.47	-2.10	-9.40	0.37	-0.80	-0.78
10-Apr-2009	08:00:00	0.43	-1.75	-11.14	2.73	-2.53	-0.87
10-Apr-2009	20:00:00	0.41	-1.99	-12.04	2.16	-0.88	-0.99
11-Apr-2009	08:00:00	2.40	1.12	-11.90	2.03	-0.27	0.51
11-Apr-2009	20:00:00	1.44	-0.88	-3.52	1.85	0.33	0.16
12-Apr-2009	08:00:00	1.13	-1.21	-2.80	1.91	-0.88	0.01
12-Apr-2009	20:00:00	0.90	-1.69	-4.46	2.19	-0.10	-0.16
13-Apr-2009	08:00:00	0.77	-1.24	-4.80	2.31	-0.47	-0.17
13-Apr-2009	20:00:00	0.88	-1.15	-6.16	2.87	-0.20	-0.15
14-Apr-2009	08:00:00	1.04	-0.94	-5.60	2.24	-0.24	-0.09
14-Apr-2009	20:00:00	2.00	1.16	-5.47	1.93	0.62	0.61

Date	Time						
dd-mmm-yyyy	hh:mm:ss	Jon AW7	Jon AW8	Jon AW9	Jon AW10	Jon AW11	Jon AW12
15-Apr-2009	08:00:00	1.69	0.18	-2.60	1.75	0.07	0.36
15-Apr-2009	20:00:00	1.37	-1.20	-2.87	1.19	0.25	0.18
16-Apr-2009	08:00:00	1.23	-1.27	-4.17	0.45	-0.74	0.08
16-Apr-2009	20:00:00	1.03	-1.82	-5.66	0.33	-0.18	-0.18
17-Apr-2009	08:00:00	0.96	-1.59	-6.60	-0.06	-1.49	-0.31
17-Apr-2009	20:00:00	0.81	-2.10	-8.49	-0.52	-0.51	-0.57
18-Apr-2009	08:00:00	0.72	-1.79	-9.47	-0.84	-2.11	-0.68
18-Apr-2009	20:00:00	0.58	-2.26	-10.25	-1.09	-0.53	-0.99
19-Apr-2009	08:00:00	0.55	-1.92	-11.25	0.25	-2.47	-1.09
19-Apr-2009	20:00:00	0.46	-2.08	-12.28	0.28	-1.04	-1.25
20-Apr-2009	08:00:00	0.92	0.66	-12.45	-0.16	-1.12	-0.53
20-Apr-2009	20:00:00	0.80	-1.64	-11.90	-0.89	-0.17	-0.90
21-Apr-2009	08:00:00	0.70	-1.60	-9.09	-1.61	-1.90	-0.99
21-Apr-2009	20:00:00	0.56	-2.28	-11.29	-3.34	-0.88	-1.42
22-Apr-2009	08:00:00	0.50	-2.29	-12.58	-4.26	-2.18	-1.62
22-Apr-2009	20:00:00	0.40	-2.90	-14.46	-6.29	-1.62	-2.18
23-Apr-2009	08:00:00	0.36	-2.64	-16.08	-6.74	-3.64	-2.41
23-Apr-2009	20:00:00	0.32	-3.38	-17.34	-8.94	-2.14	-3.22
24-Apr-2009	08:00:00	0.39	-2.96	-18.05	-8.93	-4.07	-3.41
24-Apr-2009	20:00:00	1.01	-3.97	-19.01	-11.77	-3.20	-4.99
25-Apr-2009	08:00:00	0.93	-3.46	-19.36	-12.28	-5.51	-5.11
25-Apr-2009	20:00:00	0.65	-5.17	-20.28	-14.49	-5.14	-8.20
26-Apr-2009	08:00:00	0.55	-4.59	-20.54	-15.35	-7.12	-8.61
26-Apr-2009	20:00:00	0.26	-7.28	-21.53	-16.94	-7.46	-11.54
27-Apr-2009	08:00:00	0.14	-6.28	-21.68	-17.97	-9.09	-12.39
27-Apr-2009	20:00:00	-0.20	-10.27	-22.86	-18.78	-9.45	-15.22
28-Apr-2009	08:00:00	-0.32	-8.92	-23.06	-19.63	-11.08	-16.11
28-Apr-2009	20:00:00	-0.73	-12.56	-23.85	-20.13	-10.67	-17.80
29-Apr-2009	08:00:00	-0.83	-10.34	-24.03	-21.09	-11.80	-18.20
29-Apr-2009	20:00:00	-1.24	-13.85	-24.74	-21.14	-11.23	-19.26
30-Apr-2009	08:00:00	-1.41	-11.64	-24.88	-21.90	-11.92	-19.62
30-Apr-2009	20:00:00	-1.95	-14.42	-25.97	-21.98	-12.09	-20.29
01-May-2009	08:00:00	-2.04	-11.10	-25.88	-22.36	-12.38	-20.31
01-May-2009	20:00:00	-3.23	-15.54	-26.38	-20.60	-12.12	-21.01
02-May-2009	08:00:00	-3.11	-11.98	-26.12	-14.21	-12.45	-21.26
02-May-2009	20:00:00	-0.67	-0.75	-26.67	-14.85	-1.46	-19.22
03-May-2009	08:00:00	-1.27	-1.74	-27.16	-16.22	-3.11	-12.82
03-May-2009	20:00:00	-1.68	-2.72	-26.36	-17.56	-4.29	-15.06
04-May-2009	08:00:00	-1.88	-2.86	-24.92	-6.82	-6.50	-15.98
04-May-2009	20:00:00	-2.30	-2.96	-24.96	-0.69	-6.85	-17.51
05-May-2009	08:00:00	-0.18	1.32	-25.86	-0.76	-1.06	-0.95
05-May-2009	20:00:00	0.29	0.60	-26.43	-1.57	-0.17	-2.03
06-May-2009	08:00:00	0.44	0.37	-20.27	-1.81	-1.02	-1.76
06-May-2009	20:00:00	0.39	-0.34	-17.86	-3.39	-0.66	-1.75
07-May-2009	08:00:00	0.37	-0.51	-17.75	-4.41	-1.80	-1.68
07-May-2009	20:00:00	0.16	-2.02	-18.44	-7.05	-0.66	-2.48
08-May-2009	08:00:00	0.07	-1.86	-19.21	-7.75	-2.32	-2.60
08-May-2009	20:00:00	-0.13	-2.68	-20.91	-12.83	-1.03	-3.62
09-May-2009	08:00:00	-0.23	-2.51	-22.29	-13.39	-3.41	-3.74
09-May-2009	20:00:00	-0.74	-4.62	-22.92	-16.21	-2.30	-8.59
10-May-2009	08:00:00	-0.88	-4.56	-23.80	-2.20	-4.80	-9.25
10-May-2009	20:00:00	-1.55	-7.76	-25.58	-1.02	-5.44	-13.65

Date	Time						
dd-mmm-yyyy	hh:mm:ss	Jon AW7	Jon AW8	Jon AW9	Jon AW10	Jon AW11	Jon AW12
11-May-2009	08:00:00	0.35	0.91	-27.04	-1.65	-0.47	-1.28
11-May-2009	20:00:00	0.29	0.54	-27.66	-4.77	-0.37	-1.55
12-May-2009	08:00:00	0.24	0.15	-25.20	-6.35	-1.39	-1.54
12-May-2009	20:00:00	-0.03	-1.85	-23.52	-10.19	-0.56	-2.28
13-May-2009	08:00:00	-0.15	-1.94	-23.56	-10.63	-2.22	-2.42
13-May-2009	20:00:00	-0.44	-3.11	-24.93	-9.17	-1.17	-3.64
14-May-2009	08:00:00	-0.57	-1.38	-26.00	-9.78	-0.93	-2.84
14-May-2009	20:00:00	-0.46	-1.33	-26.88	-13.63	-1.66	-3.12
15-May-2009	08:00:00	-0.52	-1.31	-27.25	-13.92	-2.00	-3.14
15-May-2009	20:00:00	-0.92	-3.02	-27.85	-13.57	-1.74	-5.82
16-May-2009	08:00:00	-1.00	-2.82	-28.42	-13.79	-2.79	-5.72
16-May-2009	20:00:00	-1.02	-2.32	-29.11	-12.47	-2.12	-5.61
17-May-2009	08:00:00	-1.18	-2.32	-29.59	-1.78	-3.27	-6.05
17-May-2009	20:00:00	-0.52	0.93	-30.11	-4.45	-0.59	-0.53
18-May-2009	08:00:00	0.07	0.93	-30.64	-6.99	-1.08	-1.36
18-May-2009	20:00:00	-0.26	0.08	-30.48	-11.95	-0.49	-2.27
19-May-2009	08:00:00	-0.44	-0.75	-29.16	-13.27	-1.92	-2.50
19-May-2009	20:00:00	-0.96	-2.74	-29.33	-16.47	-1.12	-4.53
20-May-2009	08:00:00	-1.12	-2.87	-30.01	-16.96	-2.96	-4.82
20-May-2009	20:00:00	-1.79	-4.22	-30.90	-18.75	-2.08	-9.06
21-May-2009	08:00:00	-1.86	-3.79	-31.60	-19.82	-3.21	-8.75
21-May-2009	20:00:00	-3.32	-6.73	-32.41	-20.61	-4.02	-13.70
22-May-2009	08:00:00	-3.25	-6.27	-33.20	-21.52	-6.04	-14.28
22-May-2009	20:00:00	-4.51	-8.88	-33.82	-22.10	-5.91	-16.88
23-May-2009	08:00:00	-4.51	-7.81	-34.47	-22.64	-7.97	-17.20
23-May-2009	20:00:00	-5.94	-9.51	-35.45	-4.26	-7.63	-18.44
24-May-2009	08:00:00	-2.62	-0.07	-35.97	-4.34	-1.20	-13.46
24-May-2009	20:00:00	-1.17	0.91	-36.55	-0.07	-1.03	-2.23
25-May-2009	08:00:00	-1.39	0.69	-36.54	-0.53	-1.30	-2.72
25-May-2009	20:00:00	0.17	1.07	-35.36	2.97	0.05	0.17
26-May-2009	08:00:00	0.29	1.30	-34.27	2.40	0.18	0.61
26-May-2009	20:00:00	5.42	1.67	-31.05	1.35	1.92	1.99
27-May-2009	08:00:00	3.98	0.99	-25.98	1.05	-0.29	0.12
27-May-2009	20:00:00	2.64	0.30	-14.00	3.11	0.00	-0.30
28-May-2009	08:00:00	2.17	0.33	-6.44	2.74	-1.05	-0.43
28-May-2009	20:00:00	4.02	1.47	-7.03	2.43	1.57	1.77
29-May-2009	08:00:00	4.14	0.91	-7.59	2.16	-0.80	0.09
29-May-2009	20:00:00	2.92	0.00	-3.90	1.29	0.33	-0.35
30-May-2009	08:00:00	2.46	-0.27	-2.79	1.07	-1.40	-0.53
30-May-2009	20:00:00	2.00	-2.03	-3.50	0.76	-0.13	-1.13
31-May-2009	08:00:00	1.85	-1.78	-5.00	0.10	-1.93	-1.26
31-May-2009	20:00:00	1.51	-3.76	-7.45	-0.90	-0.48	-2.23
01-Jun-2009	08:00:00	1.38	-3.44	-9.00	-1.25	-3.20	-2.46
01-Jun-2009	20:00:00	1.02	-6.12	-12.71	-3.19	-1.14	-4.91
02-Jun-2009	08:00:00	0.88	-5.36	-14.71	-3.99	-4.07	-4.99
02-Jun-2009	20:00:00	0.54	-10.11	-16.52	-8.63	-3.36	-10.37
03-Jun-2009	08:00:00	0.39	-8.34	-17.41	-9.44	-6.22	-10.72
03-Jun-2009	20:00:00	0.00	-14.74	-18.75	-0.36	-7.20	-15.75
04-Jun-2009	08:00:00	-0.10	-11.50	-19.54	-0.31	-8.19	-16.38
04-Jun-2009	20:00:00	0.39	-0.19	-20.63	-0.99	-1.19	-4.00
05-Jun-2009	08:00:00	0.86	0.59	-21.32	-0.90	-1.69	-2.35
05-Jun-2009	20:00:00	0.72	-0.34	-17.74	-2.25	-0.78	-4.63

Date	Time						
dd-mmm-yyyy	hh:mm:ss	Jon AW7	Jon AW8	Jon AW9	Jon AW10	Jon AW11	Jon AW12
06-Jun-2009	08:00:00	0.64	-0.58	-15.72	-2.78	-2.27	-5.06
06-Jun-2009	20:00:00	0.37	-2.32	-17.15	-5.95	-1.25	-9.65
07-Jun-2009	08:00:00	0.25	-2.33	-18.05	-6.25	-2.56	-10.54
07-Jun-2009	20:00:00	-0.05	-4.14	-19.30	-11.06	-2.49	-14.49
08-Jun-2009	08:00:00	-0.15	-3.67	-20.11	-10.97	-4.23	-15.14
08-Jun-2009	20:00:00	-0.54	-6.96	-20.89	-14.22	-5.03	-18.04
09-Jun-2009	08:00:00	-0.65	-6.10	-21.55	-12.80	-7.95	-18.38
09-Jun-2009	20:00:00	-0.93	-6.32	-22.39	-16.39	-6.21	-19.55
10-Jun-2009	08:00:00	-1.13	-6.63	-23.49	-11.83	-8.90	-18.79
10-Jun-2009	20:00:00	-1.93	-10.82	-24.60	-14.58	-9.29	-20.83
11-Jun-2009	08:00:00	-1.29	-4.29	-25.31	-14.67	-6.92	-17.86
11-Jun-2009	20:00:00	-1.65	-5.40	-26.38	-18.05	-6.99	-19.98
12-Jun-2009	08:00:00	-1.94	-5.78	-26.47	-19.35	-8.18	-20.17
12-Jun-2009	20:00:00	-3.34	-11.97	-26.83	-20.34	-11.67	-21.59
13-Jun-2009	08:00:00	-3.38	-10.64	-27.04	-21.18	-14.30	-22.31
13-Jun-2009	20:00:00	-5.48	-17.05	-28.22	-22.72	-13.46	-22.92
14-Jun-2009	08:00:00	-5.59	-14.70	-29.23	-23.46	-15.58	-23.50
14-Jun-2009	20:00:00	-11.32	-19.71	-30.14	-24.33	-14.90	-23.98
15-Jun-2009	08:00:00	-11.70	-17.05	-31.36	-24.91	-16.85	-24.45
15-Jun-2009	20:00:00	-14.61	-20.16	-32.22	-25.27	-15.82	-24.83
16-Jun-2009	08:00:00	-12.38	-12.55	-33.02	-25.60	-13.06	-25.23
16-Jun-2009	20:00:00	-16.22	-17.85	-33.83	-25.51	-14.94	-25.62
17-Jun-2009	08:00:00	-8.91	-6.13	-34.60	-24.69	-12.45	-25.99
17-Jun-2009	20:00:00	-13.00	-10.65	-35.45	-24.52	-13.06	-26.12
18-Jun-2009	08:00:00	-7.14	-4.21	-35.81	-24.56	-10.28	-26.22
18-Jun-2009	20:00:00	-12.72	-9.20	-35.71	-25.78	-12.72	-26.21
19-Jun-2009	08:00:00	-13.83	-9.87	-35.73	-25.90	-15.89	-26.40
19-Jun-2009	20:00:00	-17.64	-16.73	-35.99	-26.69	-15.69	-26.68
20-Jun-2009	08:00:00	-17.80	-14.93	-36.72	-26.99	-16.24	-26.99
20-Jun-2009	20:00:00	-19.73	-20.86	-37.27	-27.64	-17.76	-27.30
21-Jun-2009	08:00:00	-20.00	-18.11	-37.92	-28.19	-17.17	-27.66
21-Jun-2009	20:00:00	-21.24	-23.87	-38.35	-28.35	-19.20	-28.03
22-Jun-2009	08:00:00	-22.14	-24.34	-39.31	-28.82	-19.75	-28.57
22-Jun-2009	20:00:00	-22.47	-25.49	-40.00	-29.58	-20.20	-28.82
23-Jun-2009	08:00:00	-23.01	-23.12	-40.86	-29.91	-19.29	-29.28
23-Jun-2009	20:00:00	-23.60	-26.49	-41.14	-30.56	-21.28	-29.71
24-Jun-2009	08:00:00	-24.10	-24.57	-41.18	-30.74	-20.45	-30.13
24-Jun-2009	20:00:00	-24.62	-27.24	-41.21	-31.60	-22.32	-30.49
25-Jun-2009	08:00:00	-25.15	-26.08	-41.18	-31.98	-21.90	-30.91
25-Jun-2009	20:00:00	-25.66	-28.04	-41.16	-32.40	-23.31	-31.29
26-Jun-2009	08:00:00	-26.16	-27.08	-41.17	-32.41	-23.13	-31.77
26-Jun-2009	20:00:00	-26.63	-28.68	-41.09	-32.66	-24.20	-32.14
27-Jun-2009	08:00:00	-27.15	-27.84	-41.09	-33.03	-24.15	-32.56
27-Jun-2009	20:00:00	-27.62	-29.27	-41.05	-33.36	-25.08	-32.87
28-Jun-2009	08:00:00	-28.18	-28.94	-41.04	-33.70	-25.18	-33.17
28-Jun-2009	20:00:00	-28.61	-29.92	-40.99	-34.07	-25.90	-33.36
29-Jun-2009	08:00:00	-29.09	-29.60	-40.93	-34.47	-25.94	-33.66
29-Jun-2009	20:00:00	-29.52	-30.50	-40.79	-34.87	-26.73	-33.92
30-Jun-2009	08:00:00	-29.95	-30.54	-40.77	-35.33	-26.89	-34.26
30-Jun-2009	20:00:00	-30.18	-31.28	-40.79	-35.72	-27.77	-34.64
01-Jul-2009	08:00:00	-30.42	-31.44	-40.79	-36.18	-28.07	-35.12
01-Jul-2009	20:00:00	-30.68	-32.03	-40.78	-36.51	-28.79	-35.51

Date	Time						
dd-mmm-yyyy	hh:mm:ss	Jon AW7	Jon AW8	Jon AW9	Jon AW10	Jon AW11	Jon AW12
02-Jul-2009	08:00:00	-30.98	-32.15	-40.78	-36.49	-29.07	-35.94
02-Jul-2009	20:00:00	-31.27	-32.72	-40.79	-37.06	-29.84	-36.27
03-Jul-2009	08:00:00	-31.57	-32.98	-40.79	-37.30	-30.07	-36.70
03-Jul-2009	20:00:00	-31.88	-33.54	-40.80	-38.02	-30.95	-37.00
04-Jul-2009	08:00:00	-32.21	-33.74	-40.79	-38.18	-31.24	-37.33
04-Jul-2009	20:00:00	-32.46	-34.21	-40.78	-38.36	-32.03	-37.55
05-Jul-2009	08:00:00	-32.76	-34.19	-40.79	-38.58	-32.03	-37.80
05-Jul-2009	20:00:00	-33.03	-34.44	-40.78	-38.82	-32.38	-37.98
06-Jul-2009	08:00:00	-33.31	-34.37	-40.78	-38.18	-32.43	-38.25
06-Jul-2009	20:00:00	-33.57	-34.73	-40.79	-38.18	-32.96	-38.48
07-Jul-2009	08:00:00	-33.90	-34.79	-40.80	-38.20	-33.10	-38.78
07-Jul-2009	20:00:00	-34.17	-35.27	-40.79	-38.18	-33.87	-39.00
08-Jul-2009	08:00:00	-34.48	-35.42	-40.79	-38.15	-34.17	-39.28
08-Jul-2009	20:00:00	-34.79	-35.73	-40.79	-37.59	-34.61	-39.55
09-Jul-2009	08:00:00	-35.08	-35.37	-40.79	-37.34	-34.81	-39.86
09-Jul-2009	20:00:00	-35.39	-34.79	-40.78	-38.05	-35.04	-40.25
10-Jul-2009	08:00:00	-35.68	-33.96	-40.80	-38.05	-35.23	-40.62
10-Jul-2009	20:00:00	-36.02	-35.30	-40.79	-38.03	-35.68	-40.89
11-Jul-2009	08:00:00	-36.26	-35.32	-40.79	-37.96	-35.95	-41.21
11-Jul-2009	20:00:00	-36.53	-35.96	-40.79	-37.96	-36.34	-41.35
12-Jul-2009	08:00:00	-36.76	-36.08	-40.80	-37.96	-36.64	-41.46
12-Jul-2009	20:00:00	-36.99	-36.56	-40.79	-37.96	-37.17	-41.57
13-Jul-2009	08:00:00	-37.22	-36.70	-40.80	-37.83	-37.37	-41.73
13-Jul-2009	20:00:00	-37.44	-36.41	-40.78	-37.83	-37.55	-41.87
14-Jul-2009	08:00:00	-37.66	-35.73	-40.80	-38.08	-37.73	-42.10
14-Jul-2009	20:00:00	-37.88	-36.82	-40.80	-37.85	-38.05	-41.64
15-Jul-2009	08:00:00	-38.13	-36.95	-40.79	-37.85	-38.30	-41.63
15-Jul-2009	20:00:00	-38.38	-37.28	-40.80	-37.87	-38.54	-41.59
16-Jul-2009	08:00:00	-38.64	-37.37	-40.79	-37.88	-38.66	-41.63
16-Jul-2009	20:00:00	-38.82	-37.66	-40.79	-37.88	-38.89	-41.64
17-Jul-2009	08:00:00	-39.06	-37.53	-40.80	-37.88	-39.00	-41.62
17-Jul-2009	20:00:00	-39.26	-37.99	-40.80	-37.89	-39.23	-41.64
18-Jul-2009	08:00:00	-39.49	-38.08	-40.79	-37.88	-39.37	-41.66
18-Jul-2009	20:00:00	-39.72	-38.41	-40.80	-37.90	-39.51	-41.66
19-Jul-2009	08:00:00	-39.94	-38.55	-40.79	-37.88	-39.68	-41.67
19-Jul-2009	20:00:00	-40.24	-38.90	-40.79	-37.90	-39.85	-41.66
20-Jul-2009	08:00:00	-40.45	-38.96	-40.79	-38.07	-40.01	-41.67
20-Jul-2009	20:00:00	-39.92	-37.00	-40.80	-38.26	-39.94	-41.67
21-Jul-2009	08:00:00	-39.67	-37.79	-40.80	-37.90	-39.26	-41.66
21-Jul-2009	20:00:00	-40.02	-37.58	-40.81	-37.91	-39.49	-41.66
22-Jul-2009	08:00:00	-40.38	-36.53	-40.81	-37.90	-39.83	-41.65
22-Jul-2009	20:00:00	-40.73	-36.36	-40.80	-37.91	-40.22	-41.62
23-Jul-2009	08:00:00	-41.06	-35.36	-40.80	-37.92	-40.32	-41.61
23-Jul-2009	20:00:00	-41.38	-35.05	-40.80	-37.91	-40.42	-41.61
24-Jul-2009	08:00:00	-41.64	-32.30	-40.80	-37.90	-24.34	-41.52
24-Jul-2009	20:00:00	-41.85	-31.47	-40.80	-37.85	-27.87	-41.53
25-Jul-2009	08:00:00	-42.15	-29.96	-40.81	-37.96	-29.73	-41.56
25-Jul-2009	20:00:00	-42.49	-29.46	-40.80	-37.91	-31.59	-41.56
26-Jul-2009	08:00:00	-42.80	-28.85	-40.81	-37.90	-33.36	-41.58
26-Jul-2009	20:00:00	-43.15	-29.79	-40.79	-37.65	-34.83	-41.58
27-Jul-2009	08:00:00	-43.48	-29.50	-40.82	-37.66	-36.26	-41.60
27-Jul-2009	20:00:00	-43.85	-30.46	-40.80	-37.66	-37.19	-41.60

Date	Time						
dd-mmm-yyyy	hh:mm:ss	Jon AW7	Jon AW8	Jon AW9	Jon AW10	Jon AW11	Jon AW12
28-Jul-2009	08:00:00	-44.06	-30.03	-40.79	-37.66	-37.90	-41.61
28-Jul-2009	20:00:00	-44.35	-30.23	-40.79	-37.66	-38.16	-41.58
29-Jul-2009	08:00:00	-44.59	-29.13	-40.80	-37.66	-38.28	-41.61
29-Jul-2009	20:00:00	-44.85	-28.61	-40.80	-37.67	-38.75	-41.60
30-Jul-2009	08:00:00	-45.08	-28.04	-40.80	-37.67	-39.15	-41.61
30-Jul-2009	20:00:00	-45.35	-28.43	-40.80	-37.66	-39.52	-41.61
31-Jul-2009	08:00:00	-45.60	-27.94	-40.80	-37.66	-39.76	-41.61
31-Jul-2009	20:00:00	-45.85	-28.29	-40.81	-37.66	-35.42	-41.61
01-Aug-2009	08:00:00	-46.12	-27.35	-40.81	-37.68	-36.21	-41.60
01-Aug-2009	20:00:00	-46.42	-26.44	-40.80	-37.66	-37.33	-41.58
02-Aug-2009	08:00:00	-46.63	-25.50	-40.80	-37.68	-38.02	-41.59
02-Aug-2009	20:00:00	-46.86	-24.92	-40.80	-37.65	-38.51	-41.49
03-Aug-2009	08:00:00	-47.07	-24.46	-40.82	-37.66	-38.92	-41.50
03-Aug-2009	20:00:00	-47.32	-25.29	-40.80	-37.66	-39.34	-41.52
04-Aug-2009	08:00:00	-47.53	-24.62	-40.82	-37.66	-39.61	-41.54
04-Aug-2009	20:00:00	-47.77	-26.29	-40.79	-37.66	-39.87	-41.55
05-Aug-2009	08:00:00	-47.98	-25.93	-40.80	-37.66	-40.14	-41.56
05-Aug-2009	20:00:00	-48.18	-26.33	-40.80	-37.67	-36.43	-41.55
06-Aug-2009	08:00:00	-48.42	-25.51	-40.80	-37.68	-37.05	-41.56
06-Aug-2009	20:00:00	-48.65	-26.29	-40.80	-37.68	-37.92	-41.59
07-Aug-2009	08:00:00	-48.90	-26.05	-40.80	-37.67	-38.68	-41.61
07-Aug-2009	20:00:00	-49.23	-27.77	-40.81	-37.66	-39.27	-41.61
08-Aug-2009	08:00:00	-49.49	-27.78	-40.82	-37.68	-39.71	-41.61
08-Aug-2009	20:00:00	-49.83	-29.31	-40.82	-37.68	-40.02	-41.61
09-Aug-2009	08:00:00	-50.09	-29.40	-40.81	-37.67	-40.50	-41.63
09-Aug-2009	20:00:00	-50.40	-31.03	-40.80	-37.67	-40.74	-41.61
10-Aug-2009	08:00:00	-50.67	-30.98	-40.82	-37.68	-40.99	-41.61
10-Aug-2009	20:00:00	-50.90	-32.62	-40.82	-37.68	-41.15	-41.60
11-Aug-2009	08:00:00	-51.15	-32.86	-40.81	-37.68	-41.28	-41.60
11-Aug-2009	20:00:00	-51.38	-34.28	-40.81	-37.67	-41.37	-41.58
12-Aug-2009	08:00:00	-51.62	-34.48	-40.82	-37.67	-41.70	-41.60
12-Aug-2009	20:00:00	-51.89	-34.45	-40.82	-37.68	-41.29	-41.62
13-Aug-2009	08:00:00	-52.19	-33.94	-40.82	-37.67	-41.49	-41.62
13-Aug-2009	20:00:00	-52.34	-32.39	-40.81	-37.67	-36.80	-41.62
14-Aug-2009	08:00:00	-52.45	-30.87	-40.81	-37.67	-37.28	-41.62
14-Aug-2009	20:00:00	-26.16	-4.47	-40.82	-37.66	-12.27	-41.62
15-Aug-2009	08:00:00	-27.78	-3.55	-40.81	-37.68	-11.65	-41.63
15-Aug-2009	20:00:00	-29.21	-9.06	-40.81	-37.68	-17.62	-41.61
16-Aug-2009	08:00:00	-30.28	-10.23	-40.81	-37.68	-20.68	-41.62
16-Aug-2009	20:00:00	-31.23	-12.41	-40.80	-37.67	-22.90	-41.61
17-Aug-2009	08:00:00	-31.87	-13.10	-40.82	-37.68	-24.42	-41.61
17-Aug-2009	20:00:00	-32.54	-15.61	-40.82	-37.67	-25.93	-41.60
18-Aug-2009	08:00:00	-33.07	-15.74	-40.82	-37.68	-27.06	-41.59
18-Aug-2009	20:00:00	-33.59	-18.62	-40.81	-37.68	-28.31	-41.58
19-Aug-2009	08:00:00	-34.01	-18.77	-40.82	-37.68	-29.18	-41.48
19-Aug-2009	20:00:00	-34.46	-20.84	-40.81	-37.68	-30.06	-41.47
20-Aug-2009	08:00:00	-34.90	-20.47	-40.82	-37.67	-30.82	-41.49
20-Aug-2009	20:00:00	-35.30	-21.76	-40.82	-37.68	-31.75	-41.49
21-Aug-2009	08:00:00	-35.68	-21.17	-40.82	-37.68	-32.65	-41.50
21-Aug-2009	20:00:00	-36.04	-22.75	-40.82	-37.68	-33.47	-41.49
22-Aug-2009	08:00:00	-36.39	-22.12	-40.81	-37.67	-33.98	-41.49
22-Aug-2009	20:00:00	-36.74	-10.46	-40.82	-37.68	-12.65	-41.49

Date	Time						
dd-mmm-yyyy	hh:mm:ss	Jon AW7	Jon AW8	Jon AW9	Jon AW10	Jon AW11	Jon AW12
23-Aug-2009	08:00:00	-26.00	-1.93	-40.82	-37.68	-11.13	-41.52
23-Aug-2009	20:00:00	-27.14	-4.02	-40.82	-30.35	-16.15	-41.53
24-Aug-2009	08:00:00	-27.97	-5.21	-40.81	-31.81	-19.31	-41.56
24-Aug-2009	20:00:00	-28.84	-9.69	-40.82	-33.11	-21.82	-41.56
25-Aug-2009	08:00:00	-29.57	-10.51	-40.82	-34.10	-23.45	-41.57
25-Aug-2009	20:00:00	-30.32	-14.43	-40.82	-35.38	-24.97	-41.56
26-Aug-2009	08:00:00	-30.88	-14.96	-40.83	-36.31	-26.15	-41.57
26-Aug-2009	20:00:00	-31.50	-17.54	-40.82	-37.31	-27.32	-41.56
27-Aug-2009	08:00:00	-32.03	-17.34	-40.82	-37.66	-28.18	-41.57
27-Aug-2009	20:00:00	-32.64	-18.98	-40.81	-38.01	-29.08	-41.58
28-Aug-2009	08:00:00	-33.17	-18.23	-40.81	-37.94	-29.68	-41.57
28-Aug-2009	20:00:00	-33.63	-19.01	-40.81	-37.77	-30.28	-41.54
29-Aug-2009	08:00:00	-34.01	-18.42	-40.81	-37.42	-30.79	-41.54
29-Aug-2009	20:00:00	-34.44	-20.73	-40.81	-37.73	-31.70	-41.55
30-Aug-2009	08:00:00	-34.93	-20.81	-40.83	-31.97	-32.55	-41.56
30-Aug-2009	20:00:00	-35.39	-21.46	-40.81	-24.38	-2.65	-41.58
31-Aug-2009	08:00:00	-34.52	-4.22	-40.82	-24.09	-13.34	-41.59
31-Aug-2009	20:00:00	-35.06	-4.02	-40.83	-26.84	-15.73	-41.60
01-Sep-2009	08:00:00	-35.57	-5.18	-40.82	-29.76	-18.73	-41.60
01-Sep-2009	20:00:00	-36.05	-9.65	-40.82	-31.66	-21.54	-41.59
02-Sep-2009	08:00:00	-36.43	-10.40	-40.81	-33.08	-23.23	-41.59
02-Sep-2009	20:00:00	-36.88	-13.86	-40.82	-34.42	-24.87	-41.58
03-Sep-2009	08:00:00	-37.24	-14.16	-40.82	-35.45	-26.05	-41.57
03-Sep-2009	20:00:00	-37.53	-17.25	-40.81	-36.70	-27.30	-41.57
04-Sep-2009	08:00:00	-37.89	-17.43	-40.82	-37.57	-28.23	-41.58
04-Sep-2009	20:00:00	-38.24	-19.74	-40.83	-37.97	-29.22	-41.58
05-Sep-2009	08:00:00	-38.56	-19.61	-40.83	-37.95	-29.97	-41.58
05-Sep-2009	20:00:00	-38.96	-21.45	-40.83	-37.96	-30.84	-41.58
06-Sep-2009	08:00:00	-39.26	-20.93	-40.83	-37.95	-31.73	-41.45
06-Sep-2009	20:00:00	-39.66	-22.45	-40.84	-37.95	-32.77	-41.46
07-Sep-2009	08:00:00	-39.93	-21.54	-40.83	-37.94	-33.36	-41.46
07-Sep-2009	20:00:00	-40.21	-22.73	-40.85	-37.95	-33.97	-41.46
08-Sep-2009	08:00:00	-40.55	-22.53	-40.83	-37.94	-34.47	-41.47
08-Sep-2009	20:00:00	-40.89	-23.66	-40.82	-37.95	-35.07	-41.49
09-Sep-2009	08:00:00	-41.25	-23.56	-40.82	-37.93	-35.55	-41.51
09-Sep-2009	20:00:00	-41.79	-24.74	-40.83	-38.18	-36.06	-41.51
10-Sep-2009	08:00:00	-42.27	-24.61	-40.81	-38.19	-36.48	-41.53
10-Sep-2009	20:00:00	-42.78	-25.62	-40.83	-37.94	-36.93	-41.54
11-Sep-2009	08:00:00	-43.23	-25.27	-40.83	-37.94	-37.29	-41.53
11-Sep-2009	20:00:00	-43.65	-26.27	-40.83	-37.93	-37.67	-41.53
12-Sep-2009	08:00:00	-44.10	-25.79	-40.83	-37.94	-37.96	-41.52
12-Sep-2009	20:00:00	-44.47	-27.07	-40.82	-37.94	-38.34	-41.52
13-Sep-2009	08:00:00	-44.83	-26.83	-40.83	-37.92	-38.65	-41.53
13-Sep-2009	20:00:00	-45.21	-28.23	-40.83	-37.91	-39.03	-41.54
14-Sep-2009	08:00:00	-45.52	-28.05	-40.83	-37.92	-39.34	-41.56
14-Sep-2009	20:00:00	-45.94	-29.36	-40.83	-37.92	-39.55	-41.86
15-Sep-2009	08:00:00	-46.27	-28.96	-40.83	-37.92	-39.86	-41.41
15-Sep-2009	20:00:00	-46.66	-29.96	-40.83	-37.91	-40.15	-41.32
16-Sep-2009	08:00:00	-46.96	-29.52	-40.83	-37.91	-40.48	-41.39
16-Sep-2009	20:00:00	-47.28	-30.39	-40.83	-37.91	-40.81	-41.38
17-Sep-2009	08:00:00	-47.59	-29.85	-40.83	-37.92	-41.10	-41.39
17-Sep-2009	20:00:00	-47.96	-30.49	-40.82	-37.91	-41.20	-41.37

Date	Time						
dd-mmm-yyyy	hh:mm:ss	Jon AW7	Jon AW8	Jon AW9	Jon AW10	Jon AW11	Jon AW12
18-Sep-2009	08:00:00	-48.24	-29.96	-40.82	-37.91	-41.38	-41.39
18-Sep-2009	20:00:00	-48.65	-30.64	-40.84	-37.92	-41.59	-41.38
19-Sep-2009	08:00:00	-48.99	-30.08	-40.83	-37.91	-41.80	-41.38
19-Sep-2009	20:00:00	-49.45	-31.44	-40.83	-37.92	-40.93	-41.40
20-Sep-2009	08:00:00	-49.88	-31.36	-40.83	-37.91	-41.13	-41.43
20-Sep-2009	20:00:00	-50.36	-32.30	-40.83	-37.92	-40.63	-41.51
21-Sep-2009	08:00:00	-50.80	-32.14	-40.84	-37.91	-40.65	-41.41
21-Sep-2009	20:00:00	-51.32	-33.15	-40.83	-37.67	-40.67	-41.44
22-Sep-2009	08:00:00	-51.72	-32.78	-40.83	-37.67	-40.69	-41.42
0	20:00:00	-52.32	-54.73	-40.83	-37.67	-40.81	-41.11
0	08:00:00	-52.32	-54.73	-40.84	-37.67	-40.81	-41.11
0	20:00:00	-52.32	-54.73	-40.81	-37.67	-40.81	-41.11
0	08:00:00	-52.32	-54.73	-40.81	-37.67	-40.81	-41.11
0	20:00:00	-52.32	-54.73	-40.81	-37.67	-40.81	-41.11
0	08:00:00	-52.32	-54.73	-40.81	-37.67	-40.81	-41.11
0	20:00:00	-52.32	-54.73	-40.81	-37.67	-40.81	-41.11
0	08:00:00	-52.32	-54.73	-40.81	-37.67	-40.81	-41.11
0	20:00:00	-52.32	-54.73	-40.81	-37.67	-40.81	-41.11
0	08:00:00	-52.32	-54.73	-40.81	-37.67	-40.81	-41.11
0	20:00:00	-52.32	-54.73	-40.81	-37.67	-40.81	-41.11
0	08:00:00	-52.32	-54.73	-40.81	-37.67	-40.81	-41.11
0	20:00:00	-52.32	-54.73	-40.81	-37.67	-40.81	-41.11
0	08:00:00	-52.32	-54.73	-40.81	-37.67	-40.81	-41.11
0	20:00:00	-52.32	-54.73	-40.81	-37.67	-40.81	-41.11
0	08:00:00	-52.32	-54.73	-40.81	-37.67	-40.81	-41.11
0	20:00:00	-52.32	-54.73	-40.81	-37.67	-40.81	-41.11
0	08:00:00	-52.32	-54.73	-40.81	-37.67	-40.81	-41.11
0	20:00:00	-52.32	-54.73	-40.81	-37.67	-40.81	-41.11
0	08:00:00	-52.32	-54.73	-40.81	-37.67	-40.81	-41.11
0	20:00:00	-52.32	-54.73	-40.81	-37.67	-40.81	-41.11
0	08:00:00	-52.32	-54.73	-40.81	-37.67	-40.81	-41.11
0	20:00:00	-52.32	-54.73	-40.81	-37.67	-40.81	-41.11
0	08:00:00	-52.32	-54.73	-40.81	-37.67	-40.81	-41.11
0	20:00:00	-52.32	-54.73	-40.81	-37.67	-40.81	-41.11
0	08:00:00	-52.32	-54.73	-40.81	-37.67	-40.81	-41.11
0	20:00:00	-52.32	-54.73	-40.81	-37.67	-40.81	-41.11
0	08:00:00	-52.32	-54.73	-40.81	-37.67	-40.81	-41.11
0	20:00:00	-52.32	-54.73	-40.81	-37.67	-40.81	-41.11
0	08:00:00	-52.32	-54.73	-40.81	-37.67	-40.81	-41.11
0	20:00:00	-52.32	-54.73	-40.81	-37.67	-40.81	-41.11
0	08:00:00	-52.32	-54.73	-40.81	-37.67	-40.81	-41.11
0	20:00:00	-52.32	-54.73	-40.81	-37.67	-40.81	-41.11
0	08:00:00	-52.32	-54.73	-40.81	-37.67	-40.81	-41.11
0	20:00:00	-52.32	-54.73	-40.81	-37.67	-40.81	-41.11

Date	Time						
dd-mmm-yyyy	hh:mm:ss	Jon AW13	Jon AW14	Jon RAW1	Jon RAW2	Jon RAW3	CG1
01-Jan-2009	08:00:00	-0.18	-3.84	-0.75	0.78	6.99	
01-Jan-2009	20:00:00	-0.24	-3.83	-0.74	0.74	4.75	
02-Jan-2009	08:00:00	-0.40	-3.90	-0.82	0.65	2.10	
02-Jan-2009	20:00:00	-0.33	-3.83	-0.87	0.65	-1.96	
03-Jan-2009	08:00:00	-0.42	-3.86	-0.97	0.61	-2.89	
03-Jan-2009	20:00:00	-0.48	-3.89	-1.03	0.59	1.47	
04-Jan-2009	08:00:00	0.55	-2.18	0.30	1.64	-0.63	
04-Jan-2009	20:00:00	0.78	-2.49	1.09	2.23	-2.52	
05-Jan-2009	08:00:00	0.64	-2.72	1.03	2.08	-1.29	
05-Jan-2009	20:00:00	0.58	-2.82	0.90	2.01	2.22	
06-Jan-2009	08:00:00	1.24	-2.01	1.61	2.63	-0.49	
06-Jan-2009	20:00:00	1.07	-2.43	1.53	2.64	3.62	
07-Jan-2009	08:00:00	1.29	-1.59	1.68	2.70	-4.56	
07-Jan-2009	20:00:00	0.97	-2.48	1.38	2.51	6.78	
08-Jan-2009	08:00:00	0.73	-2.89	1.19	2.28	5.32	
08-Jan-2009	20:00:00	0.61	-3.14	1.07	2.13	6.02	
09-Jan-2009	08:00:00	0.33	-3.46	0.96	1.93	6.08	
09-Jan-2009	20:00:00	0.19	-3.57	0.82	1.82	5.60	
10-Jan-2009	08:00:00	-0.05	-3.70	0.62	1.71	6.03	
10-Jan-2009	20:00:00	-0.09	-3.66	0.58	1.69	-0.95	
11-Jan-2009	08:00:00	0.94	-2.53	0.88	1.83	-0.75	
11-Jan-2009	20:00:00	0.74	-2.75	0.76	1.77	2.65	
12-Jan-2009	08:00:00	0.49	-3.07	0.85	1.66	6.32	
12-Jan-2009	20:00:00	0.37	-3.30	0.61	1.56	5.16	
13-Jan-2009	08:00:00	0.27	-3.42	0.51	1.48	1.89	
13-Jan-2009	20:00:00	0.23	-3.43	0.43	1.46	2.90	
14-Jan-2009	08:00:00	-0.13	-3.68	0.17	1.34	6.67	
14-Jan-2009	20:00:00	-0.21	-3.70	0.11	1.27	4.59	
15-Jan-2009	08:00:00	-0.50	-3.92	-0.07	1.18	7.79	
15-Jan-2009	20:00:00	-0.51	-4.01	0.14	1.08	5.86	
16-Jan-2009	08:00:00	-0.97	-4.42	-0.08	0.88	0.04	
16-Jan-2009	20:00:00	-0.85	-4.27	-0.15	0.81	3.26	
17-Jan-2009	08:00:00	-1.74	-5.29	-0.39	0.52	-0.40	
17-Jan-2009	20:00:00	-1.28	-4.29	-0.17	0.73	-2.68	
18-Jan-2009	08:00:00	-0.86	-4.00	-0.18	0.79	-7.24	
18-Jan-2009	20:00:00	-0.05	-3.66	-0.10	0.92	0.08	
19-Jan-2009	08:00:00	-0.28	-3.72	-0.24	0.89	3.56	
19-Jan-2009	20:00:00	-0.08	-3.63	-0.26	0.96	-0.22	
20-Jan-2009	08:00:00	0.60	-3.14	-0.10	1.09	6.53	
20-Jan-2009	20:00:00	0.56	-2.98	0.15	1.22	1.26	
21-Jan-2009	08:00:00	-0.03	-3.53	-0.16	1.06	0.35	
21-Jan-2009	20:00:00	0.41	-2.84	0.25	1.10	0.70	
22-Jan-2009	08:00:00	-0.34	-3.52	-0.04	0.96	11.09	
22-Jan-2009	20:00:00	0.73	-2.82	0.28	1.21	2.74	
23-Jan-2009	08:00:00	0.20	-3.31	0.06	1.10	4.89	
23-Jan-2009	20:00:00	0.81	-2.97	0.02	1.16	6.37	
24-Jan-2009	08:00:00	0.60	-3.01	-0.04	1.09	3.52	
24-Jan-2009	20:00:00	0.52	-3.06	-0.12	1.02	3.19	
25-Jan-2009	08:00:00	0.38	-3.18	-0.32	0.89	3.98	
25-Jan-2009	20:00:00	0.29	-3.39	-0.43	0.80	3.12	
26-Jan-2009	08:00:00	0.20	-3.46	-0.53	0.68	3.38	
26-Jan-2009	20:00:00	0.08	-3.57	-0.65	0.59	-0.74	

Date	Time						
dd-mmm-yyyy	hh:mm:ss	Jon AW13	Jon AW14	Jon RAW1	Jon RAW2	Jon RAW3	CG1
27-Jan-2009	08:00:00	-0.02	-3.65	-0.72	0.51	2.60	
27-Jan-2009	20:00:00	-0.09	-3.74	-0.71	0.52	-3.72	
28-Jan-2009	08:00:00	-0.08	-3.60	-0.66	0.56	-5.31	
28-Jan-2009	20:00:00	0.89	-2.30	0.35	1.12	4.91	
29-Jan-2009	08:00:00	0.68	-2.63	0.27	1.19	3.41	
29-Jan-2009	20:00:00	0.57	-2.91	0.15	1.17	5.54	
30-Jan-2009	08:00:00	0.40	-3.12	0.00	1.04	3.82	
30-Jan-2009	20:00:00	0.30	-3.29	-0.13	0.97	4.26	
31-Jan-2009	08:00:00	-0.19	-3.67	-0.33	0.80	5.31	
31-Jan-2009	20:00:00	-0.09	-3.64	-0.45	0.73	4.53	
01-Feb-2009	08:00:00	-0.50	-3.89	-0.64	0.59	3.91	
01-Feb-2009	20:00:00	-0.29	-3.82	-0.69	0.57	3.02	
02-Feb-2009	08:00:00	-0.49	-3.94	-0.84	0.50	4.66	
02-Feb-2009	20:00:00	-0.37	-3.86	-0.80	0.49	3.42	
03-Feb-2009	08:00:00	0.80	-2.62	0.77	1.51	3.76	
03-Feb-2009	20:00:00	0.62	-2.90	0.71	1.58	1.07	
04-Feb-2009	08:00:00	0.47	-3.03	0.77	1.62	4.33	
04-Feb-2009	20:00:00	0.52	-3.04	0.94	1.66	3.88	
05-Feb-2009	08:00:00	-0.06	-3.72	0.66	1.37	9.54	
05-Feb-2009	20:00:00	-0.05	-3.46	0.66	1.41	-0.14	
06-Feb-2009	08:00:00	-0.75	-4.08	0.40	1.14	2.63	
06-Feb-2009	20:00:00	-0.24	-3.52	0.46	1.34	4.17	
07-Feb-2009	08:00:00	-0.63	-3.88	0.28	1.19	4.24	
07-Feb-2009	20:00:00	-0.05	-3.73	0.24	1.18	2.73	
08-Feb-2009	08:00:00	-0.28	-3.84	0.18	1.09	2.71	
08-Feb-2009	20:00:00	-0.22	-3.90	0.14	1.07	3.89	
09-Feb-2009	08:00:00	-0.39	-4.03	-0.01	0.95	3.51	
09-Feb-2009	20:00:00	-0.42	-4.14	-0.07	0.90	1.75	
10-Feb-2009	08:00:00	-0.50	-4.17	-0.19	0.83	-1.77	
10-Feb-2009	20:00:00	-0.50	-4.16	-0.23	0.81	2.60	
11-Feb-2009	08:00:00	-0.56	-4.21	-0.31	0.71	1.36	
11-Feb-2009	20:00:00	-0.44	-4.11	-0.21	0.74	1.67	
12-Feb-2009	08:00:00	-0.55	-4.24	0.29	1.12	2.24	
12-Feb-2009	20:00:00	-0.68	-4.43	0.14	1.04	3.07	
13-Feb-2009	08:00:00	-0.84	-4.57	-0.06	0.90	1.24	
13-Feb-2009	20:00:00	-0.85	-4.60	-0.18	0.82	2.85	
14-Feb-2009	08:00:00	-0.88	-4.55	-0.31	0.73	0.08	
14-Feb-2009	20:00:00	-0.83	-4.38	-0.26	0.75	4.16	
15-Feb-2009	08:00:00	-1.02	-4.65	-0.49	0.61	1.42	
15-Feb-2009	20:00:00	-1.07	-4.77	-0.56	0.54	3.11	
16-Feb-2009	08:00:00	-0.58	-4.06	0.24	1.01	1.63	
16-Feb-2009	20:00:00	-0.71	-4.33	0.04	0.94	3.39	
17-Feb-2009	08:00:00	-1.10	-4.69	-0.26	0.75	0.67	
17-Feb-2009	20:00:00	-0.89	-4.54	-0.35	0.69	3.06	
18-Feb-2009	08:00:00	-0.59	-4.20	-0.06	0.97	0.76	
18-Feb-2009	20:00:00	0.78	-2.79	1.33	1.85	-0.16	
19-Feb-2009	08:00:00	1.07	-2.50	2.11	2.70	1.88	
19-Feb-2009	20:00:00	0.75	-3.05	1.82	2.28	3.17	
20-Feb-2009	08:00:00	0.44	-3.47	1.59	2.03	2.39	
20-Feb-2009	20:00:00	0.33	-3.63	1.45	1.87	3.64	
21-Feb-2009	08:00:00	-0.18	-4.03	1.29	1.66	2.99	
21-Feb-2009	20:00:00	0.04	-3.91	1.23	1.64	3.16	

Date	Time						
dd-mmm-yyyy	hh:mm:ss	Jon AW13	Jon AW14	Jon RAW1	Jon RAW2	Jon RAW3	CG1
22-Feb-2009	08:00:00	-0.10	-3.90	1.14	1.53	-1.88	
22-Feb-2009	20:00:00	-0.37	-4.22	0.95	1.43	3.94	
23-Feb-2009	08:00:00	-0.65	-4.51	0.78	1.26	0.90	
23-Feb-2009	20:00:00	-0.66	-4.62	0.68	1.22	4.04	
24-Feb-2009	08:00:00	-1.21	-5.05	0.47	1.03	1.27	
24-Feb-2009	20:00:00	-0.83	-4.82	0.38	1.00	3.28	
25-Feb-2009	08:00:00	-1.16	-5.00	0.23	0.89	-0.37	0
25-Feb-2009	20:00:00	-0.95	-4.88	0.25	0.88	2.02	
26-Feb-2009	08:00:00	-1.06	-4.88	0.15	0.76	-0.37	
26-Feb-2009	20:00:00	-1.06	-4.76	0.14	0.76	2.14	
27-Feb-2009	08:00:00	-1.02	-4.63	0.08	0.74	1.30	
27-Feb-2009	20:00:00	-0.76	-4.18	0.44	1.00	2.89	
28-Feb-2009	08:00:00	-0.09	-3.36	0.90	1.24	0.32	
28-Feb-2009	20:00:00	1.83	-1.47	3.44	3.92	6.65	
01-Mar-2009	08:00:00	1.76	-2.06	3.06	3.14	2.96	
01-Mar-2009	20:00:00	2.09	-1.48	13.19	14.56	13.82	
02-Mar-2009	08:00:00	1.44	-2.33	20.53	12.10	12.81	
02-Mar-2009	20:00:00	1.07	-2.81	22.70	12.26	14.46	
03-Mar-2009	08:00:00	0.69	-3.47	21.55	12.49	15.95	
03-Mar-2009	20:00:00	0.79	-3.31	18.20	12.10	17.38	
04-Mar-2009	08:00:00	0.39	-3.81	19.55	12.26	15.65	
04-Mar-2009	20:00:00	0.77	-3.53	15.43	11.79	16.41	
05-Mar-2009	08:00:00	0.47	-3.80	21.93	12.44	16.77	
05-Mar-2009	20:00:00	0.68	-3.72	13.97	10.47	11.80	
06-Mar-2009	08:00:00	0.63	-3.80	13.87	9.79	7.37	
06-Mar-2009	20:00:00	0.65	-3.83	13.17	8.69	10.31	
07-Mar-2009	08:00:00	0.60	-3.91	13.18	7.43	6.57	
07-Mar-2009	20:00:00	0.62	-3.92	11.02	7.11	8.49	
08-Mar-2009	08:00:00	0.58	-3.96	9.91	6.30	5.49	
08-Mar-2009	20:00:00	0.57	-4.05	4.36	6.44	6.69	
09-Mar-2009	08:00:00	0.54	-4.09	10.11	6.18	2.22	
09-Mar-2009	20:00:00	0.43	-4.20	4.01	6.21	5.97	
10-Mar-2009	08:00:00	0.32	-4.35	4.09	6.24	1.61	
10-Mar-2009	20:00:00	0.22	-4.39	2.63	5.87	4.54	
11-Mar-2009	08:00:00	0.17	-4.30	0.96	3.80	0.96	
11-Mar-2009	20:00:00	0.10	-4.40	1.27	7.79	2.04	
12-Mar-2009	08:00:00	-0.14	-4.60	1.40	4.92	1.53	
12-Mar-2009	20:00:00	-0.30	-4.87	3.98	2.97	2.08	
13-Mar-2009	08:00:00	-0.41	-4.95	6.28	5.42	2.01	
13-Mar-2009	20:00:00	0.12	-3.99	3.42	4.40	0.56	
14-Mar-2009	08:00:00	0.33	-4.06	4.40	5.13	0.76	
14-Mar-2009	20:00:00	0.87	-3.26	2.53	2.85	0.79	
15-Mar-2009	08:00:00	1.03	-2.87	1.90	1.78	0.78	
15-Mar-2009	20:00:00	1.05	-2.61	-1.19	2.33	1.20	
16-Mar-2009	08:00:00	1.01	-2.84	0.71	2.33	1.52	
16-Mar-2009	20:00:00	1.18	-2.65	-1.85	2.47	1.35	
17-Mar-2009	08:00:00	1.08	-2.83	1.77	2.34	1.32	
17-Mar-2009	20:00:00	0.88	-3.08	1.80	2.22	4.12	
18-Mar-2009	08:00:00	0.78	-3.20	7.21	2.01	0.19	
18-Mar-2009	20:00:00	0.74	-3.31	4.67	1.97	4.25	
19-Mar-2009	08:00:00	0.66	-3.42	8.65	1.78	0.85	
19-Mar-2009	20:00:00	0.61	-3.52	7.04	1.88	3.41	

Date	Time						
dd-mmm-yyyy	hh:mm:ss	Jon AW13	Jon AW14	Jon RAW1	Jon RAW2	Jon RAW3	CG1
20-Mar-2009	08:00:00	0.93	-2.84	8.86	2.38	2.21	
20-Mar-2009	20:00:00	0.73	-3.20	7.11	2.21	4.97	
21-Mar-2009	08:00:00	0.52	-3.37	6.85	1.92	1.09	
21-Mar-2009	20:00:00	0.42	-3.57	6.09	1.86	4.20	
22-Mar-2009	08:00:00	0.27	-3.72	2.49	1.66	0.70	
22-Mar-2009	20:00:00	0.17	-3.82	7.24	1.66	4.68	
23-Mar-2009	08:00:00	-0.02	-3.92	7.41	1.44	0.76	0
23-Mar-2009	20:00:00	-0.10	-4.00	3.17	1.47	4.42	
24-Mar-2009	08:00:00	-0.24	-4.14	6.23	1.32	0.11	
24-Mar-2009	20:00:00	-0.35	-4.29	4.87	1.23	3.31	
25-Mar-2009	08:00:00	-0.44	-4.32	4.94	1.10	0.61	
25-Mar-2009	20:00:00	-0.41	-4.11	1.68	1.06	1.95	
26-Mar-2009	08:00:00	0.63	-3.54	2.11	1.45	0.24	
26-Mar-2009	20:00:00	0.61	-3.52	1.47	1.96	2.26	
27-Mar-2009	08:00:00	0.48	-3.57	6.93	2.06	0.66	
27-Mar-2009	20:00:00	0.63	-3.37	0.12	2.17	1.32	
28-Mar-2009	08:00:00	0.53	-3.43	3.72	2.06	0.22	
28-Mar-2009	20:00:00	2.18	-1.53	0.81	3.71	2.34	
29-Mar-2009	08:00:00	1.17	-2.61	-1.53	2.68	0.94	
29-Mar-2009	20:00:00	0.80	-3.07	7.09	4.23	10.47	
30-Mar-2009	08:00:00	0.61	-3.36	7.14	3.46	6.38	
30-Mar-2009	20:00:00	0.34	-3.63	7.27	2.46	3.93	
31-Mar-2009	08:00:00	0.08	-3.79	2.62	2.14	0.19	
31-Mar-2009	20:00:00	-0.01	-3.88	3.98	2.00	2.73	
01-Apr-2009	08:00:00	-0.05	-3.85	7.76	1.89	0.46	
01-Apr-2009	20:00:00	0.08	-3.71	-0.24	1.87	2.16	
02-Apr-2009	08:00:00	0.42	-3.27	4.80	1.83	0.63	
02-Apr-2009	20:00:00	1.02	-2.72	0.67	2.74	0.86	
03-Apr-2009	08:00:00	1.18	-2.49	-0.84	3.48	2.86	
03-Apr-2009	20:00:00	0.71	-3.01	8.06	2.60	5.38	
04-Apr-2009	08:00:00	0.42	-3.36	8.29	2.23	0.89	
04-Apr-2009	20:00:00	0.09	-3.66	7.92	2.10	4.36	
05-Apr-2009	08:00:00	-0.11	-3.85	7.87	1.90	0.45	
05-Apr-2009	20:00:00	-0.23	-4.04	7.04	1.84	3.52	
06-Apr-2009	08:00:00	-0.11	-3.86	2.41	1.76	-0.09	
06-Apr-2009	20:00:00	0.46	-3.55	7.62	1.57	2.74	
07-Apr-2009	08:00:00	0.05	-3.84	7.71	1.38	0.15	
07-Apr-2009	20:00:00	-0.28	-4.19	5.81	1.16	2.46	
08-Apr-2009	08:00:00	-0.52	-4.42	6.46	0.92	-0.34	
08-Apr-2009	20:00:00	-0.68	-4.61	2.01	0.86	3.21	
09-Apr-2009	08:00:00	-0.84	-4.80	7.29	0.65	0.58	
09-Apr-2009	20:00:00	-1.02	-5.28	6.26	0.57	3.92	
10-Apr-2009	08:00:00	-1.11	-5.46	0.58	0.41	-0.37	
10-Apr-2009	20:00:00	-1.14	-5.42	0.60	0.38	1.14	
11-Apr-2009	08:00:00	1.15	-2.81	2.85	2.15	1.06	
11-Apr-2009	20:00:00	0.71	-3.39	2.75	1.97	3.76	
12-Apr-2009	08:00:00	0.38	-3.75	2.36	1.72	0.23	
12-Apr-2009	20:00:00	0.01	-4.15	2.12	1.56	3.88	
13-Apr-2009	08:00:00	-0.21	-4.29	1.83	1.37	-0.12	
13-Apr-2009	20:00:00	-0.21	-4.16	1.72	1.31	0.34	
14-Apr-2009	08:00:00	-0.13	-4.01	1.69	1.29	-0.12	
14-Apr-2009	20:00:00	1.12	-2.78	2.63	1.94	1.98	

Date	Time						
dd-mmm-yyyy	hh:mm:ss	Jon AW13	Jon AW14	Jon RAW1	Jon RAW2	Jon RAW3	CG1
15-Apr-2009	08:00:00	0.75	-3.06	2.54	1.89	1.06	
15-Apr-2009	20:00:00	0.43	-3.46	2.23	1.66	3.82	
16-Apr-2009	08:00:00	0.04	-3.84	1.88	1.41	1.61	
16-Apr-2009	20:00:00	-0.30	-4.34	1.53	1.16	4.98	
17-Apr-2009	08:00:00	-0.58	-4.55	1.22	0.90	0.18	
17-Apr-2009	20:00:00	-0.80	-4.94	0.98	0.72	5.29	
18-Apr-2009	08:00:00	-0.97	-5.02	0.75	0.48	0.44	
18-Apr-2009	20:00:00	-1.15	-5.61	0.47	0.33	5.55	
19-Apr-2009	08:00:00	-1.27	-5.58	0.30	0.13	-0.07	
19-Apr-2009	20:00:00	-1.34	-5.78	0.09	-0.02	1.54	
20-Apr-2009	08:00:00	-0.40	-3.85	1.52	0.96	0.55	
20-Apr-2009	20:00:00	-0.51	-4.63	0.93	0.80	4.47	
21-Apr-2009	08:00:00	-0.69	-4.85	0.71	0.59	2.06	
21-Apr-2009	20:00:00	-0.99	-5.65	0.23	0.26	3.16	
22-Apr-2009	08:00:00	-1.23	-6.29	-0.07	0.00	2.89	
22-Apr-2009	20:00:00	-1.60	-8.44	-0.66	-0.36	3.43	
23-Apr-2009	08:00:00	-1.87	-9.05	-0.96	-0.63	0.15	0
23-Apr-2009	20:00:00	-2.15	-11.16	-1.77	-0.87	4.36	
24-Apr-2009	08:00:00	-2.37	-11.58	-2.12	-1.08	0.29	
24-Apr-2009	20:00:00	-2.76	-13.98	-3.48	-1.41	4.15	
25-Apr-2009	08:00:00	-2.98	-14.11	-3.86	-1.60	2.24	
25-Apr-2009	20:00:00	-3.66	-16.99	-6.42	-2.11	3.23	
26-Apr-2009	08:00:00	-4.11	-17.17	-7.13	-2.36	0.99	
26-Apr-2009	20:00:00	-5.50	-19.60	-11.68	-3.05	1.76	
27-Apr-2009	08:00:00	-6.23	-19.62	-12.16	-3.36	-0.12	
27-Apr-2009	20:00:00	-8.35	-21.75	-16.17	-4.26	0.81	
28-Apr-2009	08:00:00	-9.34	-21.64	-17.11	-4.65	-2.00	
28-Apr-2009	20:00:00	-11.61	-23.07	-18.97	-5.76	-1.69	
29-Apr-2009	08:00:00	-12.24	-22.58	-19.71	-6.13	-3.13	
29-Apr-2009	20:00:00	-14.07	-23.92	-20.52	-7.45	-4.40	
30-Apr-2009	08:00:00	-14.64	-23.78	-21.15	-7.90	-2.45	
30-Apr-2009	20:00:00	-16.02	-24.49	-21.70	-8.97	-7.17	
01-May-2009	08:00:00	-15.77	-23.59	-22.17	-9.29	-6.48	
01-May-2009	20:00:00	-17.55	-24.83	-22.64	-10.66	-8.32	
02-May-2009	08:00:00	-17.13	-24.21	-23.03	-11.00	-7.52	
02-May-2009	20:00:00	-11.96	-24.73	-23.33	-8.16	-1.06	
03-May-2009	08:00:00	-3.99	-13.32	-23.59	-7.01	-4.99	
03-May-2009	20:00:00	-5.06	-16.22	-24.03	-8.71	-6.60	
04-May-2009	08:00:00	-5.71	-17.19	-24.42	-9.22	-7.38	
04-May-2009	20:00:00	-7.23	-19.48	-24.82	-10.75	-7.27	
05-May-2009	08:00:00	-0.39	-3.25	-24.67	-4.18	-3.93	
05-May-2009	20:00:00	0.47	-4.54	-24.32	-3.73	-0.31	
06-May-2009	08:00:00	0.22	-5.05	-18.15	-2.43	0.78	
06-May-2009	20:00:00	-0.09	-6.07	-19.64	-3.29	-0.97	
07-May-2009	08:00:00	-0.38	-6.49	-20.68	-3.59	0.46	
07-May-2009	20:00:00	-0.73	-10.02	-22.01	-4.92	-1.04	
08-May-2009	08:00:00	-0.94	-11.02	-22.94	-5.29	-2.50	
08-May-2009	20:00:00	-1.21	-14.01	-23.68	-6.15	-2.43	
09-May-2009	08:00:00	-1.40	-14.14	-24.21	-6.45	-2.67	
09-May-2009	20:00:00	-1.91	-19.53	-24.89	-8.88	-2.58	
10-May-2009	08:00:00	-2.20	-19.61	-25.41	-9.51	-4.32	
10-May-2009	20:00:00	-2.95	-22.82	-26.03	-12.01	-4.92	

Date	Time						
dd-mmm-yyyy	hh:mm:ss	Jon AW13	Jon AW14	Jon RAW1	Jon RAW2	Jon RAW3	CG1
11-May-2009	08:00:00	-0.09	-8.06	-25.78	-5.06	0.04	
11-May-2009	20:00:00	-0.17	-5.96	-26.40	-5.93	-2.63	
12-May-2009	08:00:00	-0.43	-7.34	-26.81	-6.75	-4.20	
12-May-2009	20:00:00	-0.81	-12.13	-27.31	-8.88	-3.48	
13-May-2009	08:00:00	-1.12	-13.80	-27.80	-9.69	-6.78	
13-May-2009	20:00:00	-1.42	-17.73	-28.31	-11.92	-6.90	
14-May-2009	08:00:00	-1.52	-17.47	-28.68	-12.66	-8.86	
14-May-2009	20:00:00	-1.42	-15.67	-29.01	-13.41	-7.83	
15-May-2009	08:00:00	-1.61	-15.85	-29.32	-13.77	-9.75	
15-May-2009	20:00:00	-2.02	-19.94	-29.70	-15.16	-10.03	
16-May-2009	08:00:00	-2.22	-19.35	-30.05	-13.62	-9.15	
16-May-2009	20:00:00	-2.11	-19.59	-30.35	-14.61	-10.23	
17-May-2009	08:00:00	-2.43	-19.05	-30.64	-15.08	-11.41	
17-May-2009	20:00:00	-0.53	-20.16	-30.25	-3.74	-2.77	
18-May-2009	08:00:00	-0.34	-5.76	-30.32	-3.26	-0.83	
18-May-2009	20:00:00	-0.59	-10.22	-30.80	-5.38	-0.85	
19-May-2009	08:00:00	-0.85	-12.31	-31.16	-6.36	-4.40	
19-May-2009	20:00:00	-1.30	-17.70	-31.50	-8.65	-3.19	
20-May-2009	08:00:00	-1.60	-18.39	-31.84	-9.53	-6.12	
20-May-2009	20:00:00	-2.10	-22.07	-32.28	-12.06	-6.39	
21-May-2009	08:00:00	-2.40	-21.54	-32.61	-12.72	-8.39	
21-May-2009	20:00:00	-3.16	-24.32	-32.93	-15.07	-10.03	
22-May-2009	08:00:00	-3.75	-24.29	-33.28	-15.93	-11.94	
22-May-2009	20:00:00	-5.50	-25.74	-33.62	-17.16	-13.50	
23-May-2009	08:00:00	-6.77	-25.79	-33.93	-17.99	-15.35	
23-May-2009	20:00:00	-8.80	-26.59	-34.20	-18.64	-15.62	
24-May-2009	08:00:00	-7.56	-26.41	-34.47	-19.27	-16.32	
24-May-2009	20:00:00	-1.02	-11.09	-34.70	-12.17	-9.31	
25-May-2009	08:00:00	-1.19	-11.64	-34.97	-12.16	-10.47	
25-May-2009	20:00:00	0.77	-4.32	-35.21	-9.24	-7.30	
26-May-2009	08:00:00	0.53	-4.73	-35.44	-9.72	-8.20	
26-May-2009	20:00:00	2.65	-0.41	-35.65	-7.93	-5.91	
27-May-2009	08:00:00	0.88	-2.80	-35.89	-7.37	-6.33	
27-May-2009	20:00:00	0.54	-3.47	-36.22	-9.43	-8.44	
28-May-2009	08:00:00	0.36	-3.75	-36.43	-9.92	-10.04	
28-May-2009	20:00:00	2.79	-1.57	-34.73	-1.25	2.06	
29-May-2009	08:00:00	0.91	-2.67	-32.76	-2.37	-0.34	
29-May-2009	20:00:00	0.49	-3.58	-33.25	-3.70	0.91	0
30-May-2009	08:00:00	0.21	-4.08	-33.68	-4.21	-1.10	
30-May-2009	20:00:00	-0.32	-5.73	-34.09	-6.01	-0.67	
31-May-2009	08:00:00	-0.59	-5.76	-34.44	-6.57	-3.80	
31-May-2009	20:00:00	-1.14	-9.44	-34.76	-9.24	-2.76	
01-Jun-2009	08:00:00	-1.44	-9.98	-35.14	-10.05	-5.30	
01-Jun-2009	20:00:00	-2.16	-14.55	-35.56	-13.24	-6.00	
02-Jun-2009	08:00:00	-2.45	-13.69	-35.87	-14.02	-8.49	
02-Jun-2009	20:00:00	-3.83	-17.99	-36.28	-16.69	-10.42	
03-Jun-2009	08:00:00	-4.44	-17.08	-36.63	-17.81	-12.87	
03-Jun-2009	20:00:00	-7.64	-20.98	-37.02	-19.02	-15.81	
04-Jun-2009	08:00:00	-9.03	-20.22	-37.44	-20.01	-18.81	
04-Jun-2009	20:00:00	-3.36	-12.72	-36.19	-2.68	1.40	
05-Jun-2009	08:00:00	-1.55	-5.65	-29.53	-1.24	-0.03	
05-Jun-2009	20:00:00	-2.11	-9.00	-30.17	-1.28	0.96	

Date	Time						
dd-mmm-yyyy	hh:mm:ss	Jon AW13	Jon AW14	Jon RAW1	Jon RAW2	Jon RAW3	CG1
06-Jun-2009	08:00:00	-2.39	-10.11	-30.81	-1.46	-0.40	
06-Jun-2009	20:00:00	-3.47	-14.64	-31.35	-2.44	-0.33	
07-Jun-2009	08:00:00	-4.13	-15.04	-31.78	-2.85	-3.26	
07-Jun-2009	20:00:00	-6.39	-18.38	-32.19	-3.95	-1.90	
08-Jun-2009	08:00:00	-7.39	-17.87	-32.57	-4.39	-4.07	
08-Jun-2009	20:00:00	-11.57	-21.16	-32.97	-6.12	-3.18	
09-Jun-2009	08:00:00	-12.27	-20.70	-33.40	-6.74	-5.67	
09-Jun-2009	20:00:00	-15.21	-23.48	-33.80	-8.16	-0.21	
10-Jun-2009	08:00:00	-13.79	-21.53	-34.24	-7.73	-6.50	
10-Jun-2009	20:00:00	-17.93	-24.62	-34.62	-10.42	-7.27	
11-Jun-2009	08:00:00	-11.89	-21.13	-34.85	-3.40	-2.24	
11-Jun-2009	20:00:00	-14.93	-23.19	-35.17	-4.15	1.46	
12-Jun-2009	08:00:00	-14.64	-21.86	-35.59	-4.74	-3.63	
12-Jun-2009	20:00:00	-19.01	-25.20	-35.90	-6.80	-1.98	
13-Jun-2009	08:00:00	-19.63	-25.55	-36.19	-7.38	-4.56	
13-Jun-2009	20:00:00	-21.52	-27.28	-36.58	-10.51	-5.30	
14-Jun-2009	08:00:00	-22.37	-27.45	-36.91	-11.29	-7.40	
14-Jun-2009	20:00:00	-23.33	-28.83	-37.30	-14.54	-10.78	
15-Jun-2009	08:00:00	-24.00	-28.78	-37.60	-15.33	-12.79	
15-Jun-2009	20:00:00	-24.56	-29.69	-37.97	-17.14	-15.32	
16-Jun-2009	08:00:00	-24.98	-29.56	-38.28	-17.21	-14.84	
16-Jun-2009	20:00:00	-25.51	-30.57	-38.60	-18.14	-15.96	
17-Jun-2009	08:00:00	-25.76	-30.00	-39.03	-18.97	-18.27	
17-Jun-2009	20:00:00	-25.02	-30.35	-39.48	-19.64	-19.27	
18-Jun-2009	08:00:00	-24.11	-28.97	-39.90	-20.32	-20.68	
18-Jun-2009	20:00:00	-23.03	-29.71	-40.37	-20.93	-21.91	
19-Jun-2009	08:00:00	-23.00	-29.31	-40.85	-21.70	-25.27	
19-Jun-2009	20:00:00	-24.16	-31.13	-41.44	-22.32	-26.36	
20-Jun-2009	08:00:00	-25.05	-30.79	-41.69	-23.02	-29.54	
20-Jun-2009	20:00:00	-25.83	-32.07	-42.22	-23.60	-29.97	
21-Jun-2009	08:00:00	-26.35	-31.78	-42.64	-24.26	-33.27	
21-Jun-2009	20:00:00	-26.93	-33.53	-43.31	-24.86	-32.53	
22-Jun-2009	08:00:00	-27.55	-33.95	-43.77	-25.71	-41.05	
22-Jun-2009	20:00:00	-27.90	-34.76	-44.53	-26.16	-36.35	0
23-Jun-2009	08:00:00	-28.40	-34.32	-45.02	-26.90	-40.38	
23-Jun-2009	20:00:00	-28.94	-35.97	-45.87	-27.55	-39.85	
24-Jun-2009	08:00:00	-29.41	-35.55	-46.42	-28.36	-44.33	
24-Jun-2009	20:00:00	-29.87	-37.15	-47.16	-29.04	-43.46	
25-Jun-2009	08:00:00	-30.35	-36.70	-47.81	-29.82	-46.96	
25-Jun-2009	20:00:00	-30.73	-38.34	-48.83	-30.45	-46.03	
26-Jun-2009	08:00:00	-31.13	-37.51	-49.02	-31.16	-49.11	
26-Jun-2009	20:00:00	-31.71	-39.42	-48.98	-31.81	-47.01	
27-Jun-2009	08:00:00	-32.13	-38.56	-49.05	-32.48	-49.72	
27-Jun-2009	20:00:00	-32.73	-39.80	-49.06	-33.11	-46.95	
28-Jun-2009	08:00:00	-33.26	-39.47	-49.11	-33.82	-49.93	
28-Jun-2009	20:00:00	-33.80	-39.83	-49.06	-34.44	-47.21	
29-Jun-2009	08:00:00	-34.29	-39.82	-49.11	-35.13	-49.29	
29-Jun-2009	20:00:00	-35.20	-39.83	-49.06	-35.73	-46.74	
30-Jun-2009	08:00:00	-35.64	-39.86	-49.13	-36.43	-49.67	
30-Jun-2009	20:00:00	-36.43	-39.83	-49.07	-36.99	-47.04	
01-Jul-2009	08:00:00	-37.03	-39.81	-49.15	-37.69	-49.83	
01-Jul-2009	20:00:00	-37.65	-39.83	-49.06	-38.38	-47.01	

Date	Time						
dd-mmm-yyyy	hh:mm:ss	Jon AW13	Jon AW14	Jon RAW1	Jon RAW2	Jon RAW3	CG1
02-Jul-2009	08:00:00	-38.27	-39.79	-49.13	-39.18	-49.42	
02-Jul-2009	20:00:00	-39.07	-39.81	-49.06	-39.98	-47.10	
03-Jul-2009	08:00:00	-39.72	-39.79	-49.13	-40.97	-49.11	
03-Jul-2009	20:00:00	-40.53	-39.81	-49.09	-41.76	-46.49	
04-Jul-2009	08:00:00	-41.00	-39.83	-49.14	-42.43	-49.96	
04-Jul-2009	20:00:00	-41.66	-39.89	-49.06	-42.94	-47.48	
05-Jul-2009	08:00:00	-41.98	-39.85	-49.12	-43.59	-49.79	
05-Jul-2009	20:00:00	-42.35	-39.81	-49.06	-44.08	-48.07	
06-Jul-2009	08:00:00	-42.60	-39.83	-49.10	-44.65	-49.32	
06-Jul-2009	20:00:00	-43.10	-39.85	-49.10	-45.14	-48.48	
07-Jul-2009	08:00:00	-43.50	-39.86	-49.12	-45.70	-49.32	
07-Jul-2009	20:00:00	-44.17	-39.86	-49.06	-46.17	-47.00	
08-Jul-2009	08:00:00	-44.69	-39.85	-49.11	-46.77	-49.75	
08-Jul-2009	20:00:00	-45.16	-39.84	-49.08	-47.22	-47.58	
09-Jul-2009	08:00:00	-45.52	-39.82	-49.11	-47.75	-48.80	
09-Jul-2009	20:00:00	-45.95	-39.81	-49.09	-47.90	-48.44	
10-Jul-2009	08:00:00	-45.93	-39.78	-49.11	-48.00	-49.48	
10-Jul-2009	20:00:00	-46.14	-39.82	-49.08	-47.95	-47.76	
11-Jul-2009	08:00:00	-45.69	-39.82	-49.14	-48.01	-49.83	
11-Jul-2009	20:00:00	-45.61	-39.86	-49.08	-47.93	-47.87	
12-Jul-2009	08:00:00	-45.49	-39.88	-49.11	-48.01	-49.46	
12-Jul-2009	20:00:00	-45.54	-39.87	-49.07	-47.91	-48.03	
13-Jul-2009	08:00:00	-45.58	-39.87	-49.10	-47.93	-48.42	
13-Jul-2009	20:00:00	-45.61	-39.88	-49.08	-47.91	-48.23	
14-Jul-2009	08:00:00	-45.72	-39.86	-49.11	-47.99	-48.82	
14-Jul-2009	20:00:00	-45.73	-39.86	-49.07	-47.93	-46.28	
15-Jul-2009	08:00:00	-45.77	-39.83	-49.11	-48.03	-50.04	
15-Jul-2009	20:00:00	-45.73	-39.89	-49.07	-47.93	-48.28	
16-Jul-2009	08:00:00	-45.73	-39.89	-49.12	-47.97	-50.08	
16-Jul-2009	20:00:00	-45.84	-39.88	-49.08	-47.93	-48.30	
17-Jul-2009	08:00:00	-45.83	-39.90	-49.12	-47.96	-49.88	
17-Jul-2009	20:00:00	-45.84	-39.90	-49.08	-47.89	-47.85	
18-Jul-2009	08:00:00	-45.84	-39.86	-49.12	-47.96	-48.77	
18-Jul-2009	20:00:00	-45.83	-39.85	-49.10	-47.93	-47.86	
19-Jul-2009	08:00:00	-45.85	-39.84	-49.13	-48.00	-49.84	
19-Jul-2009	20:00:00	-45.83	-39.88	-49.09	-47.95	-48.08	
20-Jul-2009	08:00:00	-45.84	-39.87	-49.12	-47.99	-49.75	
20-Jul-2009	20:00:00	-45.83	-39.88	-49.09	-47.93	-46.57	
21-Jul-2009	08:00:00	-45.83	-39.85	-49.11	-47.97	-49.28	
21-Jul-2009	20:00:00	-45.84	-39.87	-49.10	-47.95	-48.45	
22-Jul-2009	08:00:00	-45.85	-39.86	-49.13	-47.98	-49.24	
22-Jul-2009	20:00:00	-45.83	-39.89	-49.08	-47.92	-47.77	
23-Jul-2009	08:00:00	-45.84	-39.90	-49.11	-47.96	-49.44	
23-Jul-2009	20:00:00	-45.84	-39.91	-49.07	-47.91	-47.64	
24-Jul-2009	08:00:00	-45.84	-39.89	-49.13	-47.96	-49.23	
24-Jul-2009	20:00:00	-45.84	-39.89	-49.07	-47.92	-47.60	
25-Jul-2009	08:00:00	-45.84	-39.87	-49.14	-47.98	-49.95	
25-Jul-2009	20:00:00	-45.84	-39.75	-49.05	-47.88	-46.81	
26-Jul-2009	08:00:00	-45.85	-39.75	-49.14	-47.98	-49.37	
26-Jul-2009	20:00:00	-45.83	-39.75	-49.08	-47.91	-46.92	
27-Jul-2009	08:00:00	-45.84	-39.76	-49.15	-47.98	-49.39	
27-Jul-2009	20:00:00	-45.85	-39.75	-49.15	-47.93	-48.22	0

Date	Time						
dd-mmm-yyyy	hh:mm:ss	Jon AW13	Jon AW14	Jon RAW1	Jon RAW2	Jon RAW3	CG1
28-Jul-2009	08:00:00	-45.82	-39.75	-49.20	-47.97	-49.70	
28-Jul-2009	20:00:00	-45.84	-39.76	-49.14	-47.90	-47.75	
29-Jul-2009	08:00:00	-45.83	-39.76	-49.20	-47.96	-49.83	
29-Jul-2009	20:00:00	-45.82	-39.75	-49.17	-47.92	-48.78	
30-Jul-2009	08:00:00	-45.84	-39.76	-49.19	-47.95	-49.44	
30-Jul-2009	20:00:00	-45.83	-39.76	-49.16	-47.91	-48.37	
31-Jul-2009	08:00:00	-45.83	-39.76	-49.21	-47.96	-49.90	
31-Jul-2009	20:00:00	-45.83	-39.76	-49.17	-47.92	-48.70	
01-Aug-2009	08:00:00	-45.83	-39.76	-49.20	-47.96	-49.97	
01-Aug-2009	20:00:00	-45.82	-39.76	-49.17	-47.92	-48.74	
02-Aug-2009	08:00:00	-45.83	-39.76	-49.20	-47.93	-49.97	
02-Aug-2009	20:00:00	-45.83	-39.77	-49.17	-47.90	-49.46	
03-Aug-2009	08:00:00	-45.84	-39.75	-49.21	-47.94	-50.16	
03-Aug-2009	20:00:00	-45.85	-39.76	-49.17	-47.90	-47.92	
04-Aug-2009	08:00:00	-45.84	-39.76	-49.20	-47.96	-50.26	
04-Aug-2009	20:00:00	-45.85	-39.75	-49.17	-47.89	-48.30	
05-Aug-2009	08:00:00	-45.83	-39.76	-49.19	-47.93	-50.40	
05-Aug-2009	20:00:00	-45.84	-39.75	-49.08	-47.87	-44.90	
06-Aug-2009	08:00:00	-45.83	-39.77	-49.18	-47.92	-50.58	
06-Aug-2009	20:00:00	-45.82	-39.76	-49.16	-47.88	-48.40	
07-Aug-2009	08:00:00	-45.83	-39.77	-49.18	-47.96	-50.06	
07-Aug-2009	20:00:00	-45.83	-39.75	-49.15	-47.90	-48.29	
08-Aug-2009	08:00:00	-45.83	-39.75	-49.18	-47.96	-50.44	
08-Aug-2009	20:00:00	-45.84	-39.75	-49.15	-47.90	-48.66	
09-Aug-2009	08:00:00	-45.84	-39.75	-49.20	-47.96	-50.45	
09-Aug-2009	20:00:00	-45.83	-39.75	-49.16	-47.89	-48.48	
10-Aug-2009	08:00:00	-45.84	-39.76	-49.18	-47.95	-50.49	
10-Aug-2009	20:00:00	-45.83	-39.76	-49.13	-47.86	-47.95	
11-Aug-2009	08:00:00	-45.84	-39.76	-49.18	-47.91	-50.24	
11-Aug-2009	20:00:00	-45.84	-39.77	-49.14	-47.86	-46.72	
12-Aug-2009	08:00:00	-45.84	-39.77	-49.18	-47.90	-50.38	
12-Aug-2009	20:00:00	-45.84	-39.76	-49.15	-47.89	-50.10	
13-Aug-2009	08:00:00	-45.83	-39.76	-49.17	-47.90	-50.22	
13-Aug-2009	20:00:00	-45.84	-39.75	-49.15	-47.88	-49.44	
14-Aug-2009	08:00:00	-45.84	-39.74	-49.19	-47.94	-50.68	
14-Aug-2009	20:00:00	-31.81	-39.75	-49.17	-47.87	-48.93	
15-Aug-2009	08:00:00	-35.68	-39.75	-49.17	-47.91	-50.48	
15-Aug-2009	20:00:00	-38.34	-39.74	-49.15	-47.88	-48.82	
16-Aug-2009	08:00:00	-40.80	-39.75	-49.19	-47.93	-50.63	
16-Aug-2009	20:00:00	-42.94	-39.73	-49.15	-47.88	-49.34	
17-Aug-2009	08:00:00	-44.63	-39.74	-49.16	-47.93	-50.54	
17-Aug-2009	20:00:00	-45.89	-39.75	-49.16	-47.87	-49.29	
18-Aug-2009	08:00:00	-45.79	-39.76	-49.16	-47.92	-50.44	
18-Aug-2009	20:00:00	-45.80	-39.76	-49.11	-47.94	-48.55	
19-Aug-2009	08:00:00	-45.82	-39.75	-49.17	-47.99	-50.96	
19-Aug-2009	20:00:00	-45.79	-39.76	-49.11	-47.94	-49.41	
20-Aug-2009	08:00:00	-45.82	-39.76	-49.18	-47.99	-50.91	
20-Aug-2009	20:00:00	-45.80	-39.76	-49.14	-47.94	-49.71	
21-Aug-2009	08:00:00	-45.81	-39.77	-49.17	-47.96	-50.87	
21-Aug-2009	20:00:00	-45.81	-39.77	-49.12	-47.93	-49.26	
22-Aug-2009	08:00:00	-45.82	-39.78	-49.17	-47.95	-50.52	
22-Aug-2009	20:00:00	-45.82	-39.76	-49.13	-47.92	-48.32	

Date	Time						
dd-mmm-yyyy	hh:mm:ss	Jon AW13	Jon AW14	Jon RAW1	Jon RAW2	Jon RAW3	CG1
23-Aug-2009	08:00:00	-26.63	-39.77	-49.16	-47.97	-50.44	
23-Aug-2009	20:00:00	-31.00	-39.75	-49.13	-47.94	-49.40	
24-Aug-2009	08:00:00	-34.35	-39.74	-49.16	-47.98	-50.30	
24-Aug-2009	20:00:00	-38.17	-39.75	-49.12	-48.05	-49.21	0
25-Aug-2009	08:00:00	-40.91	-39.75	-49.14	-48.12	-49.28	
25-Aug-2009	20:00:00	-43.45	-39.75	-49.08	-48.05	-49.21	
26-Aug-2009	08:00:00	-45.41	-39.74	-49.13	-48.12	-49.28	
26-Aug-2009	20:00:00	-45.88	-39.75	-49.11	-48.06	-49.22	
27-Aug-2009	08:00:00	-45.86	-39.76	-49.13	-48.10	-49.26	
27-Aug-2009	20:00:00	-45.86	-39.75	-49.11	-48.05	-49.21	
28-Aug-2009	08:00:00	-45.87	-39.75	-49.11	-48.09	-49.25	
28-Aug-2009	20:00:00	-45.85	-39.76	-48.98	-48.07	-49.23	
29-Aug-2009	08:00:00	-45.85	-39.77	-49.15	-48.10	-49.26	
29-Aug-2009	20:00:00	-45.86	-39.76	-49.11	-48.05	-49.21	
30-Aug-2009	08:00:00	-45.89	-39.76	-49.14	-48.12	-49.28	
30-Aug-2009	20:00:00	-45.89	-39.76	-49.11	-48.06	-49.22	
31-Aug-2009	08:00:00	-45.89	-39.74	-49.12	-48.10	-49.26	
31-Aug-2009	20:00:00	-45.89	-39.74	-49.12	-48.10	-49.26	
01-Sep-2009	08:00:00	-45.91	-39.76	-49.12	-48.11	-49.27	
01-Sep-2009	20:00:00	-45.84	-39.74	-49.08	-48.07	-49.23	
02-Sep-2009	08:00:00	-45.85	-39.74	-49.11	-48.14	-49.30	
02-Sep-2009	20:00:00	-45.84	-39.76	-49.08	-48.06	-49.22	
03-Sep-2009	08:00:00	-45.84	-39.75	-49.12	-48.11	-49.27	
03-Sep-2009	20:00:00	-45.85	-39.76	-49.07	-48.04	-49.20	
04-Sep-2009	08:00:00	-45.85	-39.76	-49.12	-48.10	-49.26	
04-Sep-2009	20:00:00	-45.85	-39.75	-49.06	-48.06	-49.22	
05-Sep-2009	08:00:00	-45.85	-39.75	-49.13	-48.12	-49.28	
05-Sep-2009	20:00:00	-45.85	-39.75	-49.09	-48.07	-49.23	
06-Sep-2009	08:00:00	-45.85	-39.74	-49.13	-48.12	-49.28	
06-Sep-2009	20:00:00	-45.83	-39.75	-49.08	-48.07	-49.23	
07-Sep-2009	08:00:00	-45.86	-39.75	-49.13	-48.12	-49.28	
07-Sep-2009	20:00:00	-45.85	-39.75	-49.11	-48.06	-49.22	
08-Sep-2009	08:00:00	-45.85	-39.75	-49.13	-48.10	-49.26	
08-Sep-2009	20:00:00	-45.84	-39.75	-49.08	-48.04	-49.20	
09-Sep-2009	08:00:00	-45.85	-39.76	-49.19	-48.14	-49.30	
09-Sep-2009	20:00:00	-45.85	-39.75	-49.11	-48.08	-49.24	
10-Sep-2009	08:00:00	-45.84	-39.73	-49.13	-48.12	-49.28	
10-Sep-2009	20:00:00	-45.85	-39.73	-49.13	-48.10	-49.26	
11-Sep-2009	08:00:00	-45.86	-39.74	-49.14	-48.14	-49.30	
11-Sep-2009	20:00:00	-45.85	-39.75	-49.09	-48.06	-49.22	
12-Sep-2009	08:00:00	-45.84	-39.78	-49.14	-48.10	-49.26	
12-Sep-2009	20:00:00	-45.85	-39.76	-49.08	-48.04	-49.20	
13-Sep-2009	08:00:00	-45.84	-39.76	-49.14	-48.12	-49.28	
13-Sep-2009	20:00:00	-45.85	-39.74	-49.09	-48.04	-49.20	
14-Sep-2009	08:00:00	-45.86	-39.75	-49.14	-48.11	-49.27	
14-Sep-2009	20:00:00	-45.85	-39.76	-49.08	-48.05	-49.21	
15-Sep-2009	08:00:00	-45.85	-39.74	-49.15	-48.10	-49.26	
15-Sep-2009	20:00:00	-45.85	-39.76	-49.12	-48.06	-49.22	
16-Sep-2009	08:00:00	-45.85	-39.76	-49.15	-48.11	-49.27	
16-Sep-2009	20:00:00	-45.84	-39.75	-49.14	-48.09	-49.25	
17-Sep-2009	08:00:00	-45.85	-39.75	-49.14	-48.11	-49.27	
17-Sep-2009	20:00:00	-45.83	-39.75	-49.13	-48.08	-49.24	

Date	Time		On-site Raingauge	Wadesboro Daily Rainfall	Wadesboro Monthly Rainfall
dd-mmm-yyyy	hh:mm:ss	CG2			
01-Jan-2009	08:00:00				
01-Jan-2009	20:00:00				
02-Jan-2009	08:00:00				
02-Jan-2009	20:00:00				
03-Jan-2009	08:00:00				
03-Jan-2009	20:00:00				
04-Jan-2009	08:00:00			0.39	
04-Jan-2009	20:00:00				
05-Jan-2009	08:00:00			0.27	
05-Jan-2009	20:00:00				
06-Jan-2009	08:00:00			0.57	
06-Jan-2009	20:00:00				
07-Jan-2009	08:00:00			0.23	
07-Jan-2009	20:00:00				
08-Jan-2009	08:00:00			0.23	
08-Jan-2009	20:00:00				
09-Jan-2009	08:00:00				
09-Jan-2009	20:00:00				
10-Jan-2009	08:00:00				
10-Jan-2009	20:00:00				
11-Jan-2009	08:00:00			0.07	
11-Jan-2009	20:00:00				
12-Jan-2009	08:00:00				
12-Jan-2009	20:00:00				
13-Jan-2009	08:00:00				
13-Jan-2009	20:00:00				
14-Jan-2009	08:00:00				
14-Jan-2009	20:00:00				
15-Jan-2009	08:00:00				
15-Jan-2009	20:00:00				
16-Jan-2009	08:00:00				
16-Jan-2009	20:00:00				
17-Jan-2009	08:00:00				
17-Jan-2009	20:00:00				
18-Jan-2009	08:00:00				
18-Jan-2009	20:00:00				
19-Jan-2009	08:00:00			0.05	
19-Jan-2009	20:00:00				
20-Jan-2009	08:00:00			0.14	
20-Jan-2009	20:00:00				
21-Jan-2009	08:00:00				
21-Jan-2009	20:00:00				
22-Jan-2009	08:00:00				
22-Jan-2009	20:00:00				
23-Jan-2009	08:00:00				
23-Jan-2009	20:00:00				
24-Jan-2009	08:00:00				
24-Jan-2009	20:00:00				
25-Jan-2009	08:00:00			0.03	
25-Jan-2009	20:00:00				
26-Jan-2009	08:00:00				
26-Jan-2009	20:00:00				

Date	Time		On-site Raingauge	Wadesboro Daily Rainfall	Wadesboro Monthly Rainfall
dd-mmm-yyyy	hh:mm:ss	CG2			
27-Jan-2009	08:00:00				
27-Jan-2009	20:00:00				
28-Jan-2009	08:00:00				
28-Jan-2009	20:00:00				
29-Jan-2009	08:00:00			0.15	
29-Jan-2009	20:00:00				
30-Jan-2009	08:00:00				
30-Jan-2009	20:00:00				
31-Jan-2009	08:00:00				
31-Jan-2009	20:00:00				2.13
01-Feb-2009	08:00:00				
01-Feb-2009	20:00:00				
02-Feb-2009	08:00:00				
02-Feb-2009	20:00:00				
03-Feb-2009	08:00:00				
03-Feb-2009	20:00:00				
04-Feb-2009	08:00:00				
04-Feb-2009	20:00:00				
05-Feb-2009	08:00:00				
05-Feb-2009	20:00:00				
06-Feb-2009	08:00:00				
06-Feb-2009	20:00:00				
07-Feb-2009	08:00:00				
07-Feb-2009	20:00:00				
08-Feb-2009	08:00:00				
08-Feb-2009	20:00:00				
09-Feb-2009	08:00:00				
09-Feb-2009	20:00:00				
10-Feb-2009	08:00:00				
10-Feb-2009	20:00:00				
11-Feb-2009	08:00:00			0.1	
11-Feb-2009	20:00:00				
12-Feb-2009	08:00:00				
12-Feb-2009	20:00:00				
13-Feb-2009	08:00:00				
13-Feb-2009	20:00:00				
14-Feb-2009	08:00:00			0.01	
14-Feb-2009	20:00:00				
15-Feb-2009	08:00:00				
15-Feb-2009	20:00:00				
16-Feb-2009	08:00:00			0.06	
16-Feb-2009	20:00:00				
17-Feb-2009	08:00:00				
17-Feb-2009	20:00:00				
18-Feb-2009	08:00:00			0.42	
18-Feb-2009	20:00:00				
19-Feb-2009	08:00:00				
19-Feb-2009	20:00:00				
20-Feb-2009	08:00:00				
20-Feb-2009	20:00:00				
21-Feb-2009	08:00:00				
21-Feb-2009	20:00:00				

Appendix D

Monitoring Year 4 - 2009

Date	Time		On-site Raingauge	Wadesboro Daily Rainfall	Wadesboro Monthly Rainfall
dd-mmm-yyyy	hh:mm:ss	CG2			
22-Feb-2009	08:00:00				
22-Feb-2009	20:00:00				
23-Feb-2009	08:00:00				
23-Feb-2009	20:00:00				
24-Feb-2009	08:00:00				
24-Feb-2009	20:00:00				
25-Feb-2009	08:00:00	0	0		
25-Feb-2009	20:00:00				
26-Feb-2009	08:00:00				
26-Feb-2009	20:00:00				
27-Feb-2009	08:00:00			0.03	
27-Feb-2009	20:00:00				
28-Feb-2009	08:00:00			0.95	
28-Feb-2009	20:00:00				1.57
01-Mar-2009	08:00:00			0.75	
01-Mar-2009	20:00:00				
02-Mar-2009	08:00:00				
02-Mar-2009	20:00:00				
03-Mar-2009	08:00:00				
03-Mar-2009	20:00:00				
04-Mar-2009	08:00:00				
04-Mar-2009	20:00:00				
05-Mar-2009	08:00:00				
05-Mar-2009	20:00:00				
06-Mar-2009	08:00:00				
06-Mar-2009	20:00:00				
07-Mar-2009	08:00:00				
07-Mar-2009	20:00:00				
08-Mar-2009	08:00:00				
08-Mar-2009	20:00:00				
09-Mar-2009	08:00:00				
09-Mar-2009	20:00:00				
10-Mar-2009	08:00:00				
10-Mar-2009	20:00:00				
11-Mar-2009	08:00:00				
11-Mar-2009	20:00:00				
12-Mar-2009	08:00:00				
12-Mar-2009	20:00:00				
13-Mar-2009	08:00:00				
13-Mar-2009	20:00:00				
14-Mar-2009	08:00:00			0.03	
14-Mar-2009	20:00:00				
15-Mar-2009	08:00:00			0.33	
15-Mar-2009	20:00:00				
16-Mar-2009	08:00:00			0.15	
16-Mar-2009	20:00:00				
17-Mar-2009	08:00:00				
17-Mar-2009	20:00:00				
18-Mar-2009	08:00:00				
18-Mar-2009	20:00:00				
19-Mar-2009	08:00:00			0.18	
19-Mar-2009	20:00:00				

Appendix D

Monitoring Year 4 - 2009

Date	Time		On-site Raingauge	Wadesboro Daily Rainfall	Wadesboro Monthly Rainfall
dd-mmm-yyyy	hh:mm:ss	CG2			
20-Mar-2009	08:00:00				
20-Mar-2009	20:00:00				
21-Mar-2009	08:00:00				
21-Mar-2009	20:00:00				
22-Mar-2009	08:00:00				
22-Mar-2009	20:00:00				
23-Mar-2009	08:00:00	0	4.05		
23-Mar-2009	20:00:00				
24-Mar-2009	08:00:00				
24-Mar-2009	20:00:00				
25-Mar-2009	08:00:00			0.03	
25-Mar-2009	20:00:00				
26-Mar-2009	08:00:00			0.04	
26-Mar-2009	20:00:00				
27-Mar-2009	08:00:00			0.03	
27-Mar-2009	20:00:00				
28-Mar-2009	08:00:00			0.42	
28-Mar-2009	20:00:00				
29-Mar-2009	08:00:00				
29-Mar-2009	20:00:00				
30-Mar-2009	08:00:00				
30-Mar-2009	20:00:00				
31-Mar-2009	08:00:00				
31-Mar-2009	20:00:00				
01-Apr-2009	08:00:00				
01-Apr-2009	20:00:00				1.96
02-Apr-2009	08:00:00			0.43	
02-Apr-2009	20:00:00				
03-Apr-2009	08:00:00			0.22	
03-Apr-2009	20:00:00				
04-Apr-2009	08:00:00				
04-Apr-2009	20:00:00				
05-Apr-2009	08:00:00				
05-Apr-2009	20:00:00				
06-Apr-2009	08:00:00				
06-Apr-2009	20:00:00				
07-Apr-2009	08:00:00				
07-Apr-2009	20:00:00				
08-Apr-2009	08:00:00				
08-Apr-2009	20:00:00				
09-Apr-2009	08:00:00				
09-Apr-2009	20:00:00				
10-Apr-2009	08:00:00			0.38	
10-Apr-2009	20:00:00				
11-Apr-2009	08:00:00				
11-Apr-2009	20:00:00				
12-Apr-2009	08:00:00				
12-Apr-2009	20:00:00				
13-Apr-2009	08:00:00				
13-Apr-2009	20:00:00				
14-Apr-2009	08:00:00			0.33	
14-Apr-2009	20:00:00				

Date	Time		On-site Raingauge	Wadesboro Daily Rainfall	Wadesboro Monthly Rainfall
dd-mmm-yyyy	hh:mm:ss	CG2			
15-Apr-2009	08:00:00				
15-Apr-2009	20:00:00				
16-Apr-2009	08:00:00				
16-Apr-2009	20:00:00				
17-Apr-2009	08:00:00				
17-Apr-2009	20:00:00				
18-Apr-2009	08:00:00				
18-Apr-2009	20:00:00				
19-Apr-2009	08:00:00				
19-Apr-2009	20:00:00				
20-Apr-2009	08:00:00			0.12	
20-Apr-2009	20:00:00				
21-Apr-2009	08:00:00				
21-Apr-2009	20:00:00				
22-Apr-2009	08:00:00				
22-Apr-2009	20:00:00				
23-Apr-2009	08:00:00	0	2.88	0.03	
23-Apr-2009	20:00:00				
24-Apr-2009	08:00:00				
24-Apr-2009	20:00:00				
25-Apr-2009	08:00:00				
25-Apr-2009	20:00:00				
26-Apr-2009	08:00:00				
26-Apr-2009	20:00:00				
27-Apr-2009	08:00:00				
27-Apr-2009	20:00:00				
28-Apr-2009	08:00:00				
28-Apr-2009	20:00:00				
29-Apr-2009	08:00:00				
29-Apr-2009	20:00:00				
30-Apr-2009	08:00:00				
30-Apr-2009	20:00:00				
01-May-2009	08:00:00			0.01	
01-May-2009	20:00:00				1.51
02-May-2009	08:00:00			0.63	
02-May-2009	20:00:00				
03-May-2009	08:00:00				
03-May-2009	20:00:00				
04-May-2009	08:00:00			0.01	
04-May-2009	20:00:00				
05-May-2009	08:00:00			0.44	
05-May-2009	20:00:00				
06-May-2009	08:00:00			0.06	
06-May-2009	20:00:00				
07-May-2009	08:00:00				
07-May-2009	20:00:00				
08-May-2009	08:00:00			0.01	
08-May-2009	20:00:00				
09-May-2009	08:00:00				
09-May-2009	20:00:00				
10-May-2009	08:00:00				
10-May-2009	20:00:00				

Date	Time		On-site Raingauge	Wadesboro Daily Rainfall	Wadesboro Monthly Rainfall
dd-mmm-yyyy	hh:mm:ss	CG2			
11-May-2009	08:00:00			0.3	
11-May-2009	20:00:00				
12-May-2009	08:00:00				
12-May-2009	20:00:00				
13-May-2009	08:00:00				
13-May-2009	20:00:00				
14-May-2009	08:00:00				
14-May-2009	20:00:00				
15-May-2009	08:00:00				
15-May-2009	20:00:00				
16-May-2009	08:00:00				
16-May-2009	20:00:00				
17-May-2009	08:00:00			0.26	
17-May-2009	20:00:00				
18-May-2009	08:00:00			0.03	
18-May-2009	20:00:00				
19-May-2009	08:00:00				
19-May-2009	20:00:00				
20-May-2009	08:00:00				
20-May-2009	20:00:00				
21-May-2009	08:00:00				
21-May-2009	20:00:00				
22-May-2009	08:00:00				
22-May-2009	20:00:00				
23-May-2009	08:00:00				
23-May-2009	20:00:00				
24-May-2009	08:00:00			0.29	
24-May-2009	20:00:00				
25-May-2009	08:00:00			0.23	
25-May-2009	20:00:00				
26-May-2009	08:00:00			0.19	
26-May-2009	20:00:00				
27-May-2009	08:00:00				
27-May-2009	20:00:00				
28-May-2009	08:00:00			0.36	
28-May-2009	20:00:00				
29-May-2009	08:00:00				
29-May-2009	20:00:00	0	5.39		
30-May-2009	08:00:00				
30-May-2009	20:00:00				
31-May-2009	08:00:00				
31-May-2009	20:00:00				
01-Jun-2009	08:00:00				
01-Jun-2009	20:00:00				2.82
02-Jun-2009	08:00:00				
02-Jun-2009	20:00:00				
03-Jun-2009	08:00:00				
03-Jun-2009	20:00:00				
04-Jun-2009	08:00:00			0.99	
04-Jun-2009	20:00:00				
05-Jun-2009	08:00:00			0.01	
05-Jun-2009	20:00:00				

Date	Time		On-site Raingauge	Wadesboro Daily Rainfall	Wadesboro Monthly Rainfall
dd-mmm-yyyy	hh:mm:ss	CG2			
06-Jun-2009	08:00:00				
06-Jun-2009	20:00:00				
07-Jun-2009	08:00:00				
07-Jun-2009	20:00:00				
08-Jun-2009	08:00:00				
08-Jun-2009	20:00:00				
09-Jun-2009	08:00:00			0.45	
09-Jun-2009	20:00:00				
10-Jun-2009	08:00:00			0.19	
10-Jun-2009	20:00:00				
11-Jun-2009	08:00:00			0.17	
11-Jun-2009	20:00:00				
12-Jun-2009	08:00:00			0.08	
12-Jun-2009	20:00:00				
13-Jun-2009	08:00:00				
13-Jun-2009	20:00:00				
14-Jun-2009	08:00:00				
14-Jun-2009	20:00:00				
15-Jun-2009	08:00:00				
15-Jun-2009	20:00:00				
16-Jun-2009	08:00:00			0.02	
16-Jun-2009	20:00:00				
17-Jun-2009	08:00:00			0.02	
17-Jun-2009	20:00:00				
18-Jun-2009	08:00:00				
18-Jun-2009	20:00:00				
19-Jun-2009	08:00:00				
19-Jun-2009	20:00:00				
20-Jun-2009	08:00:00				
20-Jun-2009	20:00:00				
21-Jun-2009	08:00:00				
21-Jun-2009	20:00:00				
22-Jun-2009	08:00:00				
22-Jun-2009	20:00:00	0	2.38		
23-Jun-2009	08:00:00				
23-Jun-2009	20:00:00				
24-Jun-2009	08:00:00				
24-Jun-2009	20:00:00				
25-Jun-2009	08:00:00				
25-Jun-2009	20:00:00				
26-Jun-2009	08:00:00				
26-Jun-2009	20:00:00				
27-Jun-2009	08:00:00				
27-Jun-2009	20:00:00				
28-Jun-2009	08:00:00				
28-Jun-2009	20:00:00				
29-Jun-2009	08:00:00				
29-Jun-2009	20:00:00				
30-Jun-2009	08:00:00				
30-Jun-2009	20:00:00				
01-Jul-2009	08:00:00				
01-Jul-2009	20:00:00				1.93

Date	Time		On-site Raingauge	Wadesboro Daily Rainfall	Wadesboro Monthly Rainfall
dd-mmm-yyyy	hh:mm:ss	CG2			
02-Jul-2009	08:00:00				
02-Jul-2009	20:00:00				
03-Jul-2009	08:00:00				
03-Jul-2009	20:00:00				
04-Jul-2009	08:00:00				
04-Jul-2009	20:00:00				
05-Jul-2009	08:00:00				
05-Jul-2009	20:00:00				
06-Jul-2009	08:00:00				
06-Jul-2009	20:00:00				
07-Jul-2009	08:00:00				
07-Jul-2009	20:00:00				
08-Jul-2009	08:00:00				
08-Jul-2009	20:00:00				
09-Jul-2009	08:00:00				
09-Jul-2009	20:00:00				
10-Jul-2009	08:00:00				
10-Jul-2009	20:00:00				
11-Jul-2009	08:00:00				
11-Jul-2009	20:00:00				
12-Jul-2009	08:00:00				
12-Jul-2009	20:00:00				
13-Jul-2009	08:00:00			0.07	
13-Jul-2009	20:00:00				
14-Jul-2009	08:00:00				
14-Jul-2009	20:00:00				
15-Jul-2009	08:00:00				
15-Jul-2009	20:00:00				
16-Jul-2009	08:00:00			0.26	
16-Jul-2009	20:00:00				
17-Jul-2009	08:00:00				
17-Jul-2009	20:00:00				
18-Jul-2009	08:00:00				
18-Jul-2009	20:00:00				
19-Jul-2009	08:00:00				
19-Jul-2009	20:00:00				
20-Jul-2009	08:00:00			0.07	
20-Jul-2009	20:00:00				
21-Jul-2009	08:00:00			0.11	
21-Jul-2009	20:00:00				
22-Jul-2009	08:00:00			0.37	
22-Jul-2009	20:00:00				
23-Jul-2009	08:00:00			0.05	
23-Jul-2009	20:00:00				
24-Jul-2009	08:00:00			0.05	
24-Jul-2009	20:00:00				
25-Jul-2009	08:00:00				
25-Jul-2009	20:00:00				
26-Jul-2009	08:00:00				
26-Jul-2009	20:00:00				
27-Jul-2009	08:00:00			0.31	
27-Jul-2009	20:00:00	0	2.19		

Appendix D

Monitoring Year 4 - 2009

Date	Time		On-site Raingauge	Wadesboro Daily Rainfall	Wadesboro Monthly Rainfall
dd-mmm-yyyy	hh:mm:ss	CG2			
28-Jul-2009	08:00:00			0.14	
28-Jul-2009	20:00:00				
29-Jul-2009	08:00:00			0.02	
29-Jul-2009	20:00:00				
30-Jul-2009	08:00:00				
30-Jul-2009	20:00:00				
31-Jul-2009	08:00:00			0.05	
31-Jul-2009	20:00:00				
01-Aug-2009	08:00:00				
01-Aug-2009	20:00:00				1.5
02-Aug-2009	08:00:00			0.11	
02-Aug-2009	20:00:00				
03-Aug-2009	08:00:00				
03-Aug-2009	20:00:00				
04-Aug-2009	08:00:00				
04-Aug-2009	20:00:00				
05-Aug-2009	08:00:00			0.16	
05-Aug-2009	20:00:00				
06-Aug-2009	08:00:00				
06-Aug-2009	20:00:00				
07-Aug-2009	08:00:00				
07-Aug-2009	20:00:00				
08-Aug-2009	08:00:00				
08-Aug-2009	20:00:00				
09-Aug-2009	08:00:00				
09-Aug-2009	20:00:00				
10-Aug-2009	08:00:00				
10-Aug-2009	20:00:00				
11-Aug-2009	08:00:00			0.05	
11-Aug-2009	20:00:00				
12-Aug-2009	08:00:00			0.12	
12-Aug-2009	20:00:00				
13-Aug-2009	08:00:00			0.21	
13-Aug-2009	20:00:00				
14-Aug-2009	08:00:00			0.05	
14-Aug-2009	20:00:00				
15-Aug-2009	08:00:00				
15-Aug-2009	20:00:00				
16-Aug-2009	08:00:00				
16-Aug-2009	20:00:00				
17-Aug-2009	08:00:00				
17-Aug-2009	20:00:00				
18-Aug-2009	08:00:00				
18-Aug-2009	20:00:00				
19-Aug-2009	08:00:00			0.01	
19-Aug-2009	20:00:00				
20-Aug-2009	08:00:00			0.02	
20-Aug-2009	20:00:00				
21-Aug-2009	08:00:00				
21-Aug-2009	20:00:00				
22-Aug-2009	08:00:00			0.97	
22-Aug-2009	20:00:00				

Date	Time		On-site Raingauge	Wadesboro Daily Rainfall	Wadesboro Monthly Rainfall
dd-mmm-yyyy	hh:mm:ss	CG2			
23-Aug-2009	08:00:00				
23-Aug-2009	20:00:00				
24-Aug-2009	08:00:00				
24-Aug-2009	20:00:00	0	4.6		
25-Aug-2009	08:00:00				
25-Aug-2009	20:00:00				
26-Aug-2009	08:00:00				
26-Aug-2009	20:00:00				
27-Aug-2009	08:00:00				
27-Aug-2009	20:00:00				
28-Aug-2009	08:00:00			0.01	
28-Aug-2009	20:00:00				
29-Aug-2009	08:00:00				
29-Aug-2009	20:00:00				
30-Aug-2009	08:00:00			0.16	
30-Aug-2009	20:00:00				
31-Aug-2009	08:00:00			0.11	
31-Aug-2009	20:00:00				
01-Sep-2009	08:00:00				
01-Sep-2009	20:00:00				1.98
02-Sep-2009	08:00:00				
02-Sep-2009	20:00:00				
03-Sep-2009	08:00:00				
03-Sep-2009	20:00:00				
04-Sep-2009	08:00:00				
04-Sep-2009	20:00:00				
05-Sep-2009	08:00:00				
05-Sep-2009	20:00:00				
06-Sep-2009	08:00:00				
06-Sep-2009	20:00:00				
07-Sep-2009	08:00:00				
07-Sep-2009	20:00:00				
08-Sep-2009	08:00:00				
08-Sep-2009	20:00:00				
09-Sep-2009	08:00:00				
09-Sep-2009	20:00:00				
10-Sep-2009	08:00:00				
10-Sep-2009	20:00:00				
11-Sep-2009	08:00:00				
11-Sep-2009	20:00:00				
12-Sep-2009	08:00:00				
12-Sep-2009	20:00:00				
13-Sep-2009	08:00:00				
13-Sep-2009	20:00:00				
14-Sep-2009	08:00:00				
14-Sep-2009	20:00:00				
15-Sep-2009	08:00:00				
15-Sep-2009	20:00:00				
16-Sep-2009	08:00:00				
16-Sep-2009	20:00:00			0.05	
17-Sep-2009	08:00:00				
17-Sep-2009	20:00:00				

Date	Time	Water Level (inches)				
		Jon AW15	Jon AW16	Jon AW17	Jon AW18	Jon AW19
1-Jan-2009	06:00:00	-3.57	-6.90	-25.74	-6.75	-5.58
1-Jan-2009	12:00:00	-3.14	-6.62	-25.27	-6.02	-4.83
1-Jan-2009	18:00:00	-2.52	-5.90	-24.73	-4.97	-3.27
1-Jan-2009	24:00:00	-3.80	-7.37	-25.98	-6.18	-4.49
2-Jan-2009	06:00:00	-4.82	-8.20	-26.71	-6.75	-5.35
2-Jan-2009	12:00:00	-6.34	-9.60	-28.28	-8.21	-6.43
2-Jan-2009	18:00:00	-7.60	-10.37	-29.55	-9.13	-7.05
2-Jan-2009	24:00:00	-8.35	-11.32	-30.96	-10.27	-8.06
3-Jan-2009	06:00:00	-7.29	-10.90	-30.81	-9.73	-7.81
3-Jan-2009	12:00:00	-7.00	-10.90	-30.98	-9.73	-7.65
3-Jan-2009	18:00:00	-6.16	-9.84	-30.16	-8.52	-6.77
3-Jan-2009	24:00:00	-6.38	-10.32	-30.56	-8.90	-6.95
4-Jan-2009	06:00:00	-6.26	-10.12	-30.49	-8.59	-6.83
4-Jan-2009	12:00:00	-6.56	-10.44	-30.91	-8.96	-6.95
4-Jan-2009	18:00:00	-5.23	-5.32	-26.97	-6.48	-3.83
4-Jan-2009	24:00:00	-5.52	-6.13	-25.64	-7.61	-4.26
5-Jan-2009	06:00:00	-5.80	-6.18	-24.60	-7.76	-4.33
5-Jan-2009	12:00:00	-6.21	-6.88	-24.67	-8.48	-5.10
5-Jan-2009	18:00:00	-6.60	-6.91	-24.75	-8.52	-5.22
5-Jan-2009	24:00:00	-7.89	-8.87	-26.46	-10.39	-7.19
6-Jan-2009	06:00:00	-8.26	-9.01	-26.72	-10.45	-7.55
6-Jan-2009	12:00:00	-8.18	-9.12	-27.19	-10.40	-7.70
6-Jan-2009	18:00:00	-9.18	-8.53	-22.35	-9.99	-7.67
6-Jan-2009	24:00:00	-10.16	-9.98	-19.21	-12.31	-9.07
7-Jan-2009	06:00:00	-11.92	-11.39	-21.82	-13.82	-10.37
7-Jan-2009	12:00:00	-14.78	-13.98	-24.99	-16.45	-12.87
7-Jan-2009	18:00:00	-14.23	-13.67	-21.04	-15.84	-12.86
7-Jan-2009	24:00:00	-12.52	-13.49	-22.47	-16.11	-12.74
8-Jan-2009	06:00:00	-10.78	-11.24	-21.92	-13.91	-10.55
8-Jan-2009	12:00:00	-10.06	-10.49	-22.10	-12.99	-9.91
8-Jan-2009	18:00:00	-10.71	-10.80	-22.92	-13.17	-10.45
8-Jan-2009	24:00:00	-9.84	-11.15	-23.79	-13.56	-11.04
9-Jan-2009	06:00:00	-7.34	-8.80	-22.52	-11.13	-9.23
9-Jan-2009	12:00:00	-5.08	-6.60	-20.91	-8.94	-7.39
9-Jan-2009	18:00:00	-3.70	-4.50	-19.41	-6.72	-4.97
9-Jan-2009	24:00:00	-3.94	-5.44	-20.30	-7.33	-5.57
10-Jan-2009	06:00:00	-3.27	-4.86	-19.80	-6.50	-5.01
10-Jan-2009	12:00:00	-3.42	-5.35	-20.35	-6.79	-5.18
10-Jan-2009	18:00:00	-4.69	-5.75	-21.09	-7.09	-5.16
10-Jan-2009	24:00:00	-6.51	-8.23	-23.50	-9.41	-7.16
11-Jan-2009	06:00:00	-7.27	-9.22	-24.81	-10.53	-8.22
11-Jan-2009	12:00:00	-8.13	-8.71	-24.75	-9.96	-7.44
11-Jan-2009	18:00:00	-7.52	-7.88	-22.57	-9.51	-6.38
11-Jan-2009	24:00:00	-7.36	-8.39	-22.47	-10.33	-6.98
12-Jan-2009	06:00:00	-5.95	-7.16	-21.85	-9.17	-6.01
12-Jan-2009	12:00:00	-4.51	-5.95	-21.21	-7.87	-5.17
12-Jan-2009	18:00:00	-3.16	-3.91	-20.06	-5.87	-3.73
12-Jan-2009	24:00:00	-3.56	-5.08	-21.14	-6.74	-4.68
13-Jan-2009	06:00:00	-3.49	-4.97	-21.22	-6.41	-4.41
13-Jan-2009	12:00:00	-5.40	-6.95	-23.17	-8.17	-5.85
13-Jan-2009	18:00:00	-6.52	-7.70	-24.32	-8.87	-6.59
13-Jan-2009	24:00:00	-7.81	-9.91	-26.54	-10.93	-8.41
14-Jan-2009	06:00:00	-7.09	-9.66	-26.70	-10.59	-8.58
14-Jan-2009	12:00:00	-5.23	-8.14	-25.69	-8.93	-7.38
14-Jan-2009	18:00:00	-4.11	-6.54	-24.58	-7.23	-5.13
14-Jan-2009	24:00:00	-4.93	-7.87	-25.78	-8.28	-6.25

Date	Time	Water Level (inches)				
		Jon AW15	Jon AW16	Jon AW17	Jon AW18	Jon AW19
15-Jan-2009	06:00:00	-4.96	-7.84	-25.95	-8.15	-6.35
15-Jan-2009	12:00:00	-5.19	-8.69	-26.76	-8.82	-7.05
15-Jan-2009	18:00:00	-3.68	-6.92	-25.68	-7.01	-4.95
15-Jan-2009	24:00:00	-2.91	-6.80	-25.62	-6.62	-4.93
16-Jan-2009	06:00:00	-0.42	-4.66	-23.76	-4.31	-2.96
16-Jan-2009	12:00:00	0.57	-4.04	-22.84	-3.33	-2.40
16-Jan-2009	18:00:00	1.83	-2.95	-22.10	-2.21	-1.11
16-Jan-2009	24:00:00	0.58	-3.83	-23.08	-3.09	-1.09
17-Jan-2009	06:00:00	0.51	-4.50	-23.08	-3.24	-2.03
17-Jan-2009	12:00:00	-0.22	-6.17	-23.91	-4.56	-4.87
17-Jan-2009	18:00:00	0.12	-5.80	-24.50	-4.77	-5.28
17-Jan-2009	24:00:00	-2.36	-6.12	-26.48	-6.07	-4.33
18-Jan-2009	06:00:00	-3.96	-7.62	-27.97	-7.45	-5.27
18-Jan-2009	12:00:00	-6.08	-9.41	-29.97	-9.25	-6.78
18-Jan-2009	18:00:00	-7.77	-10.70	-31.53	-10.50	-7.76
18-Jan-2009	24:00:00	-9.34	-11.58	-33.28	-11.63	-8.81
19-Jan-2009	06:00:00	-9.92	-12.34	-33.49	-12.25	-9.26
19-Jan-2009	12:00:00	-11.41	-14.10	-34.95	-14.07	-11.37
19-Jan-2009	18:00:00	-11.74	-14.15	-35.50	-14.19	-11.42
19-Jan-2009	24:00:00	-12.62	-15.42	-36.60	-15.32	-12.56
20-Jan-2009	06:00:00	-13.11	-16.00	-37.29	-15.85	-13.26
20-Jan-2009	12:00:00	-12.49	-14.28	-36.92	-14.46	-11.77
20-Jan-2009	18:00:00	-10.28	-12.40	-34.80	-12.63	-9.39
20-Jan-2009	24:00:00	-9.26	-11.53	-33.61	-11.91	-8.88
21-Jan-2009	06:00:00	-7.42	-9.88	-31.59	-9.92	-7.01
21-Jan-2009	12:00:00	-6.76	-9.70	-30.68	-9.45	-7.41
21-Jan-2009	18:00:00	-4.82	-8.35	-29.60	-8.12	-6.20
21-Jan-2009	24:00:00	-5.60	-7.22	-29.53	-7.17	-4.45
22-Jan-2009	06:00:00	-5.73	-8.17	-28.99	-7.65	-4.70
22-Jan-2009	12:00:00	-6.34	-9.40	-29.14	-8.41	-6.32
22-Jan-2009	18:00:00	-4.74	-8.42	-28.93	-7.79	-5.85
22-Jan-2009	24:00:00	-5.98	-7.32	-29.32	-7.51	-4.74
23-Jan-2009	06:00:00	-5.84	-8.08	-28.94	-7.71	-4.59
23-Jan-2009	12:00:00	-6.52	-9.06	-29.06	-8.42	-5.69
23-Jan-2009	18:00:00	-6.04	-8.24	-29.11	-8.01	-5.12
23-Jan-2009	24:00:00	-7.58	-9.43	-30.22	-9.25	-6.20
24-Jan-2009	06:00:00	-7.50	-9.74	-30.24	-9.49	-6.41
24-Jan-2009	12:00:00	-7.87	-10.37	-30.58	-9.92	-6.98
24-Jan-2009	18:00:00	-6.96	-9.43	-29.78	-8.72	-6.08
24-Jan-2009	24:00:00	-6.61	-9.47	-29.76	-8.66	-6.20
25-Jan-2009	06:00:00	-5.17	-8.33	-28.77	-7.37	-5.17
25-Jan-2009	12:00:00	-4.63	-8.12	-28.23	-6.81	-4.73
25-Jan-2009	18:00:00	-4.28	-7.57	-27.54	-5.89	-3.96
25-Jan-2009	24:00:00	-5.04	-8.66	-28.35	-6.80	-4.85
26-Jan-2009	06:00:00	-4.62	-8.27	-28.11	-6.29	-4.31
26-Jan-2009	12:00:00	-4.59	-8.38	-28.11	-6.09	-4.15
26-Jan-2009	18:00:00	-3.82	-7.32	-27.07	-4.82	-3.11
26-Jan-2009	24:00:00	-4.22	-8.24	-27.92	-5.79	-3.83
27-Jan-2009	06:00:00	-4.03	-7.82	-27.54	-5.05	-3.18
27-Jan-2009	12:00:00	-4.45	-8.24	-28.04	-5.65	-3.59
27-Jan-2009	18:00:00	-4.60	-7.93	-27.73	-5.07	-3.30
27-Jan-2009	24:00:00	-5.83	-9.30	-28.95	-6.62	-4.51
28-Jan-2009	06:00:00	-6.87	-10.00	-29.82	-7.33	-5.15
28-Jan-2009	12:00:00	-8.25	-10.98	-31.23	-8.72	-6.08
28-Jan-2009	18:00:00	-10.40	-11.60	-33.04	-10.59	-7.65
28-Jan-2009	24:00:00	-8.50	-11.16	-33.70	-10.77	-8.01

Date	Time	Water Level (inches)				
		Jon AW15	Jon AW16	Jon AW17	Jon AW18	Jon AW19
29-Jan-2009	06:00:00	-8.79	-9.43	-31.84	-9.65	-6.67
29-Jan-2009	12:00:00	-8.41	-9.54	-30.87	-9.87	-6.50
29-Jan-2009	18:00:00	-8.28	-8.94	-29.67	-9.27	-5.77
29-Jan-2009	24:00:00	-8.61	-9.98	-29.97	-10.14	-6.86
30-Jan-2009	06:00:00	-8.34	-9.78	-29.50	-9.61	-6.77
30-Jan-2009	12:00:00	-8.55	-10.52	-29.78	-9.99	-7.58
30-Jan-2009	18:00:00	-8.46	-10.01	-29.46	-9.20	-6.95
30-Jan-2009	24:00:00	-8.78	-11.23	-30.31	-10.02	-8.06
31-Jan-2009	06:00:00	-7.59	-10.40	-29.54	-8.83	-7.14
31-Jan-2009	12:00:00	-7.39	-10.54	-29.41	-8.54	-6.98
31-Jan-2009	18:00:00	-6.34	-9.20	-28.69	-7.04	-5.06
31-Jan-2009	24:00:00	-6.70	-10.22	-29.22	-7.77	-5.82
1-Feb-2009	06:00:00	-6.80	-10.50	-29.32	-7.62	-5.99
1-Feb-2009	12:00:00	-6.90	-11.10	-29.53	-7.82	-6.19
1-Feb-2009	18:00:00	-6.91	-10.25	-29.42	-7.21	-5.31
1-Feb-2009	24:00:00	-8.31	-12.30	-30.88	-8.84	-6.84
2-Feb-2009	06:00:00	-8.41	-12.73	-31.16	-8.97	-7.13
2-Feb-2009	12:00:00	-9.19	-13.63	-31.88	-9.61	-7.91
2-Feb-2009	18:00:00	-10.09	-14.15	-32.68	-10.16	-8.11
2-Feb-2009	24:00:00	-11.65	-15.89	-34.28	-11.89	-9.68
3-Feb-2009	06:00:00	-8.52	-11.24	-34.75	-9.89	-8.10
3-Feb-2009	12:00:00	-9.34	-10.02	-32.90	-9.85	-7.09
3-Feb-2009	18:00:00	-9.32	-10.00	-31.29	-9.51	-6.17
3-Feb-2009	24:00:00	-10.72	-12.07	-32.23	-11.51	-8.06
4-Feb-2009	06:00:00	-10.63	-11.99	-31.62	-11.19	-7.91
4-Feb-2009	12:00:00	-8.65	-10.90	-30.46	-9.83	-6.93
4-Feb-2009	18:00:00	-5.49	-8.62	-28.30	-7.11	-4.55
4-Feb-2009	24:00:00	-5.48	-7.67	-27.61	-6.26	-3.41
5-Feb-2009	06:00:00	-4.06	-6.65	-25.98	-4.69	-2.40
5-Feb-2009	12:00:00	-3.67	-6.85	-25.12	-4.10	-2.41
5-Feb-2009	18:00:00	-1.44	-6.04	-24.28	-2.69	-0.71
5-Feb-2009	24:00:00	-2.89	-6.47	-24.86	-3.41	-1.10
6-Feb-2009	06:00:00	-3.69	-7.82	-24.94	-3.61	-1.77
6-Feb-2009	12:00:00	-4.65	-9.52	-25.45	-4.43	-2.99
6-Feb-2009	18:00:00	-2.79	-8.58	-25.96	-4.07	-2.31
6-Feb-2009	24:00:00	-4.47	-8.35	-27.08	-5.01	-2.51
7-Feb-2009	06:00:00	-4.40	-8.95	-26.98	-4.79	-2.79
7-Feb-2009	12:00:00	-4.71	-10.21	-27.09	-5.16	-3.33
7-Feb-2009	18:00:00	-3.82	-9.01	-26.74	-4.05	-2.16
7-Feb-2009	24:00:00	-5.86	-10.97	-28.23	-5.95	-3.80
8-Feb-2009	06:00:00	-5.72	-11.52	-28.50	-5.88	-3.93
8-Feb-2009	12:00:00	-6.37	-12.50	-29.04	-6.35	-4.51
8-Feb-2009	18:00:00	-6.63	-12.74	-29.17	-6.31	-4.22
8-Feb-2009	24:00:00	-7.29	-13.96	-30.06	-7.32	-5.18
9-Feb-2009	06:00:00	-6.80	-13.91	-29.86	-6.95	-4.89
9-Feb-2009	12:00:00	-6.26	-13.75	-29.32	-6.31	-4.50
9-Feb-2009	18:00:00	-5.61	-13.08	-28.47	-5.16	-3.44
9-Feb-2009	24:00:00	-6.58	-14.38	-29.36	-6.33	-4.37
10-Feb-2009	06:00:00	-6.55	-14.56	-29.44	-6.25	-4.28
10-Feb-2009	12:00:00	-6.87	-15.25	-29.98	-6.68	-4.56
10-Feb-2009	18:00:00	-7.05	-15.18	-29.89	-6.39	-4.32
10-Feb-2009	24:00:00	-8.41	-16.58	-31.09	-7.95	-5.69
11-Feb-2009	06:00:00	-8.61	-17.00	-31.47	-8.05	-5.89
11-Feb-2009	12:00:00	-9.06	-17.63	-31.89	-8.45	-6.25
11-Feb-2009	18:00:00	-9.67	-17.96	-32.19	-8.64	-6.45
11-Feb-2009	24:00:00	-12.73	-20.36	-34.66	-11.75	-9.08

Date	Time	Water Level (inches)				
		Jon AW15	Jon AW16	Jon AW17	Jon AW18	Jon AW19
12-Feb-2009	06:00:00	-12.98	-21.22	-35.77	-12.62	-9.97
12-Feb-2009	12:00:00	-12.28	-21.20	-35.31	-11.78	-9.55
12-Feb-2009	18:00:00	-11.50	-20.41	-34.23	-10.56	-8.58
12-Feb-2009	24:00:00	-11.68	-21.07	-34.41	-10.93	-8.82
13-Feb-2009	06:00:00	-10.95	-20.71	-33.72	-10.03	-8.09
13-Feb-2009	12:00:00	-10.94	-20.94	-33.51	-9.84	-7.97
13-Feb-2009	18:00:00	-11.16	-20.89	-33.36	-9.50	-7.56
13-Feb-2009	24:00:00	-12.48	-22.45	-34.58	-11.06	-8.93
14-Feb-2009	06:00:00	-12.63	-22.66	-34.74	-10.97	-8.76
14-Feb-2009	12:00:00	-13.38	-23.51	-35.54	-11.76	-9.36
14-Feb-2009	18:00:00	-13.03	-23.08	-35.68	-11.53	-9.08
14-Feb-2009	24:00:00	-14.12	-24.01	-36.80	-12.67	-10.05
15-Feb-2009	06:00:00	-13.63	-24.01	-36.42	-12.15	-9.92
15-Feb-2009	12:00:00	-12.30	-22.98	-35.13	-10.75	-8.83
15-Feb-2009	18:00:00	-11.96	-21.92	-33.86	-9.53	-7.61
15-Feb-2009	24:00:00	-13.14	-23.41	-34.94	-10.92	-8.75
16-Feb-2009	06:00:00	-13.09	-23.48	-34.94	-10.70	-8.71
16-Feb-2009	12:00:00	-7.96	-18.78	-34.32	-7.92	-5.09
16-Feb-2009	18:00:00	-8.31	-17.82	-33.00	-7.23	-4.11
16-Feb-2009	24:00:00	-9.25	-19.08	-33.19	-8.03	-5.25
17-Feb-2009	06:00:00	-8.35	-18.89	-32.07	-6.92	-4.56
17-Feb-2009	12:00:00	-8.68	-19.36	-31.50	-6.62	-4.44
17-Feb-2009	18:00:00	-9.12	-19.48	-31.41	-6.48	-3.93
17-Feb-2009	24:00:00	-11.23	-21.41	-32.84	-8.34	-5.75
18-Feb-2009	06:00:00	-11.88	-22.28	-33.46	-8.91	-6.39
18-Feb-2009	12:00:00	-13.02	-24.01	-35.05	-10.68	-7.74
18-Feb-2009	18:00:00	-8.94	-12.43	-33.31	-9.09	-6.78
18-Feb-2009	24:00:00	-12.81	-15.61	-36.91	-12.99	-9.77
19-Feb-2009	06:00:00	-12.14	-14.28	-36.84	-13.14	-10.70
19-Feb-2009	12:00:00	-13.48	-13.97	-30.51	-14.37	-11.30
19-Feb-2009	18:00:00	-12.66	-13.02	-28.30	-13.53	-10.14
19-Feb-2009	24:00:00	-12.15	-13.06	-27.57	-13.25	-9.80
20-Feb-2009	06:00:00	-9.51	-10.86	-25.82	-10.75	-7.50
20-Feb-2009	12:00:00	-8.30	-9.98	-24.98	-9.54	-6.97
20-Feb-2009	18:00:00	-7.41	-9.12	-24.25	-7.97	-5.67
20-Feb-2009	24:00:00	-7.93	-10.54	-25.02	-8.75	-6.72
21-Feb-2009	06:00:00	-7.09	-10.38	-24.51	-7.76	-6.00
21-Feb-2009	12:00:00	-6.21	-10.43	-24.01	-6.86	-5.31
21-Feb-2009	18:00:00	-5.65	-9.58	-23.97	-5.89	-3.84
21-Feb-2009	24:00:00	-7.75	-11.94	-25.68	-7.81	-5.72
22-Feb-2009	06:00:00	-8.07	-12.96	-26.53	-8.13	-6.21
22-Feb-2009	12:00:00	-9.55	-14.82	-28.22	-9.71	-7.23
22-Feb-2009	18:00:00	-9.25	-14.90	-28.47	-9.51	-7.35
22-Feb-2009	24:00:00	-8.04	-14.82	-27.82	-8.57	-6.83
23-Feb-2009	06:00:00	-5.96	-13.68	-25.89	-6.06	-4.55
23-Feb-2009	12:00:00	-6.06	-14.51	-26.05	-6.08	-4.49
23-Feb-2009	18:00:00	-5.77	-14.20	-25.42	-4.94	-3.20
23-Feb-2009	24:00:00	-7.11	-16.08	-26.98	-6.56	-4.85
24-Feb-2009	06:00:00	-6.58	-16.21	-26.71	-6.13	-4.64
24-Feb-2009	12:00:00	-6.73	-16.56	-26.52	-5.78	-4.62
24-Feb-2009	18:00:00	-5.53	-15.79	-26.25	-5.00	-3.25
24-Feb-2009	24:00:00	-7.15	-17.12	-27.40	-6.18	-4.38
25-Feb-2009	06:00:00	-7.11	-17.60	-27.33	-5.99	-4.55
25-Feb-2009	12:00:00	-7.27	-18.00	-27.46	-6.13	-4.75
25-Feb-2009	18:00:00	-7.06	-17.62	-27.19	-5.30	-3.83
25-Feb-2009	24:00:00	-8.23	-18.64	-28.39	-6.60	-4.86

Date	Time	Water Level (inches)				
		Jon AW15	Jon AW16	Jon AW17	Jon AW18	Jon AW19
26-Feb-2009	06:00:00	-8.31	-19.14	-28.68	-6.68	-5.10
26-Feb-2009	12:00:00	-8.47	-19.37	-28.86	-6.73	-5.03
26-Feb-2009	18:00:00	-8.53	-19.61	-29.12	-6.75	-5.04
26-Feb-2009	24:00:00	-8.52	-19.24	-28.76	-6.51	-4.55
27-Feb-2009	06:00:00	-8.40	-19.39	-28.93	-6.39	-4.46
27-Feb-2009	12:00:00	-8.08	-19.27	-28.83	-6.29	-4.09
27-Feb-2009	18:00:00	-8.49	-19.48	-29.18	-6.37	-4.19
27-Feb-2009	24:00:00	-6.36	-17.15	-28.69	-5.03	-2.12
28-Feb-2009	06:00:00	-6.52	-17.15	-28.92	-5.46	-2.84
28-Feb-2009	12:00:00	-3.62	-17.14	-28.99	-5.17	-2.40
28-Feb-2009	18:00:00	-1.09	-3.74	-23.53	-2.67	-0.60
28-Feb-2009	24:00:00	-1.38	-1.04	-10.96	-2.43	-0.19
1-Mar-2009	06:00:00	-1.64	-1.40	-0.06	-3.23	-0.42
1-Mar-2009	12:00:00	-1.28	-1.76	-2.38	-3.51	-0.68
1-Mar-2009	18:00:00	-1.26	-1.08	0.93	-2.72	-0.31
1-Mar-2009	24:00:00	-0.67	1.03	0.88	-3.23	-0.18
2-Mar-2009	06:00:00	-0.94	0.38	3.92	-3.20	-0.39
2-Mar-2009	12:00:00	-1.52	0.08	1.10	-3.37	-0.65
2-Mar-2009	18:00:00	-1.90	-0.55	0.38	-3.73	-0.97
2-Mar-2009	24:00:00	-2.20	-0.74	0.06	-4.28	-0.91
3-Mar-2009	06:00:00	-2.25	-0.97	-1.93	-4.59	-1.23
3-Mar-2009	12:00:00	-2.42	-1.30	-3.91	-4.89	-2.16
3-Mar-2009	18:00:00	-2.44	-1.76	-6.32	-4.76	-1.92
3-Mar-2009	24:00:00	-2.54	-1.97	-7.45	-4.98	-2.47
4-Mar-2009	06:00:00	-2.53	-2.24	-8.89	-4.99	-3.11
4-Mar-2009	12:00:00	-2.50	-2.82	-10.12	-5.31	-3.77
4-Mar-2009	18:00:00	-2.48	-2.84	-11.41	-5.09	-2.79
4-Mar-2009	24:00:00	-2.64	-3.00	-10.99	-5.16	-2.79
5-Mar-2009	06:00:00	-2.61	-3.19	-11.97	-5.11	-3.33
5-Mar-2009	12:00:00	-2.50	-3.54	-12.87	-5.35	-3.68
5-Mar-2009	18:00:00	-2.72	-3.56	-13.92	-5.29	-3.33
5-Mar-2009	24:00:00	-2.77	-4.04	-13.88	-5.33	-3.32
6-Mar-2009	06:00:00	-2.58	-4.12	-14.50	-5.19	-3.27
6-Mar-2009	12:00:00	-2.22	-4.40	-15.08	-5.25	-3.19
6-Mar-2009	18:00:00	-2.96	-4.58	-15.75	-5.31	-3.17
6-Mar-2009	24:00:00	-2.65	-4.78	-15.57	-5.45	-3.20
7-Mar-2009	06:00:00	-2.53	-4.79	-15.98	-5.16	-3.01
7-Mar-2009	12:00:00	-2.30	-5.08	-16.51	-5.17	-3.09
7-Mar-2009	18:00:00	-2.88	-5.44	-17.40	-5.49	-3.42
7-Mar-2009	24:00:00	-2.61	-5.32	-17.08	-5.47	-3.02
8-Mar-2009	06:00:00	-2.30	-5.48	-17.48	-5.31	-3.11
8-Mar-2009	12:00:00	-2.29	-5.64	-17.84	-5.29	-3.06
8-Mar-2009	18:00:00	-2.70	-5.77	-18.48	-5.39	-3.19
8-Mar-2009	24:00:00	-2.60	-5.89	-18.52	-5.58	-3.21
9-Mar-2009	06:00:00	-2.49	-5.93	-18.91	-5.45	-3.17
9-Mar-2009	12:00:00	-2.47	-5.95	-19.32	-5.36	-3.00
9-Mar-2009	18:00:00	-2.82	-6.29	-20.30	-5.67	-3.47
9-Mar-2009	24:00:00	-2.79	-6.50	-20.54	-5.99	-3.63
10-Mar-2009	06:00:00	-2.46	-6.55	-21.02	-5.75	-3.62
10-Mar-2009	12:00:00	-2.61	-6.88	-21.64	-5.99	-3.74
10-Mar-2009	18:00:00	-3.06	-7.12	-22.26	-6.14	-4.04
10-Mar-2009	24:00:00	-2.92	-7.12	-22.35	-6.25	-3.77
11-Mar-2009	06:00:00	-2.72	-6.90	-22.66	-5.90	-3.49
11-Mar-2009	12:00:00	-2.65	-6.59	-22.89	-5.71	-3.07
11-Mar-2009	18:00:00	-3.19	-6.83	-23.50	-6.06	-3.38
11-Mar-2009	24:00:00	-3.09	-7.06	-23.62	-6.21	-3.48

Date	Time	Water Level (inches)				
		Jon AW15	Jon AW16	Jon AW17	Jon AW18	Jon AW19
12-Mar-2009	06:00:00	-2.97	-7.09	-24.07	-6.12	-3.68
12-Mar-2009	12:00:00	-2.91	-7.70	-24.70	-6.35	-3.98
12-Mar-2009	18:00:00	-3.43	-8.32	-25.41	-6.84	-4.53
12-Mar-2009	24:00:00	-3.49	-8.33	-25.33	-6.87	-4.39
13-Mar-2009	06:00:00	-3.46	-8.36	-25.60	-6.78	-4.38
13-Mar-2009	12:00:00	-3.31	-8.50	-25.88	-6.96	-4.37
13-Mar-2009	18:00:00	-2.90	-8.65	-26.37	-7.02	-4.67
13-Mar-2009	24:00:00	-2.14	-5.68	-26.13	-4.98	-1.56
14-Mar-2009	06:00:00	-2.82	-5.99	-26.16	-5.22	-1.73
14-Mar-2009	12:00:00	-2.79	-6.37	-26.10	-5.41	-2.13
14-Mar-2009	18:00:00	-1.44	-4.46	-26.42	-4.13	-1.20
14-Mar-2009	24:00:00	-2.50	-3.92	-25.05	-3.84	-0.67
15-Mar-2009	06:00:00	-2.47	-3.89	-24.63	-3.91	-0.71
15-Mar-2009	12:00:00	-2.05	-3.65	-24.04	-3.95	-0.71
15-Mar-2009	18:00:00	-1.34	-1.50	-21.79	-2.60	-0.44
15-Mar-2009	24:00:00	-2.40	-2.58	-19.56	-3.54	-0.66
16-Mar-2009	06:00:00	-2.11	-1.93	-17.40	-3.02	-0.54
16-Mar-2009	12:00:00	-2.42	-2.57	-15.66	-3.87	-0.71
16-Mar-2009	18:00:00	-2.04	-2.50	-16.10	-3.98	-0.77
16-Mar-2009	24:00:00	-1.81	-2.09	-14.44	-3.27	-0.60
17-Mar-2009	06:00:00	-1.83	-1.66	-12.31	-2.87	-0.47
17-Mar-2009	12:00:00	-2.22	-2.03	-11.48	-3.81	-0.66
17-Mar-2009	18:00:00	-2.19	-2.41	-13.11	-4.22	-0.89
17-Mar-2009	24:00:00	-2.46	-2.78	-13.74	-4.52	-1.15
18-Mar-2009	06:00:00	-2.17	-2.84	-14.55	-4.45	-1.26
18-Mar-2009	12:00:00	-2.19	-3.18	-15.31	-4.61	-1.70
18-Mar-2009	18:00:00	-2.30	-3.44	-16.08	-4.74	-2.16
18-Mar-2009	24:00:00	-2.43	-3.62	-15.97	-4.80	-2.05
19-Mar-2009	06:00:00	-2.11	-3.65	-16.41	-4.63	-2.12
19-Mar-2009	12:00:00	-2.16	-4.06	-16.83	-4.61	-2.23
19-Mar-2009	18:00:00	-2.59	-4.43	-17.49	-4.93	-2.52
19-Mar-2009	24:00:00	-2.78	-4.68	-17.56	-4.86	-2.35
20-Mar-2009	06:00:00	-1.53	-1.31	-14.90	-2.36	-0.69
20-Mar-2009	12:00:00	-2.13	-2.88	-15.84	-3.61	-0.60
20-Mar-2009	18:00:00	-2.54	-3.49	-16.00	-4.41	-1.03
20-Mar-2009	24:00:00	-2.40	-3.86	-16.29	-4.81	-1.47
21-Mar-2009	06:00:00	-2.35	-4.08	-17.24	-4.70	-2.06
21-Mar-2009	12:00:00	-2.11	-4.54	-18.19	-4.80	-2.66
21-Mar-2009	18:00:00	-2.68	-5.11	-19.05	-5.12	-2.88
21-Mar-2009	24:00:00	-2.73	-5.46	-19.05	-5.13	-2.88
22-Mar-2009	06:00:00	-2.42	-5.62	-19.47	-5.04	-2.78
22-Mar-2009	12:00:00	-2.37	-5.89	-19.94	-5.07	-2.82
22-Mar-2009	18:00:00	-2.76	-6.18	-20.66	-5.30	-3.05
22-Mar-2009	24:00:00	-2.80	-6.25	-20.72	-5.39	-2.93
23-Mar-2009	06:00:00	-2.42	-6.14	-21.12	-5.24	-2.77
23-Mar-2009	12:00:00	-2.53	-6.38	-21.69	-5.33	-2.90
23-Mar-2009	18:00:00	-3.14	-6.56	-22.39	-5.51	-3.07
23-Mar-2009	24:00:00	-3.08	-6.66	-22.60	-5.70	-3.05
24-Mar-2009	06:00:00	-2.96	-6.68	-23.10	-5.71	-3.08
24-Mar-2009	12:00:00	-2.78	-7.02	-23.59	-5.76	-3.18
24-Mar-2009	18:00:00	-3.43	-7.48	-24.45	-6.12	-3.68
24-Mar-2009	24:00:00	-3.48	-7.38	-24.33	-6.13	-3.43
25-Mar-2009	06:00:00	-3.06	-7.42	-24.69	-6.00	-3.36
25-Mar-2009	12:00:00	-3.42	-7.37	-24.92	-5.91	-3.24
25-Mar-2009	18:00:00	-3.25	-7.70	-25.38	-6.19	-3.51
25-Mar-2009	24:00:00	-3.09	-7.37	-25.40	-5.95	-3.01

Date	Time	Water Level (inches)				
		Jon AW15	Jon AW16	Jon AW17	Jon AW18	Jon AW19
26-Mar-2009	06:00:00	-1.98	-4.36	-25.17	-4.05	-1.07
26-Mar-2009	12:00:00	-2.43	-4.52	-24.45	-4.32	-0.87
26-Mar-2009	18:00:00	-2.73	-4.91	-24.43	-4.56	-1.21
26-Mar-2009	24:00:00	-2.64	-4.90	-24.25	-4.53	-1.40
27-Mar-2009	06:00:00	-2.92	-5.15	-24.49	-4.69	-1.68
27-Mar-2009	12:00:00	-2.74	-5.44	-24.66	-4.71	-1.92
27-Mar-2009	18:00:00	-2.49	-5.63	-25.02	-4.83	-2.03
27-Mar-2009	24:00:00	-2.94	-4.97	-24.57	-4.46	-1.43
28-Mar-2009	06:00:00	-2.80	-4.97	-24.68	-4.56	-1.61
28-Mar-2009	12:00:00	-3.03	-5.27	-24.79	-4.58	-1.81
28-Mar-2009	18:00:00	-2.97	-5.52	-25.28	-4.75	-2.07
28-Mar-2009	24:00:00	-0.36	-2.06	-20.49	-3.23	-0.32
29-Mar-2009	06:00:00	-1.65	-0.92	-5.00	-3.32	-0.15
29-Mar-2009	12:00:00	-1.98	-1.63	-6.85	-3.91	-0.48
29-Mar-2009	18:00:00	-2.58	-2.08	-8.88	-4.51	-0.92
29-Mar-2009	24:00:00	-2.14	-2.24	-10.36	-4.73	-0.98
30-Mar-2009	06:00:00	-2.00	-2.42	-11.98	-4.67	-1.64
30-Mar-2009	12:00:00	-1.94	-2.81	-12.78	-4.79	-2.21
30-Mar-2009	18:00:00	-2.46	-3.31	-13.90	-5.17	-2.72
30-Mar-2009	24:00:00	-2.20	-3.56	-14.48	-5.28	-2.77
31-Mar-2009	06:00:00	-2.26	-3.68	-15.32	-5.01	-2.61
31-Mar-2009	12:00:00	-2.08	-4.16	-16.09	-5.03	-2.71
31-Mar-2009	18:00:00	-2.47	-4.58	-16.98	-5.31	-2.90
31-Mar-2009	24:00:00	-2.35	-4.80	-17.10	-5.45	-2.65
1-Apr-2009	06:00:00	-2.30	-4.80	-17.42	-5.15	-2.48
1-Apr-2009	12:00:00	-1.98	-4.82	-17.71	-4.97	-2.15
1-Apr-2009	18:00:00	-2.30	-4.74	-18.33	-4.94	-2.12
1-Apr-2009	24:00:00	-2.48	-4.84	-18.56	-5.05	-2.16
2-Apr-2009	06:00:00	-2.18	-4.94	-18.81	-4.94	-2.22
2-Apr-2009	12:00:00	-1.50	-4.80	-19.06	-4.79	-1.93
2-Apr-2009	18:00:00	-1.80	-3.41	-18.74	-3.77	-0.79
2-Apr-2009	24:00:00	-1.80	-2.14	-17.64	-3.00	-0.41
3-Apr-2009	06:00:00	-2.11	-2.59	-16.65	-3.81	-0.29
3-Apr-2009	12:00:00	-1.86	-1.58	-15.88	-2.71	-0.30
3-Apr-2009	18:00:00	-2.44	-2.72	-15.07	-4.19	-0.81
3-Apr-2009	24:00:00	-2.37	-3.19	-15.94	-4.83	-1.04
4-Apr-2009	06:00:00	-2.13	-3.35	-17.19	-4.62	-1.52
4-Apr-2009	12:00:00	-2.14	-3.68	-17.89	-4.71	-1.95
4-Apr-2009	18:00:00	-2.85	-4.39	-18.86	-5.12	-2.41
4-Apr-2009	24:00:00	-2.90	-5.00	-19.23	-5.31	-2.41
5-Apr-2009	06:00:00	-2.72	-5.12	-19.64	-4.92	-2.12
5-Apr-2009	12:00:00	-2.58	-5.59	-20.16	-4.99	-2.19
5-Apr-2009	18:00:00	-3.19	-6.01	-20.86	-5.39	-2.45
5-Apr-2009	24:00:00	-2.85	-6.36	-21.13	-5.55	-2.40
6-Apr-2009	06:00:00	-2.66	-6.05	-21.37	-5.10	-1.87
6-Apr-2009	12:00:00	-2.58	-5.57	-21.48	-4.85	-1.50
6-Apr-2009	18:00:00	-2.89	-3.24	-21.10	-3.63	-0.60
6-Apr-2009	24:00:00	-2.66	-4.58	-21.49	-4.61	-0.93
7-Apr-2009	06:00:00	-2.85	-5.12	-22.23	-4.73	-1.63
7-Apr-2009	12:00:00	-2.94	-5.60	-22.60	-4.77	-1.76
7-Apr-2009	18:00:00	-3.54	-6.46	-23.46	-5.27	-2.28
7-Apr-2009	24:00:00	-3.68	-7.13	-23.77	-5.39	-2.36
8-Apr-2009	06:00:00	-3.61	-7.51	-24.57	-5.45	-2.57
8-Apr-2009	12:00:00	-3.74	-7.78	-24.87	-5.36	-2.52
8-Apr-2009	18:00:00	-4.48	-8.30	-25.46	-5.76	-2.71
8-Apr-2009	24:00:00	-4.51	-8.69	-25.39	-5.94	-2.57

Date	Time	Water Level (inches)				
		Jon AW15	Jon AW16	Jon AW17	Jon AW18	Jon AW19
9-Apr-2009	06:00:00	-4.45	-8.95	-25.77	-5.72	-2.49
9-Apr-2009	12:00:00	-4.29	-9.34	-26.24	-5.77	-2.71
9-Apr-2009	18:00:00	-5.40	-10.21	-26.94	-6.35	-3.30
9-Apr-2009	24:00:00	-5.55	-11.09	-27.07	-6.68	-3.21
10-Apr-2009	06:00:00	-5.23	-11.44	-27.22	-6.31	-3.07
10-Apr-2009	12:00:00	-5.41	-11.80	-27.52	-6.41	-3.05
10-Apr-2009	18:00:00	-5.91	-12.79	-28.21	-7.05	-3.67
10-Apr-2009	24:00:00	-6.06	-12.78	-27.69	-6.62	-2.81
11-Apr-2009	06:00:00	-0.84	-0.77	-22.09	-2.22	-0.42
11-Apr-2009	12:00:00	-2.25	-1.66	-18.37	-3.37	-0.33
11-Apr-2009	18:00:00	-3.02	-2.34	-17.72	-4.31	-0.77
11-Apr-2009	24:00:00	-3.12	-2.87	-17.85	-4.67	-0.92
12-Apr-2009	06:00:00	-2.88	-3.10	-18.79	-4.67	-1.29
12-Apr-2009	12:00:00	-3.09	-3.58	-19.23	-4.69	-1.61
12-Apr-2009	18:00:00	-3.70	-4.33	-20.16	-5.21	-2.23
12-Apr-2009	24:00:00	-3.91	-5.00	-20.29	-5.43	-2.30
13-Apr-2009	06:00:00	-3.49	-5.45	-20.85	-5.16	-2.13
13-Apr-2009	12:00:00	-3.62	-5.99	-21.43	-5.09	-2.09
13-Apr-2009	18:00:00	-3.76	-6.32	-21.75	-5.15	-1.86
13-Apr-2009	24:00:00	-3.97	-6.37	-21.82	-4.94	-1.68
14-Apr-2009	06:00:00	-4.12	-6.35	-22.21	-4.93	-1.69
14-Apr-2009	12:00:00	-3.94	-6.08	-22.34	-4.76	-1.53
14-Apr-2009	18:00:00	-2.46	-3.44	-22.77	-3.55	-1.02
14-Apr-2009	24:00:00	-1.51	-2.14	-20.98	-3.05	-0.36
15-Apr-2009	06:00:00	-2.46	-2.70	-20.05	-3.73	-0.51
15-Apr-2009	12:00:00	-2.53	-3.14	-19.50	-4.09	-0.74
15-Apr-2009	18:00:00	-3.36	-3.79	-19.65	-4.61	-1.15
15-Apr-2009	24:00:00	-3.49	-4.30	-19.96	-4.80	-1.34
16-Apr-2009	06:00:00	-3.20	-4.72	-20.77	-4.75	-1.52
16-Apr-2009	12:00:00	-3.32	-5.32	-21.43	-4.75	-1.41
16-Apr-2009	18:00:00	-4.24	-6.26	-22.26	-5.29	-1.83
16-Apr-2009	24:00:00	-4.29	-7.40	-22.83	-5.60	-1.99
17-Apr-2009	06:00:00	-4.10	-7.90	-23.20	-5.17	-1.87
17-Apr-2009	12:00:00	-4.34	-8.50	-23.92	-5.34	-2.11
17-Apr-2009	18:00:00	-5.20	-9.40	-24.74	-6.00	-2.55
17-Apr-2009	24:00:00	-5.47	-10.58	-24.98	-6.30	-2.66
18-Apr-2009	06:00:00	-5.00	-10.84	-25.23	-5.79	-2.51
18-Apr-2009	12:00:00	-4.99	-11.20	-25.45	-5.70	-2.42
18-Apr-2009	18:00:00	-6.04	-12.19	-26.10	-6.47	-2.76
18-Apr-2009	24:00:00	-6.37	-13.63	-26.35	-6.84	-2.71
19-Apr-2009	06:00:00	-6.25	-14.17	-26.67	-6.33	-2.70
19-Apr-2009	12:00:00	-6.37	-14.60	-26.95	-6.31	-2.59
19-Apr-2009	18:00:00	-6.87	-15.26	-27.40	-6.71	-2.91
19-Apr-2009	24:00:00	-6.98	-15.79	-27.54	-6.75	-2.69
20-Apr-2009	06:00:00	-6.72	-15.73	-27.66	-6.33	-2.48
20-Apr-2009	12:00:00	-3.72	-15.52	-27.73	-6.09	-2.30
20-Apr-2009	18:00:00	-4.71	-8.92	-27.37	-4.83	-1.32
20-Apr-2009	24:00:00	-5.62	-11.63	-27.64	-5.69	-2.10
21-Apr-2009	06:00:00	-5.44	-13.31	-28.02	-5.49	-2.15
21-Apr-2009	12:00:00	-5.78	-14.44	-28.32	-5.73	-2.37
21-Apr-2009	18:00:00	-7.20	-15.76	-28.65	-6.31	-2.77
21-Apr-2009	24:00:00	-7.70	-17.28	-28.92	-6.84	-2.83
22-Apr-2009	06:00:00	-7.46	-17.81	-29.24	-6.69	-2.84
22-Apr-2009	12:00:00	-7.78	-18.38	-29.59	-6.77	-3.02
22-Apr-2009	18:00:00	-9.38	-19.40	-30.15	-7.74	-3.66
22-Apr-2009	24:00:00	-10.44	-20.75	-30.42	-8.67	-4.01

Date	Time	Water Level (inches)				
		Jon AW15	Jon AW16	Jon AW17	Jon AW18	Jon AW19
23-Apr-2009	06:00:00	-10.23	-20.94	-30.62	-8.57	-3.98
23-Apr-2009	12:00:00	-10.60	-21.41	-30.82	-8.75	-4.22
23-Apr-2009	18:00:00	-13.48	-22.06	-31.34	-9.68	-4.91
23-Apr-2009	24:00:00	-13.00	-23.09	-31.56	-11.18	-5.75
24-Apr-2009	06:00:00	-13.21	-22.96	-31.62	-10.98	-5.77
24-Apr-2009	12:00:00	-14.61	-23.21	-31.72	-11.00	-5.83
24-Apr-2009	18:00:00	-15.94	-23.94	-32.19	-12.07	-6.63
24-Apr-2009	24:00:00	-15.31	-24.34	-32.18	-13.86	-7.52
25-Apr-2009	06:00:00	-15.37	-24.35	-32.44	-13.61	-7.50
25-Apr-2009	12:00:00	-17.19	-24.40	-32.42	-13.34	-7.38
25-Apr-2009	18:00:00	-18.91	-25.01	-33.06	-14.78	-8.52
25-Apr-2009	24:00:00	-17.97	-25.72	-33.19	-17.01	-9.74
26-Apr-2009	06:00:00	-17.85	-25.64	-33.16	-16.61	-9.65
26-Apr-2009	12:00:00	-19.56	-25.72	-33.16	-16.40	-9.68
26-Apr-2009	18:00:00	-21.03	-26.29	-33.80	-17.73	-10.82
26-Apr-2009	24:00:00	-20.38	-26.84	-33.93	-19.52	-12.08
27-Apr-2009	06:00:00	-20.35	-26.95	-34.05	-19.50	-12.45
27-Apr-2009	12:00:00	-21.55	-27.04	-34.27	-19.46	-12.78
27-Apr-2009	18:00:00	-22.98	-27.58	-34.72	-20.33	-13.64
27-Apr-2009	24:00:00	-22.52	-28.15	-34.89	-22.03	-15.24
28-Apr-2009	06:00:00	-22.47	-28.20	-34.94	-22.16	-15.65
28-Apr-2009	12:00:00	-23.26	-28.44	-35.02	-22.02	-15.86
28-Apr-2009	18:00:00	-24.51	-28.87	-35.46	-22.64	-16.74
28-Apr-2009	24:00:00	-23.85	-29.22	-35.49	-23.65	-17.71
29-Apr-2009	06:00:00	-23.86	-29.20	-35.48	-23.81	-17.70
29-Apr-2009	12:00:00	-24.56	-29.57	-35.76	-23.75	-18.03
29-Apr-2009	18:00:00	-25.36	-30.06	-36.14	-24.15	-18.74
29-Apr-2009	24:00:00	-25.24	-30.22	-36.34	-24.97	-19.26
30-Apr-2009	06:00:00	-25.32	-30.31	-36.36	-25.28	-19.43
30-Apr-2009	12:00:00	-25.81	-30.58	-36.56	-25.35	-19.89
30-Apr-2009	18:00:00	-26.25	-31.13	-36.96	-25.79	-20.43
30-Apr-2009	24:00:00	-25.87	-31.10	-36.93	-25.91	-20.35
1-May-2009	06:00:00	-25.35	-31.14	-36.96	-26.15	-20.39
1-May-2009	12:00:00	-26.13	-31.34	-37.09	-25.77	-20.22
1-May-2009	18:00:00	-26.82	-31.81	-37.51	-26.19	-20.78
1-May-2009	24:00:00	-26.76	-31.73	-37.63	-26.55	-21.41
2-May-2009	06:00:00	-26.40	-31.61	-37.54	-26.59	-21.29
2-May-2009	12:00:00	-26.88	-31.90	-37.75	-26.58	-21.05
2-May-2009	18:00:00	-27.62	-32.42	-38.20	-27.15	-21.37
2-May-2009	24:00:00	-16.65	-32.38	-38.29	-27.41	-22.17
3-May-2009	06:00:00	-14.52	-32.12	-37.76	-24.18	-6.99
3-May-2009	12:00:00	-14.74	-30.28	-37.74	-20.87	-7.02
3-May-2009	18:00:00	-16.83	-29.33	-38.02	-19.79	-7.62
3-May-2009	24:00:00	-17.30	-29.08	-38.31	-19.89	-8.64
4-May-2009	06:00:00	-17.67	-29.17	-38.20	-20.24	-9.27
4-May-2009	12:00:00	-19.04	-29.42	-38.28	-20.29	-9.48
4-May-2009	18:00:00	-20.22	-30.02	-38.70	-21.36	-11.01
4-May-2009	24:00:00	-19.70	-30.35	-38.89	-22.29	-11.95
5-May-2009	06:00:00	-18.39	-30.58	-38.77	-22.52	-11.72
5-May-2009	12:00:00	-4.94	-30.90	-38.74	-22.32	-11.66
5-May-2009	18:00:00	-4.93	-22.79	-35.44	-5.66	-1.58
5-May-2009	24:00:00	-5.04	-18.68	-35.11	-7.07	-1.95
6-May-2009	06:00:00	-5.07	-19.48	-35.32	-7.29	-2.34
6-May-2009	12:00:00	-5.72	-19.99	-35.29	-7.39	-2.40
6-May-2009	18:00:00	-6.37	-20.96	-35.58	-8.33	-2.85
6-May-2009	24:00:00	-6.37	-21.49	-35.50	-9.73	-2.93

Date	Time	Water Level (inches)				
		Jon AW15	Jon AW16	Jon AW17	Jon AW18	Jon AW19
7-May-2009	06:00:00	-6.32	-22.02	-35.64	-9.45	-2.84
7-May-2009	12:00:00	-7.84	-22.19	-35.58	-9.03	-2.71
7-May-2009	18:00:00	-9.63	-22.97	-36.02	-10.71	-3.23
7-May-2009	24:00:00	-9.60	-24.13	-36.31	-13.28	-3.90
8-May-2009	06:00:00	-9.85	-24.44	-36.48	-12.55	-4.01
8-May-2009	12:00:00	-11.10	-24.80	-36.51	-12.24	-4.16
8-May-2009	18:00:00	-12.55	-25.54	-36.94	-13.69	-4.76
8-May-2009	24:00:00	-12.55	-26.18	-37.29	-15.32	-5.36
9-May-2009	06:00:00	-12.68	-26.32	-37.03	-14.37	-5.37
9-May-2009	12:00:00	-15.00	-26.60	-37.08	-13.92	-5.55
9-May-2009	18:00:00	-18.15	-27.35	-37.71	-16.27	-6.68
9-May-2009	24:00:00	-18.09	-28.09	-38.18	-19.23	-9.33
10-May-2009	06:00:00	-18.48	-28.58	-38.25	-19.04	-9.30
10-May-2009	12:00:00	-19.93	-29.04	-38.46	-18.77	-9.66
10-May-2009	18:00:00	-21.93	-29.84	-39.01	-20.17	-11.05
10-May-2009	24:00:00	-21.99	-30.31	-39.22	-22.05	-13.80
11-May-2009	06:00:00	-22.35	-30.54	-38.97	-22.05	-13.87
11-May-2009	12:00:00	-8.04	-30.92	-39.04	-21.68	-13.80
11-May-2009	18:00:00	-7.87	-27.16	-36.74	-8.61	-2.01
11-May-2009	24:00:00	-7.88	-24.04	-36.79	-9.69	-2.58
12-May-2009	06:00:00	-8.05	-24.48	-36.73	-10.08	-2.82
12-May-2009	12:00:00	-9.51	-25.06	-36.66	-10.41	-3.18
12-May-2009	18:00:00	-12.24	-26.02	-37.20	-11.90	-3.98
12-May-2009	24:00:00	-12.03	-26.86	-37.34	-15.32	-5.04
13-May-2009	06:00:00	-12.67	-27.53	-37.50	-14.94	-5.40
13-May-2009	12:00:00	-14.64	-28.19	-37.62	-15.01	-5.88
13-May-2009	18:00:00	-16.17	-28.84	-38.07	-16.44	-6.87
13-May-2009	24:00:00	-16.09	-29.23	-38.24	-18.59	-7.93
14-May-2009	06:00:00	-16.40	-29.63	-38.29	-18.36	-8.24
14-May-2009	12:00:00	-11.88	-30.11	-38.25	-17.73	-8.16
14-May-2009	18:00:00	-15.20	-30.70	-38.65	-15.11	-4.95
14-May-2009	24:00:00	-15.61	-30.26	-38.62	-17.25	-6.55
15-May-2009	06:00:00	-15.82	-30.58	-38.66	-17.36	-7.10
15-May-2009	12:00:00	-17.68	-30.96	-38.73	-16.95	-7.17
15-May-2009	18:00:00	-19.71	-31.62	-39.15	-18.13	-8.16
15-May-2009	24:00:00	-19.82	-31.50	-39.16	-20.45	-9.89
16-May-2009	06:00:00	-19.68	-31.74	-39.19	-20.58	-10.32
16-May-2009	12:00:00	-20.91	-32.21	-39.25	-20.25	-10.40
16-May-2009	18:00:00	-20.76	-32.78	-39.62	-21.12	-11.31
16-May-2009	24:00:00	-19.36	-32.96	-39.55	-22.37	-10.41
17-May-2009	06:00:00	-19.48	-32.94	-39.49	-20.90	-9.96
17-May-2009	12:00:00	-20.46	-33.23	-39.10	-20.22	-9.79
17-May-2009	18:00:00	-21.62	-33.70	-39.36	-20.54	-10.51
17-May-2009	24:00:00	-7.04	-33.67	-39.57	-21.98	-12.06
18-May-2009	06:00:00	-5.55	-33.97	-39.52	-13.70	-1.79
18-May-2009	12:00:00	-7.60	-33.80	-38.65	-7.58	-1.28
18-May-2009	18:00:00	-10.71	-33.43	-38.72	-9.27	-2.41
18-May-2009	24:00:00	-11.88	-32.87	-39.01	-12.90	-3.74
19-May-2009	06:00:00	-12.86	-32.42	-39.12	-13.23	-4.10
19-May-2009	12:00:00	-14.71	-32.53	-39.08	-13.62	-4.45
19-May-2009	18:00:00	-17.80	-32.70	-39.40	-14.96	-5.19
19-May-2009	24:00:00	-18.51	-33.04	-39.70	-18.00	-7.11
20-May-2009	06:00:00	-18.87	-33.29	-39.90	-18.29	-7.71
20-May-2009	12:00:00	-20.40	-33.74	-39.79	-18.18	-8.01
20-May-2009	18:00:00	-22.45	-34.22	-40.11	-19.50	-9.08
20-May-2009	24:00:00	-22.51	-34.56	-40.22	-21.79	-11.49

Date	Time	Water Level (inches)				
		Jon AW15	Jon AW16	Jon AW17	Jon AW18	Jon AW19
21-May-2009	06:00:00	-22.30	-34.80	-40.15	-22.23	-11.72
21-May-2009	12:00:00	-23.36	-34.98	-40.09	-21.71	-11.69
21-May-2009	18:00:00	-25.14	-35.54	-40.54	-22.58	-12.90
21-May-2009	24:00:00	-25.42	-35.82	-40.71	-24.37	-15.93
22-May-2009	06:00:00	-25.36	-35.68	-40.51	-24.83	-16.17
22-May-2009	12:00:00	-26.29	-35.95	-40.58	-24.84	-16.31
22-May-2009	18:00:00	-27.00	-36.54	-41.06	-25.47	-17.27
22-May-2009	24:00:00	-27.36	-36.68	-41.08	-26.29	-18.97
23-May-2009	06:00:00	-27.61	-36.78	-41.11	-26.65	-19.20
23-May-2009	12:00:00	-28.08	-37.02	-41.07	-26.59	-19.29
23-May-2009	18:00:00	-28.60	-37.74	-41.44	-27.24	-19.92
23-May-2009	24:00:00	-28.75	-38.68	-41.41	-27.49	-20.47
24-May-2009	06:00:00	-28.70	-39.12	-41.50	-27.72	-20.59
24-May-2009	12:00:00	-22.16	-39.42	-41.54	-27.73	-20.52
24-May-2009	18:00:00	-15.33	-39.86	-40.28	-21.93	-3.83
24-May-2009	24:00:00	-11.08	-39.54	-40.54	-17.55	-2.45
25-May-2009	06:00:00	-11.40	-39.66	-40.48	-14.97	-2.54
25-May-2009	12:00:00	-12.04	-39.25	-39.96	-14.33	-2.88
25-May-2009	18:00:00	-6.42	-39.34	-40.10	-14.75	-3.45
25-May-2009	24:00:00	-5.67	-38.52	-34.96	-3.96	-0.73
26-May-2009	06:00:00	-5.49	-37.80	-37.48	-5.46	-0.86
26-May-2009	12:00:00	-3.39	-37.15	-37.35	-5.41	-1.27
26-May-2009	18:00:00	-3.09	-35.77	-33.27	-3.13	-0.57
26-May-2009	24:00:00	-2.50	-21.94	-34.72	-4.75	-0.56
27-May-2009	06:00:00	-2.73	-0.83	0.45	-3.36	-0.20
27-May-2009	12:00:00	-3.40	-1.69	-1.33	-4.11	-0.49
27-May-2009	18:00:00	-3.72	-2.39	-3.70	-4.86	-1.11
27-May-2009	24:00:00	-3.42	-3.07	-9.18	-5.53	-2.00
28-May-2009	06:00:00	-4.29	-3.24	-10.59	-4.95	-2.01
28-May-2009	12:00:00	-3.38	-3.78	-11.85	-5.06	-2.21
28-May-2009	18:00:00	-2.02	-5.00	-13.54	-6.18	-2.72
28-May-2009	24:00:00	-2.17	-5.04	-14.64	-6.00	-2.29
29-May-2009	06:00:00	-3.04	-0.55	0.70	-3.27	-0.15
29-May-2009	12:00:00	-3.36	-1.36	0.18	-4.13	-0.43
29-May-2009	18:00:00	-2.61	-2.15	-2.59	-5.13	-1.20
29-May-2009	24:00:00	-2.70	-2.81	-8.31	-6.47	-2.48
30-May-2009	06:00:00	-3.79	-2.76	-10.14	-5.11	-2.31
30-May-2009	12:00:00	-4.22	-3.19	-11.26	-5.10	-2.35
30-May-2009	18:00:00	-3.46	-4.51	-13.68	-6.80	-3.27
30-May-2009	24:00:00	-3.32	-6.41	-16.46	-9.03	-4.75
31-May-2009	06:00:00	-4.51	-6.46	-16.81	-7.56	-4.86
31-May-2009	12:00:00	-5.52	-7.10	-17.38	-7.15	-4.75
31-May-2009	18:00:00	-5.25	-8.98	-18.88	-9.15	-5.67
31-May-2009	24:00:00	-5.67	-11.76	-20.74	-12.44	-7.80
1-Jun-2009	06:00:00	-7.05	-11.38	-21.16	-11.03	-8.15
1-Jun-2009	12:00:00	-9.63	-11.63	-21.82	-10.76	-8.51
1-Jun-2009	18:00:00	-9.18	-12.89	-23.07	-12.69	-9.44
1-Jun-2009	24:00:00	-9.45	-15.54	-24.81	-16.39	-12.68
2-Jun-2009	06:00:00	-11.31	-15.34	-25.21	-15.49	-13.34
2-Jun-2009	12:00:00	-14.17	-15.66	-25.53	-14.87	-13.39
2-Jun-2009	18:00:00	-14.00	-17.22	-26.68	-16.93	-14.59
2-Jun-2009	24:00:00	-14.23	-19.52	-27.72	-19.76	-17.65
3-Jun-2009	06:00:00	-15.94	-19.90	-28.17	-19.53	-18.54
3-Jun-2009	12:00:00	-18.73	-20.18	-28.53	-18.86	-18.44
3-Jun-2009	18:00:00	-19.11	-21.22	-29.38	-19.99	-19.25
3-Jun-2009	24:00:00	-19.20	-23.17	-30.44	-22.46	-20.96

Date	Time	Water Level (inches)				
		Jon AW15	Jon AW16	Jon AW17	Jon AW18	Jon AW19
4-Jun-2009	06:00:00	-19.66	-23.48	-30.80	-22.88	-21.51
4-Jun-2009	12:00:00	-9.37	-23.69	-31.10	-22.53	-21.61
4-Jun-2009	18:00:00	-3.72	-24.10	-31.62	-22.59	-21.72
4-Jun-2009	24:00:00	-4.05	-19.85	-31.38	-20.70	-17.95
5-Jun-2009	06:00:00	-4.69	-13.62	-28.15	-12.20	-6.32
5-Jun-2009	12:00:00	-6.57	-11.30	-29.43	-8.60	-3.59
5-Jun-2009	18:00:00	-6.99	-13.22	-29.79	-9.90	-4.45
5-Jun-2009	24:00:00	-7.24	-16.12	-30.70	-12.83	-6.08
6-Jun-2009	06:00:00	-8.65	-17.22	-31.26	-13.16	-7.04
6-Jun-2009	12:00:00	-10.66	-17.56	-31.33	-12.79	-6.95
6-Jun-2009	18:00:00	-11.22	-18.85	-32.08	-14.19	-7.99
6-Jun-2009	24:00:00	-11.68	-20.69	-32.58	-17.03	-10.51
7-Jun-2009	06:00:00	-12.75	-21.28	-32.84	-17.21	-11.45
7-Jun-2009	12:00:00	-14.97	-21.71	-32.96	-16.92	-11.73
7-Jun-2009	18:00:00	-15.32	-22.38	-33.48	-17.60	-12.45
7-Jun-2009	24:00:00	-15.38	-23.70	-33.86	-20.12	-15.36
8-Jun-2009	06:00:00	-16.35	-23.87	-33.85	-20.29	-16.21
8-Jun-2009	12:00:00	-18.94	-24.18	-34.15	-19.92	-16.21
8-Jun-2009	18:00:00	-19.12	-24.53	-34.44	-20.23	-16.63
8-Jun-2009	24:00:00	-19.28	-25.84	-35.07	-22.86	-19.35
9-Jun-2009	06:00:00	-20.56	-25.96	-35.05	-23.35	-20.06
9-Jun-2009	12:00:00	-22.34	-26.18	-35.19	-23.10	-20.05
9-Jun-2009	18:00:00	-19.70	-26.82	-35.84	-23.95	-20.82
9-Jun-2009	24:00:00	-20.11	-27.74	-36.30	-25.57	-22.28
10-Jun-2009	06:00:00	-21.44	-27.32	-36.16	-25.55	-21.44
10-Jun-2009	12:00:00	-23.91	-27.56	-36.24	-25.02	-21.23
10-Jun-2009	18:00:00	-22.83	-28.42	-36.86	-25.44	-21.66
10-Jun-2009	24:00:00	-20.00	-29.02	-37.36	-26.71	-23.24
11-Jun-2009	06:00:00	-19.96	-29.30	-37.22	-27.07	-23.28
11-Jun-2009	12:00:00	-22.15	-28.07	-37.23	-25.94	-20.93
11-Jun-2009	18:00:00	-21.25	-28.45	-37.63	-25.21	-20.66
11-Jun-2009	24:00:00	-21.46	-29.23	-37.87	-26.16	-21.36
12-Jun-2009	06:00:00	-22.57	-29.50	-37.90	-26.28	-21.47
12-Jun-2009	12:00:00	-24.50	-29.65	-37.75	-25.65	-21.38
12-Jun-2009	18:00:00	-25.44	-30.35	-38.42	-26.35	-21.92
12-Jun-2009	24:00:00	-25.82	-30.62	-38.76	-27.77	-23.31
13-Jun-2009	06:00:00	-26.68	-31.20	-38.85	-28.09	-24.05
13-Jun-2009	12:00:00	-27.96	-31.56	-38.88	-28.14	-24.42
13-Jun-2009	18:00:00	-28.48	-32.40	-39.54	-28.95	-25.11
13-Jun-2009	24:00:00	-28.70	-32.62	-40.11	-29.85	-25.40
14-Jun-2009	06:00:00	-29.31	-32.84	-40.04	-29.76	-25.58
14-Jun-2009	12:00:00	-29.90	-33.30	-40.05	-29.66	-25.76
14-Jun-2009	18:00:00	-30.27	-34.10	-40.68	-30.42	-26.31
14-Jun-2009	24:00:00	-30.38	-34.42	-41.20	-31.22	-26.65
15-Jun-2009	06:00:00	-30.81	-34.61	-41.18	-31.07	-26.72
15-Jun-2009	12:00:00	-31.18	-34.87	-41.19	-30.84	-26.99
15-Jun-2009	18:00:00	-31.35	-35.41	-41.61	-31.39	-27.33
15-Jun-2009	24:00:00	-31.38	-35.59	-41.83	-31.75	-27.36
16-Jun-2009	06:00:00	-31.66	-35.93	-41.94	-31.73	-27.51
16-Jun-2009	12:00:00	-31.80	-36.25	-42.01	-31.45	-27.80
16-Jun-2009	18:00:00	-31.75	-36.96	-42.39	-32.06	-28.22
16-Jun-2009	24:00:00	-31.86	-37.31	-42.37	-32.63	-28.47
17-Jun-2009	06:00:00	-31.18	-37.45	-42.16	-32.55	-28.51
17-Jun-2009	12:00:00	-31.00	-38.52	-42.18	-32.21	-28.59
17-Jun-2009	18:00:00	-30.48	-39.24	-42.31	-32.61	-28.86
17-Jun-2009	24:00:00	-29.58	-39.35	-42.38	-32.78	-28.68

Date	Time	Water Level (inches)				
		Jon AW15	Jon AW16	Jon AW17	Jon AW18	Jon AW19
18-Jun-2009	06:00:00	-29.36	-39.49	-42.18	-32.33	-28.58
18-Jun-2009	12:00:00	-29.00	-39.56	-42.20	-31.63	-28.40
18-Jun-2009	18:00:00	-28.75	-40.09	-42.49	-31.99	-28.64
18-Jun-2009	24:00:00	-28.80	-40.10	-42.36	-32.85	-28.61
19-Jun-2009	06:00:00	-29.70	-40.02	-42.06	-32.17	-28.37
19-Jun-2009	12:00:00	-30.64	-40.21	-42.08	-31.77	-28.58
19-Jun-2009	18:00:00	-31.21	-40.92	-42.51	-32.83	-29.15
19-Jun-2009	24:00:00	-31.69	-41.04	-42.36	-33.47	-29.31
20-Jun-2009	06:00:00	-32.47	-41.08	-42.09	-33.21	-29.18
20-Jun-2009	12:00:00	-32.84	-41.17	-42.01	-32.65	-29.35
20-Jun-2009	18:00:00	-32.77	-41.76	-42.27	-33.44	-29.78
20-Jun-2009	24:00:00	-32.95	-41.82	-42.32	-34.23	-29.84
21-Jun-2009	06:00:00	-33.55	-41.88	-42.03	-33.93	-29.78
21-Jun-2009	12:00:00	-33.75	-42.07	-42.02	-33.54	-30.02
21-Jun-2009	18:00:00	-33.90	-42.47	-42.34	-34.34	-30.47
21-Jun-2009	24:00:00	-33.97	-42.78	-42.25	-35.22	-30.65
22-Jun-2009	06:00:00	-34.89	-42.86	-42.07	-35.18	-30.77
22-Jun-2009	12:00:00	-34.90	-43.10	-42.08	-34.70	-31.05
22-Jun-2009	18:00:00	-34.78	-43.63	-42.24	-35.31	-31.59
22-Jun-2009	24:00:00	-34.59	-38.88	-42.22	-36.42	-31.81
23-Jun-2009	06:00:00	-35.00	-38.57	-41.92	-36.26	-31.88
23-Jun-2009	12:00:00	-34.98	-38.35	-41.83	-35.76	-32.13
23-Jun-2009	18:00:00	-34.62	-38.80	-42.28	-36.74	-32.81
23-Jun-2009	24:00:00	-34.64	-38.76	-42.20	-37.55	-33.07
24-Jun-2009	06:00:00	-34.83	-38.48	-41.88	-37.55	-33.13
24-Jun-2009	12:00:00	-35.00	-38.44	-41.74	-37.13	-33.31
24-Jun-2009	18:00:00	-34.68	-38.74	-42.16	-37.79	-33.85
24-Jun-2009	24:00:00	-34.44	-38.70	-42.08	-38.60	-34.13
25-Jun-2009	06:00:00	-34.83	-38.47	-41.83	-38.55	-34.10
25-Jun-2009	12:00:00	-35.04	-38.45	-41.82	-38.22	-34.32
25-Jun-2009	18:00:00	-34.47	-38.71	-42.07	-38.85	-34.89
25-Jun-2009	24:00:00	-34.60	-38.72	-42.07	-39.77	-35.10
26-Jun-2009	06:00:00	-34.92	-38.47	-41.86	-39.62	-35.12
26-Jun-2009	12:00:00	-34.92	-38.45	-41.84	-39.09	-35.31
26-Jun-2009	18:00:00	-34.86	-38.81	-42.14	-39.85	-35.90
26-Jun-2009	24:00:00	-34.56	-38.75	-42.10	-40.76	-36.05
27-Jun-2009	06:00:00	-35.02	-38.52	-41.92	-40.76	-36.08
27-Jun-2009	12:00:00	-34.72	-38.53	-41.95	-40.32	-36.23
27-Jun-2009	18:00:00	-34.68	-38.89	-42.22	-41.04	-36.79
27-Jun-2009	24:00:00	-34.69	-38.65	-42.13	-41.51	-36.93
28-Jun-2009	06:00:00	-34.94	-38.50	-41.79	-41.27	-37.03
28-Jun-2009	12:00:00	-34.84	-38.51	-41.89	-41.36	-37.29
28-Jun-2009	18:00:00	-34.77	-38.84	-42.21	-41.69	-37.87
28-Jun-2009	24:00:00	-34.52	-38.70	-42.04	-41.48	-37.94
29-Jun-2009	06:00:00	-34.90	-38.47	-41.78	-41.27	-37.95
29-Jun-2009	12:00:00	-34.68	-38.52	-41.95	-41.36	-38.17
29-Jun-2009	18:00:00	-34.50	-38.69	-42.08	-41.51	-38.57
29-Jun-2009	24:00:00	-34.57	-38.68	-42.03	-41.41	-38.82
30-Jun-2009	06:00:00	-34.86	-38.41	-41.71	-41.17	-38.89
30-Jun-2009	12:00:00	-34.87	-38.53	-41.86	-41.37	-39.20
30-Jun-2009	18:00:00	-34.64	-38.87	-42.21	-41.67	-39.68
30-Jun-2009	24:00:00	-34.70	-38.71	-42.15	-41.51	-39.90
1-Jul-2009	06:00:00	-34.95	-38.44	-41.78	-41.31	-39.96
1-Jul-2009	12:00:00	-34.76	-38.41	-41.80	-41.29	-40.26
1-Jul-2009	18:00:00	-34.47	-38.77	-42.04	-41.60	-40.89
1-Jul-2009	24:00:00	-34.53	-38.76	-41.95	-41.51	-41.05

Date	Time	Water Level (inches)				
		Jon AW15	Jon AW16	Jon AW17	Jon AW18	Jon AW19
2-Jul-2009	06:00:00	-34.84	-38.58	-41.86	-41.41	-41.30
2-Jul-2009	12:00:00	-34.88	-38.50	-41.83	-41.27	-41.55
2-Jul-2009	18:00:00	-34.57	-38.81	-42.07	-41.60	-42.08
2-Jul-2009	24:00:00	-34.36	-38.69	-41.91	-41.49	-41.83
3-Jul-2009	06:00:00	-34.92	-38.45	-41.72	-41.24	-41.59
3-Jul-2009	12:00:00	-34.86	-38.41	-41.66	-41.24	-41.49
3-Jul-2009	18:00:00	-34.40	-38.74	-42.03	-41.49	-41.87
3-Jul-2009	24:00:00	-34.60	-38.82	-42.07	-41.59	-41.85
4-Jul-2009	06:00:00	-34.84	-38.33	-41.67	-41.25	-41.46
4-Jul-2009	12:00:00	-34.82	-38.40	-41.79	-41.31	-41.55
4-Jul-2009	18:00:00	-34.70	-38.86	-42.13	-41.72	-41.81
4-Jul-2009	24:00:00	-34.51	-38.75	-42.10	-41.64	-41.82
5-Jul-2009	06:00:00	-34.89	-38.44	-41.65	-41.33	-41.55
5-Jul-2009	12:00:00	-34.70	-38.47	-41.83	-41.30	-41.57
5-Jul-2009	18:00:00	-34.39	-38.84	-41.97	-41.64	-41.87
5-Jul-2009	24:00:00	-34.53	-38.71	-41.90	-41.55	-41.70
6-Jul-2009	06:00:00	-34.88	-38.51	-41.71	-41.40	-41.54
6-Jul-2009	12:00:00	-34.77	-38.54	-41.74	-41.41	-41.55
6-Jul-2009	18:00:00	-34.64	-38.76	-41.91	-41.64	-41.75
6-Jul-2009	24:00:00	-34.50	-38.60	-41.78	-41.51	-41.65
7-Jul-2009	06:00:00	-34.78	-38.53	-41.72	-41.39	-41.43
7-Jul-2009	12:00:00	-34.90	-38.47	-41.66	-41.34	-41.47
7-Jul-2009	18:00:00	-34.48	-38.78	-42.00	-41.64	-41.76
7-Jul-2009	24:00:00	-34.53	-38.82	-42.01	-41.60	-41.78
8-Jul-2009	06:00:00	-34.95	-38.60	-41.65	-41.29	-41.46
8-Jul-2009	12:00:00	-34.32	-38.70	-41.60	-41.35	-41.40
8-Jul-2009	18:00:00	-34.36	-38.86	-42.00	-41.65	-41.82
8-Jul-2009	24:00:00	-34.60	-38.58	-41.65	-41.35	-41.47
9-Jul-2009	06:00:00	-34.45	-38.60	-41.73	-41.35	-41.39
9-Jul-2009	12:00:00	-34.46	-38.68	-41.80	-41.41	-41.47
9-Jul-2009	18:00:00	-34.51	-38.78	-41.78	-41.49	-41.61
9-Jul-2009	24:00:00	-34.39	-38.75	-41.85	-41.49	-41.58
10-Jul-2009	06:00:00	-34.70	-38.69	-41.74	-41.37	-41.52
10-Jul-2009	12:00:00	-34.84	-38.63	-41.72	-41.30	-41.48
10-Jul-2009	18:00:00	-34.52	-38.95	-41.98	-41.65	-41.75
10-Jul-2009	24:00:00	-34.30	-38.86	-41.88	-41.60	-41.71
11-Jul-2009	06:00:00	-34.51	-38.72	-41.74	-41.43	-41.52
11-Jul-2009	12:00:00	-34.60	-38.80	-41.78	-41.43	-41.60
11-Jul-2009	18:00:00	-34.82	-38.92	-42.09	-41.63	-41.73
11-Jul-2009	24:00:00	-34.35	-38.83	-41.94	-41.55	-41.64
12-Jul-2009	06:00:00	-34.75	-38.60	-41.71	-41.25	-41.36
12-Jul-2009	12:00:00	-34.81	-38.56	-41.66	-41.27	-41.34
12-Jul-2009	18:00:00	-34.47	-38.92	-41.97	-41.58	-41.71
12-Jul-2009	24:00:00	-34.58	-38.88	-41.95	-41.53	-41.64
13-Jul-2009	06:00:00	-34.42	-38.72	-41.67	-41.33	-41.52
13-Jul-2009	12:00:00	-34.75	-38.77	-41.84	-41.31	-41.59
13-Jul-2009	18:00:00	-34.53	-38.78	-41.85	-41.47	-41.55
13-Jul-2009	24:00:00	-34.56	-39.01	-42.02	-41.64	-41.81
14-Jul-2009	06:00:00	-34.86	-38.69	-41.67	-41.33	-41.47
14-Jul-2009	12:00:00	-34.75	-38.72	-41.70	-41.36	-41.47
14-Jul-2009	18:00:00	-34.30	-39.01	-42.04	-41.75	-41.81
14-Jul-2009	24:00:00	-34.39	-38.90	-42.02	-41.60	-41.78
15-Jul-2009	06:00:00	-34.75	-38.60	-41.59	-41.29	-41.41
15-Jul-2009	12:00:00	-34.42	-38.66	-41.59	-41.24	-41.35
15-Jul-2009	18:00:00	-34.27	-38.98	-42.02	-41.65	-41.81
15-Jul-2009	24:00:00	-34.41	-38.75	-41.80	-41.42	-41.47

Date	Time	Water Level (inches)				
		Jon AW15	Jon AW16	Jon AW17	Jon AW18	Jon AW19
16-Jul-2009	06:00:00	-34.94	-38.59	-41.65	-41.30	-41.39
16-Jul-2009	12:00:00	-34.62	-38.63	-41.67	-41.39	-41.49
16-Jul-2009	18:00:00	-34.54	-38.93	-42.00	-41.61	-41.73
16-Jul-2009	24:00:00	-34.46	-38.88	-41.85	-41.53	-41.58
17-Jul-2009	06:00:00	-34.65	-38.72	-41.71	-41.30	-41.45
17-Jul-2009	12:00:00	-34.90	-38.65	-41.70	-41.28	-41.41
17-Jul-2009	18:00:00	-34.56	-38.92	-41.91	-41.51	-41.77
17-Jul-2009	24:00:00	-34.44	-38.99	-41.88	-41.55	-41.77
18-Jul-2009	06:00:00	-34.71	-38.60	-41.56	-41.21	-41.34
18-Jul-2009	12:00:00	-34.72	-38.72	-41.66	-41.31	-41.51
18-Jul-2009	18:00:00	-34.29	-38.95	-41.92	-41.60	-41.72
18-Jul-2009	24:00:00	-34.33	-38.90	-41.78	-41.48	-41.61
19-Jul-2009	06:00:00	-34.82	-38.64	-41.53	-41.27	-41.30
19-Jul-2009	12:00:00	-34.70	-38.64	-41.66	-41.30	-41.46
19-Jul-2009	18:00:00	-34.32	-39.00	-41.90	-41.66	-41.72
19-Jul-2009	24:00:00	-34.46	-38.87	-41.82	-41.54	-41.57
20-Jul-2009	06:00:00	-34.82	-38.66	-41.66	-41.33	-41.43
20-Jul-2009	12:00:00	-34.50	-38.64	-41.60	-41.28	-41.39
20-Jul-2009	18:00:00	-34.30	-38.99	-41.98	-41.60	-41.77
20-Jul-2009	24:00:00	-34.30	-38.66	-41.70	-41.42	-41.51
21-Jul-2009	06:00:00	-34.84	-38.56	-41.77	-41.22	-41.24
21-Jul-2009	12:00:00	-34.72	-38.65	-41.80	-41.23	-41.37
21-Jul-2009	18:00:00	-34.32	-38.99	-42.08	-41.60	-41.71
21-Jul-2009	24:00:00	-34.28	-38.94	-42.04	-41.55	-41.64
22-Jul-2009	06:00:00	-34.60	-38.60	-41.72	-41.13	-41.28
22-Jul-2009	12:00:00	-34.82	-38.51	-41.70	-41.21	-41.30
22-Jul-2009	18:00:00	-34.29	-38.96	-42.00	-41.57	-41.63
22-Jul-2009	24:00:00	-34.41	-38.90	-41.98	-41.52	-41.69
23-Jul-2009	06:00:00	-34.63	-38.69	-41.82	-41.35	-41.47
23-Jul-2009	12:00:00	-34.59	-38.57	-41.73	-41.24	-41.41
23-Jul-2009	18:00:00	-34.62	-38.93	-42.06	-41.53	-41.73
23-Jul-2009	24:00:00	-34.50	-38.72	-41.83	-41.49	-41.69
24-Jul-2009	06:00:00	-34.54	-38.54	-41.61	-41.31	-41.40
24-Jul-2009	12:00:00	-34.76	-38.45	-41.79	-41.22	-41.40
24-Jul-2009	18:00:00	-34.39	-38.83	-42.10	-41.61	-41.75
24-Jul-2009	24:00:00	-34.44	-38.70	-42.13	-41.54	-41.65
25-Jul-2009	06:00:00	-34.89	-38.42	-41.66	-41.11	-41.23
25-Jul-2009	12:00:00	-34.86	-38.47	-41.76	-41.19	-41.33
25-Jul-2009	18:00:00	-34.52	-38.82	-42.10	-41.61	-41.71
25-Jul-2009	24:00:00	-34.42	-38.74	-42.09	-41.54	-41.65
26-Jul-2009	06:00:00	-34.74	-38.53	-41.85	-41.34	-41.34
26-Jul-2009	12:00:00	-34.69	-38.48	-41.88	-41.24	-41.33
26-Jul-2009	18:00:00	-34.47	-38.78	-42.06	-41.55	-41.70
26-Jul-2009	24:00:00	-34.54	-38.81	-42.07	-41.60	-41.71
27-Jul-2009	06:00:00	-34.89	-38.45	-41.89	-41.33	-41.34
27-Jul-2009	12:00:00	-34.95	-38.52	-41.86	-41.34	-41.43
27-Jul-2009	18:00:00	-34.40	-38.77	-42.08	-41.63	-41.69
27-Jul-2009	24:00:00	-34.47	-38.82	-41.97	-41.42	-41.69
28-Jul-2009	06:00:00	-34.78	-38.63	-41.77	-41.16	-41.57
28-Jul-2009	12:00:00	-34.69	-38.65	-41.74	-41.12	-41.49
28-Jul-2009	18:00:00	-34.20	-38.86	-41.97	-41.48	-41.78
28-Jul-2009	24:00:00	-34.39	-38.66	-41.76	-41.18	-41.53
29-Jul-2009	06:00:00	-34.75	-38.56	-41.71	-41.19	-41.45
29-Jul-2009	12:00:00	-34.58	-38.63	-41.70	-41.15	-41.49
29-Jul-2009	18:00:00	-34.39	-38.87	-42.00	-41.42	-41.77
29-Jul-2009	24:00:00	-34.34	-38.92	-42.03	-41.46	-41.87

Date	Time	Water Level (inches)				
		Jon AW15	Jon AW16	Jon AW17	Jon AW18	Jon AW19
30-Jul-2009	06:00:00	-34.74	-38.52	-41.66	-41.07	-41.47
30-Jul-2009	12:00:00	-34.78	-38.60	-41.71	-41.12	-41.46
30-Jul-2009	18:00:00	-34.53	-38.96	-42.04	-41.49	-41.79
30-Jul-2009	24:00:00	-34.33	-38.82	-41.96	-41.41	-41.71
31-Jul-2009	06:00:00	-34.89	-38.59	-41.70	-41.19	-41.48
31-Jul-2009	12:00:00	-34.42	-38.63	-41.74	-41.17	-41.51
31-Jul-2009	18:00:00	-34.60	-38.82	-41.98	-41.40	-41.73
31-Jul-2009	24:00:00	-34.39	-38.60	-41.72	-41.11	-41.54
1-Aug-2009	06:00:00	-34.58	-38.70	-41.78	-41.22	-41.64
1-Aug-2009	12:00:00	-34.92	-38.70	-41.79	-41.23	-41.65
1-Aug-2009	18:00:00	-34.40	-38.71	-41.84	-41.27	-41.64
1-Aug-2009	24:00:00	-34.33	-38.92	-41.96	-41.46	-41.81
2-Aug-2009	06:00:00	-34.77	-38.69	-41.77	-41.18	-41.48
2-Aug-2009	12:00:00	-34.45	-38.69	-41.78	-41.19	-41.43
2-Aug-2009	18:00:00	-34.59	-38.68	-41.70	-41.21	-41.55
2-Aug-2009	24:00:00	-34.38	-38.77	-41.80	-41.28	-41.60
3-Aug-2009	06:00:00	-34.90	-38.70	-41.71	-41.16	-41.51
3-Aug-2009	12:00:00	-34.72	-38.60	-41.74	-41.15	-41.49
3-Aug-2009	18:00:00	-34.40	-38.98	-42.04	-41.49	-41.81
3-Aug-2009	24:00:00	-34.28	-38.81	-41.85	-41.39	-41.70
4-Aug-2009	06:00:00	-34.83	-38.50	-41.60	-41.11	-41.41
4-Aug-2009	12:00:00	-34.62	-38.52	-41.61	-41.05	-41.43
4-Aug-2009	18:00:00	-34.52	-38.93	-41.98	-41.46	-41.72
4-Aug-2009	24:00:00	-34.36	-38.80	-41.84	-41.37	-41.75
5-Aug-2009	06:00:00	-34.76	-38.56	-41.64	-41.12	-41.45
5-Aug-2009	12:00:00	-34.84	-38.59	-41.67	-41.24	-41.53
5-Aug-2009	18:00:00	-34.57	-38.82	-41.84	-41.40	-41.71
5-Aug-2009	24:00:00	-34.38	-38.93	-41.90	-41.40	-41.70
6-Aug-2009	06:00:00	-34.72	-38.54	-41.61	-41.13	-41.45
6-Aug-2009	12:00:00	-34.60	-38.59	-41.66	-41.10	-41.49
6-Aug-2009	18:00:00	-34.51	-38.86	-41.90	-41.46	-41.78
6-Aug-2009	24:00:00	-34.10	-38.82	-41.92	-41.35	-41.69
7-Aug-2009	06:00:00	-34.60	-38.57	-41.59	-41.12	-41.52
7-Aug-2009	12:00:00	-34.80	-38.59	-41.62	-41.06	-41.46
7-Aug-2009	18:00:00	-34.20	-38.90	-41.95	-41.39	-41.76
7-Aug-2009	24:00:00	-34.35	-38.76	-41.85	-41.37	-41.65
8-Aug-2009	06:00:00	-34.82	-38.56	-41.50	-40.99	-41.41
8-Aug-2009	12:00:00	-34.83	-38.63	-41.62	-41.11	-41.51
8-Aug-2009	18:00:00	-34.33	-38.82	-41.88	-41.41	-41.73
8-Aug-2009	24:00:00	-34.35	-38.87	-41.84	-41.30	-41.71
9-Aug-2009	06:00:00	-34.82	-38.58	-41.62	-41.04	-41.36
9-Aug-2009	12:00:00	-34.75	-38.58	-41.61	-41.12	-41.48
9-Aug-2009	18:00:00	-34.45	-38.94	-42.02	-41.52	-41.77
9-Aug-2009	24:00:00	-34.30	-38.87	-42.00	-41.47	-41.73
10-Aug-2009	06:00:00	-34.64	-38.52	-41.49	-41.00	-41.37
10-Aug-2009	12:00:00	-34.92	-38.57	-41.62	-41.13	-41.51
10-Aug-2009	18:00:00	-34.41	-38.81	-41.95	-41.42	-41.69
10-Aug-2009	24:00:00	-34.38	-38.89	-41.88	-41.37	-41.70
11-Aug-2009	06:00:00	-34.80	-38.50	-41.54	-40.97	-41.33
11-Aug-2009	12:00:00	-35.13	-38.54	-41.60	-41.19	-41.47
11-Aug-2009	18:00:00	-34.46	-38.80	-41.90	-41.35	-41.73
11-Aug-2009	24:00:00	-34.41	-38.53	-41.62	-41.15	-41.41
12-Aug-2009	06:00:00	-34.44	-38.51	-41.61	-41.12	-41.41
12-Aug-2009	12:00:00	-34.59	-38.46	-41.55	-41.05	-41.39
12-Aug-2009	18:00:00	-34.32	-38.74	-41.85	-41.39	-41.67
12-Aug-2009	24:00:00	-34.58	-38.60	-41.78	-41.17	-41.59

Date	Time	Water Level (inches)				
		Jon AW15	Jon AW16	Jon AW17	Jon AW18	Jon AW19
13-Aug-2009	06:00:00	-34.59	-38.51	-41.65	-41.13	-41.43
13-Aug-2009	12:00:00	-34.74	-38.62	-41.68	-41.13	-41.55
13-Aug-2009	18:00:00	-34.51	-38.56	-41.62	-41.17	-41.48
13-Aug-2009	24:00:00	-34.47	-38.78	-41.94	-41.40	-41.69
14-Aug-2009	06:00:00	-34.76	-38.48	-41.60	-41.12	-41.45
14-Aug-2009	12:00:00	-34.66	-38.60	-41.65	-41.17	-41.48
14-Aug-2009	18:00:00	-34.42	-38.74	-41.88	-41.42	-41.69
14-Aug-2009	24:00:00	-34.30	-38.74	-41.90	-41.34	-31.83
15-Aug-2009	06:00:00	-34.76	-38.48	-41.74	-41.07	-41.63
15-Aug-2009	12:00:00	-34.83	-38.56	-41.73	-41.15	-39.13
15-Aug-2009	18:00:00	-34.38	-38.86	-42.09	-41.45	-41.90
15-Aug-2009	24:00:00	-34.28	-38.81	-42.01	-41.46	-41.81
16-Aug-2009	06:00:00	-34.69	-38.40	-41.62	-40.98	-41.43
16-Aug-2009	12:00:00	-34.77	-38.47	-41.72	-41.10	-41.60
16-Aug-2009	18:00:00	-34.33	-38.70	-41.95	-41.31	-41.76
16-Aug-2009	24:00:00	-34.36	-38.72	-42.02	-41.35	-41.82
17-Aug-2009	06:00:00	-34.63	-38.58	-41.73	-41.12	-41.57
17-Aug-2009	12:00:00	-34.62	-38.42	-41.66	-41.05	-41.46
17-Aug-2009	18:00:00	-34.18	-38.69	-41.90	-41.35	-41.79
17-Aug-2009	24:00:00	-34.54	-38.51	-41.78	-41.18	-41.60
18-Aug-2009	06:00:00	-34.63	-38.39	-41.58	-41.00	-41.49
18-Aug-2009	12:00:00	-34.64	-38.52	-41.79	-41.16	-41.63
18-Aug-2009	18:00:00	-34.23	-38.77	-41.96	-41.36	-41.87
18-Aug-2009	24:00:00	-34.26	-38.78	-41.95	-41.30	-41.79
19-Aug-2009	06:00:00	-34.60	-38.38	-41.67	-41.04	-41.33
19-Aug-2009	12:00:00	-34.63	-38.48	-41.65	-41.04	-41.45
19-Aug-2009	18:00:00	-34.18	-38.68	-41.83	-41.24	-41.55
19-Aug-2009	24:00:00	-34.22	-38.74	-41.97	-41.33	-41.66
20-Aug-2009	06:00:00	-34.84	-38.45	-41.59	-41.11	-41.35
20-Aug-2009	12:00:00	-34.87	-38.46	-41.66	-41.05	-41.46
20-Aug-2009	18:00:00	-34.34	-38.95	-42.00	-41.48	-41.76
20-Aug-2009	24:00:00	-34.16	-38.81	-41.98	-41.40	-41.71
21-Aug-2009	06:00:00	-34.70	-38.52	-41.74	-41.18	-41.52
21-Aug-2009	12:00:00	-34.81	-38.52	-41.78	-41.24	-41.47
21-Aug-2009	18:00:00	-34.40	-38.78	-42.01	-41.37	-41.71
21-Aug-2009	24:00:00	-34.46	-38.76	-41.96	-41.35	-41.64
22-Aug-2009	06:00:00	-34.58	-38.56	-41.76	-41.22	-41.45
22-Aug-2009	12:00:00	-34.30	-38.56	-41.71	-41.15	-41.43
22-Aug-2009	18:00:00	-33.38	-38.69	-41.84	-41.28	-41.60
22-Aug-2009	24:00:00	-31.03	-38.51	-41.61	-41.12	-41.42
23-Aug-2009	06:00:00	-31.72	-38.54	-36.43	-41.22	-41.51
23-Aug-2009	12:00:00	-33.15	-38.64	-41.74	-41.22	-41.47
23-Aug-2009	18:00:00	-34.29	-38.70	-41.90	-41.30	-41.83
23-Aug-2009	24:00:00	-34.51	-38.76	-41.92	-41.46	-41.87
24-Aug-2009	06:00:00	-34.65	-38.45	-41.66	-41.09	-41.57
24-Aug-2009	12:00:00	-34.39	-38.51	-41.73	-41.13	-41.65
24-Aug-2009	18:00:00	-34.57	-38.86	-41.35	-41.42	-42.00
24-Aug-2009	24:00:00	-34.74	-38.86	-41.95	-40.98	-41.77
25-Aug-2009	06:00:00	-34.87	-38.42	-41.49	-41.18	-41.23
25-Aug-2009	12:00:00	-34.27	-38.52	-41.71	-41.46	-41.52
25-Aug-2009	18:00:00	-34.33	-38.83	-42.08	-41.53	-41.78
25-Aug-2009	24:00:00	-34.88	-38.86	-42.01	-41.11	-41.79
26-Aug-2009	06:00:00	-34.71	-38.45	-41.61	-41.13	-41.36
26-Aug-2009	12:00:00	-34.35	-38.56	-41.60	-41.54	-41.46
26-Aug-2009	18:00:00	-34.28	-38.96	-41.97	-41.52	-41.83
26-Aug-2009	24:00:00	-34.81	-38.88	-41.98	-41.00	-41.73

Date	Time	Water Level (inches)				
		Jon AW15	Jon AW16	Jon AW17	Jon AW18	Jon AW19
27-Aug-2009	06:00:00	-34.57	-38.42	-41.60	-41.01	-41.28
27-Aug-2009	12:00:00	-34.52	-38.42	-41.53	-41.42	-41.35
27-Aug-2009	18:00:00	-34.40	-38.78	-41.97	-41.27	-41.71
27-Aug-2009	24:00:00	-34.60	-38.69	-41.76	-41.18	-41.60
28-Aug-2009	06:00:00	-34.33	-38.63	-41.65	-41.19	-41.51
28-Aug-2009	12:00:00	-34.32	-38.66	-41.72	-41.30	-41.53
28-Aug-2009	18:00:00	-34.41	-38.77	-41.83	-41.23	-41.69
28-Aug-2009	24:00:00	-34.78	-38.72	-41.74	-41.12	-41.55
29-Aug-2009	06:00:00	-34.63	-38.57	-41.64	-41.21	-41.37
29-Aug-2009	12:00:00	-34.33	-38.68	-41.68	-41.46	-41.46
29-Aug-2009	18:00:00	-34.34	-38.78	-41.88	-41.27	-41.64
29-Aug-2009	24:00:00	-34.62	-38.70	-41.78	-40.98	-41.61
30-Aug-2009	06:00:00	-34.51	-38.42	-41.48	-41.00	-41.30
30-Aug-2009	12:00:00	-34.36	-38.42	-41.53	-41.33	-41.37
30-Aug-2009	18:00:00	-34.23	-38.80	-41.88	-41.18	-41.64
30-Aug-2009	24:00:00	-34.34	-38.63	-41.66	-41.10	-41.42
31-Aug-2009	06:00:00	-34.00	-38.50	-41.60	-41.06	-41.37
31-Aug-2009	12:00:00	-34.04	-38.50	-41.54	-41.03	-41.36
31-Aug-2009	18:00:00	-34.50	-38.45	-41.50	-41.12	-41.40
31-Aug-2009	24:00:00	-34.65	-38.57	-41.59	-41.15	-41.41
1-Sep-2009	06:00:00	-34.72	-38.65	-41.68	-41.06	-41.40
1-Sep-2009	12:00:00	-34.36	-38.54	-41.59	-41.39	-41.47
1-Sep-2009	18:00:00	-34.42	-38.71	-41.92	-41.35	-41.70
1-Sep-2009	24:00:00	-34.81	-38.74	-41.89	-40.97	-41.66
2-Sep-2009	06:00:00	-34.75	-38.46	-41.46	-41.11	-41.29
2-Sep-2009	12:00:00	-34.35	-38.56	-41.60	-41.37	-41.30
2-Sep-2009	18:00:00	-34.35	-38.78	-41.79	-41.30	-41.60
2-Sep-2009	24:00:00	-34.72	-38.82	-41.77	-40.95	-41.59
3-Sep-2009	06:00:00	-34.77	-38.44	-41.56	-40.99	-41.31
3-Sep-2009	12:00:00	-34.50	-38.44	-41.60	-41.28	-41.36
3-Sep-2009	18:00:00	-34.28	-38.80	-41.83	-41.39	-41.57
3-Sep-2009	24:00:00	-34.87	-38.87	-41.96	-41.07	-41.64
4-Sep-2009	06:00:00	-34.71	-38.59	-41.66	-41.04	-41.41
4-Sep-2009	12:00:00	-34.39	-38.51	-41.62	-41.40	-41.25
4-Sep-2009	18:00:00	-34.40	-38.80	-41.88	-41.33	-41.64
4-Sep-2009	24:00:00	-34.71	-38.75	-41.82	-41.03	-41.58
5-Sep-2009	06:00:00	-34.76	-38.52	-41.59	-41.11	-41.35
5-Sep-2009	12:00:00	-34.51	-38.57	-41.61	-41.42	-41.42
5-Sep-2009	18:00:00	-34.30	-38.89	-41.94	-41.24	-41.69
5-Sep-2009	24:00:00	-34.74	-38.65	-41.80	-41.01	-41.48
6-Sep-2009	06:00:00	-34.57	-38.52	-41.58	-41.06	-41.33
6-Sep-2009	12:00:00	-34.46	-38.48	-41.58	-41.35	-41.28
6-Sep-2009	18:00:00	-34.42	-38.82	-41.89	-41.22	-41.64
6-Sep-2009	24:00:00	-34.63	-38.72	-41.80	-41.01	-41.48
7-Sep-2009	06:00:00	-34.66	-38.44	-41.56	-41.11	-41.36
7-Sep-2009	12:00:00	-34.50	-38.56	-41.59	-41.30	-41.34
7-Sep-2009	18:00:00	-34.50	-38.74	-41.82	-41.23	-41.63
7-Sep-2009	24:00:00	-34.65	-38.65	-41.78	-40.95	-41.39
8-Sep-2009	06:00:00	-34.88	-38.42	-41.55	-41.13	-41.25
8-Sep-2009	12:00:00	-34.39	-38.60	-41.77	-41.33	-41.46
8-Sep-2009	18:00:00	-34.24	-38.72	-41.82	-41.34	-41.57
8-Sep-2009	24:00:00	-34.66	-38.83	-41.96	-41.03	-41.59
9-Sep-2009	06:00:00	-34.58	-38.42	-41.53	-41.06	-41.23
9-Sep-2009	12:00:00	-34.45	-38.51	-41.59	-41.23	-41.34
9-Sep-2009	18:00:00	-34.41	-38.72	-41.82	-41.27	-41.54
9-Sep-2009	24:00:00	-34.75	-38.65	-41.80	-41.04	-41.58

Date	Time	Water Level (inches)				
		Jon AW15	Jon AW16	Jon AW17	Jon AW18	Jon AW19
10-Sep-2009	06:00:00	-34.56	-38.50	-41.62	-41.06	-41.31
10-Sep-2009	12:00:00	-34.40	-38.51	-41.68	-41.41	-41.39
10-Sep-2009	18:00:00	-34.30	-38.83	-41.90	-41.22	-41.73
10-Sep-2009	24:00:00	-34.96	-38.63	-41.78	-41.13	-41.59
11-Sep-2009	06:00:00	-34.75	-38.56	-41.67	-41.01	-41.49
11-Sep-2009	12:00:00	-34.39	-38.44	-41.59	-41.36	-41.37
11-Sep-2009	18:00:00	-34.39	-38.82	-41.94	-41.31	-41.66
11-Sep-2009	24:00:00	-34.84	-38.66	-41.82	-41.04	-41.63
12-Sep-2009	06:00:00	-34.48	-38.52	-41.56	-41.00	-41.39
12-Sep-2009	12:00:00	-34.46	-38.41	-41.55	-41.43	-41.28
12-Sep-2009	18:00:00	-34.32	-38.77	-41.95	-41.25	-41.71
12-Sep-2009	24:00:00	-34.65	-38.69	-41.77	-41.04	-41.49
13-Sep-2009	06:00:00	-34.62	-38.46	-41.54	-41.07	-41.37
13-Sep-2009	12:00:00	-34.44	-38.42	-41.55	-41.33	-41.41
13-Sep-2009	18:00:00	-34.26	-38.72	-41.85	-41.31	-41.53
13-Sep-2009	24:00:00	-34.69	-38.72	-41.80	-41.00	-41.55
14-Sep-2009	06:00:00	-34.75	-38.39	-41.56	-41.05	-41.24
14-Sep-2009	12:00:00	-34.33	-38.45	-41.55	-41.41	-41.24
14-Sep-2009	18:00:00	-34.30	-38.86	-41.94	-41.31	-41.64
14-Sep-2009	24:00:00	-34.68	-38.69	-41.86	-41.01	-41.59
15-Sep-2009	06:00:00	-34.46	-38.33	-41.52	-41.00	-41.29
15-Sep-2009	12:00:00	-34.40	-38.40	-41.54	-41.25	-41.21
15-Sep-2009	18:00:00	-34.44	-38.74	-41.88	-41.11	-41.48
15-Sep-2009	24:00:00	-34.71	-38.53	-41.65	-41.03	-41.31
16-Sep-2009	06:00:00	-34.40	-38.46	-41.60	-41.04	-41.18
16-Sep-2009	12:00:00	-34.52	-38.56	-41.58	-41.25	-41.33
16-Sep-2009	18:00:00	-34.51	-38.70	-41.80	-41.16	-41.46
16-Sep-2009	24:00:00	-34.65	-38.56	-41.70	-41.13	-41.40
17-Sep-2009	06:00:00	-34.75	-38.46	-41.61	-41.06	-41.39
17-Sep-2009	12:00:00	-34.50	-38.50	-41.70	-41.27	-41.36
17-Sep-2009	18:00:00	-34.51	-38.71	-41.80	-41.25	-41.52
17-Sep-2009	24:00:00	-34.54	-38.72	-41.85	-41.22	-41.52
18-Sep-2009	06:00:00	-34.54	-38.54	-41.72	-41.00	-41.39
18-Sep-2009	12:00:00	-34.44	-38.48	-41.68	-41.33	-41.37
18-Sep-2009	18:00:00	-34.39	-38.62	-41.79	-41.18	-41.53
18-Sep-2009	24:00:00	-34.68	-38.57	-41.74	-41.13	-41.48
19-Sep-2009	06:00:00	-34.51	-38.50	-41.60	-41.11	-41.40
19-Sep-2009	12:00:00	-34.35	-38.47	-41.66	-41.37	-41.35
19-Sep-2009	18:00:00	-34.26	-38.80	-41.91	-41.24	-41.58
19-Sep-2009	24:00:00	-34.70	-38.58	-41.68	-41.05	-41.51
20-Sep-2009	06:00:00	-34.57	-38.47	-41.55	-41.01	-41.36
20-Sep-2009	12:00:00	-34.32	-38.44	-41.53	-41.46	-41.29
20-Sep-2009	18:00:00	-34.51	-38.86	-42.00	-41.15	-41.77
20-Sep-2009	24:00:00	-34.74	-38.64	-41.68	-41.06	-41.43
21-Sep-2009	06:00:00	-34.56	-38.50	-41.59	-41.16	-41.35
21-Sep-2009	12:00:00	-34.58	-38.59	-41.67	-41.30	-41.48
21-Sep-2009	18:00:00	-34.44	-38.77	-41.83	-41.24	-41.66
21-Sep-2009	24:00:00	0.00	-38.62	-41.77	-41.21	-41.57
22-Sep-2009	06:00:00	0.00	-38.58	-41.67	-41.12	-41.45
22-Sep-2009	12:00:00	0.00	-38.53	-41.66	0.00	-41.36
22-Sep-2009	18:00:00	0.00	-38.80	0.00	0.00	0.00
22-Sep-2009	24:00:00	0.00	0.00	0.00	0.00	0.00
23-Sep-2009	06:00:00	0.00	0.00	0.00	0.00	0.00
23-Sep-2009	12:00:00	0.00	0.00	0.00	0.00	0.00
23-Sep-2009	18:00:00	0.00	0.00	0.00	0.00	0.00
23-Sep-2009	24:00:00	0.00	0.00	0.00	0.00	0.00

Date	Time	Water Level (inches)				
		Jon AW15	Jon AW16	Jon AW17	Jon AW18	Jon AW19
24-Sep-2009	06:00:00	0.00	0.00	0.00	0.00	0.00
24-Sep-2009	12:00:00	0.00	0.00	0.00	0.00	0.00
24-Sep-2009	18:00:00	0.00	0.00	0.00	0.00	0.00
24-Sep-2009	24:00:00	0.00	0.00	0.00	0.00	0.00
25-Sep-2009	06:00:00	0.00	0.00	0.00	0.00	0.00
25-Sep-2009	12:00:00	0.00	0.00	0.00	0.00	0.00
25-Sep-2009	18:00:00	0.00	0.00	0.00	0.00	0.00
25-Sep-2009	24:00:00	0.00	0.00	0.00	0.00	0.00
26-Sep-2009	06:00:00	0.00	0.00	0.00	0.00	0.00
26-Sep-2009	12:00:00	0.00	0.00	0.00	0.00	0.00
26-Sep-2009	18:00:00	0.00	0.00	0.00	0.00	0.00
26-Sep-2009	24:00:00	0.00	0.00	0.00	0.00	0.00
27-Sep-2009	06:00:00	0.00	0.00	0.00	0.00	0.00
27-Sep-2009	12:00:00	0.00	0.00	0.00	0.00	0.00
27-Sep-2009	18:00:00	0.00	0.00	0.00	0.00	0.00
27-Sep-2009	24:00:00	0.00	0.00	0.00	0.00	0.00
28-Sep-2009	06:00:00	0.00	0.00	0.00	0.00	0.00
28-Sep-2009	12:00:00	0.00	0.00	0.00	0.00	0.00
28-Sep-2009	18:00:00	0.00	0.00	0.00	0.00	0.00
28-Sep-2009	24:00:00	0.00	0.00	0.00	0.00	0.00
29-Sep-2009	06:00:00	0.00	0.00	0.00	0.00	0.00
29-Sep-2009	12:00:00	0.00	0.00	0.00	0.00	0.00
29-Sep-2009	18:00:00	0.00	0.00	0.00	0.00	0.00
29-Sep-2009	24:00:00	0.00	0.00	0.00	0.00	0.00
30-Sep-2009	06:00:00	0.00	0.00	0.00	0.00	0.00
30-Sep-2009	12:00:00	0.00	0.00	0.00	0.00	0.00
30-Sep-2009	18:00:00	0.00	0.00	0.00	0.00	0.00
30-Sep-2009	24:00:00	0.00	0.00	0.00	0.00	0.00
1-Oct-2009	06:00:00	0.00	0.00	0.00	0.00	0.00
1-Oct-2009	12:00:00	0.00	0.00	0.00	0.00	0.00
1-Oct-2009	18:00:00	0.00	0.00	0.00	0.00	0.00
1-Oct-2009	24:00:00	0.00	0.00	0.00	0.00	0.00
2-Oct-2009	06:00:00	0.00	0.00	0.00	0.00	0.00
2-Oct-2009	12:00:00	0.00	0.00	0.00	0.00	0.00
2-Oct-2009	18:00:00	0.00	0.00	0.00	0.00	0.00
2-Oct-2009	24:00:00	0.00	0.00	0.00	0.00	0.00
3-Oct-2009	06:00:00	0.00	0.00	0.00	0.00	0.00
3-Oct-2009	12:00:00	0.00	0.00	0.00	0.00	0.00
3-Oct-2009	18:00:00	0.00	0.00	0.00	0.00	0.00
3-Oct-2009	24:00:00	0.00	0.00	0.00	0.00	0.00
4-Oct-2009	06:00:00	0.00	0.00	0.00	0.00	0.00
4-Oct-2009	12:00:00	0.00	0.00	0.00	0.00	0.00
4-Oct-2009	18:00:00	0.00	0.00	0.00	0.00	0.00
4-Oct-2009	24:00:00	0.00	0.00	0.00	0.00	0.00
5-Oct-2009	06:00:00	0.00	0.00	0.00	0.00	0.00
5-Oct-2009	12:00:00	0.00	0.00	0.00	0.00	0.00
5-Oct-2009	18:00:00	0.00	0.00	0.00	0.00	0.00
5-Oct-2009	24:00:00	0.00	0.00	0.00	0.00	0.00
6-Oct-2009	06:00:00	0.00	0.00	0.00	0.00	0.00
6-Oct-2009	12:00:00	0.00	0.00	0.00	0.00	0.00
6-Oct-2009	18:00:00	0.00	0.00	0.00	0.00	0.00
6-Oct-2009	24:00:00	0.00	0.00	0.00	0.00	0.00
7-Oct-2009	06:00:00	0.00	0.00	0.00	0.00	0.00
7-Oct-2009	12:00:00	0.00	0.00	0.00	0.00	0.00
7-Oct-2009	18:00:00	0.00	0.00	0.00	0.00	0.00
7-Oct-2009	24:00:00	0.00	0.00	0.00	0.00	0.00

Date	Time	Water Level (inches)				
		Jon AW15	Jon AW16	Jon AW17	Jon AW18	Jon AW19
8-Oct-2009	06:00:00	0.00	0.00	0.00	0.00	0.00
8-Oct-2009	12:00:00	0.00	0.00	0.00	0.00	0.00
8-Oct-2009	18:00:00	0.00	0.00	0.00	0.00	0.00
8-Oct-2009	24:00:00	0.00	0.00	0.00	0.00	0.00
9-Oct-2009	06:00:00	0.00	0.00	0.00	0.00	0.00
9-Oct-2009	12:00:00	0.00	0.00	0.00	0.00	0.00
9-Oct-2009	18:00:00	0.00	0.00	0.00	0.00	0.00
9-Oct-2009	24:00:00	0.00	0.00	0.00	0.00	0.00
10-Oct-2009	06:00:00	0.00	0.00	0.00	0.00	0.00
10-Oct-2009	12:00:00	0.00	0.00	0.00	0.00	0.00
10-Oct-2009	18:00:00	0.00	0.00	0.00	0.00	0.00
10-Oct-2009	24:00:00	0.00	0.00	0.00	0.00	0.00
11-Oct-2009	06:00:00	0.00	0.00	0.00	0.00	0.00
11-Oct-2009	12:00:00	0.00	0.00	0.00	0.00	0.00
11-Oct-2009	18:00:00	0.00	0.00	0.00	0.00	0.00
11-Oct-2009	24:00:00	0.00	0.00	0.00	0.00	0.00
12-Oct-2009	06:00:00	0.00	0.00	0.00	0.00	0.00
12-Oct-2009	12:00:00	0.00	0.00	0.00	0.00	0.00
12-Oct-2009	18:00:00	0.00	0.00	0.00	0.00	0.00
12-Oct-2009	24:00:00	0.00	0.00	0.00	0.00	0.00
13-Oct-2009	06:00:00	0.00	0.00	0.00	0.00	0.00
13-Oct-2009	12:00:00	0.00	0.00	0.00	0.00	0.00
13-Oct-2009	18:00:00	0.00	0.00	0.00	0.00	0.00
13-Oct-2009	24:00:00	0.00	0.00	0.00	0.00	0.00
14-Oct-2009	06:00:00	0.00	0.00	0.00	0.00	0.00
14-Oct-2009	12:00:00	0.00	0.00	0.00	0.00	0.00
14-Oct-2009	18:00:00	0.00	0.00	0.00	0.00	0.00
14-Oct-2009	24:00:00	0.00	0.00	0.00	0.00	0.00
15-Oct-2009	06:00:00	0.00	0.00	0.00	0.00	0.00
15-Oct-2009	12:00:00	0.00	0.00	0.00	0.00	0.00
15-Oct-2009	18:00:00	0.00	0.00	0.00	0.00	0.00
15-Oct-2009	24:00:00	0.00	0.00	0.00	0.00	0.00
16-Oct-2009	06:00:00	0.00	0.00	0.00	0.00	0.00
16-Oct-2009	12:00:00	0.00	0.00	0.00	0.00	0.00
16-Oct-2009	18:00:00	0.00	0.00	0.00	0.00	0.00
16-Oct-2009	24:00:00	0.00	0.00	0.00	0.00	0.00
17-Oct-2009	06:00:00	0.00	0.00	0.00	0.00	0.00
17-Oct-2009	12:00:00	0.00	0.00	0.00	0.00	0.00
17-Oct-2009	18:00:00	0.00	0.00	0.00	0.00	0.00
17-Oct-2009	24:00:00	0.00	0.00	0.00	0.00	0.00
18-Oct-2009	06:00:00	0.00	0.00	0.00	0.00	0.00
18-Oct-2009	12:00:00	0.00	0.00	0.00	0.00	0.00
18-Oct-2009	18:00:00	0.00	0.00	0.00	0.00	0.00
18-Oct-2009	24:00:00	0.00	0.00	0.00	0.00	0.00
19-Oct-2009	06:00:00	0.00	0.00	0.00	0.00	0.00
19-Oct-2009	12:00:00	0.00	0.00	0.00	0.00	0.00
19-Oct-2009	18:00:00	0.00	0.00	0.00	0.00	0.00
19-Oct-2009	24:00:00	0.00	0.00	0.00	0.00	0.00
20-Oct-2009	06:00:00	0.00	0.00	0.00	0.00	0.00
20-Oct-2009	12:00:00	0.00	0.00	0.00	0.00	0.00
20-Oct-2009	18:00:00	0.00	0.00	0.00	0.00	0.00
20-Oct-2009	24:00:00	0.00	0.00	0.00	0.00	0.00
21-Oct-2009	06:00:00	0.00	0.00	0.00	0.00	0.00
21-Oct-2009	12:00:00	0.00	0.00	0.00	0.00	0.00
21-Oct-2009	18:00:00	0.00	0.00	0.00	0.00	0.00
21-Oct-2009	24:00:00	0.00	0.00	0.00	0.00	0.00

Date	Time	Water Level (inches)				
		Jon AW15	Jon AW16	Jon AW17	Jon AW18	Jon AW19
22-Oct-2009	06:00:00	0.00	0.00	0.00	0.00	0.00
22-Oct-2009	12:00:00	0.00	0.00	0.00	0.00	0.00
22-Oct-2009	18:00:00	0.00	0.00	0.00	0.00	0.00
22-Oct-2009	24:00:00	0.00	0.00	0.00	0.00	0.00
23-Oct-2009	06:00:00	0.00	0.00	0.00	0.00	0.00
23-Oct-2009	12:00:00	0.00	0.00	0.00	0.00	0.00
23-Oct-2009	18:00:00	0.00	0.00	0.00	0.00	0.00
23-Oct-2009	24:00:00	0.00	0.00	0.00	0.00	0.00
24-Oct-2009	06:00:00	0.00	0.00	0.00	0.00	0.00
24-Oct-2009	12:00:00	0.00	0.00	0.00	0.00	0.00
24-Oct-2009	18:00:00	0.00	0.00	0.00	0.00	0.00
24-Oct-2009	24:00:00	0.00	0.00	0.00	0.00	0.00
25-Oct-2009	06:00:00	0.00	0.00	0.00	0.00	0.00
25-Oct-2009	12:00:00	0.00	0.00	0.00	0.00	0.00
25-Oct-2009	18:00:00	0.00	0.00	0.00	0.00	0.00
25-Oct-2009	24:00:00	0.00	0.00	0.00	0.00	0.00
26-Oct-2009	06:00:00	0.00	0.00	0.00	0.00	0.00
26-Oct-2009	12:00:00	0.00	0.00	0.00	0.00	0.00
26-Oct-2009	18:00:00	0.00	0.00	0.00	0.00	0.00
26-Oct-2009	24:00:00	0.00	0.00	0.00	0.00	0.00
27-Oct-2009	06:00:00	0.00	0.00	0.00	0.00	0.00
27-Oct-2009	12:00:00	0.00	0.00	0.00	0.00	0.00
27-Oct-2009	18:00:00	0.00	0.00	0.00	0.00	0.00
27-Oct-2009	24:00:00	0.00	0.00	0.00	0.00	0.00
28-Oct-2009	06:00:00	0.00	0.00	0.00	0.00	0.00
28-Oct-2009	12:00:00	0.00	0.00	0.00	0.00	0.00
28-Oct-2009	18:00:00	0.00	0.00	0.00	0.00	0.00
28-Oct-2009	24:00:00	0.00	0.00	0.00	0.00	0.00
29-Oct-2009	06:00:00	0.00	0.00	0.00	0.00	0.00
29-Oct-2009	12:00:00	0.00	0.00	0.00	0.00	0.00
29-Oct-2009	18:00:00	0.00	0.00	0.00	0.00	0.00
29-Oct-2009	24:00:00	0.00	0.00	0.00	0.00	0.00
30-Oct-2009	06:00:00	0.00	0.00	0.00	0.00	0.00
30-Oct-2009	12:00:00	0.00	0.00	0.00	0.00	0.00
30-Oct-2009	18:00:00	0.00	0.00	0.00	0.00	0.00
30-Oct-2009	24:00:00	0.00	0.00	0.00	0.00	0.00
31-Oct-2009	06:00:00	0.00	0.00	0.00	0.00	0.00
31-Oct-2009	12:00:00	0.00	0.00	0.00	0.00	0.00
31-Oct-2009	18:00:00	0.00	0.00	0.00	0.00	0.00
31-Oct-2009	24:00:00	0.00	0.00	0.00	0.00	0.00
1-Nov-2009	06:00:00	0.00	0.00	0.00	0.00	0.00
1-Nov-2009	12:00:00	0.00	0.00	0.00	0.00	0.00
1-Nov-2009	18:00:00	0.00	0.00	0.00	0.00	0.00
1-Nov-2009	24:00:00	0.00	0.00	0.00	0.00	0.00
2-Nov-2009	06:00:00	0.00	0.00	0.00	0.00	0.00
2-Nov-2009	12:00:00	0.00	0.00	0.00	0.00	0.00
2-Nov-2009	18:00:00	0.00	0.00	0.00	0.00	0.00
2-Nov-2009	24:00:00	0.00	0.00	0.00	0.00	0.00
3-Nov-2009	06:00:00	0.00	0.00	0.00	0.00	0.00
3-Nov-2009	12:00:00	0.00	0.00	0.00	0.00	0.00
3-Nov-2009	18:00:00	0.00	0.00	0.00	0.00	0.00
3-Nov-2009	24:00:00	0.00	0.00	0.00	0.00	0.00
4-Nov-2009	06:00:00	0.00	0.00	0.00	0.00	0.00
4-Nov-2009	12:00:00	0.00	0.00	0.00	0.00	0.00
4-Nov-2009	18:00:00	0.00	0.00	0.00	0.00	0.00
4-Nov-2009	24:00:00	0.00	0.00	0.00	0.00	0.00

Date	Time	Water Level (inches)				
		Jon AW15	Jon AW16	Jon AW17	Jon AW18	Jon AW19
5-Nov-2009	06:00:00	0.00	0.00	0.00	0.00	0.00
5-Nov-2009	12:00:00	0.00	0.00	0.00	0.00	0.00
5-Nov-2009	18:00:00	0.00	0.00	0.00	0.00	0.00
5-Nov-2009	24:00:00	0.00	0.00	0.00	0.00	0.00
6-Nov-2009	06:00:00	0.00	0.00	0.00	0.00	0.00
6-Nov-2009	12:00:00	0.00	0.00	0.00	0.00	0.00
6-Nov-2009	18:00:00	0.00	0.00	0.00	0.00	0.00
6-Nov-2009	24:00:00	0.00	0.00	0.00	0.00	0.00
7-Nov-2009	06:00:00	0.00	0.00	0.00	0.00	0.00
7-Nov-2009	12:00:00	0.00	0.00	0.00	0.00	0.00
7-Nov-2009	18:00:00	0.00	0.00	0.00	0.00	0.00
7-Nov-2009	24:00:00	0.00	0.00	0.00	0.00	0.00
8-Nov-2009	06:00:00	0.00	0.00	0.00	0.00	0.00
8-Nov-2009	12:00:00	0.00	0.00	0.00	0.00	0.00
8-Nov-2009	18:00:00	0.00	0.00	0.00	0.00	0.00
8-Nov-2009	24:00:00	0.00	0.00	0.00	0.00	0.00
9-Nov-2009	06:00:00	0.00	0.00	0.00	0.00	0.00
9-Nov-2009	12:00:00	0.00	0.00	0.00	0.00	0.00
9-Nov-2009	18:00:00	0.00	0.00	0.00	0.00	0.00
9-Nov-2009	24:00:00	0.00	0.00	0.00	0.00	0.00
10-Nov-2009	06:00:00	0.00	0.00	0.00	0.00	0.00
10-Nov-2009	12:00:00	0.00	0.00	0.00	0.00	0.00
10-Nov-2009	18:00:00	0.00	0.00	0.00	0.00	0.00
10-Nov-2009	24:00:00	0.00	0.00	0.00	0.00	0.00
11-Nov-2009	06:00:00	0.00	0.00	0.00	0.00	0.00
11-Nov-2009	12:00:00	0.00	0.00	0.00	0.00	0.00
11-Nov-2009	18:00:00	0.00	0.00	0.00	0.00	0.00
11-Nov-2009	24:00:00	0.00	0.00	0.00	0.00	0.00
12-Nov-2009	06:00:00	0.00	0.00	0.00	0.00	0.00
12-Nov-2009	12:00:00	0.00	0.00	0.00	0.00	0.00
12-Nov-2009	18:00:00	0.00	0.00	0.00	0.00	0.00
12-Nov-2009	24:00:00	0.00	0.00	0.00	0.00	0.00
13-Nov-2009	06:00:00	0.00	0.00	0.00	0.00	0.00
13-Nov-2009	12:00:00	0.00	0.00	0.00	0.00	0.00
13-Nov-2009	18:00:00	0.00	0.00	0.00	0.00	0.00
13-Nov-2009	24:00:00	0.00	0.00	0.00	0.00	0.00
14-Nov-2009	06:00:00	0.00	0.00	0.00	0.00	0.00
14-Nov-2009	12:00:00	0.00	0.00	0.00	0.00	0.00
14-Nov-2009	18:00:00	0.00	0.00	0.00	0.00	0.00
14-Nov-2009	24:00:00	0.00	0.00	0.00	0.00	0.00
15-Nov-2009	06:00:00	0.00	0.00	0.00	0.00	0.00
15-Nov-2009	12:00:00	0.00	0.00	0.00	0.00	0.00
15-Nov-2009	18:00:00	0.00	0.00	0.00	0.00	0.00
15-Nov-2009	24:00:00	0.00	0.00	0.00	0.00	0.00
16-Nov-2009	06:00:00	0.00	0.00	0.00	0.00	0.00
16-Nov-2009	12:00:00	0.00	0.00	0.00	0.00	0.00
16-Nov-2009	18:00:00	0.00	0.00	0.00	0.00	0.00
16-Nov-2009	24:00:00	0.00	0.00	0.00	0.00	0.00
17-Nov-2009	06:00:00	0.00	0.00	0.00	0.00	0.00
17-Nov-2009	12:00:00	0.00	0.00	0.00	0.00	0.00
17-Nov-2009	18:00:00	0.00	0.00	0.00	0.00	0.00
17-Nov-2009	24:00:00	0.00	0.00	0.00	0.00	0.00
18-Nov-2009	06:00:00	0.00	0.00	0.00	0.00	0.00
18-Nov-2009	12:00:00	0.00	0.00	0.00	0.00	0.00
18-Nov-2009	18:00:00	0.00	0.00	0.00	0.00	0.00
18-Nov-2009	24:00:00	0.00	0.00	0.00	0.00	0.00

Date	Time	Water Level (inches)				
		Jon AW15	Jon AW16	Jon AW17	Jon AW18	Jon AW19
19-Nov-2009	06:00:00	0.00	0.00	0.00	0.00	0.00
19-Nov-2009	12:00:00	0.00	0.00	0.00	0.00	0.00
19-Nov-2009	18:00:00	0.00	0.00	0.00	0.00	0.00
19-Nov-2009	24:00:00	0.00	0.00	0.00	0.00	0.00
20-Nov-2009	06:00:00	0.00	0.00	0.00	0.00	0.00
20-Nov-2009	12:00:00	0.00	0.00	0.00	0.00	0.00
20-Nov-2009	18:00:00	0.00	0.00	0.00	0.00	0.00
20-Nov-2009	24:00:00	0.00	0.00	0.00	0.00	0.00
21-Nov-2009	06:00:00	0.00	0.00	0.00	0.00	0.00
21-Nov-2009	12:00:00	0.00	0.00	0.00	0.00	0.00
21-Nov-2009	18:00:00	0.00	0.00	0.00	0.00	0.00
21-Nov-2009	24:00:00	0.00	0.00	0.00	0.00	0.00
22-Nov-2009	06:00:00	0.00	0.00	0.00	0.00	0.00
22-Nov-2009	12:00:00	0.00	0.00	0.00	0.00	0.00
22-Nov-2009	18:00:00	0.00	0.00	0.00	0.00	0.00
22-Nov-2009	24:00:00	0.00	0.00	0.00	0.00	0.00
23-Nov-2009	06:00:00	0.00	0.00	0.00	0.00	0.00
23-Nov-2009	12:00:00	0.00	0.00	0.00	0.00	0.00
23-Nov-2009	18:00:00	0.00	0.00	0.00	0.00	0.00
23-Nov-2009	24:00:00	0.00	0.00	0.00	0.00	0.00
24-Nov-2009	06:00:00	0.00	0.00	0.00	0.00	0.00
24-Nov-2009	12:00:00	0.00	0.00	0.00	0.00	0.00
24-Nov-2009	18:00:00	0.00	0.00	0.00	0.00	0.00
24-Nov-2009	24:00:00	0.00	0.00	0.00	0.00	0.00
25-Nov-2009	06:00:00	0.00	0.00	0.00	0.00	0.00
25-Nov-2009	12:00:00	0.00	0.00	0.00	0.00	0.00
25-Nov-2009	18:00:00	0.00	0.00	0.00	0.00	0.00
25-Nov-2009	24:00:00	0.00	0.00	0.00	0.00	0.00
26-Nov-2009	06:00:00	0.00	0.00	0.00	0.00	0.00
26-Nov-2009	12:00:00	0.00	0.00	0.00	0.00	0.00
26-Nov-2009	18:00:00	0.00	0.00	0.00	0.00	0.00
26-Nov-2009	24:00:00	0.00	0.00	0.00	0.00	0.00
27-Nov-2009	06:00:00	0.00	0.00	0.00	0.00	0.00
27-Nov-2009	12:00:00	0.00	0.00	0.00	0.00	0.00
27-Nov-2009	18:00:00	0.00	0.00	0.00	0.00	0.00
27-Nov-2009	24:00:00	0.00	0.00	0.00	0.00	0.00
28-Nov-2009	06:00:00	0.00	0.00	0.00	0.00	0.00
28-Nov-2009	12:00:00	0.00	0.00	0.00	0.00	0.00
28-Nov-2009	18:00:00	0.00	0.00	0.00	0.00	0.00
28-Nov-2009	24:00:00	0.00	0.00	0.00	0.00	0.00
29-Nov-2009	06:00:00	0.00	0.00	0.00	0.00	0.00
29-Nov-2009	12:00:00	0.00	0.00	0.00	0.00	0.00
29-Nov-2009	18:00:00	0.00	0.00	0.00	0.00	0.00
29-Nov-2009	24:00:00	0.00	0.00	0.00	0.00	0.00
30-Nov-2009	06:00:00	0.00	0.00	0.00	0.00	0.00
30-Nov-2009	12:00:00	0.00	0.00	0.00	0.00	0.00
30-Nov-2009	18:00:00	0.00	0.00	0.00	0.00	0.00
30-Nov-2009	24:00:00	0.00	0.00	0.00	0.00	0.00
1-Dec-2009	06:00:00	0.00	0.00	0.00	0.00	0.00
1-Dec-2009	12:00:00	0.00	0.00	0.00	0.00	0.00
1-Dec-2009	18:00:00	0.00	0.00	0.00	0.00	0.00
1-Dec-2009	24:00:00	0.00	0.00	0.00	0.00	0.00
2-Dec-2009	06:00:00	0.00	0.00	0.00	0.00	0.00
2-Dec-2009	12:00:00	0.00	0.00	0.00	0.00	0.00
2-Dec-2009	18:00:00	0.00	0.00	0.00	0.00	0.00
2-Dec-2009	24:00:00	0.00	0.00	0.00	0.00	0.00

Date	Time	Water Level (inches)				
		Jon AW15	Jon AW16	Jon AW17	Jon AW18	Jon AW19
3-Dec-2009	06:00:00	0.00	0.00	0.00	0.00	0.00
3-Dec-2009	12:00:00	0.00	0.00	0.00	0.00	0.00
3-Dec-2009	18:00:00	0.00	0.00	0.00	0.00	0.00
3-Dec-2009	24:00:00	0.00	0.00	0.00	0.00	0.00
4-Dec-2009	06:00:00	0.00	0.00	0.00	0.00	0.00
4-Dec-2009	12:00:00	0.00	0.00	0.00	0.00	0.00
4-Dec-2009	18:00:00	0.00	0.00	0.00	0.00	0.00
4-Dec-2009	24:00:00	0.00	0.00	0.00	0.00	0.00
5-Dec-2009	06:00:00	0.00	0.00	0.00	0.00	0.00
5-Dec-2009	12:00:00	0.00	0.00	0.00	0.00	0.00
5-Dec-2009	18:00:00	0.00	0.00	0.00	0.00	0.00
5-Dec-2009	24:00:00	0.00	0.00	0.00	0.00	0.00
6-Dec-2009	06:00:00	0.00	0.00	0.00	0.00	0.00
6-Dec-2009	12:00:00	0.00	0.00	0.00	0.00	0.00
6-Dec-2009	18:00:00	0.00	0.00	0.00	0.00	0.00
6-Dec-2009	24:00:00	0.00	0.00	0.00	0.00	0.00
7-Dec-2009	06:00:00	0.00	0.00	0.00	0.00	0.00
7-Dec-2009	12:00:00	0.00	0.00	0.00	0.00	0.00
7-Dec-2009	18:00:00	0.00	0.00	0.00	0.00	0.00
7-Dec-2009	24:00:00	0.00	0.00	0.00	0.00	0.00
8-Dec-2009	06:00:00	0.00	0.00	0.00	0.00	0.00
8-Dec-2009	12:00:00	0.00	0.00	0.00	0.00	0.00
8-Dec-2009	18:00:00	0.00	0.00	0.00	0.00	0.00
8-Dec-2009	24:00:00	0.00	0.00	0.00	0.00	0.00
9-Dec-2009	06:00:00	0.00	0.00	0.00	0.00	0.00
9-Dec-2009	12:00:00	0.00	0.00	0.00	0.00	0.00
9-Dec-2009	18:00:00	0.00	0.00	0.00	0.00	0.00
9-Dec-2009	24:00:00	0.00	0.00	0.00	0.00	0.00
10-Dec-2009	06:00:00	0.00	0.00	0.00	0.00	0.00
10-Dec-2009	12:00:00	0.00	0.00	0.00	0.00	0.00
10-Dec-2009	18:00:00	0.00	0.00	0.00	0.00	0.00
10-Dec-2009	24:00:00	0.00	0.00	0.00	0.00	0.00
11-Dec-2009	06:00:00	0.00	0.00	0.00	0.00	0.00
11-Dec-2009	12:00:00	0.00	0.00	0.00	0.00	0.00
11-Dec-2009	18:00:00	0.00	0.00	0.00	0.00	0.00
11-Dec-2009	24:00:00	0.00	0.00	0.00	0.00	0.00
12-Dec-2009	06:00:00	0.00	0.00	0.00	0.00	0.00
12-Dec-2009	12:00:00	0.00	0.00	0.00	0.00	0.00
12-Dec-2009	18:00:00	0.00	0.00	0.00	0.00	0.00
12-Dec-2009	24:00:00	0.00	0.00	0.00	0.00	0.00
13-Dec-2009	06:00:00	0.00	0.00	0.00	0.00	0.00
13-Dec-2009	12:00:00	0.00	0.00	0.00	0.00	0.00
13-Dec-2009	18:00:00	0.00	0.00	0.00	0.00	0.00
13-Dec-2009	24:00:00	0.00	0.00	0.00	0.00	0.00
14-Dec-2009	06:00:00	0.00	0.00	0.00	0.00	0.00
14-Dec-2009	12:00:00	0.00	0.00	0.00	0.00	0.00
14-Dec-2009	18:00:00	0.00	0.00	0.00	0.00	0.00
14-Dec-2009	24:00:00	0.00	0.00	0.00	0.00	0.00
15-Dec-2009	06:00:00	0.00	0.00	0.00	0.00	0.00
15-Dec-2009	12:00:00	0.00	0.00	0.00	0.00	0.00
15-Dec-2009	18:00:00	0.00	0.00	0.00	0.00	0.00
15-Dec-2009	24:00:00	0.00	0.00	0.00	0.00	0.00
16-Dec-2009	06:00:00	0.00	0.00	0.00	0.00	0.00
16-Dec-2009	12:00:00	0.00	0.00	0.00	0.00	0.00
16-Dec-2009	18:00:00	0.00	0.00	0.00	0.00	0.00
16-Dec-2009	24:00:00	0.00	0.00	0.00	0.00	0.00

Date	Time	Water Level (inches)				
dd-mmm-yyyy	hh:mm:ss	Jon AW15	Jon AW16	Jon AW17	Jon AW18	Jon AW19
31-Dec-2009	18:00:00	0.00	0.00	0.00	0.00	0.00
31-Dec-2009	24:00:00	0.00	0.00	0.00	0.00	0.00
1-Jan-2010	06:00:00	0.00	0.00	0.00	0.00	0.00
1-Jan-2010	12:00:00	0.00	0.00	0.00	0.00	0.00
1-Jan-2010	18:00:00	0.00	0.00	0.00	0.00	0.00
1-Jan-2010	24:00:00	0.00	0.00	0.00	0.00	0.00