

**May 2018 Revision**  
**to**  
**Amendment 1**  
**to the**  
**North Carolina Shrimp**  
**Fishery Management Plan**

Prepared by the

North Carolina Department of Environmental Quality  
Division of Marine Fisheries  
3441 Arendell Street  
P.O. Box 769  
Morehead City, NC 28557



## Executive Summary

There are three shrimp species (brown, pink, and white) that make up the shrimp fishery in North Carolina. In 2018, shrimp were the most economically important species for commercial fisheries in North Carolina. Amendment 1 to the Shrimp Fishery Management Plan (FMP) was developed to address bycatch in the commercial and recreational shrimp fishery as well as the development of a live bait shrimp fishery. In February 2015, the North Carolina Marine Fisheries Commission (NCMFC) adopted Amendment 1 and recommended a wider range of certified bycatch reduction devices to choose from, required two bycatch reduction devices in shrimp trawls and skimmer trawls, increased the daily harvest limit for cast nets in closed areas, and allowed live bait fishermen to fish until noon on Saturdays. In accordance with Amendment 1 as an adaptive management measure, the NCMFC also formed a Shrimp Bycatch Reduction Industry Workgroup (workgroup) made up of fishermen, net makers, and scientists from North Carolina Division of Marine Fisheries (NCDMF), National Marine Fisheries Service (NMFS), and N.C. Sea Grant to develop different gear configurations to reduce bycatch to the greatest extent practicable with a 40 percent target reduction.

During 2015-2017, a series of gear comparisons were made using modified shrimp trawls in Pamlico Sound and the Atlantic Ocean to determine gear configurations that best reduce bycatch, while maintaining acceptable shrimp harvest. The workgroup had initially desired acceptable shrimp loss as between 3% to 5%, depending on the reduction in bycatch achieved. However, after reviewing the results of the testing, the workgroup noted that a higher range of shrimp loss would be acceptable if significant finfish bycatch reduction occurred. Twelve experimental otter trawl configurations were tested (14 comparisons total) against a control net consisting of a federally certified Turtle Excluder Device (TED) with 4-inch bar spacing, one state fisheye Bycatch Reduction Device (BRD), and a 1 1/2-inch stretch mesh tailbag (current industry standard). Paired t-tests and a randomization test were used to determine whether the catches between the control and experimental nets were significantly different for each catch category (shrimp and bycatch species).

Four of the 12 gear combinations tested met or exceeded the 40% target reduction in finfish bycatch while also minimizing shrimp loss. Overall, finfish bycatch reductions ranged from 4.5 to 57.2%. Differences in shrimp catch between the control and experimental nets ranged from a 16.2 percent loss to a 9.9% gain. Results from the industry workgroup testing and the workgroup recommendation were presented to the NCMFC at its May 2018 business meeting. At this meeting the NCMFC voted to require fishermen to use one of four gear combinations tested by the workgroup that achieved at least a 40 percent reduction in finfish bycatch. The four gear configurations that achieved or exceeded these bycatch reductions without significantly reducing shrimp catch (less than 6 %) were:

- Double federal fisheyes used with a 1 7/8-inch stretch mesh tailbag and a 4-inch spaced bar TED
- Double federal fisheyes used with a 1 3/4-inch stretch mesh tailbag and a 4-inch spaced bar TED
- Double federal fisheyes used with a 1 3/4-inch stretch mesh tailbag and a 3-inch spaced bar TED
- A single state fisheye used with a 1 3/4-inch stretch mesh tailbag and a Virgil Potter BRD

Tows made with 4-inch TED, double federal fisheyes, and 1 3/4-inch tailbag significantly reduced finfish bycatch from 54.0% (randomization test) to 57.2% (t-test) and had the greatest reduction in finfish bycatch of all the gear combinations tested by the workgroup. Tows made with the 3-inch TED, double federal fisheyes, and 1 3/4-inch tailbag gears yielded the second highest reduction of the gear combinations tested, reducing finfish bycatch by 44.9% (t-test and randomization test). Tows made with the Virgil Potter BRD, and 1 3/4-inch tailbag gear combination was found to significantly reduce finfish bycatch by 43.2% (t-test) to 44.3% (randomization test). While not significant, the mean weight of shrimp was reduced by 5.5% for this gear combination. The double federal fisheye, 4-inch TED and 1 7/8-inch tailbag gear combination was found to significantly reduce finfish bycatch by 40.8% based on the t-test results. Randomization test results also found that finfish bycatch was reduced by 40.1% for this gear. The new gear configurations will be required in all shrimp trawls, except skimmer trawls, used in inside waters where up to 220 feet of combined headrope is allowed (Pamlico Sound and portions of the Pamlico, Bay, and Neuse rivers).

An issue paper outlining the results of the gear testing and industry workgroup recommendation were presented to the NCMFC at its May 2018 business meeting. At that time, the NCMFC selected their preferred management strategy. Management measures approved by the NCMFC were implemented via Proclamation SH-3-2019, effective July 1, 2019. The commission also voted to continue the shrimp industry workgroup and explore funding options for more studies; to survey fishermen to determine what bycatch reduction devices the shrimp trawl industry currently uses; and to begin development of Amendment 2 to the Shrimp Fishery Management Plan. This document serves as the Revision to Amendment 1 to the N.C. Shrimp FMP and documents the supporting data and rationale of the NCMFC for the following changes in shrimp management under Amendment 1 to be implemented May 1, 2018, unless otherwise specified. All other management strategies contained in Amendment 1 remain in force until another revision, supplement, or amendment to the N.C. shrimp FMP occurs.

## **I. SUBJECT**

Investigate gear modifications that could be implemented to reduce bycatch in the shrimp trawl fishery.

## **II. ORIGINATION**

The North Carolina Shrimp Fishery Management Plan (FMP) Amendment 1 and the North Carolina Marine Fisheries Commission (NCMFC).

## **III. BACKGROUND**

### NCMFC Action

In February 2015, the MFC adopted the Shrimp FMP Amendment 1 and its associated rules (NCDMF 2015). The amendment's primary focus is bycatch reduction in the shrimp trawl fishery. The MFC's preferred management strategy called for three years of industry testing of various gear configurations to reduce bycatch to the greatest extent practicable, with a 40% target reduction goal. Testing is to be conducted by a stakeholder group consisting of fishermen, net/gear manufacturers and scientific/gear specialists, partnered with staff from the North Carolina Division of Marine Fisheries (NCDMF) and North Carolina Sea Grant.

Results should minimize shrimp loss and maximize reduction of finfish bycatch. Promising gear configurations are to be brought back to the NCMFC for consideration for mandatory use in the shrimp trawl fishery.

Various gear combinations were tested against a control net that used a Florida Fish Eye bycatch reduction device (BRD), a federally-approved turtle excluder device (TED) and a 1 1/2-inch mesh stretch tailbag. Gear combinations tested include:

- Composite/square mesh panels,
- State and federal fisheyes,
- Minimum tailbag mesh size, and
- Reduced bar spacing in TED.

In the development of the final management strategies the NCMFC passed a motion at its February 2014 business meeting specifying the composition of the stakeholder workgroup and gear testing to be conducted. This was presented to the Shrimp FMP Advisory Committee (AC), as well as the NCMFC regional and standing advisory committees. In February 2015, the Shrimp FMP Amendment 1 and its rules were adopted by the NCMFC (see Appendix 1 for supporting motions).

Gear specific management strategies implemented by Amendment 1 not only required the development of the stakeholder group and gear testing, but also required fishermen to use either a T-90/square mesh tailbag or other applications of square mesh panel (e.g., skylight panel), reduced bar spacing in a TED, or another federal or state certified BRD in addition to existing TED and BRD requirements in all skimmer and otter trawls (Proclamation SH-2-2015, Appendix 4; Figure 1). To further address bycatch issues and provide fishermen more flexibility, the NCMFC also allowed the use of any federally certified BRD in all internal and offshore waters of NC. A maximum combined headrope length of 220 feet was also established in all internal coastal waters

that did not have existing maximum headrope requirements to put a cap on fleet capacity as a management tool.

### Industry Workgroup

The Shrimp Bycatch Reduction Industry Workgroup was formed in 2015. The workgroup met throughout the gear testing process to discuss results and plan for testing. A list of workgroup members is provided in Appendix 2.

Workgroup meeting summary:

- March 31, 2015 – Reviewed existing and previously completed BRD research and selected designs to be tested by the workgroup. Developed operating procedures and established a schedule and protocols for gear testing in 2015.
- Jan. 25, 2016 – Reviewed first year of testing and plan for the second year. Based on testing results, the workgroup further recommended that new BRD/gear configurations should have an acceptable shrimp loss between 3% to 5%, depending on the reduction in bycatch achieved.
- Jan. 9, 2017 – Reviewed results from the second round of testing and selected gears to be tested in 2017. After focusing on large vessels in estuarine waters the first two years, the workgroup added gear testing for small vessels and testing in the ocean in the third year of the study.
- Jan. 22, 2018 – Reviewed the data and findings from the third year of gear testing.
- April 4, 2018 – Reviewed results from the three years of testing and made recommendations for consideration by the NCMFC. Upon reviewing the results of gear testing, the workgroup noted that a higher range of shrimp loss beyond the 3% to 5% originally set would be acceptable if significant finfish bycatch reduction occurred.

NCDMF staff provided the NCMFC updates on the workgroup's efforts during the testing period. NCDMF staff presented the workgroup's recommendations to the NCMFC at its May 2018 business meeting.

### Industry Gear Testing

To evaluate the effectiveness of the various gear combinations selected by the workgroup, comparative tows were conducted aboard large commercial vessels (>46 ft) in 2015 and 2016; testing in 2017 also included smaller vessels (<45 ft) and in the ocean. Comparative tows consisted of paired net tests where a control net and an experimental net were fished simultaneously. Experimental nets were equipped with the candidate BRD or modification to be tested. Control nets for this project consisted of a typical commercial shrimp two-seam otter trawl with a Florida Fish Eye BRD (state certified), 4-inch bar spacing TED, and 1 1/2-inch stretched mesh tailbag. Headrope length was standardized for both control and experimental nets for each vessel. All experimental nets were calibrated prior to formal field trials to minimize potential net bias and all prototype testing following the National Oceanic and Atmospheric Administration (NOAA) BRD Testing Manual (NOAA 2008). A successful tow was defined as the control and experimental trawl fishing without an indication of problematic events (i.e., crab pots in net) occurring during the tow to impact or influence the fishing efficiency (catch) of one or both nets. Experimental and control nets were also switched from side to side to reduce the potential for side bias and ensure

an equal number of successful tows. To eliminate bias associated with the use of a try net (test net pulled for brief periods), the control and experimental nets were tested in the outside nets of the four-barrel (quad) rigs. Gear specification data were collected for both experimental and control nets and included headrope length, mesh size of wing and tailbag, TED type, TED bar spacing, BRD type, location, and duration (tow time). The catch from each net (experimental and control) were sampled by two NCDMF observers. After each paired tow, the entire catch was sampled and the total weight (kg) of each catch category was recorded. In 2015, only Penaeid shrimp and finfish were recorded; non-shrimp invertebrates, elasmobranchs (sharks/rays), and miscellaneous categories were added for the 2016 and 2017 testing.

Following the completion of each trip, all data were coded and entered into the NCDMF database. Tows were dropped from subsequent analyses if a problematic event (i.e., crab pots in net, hang) was experienced. Paired t-tests ( $\alpha = 0.05$ ) were used to determine whether the catches between the control and experimental nets were significantly different for each category (shrimp and bycatch species). While calibration tows were made prior to testing, some side bias was still assumed in testing. To account for this, test gears were switched between the sides of the vessel throughout testing with the goal of having an even number of tows with the experimental gear on each side of the vessel. When this was not achieved, analyses randomly picked tows so the comparisons would be made with an equal number of tows (with the control and experimental gear) on each side of the vessel. Observed weights were standardized to the target two-hour tow time to adjust for differences in tow times. In 2017, tow-times were standardized to one hour to accommodate the addition of small vessels. The average weight of each net (control and experimental) was computed for each gear and species combination along with the difference in average weight and percent change (percent reduction). A randomization procedure (Manly 2007) was also used to compare catches between control and experimental nets for each gear/species/net combination. The randomization test does not require the data to be normally distributed and does not require tows to be dropped from the analysis. In 2016 and 2017, exploratory analyses were performed to investigate tow side (port versus starboard), time of day (day versus night), and location (2017 only). The results of these analyses indicate that variation in bycatch catch rates is not always due to changes in gear alone; tow side, time of day, and spatial location may also play a role in influencing bycatch catch rates. Generalized linear modeling (GLM) was not used to adjust randomization catch values for potential biases and may differ from those reported in Brown et al. 2017. For a detailed description of the sampling methodology, gear parameters, and full data analysis see Brown et al. (2017, 2018).

## Results

A total of 267 comparative tows were made using nine experimental gears during the summer and fall in the Pamlico Sound in 2015 and 2016 (Figure 2). In 2017, a total of 120 comparative tows were made on four experimental gears during the summer and fall in the Pamlico Sound and the nearshore waters of the Atlantic Ocean (Figure 2). Only larger vessels (>46 ft) were used for testing in 2015 and 2016. Testing in 2017 also included smaller vessels (<45 ft). Approximately 98% of the tows (2015-2017) were available for analyses; problematic tows were excluded.

In 2015, only one gear met the 40% target reduction in finfish bycatch set by the NCMFC (Table 1). The double federal fisheye, 4-inch TED, and 1 7/8-inch tailbag gear combination was found to significantly reduce finfish bycatch by 40.8% based on the t-test results. The randomization test

found that finfish bycatch was reduced by 40.1% for this gear combination. While the other experimental gears tested in 2015 failed to meet the 40% target, many of the gears were found to reduce finfish bycatch while minimizing shrimp loss. The composite panel with fish spooker cone significantly reduced finfish bycatch by 25.8% (t-test) to 27.6% (randomization test). Tows made with a 3-inch TED, square mesh panel, and 1 7/8-inch tailbag significantly reduced finfish bycatch by 25.3% (t-test) to 27.5% (randomization test). T-test results indicated the mean weight of finfish bycatch was significantly reduced by 16.2% using a 3-inch TED and one state fisheye. Of all the gears tested by the workgroup in 2015, the Ricky BRD had the lowest observed reduction in finfish bycatch. Finfish reductions ranged from 4.5% (randomization test) to 6.6% (t-test). The mean weight of shrimp was not significantly different from the control net for all gears tested in 2015.

During the second year of testing, three out of four gears tested met or exceeded the 40% target reduction in finfish bycatch (Table 2). Tows made using a 4-inch TED, double federal fisheyes, and a 1 3/4-inch tailbag significantly reduced finfish bycatch by 54.0% (randomization test) to 57.2% (t-test) and had the greatest reduction in finfish bycatch of all the gears tested by the workgroup. Tows made with a 3-inch TED, double federal fisheyes, and 1 3/4-inch tailbag yielded the second highest reduction of the gear combinations tested, reducing finfish bycatch by 44.9% (t-test and randomization test). Finfish bycatch reductions were slightly lower in the fall using one state fisheye, the Virgil Potter BRD, and 1 3/4-inch tailbag gear combination. Finfish bycatch reductions ranged from 43.2% (t-test) to 44.3% (randomization test). While not significant, t-test results indicated the mean weight of shrimp was reduced by 5.5% for this gear combination. A similar gear combination tested in the summer using a slightly smaller mesh tailbag (1 1/2-inch), one state fisheye, and Virgil Potter BRD reduced finfish bycatch by 26.9% (t-test) to 28.5% (randomization test). The mean weight of non-shrimp invertebrates and elasmobranchs was not significantly different from the control net for all gears tested in 2016.

While none of the gear combinations tested in 2017 met the 40% target reduction for finfish bycatch (Table 3), the 3-inch TED, double state fisheye, and 1 5/8-inch tailbag did significantly reduce finfish bycatch in the ocean by 32.6% (t-test and randomization test) during summer testing. The mean weight (kg) of shrimp for this gear was also found to be significantly different from the control net, reducing the catch of shrimp by 6.8% (t-test). Testing the same gear combination in the ocean in the fall using a 3-inch TED, double state fisheye, and 1 5/8-inch tailbag did not significantly reduce finfish bycatch and shrimp loss almost tripled the acceptable range originally recommend by the workgroup. The t-test and randomization test did however indicate the catch of non-shrimp invertebrates and elasmobranchs were significantly reduced by 65.1% and 57.1%, respectfully for this gear combination. The 3-inch TED, single state fisheye, and 1 5/8-inch tailbag experimental gear combination significantly reduced finfish bycatch by 22.8% (t-test) in the summer in Pamlico Sound. However, the mean weights of the other species groups were not significantly different from the control net for this gear. Though not statistically significant, tows made using this gear combination also reduced the shrimp catch by 7.8% (t-test) to 9% (randomization test).

#### **IV. AUTHORITY**

§ 113-134. Rules

§ 113-173. Recreational Commercial Gear License

§ 113-182. Regulation of fishing and fisheries  
§ 113-182.1 Fishery Management Plans  
§ 113-221.1 Proclamations; emergency review  
§ 143B-289.52 Marine Fisheries Commission - powers and duties

15A NCAC 03H .0103 Proclamation Authority of Fisheries Director  
15A NCAC 03J .0104 Trawl Nets  
15A NCAC 03L .0101 Shrimp Harvest Restrictions  
15A NCAC 03L .0103 Prohibited Nets, Mesh Lengths and Areas

## **V. DISCUSSION**

Reducing bycatch in the shrimp trawl fishery and the development of gear configurations that maximize finfish reduction and minimize shrimp loss has been an ongoing task for the Division since the 1980s (NCDMF 2015). The 1992 Atlantic States Marine Fisheries Commission (ASMFC) Weakfish FMP recommended that states implement programs to reduce bycatch mortality of weakfish in the shrimp trawl fishery by 40% (ASMFC 1992). Following this recommendation, the NCDMF conducted a series of independent gear tests as well as tests in cooperation with the shrimp industry. Results from this testing lead to the development of new BRDs and gear modifications to reduce bycatch and North Carolina became the first state to require BRDs in shrimp trawls in 1992. Amendments 3 and 4 to the ASMFC Weakfish FMP later changed the certification requirement to demonstrate a 40% reduction in catch (by number) or a 50% reduction in bycatch mortality of weakfish (ASMFC 1996, 2002). In 2004, Addendum III to Amendment 4 of the ASMFC Weakfish FMP again changed the BRD requirements from a 40% reduction in weakfish by number to a 30% reduction by weight (ASMFC 2007). This change was made to complement the South Atlantic Fishery Management Council (SAFMC) Shrimp FMP and has allowed for more flexible testing and development of BRDs. With the adoption of Amendment 1 to the NC Shrimp FMP, the use of any federally certified BRD in all internal and offshore waters was approved as well as a recommendation to update testing protocols for state BRD certification (NCDMF 2015). These changes, as well as continued industry collaboration, should give fisheries managers more flexibility identifying, developing, and implementing new gears to reduce bycatch.

The use of minimum tailbag mesh regulations has been a common management strategy used by fisheries managers to reduce bycatch. As early as 1949, researchers in North Carolina have examined how larger mesh sizes in tailbags can reduce finfish bycatch in shrimp trawls (Roelofs 1950). Testing conducted by the NCDMF has also shown that larger tailbag mesh sizes and how they are hung (diamond vs. square) can reduce bycatch. Brown (2010) compared the catch rates of shrimp and bycatch in modified trawls with various tailbag mesh sizes in the Neuse River and Pamlico Sound. Experimental nets with 1 3/4-inch tailbags showed significant reductions in Atlantic croaker (16%) and spot (50%) as compared to the control net (standard 1 1/2-inch mesh tailbag); however, no significant difference in the catch of shrimp was detected between the control and experimental net. Experimental nets with a 2-inch tailbag (hung on the square) were found to have even greater reductions for Atlantic croaker (69%) and spot (82%). Results from the 2015-2017 industry field testing also showed that gears with larger tailbag mesh sizes had greater reductions in finfish bycatch than those constructed with smaller mesh tailbags. Of the four gear combinations that met or exceeded the 40% target reduction in finfish bycatch, three of those used



a 1 3/4-inch tailbag. Gear combinations using a 1 7/8-inch mesh tailbag were also found to significantly reduce finfish bycatch by 25.3% to 40.8% (randomization test data: 27.5% to 40.1%).

NOAA Fisheries has required the use of TEDs since 1992 to reduce the number of strandings and incidental takes of sea turtles (NCDMF 2015). TEDs have also been shown to reduce the bycatch of smaller finfish and invertebrates in both otter and skimmer trawls (Broome 2011; Price and Gearhart 2011). Currently, federal law mandates a 4-inch maximum TED bar spacing between grids. Broome et al. 2011, found that reduced TED grid spacing was very effective at reducing finfish bycatch while maintaining minimal shrimp loss. The authors also noted a noticeable reduction in large rays, sharks, jellyfish and horseshoe crabs in the 2-inch reduced grid TED. Of the gear combinations tested by the workgroup that met the 40% reduction in finfish bycatch, only one used a 3-inch TED. Results from both the t-test and randomization test indicated that tows made using double federal fisheyes, 1 3/4-inch tailbag, and 3-inch bar TED reduced finfish bycatch by 44.9% and only had a 4.9% loss of shrimp. Tows made with double state fisheyes, 1 5/8-inch mesh tailbag, and 3-inch TED bar spacing were also found to significantly reduce the catch of elasmobranchs by approximately 57% (t-test and randomization test) in the fall ocean fishery. Raborn et al. (2012) noted that the use of TEDs in the Gulf of Mexico Penaeid shrimp fishery reduced the catch of blacknose sharks by 94% and bonnethead sharks by 31%. The authors further note, that smaller coastal sharks, such as Atlantic sharpnose sharks, may be more effectively excluded by TEDs with reduced bar spacing. Both t-test and randomization tests indicated the catch of non-shrimp invertebrates was significantly reduced (by 65.1%) for tows made using double state fisheyes, 1 5/8-inch tailbag, and a 3-inch TED. When used in combination with larger tailbag mesh sizes (>1 1/2-inch), TEDs with reduced bar spacing appear to be very effective at reducing the bycatch of elasmobranchs and non-shrimp invertebrates in the ocean.

With the adoption of Amendment 1 the NCMFC also mandated the use of an additional federal or state certified BRD in all skimmer and otter trawls. Most fishermen have opted to use an additional state fisheye due to their low cost and ease of installation (K. Brown. NCDMF, personal communication). State fisheyes are a diamond shaped BRD (sometimes oval) that measure 5 1/2 inches by 6 1/2 inches, which provides an opening of approximately 20 square inches (Figure 3). The use of two state fisheyes provides approximately 40 total square inches of opening. Federal fisheyes must have a minimum opening of 36 square inches; however, all federal fisheyes tested by the workgroup were built with a margin of error that expanded the opening to 40 square inches (Figure 3). Thus, the use of two federal fisheyes provided approximately 80 square inches of opening. Of the four gear combinations that met or exceeded the 40% target reduction in finfish bycatch, three used double federal fisheyes. Gear combinations tested using double federal fisheyes were found to reduce finfish bycatch by 54.0% (randomization test) to 57.2% (t-test), whereas those using two state fisheyes only reduced finfish bycatch by as much as 32.6% (t-test and randomization test). The additional 40 square inches of opening gained using double federal fisheyes appears to provide greater escape of finfish than the use of double state fisheyes. Overall shrimp loss of gears using double federal fisheyes was comparable to losses of gears using double state fisheyes. However, tows made with double federal fisheyes with the addition of a float (Ricky BRD) had shrimp losses nearly double the industry recommendation and only minimal reduction in finfish bycatch. Gear combinations that incorporated two federal fisheyes and large mesh tailbags (1 3/4-inch or greater) appeared to provide the greatest reductions in finfish bycatch and

further allow fishermen to use the same gear in both state and federal waters within the Exclusive Economic Zone (EEZ).

While all the gear combinations tested resulted in reductions in finfish bycatch, it is hard to specify what element of the design made the largest contribution. Conversely, it is also hard to identify what design elements played the greatest role in minimizing shrimp loss. However, results from the industry field testing do indicate that small modifications in gear configuration such as TED bar spacing and tailbag mesh size can significantly impact gear performance. The addition of a 1 3/4-inch tailbag to the Virgil Potter BRD was found to reduce finfish bycatch an additional 15.8% (randomization test) to 16.3% (t-test) as compared to same gear rigged with a 1 1/2-inch tailbag. These reductions could be even greater with the addition of a 3-inch reduced grid TED. Nevertheless, the individual contribution of each modification cannot be quantified until further testing is done to test each specific design element of the gear combinations that met the 40% target reduction in finfish bycatch. Future testing should also incorporate design elements of gear combinations that did not meet the 40% target reduction in finfish bycatch. While several of those tested failed to meet the target, many obtained finfish bycatch reductions ranging from 25% to 30%. Thus, it is important to note that these reductions in bycatch are in addition to the 30% reduction in finfish bycatch mandated by the federal BRD certification process, and gears that met the NCMFC's 40% finfish bycatch reduction achieved nearly twice the federal requirements for reducing bycatch. Results from the industry gear testing should further encourage the use and development of new and innovative BRD designs.

Management decisions based on the results of the industry gear testing should not only consider which gear combinations had the greatest reduction in finfish bycatch, but should also consider vessel size as well as their contribution to the overall landings. In the last ten years (2007-2016), vessels greater than 55 feet made up roughly 30% of North Carolina's shrimp trawl fleet and landed 73% of the total shrimp landings (Table 4). In North Carolina's estuarine waters, roughly 67% of the vessels were 45 feet or less in length and harvested 17% of the total estuarine shrimp landings. Of the gear combinations that met the 40% reduction in finfish bycatch, vessel size ranged from 68 to 88 feet in the Pamlico Sound (Tables 1-2). Thus, it's important to note that observed finfish reductions obtained on larger vessels may not be directly applied to smaller vessels that operate in smaller waterbodies. The mandated use of untested gears on smaller boats could negatively impact gear performance and efficiency due to differences in tow times and haul-back practices. Furthermore, bycatch reductions achieved on smaller vessels should not be directly applied to larger vessels until further testing can be done. Future gear testing should include a wide variety of vessels across multiple areas throughout the state to determine how seasonal differences in species abundance, movement associated with life stage, and environmental factors influence gear performance.

All the necessary data do not currently exist to adequately quantify the overall reduction in bycatch gained by the mandated use of the gear combinations tested that met the 40% target reduction in finfish bycatch. Thus, management decisions should further consider the full extent of the social and economic factors that may impact the shrimp trawl fishery and its associated gears. Costs associated with purchasing and installing gear could become cost prohibitive making it no longer feasible for fishermen to continue in the fishery once their current gear configuration is obsolete; these costs could further be amplified for vessels using double and four-barrel rigs. To lessen these

costs, a phase-in period should be considered. Furthermore, the mandated use of untested gear combinations could further hinder the development and voluntary use of new BRDs. While gears such as the Ricky BRD did not meet the 40% target reduction in finfish, it is important to note that these gears were developed by fishermen and had promising results. Industry involvement is a key factor in not only the development and testing of new gears, but the overall acceptance of new gears. Murry et al. (1992) noted that shrimpers prefer to reduce bycatch because of the additional culling time, damage it causes to the quality of shrimp, and the extra weight in the tailbags which can reduce trawl door spread and fuel efficiency. Without acceptance from the public, the overall reduction in bycatch could be minimal if gear specific regulations are difficult to enforce. Regulations based on vessel length would be easier to enforce than those based on total combined headrope length. Vessel length can be determined from the Commercial Fishing Vessel Registration. Gear specific regulations should also consider user group (recreational, commercial) and gear type (otter trawl, skimmer trawl, crab trawl) in addition to vessel size. Recommendations from the industry workgroup on bycatch reduction in shrimp trawls that may be adopted by the NCMFC do not require an amendment and could be implemented by existing proclamation authority. Based on the motion passed at their February 2014 business meeting, the NCMFC may consider promising gear configurations that were tested by the industry workgroup for mandatory use in the shrimp trawl fishery. Management decisions based on industry collaboration, such as the work summarized in this paper, should provide further insight on solutions that limit bycatch while minimizing shrimp loss.

## **VI. THE FOUR GEAR COMBINATIONS THAT ACHEIVED AT LEAST A 40% REDUCTION IN FINFISH BYCATCH**

- 1) Double federal fisheyes, 1 7/8-inch tailbag, and 4-inch TED
  - + Significantly reduces finfish bycatch (t-test: -40.8%, randomization test: -40.1%)
  - + Net gain in shrimp observed; however, not significant (t-test: +1%, randomization test: +2.2%)
  - + Reduces culling time due to less bycatch
  - + Implements actions of Amendment 1 to the Shrimp FMP
  - Costs associated with purchasing and installing gear (+\$600 per net)
  - Untested on smaller vessels, skimmer trawls, and in the Atlantic Ocean
  
- 2) Double federal fisheyes, 1 3/4-inch tailbag, and 4-inch TED
  - + Significantly reduces finfish bycatch (t-test: -57.2%, randomization test: -54.0%)
  - + Reduces non-shrimp invertebrate bycatch; however, not significant (t-test: -15.7, randomization test: -4.9%,)
  - + Reduces culling time due to less bycatch
  - + Implements actions of Amendment 1 to the Shrimp FMP
  - Shrimp losses greater than 5%; however, not significant (t-test: -12.1%, randomization test: -16.2%)
  - Costs associated with purchasing and installing gear (+\$600 per net)
  - Untested on smaller vessels, skimmer trawls, and in the Atlantic Ocean
  
- 3) Double federal fisheyes, 1 3/4-inch tailbag, and 3-inch TED
  - + Significantly reduces finfish bycatch (t-test and randomization test: -44.9%)

- + Observed shrimp losses less than 5%; however, not significant (t-test and randomization test: -4.9%)
  - + Reduces non-shrimp invertebrate bycatch; however, not significant (t-test and randomization test: -13.3%)
  - + Reduces elasmobranch bycatch; however, not significant (t-test and randomization test: -18.6%)
  - + Potential reductions in debris and jellyfish
  - + Reduces culling time due to less bycatch
  - + Implements actions of Amendment 1 to the Shrimp FMP
  - Costs associated with purchasing and installing gear (+\$1,250 per net)
  - Potential fouling issues in areas and times of high grass concentrations
  - Untested on smaller vessels, skimmer trawls, and in the Atlantic Ocean
- 4) Single state fisheye, 1 3/4-inch tailbag, and Virgil Potter BRD
- + Significantly reduces finfish bycatch (t-test: -43.2%, randomization test: -44.3%)
  - + Reduces culling time due to less bycatch
  - + Implements actions of Amendment 1 to the Shrimp FMP
  - Costs associated with purchasing and installing gear (+\$800 per net)
  - Shrimp losses greater than 5%; however, not significant (t-test: -5.5%, randomization test: -5.8%)
  - Untested on smaller vessels, skimmer trawls, and in the Atlantic Ocean

## VII. RECOMMENDATION

### Shrimp Industry Bycatch Reduction Workgroup

- Does not want to go on record recommending a range of acceptable shrimp loss; if finfish bycatch reduction is significant, a larger range could be acceptable (beyond range used by workgroup of 3-5%).
- Does want to recommend continued collaborative bycatch reduction research, specifically continuance of the N.C. Shrimp Bycatch Reduction Industry Workgroup, requesting that funding from gear testing possibly come from surplus funds from increased license fees (i.e., Commercial Fishing Resources Fund). Industry continues to be willing to provide in-kind contributions.
- Does endorse for use on otter trawls fishing in inside waters (in areas where a combined headrope of 90-feet or greater is allowed as identified in the Shrimp FMP; Figure 4) the four combinations of bycatch reducing gears that met the target of 40% bycatch reduction, but specifically recommends:
- Use of the combination gear of double Federal fisheyes, 4-inch TED and 1 3/4-inch tailbag, again, in inside waters where an otter trawl with a combined head rope of 90-feet or greater is allowed. (Specific intent is not to have this change applied to other areas open to otter trawls, channel nets, and skimmer trawls until further bycatch reduction testing has been completed.)
- Recommends the N.C. Division of Marine Fisheries explores valid survey techniques to gather information on current bycatch reduction devices being used by industry.

## Summary of Additional Comments from Absentee Workgroup Members\*

- Some members gave blanket support.
- Would like consideration of a phase-in period.
- Had reservations on more than 5 percent shrimp loss.
- Support not setting arbitrary shrimp loss levels.
- Support for reduced bar spaced TED, but defer to those working affected areas.
- The double federal fisheyes and 1 3/4-inch tailbag produced desired goal and should not be a burden for affected boats.
- 1 3/4-inch tailbag not tested on smaller boats
  - Anecdotal testing showed shrimp loss on 21/25 and 16/20 count shrimp
- More testing on small vessels
  - Allow more time to find working combination for small vessels

*\*See Appendix 3 for complete correspondences received from absentee workgroup members on proposed recommendations.*

NCDMF Recommendation, none offered

## VIII. MANAGEMENT REVISIONS TO AMENDMENT 1 TO THE N.C. SHRIMP FMP

Amendment 1 to the North Carolina Shrimp FMP provides the adaptive management framework (see Appendix 1) for the changes in management proposed herein and titled as the May 2018 Revision. This document serves as the Revision to Amendment 1 to the N.C. Shrimp FMP and documents the supporting data and rationale of the NCMFC for the following changes in shrimp management under Amendment 1 to be implemented May 1, 2018, unless otherwise specified. All Revision management measures were implemented through Proclamation SH-3-2019 (Appendix 5).

### NCMFC Approved Management Revisions for Bycatch Reduction

- Continue the NC shrimp industry workgroup and explore funding options
- Require shrimp trawls, with the exception of skimmer trawls, fishing the inside waters where greater than 90-foot headrope length is required to use a gear combination that has been studied and achieves at least a 40 percent finfish bycatch reduction (to be implemented July 1, 2019)
- Following peer review of workgroup study, re-evaluate results and continue bycatch reduction study with industry workgroup
- Task the division to implement a survey to gather information on current bycatch reduction devices used by the industry
- Begin development of Amendment 2 to the Shrimp FMP

All other management strategies contained in Amendment 1 remain in force until another revision, supplement, or amendment to the North Carolina Shrimp FMP occurs.

## IX. REFERENCES CITED

- ASMFC (Atlantic State Marine Fisheries Commission). 1992. Weakfish Fishery Management Plan Amendment 1. ASMFC, Washington, D. C. Fishery Management Report No. 20. 69 p.
- ASMFC. 1996. Amendment 3 to the Interstate Fishery Management Plan for Weakfish. ASMFC, Washington, D. C. Fishery Management Report No. 27. 66 p.
- ASMFC. 2002. Amendment 4 to the Interstate Fishery Management Plan for Weakfish. ASMFC, Washington, D. C. Fishery Management Report No. 39. 101 p.
- ASMFC. 2007. Addendum III to Amendment 4 to the Interstate Fishery Management Plan for Weakfish. ASMFC, Washington, D. C. 6 p.
- Broome, J.D., Anderson, J.W., and D.W. Anderson. 2011. By-catch volume reduction through turtle excluder device (TED) reduced grid spacing. North Carolina Sea Grant Project # 10-FEG-03. 37 p.
- Brown, K.B. 2010. Compare catch rates of shrimp and bycatch of other species in standard (control) and modified (experimental) otter trawls in the Neuse River and Pamlico Sound, North Carolina Completion report for NOAA award no. NA08NMF474076 North Carolina Department of Environment and Natural Resources, Division of Marine Fisheries. 22 p.
- Brown, K.B., B. Price, L. Lee, S. Baker, and S. Mirabilio. 2017. An evaluation of bycatch reduction technologies in the North Carolina shrimp trawl fishery. North Carolina Department of Environment and Natural Resources, Division of Marine Fisheries, Morehead City, NC. 40 p.
- Brown, K.B., B. Price, L. Lee, S. Baker, and S. Mirabilio. 2018. Technical solutions to reduce bycatch in the North Carolina Shrimp Trawl Industry. North Carolina Department of Environment and Natural Resources, Division of Marine Fisheries, Morehead City, NC. 50 p.
- Manly, B. 2007. Randomization, bootstrap and Monte Carlo methods in biology, 3rd edition. Chapman & Hall/CRC, New York. 455 p.
- Murray, J.D., J.J. Baden, and R.A. Rulifson. 2011. Management considerations for by-catch in the North Carolina and Southeast Shrimp Fishery. *Fisheries*, 17:1, 21-26.
- NCDMF (North Carolina Division of Marine Fisheries). 2015. North Carolina Shrimp Fishery Management Plan, Amendment 1. North Carolina Department of Environment and Natural Resources, Division of Marine Fisheries, Morehead City, NC. 514 p.

NOAA (National Oceanic and Atmospheric Administration). 2008. Bycatch reduction device testing manual. National Marine Fisheries Service, Southeast Regional Office, St. Petersburg, FL. 42 p.

Raborn S.W., B.J. Gallaway, J.G. Cole, W.J. Gazey, and K.I. Andrews. 2012. Effects of turtle Excluder Devices (TEDs) on the bycatch of three small coastal sharks in the Gulf of Mexico penaeid shrimp fishery, *North American Journal of Fisheries Management*, 32(2): 333-345.

Roelofs, E.W. 1950. Observations of the capture of small fish by the shrimp trawls. Annual Report, Institute of Fisheries Research UNC, Morehead City, NC, pp 111-115.

Price, A.B., and J.L. Gearhart. 2011. Evaluations of turtle excluder device (TED) performance in the U.S. southeast Atlantic and Gulf of Mexico skimmer trawl fisheries. NOAA technical Memorandum NMFS-SEFSC-615. 15 p.

Prepared by: Chris Stewart  
[Chris.Stewart@ncdenr.gov](mailto:Chris.Stewart@ncdenr.gov)  
910-796-7370

Revised: July 18, 2018

**Table 1.** Results from the paired t-test and randomization test of the five experimental gears tested during 2015. Mean weight of catch data reported in kg. Values in bold indicate significant p-values (alpha = 0.05). Gears in grey met or exceeded the 40% reduction target for finfish bycatch.

Season / Waterbody	Vessel size (ft)	Gear	Tailb ag (in.)	TED (in.)	Species group	Control		Exp.		T-test		Control		Exp.		Randomization*	
						N	Mean	Mean	% Change	p-value	N	Mean	Mean	% Change	p-value		
Summer / Pamlico Sd.	68	Composite panel, spooker cone	1 1/2	4	Finfish	44	178.1	132.1	-25.8	< <b>0.001</b>	60	177.3	128.4	-27.6	< <b>0.001</b>		
					Shrimp	44	64.3	63.9	-0.7	0.754	60	67.3	65.2	-3.1	0.776		
Summer / Pamlico Sd.	75	Single state fisheye	1 1/2	3	Finfish	16	107.3	90.0	-16.2	<b>0.029</b>	19	112.8	89.8	-20.4	0.217		
					Shrimp	16	49.6	46.0	-7.4	0.078	19	48.2	45.5	-5.6	0.739		
Summer / Pamlico Sd.	75	Single state fisheye, square mesh panel	1 7/8	3	Finfish	40	104.8	78.2	-25.3	< <b>0.001</b>	51	102.3	74.1	-27.5	<b>0.007</b>		
					Shrimp	40	65.7	64.4	-1.9	0.309	51	67.3	65.2	-3.0	0.775		
Summer / Pamlico Sd.	88	Ricky BRD	1 1/2	4	Finfish	10	110.6	103.3	-6.6	0.503	15	100.0	95.5	-4.5	0.793		
					Shrimp	10	35.3	31.8	-9.9	0.449	15	35.4	33.3	-6.1	0.728		
Summer / Pamlico Sd.	88	Double federal fisheye	1 7/8	4	Finfish	25	90.0	53.3	-40.8	< <b>0.001</b>	32	88.3	52.9	-40.1	< <b>0.001</b>		
					Shrimp	25	61.3	61.9	1.0	0.778	32	60.6	61.9	2.2	0.862		

\* Generalized linear modeling (GLM) was not used to adjust randomization catch values for potential biases and may differ from those reported in Brown et al. 2017.



**Table 2.** Results from the paired t-test and randomization test of the five experimental gears tested during 2016. Mean weight of catch data reported in kg. Values in bold indicate significant p-values (alpha = 0.05). Gears in grey met or exceeded the 40% reduction target for finfish bycatch.

Season / Waterbody	Vessel size (ft)	Gear	Tailbag (in.)	TED (in.)	Species group	T-test				Randomization*					
						N	Control Mean	Exp. Mean	% Change	p-value	N	Control Mean	Exp. Mean	% Change	p-value
Summer/ Pamlico Sd.	68	Single state fisheye, Virgil Potter BRD	1 1/2	4	Finfish	30	146.3	106.9	-26.9	<b>&lt; 0.001</b>	33	149.4	106.9	-28.5	<b>0.005</b>
					Shrimp	30	62.6	68.8	9.9	<b>0.050</b>	33	61.8	67.0	8.5	0.696
					Invertebrates <sup>†</sup>	10	3.3	2.7	-18.8	0.384	33	1.0	0.8	-18.8	0.681
					Elasmobranchs	7	5.3	5.9	11.1	0.589	33	1.1	1.2	11.1	0.912
Summer / Pamlico Sd.	75	Double federal fisheye	1 3/4	4	Finfish	6	201.5	86.3	-57.2	<b>0.001</b>	23	164.5	75.6	-54.0	<b>&lt; 0.001</b>
					Shrimp	6	23.0	20.2	-12.1	0.215	23	28.1	23.6	-16.2	0.280
					Invertebrates <sup>†</sup>	6	7.2	6.1	-15.7	0.081	23	5.4	5.1	-4.9	0.833
					Elasmobranchs	6	1.8	2.6	45.8	0.509	23	2.1	2.5	18.8	0.573
Summer / Pamlico Sd.	75	Double federal fisheye	1 3/4	3	Finfish	30	115.4	63.6	-44.9	<b>&lt; 0.001</b>	30	115.4	63.6	-44.9	<b>0.007</b>
					Shrimp	30	27.0	25.7	-4.9	0.435	30	27.0	25.7	-4.9	0.706
					Invertebrates <sup>†</sup>	30	2.1	1.8	-13.3	0.418	30	2.1	1.8	-13.3	0.601
					Elasmobranchs	27	1.8	1.4	-18.6	0.404	30	1.6	1.3	-18.6	0.568
Fall / Pamlico Sd.	68	Single state fisheye, Virgil Potter BRD	1 3/4	4	Finfish	20	189.0	107.0	-43.2	<b>&lt; 0.001</b>	25	172.3	96.1	-44.3	<b>0.001</b>
					Shrimp	20	33.1	31.3	-5.5	0.055	25	31.3	29.5	-5.8	0.691
					Invertebrates <sup>†</sup>	25	0.0	0.0	n/a	n/a	25	0.0	0.0	n/a	n/a
					Elasmobranchs	25	0.0	0.1	n/a	n/a	25	0.0	0.0	n/a	n/a

\* *Generalized linear modeling (GLM) was not used to adjust randomization catch values for potential biases and may differ from those reported in Brown et al. 2017.*

<sup>†</sup> *Non-shrimp invertebrates*

**Table 3.** Results from the paired t-test and randomization test of the five experimental gears tested during 2017. Mean weight of catch data reported in kg. Values in bold indicate significant p-values (alpha = 0.05). Gears in grey met or exceeded the 40% reduction target for finfish bycatch.

Season / Waterbody	Vessel size (ft)	Gear	Tailbag (in.)	TED (in.)	Species group	T-test				Control		Exp.		Randomization**	
						N	Mean	Mean	% Change	p-value	N	Mean	Mean	% Change	p-value
Summer / Pamlico Sd.	44	Single state fisheye	1 1/2	3	Finfish	*	*	*	*	*	5	12.3	12.9	5.1	0.732
					Shrimp	*	*	*	*	*	5	18.7	17.3	-7.8	0.827
					Invertebrates <sup>†</sup>	*	*	*	*	*	5	4.9	6.8	38.8	0.281
					Elasmobranchs	*	*	*	*	*	4	0.2	0.4	75.0	0.487
Summer / Pamlico Sd.	40	Single state fisheye	1 5/8	3	Finfish	20	34.6	26.7	-22.8	<b>0.019</b>	22	34.9	27.8	-20.4	0.341
					Shrimp	20	12.1	11.2	-7.8	0.294	22	11.6	10.6	-9.0	0.556
					Invertebrates <sup>†</sup>	18	2.3	2.1	-6.1	0.692	22	2.1	2.1	-0.4	0.993
					Elasmobranchs	*	*	*	*	*	3	0.3	0.1	-80.0	0.397
Summer / Ocean	40	Double state fisheye	1 5/8	3	Finfish	30	146.0	98.5	-32.6	<b>&lt; 0.001</b>	30	146.0	98.5	-32.6	<b>0.002</b>
					Shrimp	30	2.9	2.7	-6.8	<b>0.039</b>	30	2.9	2.7	-6.6	0.598
					Invertebrates <sup>†</sup>	30	17.2	15.9	-7.6	0.086	30	17.2	15.9	-7.6	0.505
					Elasmobranchs	29	3.0	2.5	-16.3	0.184	30	2.9	2.4	-16.7	0.425
Fall / Ocean	35	Double state fisheye	1 5/8	3	Finfish	30	57.5	54.9	-4.6	0.670	30	57.5	54.9	-4.6	0.890
					Shrimp	30	9.8	8.3	-14.9	<b>&lt; 0.001</b>	30	9.8	8.3	-14.8	0.365
					Invertebrates <sup>†</sup>	30	8.2	2.9	-65.1	<b>0.001</b>	30	8.2	2.9	-65.1	<b>&lt; 0.001</b>
					Elasmobranchs	28	4.4	1.9	-57.1	<b>0.009</b>	29	4.3	1.8	-57.3	<b>0.014</b>
Fall / Ocean	60	Double federal fisheye	1 5/8	3	Finfish	30	75.6	97.7	29.3	0.204	30	75.6	97.7	29.3	0.250
					Shrimp	30	17.3	15.7	-9.0	<b>0.002</b>	30	17.3	15.1	-12.5	0.234
					Invertebrates <sup>†</sup>	25	2.2	2.7	21.9	0.276	30	2.3	2.9	25.1	0.455
					Elasmobranchs	15	1.3	1.0	-24.3	0.271	28	0.9	0.7	-24.5	0.360

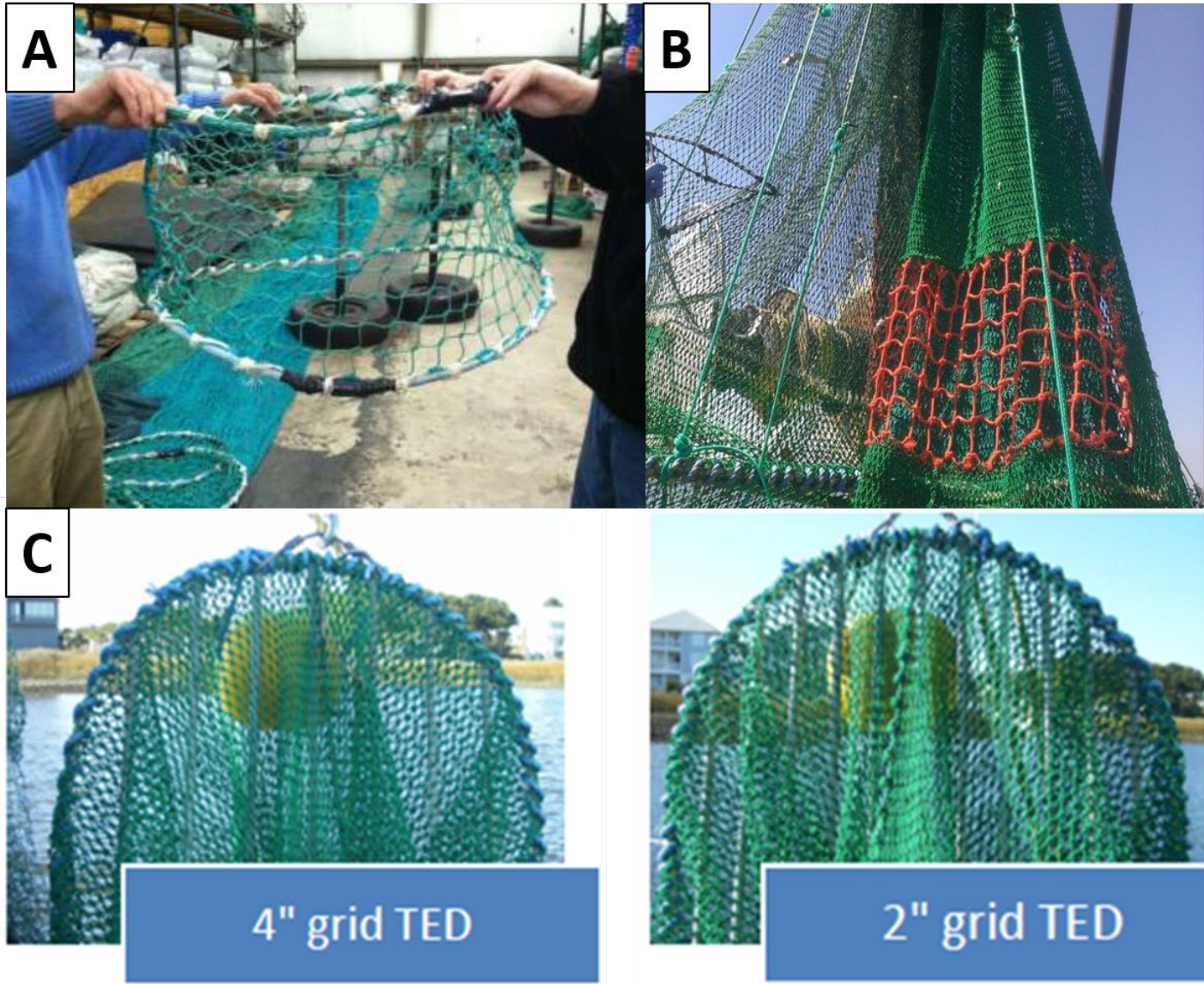
\* Tows were dropped from analysis due to the low number of matched pairs.

\*\* Generalized linear modeling (GLM) was not used to adjust randomization catch values for potential biases.

† Non-shrimp invertebrates

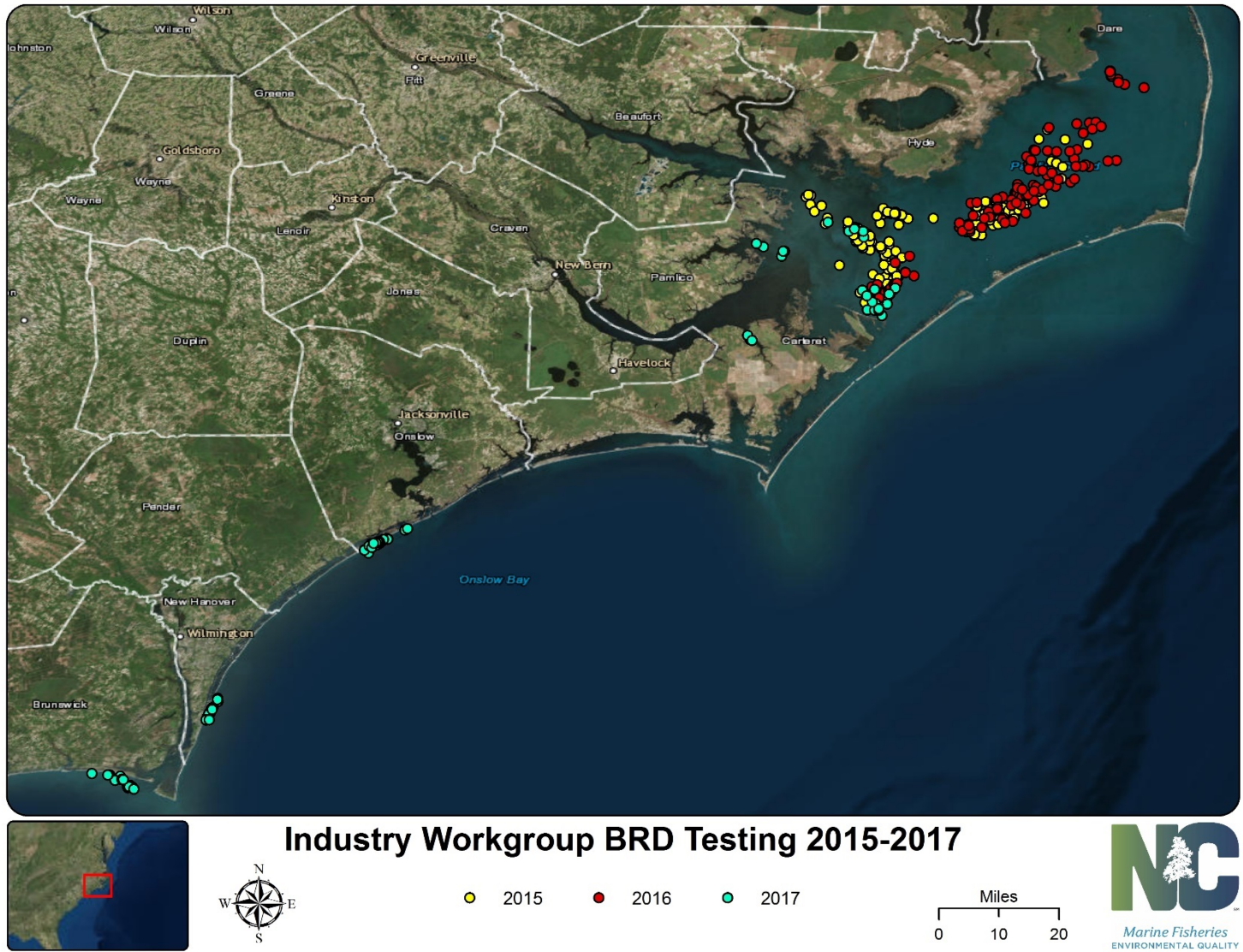
**Table 4.** North Carolina commercial shrimp trawl landings (all species) by vessel length and waterbody, 2007-2016 (NC Trip Ticket Program).

Waterbody	Vessel length		Vessels (10-year)		Trips (10-year)			Landings (10-year)		
	(Feet)	(Total number)	(% Total)	(Avg.)	(Total number)	(% Total)	(Avg.)	(Total number)	(% Total)	(Avg.)
Estuarine	0-15	99	2.6	10	294	0.7	29	74,368	0.1	7,437
	16 to 30	1,648	43.9	165	16,996	42.1	1,700	3,036,958	5.8	303,696
	31 to 45	765	20.4	77	10,597	26.3	1,060	5,839,690	11.2	583,969
	46 to 55	287	7.6	29	3,187	7.9	319	4,728,222	9.1	472,822
	> 55	956	25.5	96	9,275	23	928	38,563,295	73.8	3,856,329
State Ocean (0-3 mi)	0-15	9	0.7	2	21	0.1	4	30,802	0.2	5,134
	16 to 30	265	21	27	3,194	18.3	319	620,296	4.2	62,030
	31 to 45	292	23.2	29	4,640	26.6	464	1,708,624	11.6	170,862
	46 to 55	174	13.8	17	3,874	22.2	387	1,990,624	13.6	199,062
	> 55	519	41.2	52	5,721	32.8	572	10,333,660	70.4	1,033,366
Federal Ocean (3-200 mi)	0-15	3	2.5	3	5	1.6	5	1,289	0.1	1,289
	16 to 30	5	4.1	1	17	5.4	4	2,518	0.2	629
	31 to 45	13	10.7	2	31	9.9	5	11,109	1.1	1,852
	46 to 55	14	11.6	2	43	13.7	7	39,582	3.9	6,597
	> 55	86	71.1	10	217	69.3	24	968,016	94.7	107,557
Total (all waters)	0-15	111	2.2	7	320	0.6	525	106,459	0.2	6,262
	16 to 30	1,918	37.4	80	20,207	34.8	19	3,659,771	5.4	152,490
	31 to 45	1,070	20.8	41	15,268	26.3	842	7,559,424	11.1	290,747
	46 to 55	475	9.3	18	7,104	12.2	587	6,758,428	9.9	259,940
	> 55	1,561	30.4	54	15,213	26.2	273	49,864,971	73.4	1,719,482



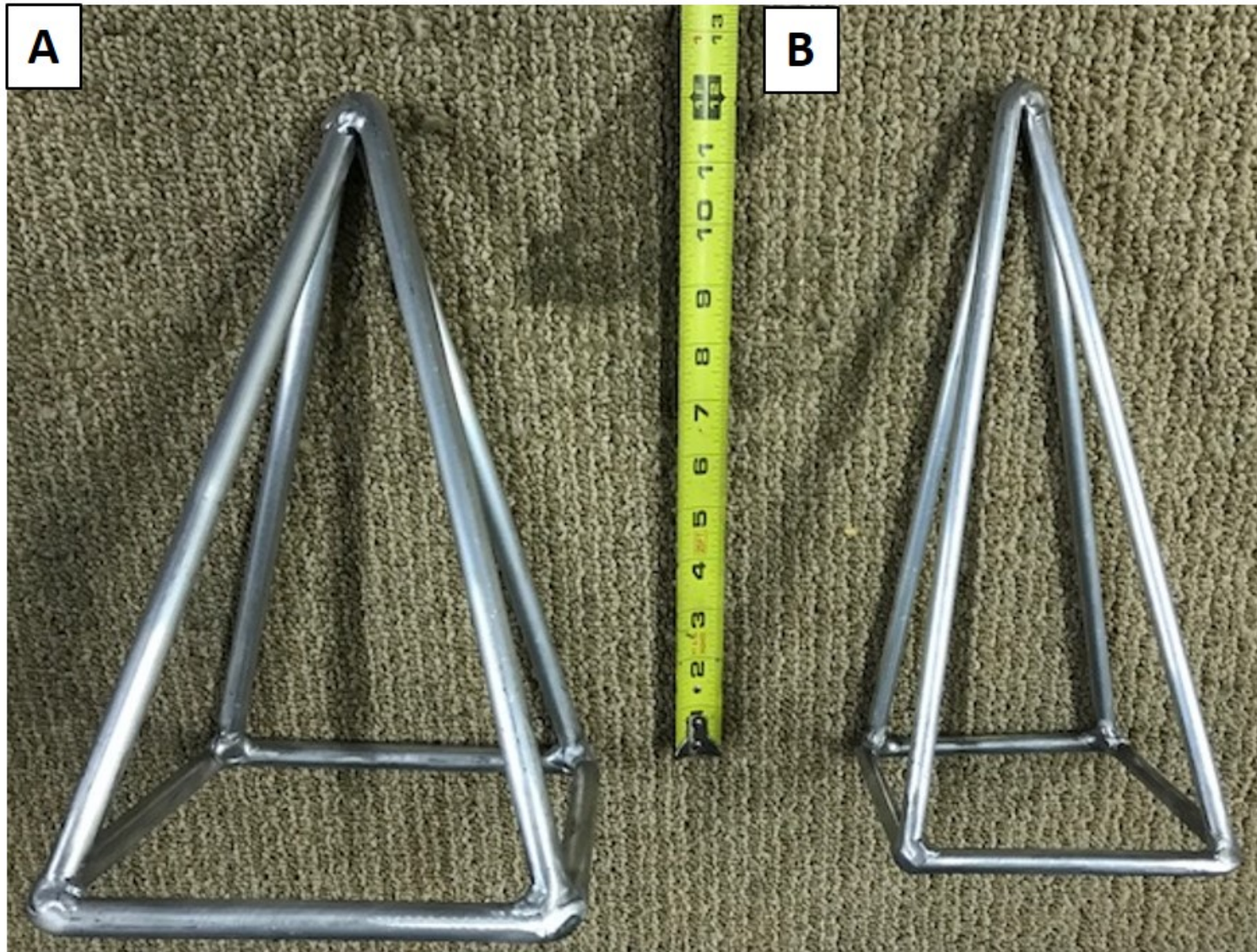
**Figure 1.** Newly approved BRDs as part of Amendment 1 to the NC Shrimp FMP: A) T-90 BRD, B) square mesh panel (skylight panel), and C) reduced bar spacing turtle excluder device (2-inch grid TED).





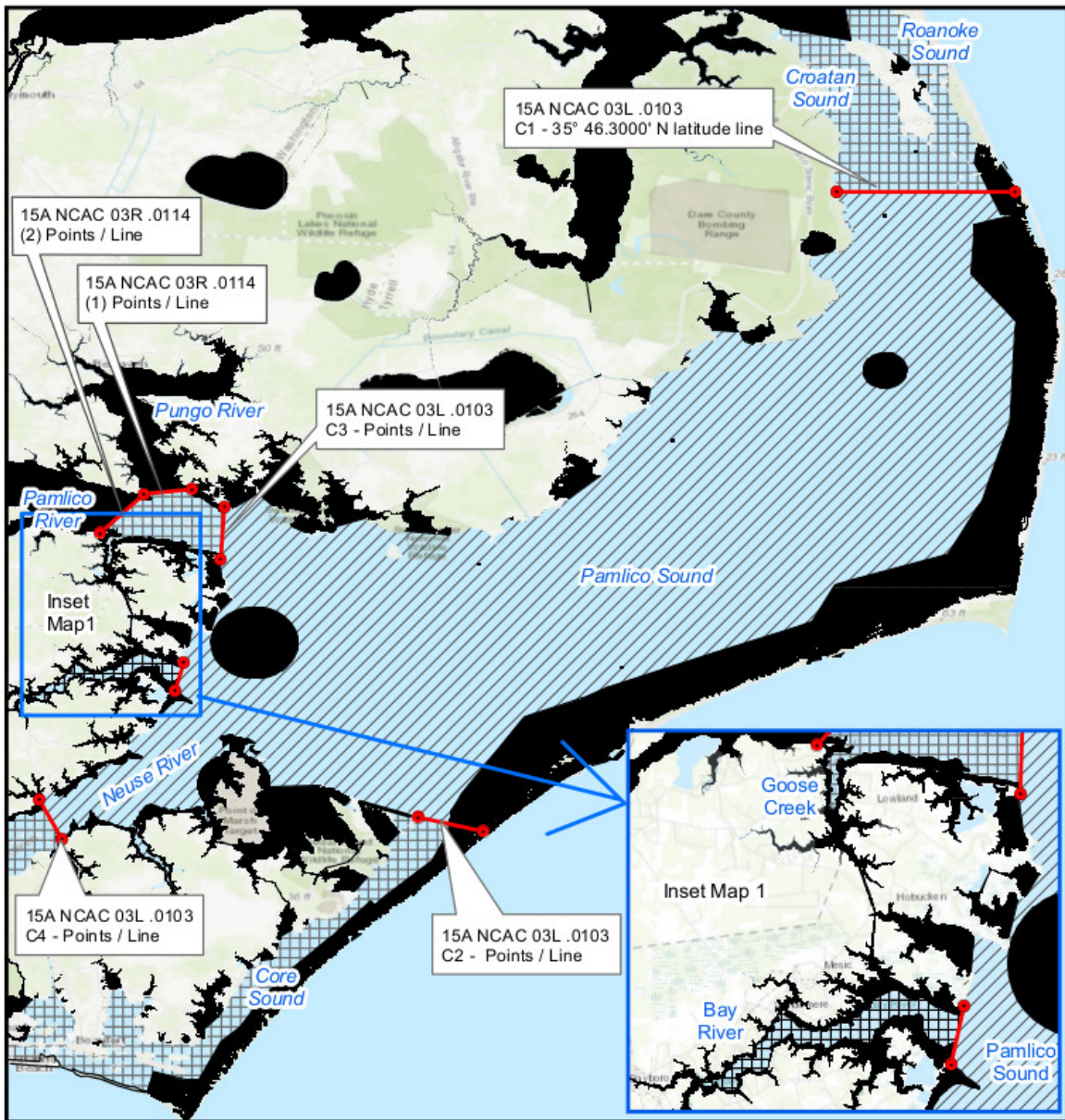
**Figure 2.** Location of Shrimp Bycatch Reduction Industry Workgroup shrimp trawl gear testing (all gears), 2015-2017.





**Figure 3.** Federal fisheye BRD (A) compared to state fisheye BRD (B).





Prohibited and allowed areas for shrimp trawling

**Figure 4.** Location of area affected (combined headrope of 220 ft or greater prohibited) by proposed recommendations from the Shrimp Bycatch Reduction Industry Workgroup.

**Appendix 1.** MFC motions for Amendment 1 to the North Carolina Shrimp FMP to address bycatch.

In November 2013, prior to approving Amendment 1 for public comment the NCMFC passed a motion to:

*Motion to add a recommendation to the draft Shrimp Fishery Management Plan Amendment 1 for a stakeholder group to initiate a three-year study testing minimum tailbag mesh T-90 (square mesh) panels, skylight panels, reduced bar spacing in turtle excluder devices and any other new methods of reducing unwanted finfish bycatch to achieve a minimum of a 40 percent reduction by weight compared to a control net with a Florida fish excluder, a federally approved turtle excluder device, and 1 1/2 inch mesh tailbag. The stakeholder group should partner with the Division of Marine Fisheries and N.C. Sea Grant to help secure funding for the study. If the target of a 40 percent reduction by weight in finfish is not achieved, further restrictions will be placed on the shrimp trawl industry to achieve the 40 percent reduction by weight. Those restrictions will be reviewed and discussed at that time.*

Based on this motion management options examined in the FMP were separated into: 1) gear modifications, 2) effort management, 3) area restrictions, and 4) the use of other fishing gears. For each of these management options, issue papers were developed and presented to the Shrimp FMP Advisory Committee (AC), as well as the regional and standing advisory committees. Gear modifications evaluated included: tailbag mesh size, Turtle Excluder Devices (TEDs) with reduced bar spacing, T-90 tailbags, and Skylight Panels (Figure 1).

In February 2014, prior to the approval of the draft Shrimp FMP Amendment 1 for review by the Secretary of the Department of Environment and Natural Resources and the Joint Legislative Commission on Governmental Operations, the NCMFC passed a motion that became the final management strategy in Amendment 1 to address bycatch:

*Motion to convene a stakeholder group to initiate industry testing of minimum tailbag mesh size, T-90 panels, skylight panels, and reduced bar spacing in turtle excluder devices to reduce bycatch to the extent practicable with a 40 percent target reduction. Upon securing funding, testing in the ocean and internal waters will consist of three years of data using test nets compared to a control net with a Florida Fish Eye, a federally-approved turtle excluder device and a 1.5-inch mesh tailbag. Results should minimize shrimp loss and maximize reduction of bycatch of finfish. Promising configurations will be brought back to the Marine Fisheries Commission for consideration for mandatory use. The stakeholder group may be partnered with the Division of Marine Fisheries and Sea Grant. Members should consist of fishermen, net/gear manufacturers and scientific/gear specialists.*

The commission gave its final approval of the Shrimp Fishery Management Plan Amendment 1 and associated rules Feb. 19, 2015 and implementation of the rules came into effect May 1, 2015. Gear specific management strategies from Amendment 1 not only required the development of the stakeholder group and gear testing, but also required fishermen to use either a T-90/square mesh tailbag or other applications of square mesh panel (e.g., skylight panel), reduced bar spacing in a TED, or another federal or state certified bycatch reduction device (BRD) in addition to existing



TED and BRD requirements in all skimmer and otter trawls (Proclamation SH-2-2015, Appendix 4; Figure 1).

**Appendix 2.** List of industry workgroup members, collaborators, and guest presenters.

Workgroup members:

Steve Parrish, net maker, Supply (passed, replaced by Douglas Todd)  
Kenny Midget, net maker, Wanchese  
Brent Fulcher, fish house owner/industry leader, New Bern  
Clyde Potter, fishermen, Hobucken  
Stevie Davis, fishermen, Sneads Ferry  
Clyde Phillips, fishermen, Swansboro  
Kenny Rustick, fishermen (skimmer), Gloucester  
John Broome, fishermen, Wilmington  
Virgil Potter, net maker, Bayboro  
Douglas Todd, fishermen, Supply (replaced Steve Parrish)  
Gordon Winfree, net maker, Shallotte  
Mikey Daniels, industry leader/fish house owner (previously), fishermen, Wanchese  
David Jarvis, fishermen, Bear Creek (added in 2018, tested gear in 2017)  
Robbie Metcalf, fishermen, Carolina Beach (added in 2018, tested gear in 2017)

Collaborators:

Kevin Brown, NCDMF  
Laura Lee, NCDMF  
Blake Price, NOAA-HSU  
Scott Baker, N.C. Sea Grant  
Sara Mirabilio, N.C. Sea Grant

Guest Presenters:

Pingguo He, U-Mass Dartmouth  
Frank Helies, GSAF  
Dan Foster, NOAA-HSU  
Gary Graham, Texas Sea Grant  
Steve Eayrs, GMRI

**Appendix 3.** Comments from absentee workgroup members on proposed recommendations.

Robbie Metcalf verbal communication 4/18/18:

- Supported all of the recommendations, but has some concern with any shrimp loss over 5%.
- He supports continuing the workgroup and gear testing and improving the gear survey.
- He always wants to make things better for the industry and what's best for the fishery.

Clyde Phillips phone conversation 4/19/18:

- Supported a phase in period.

David Jarvis phone conversation 4/19/18:

- Does not want to go on record recommending a range of acceptable shrimp loss; if finfish bycatch reduction is significant, a larger range could be acceptable (beyond range used by workgroup of 3%-5%).
  - Comments: Supportive, even 10% is acceptable if finfish loss is significant.
- Does want to recommend continued collaborative bycatch reduction research, specifically continuance of the N.C. Shrimp Bycatch Reduction Industry Workgroup, requesting that funding from gear testing possibly come from surplus funds from increased license fees (i.e., Commercial Fishing Resources Fund). Industry continues to be willing to provide in-kind contributions.
  - Comments: Fully supportive, willing to offer his vessel for continued testing.
- Does endorse for use on otter trawls fishing in inside waters (in areas where a combined head rope of 90-feet or greater is allowed as identified in the Shrimp FMP) the four combinations of bycatch reducing gears that met the target of 40% bycatch reduction, but specifically recommends:
  - Comments: Supportive with some reservations because these gears haven't been tested on small boats. Doesn't believe it will be a burden on the industry.
- Use of the combination gear of double Federal fisheyes, 4-inch TED and 1 ¾-inch tailbag, again, in inside waters where an otter trawl with a combined head rope of 90-feet or greater is allowed. (Specific intent is not to have this change applied to other areas open to otter trawls, channel nets, and skimmer trawls until further bycatch reduction testing has been completed.)
  - Comments: Supportive with some reservations because these gears haven't been tested on small boats. Doesn't believe it will be a burden on the industry.
- Recommends the N.C. Division of Marine Fisheries explores valid survey techniques to gather information on current bycatch reduction devices being used by industry.
  - Comments: Supports as long as they are valid techniques.

14 Apr 18

To: Kevin Brown

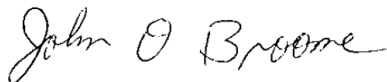
RE: Industry Workgroup Draft Recommendation to the Marine Fisheries Commission

Kevin: The recommendations set forth in the Memorandum dated 6 Apr 2018 seem very logical proposals based on the testing results thus far.

○ I totally agree that a range of acceptable shrimp loss should not arbitrarily be set. Any acceptable shrimp loss should be a function of the BRD's efficiency.

○ I work in the ocean off New Hanover County and Brunswick County and I have very little knowledge of the working conditions in Pamlico Sound. After conducting research with a FRG through N.C. Sea Grant (2" reduced spaced TED vrs. 4" spaced TED), I have been using 2" reduced spaced TED's as BRD's. Because of different conditions, such as large quantities of moss, a reduced spaced TED might not be the best BRD for Pamlico Sound or other areas. Because of this, I would like to defer to the boat owners that this proposal would affect.

○ The double Federal fisheye and 1 ¾ -inch tail bag produced the desired goal and should not be a burden for the boats affected.

A handwritten signature in cursive script that reads "John D. Broome".

John D. Broome

April 18, 2018.


Dear Marine Fisheries Commissioner,

My name is Kenny Rustick. I am a commercial fisherman from Carteret County, North Carolina and I serve on the Shrimp Industry Work Group. I was unable to attend the group's last meeting on April 4<sup>th</sup>, 2018 due to a prior surgery. I have been informed that several recommendations were voted on to pass onto the commission at it's May meeting.

I know one of the recommendations was for a 1 3/4" mesh tail bag. While the 1 3/4" mesh tail bag combined with other byrds showed a sizable reduction for the larger boats, it was never tested on the smaller boats like mine. I have tried this size tail bag before in the ocean on my boat and I noticed shrimp loss on 21/25 and 16/20 count shrimp. There were shrimp hanging out of the meshes on the tail bags when I would retrieve the trawls. I changed one tail bag to a 1 1/2" mesh and did not notice shrimp hanging out of the tail bag, and the 1 1/2" tail bag produced more shrimp.

Although this was by no means a scientific study, the 1 3/4" bags were a set of tail bags on a set of nets and turtle excluders I purchased. I tell you this because I believe we can reduce bycatch and do it with a minimal shrimp loss. I do believe we need more testing on the small boats. We could possibly try 1 5/8" and different byrd combinations. I have always found that what works for someone else might not work for me. So please give us some more time to find a combination of byrds that we know works for the small class boats.

Thank you for your time,

  
Kenny Rustick

**Brown, Kevin**

---

**From:** DOUGLAS TODD <dtodd@atmc.net>  
**Sent:** Thursday, April 19, 2018 2:02 PM  
**To:** Brown, Kevin  
**Subject:** [External] Bycatch

CAUTION: External email. Do not click links or open attachments unless verified. Send all suspicious email as an attachment to Report Spam.

Kevin the only comment that I have got back is some of the them want to know if the one fisheye with the 3-inch or less TED is still going to be approved to be used. The rest on the inform they were good with. Thanks Douglas Todd

**Brown, Kevin**

---

**From:** stevie <steviedavis134@hotmail.com>  
**Sent:** Thursday, April 19, 2018 3:22 PM  
**To:** Brown, Kevin  
**Subject:** [External] Recommendations

CAUTION: External email. Do not click links or open attachments unless verified. Send all suspicious email as an attachment to Report Spam.<mailto:report.spam@nc.gov>

I , Stevie Davis, support each of the recommendations the workgroup is proposing to the Marine Fisheries Commission  
Stevie Davis  
04/18/2018

Sent from my iPhone

**Brown, Kevin**

---

**From:** gordonsnet <gordonsnet@atmc.net>  
**Sent:** Thursday, April 19, 2018 5:52 PM  
**To:** Brown, Kevin  
**Subject:** [External] Industry Workgroup Draft Recommendation to the Marine Fisheries Commission

CAUTION: External email. Do not click links or open attachments unless verified. Send all suspicious email as an attachment to Report Spam.

I, Gordon Winfree, owner Gordons' Networks Inc. agree with the draft recommendations to the Marine Fisheries Commission listed in the memorandum.

Sent from Mail for Windows 10

**PROCLAMATION**

**RE: SHRIMP TRAWL BRD REQUIREMENTS**

Dr. Louis B. Daniel III, Director, Division of Marine Fisheries, hereby announces that effective at 12:01 A.M. Monday, June 1, 2015 the following restrictions apply to shrimp trawls (otter and skimmer trawls):

I. **GEAR RESTRICTIONS:**

It is unlawful for a person to use a shrimp trawl in coastal fishing waters without an authorized North Carolina Division of Marine Fisheries (NCDMF) Bycatch Reduction Device(s) (BRD) properly installed and operational in the cod end of EACH net as outlined below. Authorized NCDMF BRDs include:

**A. Florida Fish Excluder (FFE) (Figure 1 and Table 1):**

1. Description: Cone-shaped rigid frame constructed from aluminum, steel, or stainless steel round bar or tubing which is inserted into the cod end to form an escape opening. Minimum construction and installation requirements stated below.
2. The FFE shall be installed on the outside of the trawl. The webbing of the trawl attached to the FFE cannot cover more than 50% of the FFE.
3. The escapement opening of the FFE shall be diamond in shape and shall remain unobstructed at all times. Diamond shaped FFE shall measure at least 5 1/2 inches x 6 1/2 inches or 6 inches x 6 inches, inside diameter (see Figure 1).
4. Placement of the apex (narrow end) of the FFE shall be toward the headrope of the trawl (forward).
5. A FFE shall have at least three (3) legs and no more than four (4) legs and measure at least 12 inches in length (see Figure 1).
6. The opening of the FFE shall be installed on the outside of the cod end of the trawl no further forward than 65% of the functional cod end length measured from the cod end tie-off rings (Table 1).
7. The center of the FFE escapement opening shall be installed no more than 19 meshes from the top centerline of the cod end.
8. A FFE shall be constructed from aluminum, steel, or stainless steel round bar or tubing.

## **B. Fisheye (Figures 2 and 3):**

1. Description: The Fisheye BRD is a cone-shaped rigid frame constructed from aluminum or steel rod of at least  $\frac{1}{4}$  inch (6.35 mm) diameter, which is inserted into the cod end to form an escape opening. Minimum construction and installation requirements stated below.
2. The Fisheye has a minimum escape opening dimension of 5 inches (12.7 cm) and a minimum total escape opening area of  $36 \text{ in}^2$  ( $91.4 \text{ cm}^2$ ) [inside dimensions, not bar lengths] (Figure 2 and 3).
3. The Fisheye shall be installed on the outside of the trawl. The webbing of the trawl attached to the Fisheye cannot cover more than 50% of the Fisheye.
4. When the Fisheye BRD is installed, no part of the lazy line attachment system (i.e., any mechanism, such as elephant ears or choker straps, used to attach the lazy line to the cod end) may overlap the Fisheye escape opening when the Fisheye is installed aft of the attachment point of the cod end retrieval system. The escapement opening of the Fisheye BRD shall remain unobstructed at all times.
5. The Fisheye BRD must be installed at the top center of the cod end of the trawl to create an escape opening in the trawl facing the direction of the mouth of the trawl no further forward than 11 ft (3.4 m) from the cod end tie-off rings.
6. Placement of the apex (narrow end) of the Fisheye shall be toward the headrope of the trawl (forward).

## **C. Gulf Fisheye (Figures 2, 3, and 4):**

1. Description: The Gulf Fisheye is a cone-shaped rigid frame constructed from aluminum or steel rod of at least  $\frac{1}{4}$  inch (6.35 mm) diameter, which is inserted into the top center of the cod end, and is offset not more than 15 meshes perpendicular to the top center of the cod end to form an escape opening. Minimum construction and installation requirements stated below.
2. The Gulf Fisheye has a minimum escape opening dimension of 5 inches (12.7 cm) and a minimum total escape opening area of  $36 \text{ in}^2$  ( $91.4 \text{ cm}^2$ ) [inside dimensions, not bar lengths] (Figure 2 and 3).
3. The Gulf Fisheye shall be installed on the outside of the trawl. The webbing of the trawl attached to the Gulf Fisheye cannot cover more than 50% of the Fisheye.
4. The Gulf Fisheye BRD must be installed in the cod end of the trawl to create an escape opening in the trawl, facing in the direction of the mouth of the trawl, no less than 8.5 ft (2.59 m) and no further forward than 12.5 ft (3.81 m) from the cod end tie-off rings, and may be offset no more than 15 meshes perpendicular to the top center of the cod end (Figure 4).

5. When the Gulf Fisheye BRD is installed, no part of the lazy line attachment system (i.e., any mechanism, such as elephant ears or choker straps, used to attach the lazy line to the cod end) may overlap the Fisheye escape opening when the Fisheye is installed aft of the attachment point of the cod end retrieval system. The escapement opening of the Gulf Fisheye shall remain unobstructed at all times.
6. Placement of the apex (narrow end) of the Gulf Fisheye shall be toward the headrope of the trawl (forward).

**D. Eight (8) inch PVC "Sea Eagle" Fish Excluder (Figure 5 and Table 2):**

1. Description: The "Sea Eagle" Fish Excluder is a cone-shaped device similar to the Florida Fish Excluder and is constructed out of PVC pipe and has a trap door that is designed to close on haul back to prevent escapement of shrimp. The device is inserted into the cod end to form an escapement opening. Minimum construction and installation requirements stated below.
2. Placement of the apex (narrow end) of the "Sea Eagle" shall face the cod end of the trawl (aft).
3. The opening of the "Sea Eagle" shall be eight (8) inches in diameter and installed in the cod end of the trawl no further forward than 38% of the functional cod end length from the cod end tie-off rings (Table 2).
4. The center of the "Sea Eagle" escapement opening shall be installed on either side of the cod end between 0 and 15 meshes from the top centerline of the cod end.
5. The escapement opening of the "Sea Eagle" shall be unobstructed (the escapement flap shall be free to move and a fish retention grate shall not be present).

**E. General Eight (8) Inch and Ten (10) Inch Large Mesh and Extended Mesh Funnel BRD (Figures 6, 7, 8, 9, and 10):**

1. Description: Devices consist of a funnel of small mesh netting within a cylinder of large mesh netting, held open by one semi-rigid hoop, and are installed in the trawl net behind a National Marine Fisheries Service (NMFS) certified Turtle Excluder Device (TED). One side of the funnel is extended vertically to provide passage for shrimp to the cod end and to create an area of reduced water flow to allow for fish escapement through the larger mesh outer netting. Minimum construction and installation requirements stated below.
2. The small mesh funnel and large mesh section shall be positioned within extension sections constructed of 1 5/8 inch stretched mesh # 30 nylon twine. The extension section shall be 120 meshes in circumference. The extension section in front of the large mesh section shall be 6 1/2 meshes long, and the extension section behind the large mesh section shall be 23 meshes long.
3. The small mesh funnel shall be constructed from four (4) pieces of 1 1/2 inch stretched mesh, size # 24 twine or larger, depth stretched and heat set polyethylene webbing.



4. The small mesh funnel shall have a circumference of 120 meshes at the leading edge and 78 meshes at the trailing edge. The short side of the funnel shall be 23 meshes long, while the long side of the funnel shall be 38 1/2 meshes long. The leading edge of the funnel shall be attached three (3) meshes forward of the leading edge of the large mesh section. The eight (8) meshes at the back edge of the top and bottom sections are attached three (3) meshes behind the soft cable hoop, and are centered at the top and bottom of the extension webbing, mesh for mesh. The long side section of the funnel shall be attached to the extension webbing on the top and bottom beginning at the back edge of the top and bottom section. The sewing sequence for this section shall be two (2) meshes down, one (1) mesh over toward the top and bottom centerlines.
5. The large mesh outer section shall be 10 inch stretched mesh netting, 10 mm polyester, or # 120 nylon or heavier, hung on the square, with a **circumference of 19 meshes (95 inches)** and a length of three (3) meshes (15"), or the large mesh outer section shall be 8 inch stretched mesh netting, 4 mm polyester, or # 120 nylon or heavier, hung on the square, **with a circumference of 23 meshes (95 inches)** and a length of four (4) meshes (15 inches").
6. The leading edge of the large mesh section shall be attached to the trailing edge of the front extension. The trailing edge of the large mesh outer section is attached to the leading edge of the back extension.
7. A single hoop, constructed from 1/2 inch (0.5 inch") plastic coated cable measuring **94 1/4 inch** in length (30 inch diameter), shall be attached five (5) meshes back from the leading edge of the back extension.
8. The large mesh escapement opening must be unobstructed.
9. This BRD is installed between the TED and the cod end. When installed behind a hard TED, the leading edge of the 6 1/2 mesh front extension is attached five (5) meshes behind the posterior edge (trailing edge) of the TED. Any part of the TED extension greater than five (5) meshes long must be removed. When installed behind a soft TED, the device is placed between the TED extension and the cod end.

**F. Eight (8) Inch and Ten (10) Inch Inshore Large Mesh and Extended Funnel BRD (Figures 6, 7, 8, 9, and 10):**

1. Description. Devices consist of a funnel of small mesh netting within a cylinder of large mesh netting, held open by one semi-rigid hoop, and are installed in the trawl net behind a National Marine Fisheries Service (NMFS) certified Turtle Excluder Device (TED). One side of the funnel is extended vertically to provide passage for shrimp to the cod end and to create an area of reduced water flow to allow for fish escapement through the larger mesh outer netting. Minimum construction and installation requirements stated below.
2. The small mesh funnel and large mesh section shall be positioned within extension sections constructed of 1 3/8 inch stretched mesh #18 nylon twine. The extension section shall be 120 meshes in circumference. The extension section in front of the large mesh section shall be 6 1/2 meshes long and the extension section behind the large mesh section shall be 23 meshes long.

3. The small mesh funnel shall be constructed from four (4) pieces of 1 3/8 inches stretched mesh, size # 18 twine or larger, depth stretched and heat set polyethylene webbing.
4. The small mesh funnel shall have a circumference of 120 meshes at the leading edge and 78 meshes at the trailing edge. The short side of the funnel shall be 23 meshes long, while the long side of the funnel shall be 38 1/2 meshes long. The leading edge of the funnel shall be attached three (3) meshes forward of the leading edge of the large mesh section. The eight (8) meshes at the back edge of the top and bottom sections are attached three (3) meshes behind the soft cable hoop and are centered at the top and bottom of the extension webbing, mesh for mesh. The long side section of beginning at the back edge of the top and bottom section. The funnel shall be attached to the extension's webbing on the top and bottom. The sewing sequence for this section shall be two (2) meshes down, one (1) mesh over toward the top and bottom centerlines.
5. The large mesh outer section shall be 10 inch stretched mesh netting, 10 mm polyester, or #120 nylon or heavier, hung on the square with a circumference of **14 1/2 meshes (75 inches)** and a length of three (3) meshes (15 inch), or the large mesh outer section shall be 8 inch stretched mesh netting, 4 mm polyester, or # 120 nylon or heavier, hung on the square, **with a circumference of 19 meshes (75 inch)** and a length of four (4) meshes (15 inch).
6. The leading edge of the large mesh section shall be attached to the trailing edge of the front extension. The trailing edge of the large mesh outer section is attached to the leading edge of the back extension.
7. A single hoop, constructed from 3/8 inch (0.38 inch) plastic coated cable measuring **75 1/2 inch** in length shall be attached five (5) meshes back from the leading edge of the back extension.
8. The large mesh escapement opening must be unobstructed.
9. This BRD is installed between the TED and the cod end. When installed behind a hard TED, the leading edge of the 6 1/2 mesh front extension is attached five (5) meshes behind the posterior edge (trailing edge) of the TED. Any part of the TED extension greater than five (5) meshes long must be removed. When installed behind a soft TED, the device is placed between the TED extension and the cod end.

**G. Large Mesh Funnel Excluder (LMFE) (Figures 6,7,8, 9, and 10):**

1. Description. This device consists of a funnel of small mesh netting within a cylinder of larger mesh netting, held open by two (2) semi-rigid hoops, and is installed in the cod end of the trawl. This device must be installed behind a NMFS certified TED if a TED is required. This BRD shall meet the following specifications:
2. The small mesh funnel shall be made from two (2) sections of 1 1/2 inch or 1 5/8 inch, # 24 twine or larger, depth stretched and heat set polyethylene webbing. Funnels having a leading edge of 100 meshes circumference must have a trailing edge of at least 40 meshes and not more than 60 meshes circumference. The funnel

must be 30 meshes long. Funnels having a leading edge of 120 meshes circumference must have a trailing edge of at least 60 meshes and not more than 80 meshes in circumference. The funnel must be 30 meshes long.

3. The mesh escapement section shall be no smaller than 19 inch long and shall be 94 1/2 inch in circumference.
4. The large mesh escapement webbing shall be made from no smaller than 4 inch stretched mesh webbing hung on a square.
5. The mesh escapement opening shall remain unobstructed at all times.
6. The leading edge of the small mesh funnel and the leading edge of the large mesh escapement webbing shall be attached to a hoop, 94 1/2 inch in length (30 inch diameter), made from at least 3/8 inch diameter combination-cable or plastic coated towing cable. The trailing edge of the large mesh escapement webbing shall be attached to the second hoop constructed identical to the forward hoop.
7. The top and bottom ends of the trailing edge of the small funnel shall be attached to the top and bottom of the cod end, respectively, so the funnel remains taut while being towed.

#### **H. Jones-Davis:**

1. Description. The Jones-Davis BRD is similar to the expanded mesh and the extended funnel BRDs except that the fish escape openings are windows cut around the funnel rather than large-mesh sections. In addition, a webbing cone fish deflector is installed behind the funnel. Minimum construction and installation requirements stated below.
2. Webbing extension. The webbing extension must be constructed from a single piece of 1 5/8 inch (3.5 cm) stretch mesh # 30 nylon 42 meshes by 120 meshes. A tube is formed from the extension webbing by sewing the 42-mesh side together.
3. 28 inch (71.1cm) cable hoop. A single hoop must be constructed of 1/2 inch (1.3 cm) steel cable 88 inch (223.5 cm) in length. The cable must be joined at its ends by a 3 inch (7.6 cm) piece of 1/2 inch (1.3 cm) aluminum pipe and pressed with a 3/8 inch (0.95 cm) die to form a hoop. The inside diameter of this hoop must be between 27 and 29 inches (68.6 and 73.7 cm). The hoop must be attached to the extension webbing 17 1/2 meshes behind the leading edge. The extension webbing must be quartered and attached in four places around the hoop, and every other mesh must be attached all the way around the hoop using # 24 twine or larger. The hoop must be laced with 3/8 inch (0.95 cm) polypropylene or polyethylene rope for chaffing.
4. 24 inch (61.0 cm) hoop. A single hoop must be constructed of either # 60 twine 80 inches (203.2 cm) in length or 3/8 inch (0.95 cm) steel cable 75 1/2 inches (191.8 cm) in length. If twine is used, the twine must be laced in and out of the extension webbing 39 meshes behind the leading edge, and the ends must be tied together. If cable is used, the cable must be joined at its ends by a 3 inch (7.6 cm) piece of 3/8 inch (0.95 cm) aluminum pipe and pressed together with a 1/4 inch (0.64 cm) die to form a hoop. The inside diameter of this hoop must be between 23 and 25 inches

- (58.4 and 63.4 cm). The hoop must be attached to the extension webbing 39 meshes behind the leading edge. The extension webbing must be quartered and attached in four places around the hoop, and every other mesh must be attached all the way around the hoop using # 24 twine or larger. The hoop must be laced with 3/8 inch (0.95 cm) polypropylene or polyethylene rope for chaffing.
5. Funnel. The funnel must be constructed from four sections of 1 1/2 inch (3.8 cm) heat-set and depth-stretched polypropylene or polyethylene webbing. The two side sections must be rectangular in shape, 29 1/2 meshes on the leading edge by 23 meshes deep. The top and bottom sections are 29 1/2 meshes on the leading edge by 23 meshes deep and tapered 1 point 2 bars on both sides down to 8 meshes across the back. The four sections must be sewn together down the 23 mesh edge to form the funnel.
  6. Attachment of the funnel in the webbing extension. The funnel must be installed two meshes behind the leading edge of the extension starting at the center seam of the extension and the center mesh of the funnel's top section leading edge. On the same row of meshes, the funnel must be sewn evenly all the way around the inside of the extension. The funnel's top and bottom back edges must be attached one mesh behind the 28 inch (71.1 cm) cable hoop (front hoop). Starting at the top center seam, the back edge of the top funnel section must be attached 4 meshes each side of the center. Counting around 60 meshes from the top center, the back edge of the bottom section must be attached 4 meshes on each side of the bottom center. Clearance between the side of the funnel and the 28 inch (71.1 cm) cable hoop (front hoop) must be at least 6 inches (15.2 cm) when measured in the hanging position.
  7. Cutting the escape openings. The leading edge of the escape opening must be located within 18 inches (45.7 cm) of the posterior edge of the turtle excluder device (TED) grid. The area of the escape opening must total at least 864 in<sup>2</sup> (5,574.2 cm<sup>2</sup>). Two escape openings 10 meshes wide by 13 meshes deep must be cut 6 meshes apart in the extension webbing, starting at the top center extension seam, 3 meshes back from the leading edge and 16 meshes to the left and to the right (total of four openings). The four escape openings must be double-selvaged for strength. The escape openings shall remain unobstructed at all times.
  8. Alternative Method for Constructing the Funnel and Escape Openings. The following method for constructing the funnel and escape openings may be used instead of the method described in paragraphs F.2.d., F.2.e., and F.2.f. of this section. With this alternative method, the funnel and escape openings are formed by cutting a flap in each side of the extension webbing; pushing the flaps inward; and attaching the top and bottom edges along the bars of the extension webbing to form the V-shape of the funnel. Minimum requirements applicable to this method include: (1) The funnel's top and bottom back edges must be attached one mesh behind the 28 inch (71.1 cm) cable hoop (front hoop); (2) clearance between the side of the funnel and the 28 inch (71.1 cm) cable hoop (front hoop) must be at least 6 inches (15.2 cm) when measured in the hanging position; (3) the leading edge of the escape opening must be located within 18 inches (45.7 cm) of the posterior edge of the turtle excluder device (TED) grid; and, (4) the area of the escape opening must total at least 864 in<sup>2</sup> (5,574.2 cm<sup>2</sup>). To construct the funnel and escape openings using this method, begin 3 1/2 meshes from the leading edge of the extension, at the top center seam, count over 18 meshes on each side, and cut 13 meshes toward the back of the

- extension. Turn parallel to the leading edge, and cut 26 meshes toward the bottom center of the extension. Next, turn parallel to the top center seam, and cut 13 meshes forward toward the leading edge, creating a flap of webbing 13 meshes by 26 meshes by 13 meshes. Lengthen the flap to 18 meshes by adding a 4 1/2 mesh by 26 mesh rectangular section of webbing to the 26 mesh edge. Attach the 18 mesh edges to the top and bottom of the extension by sewing 2 bars of the extension to 1 mesh on the flap in toward the top center and bottom center of the extension, forming the exit opening and the funnel. Connect the two flaps together in the center with a 7 inch piece of # 42 twine to allow adequate clearance for fish escapement between the flaps and the side openings. On each side, sew a 6-mesh by 10 1/2 mesh section of webbing to 6 meshes of the center of the 26 mesh cut on the extension and 6 meshes centered between the 13 mesh cuts 3 1/2 meshes from the leading edge. This forms two 10 mesh by 13 mesh openings on each side.
9. Cone fish deflector: The cone fish deflector is constructed of two pieces of 1 5/8 inch (4.13 cm) polypropylene or polyethylene webbing, 40 meshes wide by 20 meshes in length and cut on the bar on each side forming a triangle. Starting at the apex of the two triangles, the two pieces must be sewn together to form a cone of webbing. The apex of the cone fish deflector must be positioned within 10-14 inches (25.4-35.6 cm) of the posterior edge of the funnel.
  10. 11 inch (27.9 cm) cable hoop for cone deflector. A single hoop must be constructed of 5/16 inch (0.79 cm) or 3/8 inch (0.95 cm) cable 34 1/2 inches (87.6 cm) in length. The ends must be joined by a 3 inch (7.6 cm) piece of 3/8 inch (0.95 cm) aluminum pipe pressed together with a 1/4 inch (0.64 cm) die. The hoop must be inserted in the webbing cone, attached 10 meshes from the apex and laced all the way around with heavy twine.
  11. Installation of the cone in the extension: The cone must be installed in the extension 12 inches (30.5 cm) behind the back edge of the funnel and attached in four places. The midpoint of a piece of # 60 twine 4 ft (1.22 m) in length must be attached to the apex of the cone. This piece of twine must be attached to the 28 inch (71.1 cm) cable hoop at the center of each of its sides; the points of attachment for the two pieces of twine must be measured 20 inches (50.8 cm) from the midpoint attachment. Two 8 inch (20.3 cm) pieces of # 60 twine must be attached to the top and bottom of the 11 inch (27.9 cm) cone hoop. The opposite ends of these two pieces of twine must be attached to the top and bottom center of the 24 inch (61 cm) cable hoop; the points of attachment for the two pieces of twine must be measured 4 inches (10.2 cm) from the points where they are tied to the 11 inch (27.9 cm) cone hoop.

#### **I. Modified Jones-Davis:**

1. Description: The Modified Jones-Davis BRD is a variation to the alternative funnel construction method of the Jones-Davis BRD except the funnel is assembled by using depth-stretched and heat-set polyethylene webbing instead of the flaps formed from the extension webbing. In addition, no hoops are used to hold the BRD open. Minimum construction and installation requirements stated below.
2. Webbing extension: The webbing extension must be constructed from a single rectangular piece of 1 5/8 inch (4.1 cm) stretch mesh # 30 nylon with dimensions of 39

1/2 meshes by 150 meshes. A tube is formed from the extension webbing by sewing the 39 1/2 mesh sides together.

3. Funnel: The funnel must be constructed from two sections of 1 5/8 inch (4.1 cm) heat-set and depth-stretched polypropylene or polyethylene webbing. The two side sections must be rectangular in shape, 25 meshes on the leading edge by 21 meshes deep. The 25 mesh leading edge of each polyethylene webbing section must be sewn evenly two meshes in from the front of the extension webbing starting 25 meshes from the top center on each side. The 21 mesh edge must be sewn to the extension webbing on a 9 bar and 1 mesh angle in the top and bottom, forming a V-shape funnel.
4. Cutting the escape opening. The leading edge of the escape openings must be located within 18 inches (45.7 cm) of the posterior edge of the turtle excluder device (TED) grid. The area of the escape opening must total at least 635 in<sup>2</sup> (4,097 cm<sup>2</sup>). Two escape openings, 6 meshes wide by 12 meshes deep, must be cut 4 meshes apart in the extension webbing, starting at the top center extension seam, 7 meshes back from the leading edge, and 30 meshes to the left and to the right (total of four openings). The four escape openings must be double-selvaged for strength. The four escape openings shall remain unobstructed at all times.
5. Cone fish deflector. The cone fish deflector is constructed of 2 pieces of 1 5/8 inch (4.1 cm) polypropylene or polyethylene webbing, 40 meshes wide by 20 meshes in length and cut on the bar on each side forming a triangle. Starting at the apex of the two triangles, the two pieces must be sewn together to form a cone of webbing. The apex of the cone fish deflector must be positioned within 12 inches (30.5 cm) of the posterior edge of the funnel.
6. 11 inch (27.9 cm) cable hoop for cone deflector. A single hoop must be constructed of 5/16 inch (0.79 cm) or 3/8 inch (0.95 cm) cable 34 1/2 inches (87.6 cm) in length. The ends must be joined by a 3 inch (7.6 cm) piece of 3/8 inch (0.95 cm) aluminum pipe pressed together with a 1/4 inch (0.64 cm) die. The hoop must be inserted in the webbing cone, attached 10 meshes from the apex and laced all the way around with heavy twine.
7. Installation of the cone in the extension. The apex of the cone must be installed in the extension within 12 inches (30.5 cm) behind the back edge of the funnel and attached in four places. The midpoint of a piece of # 60 twine (or at least 4-mesh wide strip of # 21 or heavier webbing) 3 ft (1.22 m) in length must be attached to the apex of the cone. This piece of twine or webbing must be attached within 5 meshes of the aft edge of the funnel at the center of each of its sides. Two 12 inch (30.5 cm) pieces of # 60 (or heavier) twine must be attached to the top and bottom of the 11 inch (27.9 cm) cone hoop. The opposite ends of these two pieces of twine must be attached to the top and bottom center of the extension webbing to keep the cone from inverting into the funnel.

#### **J. Cone Fish Deflector Composite Panel:**

1. Description. The Cone Fish Deflector Composite Panel BRD is a variation to the alternative funnel construction method of the Jones-Davis BRD, except the funnel is assembled by using depth-stretched and heat-set polyethylene webbing with square mesh panels on the inside instead of the flaps formed from the extension webbing. In

addition, no hoops are used to hold the BRD open. Minimum construction and installation requirements stated below.

2. Webbing extension. The webbing extension must be constructed from a single rectangular piece of 1 1/2 inch to 1 3/4 inch (3.8 cm to 4.5 cm) stretch mesh with dimensions of 24 1/2 meshes by 150 to 160 meshes. A tube is formed from the extension webbing piece by sewing the 24 1/2 mesh sides together. The leading edge of the webbing extension must be attached no more than 4 meshes from the posterior edge of the TED grid.
3. Funnel. The V-shaped funnel consists of two webbing panels attached to the extension along the leading edge of the panels. The top and bottom edges of the panels are sewn diagonally across the extension toward the center to form the funnel. The panels are 2-ply in design, each with an inner layer of 1 1/2 inch to 1 5/8 inch (3.8 cm to 4.1 cm) heat-set and depth-stretched polyethylene webbing and an outer layer constructed of no larger than 2 inch (5.1 cm) square mesh webbing (1 inch bar). The inner webbing layer must be rectangular in shape, 36 meshes on the leading edge by 20 meshes deep. The 36 mesh leading edges of the polyethylene webbing should be sewn evenly to 24 meshes of the extension webbing 1 1/2 meshes from and parallel to the leading edge of the extension starting 12 meshes up from the bottom center on each side. Alternately sew 2 meshes of the polyethylene webbing to 1 mesh of the extension webbing then 1 mesh of the polyethylene webbing to 1 mesh of the extension webbing toward the top. The bottom 20 mesh edges of the polyethylene layers are sewn evenly to the extension webbing on a 2 bar 1 mesh angle toward the bottom back center forming a V-shape in the bottom of the extension webbing. The top 20 mesh edges of the polyethylene layers are sewn evenly along the bars of the extension webbing toward the top back center. The square mesh layers must be rectangular in shape and constructed of no larger than 2 inch (5.1 cm) webbing that is 18 inches (45.7 cm) in length on the leading edge. The depth of the square mesh layer must be no more than 2 inches (5.1 cm) less than the 20 mesh side of the inner polyethylene layer when stretched taught. The 18 inch (45.7 cm) leading edge of each square mesh layer must be sewn evenly to the 36 mesh leading edge of the polyethylene section and the sides are sewn evenly (in length) to the 20 mesh edges of the polyethylene webbing. This will form a V-shape funnel using the top of the extension webbing as the top of the funnel and the bottom of the extension webbing as the bottom of the funnel.
4. Cutting the escape opening. There are two escape openings on each side of the funnel. The leading edge of the escape openings must be located on the same row of meshes in the extension webbing as the leading edge of the composite panels. The lower openings are formed by starting at the first attachment point of the composite panels and cutting 9 meshes in the extension webbing on an even row of meshes toward the top of the extension. Next, turn 90 degrees and cut 15 points on an even row toward the back of the extension webbing. At this point turn and cut 18 bars toward the bottom front of the extension webbing. Finish the escape opening by cutting 6 points toward the original starting point. The top escape openings start 5 meshes above and mirror the lower openings. Starting at the leading edge of the composite panel and 5 meshes above the lower escape opening, cut 9 meshes in the extension on an even row of meshes toward the top of the extension. Next, turn 90 degrees, and cut 6 points on an even row toward the back of the extension webbing. Then cut 18 bars toward the bottom back of the extension. To complete the

escape opening, cut 15 points forward toward the original starting point. The area of each escape opening must total at least 212 in<sup>2</sup> (1,368 cm<sup>2</sup>). The four escape openings must be double-selvaged for strength. The four escape openings shall be unobstructed at all times.

5. Cone fish deflector. The cone fish deflector is constructed of 2 pieces of 1 5/8 inch (4.1 cm) polypropylene or polyethylene webbing, 40 meshes wide by 20 meshes in length and cut on the bar on each side forming a triangle. Starting at the apex of the two triangles, the two pieces must be sewn together to form a cone of webbing. The apex of the cone fish deflector must be positioned within 12 inches (30.5 cm) of the posterior edge of the funnel.
6. 11 inch (27.9 cm) cable hoop for cone deflector. A single hoop must be constructed of 5/16 inch (0.79 cm) or 3/8 inch (0.95 cm) cable 34 1/2 inches (87.6 cm) in length. The ends must be joined by a 3 inch (7.6 cm) piece of 3/8 inch (0.95 cm) aluminum pipe pressed together with a 1/4 inch (0.64 cm) die. The hoop must be inserted in the webbing cone, attached 10 meshes from the apex and laced all the way around with heavy twine.
7. Installation of the cone in the extension. The apex of the cone must be installed in the extension within 12 inches (30.5 cm) behind the back edge of the funnel and attached in four places. The midpoint of a piece of # 60 twine (or at least 4-mesh wide strip of # 21 or heavier webbing) 3 ft (1.22 m) in length must be attached to the apex of the cone. This piece of twine or webbing must be attached within 5 meshes of the aft edge of the funnel at the center of each of its sides. Two 12 inch (30.5 cm) pieces of # 60 (or heavier) twine must be attached to the top and bottom of the 11 inch (27.9 cm) cone hoop. The opposite ends of these two pieces of twine must be attached to the top and bottom center of the extension webbing to keep the cone from inverting into the funnel.

#### **K. Square Mesh Panel (SMP) Composite Panel:**

1. Description. The SMP is a panel of square mesh webbing placed in the top of the cod end to provide finfish escape openings. Minimum construction and installation requirements stated below.
2. Webbing extension. The webbing extension must be constructed from a single rectangular piece of 1 1/2 inch to 1 3/4 inch (3.8 cm to 4.5 cm) stretch mesh with dimensions of 24 1/2 meshes by 150 to 160 meshes. A tube is formed from the extension webbing piece by sewing the 24 1/2 mesh sides together. The leading edge of the webbing extension must be attached no more than 4 meshes from the posterior edge of the TED grid.
3. Funnel. The V-shaped funnel consists of two webbing panels attached to the extension along the leading edge of the panels. The top and bottom edges of the panels are sewn diagonally across the extension toward the center to form the funnel. The panels are 2-ply in design, each with an inner layer of 1 1/2 inch to 1 5/8 inch (3.8 cm to 4.1 cm) heat-set and depth-stretched polyethylene webbing and an outer layer constructed of no larger than 2 inch (5.1 cm) square mesh webbing (1 inch bar). The inner webbing layer must be rectangular in shape, 36 meshes on the leading edge by 20 meshes deep. The 36 mesh leading edges of the polyethylene



webbing should be sewn evenly to 24 meshes of the extension webbing 1 1/2 meshes from and parallel to the leading edge of the extension starting 12 meshes up from the bottom center on each side. Alternately sew 2 meshes of the polyethylene webbing to 1 mesh of the extension webbing then 1 mesh of the polyethylene webbing to 1 mesh of the extension webbing toward the top. The bottom 20 mesh edges of the polyethylene layers are sewn evenly to the extension webbing on a 2 bar 1 mesh angle toward the bottom back center forming a V-shape in the bottom of the extension webbing. The top 20 mesh edges of the polyethylene layers are sewn evenly along the bars of the extension webbing toward the top back center. The square mesh layers must be rectangular in shape and constructed of no larger than 2 inch (5.1 cm) webbing that is 18 inches (45.7 cm) in length on the leading edge. The depth of the square mesh layer must be no more than 2 inches (5.1 cm) less than the 20 mesh side of the inner polyethylene layer when stretched taught. The 18 inch (45.7 cm) leading edge of each square mesh layer must be sewn evenly to the 36 mesh leading edge of the polyethylene section and the sides are sewn evenly (in length) to the 20 mesh edges of the polyethylene webbing. This will form a V-shape funnel using the top of the extension webbing as the top of the funnel and the bottom of the extension webbing as the bottom of the funnel.

4. Cutting the escape opening. There are two escape openings on each side of the funnel. The leading edge of the escape openings must be located on the same row of meshes in the extension webbing as the leading edge of the composite panels. The lower openings are formed by starting at the first attachment point of the composite panels and cutting 9 meshes in the extension webbing on an even row of meshes toward the top of the extension. Next, turn 90 degrees and cut 15 points on an even row toward the back of the extension webbing. At this point turn and cut 18 bars toward the bottom front of the extension webbing. Finish the escape opening by cutting 6 points toward the original starting point. The top escape openings start 5 meshes above and mirror the lower openings. Starting at the leading edge of the composite panel and 5 meshes above the lower escape opening, cut 9 meshes in the extension on an even row of meshes toward the top of the extension. Next, turn 90 degrees, and cut 6 points on an even row toward the back of the extension webbing. Then cut 18 bars toward the bottom back of the extension. To complete the escape opening, cut 15 points forward toward the original starting point. The area of each escape opening must total at least 212 in<sup>2</sup> (1,368 cm<sup>2</sup>). The four escape openings must be double-selvaged for strength. The four escape openings shall remain unobstructed at all times.
5. SMP. The SMP is constructed from a single piece of square mesh webbing with a minimum dimension of 5 squares wide and 12 squares in length with a minimum mesh size of 3 inch (76 mm) stretched mesh. The maximum twine diameter of the square mesh is # 96 twine (4 mm).
6. Cutting the SMP escape opening. The escape opening is a rectangular hole cut in the top center of the cod end webbing. The posterior edge of the escape opening must be placed no farther forward than 8 ft (2.4 m) from the cod end drawstring (tie-off rings). The width of the escape opening, as measured across the cod end, must be four cod end meshes per square of the SMP (i.e., a cut of 20 cod end meshes for a SMP that is 5 meshes wide). The stretched mesh length of the escape opening must be equal to the total length of the SMP. No portion of the SMP escape opening may be covered with additional material or netting such as chaffing webbing, which

might impede or prevent fish escapement.

7. Installation of the SMP. The SMP must be attached to the edge of the escape opening evenly around the perimeter of the escape opening cut with heavy twine.

## II. **SECOND BRD REQUIREMENTS:**

It is unlawful for a person to use a shrimp trawl in coastal fishing waters **without a second Authorized North Carolina Division of Marine Fisheries (NCDMF) Bycatch Reduction Device(s) (BRD)** as outlined in Section I. **OR** an additional Ancillary BRD, both operational and properly installed in each net. Ancillary BRDs include:

- A. Reduced bar spacing in a TED, to be considered ancillary BRD the bar spacing in the TED shall not exceed three inches from inside edge to inside edge of bars.
- B. If the primary BRD is a Florida Fish Excluder (Section I. A.), and the second authorized BRD is a FFE then the second Florida Fish Excluder shall be installed in accordance with section I.A. with the exception that the second FFE can be installed no further forward than 5 meshes from the apex of the primary FFE and the same distance from the centerline as the primary FFE with the apex of the second FFE facing the headrope of the trawl and shall be exempt from requirement I.A.5. as to the 65% placement of the FFE.
- C. A T-90 or square mesh (T-45) cod end shall be installed in a minimum of ½ the effective cod end length.
- D. T-90 or square mesh (T-45) panels shall be constructed with a minimum of 2 inch stretched mesh, cover a minimum of the top 1/3 of the effective circumference of the cod end, be a minimum of 3 feet in length, and shall be installed no further forward than 6 feet from the cod end tie-off rings.

## III. **EXEMPTIONS:**

These BRD restrictions do not apply to a single test trawl net (try net) with a headrope length of 16 feet or less, if it is operated under the following conditions:

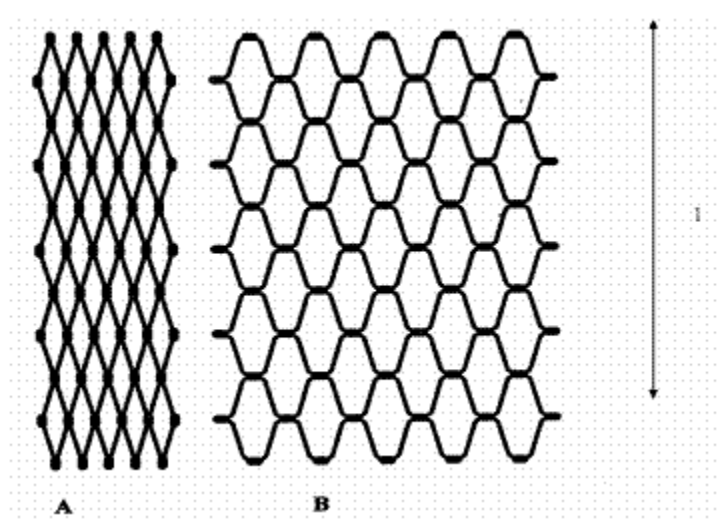
- A. net is either pulled immediately in front of another net or is not connected to another net in any way;
- B. no more than one net is used at a time; and
- C. net is not towed as a primary net.

## IV. **DEFINITIONS:** For the purposes of this proclamation, the following terms are hereby defined:

- A. Bycatch reduction device (BRD) - any gear or trawl modification (including modifications to a TED that would enhance finfish exclusion) designed to allow finfish to escape from a shrimp trawl. BRD is defined based on its ability to facilitate the escape of finfish from a shrimp trawl.
- B. Turtle Excluder Device (TED) - An inclined grid or netting panel that prevents the passage of large animals such as sea turtles and large fish into the cod end and guides

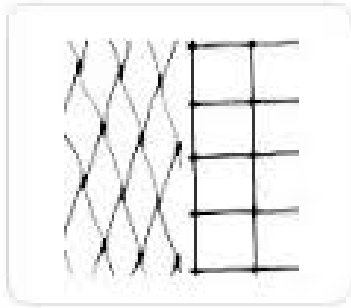
them through an escape opening located in the cod end. TED is defined based on its ability to exclude sea turtles from a shrimp trawl.

- C. Tail bag/Cod end - That portion of the trawl net at which the trawl bodies taper ends and the straight extension begins, extending to the terminal end of the trawl.
- D. Functional Cod end Length - That length of the cod end of a trawl beginning at the cod end tie-off rings and extending forward for a maximum of 105 meshes or to the point where the straight extension ends and the trawl body taper begins, whichever is less. Trawls utilizing short cod ends may include those meshes of the TED extension that are behind the TED grid and are in-line with the center of the FFE escape opening.
- E. Centerline - The line running from the center point of the headrope to the top center of the end of the cod end.
- F. T-90 – Webbing turned 90°.



**Illustration of (A) traditional (T-0) webbing and (B) T-90 webbing.**

- G. Square mesh panel (T-45) – Webbing turned 45°, such that panels are sewed in with the bar width facing the headrope.



**Illustration of traditional (T-0) webbing and square mesh (T-45) webbing.**

**V. GENERAL INFORMATION:**

- A. This proclamation is issued under the authority of N.C.G.S. 113-170.4; 113-170.5; 113-182; 143B-289.52 and N.C. Marine Fisheries Rule 15A NCAC 3J .0104(d).
- B. The Florida Fish Excluder (I. A.) is measured diagonally from inside one corner edge to the inside edge of the opposite corner while the Fisheye (I.B.) and the Gulf Fisheye (I.C) are measured by measuring two inside leg lengths and multiplying those two distances to calculate the total square inches of the opening.
- C. It is unlawful to violate the provisions of any proclamation issued by the Fisheries Director under his delegated authority per N.C. Fisheries Rule 15A NCAC 3H .0103.
- D. Channel nets, float nets, fixed nets, and butterfly nets are not required to use BRDs.
- E. The intent of this proclamation is to allow federal approved bycatch reduction devices to be approved as state bycatch reduction devices and to require a second authorized BRD in accordance with the N.C. Shrimp Fishery Management Plan Amendment 1.
- F. Persons wishing to test BRD designs not covered by this proclamation may submit BRD designs to the NCDMF, Morehead City office, for consideration for field-testing.
- G. Contact N.C. Division of Marine Fisheries, P.O. Box 769, Morehead City, NC 28557 252-726-7021 or 800-682-2632 for more information or visit the division website at <http://portal.ncdenr.org/web/mf/>.
- H. For more information on the installation of the Modified Jones Davis BRD visit: [http://sero.nmfs.noaa.gov/sustainable\\_fisheries/gulf\\_fisheries/shrimp/documents/pdfs/brds/mod\\_jones\\_davis\\_instructions.pdf](http://sero.nmfs.noaa.gov/sustainable_fisheries/gulf_fisheries/shrimp/documents/pdfs/brds/mod_jones_davis_instructions.pdf) and for more information on the installation of the Composite Panel BRD visit: [http://sero.nmfs.noaa.gov/sustainable\\_fisheries/gulf\\_fisheries/shrimp/documents/pdfs/brds/composite\\_brd\\_instructions.pdf](http://sero.nmfs.noaa.gov/sustainable_fisheries/gulf_fisheries/shrimp/documents/pdfs/brds/composite_brd_instructions.pdf).
- I. In accordance with N.C. General Statute 113-221.1(c) All persons who may be affected

by proclamations issued by the Fisheries Director are under a duty to keep themselves informed of current proclamations.

- J. This proclamation supersedes Proclamation SH-3-2012, dated May 22, 2012. **There are significant changes in that additional Bycatch Reduction Devices are now approved for use in Coastal Fishing Waters and a second Bycatch Reduction Device is required.**

BY: \_\_\_\_\_  
Dr. Louis B. Daniel III, Director  
DIVISION OF MARINE FISHERIES

May 12, 2015  
12:00 P.M.  
SH-2-2015  
/KB/sab

232 copies of the public document were printed at a cost \$1.25 each.

**Table 1.** Required placement of Florida Fish Excluders (FFE).

Functional Cod end Length *	Maximum FFE Placement**	Functional Cod end Length&	Maximum FFE Placement**
105 meshes or greater	68 meshes	82	53
104	68	81	53
103	67	80	52
102	66	79	51
101	66	78	51
100	65	77	50
99	64	76	49
98	64	75	49
97	63	74	48
96	62	73	47
95	62	72	47
94	61	71	46
93	60	70	46
92	60	69	45
91	59	68	44
90	59	67	44
89	58	66	43
88	57	65	42
87	57	64	42
86	56		
85	55		
84	55		
83	54		

\* Functional Cod end Length – That length of the cod end of a trawl beginning at the cod end tie-off and extending forward for a maximum of 105 meshes or to the point where the straight extension ends and the trawl body taper begins, whichever is less. Trawls utilizing short cod ends may include those meshes of the TED extension that are behind the TED grid and are in-line with the center of the FFE escape opening.

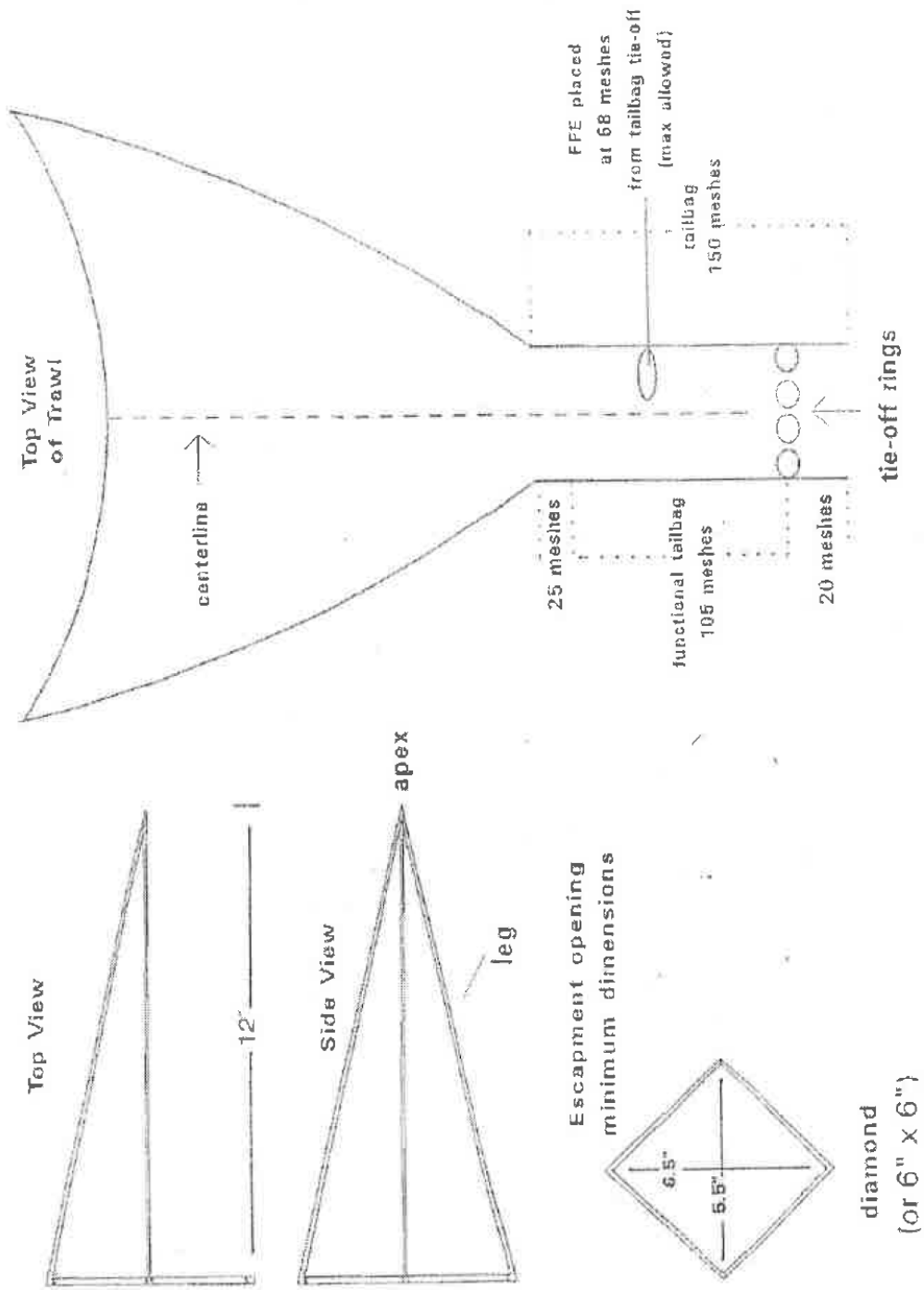
\*\* If your cod end is not included in this Table, you can figure the maximum placement for your net by following the formula: (mesh count multiplied by 65, divided by 100, using a 50 mesh cod end as an example  $(50 \times 65) / 100 = 32.5$ ).

**Table 2.** Required placement of “SEA EAGLE” Excluders.

Functional Cod end Length *	Maximum “SEA EAGLE” Placement**	Functional Cod end Length&	Maximum “SEA EAGLE” Placement**
105 meshes or greater	40 meshes	82	31
104	40	81	31
103	39	80	30
102	39	79	30
101	38	78	30
100	38	77	29
99	38	76	29
98	37	75	29
97	37	74	28
96	36	73	28
95	36	72	27
94	36	71	27
93	35	70	27
92	35	69	26
91	35	68	26
90	34	67	25
89	34	66	25
88	33	65	25
87	33	64	24
86	33		
85	32		
84	32		
83	32		

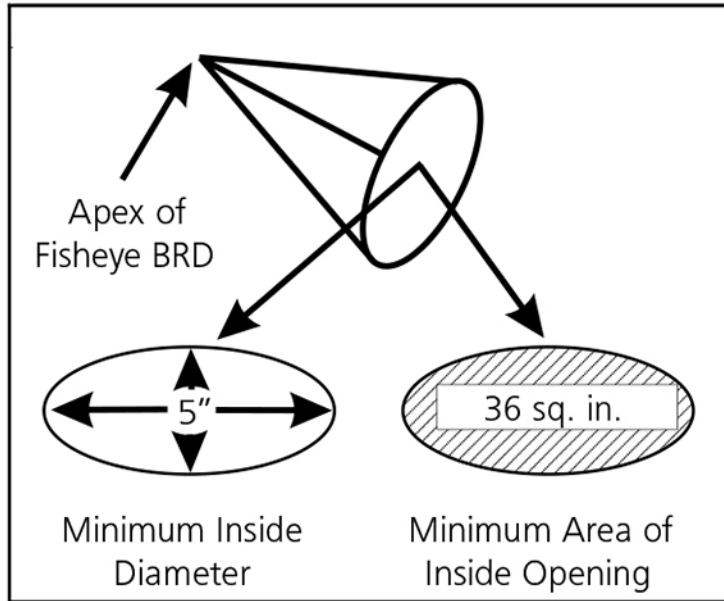
\* Functional Cod end Length – That length of the cod end of a trawl beginning at the cod end tie-off and extending forward for a maximum of 105 meshes or to the point where the straight extension ends and the trawl body taper begins, whichever is less. Trawls utilizing short cod ends may include those meshes of the TED extension that are behind the TED grid and are in-line with the center of the “SEA EAGLE” escape opening.

\*\* If your cod end is not included in this Table, you can figure the maximum placement for your net by following the formula: (mesh count multiplied by 38, divided by 100, using a 50 mesh cod end as an example:  $(50 \times 38) / 100 = 19$ ).

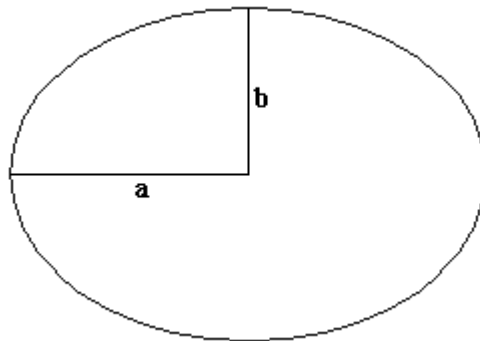


**Figure 1.** Diagram of Florida Fish Eye (FFE) (I.A.)

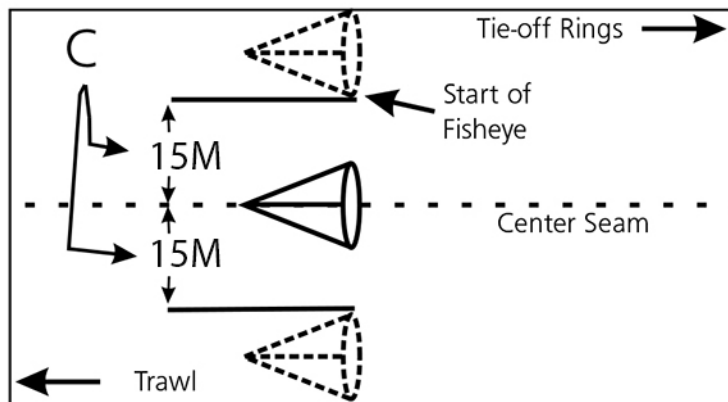




**Figure 2.** Minimum dimensions of the Fisheye (I.B.) and Gulf Fisheye (I.C.).



**Figure 3.** To determine the opening size of the oval Fisheye (I.B.) and the Gulf Fisheye (I.C.) use the following formula:  $\text{Area} = \pi \times a \times b$



**Figure 4.** Placement of the Gulf Fisheye (I.C.) in relation to the center seam of the cod end.

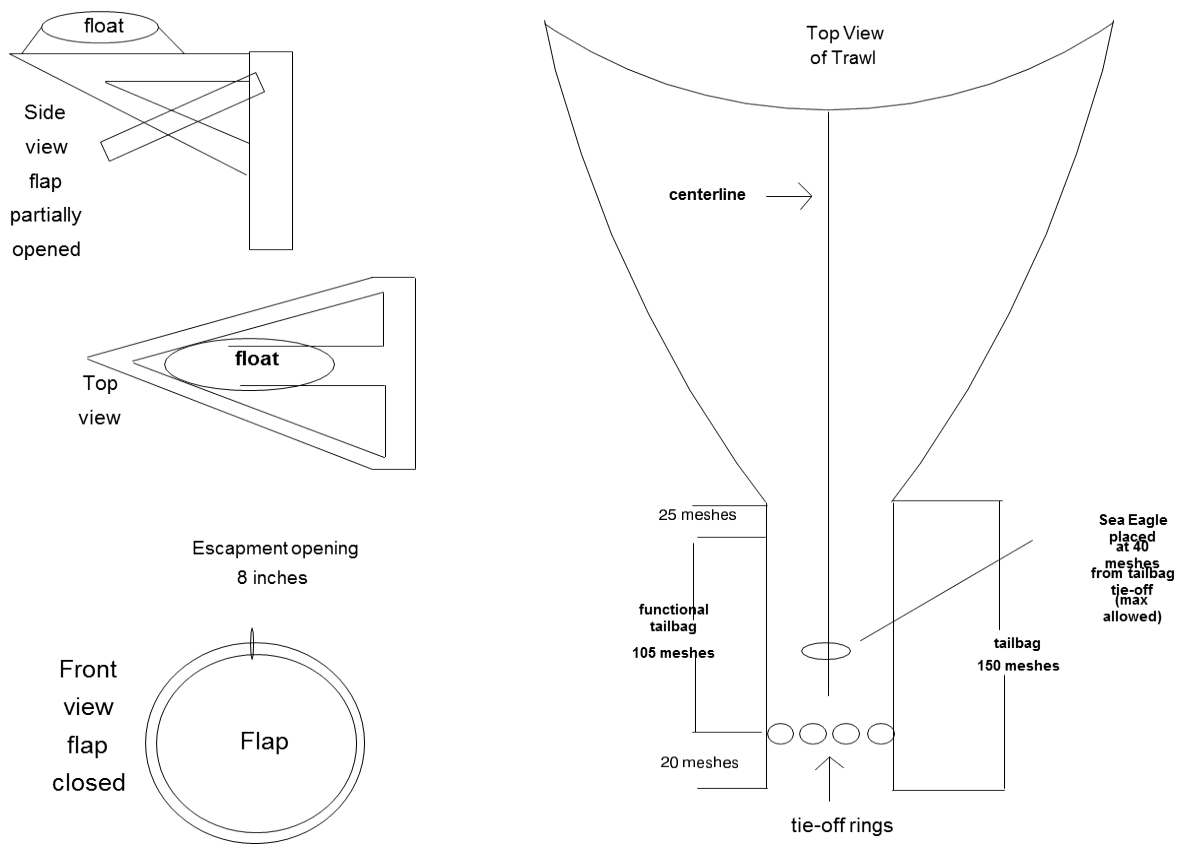
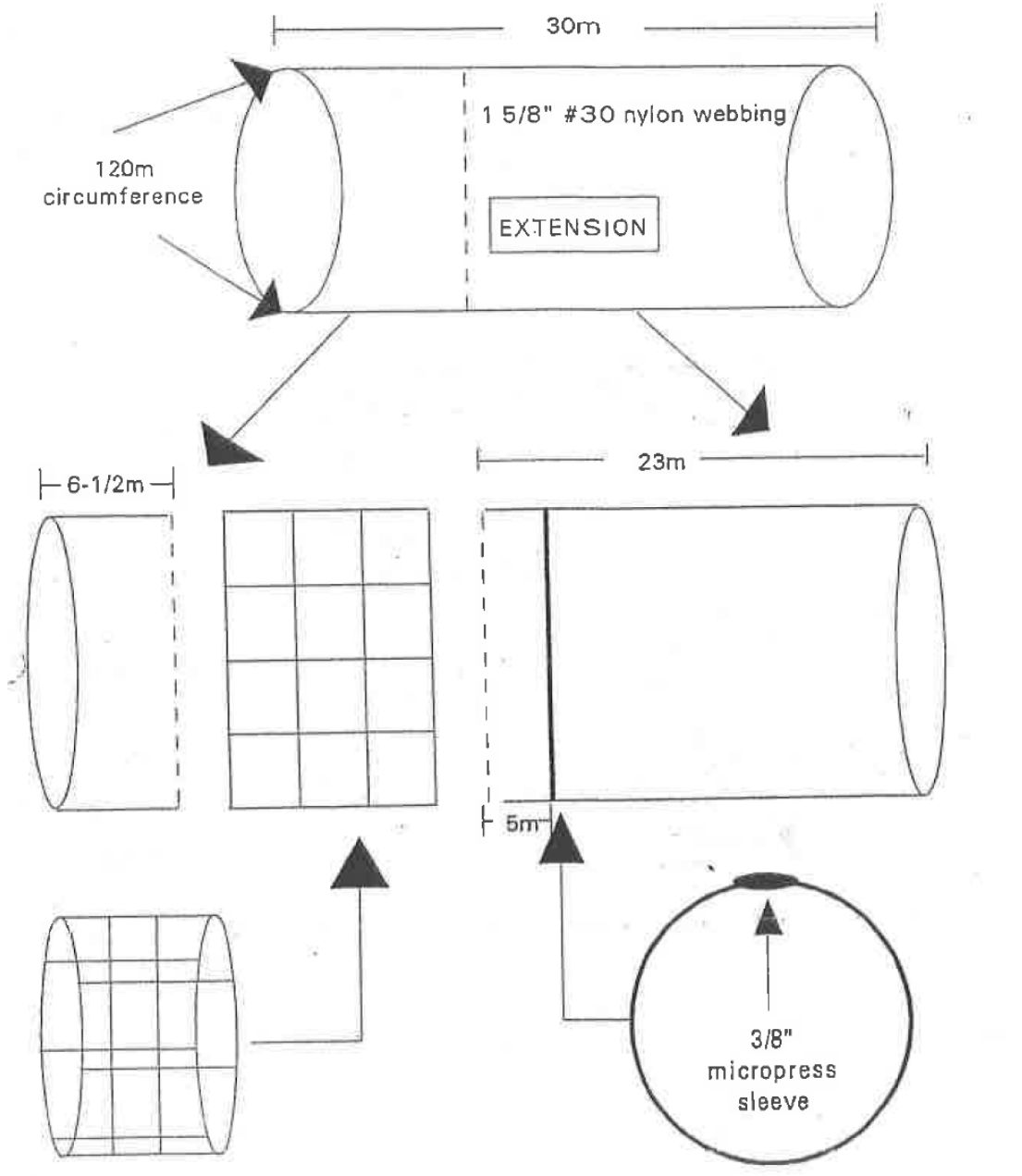


Diagram of "Sea Eagle" Fish Excluder.

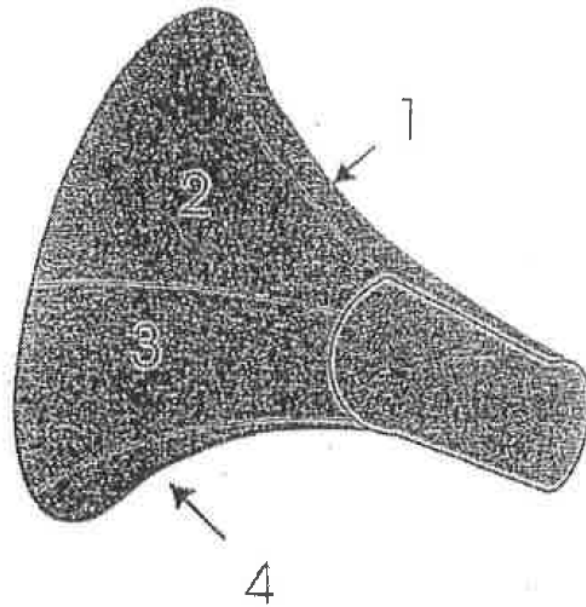
**Figure 5.** Diagram of "Sea Eagle" Fish Excluder.



10" Large mesh  
 19 meshes (95") by 3 meshes (15")  
 √  
 8" Large mesh  
 23 meshes (95") by 4 meshes (15")

**Figure 6.** Diagram of the Large Mesh and Extended Mesh Funnel BRDs (I.E, I.F, and I.G.).

# Funnel

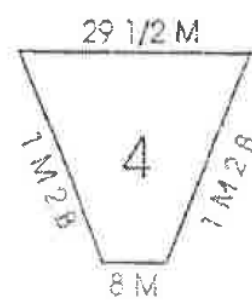
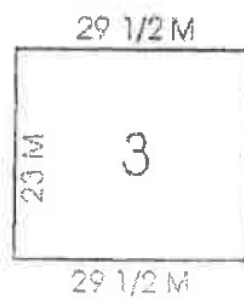
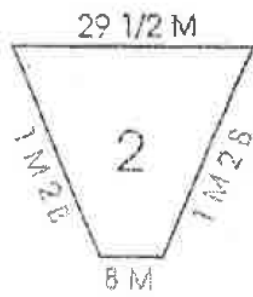


Side

Top

Side

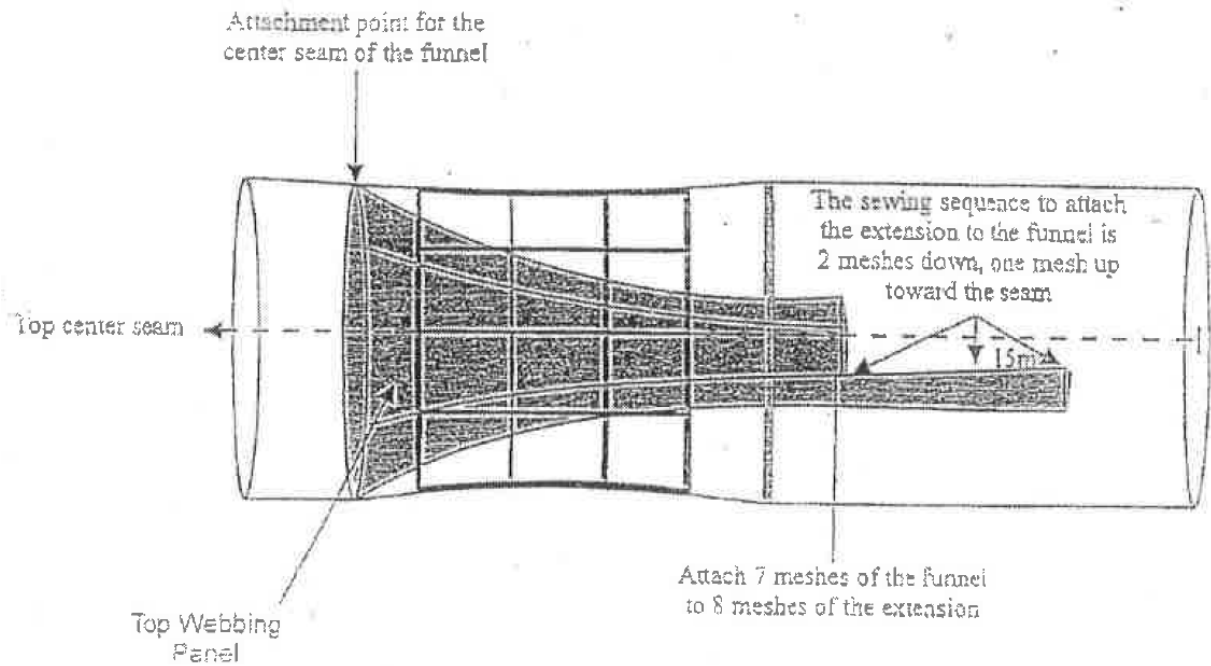
Bottom



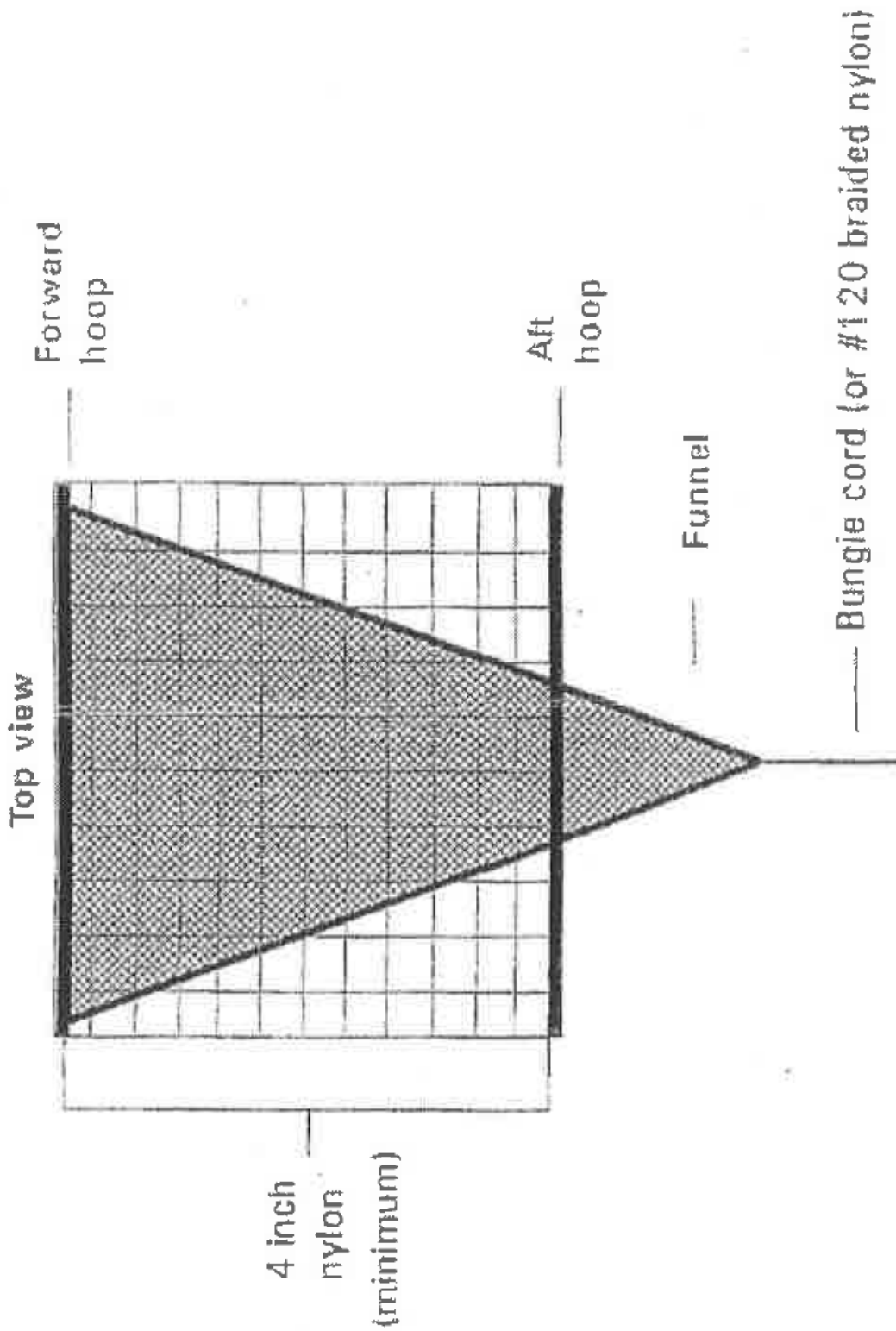
## Webbing Panels

**Figure 7.** Webbing panels of the Large Mesh and Extended Mesh Funnel BRDs (I.E., I.F. and I.G.).

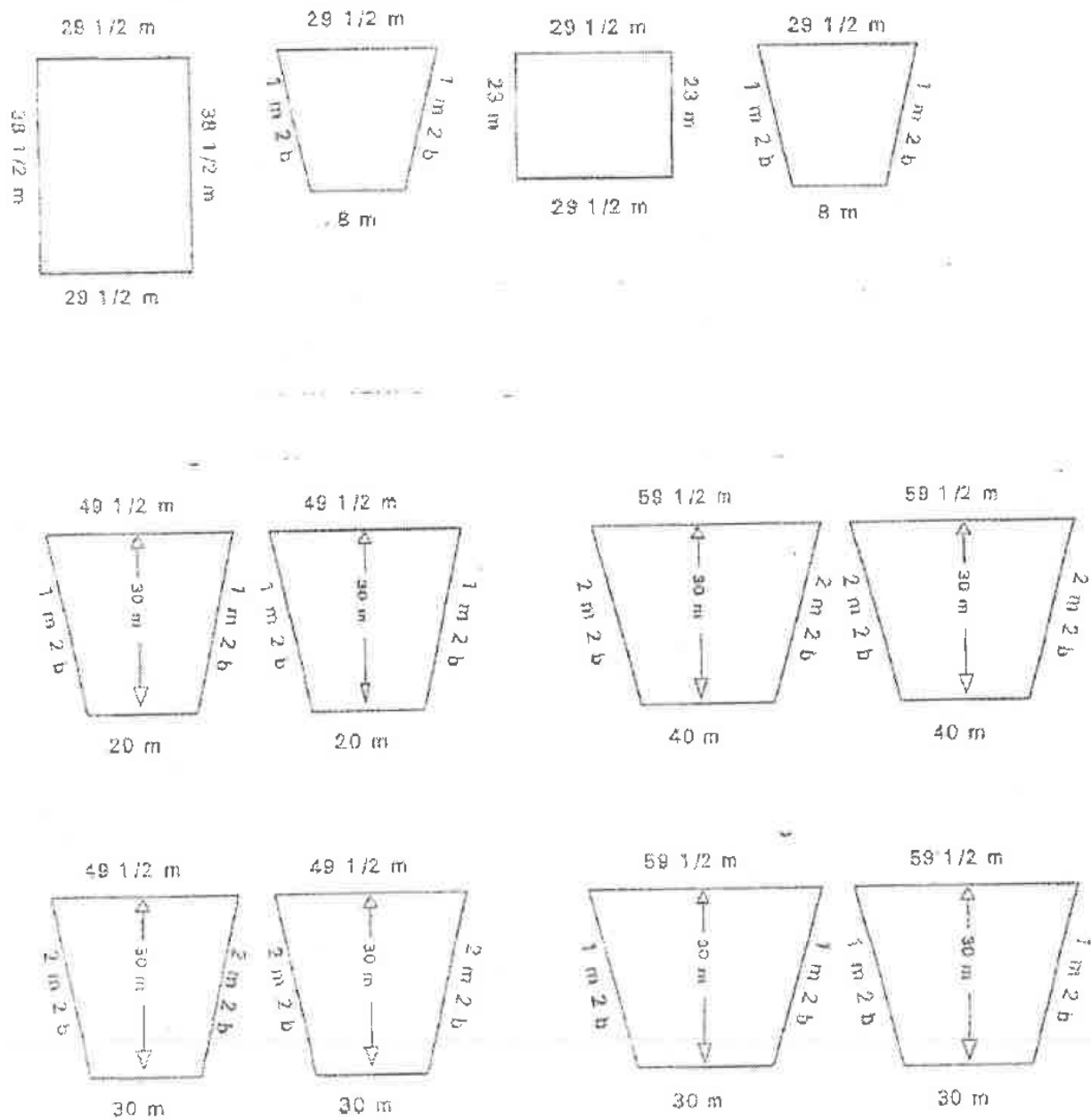
Top View



**Figure 8.** Top view of the Large Mesh and Extended Mesh Funnel BRDs (I.E., I.F., and I.G.).



**Figure 9.** Diagram of the modified large mesh funnel excluder (LMFE) (I.G.)



\* one of these four patterns may be used to construct the funnel for the large mesh funnel excluder.

**Figure 10.** Various funnel patterns of the Large Mesh Funnel Excluder (I.G.).

**PROCLAMATION**

**RE: SHRIMP TRAWL BYCATCH REDUCTION DEVICE REQUIREMENTS – PAMLICO SOUND AND PORTIONS OF THE PAMLICO, BAY, AND NEUSE RIVERS**

**This proclamation supersedes proclamation SH-1-2019 (REVISED) dated April 23, 2019. It clarifies the mesh size requirements for the trawl body and tail bag/cod end and continues specific bycatch reduction device requirements for taking shrimp with trawls (except as described in Section IV.) in Pamlico Sound and the Pamlico, Bay, and Neuse rivers where up to 220 feet of combined headrope is allowed.**

Stephen W. Murphey, Director, Division of Marine Fisheries, hereby announces that effective at 12:01 A.M. Monday, July 1, 2019 the following restrictions apply to shrimp trawls (skimmer trawls are exempt):

**I. SUSPENSION OF A PORTION OF N.C. MARINE FISHERIES COMMISSION RULE 15A NCAC 03L .0103**

The following portion of North Carolina Marine Fisheries Commission Rule 15A NCAC 03L .0103 is suspended effective at 12:01 A.M., Monday July 1, 2019:

Section (a)(1), which reads:

- (a) It is unlawful to take shrimp with nets with mesh lengths less than the following:  
(1) Trawl net – one and one-half inches;

**II. AREA DESCRIPTIONS:**

It is unlawful to take shrimp with trawls, except as described in Sections III and IV, in the areas listed below:

- (1) Pamlico Sound south of the 35° 46.3000' N latitude line and north of a line beginning at a point 34° 59.7942' N - 76° 14.6514' W on Camp Point; running easterly to a point 34° 58.7853' N - 76° 09.8922' W on Core Banks;
- (2) Pamlico River downstream of a line from a point 35° 18.5882' N - 76° 28.9625' W at Pamlico Point; running northerly to a point 35° 22.3741' N - 76° 28.6905' W at Willow Point;
- (3) Bay River downstream of a line from a point 35° 11.0858' N - 76° 31.6155' W at Bay Point; running southerly to a point 35° 09.0214' N - 76° 32.2593' W at Maw Point; and
- (4) Neuse River northeast of a line from a point 34° 58.2000' N - 76° 40.5167' W at Winthrop Point on the eastern shore of the entrance to Adams Creek; running northerly to a point 35° 01.0744' N - 76° 42.1550' W at Windmill Point at the entrance of Greens Creek at Oriental. See Map 1.

**III. GEAR RESTRICTIONS:**

In the areas described in Section II, it is unlawful to take shrimp with trawls with mesh lengths less than one and one-half inches in the body of the net, mesh lengths less than one and three-quarter inches in the tail bag/cod end of the net, and without authorized North Carolina Division



of Marine Fisheries (NCDMF) Bycatch Reduction Devices (BRD) properly installed and operational in the tail bag/cod end of EACH net as described below (Figure 1):

**A. Double Federal Fisheye (Figure 1, Table 1):**

1. Description: The Double Federal Fisheye BRD is two Federal Fisheye BRDs placed inline as described below. The Fisheye BRD is a pyramid-shaped rigid frame constructed from aluminum or steel rod of at least  $\frac{1}{4}$  inch (6.35 mm) diameter, which is inserted into the tail bag/cod end to form an escape opening. Minimum construction and installation requirements stated below.
2. The Federal Fisheye is a four-sided pyramid and has a minimum escape opening dimension of 6 inches (15.2 cm), minimum leg length of 12 inches (30.4 cm), and a minimum total escape opening area of 36 in<sup>2</sup> (91.4 cm<sup>2</sup>) [inside dimensions, not bar lengths] (Figure 1).
3. The Federal Fisheye shall be installed on the outside of the trawl. The webbing of the trawl attached to the Fisheye cannot cover more than 50% of the Federal Fisheye.
4. When the Federal Fisheye BRD is installed, no part of the lazy line attachment system (i.e., any mechanism, such as elephant ears or choker straps, used to attach the lazy line to the tail bag/cod end) may overlap the Federal Fisheye escape opening when the Federal Fisheye is installed aft of the attachment point of the tail bag/cod end retrieval system. The escapement opening shall remain unobstructed at all times.
5. The aft Federal Fisheye BRD must be installed at the top center of the tail bag/cod end of the trawl to create an escape opening in the trawl facing the direction of the mouth of the trawl no further forward than 65% of the functional tail bag/cod end length measured from the tail bag/cod end tie-off rings (Table 1).
6. Placement of the apex (narrow end) of the Federal Fisheye shall be toward the headrope of the trawl (forward).
7. The second Federal Fisheye BRD can be installed no further forward than 5 meshes from the apex of the primary Federal Fisheye BRD with the apex of the second Federal Fisheye BRD facing the headrope of the trawl.

**B. Virgil Potter BRD and one Florida Fish Excluder (Figures 2, 3 and 4, Table 1):**

1. Virgil Potter BRD  
Description: The Virgil Potter BRD is a radial escape section constructed of large mesh webbing hung on the square. Minimum construction and installation requirements stated below.
  - a. The radial escape section shall be constructed of a minimum of 8  $\frac{1}{2}$  inch stretch mesh that is five meshes long installed between the TED extension and the cod-end, and includes a funnel constructed of 1  $\frac{1}{2}$  inch stretch mesh (Figure 2, 3).
2. Florida Fish Excluder (FFE) (Figure 4 and Table 1):  
Description: pyramid-shaped rigid frame constructed from aluminum, steel, or stainless-steel round bar or tubing which is inserted into the tail bag/cod end to form an escape opening. Minimum construction and installation requirements stated below.
  - a. The FFE shall be installed on the outside of the trawl. The webbing of the trawl attached to the FFE cannot cover more than 50% of the FFE.
  - b. The escapement opening of the FFE shall be diamond in shape and shall remain unobstructed at all times. Diamond shaped FFE shall measure at least 5  $\frac{1}{2}$  inches x 6  $\frac{1}{2}$  inches or 6 inches x 6 inches, inside diameter (see Figure 4).
  - c. Placement of the apex (narrow end) of the FFE shall be toward the headrope of the trawl (forward).

- d. A FFE shall have at least three (3) legs and no more than four (4) legs and measure at least 12 inches in length (see Figure 4).
- e. The opening of the FFE shall be installed on the outside of the tail bag/cod end of the trawl no further forward than 65% of the functional tail bag/cod end length measured from the tail bag/cod end tie-off rings (Table 1).
- f. The center of the FFE escapement opening shall be installed no more than 19 meshes from the top centerline of the tail bag/cod end.
- g. A FFE shall be constructed from aluminum, steel, or stainless-steel round bar or tubing.
- h. When the FFE BRD is installed, no part of the lazy line attachment system (i.e., any mechanism, such as elephant ears or choker straps, used to attach the lazy line to the tail bag/cod end) may overlap the FFE escape opening when the FFE is installed aft of the attachment point of the tail bag/cod end retrieval system.

IV. **GEAR EXEMPTIONS:**

The gear restrictions in Section III do not apply to the following:

- D. Skimmer trawls; or
- E. A single test trawl net (try net) with a headrope length of 12 feet or less with a mesh size of one and one-half inches or greater, if it is operated under the following conditions:
  - 1. net is either pulled immediately in front of another net or is not connected to another net in any way;
  - 2. no more than one net is used at a time; and
  - 3. net is not towed as a primary net.

V. **DEFINITIONS:** For the purposes of this proclamation, the following terms are hereby defined:

- H. Bycatch reduction device (BRD) - any gear or trawl modification (including modifications to a TED that would enhance finfish exclusion) designed to allow finfish to escape from a shrimp trawl. BRD is defined based on its ability to facilitate the escape of finfish from a shrimp trawl.
- I. Turtle excluder device (TED) - An inclined grid or netting panel that prevents the passage of large animals such as sea turtles and large fish into the tail bag/cod end and guides them through an escape opening located in the tail bag/cod end. TED is defined based on its ability to exclude sea turtles from a shrimp trawl.
- J. Tail bag/cod end - That portion of the trawl net at which the trawl body's taper ends and the straight extension begins, extending to the terminal end of the trawl.
- K. Functional tail bag/cod end length - That length of the tail bag/cod end of a trawl beginning at the tail bag/cod end tie-off rings and extending forward for a maximum of 105 meshes or to the point where the straight extension ends and the trawl body taper begins, whichever is less. Trawls utilizing short tail bag/cod ends may include those meshes of the TED extension that are behind the TED grid and are in-line with the center of the FFE escape opening.
- L. Centerline - The line running from the center point of the headrope to the top center of the end of the tail bag/cod end.
- M. Radial escape section - This BRD features a guiding funnel to concentrate all animals into the middle of the tail bag/cod end and a panel of large square-meshes that extend radially around the tail bag/cod end that allows for fish escapement.
- N. Skimmer trawl - a trawl that is fished along the side of the vessel and is held open by a rigid frame and a lead weight. On its outboard side, the trawl is held open by one side of the frame extending downward and, on its inboard side, by a lead weight attached by cable or rope to the bow of the vessel.

- O. Try net – A net pulled for brief periods of time just before, or during, deployment of the primary net(s) in order to test for shrimp concentrations or determine fishing conditions (e.g. presence or absence of bottom debris, jellyfish, bycatch, seagrasses, etc.).

VI. **GENERAL INFORMATION:**

- K. This proclamation is issued under the authority of N.C.G.S. 113-170.4; 113-170.5; 113-182; 143B-289.52 and N.C. Marine Fisheries Commission Rule 15A NCAC 03J .0104(d).
- L. It is unlawful to violate the provisions of any proclamation issued by the Fisheries Director under his delegated authority per N.C. Marine Fisheries Commission Rule 15A NCAC 03H .0103.
- M. It is unlawful to use a shrimp trawl that does not conform with the federal requirements for Turtle Excluder Devices (TEDs) per N.C. Marine Fisheries Commission Rule 15A NCAC 03L .0103(h).
- N. **N.C. Marine Fisheries Commission Rule 15A NCAC 03L .0103(d) makes it unlawful to take shrimp with trawls with a combined headrope length greater than 220 feet in the areas described in Section II.**
- O. Channel nets, float nets, fixed nets, and butterfly nets are not required to use BRDs.
- P. The intent of this proclamation is to require the use of newly approved BRDs identified by a collaborative study that achieved at least a 40 percent finfish bycatch reduction in accordance with the N.C. Shrimp Fishery Management Plan Amendment 1.
- Q. Vessels operating in coastal fishing waters outside of those areas described in Section II. or using skimmer trawls must use a minimum of two authorized NCDMF BRDs as described in Proclamation SH-4-2019.
- R. Persons wishing to test BRD designs not covered by this proclamation may submit BRD designs to the NCDMF, Morehead City office, for consideration for field-testing.
- S. This proclamation only sets the gear requirements for taking shrimp with trawls in these areas as described in Section II., area openings and closings are done through separate proclamations. Individuals should check the division website (<http://portal.ncdenr.org/web/mf/>) for proclamations opening and closing specific areas for the taking of shrimp.
- T. Contact N.C. Division of Marine Fisheries, P.O. Box 769, Morehead City, NC 28557; 252-726-7021 or 800-682-2632 for more information or visit the division website at <http://portal.ncdenr.org/web/mf/>.
- U. In accordance with N.C. General Statute 113-221.1(c) All persons who may be affected by proclamations issued by the Fisheries Director are under a duty to keep themselves informed of current proclamations.
- V. **This proclamation supersedes proclamation SH-1-2019 (REVISED) dated April 23, 2019. It clarifies the mesh size requirements for the trawl body and tail bag/cod end and continues specific bycatch reduction device requirements for taking shrimp with trawls (except as described in Section IV.) in Pamlico Sound and the Pamlico, Bay, and Neuse rivers where up to 220 feet of combined headrope is allowed.**



BY: \_\_\_\_\_  
Stephen W. Murphey, Director  
DIVISION OF MARINE FISHERIES

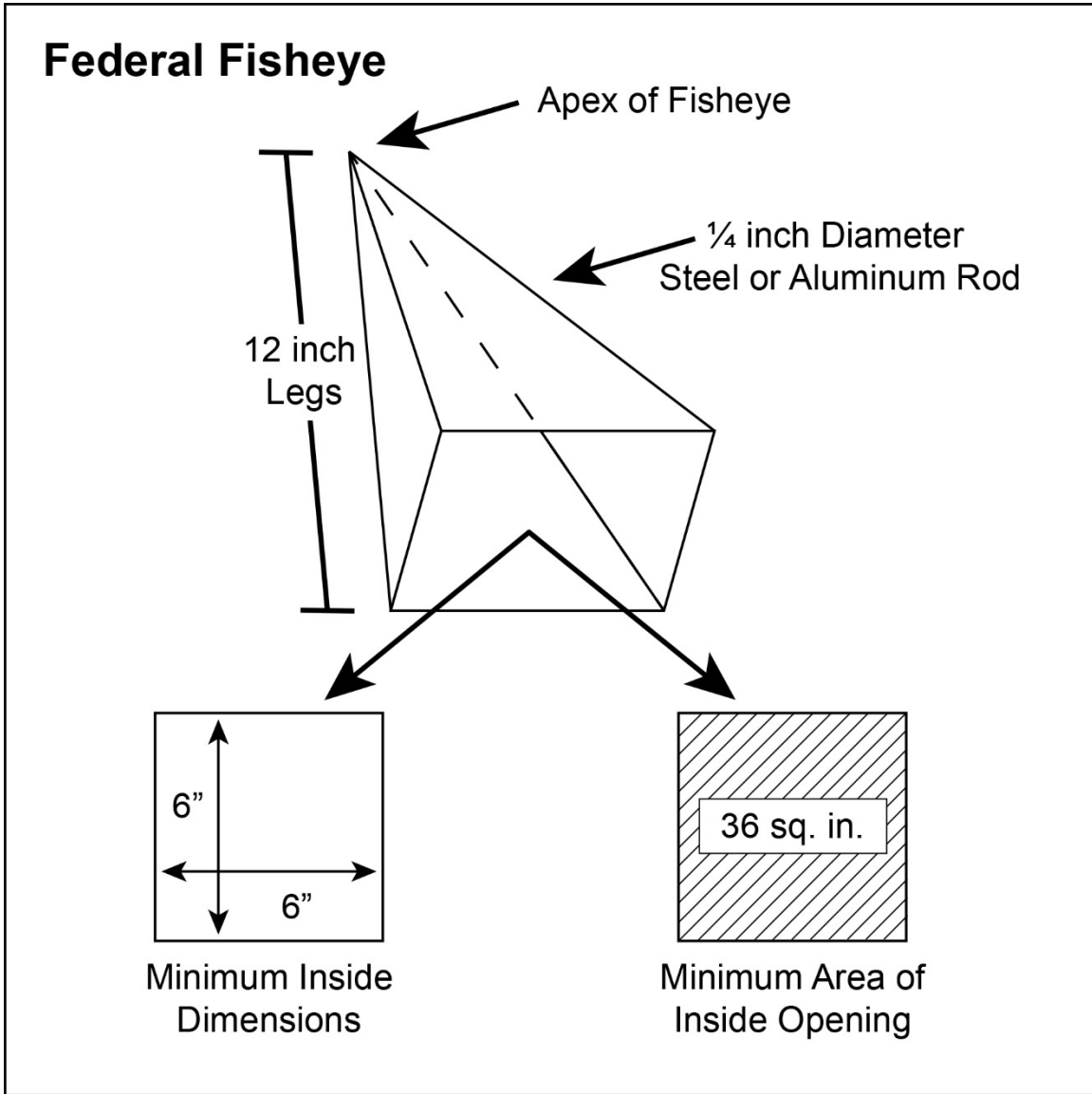
May 14, 2019  
10:20 A.M.

**Table 1.** Required placement of primary Federal Fisheye and Florida Fish Excluder.

Functional Tail bag/cod end Length*	Maximum FFE Placement**	Functional Tail bag/cod end Length**	Maximum FFE Placement**
105 meshes or greater	68 meshes	82	53
104	68	81	53
103	67	80	52
102	66	79	51
101	66	78	51
100	65	77	50
99	64	76	49
98	64	75	49
97	63	74	48
96	62	73	47
95	62	72	47
94	61	71	46
93	60	70	46
92	60	69	45
91	59	68	44
90	59	67	44
89	58	66	43
88	57	65	42
87	57	64	42
86	56		
85	55		
84	55		
83	54		

\* Functional Tail bag/cod end Length – That length of the tail bag/cod end of a trawl beginning at the tail bag/cod end tie-off and extending forward for a maximum of 105 meshes or to the point where the straight extension ends and the trawl body taper begins, whichever is less. Trawls utilizing short tail bag/cod ends may include those meshes of the TED extension that are behind the TED grid and are in-line with the center of the FFE escape opening.

\*\* If your tail bag/cod end is not included in this Table, you can figure the maximum placement for your net by following the formula: (mesh count multiplied by 65, divided by 100, using a 50 mesh tail bag/cod end as an example  $(50 \times 65) / 100 = 32.5$ ).

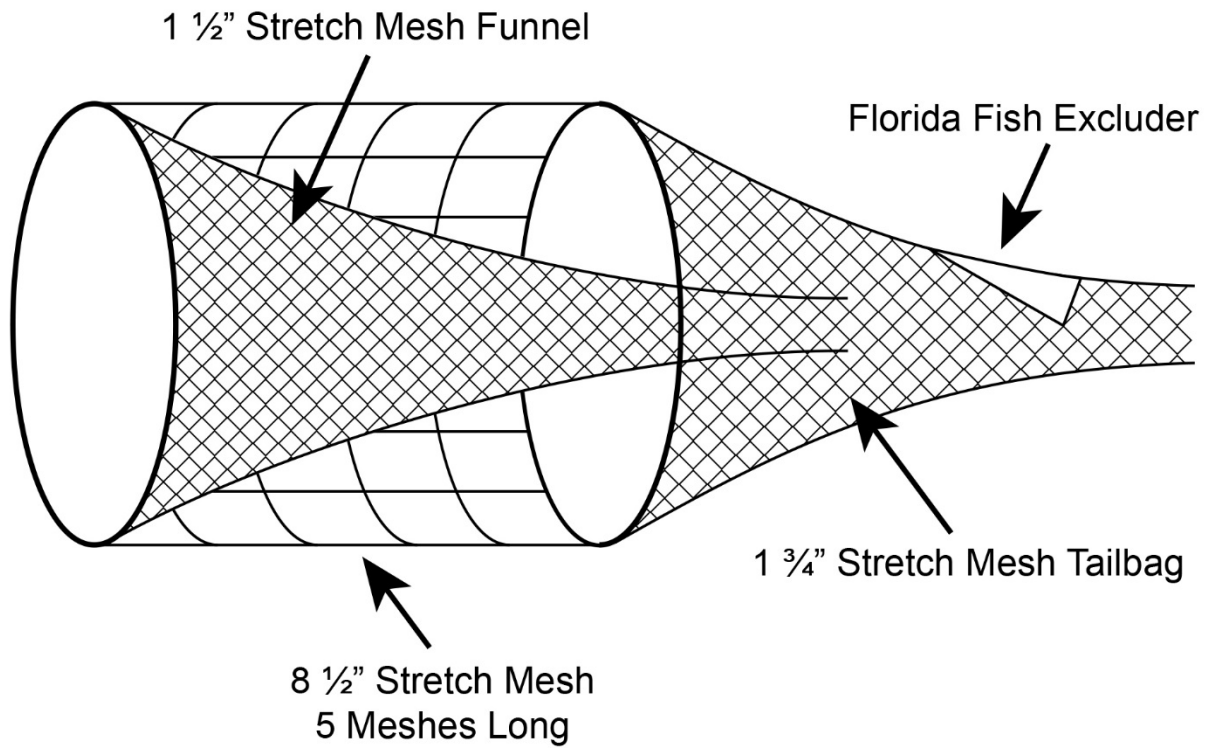


**Figure 1.** Minimum dimensions of the Federal Fisheye (III.A).

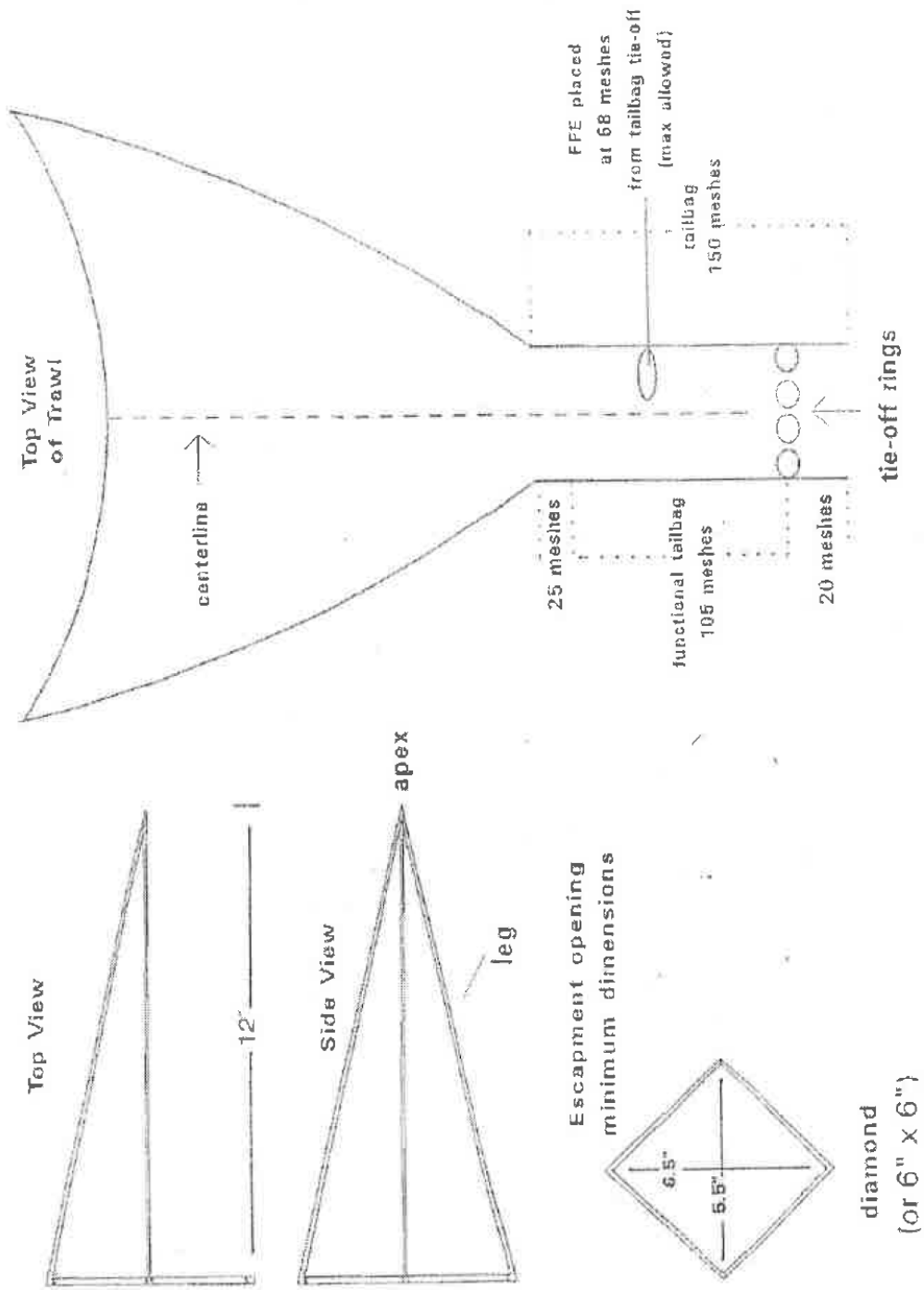


**Figure 2.** Virgil Potter BRD (III.B).

## Virgil Potter BRD



**Figure 3.** Specifications for the Virgil Potter BRD (III.B).



**Figure 4.** Diagram of Florida Fish Eye (FFE) (III.B).