

# NC Operator Certification Program

## Surface Irrigation of Wastewater

### Study Guide

Water Pollution Control System Operators Certification Commission  
North Carolina Department of Environmental Quality  
Division of Water Resources

[deq.nc.gov/opcert](http://deq.nc.gov/opcert)

Feb 2024





# Table of Contents

Purpose and Acknowledgements

Introduction

Needs-To-Know

Math Formulas

Chapter 1: Characteristics of Wastewater

Chapter 2: Pretreatment of Wastewater

Chapter 3: The Natural Treatment System

Chapter 4: Surface Irrigation Equipment

Chapter 5: Proper Wastewater Application

Chapter 6: Math

Chapter 7: Health and Safety

Chapter 8: North Carolina Regulations

List of Appendices found online at: [deq.nc.gov/opcert](http://deq.nc.gov/opcert)

Appendix A: Troubleshooting Preapplication Treatment Components

Appendix B: Guides to Proper Waste Application

Appendix C: Regulatory Information

Appendix D: Surface Irrigation Equipment

# Purpose

The purpose of this manual is simply to provide operators of surface (spray and drip) irrigation of wastewater systems the basic understanding needed to operate these systems in an efficient and environmentally sound manner. The purpose of this manual is not to provide all the technical details for the complete evaluation and design of a surface irrigation system for wastewater. There are many good reference materials that have been published on this subject that can provide more detailed information on the various topics discussed. Many of these materials will be referenced in this manual and it is hoped that you will make use of them during this course and as you continue to work with surface irrigation.

## Notes About This Manual

This manual has been written based on the current laws, rules, and technical guidance available at the time. It is possible, indeed likely, that there will be changes in the laws and technical guidance that apply to surface irrigation of wastewater. You should keep yourself aware of these changes. The organizations and government agencies that are involved in surface irrigation of wastewater will make efforts to inform individuals who own and operate surface irrigation of wastewater systems of these changes as they occur. However, you are ultimately responsible for ensuring that you are operating in compliance with current laws and rules. If you have questions, you should contact the appropriate resource people listed in Appendix B-1.

## Acknowledgements

This program is administered by the Water Pollution Control System Operators Certification Commission in conjunction with the North Carolina Department of Environmental Quality.

This manual is a combination of guidance materials gathered from various sources in conjunction with input and expertise from individuals with the following organizations:

- North Carolina State University Soil Science Department
- North Carolina State University Biological and Agricultural Engineering Department
- North Carolina Cooperative Extension Service
- Novo Nordisk BioChem North American, Incorporated
- City of Raleigh

## Introduction

Surface irrigation systems are wastewater treatment facilities that use spray or drip irrigation technologies to apply wastewater to land surfaces. These systems include some form of onsite wastewater pretreatment, ranging from simple septic tank/sand filter systems to sophisticated million gallon treatment plants.

Wastewater irrigation is a practical and environmentally friendly method of wastewater disposal. It provides water and nutrients to golf courses, lawns, forests, and crops. At the same time, it reduces or eliminates the need for wastewater discharges to local surface waters. Instead, as wastewater moves through the soil, naturally occurring processes provide additional treatment. Purified wastewater then recharges valuable groundwater resources.

As with any waste treatment process, however, mismanagement can result in negative consequences. Over-application of wastewater can result in runoff or leaching (downward movement) of contaminants to surface waters and groundwater. The result is that the system is no longer providing beneficial reuse of the wastewater but is causing negative consequences. Nutrients, metals, pathogens, salts, and chemicals in the wastewater can cause environmental problems or health concerns if not properly managed.

The goal of any wastewater treatment system is to treat the wastewater to a sufficient level to protect the public health and the environment, particularly surface and groundwater quality. The purpose of this manual and this training course is to educate operators of surface irrigation of wastewater systems in the proper operation and maintenance of these systems. These systems can effectively serve for many years and will gain public acceptance if properly operated.

A committee of experts in the wastewater, regulatory, soils, agronomy, engineering, and associated fields developed these training materials. The manual is based on a list of topics that the committee felt each operator of a surface irrigation of wastewater system should be familiar with. This list of objectives is called the “Needs-to-Know”.

The manual is relevant to the regulations and technology that existed at the time it was written. It is periodically updated to reflect changes in laws and technology. For example, interest in odor reduction from wastewater irrigation fields is increasing, thereby increasing the interest in using application equipment that distributes wastewater at or close to the ground surface. Distribution techniques such as low-drop nozzles on center pivot equipment and drip irrigation systems meet some of these needs in special cases.

However, this manual cannot cover every possible type of hardware that is used in the field. The basics of wastewater treatment, distribution, and site management will be discussed in some

detail, as these are applicable to all sites. Special and unique systems may be only briefly mentioned. The operator of these systems is encouraged to obtain more specific operation and maintenance information from the system manufacturer, designer, and/or installer.

There is also technical assistance available in the operation and maintenance of land-based wastewater and residuals treatment systems. References throughout the manual will refer the user to specialists for more information.

## Needs-To-Know (2013) Surface Irrigation of Wastewater North Carolina WPCSOCC

### Chapter 1 – Wastewater Characteristics

- 1-1. Identify the sources of wastewater.
- 1-2. Describe the difference between domestic and industrial wastewater and list concerns with application of high strength industrial waste.
- 1-3. Define inorganic and organic as they relate to wastewater treatment.
- 1-4. Describe several important physical characteristics of wastewater and identify unusual conditions that could affect system operation.
- 1-5. Define total, suspended, and dissolved solids and explain their importance in wastewater treatment.
- 1-6. Define BOD (Biochemical Oxygen Demand) and explain the importance of BOD in wastewater treatment.
- 1-7. Define organic loading rate.
- 1-8. Define dissolved oxygen and describe its importance in wastewater treatment.
- 1-9. Describe the difference between aerobic and anaerobic wastewater treatment.
- 1-10. Define pathogen and explain its relevance with wastewater treatment.
- 1-11. Identify what fecal coliform bacteria are and explain the role they play in wastewater treatment.
- 1-12. Define nutrients and explain their concentrations differ in domestic wastewater and some industrial wastewater.
- 1-13. Define hydraulic loading rate.
- 1-14. Explain why metals and synthetic organic chemicals are of concern in wastewater.
- 1-15. List the two types of fats, oils, and grease and describe their effects on wastewater treatment systems.
- 1-16. Describe soluble salts and why they may be a problem in a surface irrigation system.
- 1-17. Define pH, alkalinity, and acidity.

## Chapter 2 – Pretreatment of Wastewater

### 2.1 Lagoons

- 2-1. List the four types of stabilization lagoons.
- 2-2. Explain the differences between, and describe the general operating parameters for the following:
  - aerobic lagoons
  - aerated lagoons
  - anaerobic lagoons
  - facultative lagoons
- 2-3. Explain the difference between a stabilization lagoon and a storage lagoon.
- 2-4. Define freeboard and explain the importance of maintaining adequate freeboard.
- 2-5. Define short-circuiting and explain why it is undesirable.
- 2-6. Define detention time and explain its importance in wastewater treatment.
- 2-7. Describe the advantages of baffles/curtains in a lagoon system.
- 2-8. List the advantages of multiple cell lagoons and describe the difference between lagoons operated in series and lagoons operated in parallel.
- 2-9. List the factors that influence lagoon performance and describe their importance.
- 2-10. Define photosynthesis and describe why it is important in facultative lagoons.
- 2-11. Describe the daily fluctuation in dissolved oxygen and pH in a normally functioning facultative lagoon.
- 2-12. List probable causes and corrective actions to be taken for each of the following:
  - emergent and suspended aquatic vegetation
  - erosion
  - scum formation
  - excessive algae
  - solids accumulation
  - odor production
  - insufficient freeboard
  - short-circuiting
  - septicity
- 2-13. Describe the maintenance procedures for stabilization and storage lagoon dikes.



## *2.2 Tanks*

- 2-14. Identify the components and functions of a septic tank.
- 2-15. Define influent and effluent.
- 2-16. List the factors that affect septic tank performance.
- 2-17. Explain the effect of hydraulic and organic overloading on septic tanks.
- 2-18. Define infiltration and exfiltration and explain why each is undesirable.
- 2-19. Describe the procedure for inspecting a septic tank for infiltration or exfiltration.
- 2-20. Describe the problems that can occur with septic tanks and the visible signs that can indicate these problems.
- 2-21. Describe why, when, and how solids should be removed from septic and dosing tanks.
- 2-22. Describe how scum depth is measured in a septic tank.
- 2-23. Describe how solids (septage) accumulation is measured in a septic tank.
- 2-24. Identify the agency that permits the removal of solids from septic and dosing tanks.
- 2-25. Identify the function of a dosing tank.
- 2-26. Describe the different types of dosing mechanisms and list the advantages and disadvantages of each.
- 2-27. Describe the types of establishments that require the use of grease traps or oil/water separators.
- 2-28. Describe the components and the functions of a grease trap.
- 2-29. Describe, in general terms, the operation of grease traps associated with food service operations.
- 2-30. List the factors that affect grease trap performance.
- 2-31. Describe the importance of routine servicing of grease traps and identify who is authorized to dispose of grease from these units.
- 2-32. List the different types of oil/water separators associated with industrial operations and describe, in general terms, their operation.

## *2.3 Sand Filters*

- 2-33. Describe the purpose of a sand filter.
- 2-34. Describe the basic design of sand filters.
- 2-35. List the different types of treatment processes that occur within sand filters.
- 2-36. Explain why intermittent dosing of sand filters is important.
- 2-37. List three types of sand filters.

- 2-38. Explain recirculation and how it affects filter treatment efficiencies.
- 2-39. List the variables that affect sand filter operation and performance.
- 2-40. Describe the relationship between pretreatment and sand filter performance.
- 2-41. Explain how media size, uniformity and depth affect treatment.
- 2-42. Explain the effects of high hydraulic and/or organic loads on sand filters.
- 2-43. Describe methods for distributing effluent over a sand filter and explain why even distribution is important.
- 2-44. Describe the routine maintenance procedures that are required for proper operation of a sand filter.
- 2-45. Explain why vegetation is undesirable in a filter and how to properly control it.
- 2-46. Describe the importance of controlling infiltration/inflow and how it affects sand filters.

#### *2.4 Disinfection*

- 2-47. Identify the purpose of wastewater effluent disinfection.
- 2-48. Explain the difference between disinfection and sterilization of wastewater.
- 2-49. List the three major types of disinfection.
- 2-50. List the advantages and disadvantages of chlorination.
- 2-51. Identify the types of chlorine commonly used to disinfect treated effluent.
- 2-52. Define chlorine dosage, chlorine demand and chlorine residual.
- 2-53. Identify the approved methods for determining chlorine residual.
- 2-54. List and briefly describe the factors that affect chlorination effectiveness.
- 2-55. Briefly describe the methods of chlorination.
- 2-56. Describe procedures for chlorine leak detection and the importance of fixing leaks immediately.
- 2-57. Explain why petroleum products and solid chlorine compounds should not be stored in the same area.
- 2-58. Briefly describe ultraviolet radiation as a method of disinfection.
- 2-59. List the advantages and disadvantages of ultraviolet radiation.
- 2-60. List the factors that affect the effectiveness of ultraviolet radiation as a method of disinfection.

## Chapter 3 – The Natural Treatment System

### *Soils and Agronomy*

- 3-1. Describe the components that make up soil.
- 3-2. Define soil profile and soil horizon.
- 3-3. Describe (in general terms) the following soil characteristics and explain the relationship of these factors to the operation of a surface irrigation system:
  - soil texture
  - soil structure
  - infiltration
  - percolation and permeability
  - topography
  - restrictive horizons and soil depth
  - seasonal high water table
  - soil pH
  - cation exchange capacity
- 3-4. Explain the difference between infiltration and permeability.
- 3-5. Identify specific topography or landscape positions and describe how water movement is influenced by landscape position.
- 3-6. Define sodium adsorption ratio and explain its importance with land application of wastewater.
- 3-7. Define the following terms:
  - cations
  - anions
  - adsorption
  - exchangeable cations
  - soil solution
  - cation exchange capacity
- 3-8. Explain the relationship between pH and cation exchange capacity.
- 3-9. Define the following:
  - saturated zone
  - unsaturated zone
  - water table
  - groundwater
- 3-10. Explain the importance of depth to the water table at surface irrigation sites.
- 3-11. List the functions that vegetation plays in surface irrigation systems.

- 3-12. Define macronutrient and micronutrient and list examples of each.
- 3-13. List three factors that influence nutrient availability and describe their importance.
- 3-14. As related to nutrient availability, define:
- sufficiency
  - toxicity
  - deficiency
- 3-15. Define agronomic rate.
- 3-16. Define realistic yield expectation (R.Y.E.)
- 3-17. Define hydrologic cycle and describe (in general terms) its relationship to surface irrigation system operation and function.
- 3-18. Define evapotranspiration and describe its importance to surface irrigation system operation.
- 3-19. Name the various physical, chemical, and biological treatment processes that occur in the soil/plant system.
- 3-20. Describe the fate of these waste constituents once they enter the soil/plant system:
- nitrogen
  - phosphorus
  - heavy metals
  - pathogens
  - synthetic organic chemicals
- 3-21. Define runoff and describe the impact it can have on surface waters.
- 3-22. Define eutrophication.

## Chapter 4 – Equipment

### *4.1 Pumps and Controls*

- 4-1. Describe the purpose of a pump.
- 4-2. Define each of the following:
  - suction head (lift)
  - total dynamic head (TDH)
  - friction head
  - water horsepower
  - discharge head
  - brake horsepower
  - total pump capacity
  - motor horsepower
- 4-3. Explain how to calculate pump delivery rate.
- 4-4. Define dosing volume and describe how it is calculated.
- 4-5. Explain pump efficiency.
- 4-6. Describe a pump curve, where can it be obtained, and how can it be used.
- 4-7. Identify the problems which are associated with the condition that occurs when either the suction or discharge head exceeds the pump capacity.
- 4-8. Using diagrams, be able to identify the components of the following types of pumps. Describe applications for each type of pump and list the advantages and disadvantages of using the pump in each application. Describe the hydraulic and solids handling capacity of each type of pump:
  - centrifugal
  - positive displacement, plunger type
  - turbines
  - positive displacement, diaphragm
  - peristaltic pumps
  - positive displacement, progressive cavity (screw-flow) type
- 4-9. Identify the importance of maintaining a water level equal to or above the top of a submersible pump.
- 4-10. Describe the effect of improper (too loose or too tight) pump packing on the operation and efficiency of a pump.
- 4-11. Describe the effect of improper lubrication on the operation and efficiency of pumps.
- 4-12. Identify which pumps must normally be primed to operate.

- 4-13. Identify situations that would cause a loss of prime and explain how to re-prime the pump.
- 4-14. Describe cavitation and how it affects a centrifugal pump.
- 4-15. Describe how a water hammer is created and how it affects pumps and piping.
- 4-16. Identify the proper location for and protection of electrical connections and controls.
- 4-17. Identify the purpose and function of simplex and multiplex controls.
- 4-18. Describe how each of the following pump controls work:
- bubble tubes
  - float switches
  - electrode switches
  - pressure bulbs
  - pump alternator
  - irrigation controller
- 4-19. Explain the purpose of alternating the operation of two or more pumps.
- 4-20. Identify and describe the various types of water level alarms commonly used and explain how they work.
- 4-21. Identify the purpose and function of each the following control panel components:
- elapsed time meters
  - run cycle timers
  - relays
  - telemetry
  - alternators
  - time delay relays
  - microprocessors
- 4-22. Explain the importance of flow meters, pump run timers, and run counters and the requirements for their calibration.
- 4-23. Describe how to use pump control records to determine system performance.

#### *4.2 Distribution Network and Devices*

- 4-24. Define the following term and abbreviations as they relate to piping:
- I.D.
  - O.D.
  - I.P.S.
  - P.I.P.
  - Class
  - S.D.R.
- 4-25. Explain how to interpret SDR values.

4-26. Identify the following common types of irrigation pipes, fittings, connections, and valves and state the application of each in a surface irrigation system:

- Pipe
  - cast iron
  - steel
  - aluminum
  - DIP (ductal iron pipe)
  - PVC (Schedule 40 & 80)
- Fittings
  - elbow
  - tees
  - adapter
  - reducer
  - coupling
  - wye
  - union
- Connections
  - flange
  - mechanical joint
  - bell and spigot
  - threaded
- Valves (Manual or Motor Activated)
  - gate
  - ball
  - globe
  - butterfly
  - check
  - air relief
  - pressure relief
  - pressure reducing/regulating
  - solenoid

4-27. Explain the difference between Schedule 40 and 80 PVC pipe.

4-28. Describe a typical pipe cleanout and explain how and why it would be used.

4-29. Describe the importance of anchoring pipes securely and how thrust blocking is used.

4-30. Explain how PVC cement works and where it should be used.

4-31. Identify the following common types of distribution devices:

- rotary impact

- big gun
  - nozzle
  - full circle
  - partial circle
  - micro spray heads
  - drip emitters
- 4-32. Describe the following types of irrigation systems, and list several advantages and disadvantages of each:
- stationary or solid set
  - travelers
  - center pivot and linear move
- 4-33. Explain the difference between a ring nozzle and taper bore nozzle on an irrigation gun.
- 4-34. Explain the importance of knowing where all the underground system components are and maintaining plans or maps of these components.
- 4-35. Describe appropriate places for checking pressure heads in a surface irrigation system.



## Chapter 5 – Proper Waste Application

### *5.1 Irrigation Scheduling*

- 5-1. Define irrigation scheduling.
- 5-2. List the three questions that must be answered before irrigating treated wastewater.
- 5-3. Explain the importance of soil moisture monitoring as it relates to operations at land-based waste treatment systems.
- 5-4. List three methods to estimate the amount of water present in the soil at the start of irrigation.
- 5-5. Explain why wastewater application must be adjusted seasonally.
- 5-6. List five factors that may influence the amount of wastewater that can be irrigated.
- 5-7. Describe how infiltration rate affects wastewater application.
- 5-8. Explain how to determine how much wastewater to irrigate.
- 5-9. Explain why the “permitted” application amount or rate is not feasible at all times.
- 5-10. Define discharge rate, precipitation rate, and application depth.
- 5-11. Explain why stationary sprinklers are designed to overlap.
- 5-12. Understand how to determine the discharge rate and coverage diameter from manufacturer’s literature for stationary and traveling gun sprinklers.
- 5-13. Understand how to calculate the precipitation rate, application volume, and time of operation for stationary sprinklers.
- 5-14. Understand how to calculate the application volume and travel speed for a traveling gun sprinkler.
- 5-15. Explain what effect changing nozzle diameter can have on discharge rate and wetted diameter.
- 5-16. Explain the effects of changing pressure on droplet size, drift, precipitation rate, and wetted sprinkler diameter.
- 5-17. Explain why sprinkler systems should be field calibrated.
- 5-18. Explain calibration procedures for stationary and traveling sprinklers.

### *5.2 Sampling*

- 5-19. Describe how to determine permit sampling requirements and frequencies.
- 5-20. Describe how to take a soil sample and submit for analysis.
- 5-21. Describe, in general terms, the information available on a soil test report.

- 5-22. Describe the proper procedure for taking soil and plant tissue samples for analysis by an agronomy lab such as NCDA.
- 5-23. Describe the role of plant tissue analysis in managing and monitoring cover crops at a surface irrigation facility.
- 5-24. Describe how to take a waste sample from a lagoon and submit it for analysis.
- 5-25. Define the following terms:
- representative sample
  - grab sample
  - composite sample
  - flow proportional composite
  - timed composite
  - split sample
  - duplicate sample
- 5-26. Describe the need for proper sampling techniques and holding times.
- 5-27. Describe the importance of sampling groundwater at a surface irrigation site.
- 5-28. Describe how to minimize contamination risks while collecting groundwater samples.

### *5.3 Operations and Maintenance and Site Management*

- 5-29. List several situations that might require an operator to vary the hydraulic loading rate.
- 5-30. Identify situations that may indicate that a system's malfunction is related to a "soil-related problem" rather than a mechanical one and describe management techniques that can be used to correct or minimize these problems.
- 5-31. Describe the relationship between hydraulic loadings and surface crusting, surface ponding and surface runoff.
- 5-32. Describe the importance of limiting traffic on spray fields.
- 5-33. List several soil characteristics that affect a soil's ability to assimilate heavy metals.
- 5-34. Explain the relationship between soil pH and metal solubility in the soil.
- 5-35. Define the range of Sodium Adsorption Ratio's (SAR's) encountered in wastewater treatment and identify the SAR action level.
- 5-36. Explain why someone should call for technical assistance when the SAR level of the effluent is greater than 5.
- 5-37. Define Exchangeable Sodium Percentage (ESP) and describe the levels of ESP that should be of concern to a surface irrigation system operator.
- 5-38. Describe the importance of good cover crop management.

- 5-39. List the factors that should be considered when selecting crops for a surface irrigation system and describe why these factors are important.
- 5-40. Explain why perennial grass sods are effective in reducing erosion and nutrient losses.
- 5-41. Explain why harvesting the cover crop at a surface irrigation system is essential.
- 5-42. Explain why maintaining proper soil pH is critical to the management of a surface irrigation system.
- 5-43. List the agencies or groups that can be contacted for technical assistance with crop and/or site management.
- 5-44. Describe how to recognize poor crop health.
- 5-45. List the steps that should be taken if a suitable vegetative cover is not present at a land application site.
- 5-46. Describe how soil test and plant tissue analysis information can be used in site management.
- 5-47. Explain why uniform distribution of effluent in fields is important.
- 5-48. Explain bleed-off within the system and describe the procedures for minimizing negative impacts.
- 5-49. Identify site conditions that indicate hydraulic overload and list possible actions to minimize hydraulic overload.
- 5-50. Explain how to determine leakage around piping and valves.
- 5-51. Identify evidence of damaged or improperly constructed appurtenances including groundwater monitoring wells.
- 5-52. Given precipitation and flow data from a system, determine what this information might imply about potential system problems (in/exfiltration).
- 5-53. Describe the need to periodically calibrate flow-measuring devices.
- 5-54. Explain where to find manufacturers literature on site-specific components and the need to perform service on these components.
- 5-55. Explain how to inspect and maintain the following:
- French drain or curtain drain
  - Open drainage ditch and tiled ditches
  - Terrace or other surface water diversions (e.g., grass waterways)
- 5-56. List conditions under which an operator may need to look for expansion sites.
- 5-57. Explain the contents of the site operation and maintenance manual.
- 5-58. Identify the information that should be recorded in a daily site maintenance logbook.
- 5-59. Describe an emergency action plan.

- 5-60. List the four basic steps that should be followed in the event of a chemical spill or a release of wastes at a surface irrigation facility.
- 5-61. Explain which agencies should be contacted in the event of a spill or release.
- 5-62. Describe the importance of controlling access to spray fields.

## Chapter 6 – Math

### *Common Abbreviations*

L	=	liter
A	=	area (ft <sup>2</sup> )
V	=	Volume (ft <sup>3</sup> , gallons, etc)
ft	=	feet
ft <sup>2</sup>	=	square feet
ft <sup>3</sup>	=	cubic feet
Q	=	quantity of flow per unit of time
in	=	inches
gpm	=	gallons per minute
gpd	=	gallons per day
cfs	=	cubic feet per second
ac	=	acre
ppm	=	parts per million (mg/L)
ppb	=	parts per billion (µg/L)
psi	=	pounds per square inch
min	=	minute
mL	=	milliliter
mg/L	=	milligrams per liter

PAN	=	plant available nitrogen
lbs	=	pounds
conc	=	concentration
gal	=	gallons
cm	=	centimeter
mph	=	miles per hour
MGD	=	million gallons per day
m <sup>3</sup>	=	cubic meters
C	=	carbon
DO	=	dissolved oxygen
%	=	percent
=	=	equal to
>	=	greater than
<	=	less than
≈	=	approximately
hrs	=	hours

### ***Definitions***

**Area** - the measurement of a surface in square units such as feet squared, yards squared, etc.

**Circumference of a Circle** - the length of the external boundary of a circle; for example, the rim of a basketball goal is 62".

**Concentration (mg/L)** - the amount of a substance in a given volume such, as 1 mg/L.

**Diameter of a Circle** - distance from one side of a circle to the other, such as a 3 inch inside diameter of a pipe.

**Radius of a Circle** - one half the diameter of a circle.

**Flow Rate** - the volume of a substance that would pass a point in a given amount of time, such as 2 gallons per minute flowing out of the end of a hose.

**Field Flow Rate** - total gpm for a field (unit area).

**Friction** - the energy lost by any system in motion due to the rubbing of molecules, for example, friction losses in a pipe.

**Head** - the distance that water under pressure would rise in a pipe if allowed to do so, such as two feet of head in the distribution lateral.

**Hydraulic Soil Loading Rate** - the number of inches of wastewater applied to an area of soil in a day, such as 0.5 in/day.

**Hourly Loading Rate** - the number of inches of wastewater applied to an area of soil in an hour, such as 0.2 in/hr.

**Pi ( $\pi$ )** - a known ratio that is constant in the geometry of circles ( $\pi = 3.14$ ).

**Pressure** - the force applied to a unit area, such as the pressure in a water pipe.

**Volume** - the capacity of a container, such as a 1 gallon bucket.

### ***Conversion Factors***

1 acre (ac)	=	43,560 square feet (ft <sup>2</sup> )
1 acre-inch (ac-in)	=	27,152 gallons per acre (gal/ac)
1 cubic foot (ft <sup>3</sup> )	=	7.48 gallons
1 gallon of water	=	8.34 pounds of water
1 milligram/Liter (mg/L)	=	0.226 pounds per acre-inch (lbs/ac-in)

### ***Important Equations***

- 6-1. Calculate the area of squares, rectangles, and circles.
- 6-2. Calculate volume of tanks, cylinders, storage ponds, and lagoons.
- 6-3. Calculate the detention time of a structure given the volume and flow data.
- 6-4. Calculate pump delivery rate.
- 6-5. Convert concentration (mg/L) to pounds.
- 6-6. Calculate pounds of a substance given wastewater flow and concentration.
- 6-7. Calculate average flow rates.
- 6-8. Calculate horsepower.
- 6-9. Calculate pump delivery rate.
- 6-10. Calculate the hydraulic loading rate given flow and area.
- 6-11. Calculate hydraulic soils loading rate given flow and area.

- 6-12. Calculate flow rate given hydraulic soils loading rate and area.
- 6-13. Calculate area given hydraulic soils loading rate and flow rate.
- 6-14. Calculate hourly hydraulic soils loading rate given flow and area.
- 6-15. Convert flow data (GPD) to application depth (acre-inches).
- 6-16. Calculate plant available nitrogen (PAN).
- 6-17. Calculate sodium adsorption ratio (SAR) from a wastewater analysis.
- 6-18. Calculate exchangeable sodium percentage (ESP) from a soil analysis.
- 6-19. Calculate the application rate (precipitation rate) for stationary spray systems.
- 6-20. Determine time of system operation given application depth and application rate.
- 6-21. Calculate travel speed for traveling application equipment to meet a desired application rate.

## Chapter 7 – Health and Safety

- 7-1. List the federal and state agencies that oversee worker safety in North Carolina.
- 7-2. Describe the health and safety responsibilities of the following:
  - surface irrigation system owners
  - site supervisors
  - employees
- 7-3. List the components of a typical health and safety program.
- 7-4. Describe the information and training employers are required to provide regarding in-house chemicals.
- 7-5. Describe the types of personal protective equipment needed for working in and around surface irrigation facilities.
- 7-6. List the health and safety hazards associated with surface irrigation facilities.
- 7-7. List the health and safety measures that should be used to reduce health and safety hazards at surface irrigation facilities.
- 7-8. Explain when a process safety management and/or risk management program may be necessary.
- 7-9. Define the two types of confined spaces and describe the hazards associated with each.
- 7-10. Define “oxygen-deficient atmosphere” and describe the equipment required to enter such an atmosphere.
- 7-11. Describe “lockout/tagout” policies.
- 7-12. List the types of first aid training that are important for employees of a surface irrigation facility.
- 7-13. Describe the routine safety measures that should be followed when servicing surface irrigation equipment.
- 7-14. Explain the safety concerns of using traveling guns on sloping terrain.
- 7-15. Explain machine guarding.
- 7-16. Describe the safety procedures that should be followed when working around lagoons.
- 7-17. Describe the public health significance of vectors that may come into contact with wastewater.
- 7-18. Explain how to avoid contamination of ditches, waterways, and adjoining properties.



## Chapter 8 – North Carolina Regulations

### *8.1 Permit Regulations and Requirements*

- 8-1. Identify the regulations that govern the permitting of surface irrigation systems.
- 8-2. Identify the division of state government that is responsible for permitting surface irrigation systems.
- 8-3. Define non-discharge system.
- 8-4. Describe, in general, the application process for a new surface irrigation facility.
- 8-5. Explain the requirement for an annual permit fee and describe the consequences for not paying it.
- 8-6. Describe the need to have a copy of the non-discharge permit and the importance of reading and understanding it.
- 8-7. Describe the renewal requirements for a surface irrigation system permit.
- 8-8. Explain when a permit modification is required and give examples of changes that would require a modification.
- 8-9. Describe the minimum setback distances that must be maintained for surface irrigation systems.
- 8-10. List the operation and maintenance requirements contained in a typical spray (or drip) irrigation system permit.
- 8-11. Describe the importance of maintaining an inspection log.
- 8-12. Identify what state agency must be notified in the event of non-compliance with permit conditions and within what time period this notification must take place.
- 8-13. Describe situations or events that would require non-compliance notification.

### *8.2 Monitoring and Reporting Requirements*

- 8-14. List the types of monitoring that may be required in a surface irrigation system permit.
- 8-15. List the two types of activities that require monthly reporting.
- 8-16. Identify the form on which irrigation data must be reported, describe when the report is due, and list the information that must be reported on the form.
- 8-17. Identify the form on which wastewater or effluent monitoring data must be reported, describe when the report is due, and list the information that must be reported on the form.
- 8-18. Identify the state agency to which reports must be sent.
- 8-19. Identify who is ultimately responsible for the violation of a permit condition.

- 8-20. Describe the consequences for failing to comply with all monitoring and reporting requirements contained in a surface irrigation system permit or for violating other permit conditions.

### ***8.3 Groundwater Regulations and Requirements***

- 8-21. Identify the regulations that govern the maximum acceptable levels for parameters in groundwater.
- 8-22. Describe how to determine if a system's non-discharge permit requires monitoring wells and how to find out where they are located at the site.
- 8-23. Define compliance boundary and explain what actions are necessary if groundwater standards are exceeded at this boundary.
- 8-24. Define review boundary and explain what actions are necessary if groundwater standards are exceeded at this boundary.
- 8-25. Describe the proper exterior condition and labeling of a groundwater monitoring well.
- 8-26. Describe the importance of obtaining background or baseline groundwater samples prior to waste disposal activities.
- 8-27. Describe routine maintenance for groundwater monitoring wells.
- 8-28. Identify the report form that must be used to report groundwater monitoring data.
- 8-29. Describe how to complete a groundwater monitoring form.
- 8-30. Identify the state agency to which groundwater monitoring report forms must be sent.

### ***8.4 Operator Regulations and Requirements***

- 8-31. Identify the regulations that govern the actions of certified operators.
- 8-32. Identify the state agency that administers the operator certification program.
- 8-33. Identify the Commission that oversees the operator certification program.
- 8-34. Describe the responsibilities of the permittee with regards to designating an Operator in Responsible Charge (ORC) and Back-up Operator(s) in Responsible Charge (Back-up ORC).
- 8-35. Describe the basic requirements to obtain a surface irrigation system operator certificate.
- 8-36. List the responsibilities that all certified operators must fulfill to maintain their certification.
- 8-37. List the responsibilities of a certified operator that has been designated as the Operator in Responsible Charge for a surface irrigation system.
- 8-38. Describe the minimum visitation required from the ORC for a surface irrigation system.
- 8-39. Describe the difference between the ORC's responsibilities and the owner's responsibilities.

- 8-40. Describe the need to keep the permittee informed of any necessary repairs or maintenance.
- 8-41. Describe the responsibilities of a certified operator that has been designated as the Back-up ORC for a surface irrigation system.
- 8-42. Describe the circumstances under which a designated Back-up ORC may act as a surrogate for the ORC.
- 8-43. Define contract operations firm and describe their responsibilities.
- 8-44. Describe the types of disciplinary action the Certification Commission (WPCSOCC) may take against a certified operator.
- 8-45. Describe the grounds for action by the Certification Commission (WPCSOCC) against a certified operator.
- 8-46. Describe the terms for recertification following a disciplinary action by the Certification Commission (WPCSOCC).

## Surface Irrigation System Formulas

Area of Square or Rectangle (ft<sup>2</sup>) = length x width

Area of Circle (ft<sup>2</sup>) = 3.14 x radius<sup>2</sup> =  $\pi$  x radius<sup>2</sup> =  $\pi r^2$

Volume of Rectangular Tank (ft<sup>3</sup>) = length x width x depth

Volume of Cylindrical Tank (ft<sup>3</sup>) = area x height =  $\pi r^2$  x h

Volume of Tank (gal) = volume of tank (ft<sup>3</sup>) x 7.48 gal/ft<sup>3</sup>

Detention Time (unit of time) =  $\frac{\text{volume (gallons or ft}^3\text{)}}{\text{flow (volume/unit of time)}}$

Pounds per day (lbs/day) = concentration (mg/L) x flow (MGD) x 8.34 lb/gal

Pounds per year (lbs/year) = mg/L x MGY (annual effluent application) X 8.34 lb/gal

Concentration (mg/L) =  $\frac{\text{lbs}}{\text{flow (MGD) x 8.34 lb/gal}}$

Flow Rate (volume/unit time) = area (ft<sup>2</sup>) x velocity (feet per minute)

Horsepower =  $\frac{\text{flow (gpm) x total dynamic head (TDH)}}{3960 \text{ x pump efficiency x motor efficiency}}$

Pump Delivery Rate =  $\frac{\text{volume pumped (gal)}}{\text{pump run time}}$

Pump Delivery Rate Efficiency (%) =  $\frac{\text{Measured pump delivery rate (gpd)}}{\text{design pump delivery rate (gpd)}} \times 100$

Hydraulic Loading Rate (gpd/ft<sup>2</sup>) =  $\frac{\text{flow (gpd)}}{\text{area (ft}^2\text{)}}$

Hydraulic Soils Loading Rate (in/day) =  $\frac{\text{flow (gpd)}}{27,152 \text{ gal/acre-inch x area (acres)}}$

## Surface Irrigation System Formulas

Plant Available Nitrogen (PAN)

$$\text{Surface application} = [\text{MR} \times (\text{TKN} - \text{NH}_4)] + (0.5 \times \text{NH}_4) + \text{NO}_3 + \text{NO}_2$$

where: MR = Mineralization Rate

TKN = Total Kjeldhal Nitrogen

$$\text{Sodium Adsorption Ratio (SAR)} = \frac{\text{Na (meq)}}{\sqrt{0.5 \times (\text{Ca (meq)} + \text{Mg (meq)})}}$$

$$\text{Milliequivalent (meq)} = \frac{\text{Concentration}}{\text{Equivalent weight}}$$

$$\text{Exchangeable Sodium Percentage (ESP)} = \frac{\text{Na (meq/100 cm}^3\text{)}}{\text{CEC (meq/100 cm}^3\text{)}} \times 100$$

$$\text{Precipitation rate for stationary sprinklers (in/hr)} = \frac{96.3 \times \text{discharge rate (gpm)}}{\text{sprinkler spacing (ft)} \times \text{lateral spacing (ft)}}$$

$$\text{Time of operation (hours)} = \frac{\text{target application depth (in)}}{\text{precipitation rate (in/hr)}}$$

$$\text{Application depth for traveling gun sprinkler (in)} = \frac{19.3 \times \text{sprinkler discharge rate (gpm)}}{\text{lane spacing (ft)} \times \text{travel speed (in/min)}}$$

$$\text{Travel speed for traveling gun sprinkler (in/min)} = \frac{19.3 \times \text{sprinkler discharge rate (gpm)}}{\text{lane spacing (ft)} \times \text{application depth (in)}}$$

1 acre = 43560 square feet



# Chapter 1

## Wastewater Characteristics

Wastewater is water that has been affected by human use. To protect public health and the environment, it must be collected and treated. To properly operate and maintain a surface irrigation system, you need to understand some basic characteristics of the wastewater you will be treating. These characteristics are important factors in the design, operation, and management of any wastewater treatment system.

The physical and biological characteristics and chemical composition of wastewater can differ widely. The characteristics and composition of a single waste stream depends on its source.

### Sources of Wastewater

Wastewater comes from either domestic sources or industrial sources. Domestic sources include residences, non-industrial businesses, and institutions, such as schools. Wastewater from restrooms, laundries, and kitchens is considered domestic wastewater. It is often referred to as sewage. Wastewater from domestic sources is fairly uniform in composition and dilute in strength.

Industrial wastewater is used water produced by industrial activity. Examples are factories, mills, mines. The characteristics of industrial wastewater can vary greatly from one industry to the next. It may contain toxic substances or be very high strength.

A particular waste stream can contain wastewater from domestic sources, industrial sources, or a combination of both, although the most common sources of wastewater are domestic.

### Characteristics of Wastewater

Physical characteristics of wastewater include color, odor, temperature, and solids. Changes in these physical characteristics can indicate unusual influent or operating conditions.

#### Color

Fresh or raw (prior to any treatment) domestic wastewater is usually gray in color. Wastewater that has undergone some type of pretreatment will have a color that is indicative of the pretreatment system. Wastewater treated in a septic tank will have a gray/black color, but wastewater that has been treated in an aerobic process will have little color. The color of wastewater can also be affected by inputs from industrial sources. Color contributed from industrial sources may not be removed by the preapplication treatment system.

## Odor

Fresh or raw domestic wastewater usually has a musty odor. Odor in wastewater is generally caused by anaerobic decomposition of organic material. Hydrogen sulfide is frequently the source of a rotten-egg odor in wastewater. Other volatile sulfur-containing compounds, such as mercaptans, can also cause noxious odors. When wastewater is aerated or comes into contact with the land surface or water, these odors are released into the air. Unusual odors, such as petroleum or solvent odors can indicate abnormal industrial discharges.

## Temperature

Wastewater is generally somewhat warmer than unheated tap water. A significant increase in wastewater temperature over a short period of time may indicate an unusual industrial discharge; a significant decrease may indicate inputs of storm water into the treatment system.

Temperature influences microbial activity, an important mechanism of wastewater treatment. Up to a point, an increase in wastewater temperature will increase microbial activity. However, when wastewater reaches high temperatures, microbial activity will be inhibited. The temperature of irrigated wastewater can also have a negative effect on cover crops.

## Solids

Solids can be categorized by their physical state: total solids, dissolved solids, and suspended solids. The different fractions of solids are shown in Figure 1-1.

- **Total Solids (Residue)**

Total solids are those that remain after the wastewater is evaporated at a temperature of 103°C to 105°C. Imagine that an operator collects a one-liter sample of influent (wastewater entering a treatment system). This sample is heated to evaporate all the water. The remaining solids weigh 1000 milligrams. Thus, the total solids (residue) concentration in the sample is 1000 milligrams per liter (mg/L). This weight includes both dissolved and suspended solids.

- **Dissolved Solids**

Dissolved solids are those solids that will pass through a very fine (0.45-mm) membrane filter. Again, imagine that an operator collects a one-liter sample of raw wastewater and filters it through a very fine mesh filter such as a fiberglass filter. The dissolved solids will pass through the water. The operator can now evaporate the water and weigh the residue. In Figure 1-1, the amount of dissolved solids is 800 mg/L. Dissolved solids are also called filterable residue.

For normal municipal wastewater that contains domestic wastewater as well as some



industrial wastes, the concern of an operator is usually to remove the dissolved organic solids from the waste stream. Removal of dissolved inorganic solids is difficult to achieve.

### ○ **Suspended Solids**

Suspended solids (SS) are the solids retained by a filter. They can be removed from a waste stream by physical, biological, or chemical processes. Suspended solids are composed of two parts: settleable and nonsettleable (or colloidal). The difference between settleable and nonsettleable solids depends on the size, shape, and weight of the solid particles. Larger particles tend to settle more rapidly than smaller particles.

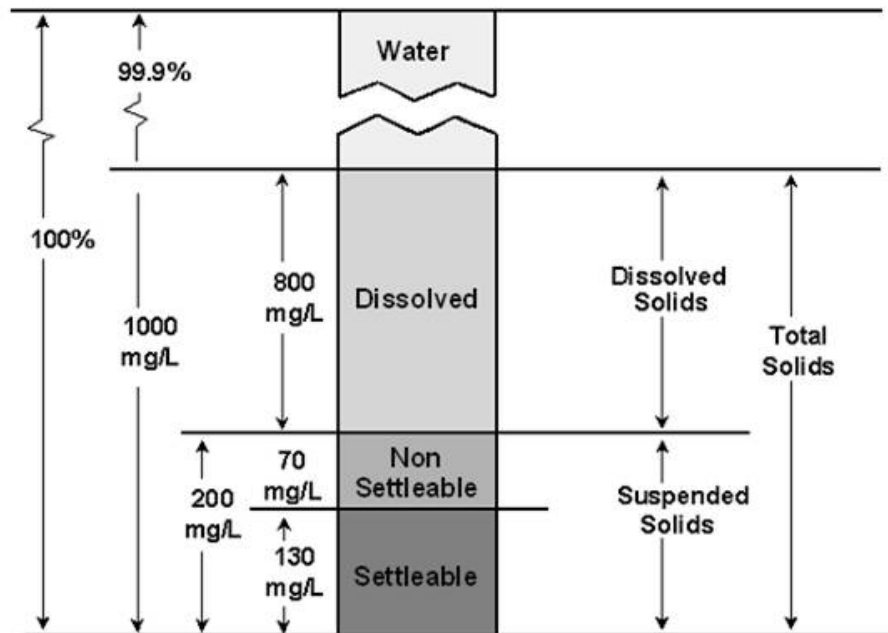

Figure 1-1. Typical composition of solids in raw wastewater.

Wastewater solids can also be characterized by their chemical composition. Total solids can be divided into organic solids and inorganic solids.

### ○ **Organic Solids**

Organic solids are plant and animal-based materials that contain carbon, normally in some combination with hydrogen, oxygen, nitrogen, and other elements. In domestic waste, they are present in forms such as proteins, carbohydrates, and fats. Synthetic organic chemicals, which may also be present, are discussed in a later section. Organic solids are subject to decay and decomposition by bacteria and other organisms. Odors are generated during this process.

- **Inorganic Solids**

Inorganic solids are materials of non-biological origin, like sand and silt. These materials are inert and are only slightly affected by biological activity. Common inorganic solids in wastewater are sand, metals, and dissolved salts.

The amount of organic and inorganic solids in a particular waste stream depends on the type of operation generating the wastewater. For example, wastewater from a meat processing plant will contain high levels of organic solids. On the other hand, wastewater from a gravel washing operation will contain high levels of inorganic solids.

One of the primary functions of a wastewater treatment system is to remove organic and inorganic solids from wastewater. During pretreatment, a significant amount of solids must be removed; otherwise, they can reduce the effectiveness of disinfection processes and clog surface irrigation equipment. Knowing the forms and concentrations of solids present in wastewater can provide an operator with useful data for the control of treatment processes.

## **Biochemical Oxygen Demand**

Biochemical oxygen demand (BOD) is amount of dissolved oxygen needed by bacteria to break down organic matter. High levels of BOD indicate high levels of organic matter in wastewater. It is considered a measure of the wastewater's strength or degree of pollution. The BOD level of influent wastewater is an important consideration when determining the type of pretreatment used in a surface irrigation system.

Biochemical oxygen demand is measured using a biochemical oxygen demand test (BOD<sub>5</sub> test), a procedure that measures the difference in dissolved oxygen in a wastewater sample incubated at 20°C for five days. The typical range of BOD in domestic wastewater ranges from 100 to 300 mg/L. The amount of organic material, measured as BOD<sub>5</sub>, applied to a given treatment process is referred to as the organic loading rate. It is expressed as pounds BOD per unit area per unit time; example: lb BOD/ft<sup>2</sup>/day.

## **Chemical Oxygen Demand**

**Chemical oxygen demand** (COD) is a measure of the dissolved oxygen required to break down or oxidize organic matter as well as inorganic material in wastewater. It is expressed as the amount of oxygen consumed from a chemical oxidant in mg/L. Results for COD can be obtained in 3 to 4 hours rather than the 5 days required for BOD.

Chemical oxygen demand results cannot be directly related to BOD, because the chemical oxidant used may react with compounds other than the bacteria. However, if BOD to COD ratios are developed for a particular system, COD can be used as a means of rapidly estimating the BOD of a sample.

Chemical oxygen demand results are typically higher than the BOD values and the correlation between the two will vary from system to system. The BOD to COD ratio is typically 0.5 to 1 for raw wastewater and may drop to as low as 0.1 to 1 for well-stabilized secondary effluent.

## Dissolved Oxygen

Dissolved oxygen (DO) is the amount of oxygen dissolved in water. The amount of oxygen that can be dissolved in water is dependent on temperature. As water temperature increases, DO content decreases and vice versa.

The distribution of oxygen in treatment units determines whether aerobic (with oxygen) or anaerobic (without oxygen) treatment processes are involved. Although some microorganisms can survive in anaerobic conditions, many of the beneficial microorganisms that stabilize wastewater require aerobic conditions.

Maintaining adequate oxygen levels allows the biological process to take place and prevents objectionable odors. Low DO concentrations (less than 1.0 mg/L) can indicate inadequate aeration or an excessive amount of organic material entering the system.

Dissolved oxygen is measured using an oxygen meter and a membrane-covered probe. It is usually expressed in milligrams per liter (mg/L).

## Pathogens

Untreated wastewater contains many billions of microorganisms per gallon. Most of these organisms are not harmful to humans. Some of them are even helpful in wastewater treatment processes. However, some can cause serious diseases such as typhoid, cholera, shigellosis, dysentery, polio, and hepatitis.

Disease-causing microorganisms are called pathogens and include bacteria, viruses, and parasites. Humans with diseases caused by these pathogens may discharge some of these harmful organisms in their body wastes. Many serious outbreaks of communicable diseases have been traced to direct contamination of drinking water or food supplies by the body wastes from a human disease carrier.

Fortunately, the pathogens that grow in the intestinal tract of diseased humans do not find wastewater treatment systems favorable environments for growth and reproduction. Many pathogenic organisms are removed by natural die-off during the normal treatment processes. However, enough can remain in the effluent (wastewater leaving the treatment system) to cause a threat to any downstream use involving human contact if adequate disinfection is not accomplished in the treatment process.

It is impractical to test for all pathogens. The presence of pathogens is determined with indirect

evidence by testing for indicator organisms, such as fecal coliform bacteria. Fecal coliform bacteria are always present in the digestive system of warm-blooded animals, including humans. These bacteria are relatively easy to identify and are usually present in higher concentrations than pathogens. Therefore, fecal coliform bacteria are used as an indicator organism for pathogens. If there is a large concentration of fecal coliform bacteria present in a water body, the potential for the presence of pathogens is high.

Wastewater treatment processes remove pathogenic organisms in several ways:

- physical removal through filtration and sedimentation,
- natural die-off of organisms due to unfavorable environments, and
- destruction of organisms by disinfection.

Proper disinfection of well-treated wastewater will usually result in essentially a complete kill of the pathogenic organisms. Disinfection processes will be discussed in more detail in Chapter 2.

## Nutrients

A nutrient is any substance that promotes growth and can be taken up by plants or consumed by organisms. Wastewater generally contains nutrients such as nitrogen, phosphorus, potassium, calcium, magnesium, iron, and sulfur. In a surface irrigation system, wastewater can provide essential nutrients to cover crops. If present at excessive levels, however, some nutrients can become pollutants.

Wastewater from domestic sources generally contains low concentrations of nutrients. This means that the amount of wastewater that can be applied annually to a given site is hydraulically limited; that is, limited by the amount of water that can be applied to the soil (the hydraulic loading rate). Since the concentration of nutrients is not high enough to be harmful, the limiting factor is how much wastewater the soil can physically accept without runoff.

However, in some cases, the quantity of wastewater that can be applied is nutrient limited. This means that the amount of wastewater that can be applied is limited by the nutrient content of the wastewater rather than by the amount of water the soil can handle.

- **Nitrogen**

Nitrogen in wastewater occurs in four different forms:

- Organic nitrogen (Org-N)
- Ammonium ( $\text{NH}_4^+$ )
- Nitrite ( $\text{NO}_2^-$ )
- Nitrate ( $\text{NO}_3^-$ )

Organic nitrogen is bound up in complex molecules including proteins, peptides, nucleic acids, and urea. As organic nitrogen is metabolized or broken down by microorganisms,

it changes first to ammonium ( $\text{NH}_4^+$ ). If aerobic conditions exist and nitrifying bacteria are present in sufficient numbers, ammonium will be converted to nitrite ( $\text{NO}_2^-$ ) and then rapidly to nitrate ( $\text{NO}_3^-$ ).

The conversion of Org-N to inorganic forms ( $\text{NH}_4^+$  and  $\text{NO}_3^-$ ) is called *mineralization*. The part of the process where  $\text{NH}_4^+$  is converted to  $\text{NO}_3^-$  is called *nitrification*. Under anaerobic conditions, denitrifying bacteria can convert  $\text{NO}_3^-$  to  $\text{N}_2$ , which is a gas that escapes to the atmosphere. These nitrogen transformations will be discussed in greater detail in a later chapter.

Plant available nitrogen (PAN) is nitrogen that exists in forms that are readily available for uptake by plants ( $\text{NH}_4^+$  and  $\text{NO}_3^-$ ). Surface irrigation systems that handle wastewater with high nitrogen concentrations may need to base wastewater application rates on supplying crop nitrogen needs rather than on the amount of water the soil can handle. The approach is to apply nitrogen at rates no greater than the crop can use because the nitrate form of nitrogen can move through the soil and threaten groundwater quality. Permits for nitrogen-limited systems have PAN monitoring requirements.

- **Phosphorus**

Phosphorus, like nitrogen, occurs in several forms in wastewater and is an essential element for biological growth and reproduction. Phosphorus can be present as orthophosphate, polyphosphate, and organic phosphate. These forms are often measured in combination as total phosphate. In domestic wastewater, total phosphorus levels generally range from two to 20 mg/L, including 1 to 15 mg/L of organic phosphorus and 1 to 15 mg/L of inorganic phosphorus.

## Metals

Metals are inorganic chemical elements present in varying amounts in most waste streams. A typical domestic wastewater has low concentrations of metals, but an industrial wastewater may be very high in metals. Although some metals are essential for proper human and plant nutrition, over time they can accumulate in soils and become toxic to plants, humans, and other animals.

Metals of concern include cadmium, copper, lead, nickel, zinc, selenium, arsenic, mercury, and molybdenum. Cadmium, arsenic, chromium, and mercury are extremely toxic; nickel, molybdenum, and lead are moderately toxic; and copper, manganese, and zinc are relatively low in toxicity.

The primary concern with using the soil to dispose of heavy metals is that these compounds are stable and often resist weathering and decomposition. Plants generally resist the uptake of metals from the soil, but their accumulation on plant leaves through irrigation may permit them to enter various food chains. Once they become part of the life cycle of soil, plants, animals, and humans,

they can accumulate in animal and human body tissue to toxic levels. This situation is especially critical for humans.

Because of the potential health effects of metals, wastewater applications sites must be properly managed to minimize the effects of metals on human health and the environment. The paramount questions facing cities or industries contemplating land application of wastes containing heavy metals or toxic substances are:

- How many acres of land are required to dispose of this waste?
- What is the anticipated 'life expectancy' of the site given the accumulation of heavy metals or other toxic substances?

## Synthetic Organic Chemicals

Although microorganisms can readily decompose most organic wastes, some organic chemicals are not readily biodegradable and can persist in wastewater and soil for many years.

These synthetic organic chemicals can reach the soil in many ways. They are sometimes a component of pesticides (insecticides and herbicides) or may be found in the waste stream that is being treated at the surface irrigation site. These products are also found where old underground storage tanks have leaked petroleum products into the soil.

With a municipal or domestic waste source, synthetic organic chemical concentrations are likely to be extremely low or nonexistent. These chemicals may be present in higher concentrations, however, in an industrial waste source. Like metals, synthetic organic chemicals can be toxic to animals and humans.

## Fats, Oils, and Greases

Fats, oils, and greases (FOG) are another category of pollutant commonly associated with both domestic and industrial wastewater. The most common form comes from animal or vegetable oils used in cooking. Food service/preparation establishments typically generate high levels of this type of fats, oils, and greases. This material can enter a treatment system as floatable particles, as emulsified material or in solution. Although microorganisms can break this type of FOG down, it can cause problems during the pumping of the wastewater by clogging pumps and spray devices in both a treatment facility and in the fields. Fats, oils, and greases can seal soil surfaces if land-applied.

Another type of FOG found less commonly in wastewater comes from petroleum-based products. This material is not readily stabilized by biological activity and can cause toxic effects on the biological community in the treatment system. It is usually associated with industry and/or automobile repair facilities.

## Salts

Chlorides, sulfates, potassium, calcium, sodium, and manganese are soluble salts (ionic compounds) that are present in wastewater. Some of them may be removed during wastewater treatment prior to effluent irrigation. Other salts, such as ferric chloride and alum, are sometimes added to aid in wastewater treatment.

Soluble salts, especially sodium ( $\text{Na}^+$ ), are important constituents of wastewater. When wastewater containing high levels of sodium or other salts is land-applied, there may be some swelling of clay minerals, which can reduce water movement through the soil.

This tendency occurs when the ratio of sodium to other cations (positively charged particles) is high. This relationship is called the sodium adsorption ratio (SAR) of a wastewater sample. The SAR of wastewater should be evaluated frequently, especially when irrigating heavy clay soils. Salts and their effects on land treatment systems will be discussed in greater detail in Chapters 3 and 5.

## pH

pH is an indication of the acidity of a substance. It is determined by the number of free hydrogen ions ( $\text{H}^+$ ) compared to the number of free hydroxide ions ( $\text{OH}^-$ ) in a solution. It is defined as the log of the concentration of the hydrogen ions ( $\text{H}^+$ ) in a solution.

pH does not have a unit; it is merely expressed as a number ranging from 1 – 14 (Figure 1-2). When the pH of a solution equals 7, the number of hydrogen ions equals the number of hydroxide ions, and the solution is neutral. When the pH is higher than 7, the number of hydroxide ions is higher, and the solution is basic or alkaline. When the pH is less than 7, the number of hydrogen ions is higher and the solution is acidic.

Because pH is a logarithmic factor; when the pH falls by one unit, that means the solution is ten times more acidic, the pH will fall by one unit. When the pH falls by 2 units, the solution is 100 more acidic. When a solution becomes a hundred times more acidic the pH will fall by two units. For example, a solution with a pH of 5 is 10 times more acidic than a solution with a pH of 6, whereas a solution with a 4 is 100 times more acidic than a solution with a pH of 6.

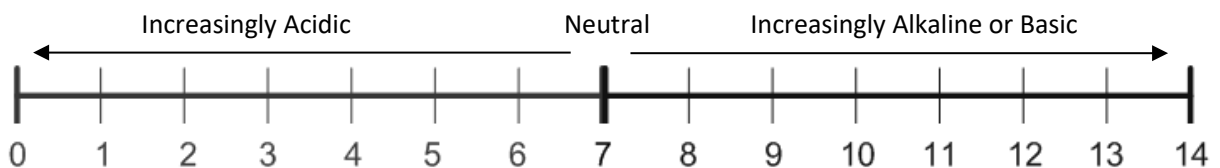

Figure 1-2. The pH scale.

The pH of domestic wastewater typically ranges from 6.5 to 7.5, depending on the pH of potable water in the service system. Significant departures from these values may indicate industrial or other non-domestic discharges.

In surface irrigation systems, the bacteria that perform most of the wastewater treatment prefer a pH of neutral (or 7) for best performance. Any rapid increase or decrease in pH can cause death in the bacteria population, resulting in poor treatment.

Note: Acidity is the capacity of wastewater to neutralize bases. Alkalinity is the capacity of wastewater to neutralize acids. While both acidity and alkalinity are related to pH, they should not be confused with pH. Wastewater does not have to be strongly acidic (low pH) to have a high acidity or strongly basic (high pH) to have a high alkalinity.

## Industrial Wastewater Characteristics

Systems treating wastewater from industrial sources must closely evaluate the pollutants that may be discharged from these industries. These possible pollutants are too varied and industry-specific to discuss in detail here. However, operators should give special attention to industries that discharge salts, which can negatively impact soil and crops, or metals and organic chemical compounds, which can cause groundwater contamination.

## Is Surface Irrigation Safe?

When regulatory and permit requirements are met, the wastewater returned to the environment after irrigation usually is higher quality than the wastewater discharged from treatment plants due to the additional treatment provided in the soil. Regulations and permit conditions protect public health and the environment by requiring that wastewater always be pretreated prior to irrigation and by restricting its quality, use, and the manner and location of its application.



## Chapter 2

### Pretreatment of Wastewater

Prior to surface irrigation, wastewater normally undergoes some form of preliminary or pre-application treatment. Pre-application treatment is used as a means of flow equalization, solids separation, physical, chemical, and biological treatment, pathogen reduction, and wastewater and sludge storage. Pre-application treatment can consist of one or more of the following components:

- lagoons
- tanks
- media filters
- disinfection

#### *2.1 Wastewater Lagoons*

Wastewater stabilization lagoons are pond-like bodies of water that are used throughout the United States to collect, treat, and store wastewater. In North Carolina, lagoons are widely used in farming communities to treat waste from animal feed lots, hog houses, and poultry buildings. However, stabilization lagoons also serve as a means of treatment for the wastewater industry (both domestic and industrial).

Lagoons are generally used for systems with flows of more than 15,000 to 20,000 gallons per day (flows that surpass reasonable tank design). They may be used as a means of flow equalization, initial separation, primary and secondary treatment, and emergency storage.

#### Types of Lagoons

There are four types of stabilization lagoons:

- aerobic,
- aerated,
- anaerobic, and
- facultative

#### *Aerobic Lagoons*

Aerobic lagoons are not common in the southeastern United States. Aerobic lagoons are designed shallow (12 to 18 inches) in order to maintain a constant DO throughout the entire depth. Oxygen is supplied by natural surface aeration and algal photosynthesis. Algae exists throughout the

depth of the lagoon and is sometimes enhanced by mixing to prevent anaerobic conditions. The success of these lagoons is dependent on the balance of heterotrophic and autotrophic organisms. Aerobic bacteria and algae biologically degrade waste.

### *Aerated Lagoons*

Many aerated lagoons are former facultative lagoons that have failed. Oxygen is introduced into these lagoons artificially through mechanical-type aerators (Figure 2-1) or diffused air from air blowers, thus eliminating the need to maintain an algae population. These lagoons can handle high-strength wastes using less land. Higher operating costs are common due to the electrical costs associated with continuously operating the aerators or mixers. These lagoons are designed to be deeper than other lagoons to provide additional volume for sludge storage below the mixing and aerated zone.

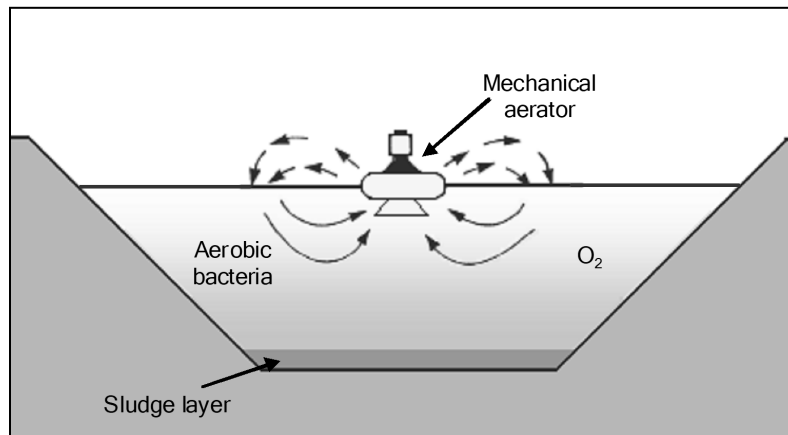

Figure 2-1. Diagram of an aerated lagoon.

### *Anaerobic Lagoons*

As discussed in Chapter One, anaerobic means “without oxygen.” There is little to no dissolved oxygen present throughout the entire depth of an anaerobic lagoon (Figure 2-2). The organic and hydraulic loading rates for anaerobic lagoons are typically very high compared to other lagoons.

The goal of anaerobic treatment is the destruction and stabilization of organic matter, rather than nutrient recycling (as in oxidation ponds). The principal biological activity is the loss of carbon as carbon dioxide by acid and methane fermentation. Similar processes occur in anaerobic digesters and septic tanks. Anaerobic lagoons are generally used for treatment of industrial or agricultural waste and are not widely used for the treatment of domestic wastewater.

Although these lagoons are highly efficient in destroying organic wastes, the processes involved can be highly odorous. A dense scum mat often forms over the entire surface of an anaerobic lagoon, promoting anaerobic conditions and limiting odor emissions. Plastic covers are also used

to promote anaerobic digestion and control odors; however, such covers must provide some means of capturing methane gas and allowing sludge removal.

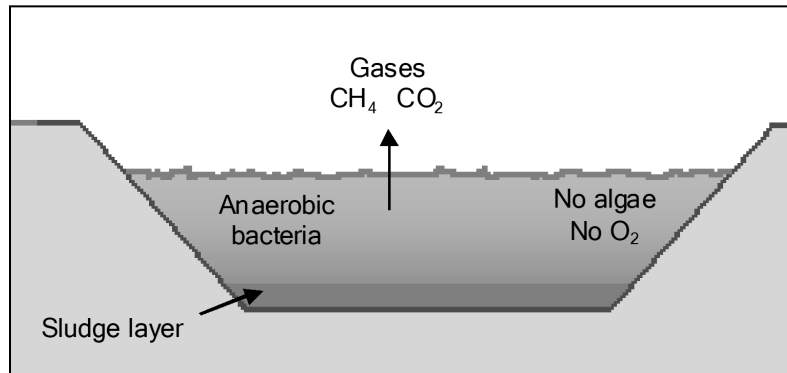

Figure 2-2. Diagram of an anaerobic lagoon.

### *Facultative Lagoons*

Facultative lagoons are common in NC, particularly for treatment of domestic wastewater. The purpose of these lagoons is to recycle nutrients while providing waste treatment. Nutrients are removed by photosynthetic algae, while organic matter is stabilized by heterotrophic bacteria (bacteria that cannot synthesize its own food). Facultative lagoons are designed to have three zones or layers of wastewater – aerobic, facultative, and anaerobic (Figure 2-3).

The aerobic zone is the upper layer of wastewater where sunlight fully penetrates. In the presence of sunlight, photosynthetic algae use carbon dioxide and nutrients to produce oxygen. The depth of the aerobic zone depends on how far light can penetrate and how much oxygen can be produced and stored there (generally around two feet).

Beneath the aerobic zone is the facultative zone. Although some sunlight penetrates, oxygen production is much lower and is much more variable than in the aerobic zone. Bacteria in this zone must be able to decompose waste both in the presence and in the absence of oxygen (facultative).

The bottom layer is the anaerobic zone where no sunlight penetrates and no oxygen is produced; therefore, waste must be degraded by anaerobic or facultative bacteria. This zone includes a layer of sludge composed of solids, bacteria and algae that settle to the bottom of the lagoon. In this zone, anaerobic and facultative bacteria decompose organic matter into volatile organic solids and gases during anaerobic fermentation.

Facultative lagoons usually range from four to eight feet deep. Detention times range from five to 30 days, although in North Carolina permitted systems are typically required to have a minimum 30-day detention time.

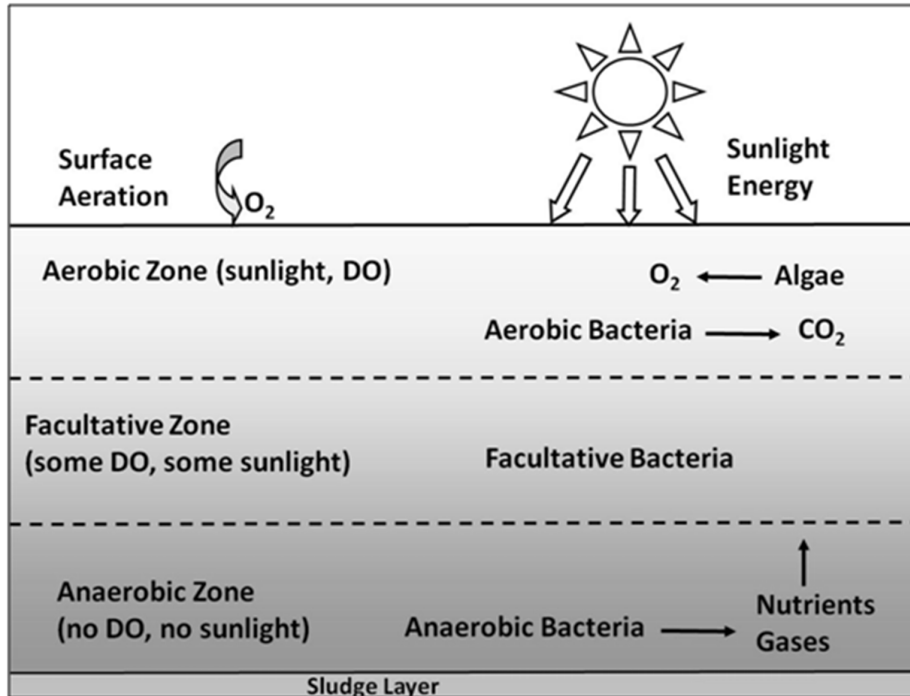

Figure 2-3. Diagram of a facultative lagoon.

The key to successful operation of these lagoons is the proper balance of oxygen-producing algae and surface aeration. Any imbalances such as excessive oxygen consumption during algae respiration, reduced oxygen production (as experienced at nighttime and during cloudy days), water temperature changes, and chemical and biological upsets can result in non-productive, “dead,” odorous lagoons.

### *Storage Ponds*

Storage ponds are not considered stabilization lagoons since their primary function is to provide temporary storage (not treatment) of wastewater. Since no surface irrigation system can operate continuously, a pond can provide wastewater storage where tank storage is unrealistic. Although a limited amount of treatment may occur in storage ponds, they are designed primarily for storage.

### Lagoon Design and Components

Lagoons are generally designed with earthen dams or dikes. Figure 2-4 shows a typical lagoon design. To allow mowing of outer banks, outside slopes are usually no more than 3 units horizontal to 1 unit vertical.

Lagoons must be designed for a minimum **freeboard** (the distance between the top of the dike at its lowest point and the highest allowed wastewater level within the lagoon). This provides for stability and a heavy rainfall factor.

Lagoons must have a permanent readable marker inside the lagoon to assist with liquid level management. The marker shows the absolute maximum and minimum operating levels to indicate when irrigation is needed and when irrigation should stop. The markers should be routinely cleaned so you can easily observe the available storage.

Liners are used to reduce the permeability of the bottom and sidewalls of earthen lagoons. The three types of liners commonly used are clay, bentonite, and synthetic membranes. Clay liners must be carefully installed with proper compaction at the proper moisture content. The inside slopes may be protected against wave erosion by riprap from one foot below the minimum water surface to the top of the freeboard.

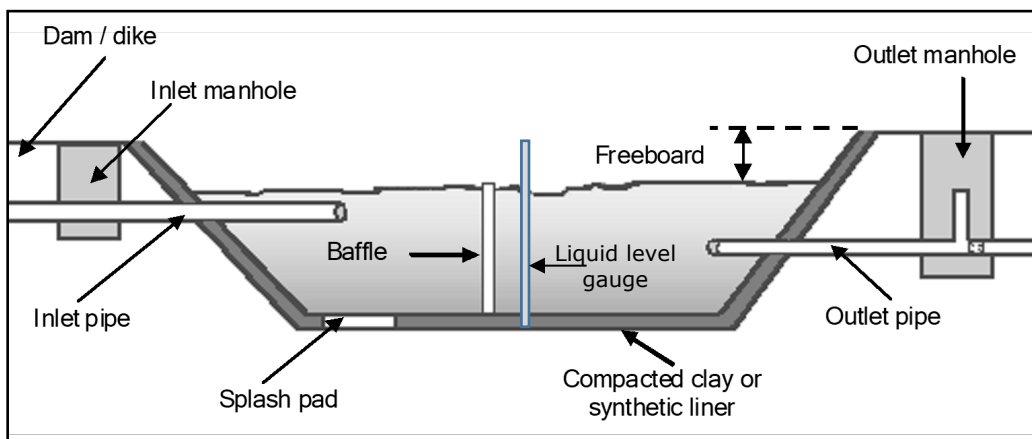

Figure 2-4. Schematic of a typical stabilization lagoon.

Bentonite is a natural material that is mixed with existing soil. It must be transported from outside North Carolina and can be expensive to install. Synthetic membranes normally consist of some type of plastic. Again, careful installation is essential as they are easily damaged.

Wastewater enters and leaves a lagoon through inlet and outlet pipes. Inlet structures should be located so that wastewater is distributed evenly in the pond. If wastewater is gravity fed to the lagoon, a concrete pad is often placed at the end of the inlet pipe to protect the lagoon liner. The outlet pipe is located as far as possible from the inlet pipe to increase detention time and prevent **short-circuiting** (a condition where some of the wastewater in a tank or lagoon travels faster than the rest of the flowing water).

Lagoons are designed for a specific **detention time** (the amount of time wastewater is retained in a treatment system). Time allows solids and many disease-causing bacteria, parasites, and viruses to settle out or die. Time also allows biological treatment to reduce the overall organic strength (BOD) of the wastewater.

Several smaller lagoons usually provide better treatment than one large lagoon. Surface irrigation

systems often have multiple cells (lagoons) that are designed to operate either in series mode, parallel mode, or both (Figures 2-5 and 2-6). Lagoons that operate in series (wastewater flows from a primary lagoon to a secondary lagoon and so forth) allow more solids to settle out than in a single lagoon.

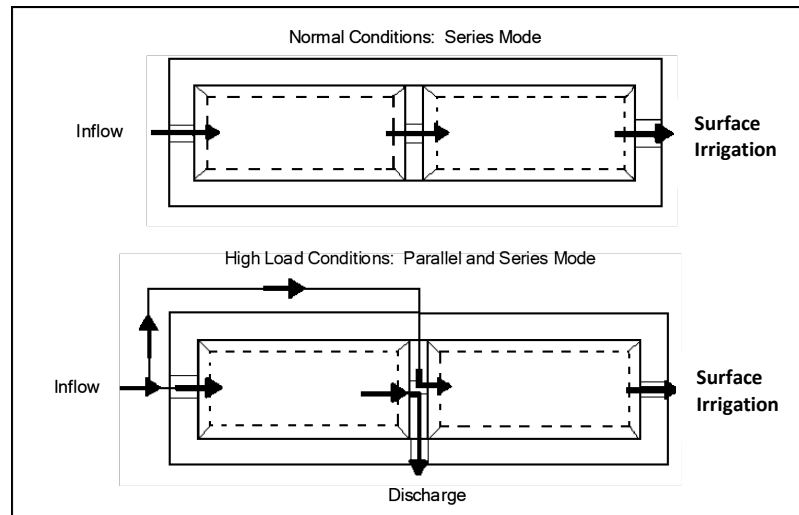

Figure 2-5. Two-cell lagoon system operated in series mode during normal conditions and in series and parallel modes during overload conditions.

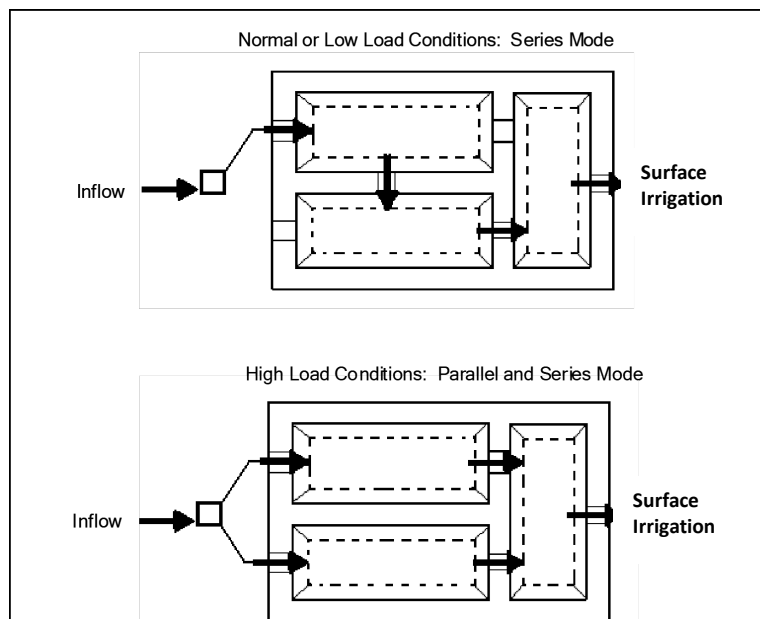

Figure 2-6. Three-cell lagoon system operated in series mode during low load or normal conditions and in parallel and series modes during high load conditions.

Sedimentation of solids and anaerobic decomposition of settled organic material occur in the first or primary cell. Organic matter is oxidized into stable products in both the primary and secondary cells, reducing BOD and SS. Tertiary or polishing lagoons can remove additional BOD and suspended matter. Because each cell provides additional treatment, a higher quality effluent results with series operation than with parallel operation.

Lagoons operated in parallel receive wastewater that is at the same stage of treatment. Wastewater with high organic loads can be distributed evenly to different cells using distribution chambers or splitter boxes with adjustable weirs or splitter arrangements. Operating lagoons in parallel allows one or more cells to be taken out of operation for maintenance and repair. A parallel configuration can also be used during winter to handle extra loads when treatment efficiencies are lower due to cold weather.

Placing lagoons in series may cause the first lagoon to become overloaded. The overload then may be carried to the next lagoon in the series. Feeding lagoons in parallel allows distribution of the incoming load evenly between units. Whether lagoons are operated in series or in parallel should depend on the loading situation and permit requirements. Table 2-1 summarizes design parameters for the four types of stabilization lagoons.

Table 2-1. Typical design parameters for stabilization lagoons.

Parameter	Type of Lagoon			
	Aerobic	Aerated	Anaerobic	Facultative
Dissolved O <sub>2</sub>	Aerobic without sludge storage	Aerobic with sludge storage	Anaerobic	Stratified, aerobic / anaerobic
Depth	12 – 18 inches	6 – 20 feet	10 – 20 feet	4 – 8 feet
Detention time	3 – 5 days	3 – 10 days	30 – 75 days	≥ 30 days
pH	6.5 – 10.5	6.5 – 8.0	6.5 – 7.2	6.5 – 8.5
BOD loading, (lb/acre/day)	Summer: 225 Winter: 110	50 – 200	650 – 850	20 – 50

## Lagoon Performance

Factors affecting lagoon performance include:

- biology
- loading rates
- hydraulics

## Biology

A critical factor influencing individual lagoon performance is the formation and presence of biological organisms, particularly algae due to its ability to produce oxygen during photosynthesis. In aerobic and aerated lagoons and in the aerobic zone of facultative lagoons, the process of photosynthesis is critical.

During this process, photosynthetic algae use carbon dioxide in the presence of sunlight to produce oxygen. Aerobic bacteria then use the oxygen to stabilize the organic waste and generate carbon dioxide and other inorganic constituents, such as ammonia, nitrate, and orthophosphates, as by-products. In turn, these constituents are used by algae during photosynthesis. This cycle is illustrated in Figure 2-7.

In anaerobic lagoons or the anaerobic layer of facultative lagoons, organic waste is converted to carbon dioxide by anaerobic organisms known as “acid producers” because they also produce nitrogen and organic acids. Another group of anaerobic organisms, “methane fermenters,” then break down the organic acids to form methane gas. Many of the by-products generated by the anaerobic bacteria are then used as food by both the aerobic bacteria and algae in the layers above, converting them to dissolved sulfate, nitrate, phosphate, and carbonate compounds. These compounds, in turn, are a source of energy for the anaerobic bacteria. The oxygen produced by the algae is used to support certain waste-stabilizing bacteria.

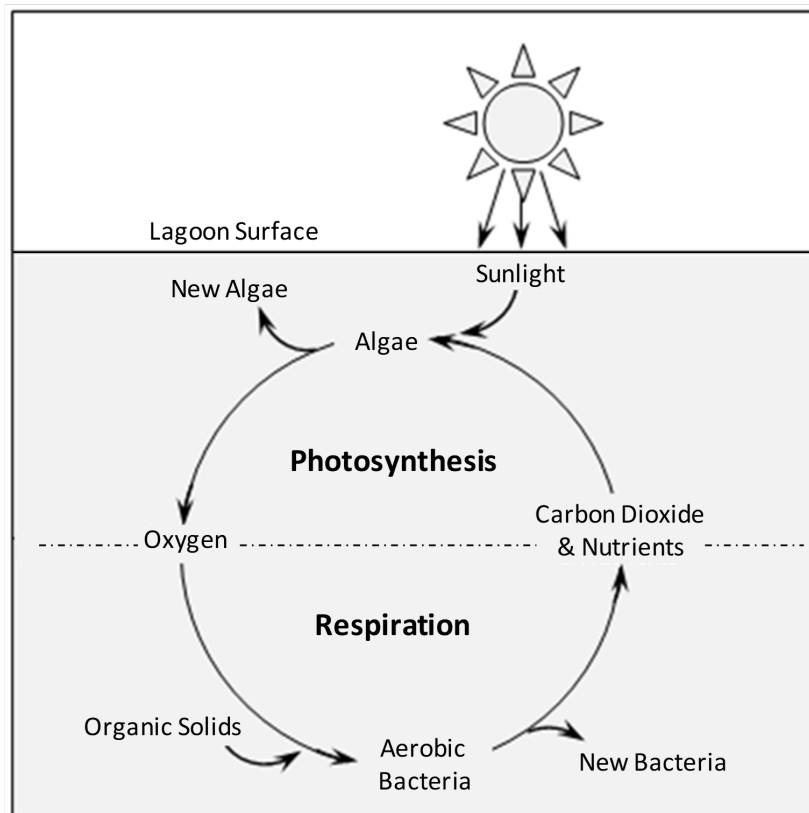

Figure 2-7. Relationship between algae and aerobic bacteria.



A major characteristic of facultative lagoons is the drastic change in DO from daytime to nighttime (Figure 2-8). During the day, algae produce oxygen and consume carbon dioxide during photosynthesis. Carbon dioxide consumption increases pH. At night the algae breathe, consuming oxygen, producing carbon dioxide, and decreasing pH. Therefore, there can be a significant day-night variation in DO content.

Day-night variation in pH may also be experienced (Figure 2-8). Extended periods of cloudy weather or high levels of algae may result in die-off of the algae. This results in the formation of a floating mat of dead algae, low DO effluent, odorous and noxious smells, and general poor effluent quality.

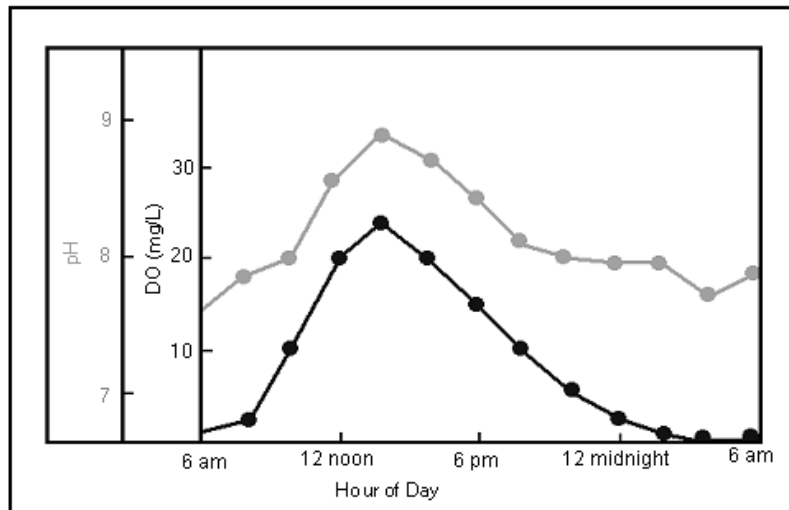

Figure 2-8. Day-night (diurnal) variation in DO and pH in a facultative lagoon.

### *Organic and Hydraulic Loading*

Because lagoons are designed to handle specific organic and hydraulic loads, organic and hydraulic loading significantly affect lagoon performance. Overloading can result from factors such as poor design, short-circuiting, infiltration, population increases, industrial growth, industrial dumps, or from diverting too much flow from one lagoon to another. Overloading results in incomplete treatment of wastewater and poor effluent quality.

If a lagoon is organically overloaded, it may not generate sufficient DO for the biological cycle to function properly. Offensive odors, sludge mats on the surface of the lagoon, or changes in color may indicate that the lagoon is organically overloaded. Aerobic, aerated, and facultative lagoons may become anaerobic and septicity (a condition where organic matter decomposes to form noxious-smelling products indicating the absence of oxygen) may occur. Although sludge accumulation is normally a gradual process, organic overloading can accelerate sludge deposits. Hydraulic overloading reduces detention time and wastewater moves through the lagoon too

quickly, resulting in poor effluent quality.

### *Hydraulics*

In addition to hydraulic loading, there are other factors that influence the hydraulics of a lagoon, such as wind and temperature. Wind affects lagoon hydraulics by directing flow in a common wind direction or even in circulatory flow patterns. Water temperatures are commonly stratified and change throughout the season. In the winter months, inflow (which is warmer than the lagoon contents) rises and flows towards the outlet. In the summer, the reverse occurs when the inflow is cooler and sinks. The effects of wind and temperature may reduce the effective volume, alter the detention time, change the lagoon's ability to achieve certain levels of treatment, and cause short-circuiting.

Some hydraulic situations can be adjusted and modified while others cannot. Modifications such as changes in inlet and outlet configuration, multiple inlets, inlet diffusers, recirculation capabilities, and changes in inlet and outlet location have a dramatic effect on effluent quality.

However, the number of treatment cells and their configuration may have the greatest impact on wastewater quality. Treatment cells can be configured by using separate interconnected lagoons, dikes, and baffles or curtains with flow-through openings. Siphons may also be used to help direct flow if proper allowable elevations are available.

### *Other Performance Issues*

Studies show that bacteria, parasite, and virus removal is very effective in multiple cell wastewater lagoons. Nitrogen, phosphorous, and BOD are also reduced by lagoons and lagoon systems. BOD removal is thought to be a function of climate, loading rate, and biological activity. Nitrogen reduction in wastewater lagoons has been observed for many years and is thought to be a function of algal uptake, sludge deposition adsorption by lagoon bottoms (if unlined), nitrification, denitrification, and volatilization (loss of ammonia gas to the atmosphere).

Although phosphorous removal is not generally required for spray systems, chemical treatment such as hydrated lime, alum, and ferric chloride are effective means of lowering phosphorous levels when necessary. Operators should also expect elevated levels of total suspended solids in lagoon effluent due to the presence of plants and animals (fish, waterfowl, etc.). Many times, a final screening (a micro strainer) or a filter system is used prior to surface irrigation to minimize solids in the effluent and prevent blockages in surface irrigation equipment.

## **Lagoon Operation and Maintenance**

Regardless of how well designed or how appropriate the hydraulic and organic loading, lagoons

will not perform to their optimum potential unless properly operated and maintained. Inspections and sampling must, at a minimum, be conducted as required by the system permit. In addition, routine operation and maintenance practices should address and control the following conditions and situations:

- emergent and suspended vegetation
- erosion
- scum formation
- excessive algae
- sludge buildup
- odor production
- low pH
- insufficient freeboard
- short-circuiting
- septicity

### *Vegetation*

Controlling vegetation in and around lagoons is very important. Long weeds and grasses on dams and dikes block wind, provide sheltered areas for insects and burrowing animals interfere with the establishment and maintenance of a desirable vegetative cover, and hinder visual inspection of dikes. Trees and other deep-rooting vegetation can impair the structural integrity of lagoon dikes. Regular mowing, weeding, and maintaining well-established vegetative covers are required to avoid these problems.

Emergent and suspended vegetation in lagoons takes up valuable space that could be occupied by algae, provides a breeding ground for mosquitoes, stops sunlight from penetrating wastewater, and hinders pond circulation. In addition, dead vegetation can contribute to increased BOD levels. Emergent growth will only occur when sunlight is able to reach the lagoon bottom and therefore should not be a problem for lagoons over three feet deep. (If multiple lagoons are operated in series, the clarity of the wastewater will be greater in the secondary and tertiary lagoons and emergent weeds may be a problem, even for deeper lagoons).

For more shallow lagoons, emergent growth can be controlled by:

- immediate removal of young plants (including roots)
- drowning weeds by raising the water level, lowering the water level, and cutting the weeds, then raising the water level again
- by installing pond liners
- as a last resort, using herbicides (which should only be used with the approval of DWR)

Suspended vegetation, such as duckweed and water meal, can occur in any lagoon regardless of depth. Often mistaken for algae, duckweed floats on a lagoon surface and has long hair-like roots

that hang down into the water. It grows rapidly and can cover the entire surface of a lagoon if not controlled. Duckweed and other surface weeds are generally not a problem if a lagoon is exposed to a clean sweep of wind. If suspended vegetation is a problem, it should be skimmed off with rakes or other tools or mechanically harvested. Ducks eat duckweed (hence, the name) and may control a light growth. As a last resort, an herbicide can be used.

### *Erosion*

Erosion can wash away clay liner material on inside banks or create cracks and crevices in outer banks. Both situations reduce the structural integrity of lagoon dams or dikes and can result in leaks and dike failure. Erosion is caused by wave action, surface runoff from precipitation, or burrowing animals.

Installing riprap or broken concrete along banks and dikes can minimize erosion (this also discourages weed growth). Diversion ditches must be installed to carry all surface water away from the lagoon.

Burrowing animals, such as moles, groundhogs, and muskrats, can usually be controlled by regular mowing of banks and removal of heavy underbrush. Since they like their tunnels partially submerged, muskrats can be discouraged by alternately raising and lowering water levels. Otherwise, animals should be trapped and relocated. Burrowed holes should be repaired immediately.

### *Scum Formation*

Like suspended vegetation, scum that collects on lagoon surfaces can block sunlight, reducing oxygen production by algae. It can clog inlet and outlet pipes. Algae can grow on it and cause odors. Scum accumulation is usually higher in the spring when water temperatures are warmer and biological activity accelerates.

If exposed to a clean sweep of wind, scum usually dissipates and settles. If not, scum can become dry and crusted, forming floating mats. These scum mats should be broken up with rakes or other tools or by jets of water from pumps or tanks trucks. Mats tend to reform, so repeated efforts may be necessary. If a system has multiple lagoons operated in parallel, letting a cell “rest” may solve the problem.

### *Excessive Algae*

Although algae is critical to the biological cycle of a lagoon, excessive algae can create serious problems. The sudden explosion of algae growth (an algae bloom) is composed primarily of blue-green algae. Blue-green algae is stringy, forms clumps or mats, and has a characteristic odor. The growth and dominance of blue-green algae can be caused by organic overloading, pond turnover, shutdown, poor conditions, and by protozoa eating all the green algae.

Algae blooms die off as suddenly as they appear, blocking sunlight and causing foul odors. The die-off of algae blooms also causes a very high BOD loading. Dissolved oxygen is depleted, and the lagoon may become anaerobic or septic. Like scum mats, algae mats should be broken up and dispersed or physically removed like duckweed.

Surface agitation is a simple method of limiting the amount of algae present in a lagoon. Ripples created by simple mechanical devices help refract some of the sunlight that hits the surface of the water. This limits the amount of sunlight that can penetrate the water column.

Algae can also be controlled by chemical and biological means. Chemical products that color lagoon water act as a shade to minimize algae growth. Because large quantities are often needed, costs may be prohibitive. There is also a residual color issue. Herbicides are another possible chemical means of controlling algae growth; but, again, costs may be prohibitive. Algaecides and copper sulfate should not be used since algaecides can kill off all algae and copper sulfate may contaminate groundwater and sludge.

Duckweed was identified as a potential problem earlier in this section. Yet, it is sometimes used as a biological deterrent to algae growth, as are other aquatic plants such as water hyacinth and pennywort. These plants take up nutrients and shade the lagoon surface, lowering algae growth rates and minimizing DO swings. It should be noted that the use of plants to combat algae growth creates additional management considerations and their growth must be controlled by regular harvesting to avoid equipment blockages (bar screens, pumps, piping, etc.)

Fish have also been used to control algae growth in some lagoons. The use of fish to consume algae also requires additional management techniques including fish harvesting and possible oxygen supplementation.

*Note: When considering any chemical or biological means of algae control, an operator must make sure that the action is approved by the Division of Water Resources and is not a violation of permit conditions.*

### *Low pH*

Depending on the type of lagoon, pH can range from 6.0 to around 10. In general, most lagoons function best if they are a little on the alkaline side, around a pH of 8. A decreasing trend in pH can be corrected or reversed by adding lime. When using lime, make a slurry of 100 pounds of hydrated lime per 50 gallons of water. Using a dosage rate of one pound of lime per 10,000 gallons in the lagoon, add the slurry around the inlet of the lagoon so that it mixes well throughout the lagoon.

### *Solids Accumulation*

As discussed earlier, solids accumulation is normally a gradual process in anaerobic and facultative lagoons because anaerobic bacteria break down wastes into products that are used by algae. Heavily loading or overloading lagoons can speed up solids accumulation. Eventually, solids accumulate to a point where they must be removed.

Solids accumulation reduces detention time (by reducing the effective volume of the lagoon) and may cause short-circuiting, odors, sludge mats, and solids carryover to the second lagoon (if operated in series). Solids accumulation should be measured at least once a year using a core taker sludge sampler. Solids are generally removed when their depth exceeds one foot. These solids must be disposed of in a manner permitted by DWR.

### *Odor Production*

Regardless of how well maintained or operated, most lagoons will produce odors from time to time. Anaerobic lagoons produce more odors than other types of lagoons, odors that can be reduced using plastic covers.

In other types of lagoons, odors may be particularly noticeable for a short period in spring, when warmer temperatures accelerate biological activity, depleting oxygen and creating anaerobic conditions. However, persistent odor problems indicate more serious problems such as overloading, extended periods of cloudy weather, poor pond circulation, and floating sludge mats. Odors can be reduced by increased mechanical aeration or by chemical methods as outlined in Appendix A-2.

### *Insufficient Freeboard*

Overflow from lagoons for any reason is a violation of state regulations and subject to enforcement action. Waiting until a lagoon has reached its maximum storage capacity before starting to irrigate does not leave room for storing excess wastewater during extended wet periods. By late summer/early fall a lagoon should be pumped down as far as possible.

For an anaerobic lagoon, efforts should be made to maintain the lagoon close to the minimum liquid level if the weather and permit conditions allow. In North Carolina, most lagoons are required to have a minimum of two feet of permanent freeboard. The system permit should be reviewed to determine the exact freeboard requirement.

Natural surface water or stormwater should be diverted away from the lagoon by surface water diversions. They are usually designed with a gentle slope so they can be vegetated and mowed, and so that rainwater runoff leaves gently without causing erosion. Their purpose is to keep all

excess water out of the lagoon so that this excess water does not have to be pumped to the spray fields. Natural surface water can be safely diverted away from the lagoon without special permits; but once this surface water enters the treatment system, it must remain in the treatment system.

### *Short-circuiting*

Short-circuiting is a condition that occurs when some of the wastewater in a lagoon or basin travels faster than the rest of the flowing water. This problem can be caused by such factors as poor design, sludge accumulation in the lagoon bottom, vegetation that hinders lagoon circulation, temperature, and overloading. It can result in shorter detention, reaction, and settling times.

Short-circuiting can be verified using dye tests. It may be corrected or prevented using curtains or baffles to redirect flow, relocation of inlet and outlet pipes, controlling vegetation, preventing overloading, and removing excessive sludge deposits from the lagoon.

### *Septicity*

Septicity is the condition where organic matter decomposes to form noxious-smelling products indicating the absence of oxygen. If severe, wastewater turns black, gives off foul odors, contains little to no dissolved oxygen and creates a high oxygen demand. This condition is undesirable in aerated, aerobic, and facultative lagoons and may result in the failure of these lagoons.

Septicity can be caused by overloading, short-circuiting, poor operation, or toxic discharges. Corrective actions include reducing flow to the lagoon, changing from series to parallel operation (if multiple lagoons), increasing recirculation, adding supplemental aeration, changing inlet and outlet arrangements, and eliminating sources of toxic discharges.

With proper design and good management practices, lagoons can be expected to achieve high quality effluent. Maximization of lagoon performance by using all available technology, coupled with good operation and management techniques, will have positive results in lagoon performance. Be aware of all potential effects on performance, determine performance goals and implement procedures necessary to achieve these goals. Troubleshooting guides contained in Appendices A-1 and A-2 should help operators identify problems and possible solutions.

## 2.2 Tanks

Tanks (septic tanks, dosing tanks, grease traps and oil/water separators) are other possible pre-application treatment components of surface irrigation systems.

## *Septic Tanks*

A septic tank is a buried, watertight receptacle designed and constructed to receive wastewater. They can be made of concrete, plastic, or fiberglass. The functions of a septic tank are to:

- separate solids, oils, and greases from the liquid
- provide limited digestion of organic matter by anaerobic bacteria
- provide flow equalization
- store solids

Wastewater enters the tank through an inlet pipe (Figure 2-9). Settable solids and partially decomposed septage settle to the bottom of the tank and accumulate. These solids are often retained by baffle walls built into the septic tank and by an outlet tee.

A scum layer, consisting of lightweight material including fats and greases, rises to the top. The partially clarified liquid then flows through an outlet structure (typically a sanitary tee outlet) below the floating scum layer and exits the tank as effluent.

Access ports or risers should be located above each compartment and should extend to finish grade to allow for regular inspections and solids removal.

### **Septic Tank Performance**

Septic tank performance is affected by hydraulic loading, organic loading, inlet and outlet arrangements, number of compartments, and operation and maintenance practices. Septic tanks are designed to handle both a specific flow rate (hydraulic load) and a specific amount of organic material (organic load).

If the septic tank is hydraulically overloaded, the detention time may be too short, and solids may not settle or float properly. If the tank is organically overloaded, septic tank performance can be reduced and the need for pumping and other forms of maintenance can be increased.

Septic tanks with properly designed and installed baffles and outlet tees produce a higher quality effluent than those tanks without these structures. Improper design and placement of baffles can create turbulence in the tank, seriously impairing settling efficiency. In addition, poorly designed or constructed baffles or outlet devices may allow scum or septage to enter discharge pipes.



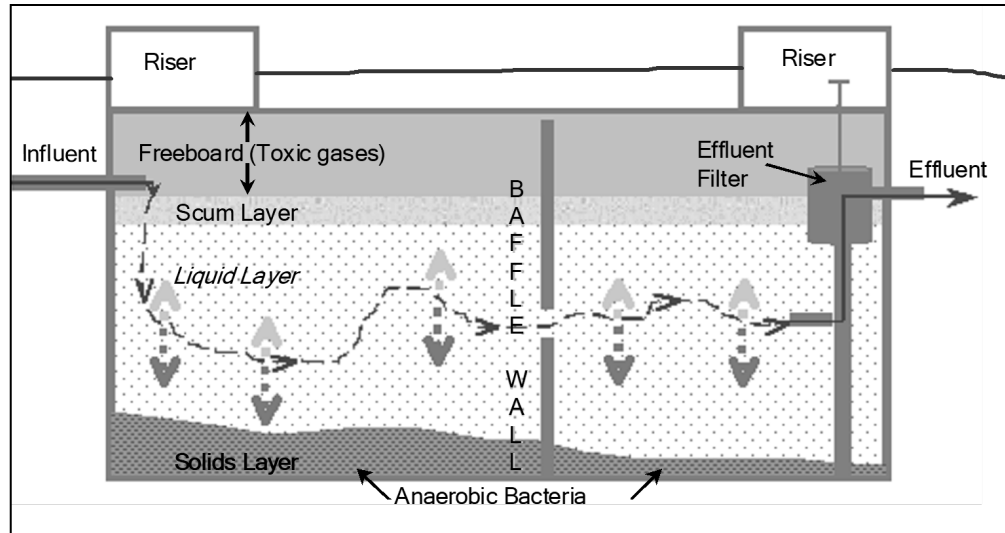

Figure 2-9. Septic tank schematic.

Outlet filters are an excellent means of providing additional protection against solids exiting the septic tank and are a requirement on all septic tanks installed on or after January 1, 1999. Multi-compartment tanks provide better treatment than single compartment tanks of the same total capacity. Multi-compartment tanks provide better protection against solids carryover into discharge pipes during periods of surges or upsets.

If a septic tank is not water-tight, leakage from the tank (exfiltration) can result in direct discharge of wastewater to groundwater and potential contamination. Infiltration (seepage of groundwater or stormwater into the tank) may result in hydraulic overloading and decreased treatment efficiency.

### *Septic Tank Operation and Maintenance*

One of the major advantages of the septic tank is that it has no moving parts; therefore, it needs little routine maintenance. However, improper operation and maintenance can impair tank performance. Routine inspections are required to ensure proper functioning. At a minimum, a tank must be accessible, must be visually inspected for signs of damage or deterioration, and solids and scum must be removed as needed.

#### **Accessibility**

The location of a septic or dosing tank should be easily identifiable for inspection and maintenance. Septic tanks should be buried or protected sufficiently to prevent damage from vehicle traffic or constructed to withstand excessive traffic or soil loads. Ideally, septic and dosing tanks should have elevated access covers (or risers) to allow for easy access. If not, operators must unearth access ports for inspection and maintenance. Manhole risers and access covers should

be watertight and structurally sound. Access covers should be removable by one person.

### Visual Inspection

All tanks must be watertight. Otherwise, infiltration can result in hydraulic overloading. A system that is hydraulically overloaded will not function efficiently. Evidence of groundwater infiltration would be wall mud stains, cracks, openings, and observation of groundwater flowing into the tank. Excessive pump run times may also indicate system infiltration such as ground or stormwater inflow.

Conversely, if a tank is not watertight, exfiltration can occur, resulting in groundwater contamination. Signs of exfiltration are observation of a constant liquid level below the outlet, wetness around the outside of the tank area, or groundwater contamination. Therefore, inlet and outlet pipes or tees should be inspected for cracks, loose grout, or other indications of problems that may result in infiltration/exfiltration. (Note that these problems are often a result of a tank settling.)

Also, outlet baffles and sanitary tees often deteriorate, become damaged, or are simply missing and should be replaced or repaired. Baffle walls (if present) should be inspected for structural integrity, clear openings, and clear venting (at the top of the baffle).

### Removal of Solids and Scum

Failure to regularly pump out accumulated solids and scum (or septage) is a major cause of tank problems. As septage depth increases, the effective liquid volume and detention time decrease. This decreases treatment efficiency and allows more solids to escape from the tank and into other treatment components, clogging pipes and causing the system to fail.

When a tank is inspected, the depth of septage and scum should be measured in all compartments of the tank, including the vicinity of the outlet baffle. The tank should be cleaned whenever the bottom of the scum layer is within three inches of the bottom of the outlet device or the septage level is within 12 inches of the bottom of the outlet device (Figure 2-10).

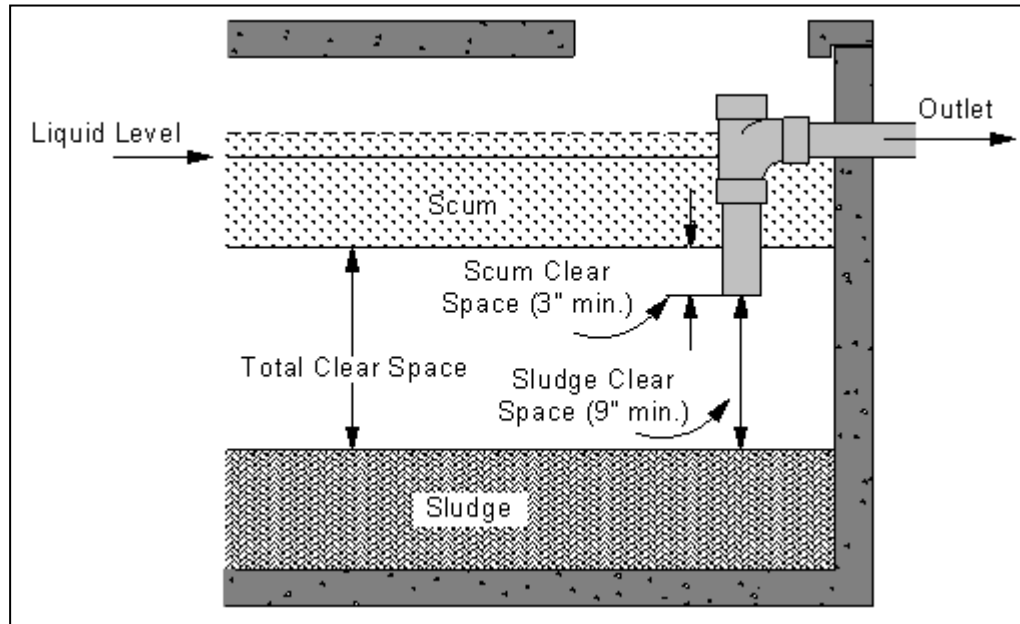

Figure 2-1. When to pump a septic tank.

Solids should be removed from the tank when the septage level in the tank reaches one third of the total depth of the tank or 25 to 33 percent of the liquid capacity of the tank. However, the efficiency of suspended solids removal may decrease before these conditions are reached.

Scum can be measured with a stick that has a hinged, weighted flap, or with any device that can be used to feel the bottom of the scum mat, such as a probe. The stick is forced through the mat, the hinged flap falls into a horizontal position, and the stick is raised until resistance from the bottom of the scum is felt. The distance to the bottom of the outlet device can be determined with the same tool.

As with lagoons, the sludge depth in a septic tank can be measured using a core taker sludge sampler, a clear core tube or a long stick wrapped with rough, white toweling (see Appendix A-3). Lowering this device to the bottom of the tank will show the depth of septage and the liquid depth of the tank. The stick or tube should be lowered behind the outlet device to avoid the scum layer. (The clear core tube could also include a check ball at the bottom to hold a column of liquid to view a cross section of the tank's contents.

When removing septage from a septic tank or dosing tank, the following should be considered.

- When using access openings for pumping, care should be taken to minimize the risk of harm to the inlet and outlet baffle.
- When a septic tank is pumped, it does not need to be disinfected, washed, or scrubbed unless repairs are necessary, or the tank is to be inspected for leakage.
- A small amount of solids may be left in the tank to provide a seed of the anaerobic

bacteria that will decompose the waste in the tank.

- Septic tank effluent quality monitored in the dosing tank may provide indications about conditions in the septic tank. Excessive solids or high BOD may indicate the need for increased pumping frequencies.
- Septic tanks are considered confined spaces and are subject to confined space entry regulations (OSHA Standard 1910.146). A septic tank or pump tank should never be entered without first having an approved confined space entry program in place. This program should include testing the air for oxygen content, lower explosive limit, and hydrogen sulfide. Because they are full of toxic gases such as methane and hydrogen sulfide, climbing into septic tanks is very dangerous.

Appendix A-3 contains more detailed information on inspecting and pumping septic tanks.

*Note: The safety measures mentioned here are not all-inclusive and OSHA should be contacted regarding specific confined space safety regulations.*

## *Dosing Tanks*

A dosing tank is basically a modified septic tank that stores pretreated wastewater for periodic discharge to subsequent treatment units or disposal areas. Effluent is gravity fed from the septic tank to the dosing tank. Effluent in the dosing tank is then periodically pumped to a sand filter or spray or drip field. Dosing tanks can also provide storage and limited pretreatment and solids separation. Dosing tanks usually have no baffle wall and have larger access ports to facilitate pump removal and inspection.

As with septic tanks, one of the most important details in dosing tank construction and inspection is water-tightness since the internal liquid level is often below surrounding groundwater levels. Any infiltration in the form of groundwater or stormwater can result in hydraulic overloading of the tank or spray or drip fields.

There are two types of dosing mechanisms – pumps and siphons. Most surface irrigation systems use pumping mechanisms rather than siphon mechanisms. Pumps can be set with float switches or timers to run an exact amount of time, dosing volumes can be easily adjusted, and pumps are generally simple to install and replace. Pumps do require power, however, and will not function during power outages, resulting in possible sewage overflows. Pumps wear with use, resulting in reduced dosing efficiency, and must eventually be replaced or rebuilt. Dosing volumes are dependent on both proper pump and float or timer operation.

Siphons, on the other hand, do not require power to function, require little to no maintenance and are relatively inexpensive. However, siphons must be set perfectly if using dual or alternating siphons. Siphons can also rust, causing trickling effluent discharge rather than dosing.

## Dosing Tanks with Pumping Mechanisms

A dosing tank with a pumping mechanism is often called a pump tank and consists of the tank, a pump and pump controls (Figure 2-11). The control system for the pump tank consists of a “pump off” switch, a “pump on” switch, and a high water alarm. The switches should withstand the humid and potentially corrosive atmosphere inside the tank. Pump failures can usually be traced to switch failures resulting in pump burnout. Therefore, high quality switches are a good investment. All electrical contacts and relays must be mounted outside the tank to protect them from corrosion. Provisions should be made to prevent gases from the tank escaping into the control box.

The tank should have sufficient volume to provide the desired dosing volume, plus a reserve volume. The reserve volume is the volume of the tank between the high water alarm switch and the invert of the inlet pipe. It provides storage during power outages or pump failure. A reserve capacity equal to the estimated daily wastewater flow is typically used for residential applications. In large flow applications, duplex pump units can be used as an alternative to provide reserve capacity.

Pump selection is based on the wastewater characteristics, the desired discharge rate, and the pumping head. If the liquid pumped is free from suspended solids, the pump may be set on a pedestal. This provides a zone below the pump where any solids entering the chamber can settle, thus reducing pump damage or malfunction. These solids must be removed periodically.

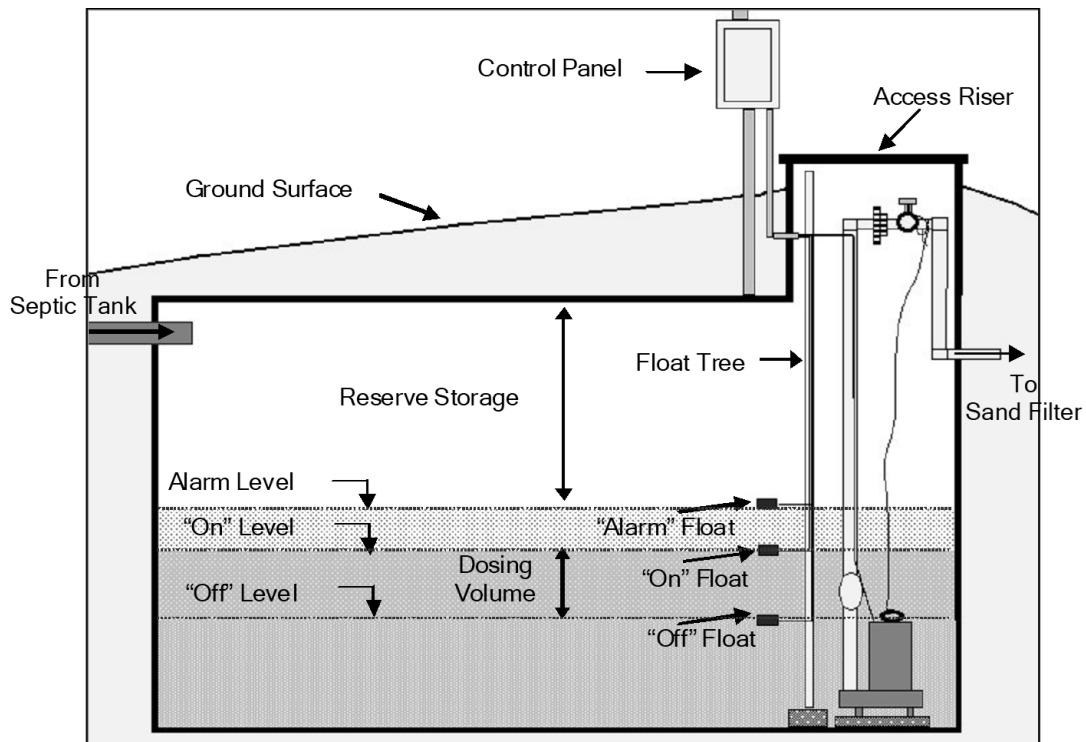

Figure 2. Dosing tank with pumping mechanism.

## Dosing Tanks with Siphon Mechanisms

Siphon mechanisms can only be used if the dosing tank is at a higher elevation than the discharge point and if the settleable and floatable solids have been removed from the waste stream. A tank using a siphon consists of only the tank and the siphon (Figure 2-12). No mechanical or electrical controls are necessary since the siphon operation is automatic. Two siphons may be placed in a tank and automatically alternate, providing a simple method of dividing the wastewater flow between two treatment or disposal units.

The design of the dosing tank is determined by the siphon selected and the head against which it must operate. The required dosing volume determines the length and width of the tank. No reserve capacity is necessary when siphons are used. When the tank fills, the siphon automatically discharges the water.

The size of the siphon is determined by the average desired flow rate. The siphon manufacturer should specify the "drawing depth" (the depth from the bottom of the siphon bell to the high water level necessary to activate the siphon).

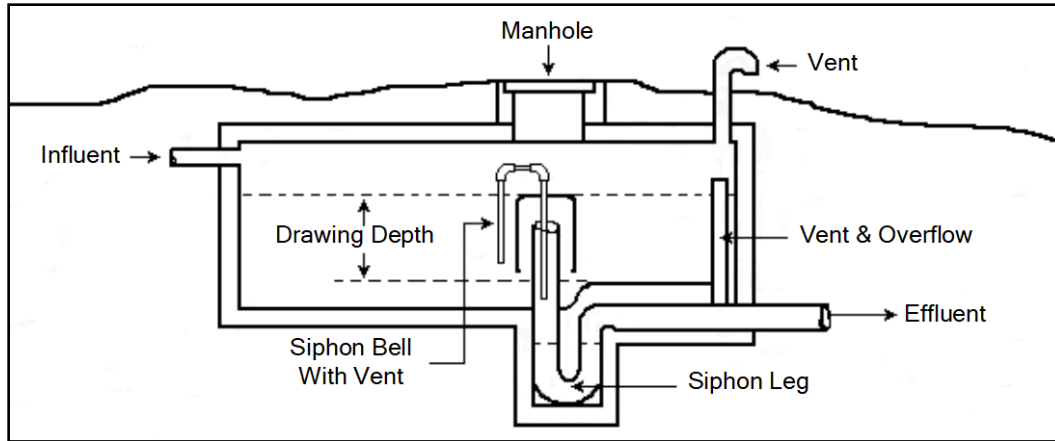

Figure 3. Dosing tank with siphon mechanism.

Siphons are made of either cast iron or fiberglass. Cast iron siphons are the most common but are subject to corrosion. Their advantage is that the bell is merely set on the discharge pipe so they can be easily removed and inspected. Fiberglass siphons do not corrode, but they must be bolted to the tank floor because they are so lightweight.

### *Dosing Tank Performance, Operation and Maintenance*

Performance and operation and maintenance issues for dosing tanks are like those for septic tanks. In addition, if a pumping mechanism is used, the system should be cycled to observe the operation of the pump and switches.

If a siphon is used, the water level in the tank should be noted over a period of time to determine if the siphon is operating properly. If it is, the water level will fluctuate from the bottom lip of the siphon bell to several inches above the bell. If the water elevation does not change despite additions of wastewater, the siphon is “dribbling,” indicating that the vent tube on the bell requires cleaning.

### **Grease Traps and Oil/Water Separators**

Wastewater from restaurants and certain industries and commercial establishments may contain high levels of fats, oils, and greases. Heavy concentrations of these materials can clog pipes and interfere with the proper operation of a surface irrigation system. It is desirable to remove fats, oils, and greases from the waste stream by installing grease traps or oil/water separators as part of the pre-application treatment system.

Food establishments and laundries handling laundry items from food establishments generate fats, oils and greases of animal and vegetable origin. The molecules of these materials have an unequal electrical charge and are polar in composition. They are readily biodegradable and can

be metabolized by microorganisms. However, if not removed from the waste stream they are the greatest contributor to pipe blockages and mechanical interference with treatment components.

Machine shops, service garages and other similar establishments (along with laundries which wash items from such facilities) generate oils and greases consisting of hydrocarbons or petroleum-based wastes. These molecules have a neutral charge and are therefore non-polar in composition. Unlike the fats, oils and greases of animal and vegetable origins, they degrade relatively slowly and generally pass through a treatment system without being significantly removed.

Fats, oils, and greases can exist in three forms: floatable (floating on the surface of the wastewater); soluble (small particles of grease and oils suspended in the wastewater); and emulsified (oils and grease dissolved into the wastewater) Although floatables are the most obstructive to lines and pipes, they can be easily removed from the waste stream using gravity. Soluble and emulsified oils and greases interfere with filtration units and are much more difficult to capture than the floatables.

In general, chemical additions that emulsify, disperse or dissolve fats, oils and greases will impair grease trap or oil/water separator performance. Examples of such chemical additions are soaps, detergents or hydrocarbon solvents used at establishments such as laundries, car washes and truck and engine degreasing facilities.

### *Grease Traps*

Grease traps are modified septic tanks that slow the flow of hot, greasy water and allow it to cool. As the wastewater cools, the fats, oils, and greases separate, congeal, and float to the top of the grease trap. Grease traps should receive only kitchen waste; no toilet waste should be plumbed into these devices. Restaurants and other food establishments handling oils and grease of a polar composition normally install small under-the-counter grease traps or large outdoor/underground grease interceptors.

Grease traps provide:

- grease and solid separation
- heat dissipation
- a mechanism for grease removal
- BOD and TSS reduction
- additional storage

Grease traps have a deeper outlet sanitary tee (50 percent of liquid depth) and larger access openings than septic tanks (Figure 2-13). Typically, grease traps and interceptors have two chambers separated by an upper baffle extending from the ceiling and a lower baffle rising from



the floor of the unit.

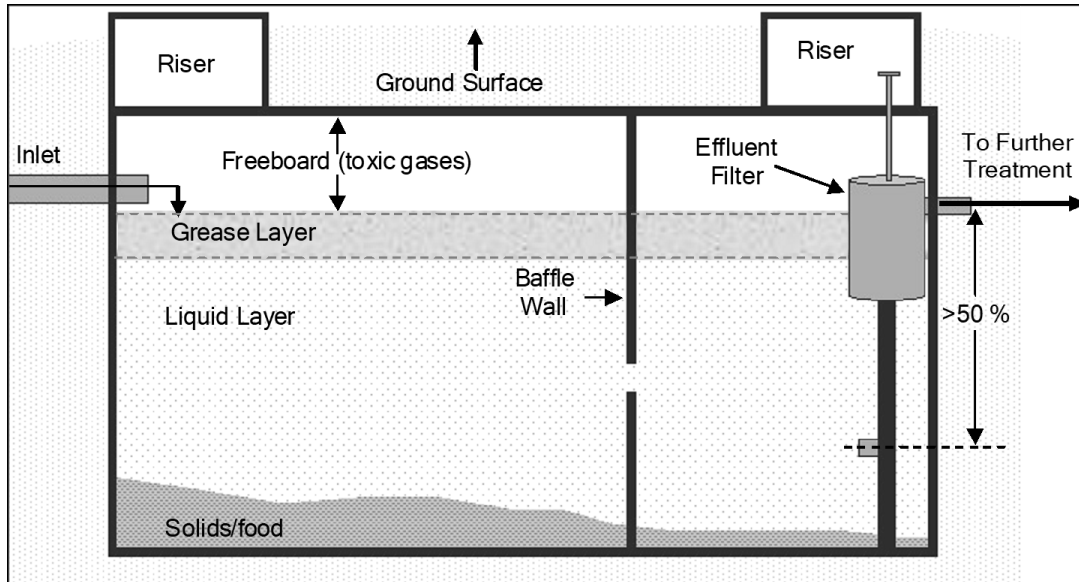

Figure 4. Typical two compartment grease trap.

As wastewater flows into the unit, fats, oils and greases float to the surface and solids settle to the bottom and are retained by the baffles. A slit in between the baffles or a space developed from overlapping baffles allows the treated wastewater to pass through to the second chamber. Floatable fats, oils and greases carried over to the second chamber are usually captured by a baffled or T-shaped discharge pipe.

The under-the-counter traps normally have a capacity range from 30 to 100 gallons. They are usually set directly beneath the source of wastewater, be it a wash sink, automatic dishwasher or other process operation discharging greasy wastes. Because of the size of the trap and the minimal grease retention capacity, these units need to be cleaned and serviced on a more frequent schedule than the outdoor grease interceptors.

Outdoor grease interceptors typically have the capacity in the range of 1,000 to 5,000 gallons. They usually are buried in the ground outside near the source of the greasy wastewater. Viewing and servicing are made possible through opening ports extending to the ground surface. Unlike the under-the-counter traps, they receive the discharge from nearly all the drainage lines in the food processing areas, including floor drains. The exception, in most cases, is the food garbage disposal. The particles of food deriving from this drain tend to load the retention capacity for solids too quickly. The required frequency of servicing the interceptor then becomes a burden to the food service establishment.

## Grease Trap Performance

Factors affecting grease trap performance include the distance of the grease trap from the grease-producing area, temperature, hydraulic loading, detention time and operation and maintenance. If the unit is too close to the source of grease and the temperature of the wastewater is extremely high, fats, oils and greases will remain suspended and pass through the unit. On the other hand, if the unit is too far from the source, the material can separate in the lines before reaching the unit and cause blockages. If the recommended hydraulic loading discharged to the unit is exceeded, not enough detention time is provided for the fats, oils, and greases to separate. Again, they will pass through the unit.

## Grease Trap Operation and Maintenance

One of the most common reasons that fats, oils, and greases pass through a grease trap is the failure to routinely check and service the unit. Servicing means removing the captured grease, oil, and solids by pumping them out and disposing of them properly. Therefore, all traps and interceptors must be easily accessible with means to inspect and service both chambers. Each unit has the capacity to retain a limited amount of floatable fats, oils and greases or settled solids.

The more of these materials that accumulate, the less detention time is available. Eventually, the retention capacity is exceeded, and any additional material passes straight through the unit. As with septic tanks, grease tank septage can only be removed and disposed of by someone permitted to do so by the Division of Waste Management, such as recycling companies and rendering operations.

## *Oil/Water Separators*

Facilities handling oils and grease of a non-polar composition (machine shops, service garages, and car washes) use oil/water separators. Many are like grease traps in design and function, removing free or floatable oils by means of gravity (Figure 2-14).

Conventional gravity separation can be enhanced using coalescing oil/water separators that contain plastic or other oil-attracting media. Oil and grease particles are drawn to the surface of the media as the wastewater passes through. The oil particles coalesce, forming beads of oil. These beads eventually float to the water surface (Figure 2-15).

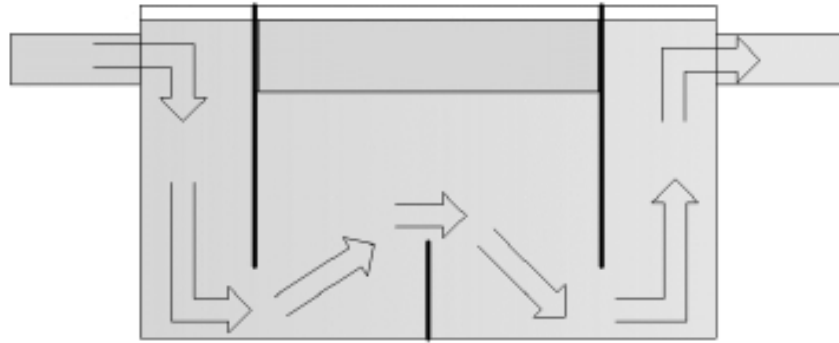

Figure 2-5. Schematic of a gravity oil/water separator.

Most oil/water separators continually remove the floating oils rather than have the separator pumped out periodically. This is accomplished by using skimmers to pull the floating oils off the surface of the wastewater and channel the recovered oils to a holding tank. Waste oil haulers then pick up the waste oil and take it to refineries to be recycled or dispose of it by burning.

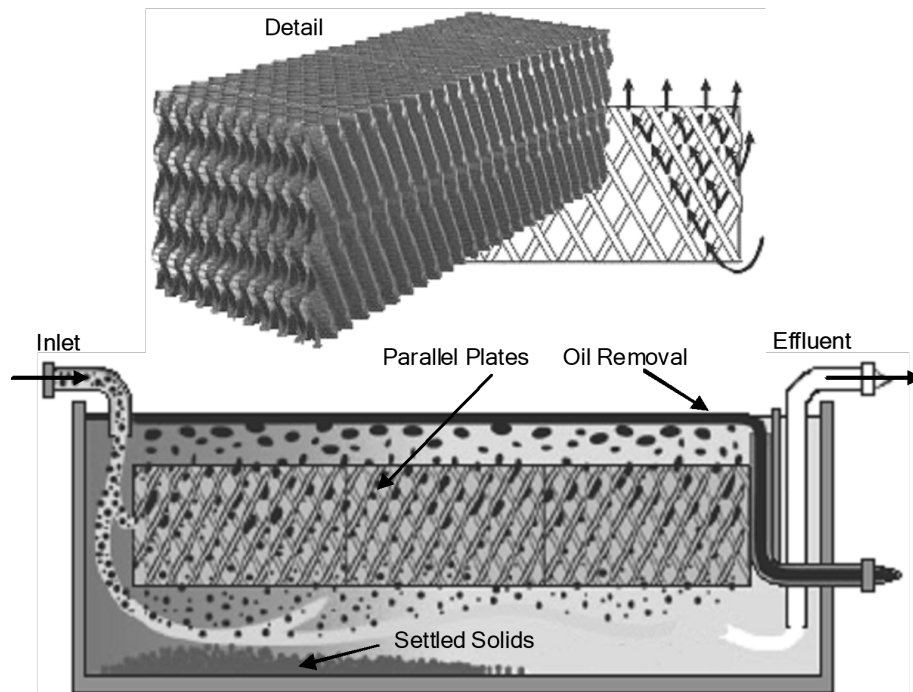

Figure 2-6. Coalescing oil/water separator with parallel plates.

Some skimmers consist of a standing pipe in the chamber of the unit. As wastewater flows into the separator, the water level rises, and any floating oils drain into the standing pipe. Another

variation is a tray or trough located in the chamber. As the water level rises, the floating oils overflow into the trough and are carried to a holding tank.

As mentioned earlier, gravity oil/water separators are not effective in removing suspended or emulsified oils and greases. Secondary forms of treatment are necessary to remove suspended or emulsified oil particles and include a variety of chemical, electrical, biological, and physical methods.

A common means of removing suspended oils is through filtration, often referred to as an ultrafiltration unit. Measured in microns, the filter pores are designed to permit water to pass through but not oils. The treated water flows on to the distribution system. The captured oils are sent to a holding tank. Eventually, the surface of the filters becomes saturated and clogged with waste oils and must be back-flushed to continue operating.

Ultrafiltration units require more frequent servicing and inspection than other oil/water separators but can remove a much greater amount of waste oil from the wastewater. Another method is dissolved air flotation. Pressurized air is pumped into the tank; oil and grease particles cling to the air bubbles and float to the surface where they are skimmed off.

Carbon filtration is a tertiary form of removing oils from the wastewater. Oils and oily wastes readily adhere to carbon particles. Because of the limited surface area of the carbon particles, eventually the filter must be changed. This form of oil removal is too costly to be used as the primary means of treatment.

## *2.3 Media Filters*

Because effluent from septic tanks normally requires further treatment prior to surface irrigation, media filters are often the second step in pre-application treatment. Although larger solids are removed by septic tanks, media filters are an excellent means of removing particulate matter and reducing total suspended solids (TSS), therefore reducing blockages of spray heads or drip emitters. They also reduce BOD, ammonium ( $\text{NH}_4^+$ ), and fecal coliform.

Media filters are watertight structures or lined excavations filled with some type of media (material), usually two to three feet deep. Underneath the media are collection drains. They may have a cover or lid or may be open to the air. Other components include vents, an inspection port, and a sampling chamber.

## **Treatment Processes**

Septic tank effluent, applied in small doses, percolates over and through the media. The underdrains collect the effluent and convey it to additional treatment. Organisms that live on the media treat the wastewater as it flows through. Air is maintained in the media pores, and it is

never saturated.

The treatment process is complex, involving physical, chemical, and biological mechanisms. Suspended solids are removed by filtration and sedimentation. Chemical adsorption (adherence) on the media surfaces also plays a role in the removal of some material.

However, the biological transformations that occur within the filter are the most significant part of treatment. Bacteria decompose organic solids and other material, reducing BOD and fecal coliform, and converting ammonium to nitrate (nitrification). These biological processes require aerobic conditions. Intermittent application of wastewater and venting of the underdrains helps ensure these conditions are maintained.

## Sand Filters

Sand filters are the oldest type of media filter and will be discussed in the most detail. They are non-proprietary, which means that a single company does not hold exclusive rights to their manufacture or design.

Sand filters are usually placed in lined excavations with masonry walls that separate the sand from contact with the soil. They are filled with clean sand 24 to 36 inches deep and are underlain with gravel and effluent collection drains. Sand filters can be configured in several different ways:

- buried or above ground
- gravity or pressure dosed
- single pass or recirculating

### *Buried Sand Filters*

Buried sand filters are constructed below ground and are covered with backfill material (Figures 2-16 and 2-17). A four to five foot deep excavation is usually made. The under-drains are surrounded by graded gravel or crushed rock and the upstream ends are brought to the surface and vented.

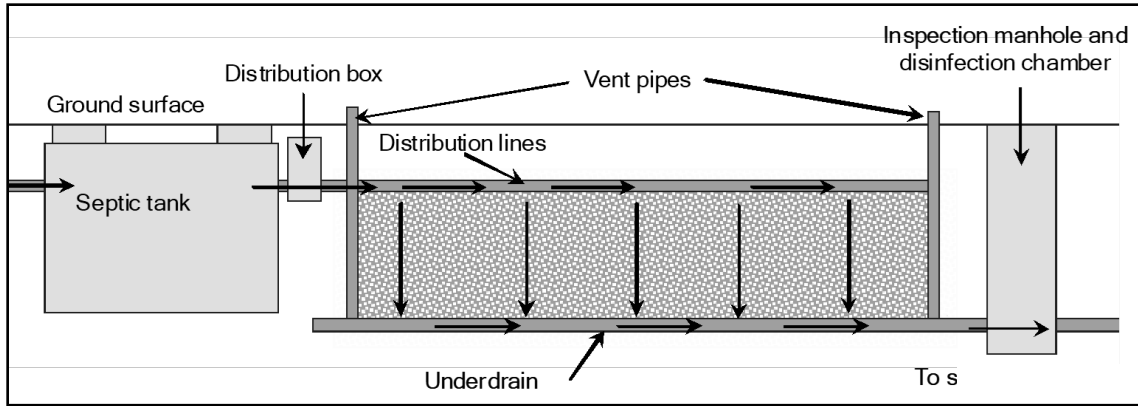

Figure 2-7. Profile view of a buried, gravity dosed, single pass sand filter.

After placement of the filter sand, another layer of washed graded gravel or crushed rock is laid over the filter surface along with the distribution piping for wastewater application. These pipes are vented to the ground surface at their downstream end. The entire filter is then backfilled.

The disadvantage to these filters is that they are not accessible to the operator and little no maintenance can be performed. These filters are usually gravity dosed and used for very small applications like single family homes.

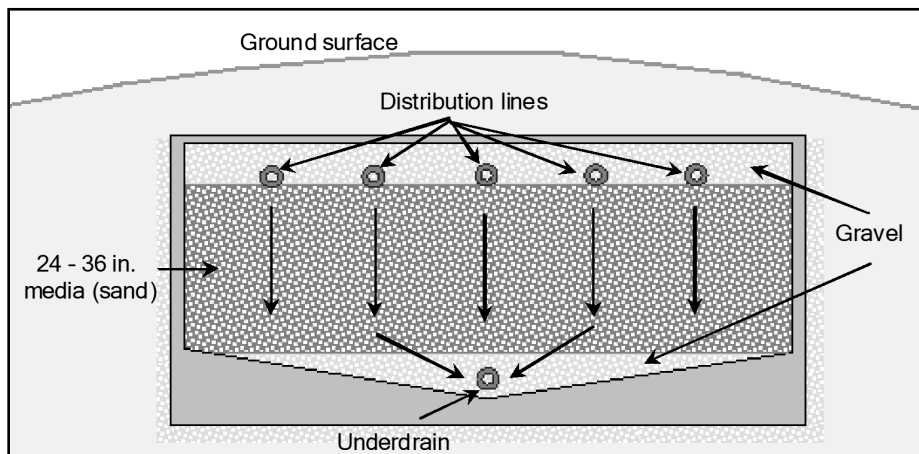

Figure 2-8. Cross-section of a buried, gravity dosed, single pass sand filter.

### *Above Ground Sand Filters*

Above ground, single pass sand filters are like buried sand filters except their surface is either left exposed or equipped with a cover or a lid. (Figure 2-18). If covered, the covers or lids must be constructed allow air to circulate through the filter to maintain aerobic conditions for biological activity.

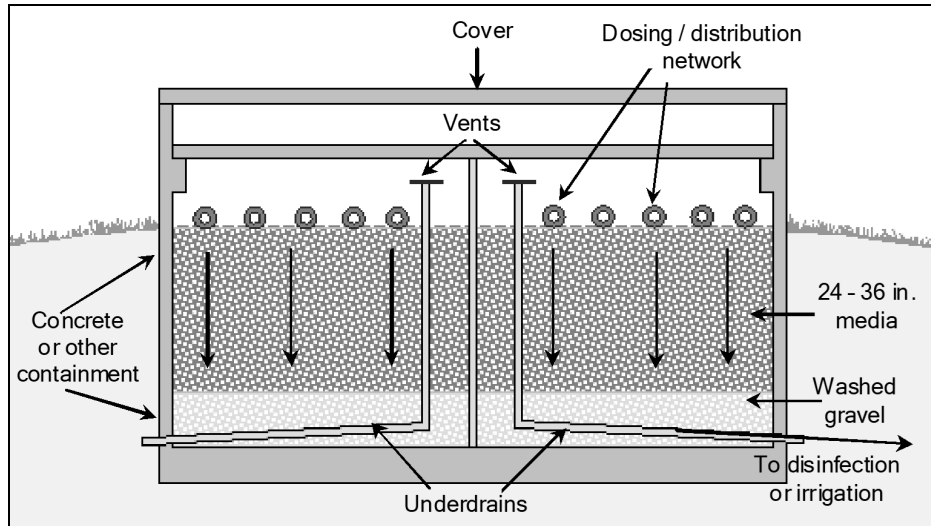

Figure 2-9. Above ground single pass sand filter.

### *Recirculating Sand Filters*

As their name indicates, recirculating sand filters employ filtrate recirculation. Septic tank effluent flows to a recirculation tank, where it is pumped to the sand filter. The effluent percolates through sand and collects in the underdrains. A portion of the treated effluent from the filter is returned to the recirculation tank where it mixes with incoming wastewater from the septic tank. The other portion of the treated effluent from the filter is sent to the irrigation field.

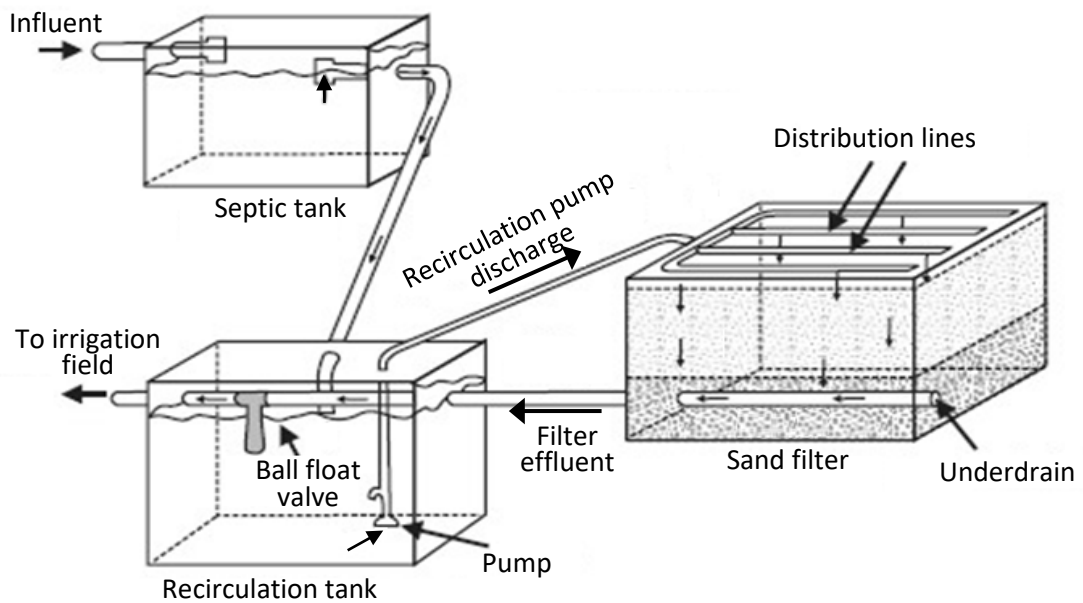

Figure 2-10. Recirculating sand filter system.

A recirculation ratio of 3:1 to 5:1 is typical. Recirculating sand filters minimize or eliminate odors and improve treatment efficiency as the result of more uniform loading cycles, decreased organic strength of septic tank effluent, and more frequent dosing. Consequently, they don't require as much surface area as single pass sand filters. Because recirculating sand filters produce a higher quality effluent, DWR promotes their use for new installations and requires justification for installation of a sand filter that is not recirculating. Table 2-2 shows a comparison of septic tank and recirculating sand filter effluent quality.

### Sand Filter Performance

The degree of stabilization attained by a sand filter is dependent upon the characteristics of the wastewater applied to the filter and the environmental conditions within the filter. Since sand filtration is largely a biological process, the characteristics of the applied wastewater affect the treatment achieved. Domestic wastewater is very amenable to sand filtration, whereas wastewater resistant to biodegradation may result in poor performance.

Table 2-2. Comparison of septic tank and recirculating sand filter effluent quality.

	Septic Tank	Recirculating Sand Filter
BOD <sub>5</sub> (mg/L)	130 – 150	2 – 15
TSS (mg/L)	30 – 150	5 – 20
NO <sub>3</sub> <sup>-</sup> (mg/L)	0 – 2	15 – 30
NH <sub>4</sub> <sup>+</sup> (mg/L)	25 – 60	0 – 5
Total N (mg/L)	25 – 70	15 – 30
Fecal Coliform (MPN/100ml)	10 <sup>5</sup> – 10 <sup>6</sup>	10 - 10 <sup>3</sup>

Variables that affect the operation and performance of sand filters include:

- pretreatment
- media size and depth
- hydraulic loading rate
- organic loading rate
- temperature
- dosing methods and frequency

#### *Pretreatment*



Sand filter performance is directly related to the degree of pretreatment achieved prior to the introduction of wastewater to the sand filter. Most of the solids must be removed by the septic tank to prevent clogging of the filter.

A properly functioning septic tank is essential for optimum performance of a sand filter. If a septic tank is hydraulically or organically overloaded, the design flow rate and the design BOD loading of the sand filter may be exceeded, leading to system failure. Studies have shown a direct relationship between degree of pretreatment and both longevity and effluent quality of sand filter systems.

There will be a slight accumulation of solids on the surface of the sand that must be periodically removed and disposed of in an approved manner. If there is a large accumulation of solids on the surface of the sand, the septic tank should be inspected to determine if it is operating properly. If the septic tank does not have an effluent filter, one should be installed.

With time accumulations of biomass and other particulate matter may build up near the filter surface to such a degree that the sand bed must be replaced to restore the hydraulic capacity of the filter to an acceptable level.

### *Media*

The size of sand used in a sand filter have a large impact on its performance. The effective size (the grain size for which 10 percent of the particles are smaller) of the sand affects the quality of wastewater that may be filtered, the rate of filtration, the penetration depth of particulate matter, and the quality of the filter effluent.

Sand that is too coarse lowers the wastewater retention time to a point where adequate biological treatment is not attained. Sand that is too fine limits the quantity of wastewater that may be successfully filtered due to early filter clogging and lack of oxygen reaching certain parts of the media.

Media depth depends on the type of filter and media used. Studies have shown that most treatment occurs within the top 9 to 12 inches of the bed. However, greater depth allows for better drainage, pathogen removal and maintenance.

For these reasons most media depths used today range from 24 to 36 inches. Although the use of more shallow filter beds may lower installation costs, deeper beds tend to produce a more constant effluent quality, are not affected as severely by rainfall, and permit the removal of more media before media replacement becomes necessary.

Whenever sand is removed from the surface due to accumulation of solids, the sand must be replaced to maintain adequate depth for treatment. When replacing sand, you must use the exact sand specified in the design. Do not go to your local home improvement store and buy place sand.

Doing so will ruin the sand filter and it will have to be replaced at great expense.

### *Hydraulic Loading Rate*

Hydraulic loading rates for sand filters are dependent on the specifications of the filter media, on whether the filter is buried or has free access, and whether the filter is single pass or recirculating. Organic loading rates and dosing patterns should also be taken into consideration.

Recommended loading rates vary throughout the literature and range from 0.75 to 5.0 gpd/ft<sup>2</sup>. For filters whose media size ranges between 0.35 and 0.50 mm, whose media uniformity coefficient is less than 3.0, and whose media dust content is less than 0.5, DWR generally recommends the following hydraulic loading rates:

- above ground single pass filters: less than or equal to 3.4 gpd/ft<sup>2</sup>
- below ground single pass filters
- vented: less than or equal to 2.44 gpd/ft<sup>2</sup>
- unvented: less than or equal to 1.44 gpd/ft<sup>2</sup>
- recirculating: less than or equal to 5.0 gpd/ft<sup>2</sup> (with a minimum 3:1 recycle ratio)

Hydraulic overloading of a sand filter results in less efficient removal of pathogens and other wastes and in a shorter filter runs (the service time during which the filter successfully accepts and treats the design flow of the system). In all cases, the hydraulic loading rates specified in the system permit must be followed.

### *Organic Loading Rate*

Sand filter performance is affected by the accumulation of organic material in the filter bed. An organic loading rate of less than 0.005 lbs BOD<sub>5</sub>/ft<sup>2</sup>/day is generally recommended. Like hydraulic overloading, organic overloading produces correspondingly shorter filter life, reducing the filter's performance and increasing the need for maintenance. Hydraulic loading rates are often adjusted to account for differences in the organic loading rate.

### *Temperature*

Temperature directly affects the rate of microbial growth, chemical reactions, adsorption mechanisms, and other factors that contribute to the treatment of wastewater within the sand filter media. Treatment slows during colder temperatures and therefore organic and hydraulic loading rates and dosing frequencies must be lowered to maintain adequate treatment. Some research shows that filters started in warm weather significantly outperformed those started in cold weather with regards to hydraulic longevity as well as effluent quality.

### *Alkalinity*

The amount of alkalinity present in the wastewater affects a sand filter's treatment efficiency. Normal nitrogen activity in the filter will cause a drop in the alkalinity present for the use by microorganisms. Artificial feeding of alkalinity for pH adjustment to the septic tank and/or the dosing chamber effluent may assist the filter's biomass in the nitrification process.

Several types of pH adjustment are available, and the safety of the operator must be considered when choosing the best type. The pH at no time should be raised above 8.0. The common pH adjustment chemicals used for wastewater treatment are sodium bicarbonate, sodium hydroxide and lime. Liquid chemicals are easier to dose and maintain consistent pH than powdered chemicals.

### *Dosing Methods and Frequency*

Dosing methods include drain tile distribution, low-pressure pipe, and spray distribution. The dosing system used should provide uniform distribution of wastewater throughout the filter cross-section. Uneven distribution can result in sections of the filter becoming overloaded and result in inadequate treatment of wastewater.

Sufficient time must also be provided between doses to allow for drainage and reaeration of pore space. Availability of oxygen within the pores allows for aerobic decomposition of the wastewater and almost complete stabilization of substances that are readily biodegradable. Under aerobic conditions the major end products of biochemical stabilization of carbonaceous and nitrogenous substances are water, carbon dioxide, bicarbonates, sulfates, and nitrates. In the absence of oxygen, carbonaceous material may be converted to carbon dioxide and methane, but nitrogenous substances degrade only to ammonia and cannot be oxidized to nitrate.

The frequency of dosing is important to sand filter performance. Early studies used a dosing frequency of once per day, but better performance and treatment has been obtained with two doses per day on sands with effective sizes ranging from 0.25 to 0.45mm. Other studies have shown that dosing frequencies beyond two per day provide no additional benefit for fine to medium sand sizes.

For filters with media greater than about 0.45mm, better purification is obtained when the frequency of dosing is increased beyond twice per day. The coarser media retains less water, limiting the amount of wastewater that should be applied at one time. This multiple dosing concept is successfully used in recirculating sand filter systems that employ a dosing frequency of once every 30 minutes. In general, more frequent dosing can allow higher loading rates with no decrease in treatment efficiency and without accelerated clogging of the filter.

## Sand Filter Operation and Maintenance

A sand filter should be raked as needed to remove any dried sludge crust from the surface of the filter. The removed crust must be disposed of in an approved manner. The raking performs several tasks that will assist the filter in treating the wastewater to its optimum performance. Raking allows the operator to break up the film of solids trapped on surface of the filter and levels the sand surface, allowing uniform distribution of wastewater. Raking also prevents weeds and grasses from gaining a foothold in the sand thus causing the wastewater to short-circuit by way of the root holes.

Vegetation, leaves, and trash must be removed from the sand filter. Such material, with the accumulation of solids, can lead to ponding. Ponding is a condition where wastewater accumulates on the surface of the filter due to the clogging of spaces between the sand grains. Ponding on the filter can indicate such problems as overloading, uneven distribution, the need for resting of the filter between doses and the need to remove the solids in the septic tank.

Distribution laterals should be flushed every 6 to 12 months to prevent solids accumulation. The performance of pumps, floats, timers, and other appurtenances should be routinely checked. The area of the sand filter should always be left untrafficked and undisturbed to prevent both contact with non-disinfected wastewater and interference with sand filter performance.

Clogging of the filter eventually occurs as the pore spaces between the media grains begins to fill with inert and biological materials. The operational period before clogging occurs is a function of the design factors, the amount of wastewater being treated, and the characteristics of the wastewater being treated. Once hydraulic conductivity falls below the average hydraulic loading, permanent ponding occurs. Although effluent quality may not initially suffer, anaerobic conditions within the filter result in further rapid clogging and a cessation of nitrification. Application of wastewater to the filter should be discontinued when continuous ponding occurs.

Eventually, filter clogging requires media regeneration. Raking of the surface will not eliminate the need for more extensive rehabilitation. The removal of the top layer of sand, as well as replacement with clean sand when sand depths are significantly depleted, appears to be very effective for filters clogged primarily near the surface. Resting of the media for a period of months has proven effective in restoring filter hydraulic conductivity.

## Other Types of Media Filters

In recent years, other types of media filters have been developed. These include filters whose media is made of:

- peat
- textile fabric
- polystyrene
- plastic
- foam

While they work on the same principles as sand filters, they are proprietary systems which means they are manufactured as “kits” or modules by companies who hold exclusive rights to their sale. The manufacturers have developed specific operation and maintenance procedures and they may require training and certification specific to a particular filter (a surface irrigation certificate is still required by DWR).

Compared to sand filters, these media filters produce as high or higher quality effluent. Wastewater is pressure dosed and distributed and they can be designed as single pass or recirculating; however, most are recirculating due to the greater treatment efficiency of this design. Although sand filters are still commonly found in older systems, the trend is toward using these “innovative” media filters in newer systems.

## *2.4 Disinfection*

Disinfection is generally the last form of pre-application treatment prior to surface irrigation of wastewater. The purpose of wastewater effluent disinfection is to destroy disease-producing microorganisms or pathogens. As discussed in Chapter 1, pathogens can cause many illnesses such as typhoid fever, amoebic dysentery, and infectious hepatitis.

It is important to note that wastewater disinfection is not the same as sterilization. Disinfection is the reduction of pathogenic microorganisms to a tolerable threshold, while sterilization is the destruction of all microorganisms. Fortunately, disinfection is effective because pathogenic organisms are more sensitive to destruction than nonpathogenic organisms.

The disinfection process should be economical, operationally practical, and environmentally acceptable. The three major types of disinfection used are:

- chlorination
- ultraviolet radiation
- ozone

## Chlorination

Because of its simple feed and control procedures, its ability to disinfect wastewater with low dosages and its relatively low cost, chlorination is the most prevalent form of disinfection in the United States today. However, heightened awareness of the safety issues and environmental concerns associated with chlorine use may decrease its popularity in the future.

Several forms of chlorine can be used in wastewater disinfection:

- liquid/gas chlorine ( $\text{Cl}_2$ ) – available in pressurized containers that maintain chlorine in a liquid state
- calcium hypochlorite ( $\text{Ca}(\text{OCl}_2)$ ) – a white powder or tablet
- sodium hypochlorite ( $\text{NaOCl}$ ) – a pale yellow solution in water

Chlorine in either the gaseous or liquid state is considered to be 100% available chlorine for disinfection purposes. Calcium hypochlorite, purchased in powder or tablet form, generally contains approximately 65% or 70% available chlorine. Sodium hypochlorite is usually purchased as a solution containing approximately 15% available chlorine. (The manufacturer's label should contain this information.)

Chlorine reacts with many compounds present in wastewater. Nitrogen compounds (including ammonia) react with chlorine to produce chloramines. These chloramines are relatively effective disinfectants. However, many of the compounds formed when chlorine reacts with non-nitrogen compounds are ineffective as disinfectants. Chlorine reacts with non-nitrogen compounds before it reacts with nitrogen compounds.

Enough chlorine must be added to react with the non-nitrogen compounds and ensure that there is enough chlorine still available for the formation of chloramines. Less chlorine is required to disinfect a higher quality effluent than a poorer quality effluent because there are fewer compounds with which the chlorine may react.

Chlorine dosage is the amount of chlorine that is added to a given volume of wastewater. Chlorine demand is the amount of chlorine that is not available as a disinfectant because of reactions with various compounds in the effluent. Chlorine residual is the amount of chlorine in the effluent that is available for disinfection after a specific contact time. A minimum chlorine residual must be maintained to ensure that enough chlorine has been added to meet all the chlorine demand.

The relationship between chlorine dosage, chlorine demand, and chlorine residual can be expressed as follows (although this is true only if the chlorine dose is equal to or greater than the demand):

$$\text{Chlorine dose} - \text{Chlorine demand} = \text{Chlorine residual}$$

Measurement of chlorine residuals must be performed by approved methods. Amperometric titration provides the most convenient and most repeatable results but is more expensive than other methods. A less expensive method is the DPD test.

Factors affecting the effectiveness of chlorination include:

- injection point and method of mixing
- design of contact chambers
- contact time
- effectiveness of upstream treatment processes
- temperature
- dose rate and type of chemical
- pH
- the number and types of organisms present in the effluent

Chlorine contact chambers should be designed so that the chlorine injection point is below the surface of the effluent to prevent volatilization. Chambers should also be designed to prevent short-circuiting of effluent. Higher chlorine concentrations, longer contact times (chlorine contact basins should be designed for a minimum of 30 minutes of contact time) and higher temperatures increase the effectiveness of chlorination while higher pH (above 7.0), TSS and organic content decrease effectiveness.

Chlorine disinfection is generally accomplished by one of the following methods:

- gas chlorination
- hypochlorination
- tablet chlorination

Gaseous chlorine is usually delivered by a vacuum-solution feed chlorinator that creates a vacuum, pulling chlorine into the water supply. Because this type of chlorinator uses pure chlorine, which is toxic, the manufacturer's operation instructions must be carefully followed. You should never attempt to operate a gas chlorinator without first reading the manufacturer's operation manual.

Hypochlorinators (Figure 2-20) are pumps or devices used to feed chlorine solutions made from sodium or calcium hypochlorite. The basic components are a storage reservoir or mixing tank, a metering pump, a feed-rate adjustment device, and an injection device.

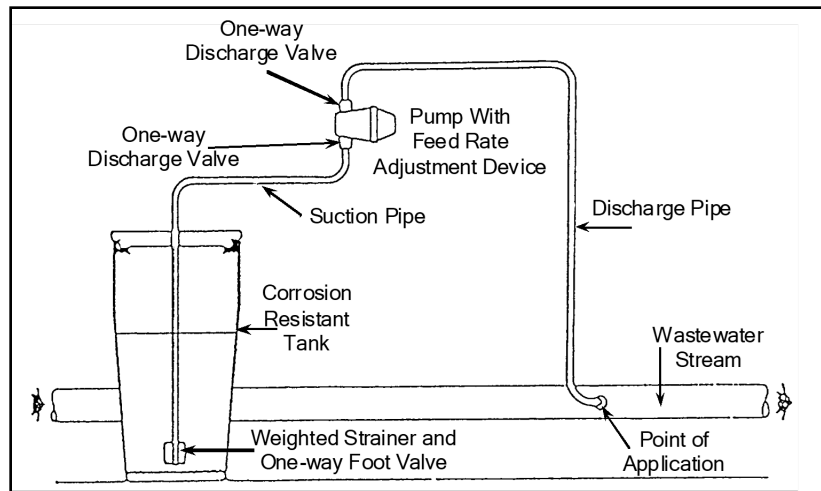

Figure 2-11. Schematic of a typical hypochlorinator.

Tablet chlorinators (Figure 2-21) use calcium hypochlorite tablets (around 70% available chlorine). The chlorinator has several slotted tubes where the tablets are placed in vertical stacks. As wastewater flows through the slotted tubes, the tablets dissolve in the effluent stream. Dosage is determined by the number of tubes containing tablets and the height of water in the chlorinator.

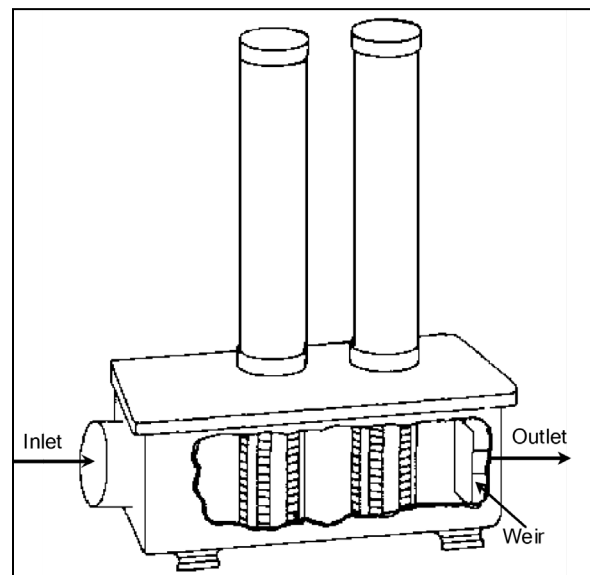

Figure 2-12. Tablet chlorinator.



### *Leak Detection and Chlorine Safety*

Chlorine is a highly toxic gas and is corrosive in moist atmospheres. Because of the corrosive nature of chlorine, leaks should be repaired as quickly as possible to prevent a minor leak from becoming a major leak. Small leaks can be found by using a rag soaked with an ammonia solution. A "squeeze bottle" filled with ammonia water may also be used. The vapors from the cloth or squeezed from the bottle will form a white cloud to indicate a chlorine leak. Care must be taken to avoid spraying ammonia water on any leak or touching the ammonia-soaked cloth to any metal.

As mentioned earlier, chlorine reacts with water to form hypochlorous acid. If inhaled, chlorine gas is absorbed by moisture that coats the lungs and destroys cell tissue. Chlorine that comes into contact with skin can cause mild to severe burns. If chlorine comes into contact with skin or clothing, the affected body parts should be flushed with water for at least 15 minutes. Symptoms of chlorine exposure are:

- burning of the eyes, nose, mouth, and throat
- coughing and choking
- nausea and vomiting
- headache and dizziness

All enclosed areas which house chlorine cylinders or equipment should have operating leak detectors. These detectors should be located outside the enclosed area and their wiring should be checked regularly. Chlorine should never be stored near gasoline, oils, or similar materials. Chlorine reacts violently with these substances. Water should never be applied to a chlorine leak, as the leak will only become larger. Do not store or use chlorine cylinders where they will be exposed to the sun.

When changing chlorine tanks, these minimum precautions must be followed:

- wear safety goggles, rubber gloves, and a long sleeved shirt
- have two operators present: one to perform the work and one to assist should a leak develop
- allow only trained personnel to enter a contaminated area

Always remember that chlorine is a hazardous chemical and must be handled with respect. Every person working with chlorine should know the proper ways to handle it, should be trained in the use of appropriate respiratory protective devices and methods of detecting hazards, and should know what to do in case of emergencies. All facilities that use chlorine should develop an emergency response plan. Emergency response plans will be covered in Chapter 5.

*Note: The safety measures mentioned here are not all-inclusive and OSHA should be contacted regarding specific chlorine safety regulations.*

## Ultraviolet Radiation

Ultraviolet (UV) radiation uses lamps that emit wavelengths of light that are invisible to humans. Ultraviolet radiation kills bacteria and viruses in wastewater effluent by destroying their cellular genetic material, thereby preventing cell replication. Unlike chlorine, UV radiation leaves no residual in the wastewater and adds nothing except energy that produces some heat. Ultraviolet (UV) light is generally considered as an alternative to chlorine disinfection when the permit requires very low or no chlorine residual or because of safety concerns. A typical ultraviolet disinfection unit is shown in Figure 2-22.

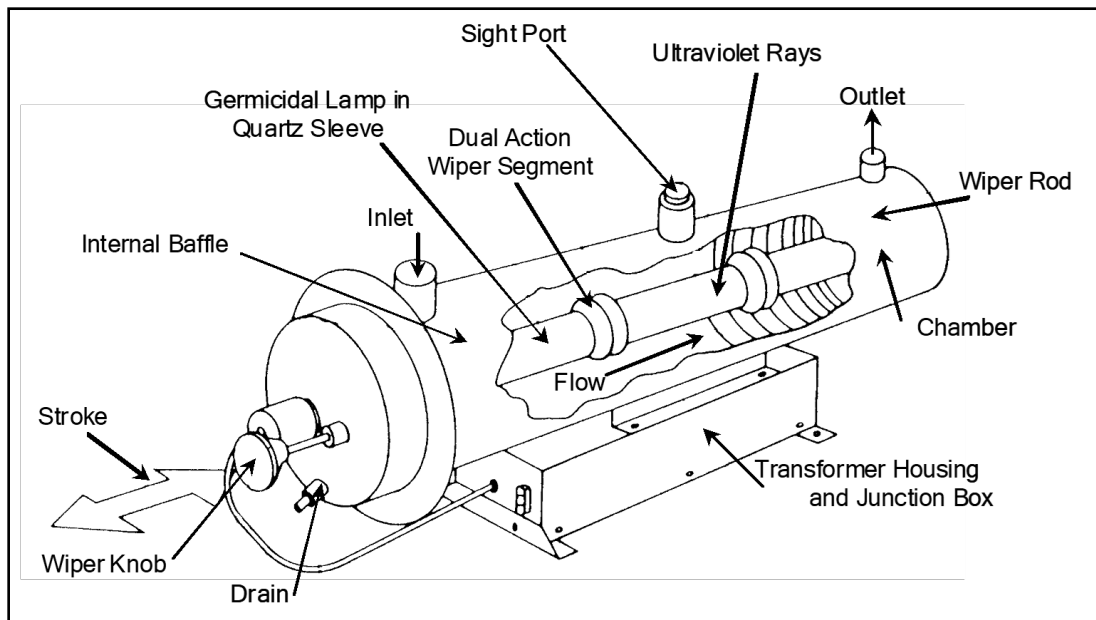

Figure 2-13. Ultraviolet radiation unit.

The advantages of UV disinfection are: there is no toxic residual, it is effective on a variety of microorganisms, UV equipment occupies little space, and is relatively inexpensive. The disadvantages of UV are the lack of a measurable residual (which makes immediate control of the process difficult), the lack of methods for measuring dosage and the need for a lower suspended solids and color concentration for it to be effective. For UV disinfection to be effective, wastewater must be relatively clean and clear, UV tubes must be kept submerged and cleaned periodically, and organisms must come into direct contact with the UV light.

## Ozone Disinfection

Ozone is not widely used in wastewater disinfection. Ozone is an unstable gas that is produced when oxygen molecules are disassociated into atomic oxygen and then collide with another oxygen molecule. Like chlorine, ozone is a strong oxidizing agent and destroys microorganisms by attacking the cell walls.

Because it is chemically unstable and decomposes to oxygen very rapidly, ozone must be produced continuously and must be used as it is produced. Ozone is bubbled through the effluent in a closed contact chamber with fine bubble diffusers covering the bottom of the chamber. Contact time is generally around 5 minutes. Ozone is then collected off the top of the contact chamber and destroyed.

Ozone is a toxic chemical that can cause severe lasting effects with exposure of more than 1 mg/L. To be effective ozone disinfection requires high transfer efficiency, good mixing, adequate contact time and minimal short-circuiting in the contactor.

The advantages of using ozone as a disinfectant include the lack of a toxic residual, an increase in effluent dissolved oxygen levels, almost instantaneous disinfection action, and is relatively insensitive to pH. Disadvantages include higher capital and operational costs and a lack of reliable automatic control systems.



## Chapter 3

### The Natural Treatment System

Final treatment and beneficial use of wastewater occurs at the surface irrigation site. The soil and vegetation function as a natural treatment system that removes, transforms, and recycles contaminants and nutrients. Not all sites, however, are suitable for irrigation of wastewater.

#### *Soil -- One Half of the Natural Treatment System*

Important functions that soil performs include:

- providing a medium for plants to grow
- providing a habitat for microorganisms
- storing and supplying water and nutrients to plants
- filtering, storing, and breaking down contaminants

#### Components of Soil

Soil forms over hundreds of years from rocks and decaying plants and animals. It is made up of solid material and the space between the solid material. The solids consist of mineral particles and organic matter. The spaces between the solids, called **pore space**, is filled with either air or water. An “ideal” soil contains around 45 to 48% mineral particles, 2 to 5% organic matter, 25% air, and 25% water (Figure 3-1).

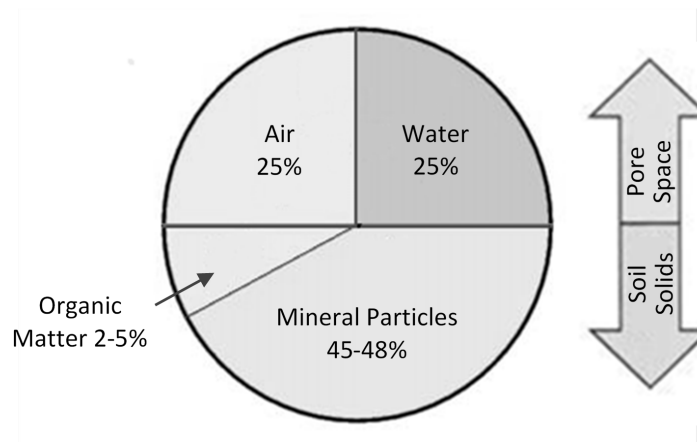

Figure 3-1. Composition of a soil that is “ideal” for surface irrigation.

The percentage of pore space that is filled with water or air changes based on how wet or dry the soil is. The types and amounts of solids determine the physical, chemical, and biological treatment capacity of the soil.

## What is a Soil Profile, a Soil Horizon, and a Soil Series?

To understand soil and how one soil differs from another, soil scientists name or “classify” soils by evaluating their physical, biological, and chemical properties. This classification is based on a three-dimensional volume or unit of soil called a soil profile. A **soil profile** is a vertical section of soil from the ground surface to the parent material (the original material the soil formed from). Each profile consists of a series of layers, called **soil horizons**, whose properties differ from the layers above and beneath.

Soils that have very similar profiles are classified as the same **soil series**. Soils in the same series have major horizons that are similar in thickness, arrangement, and other important properties. A soil series name generally comes from a town or landmark in or near the area where the soil series was first recognized. The properties of the soil series that exist at a proposed site determines if the site is suitable for irrigation of wastewater.

Each soil series has at least one, and usually three or four, horizons. Additional horizons can also be present, depending upon soil forming factors and soil age. Under disturbed conditions -- heavy agriculture or severe erosion -- not all horizons will be present. For our purposes, we are mainly concerned with the A and B horizons (Figure 3-2).

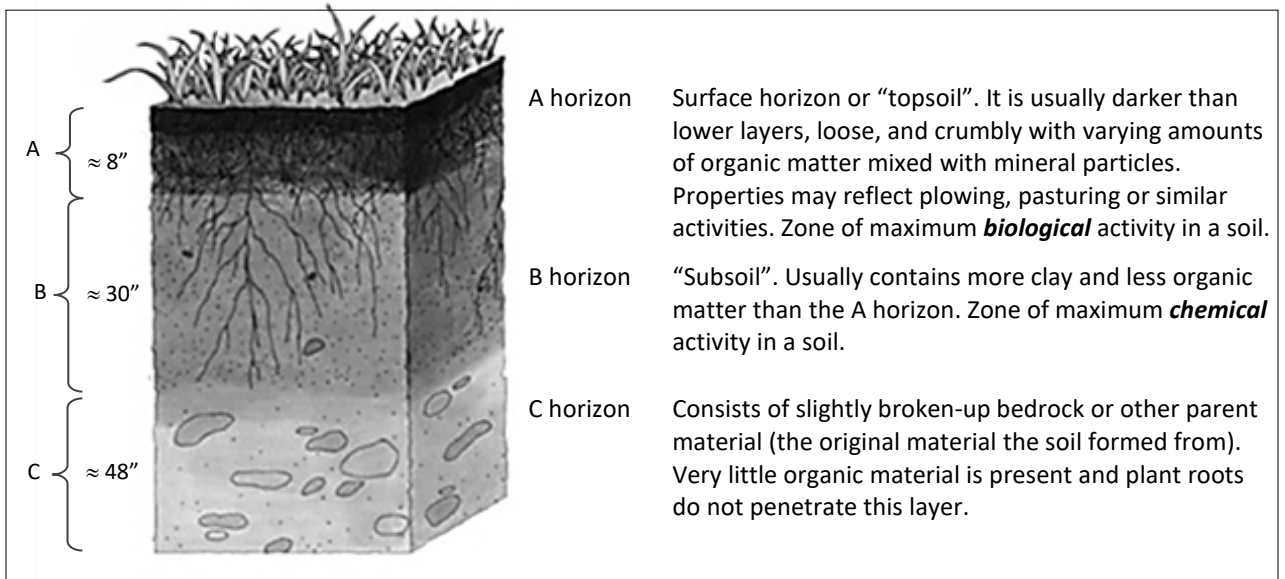

Figure 3-2. Simplified profile of a soil in the NC Piedmont region.

## Soil Properties

Soils vary greatly over short distances. A field at a land application site often contains several soil series, each with its unique properties. Some of these properties are inherent – they are

permanent and do not change. Other properties are dynamic and change depending on management.

A working knowledge of soil properties and processes will help you, as an operator, understand the limitations imposed by inherent soil properties and the challenges posed by dynamic soil properties. The goal is to manage your site(s) in a manner that maintains, and possibly improves, the treatment capacity of the soil(s).

Soil properties that influence wastewater irrigation include:

- soil texture
- soil structure
- infiltration
- percolation and permeability
- soil depth and restrictive horizons
- seasonal high water table
- topography
- soil pH
- cation exchange capacity

### *Soil Texture*

The mineral particles in the soil come in three sizes: sand-sized particles are the largest, silt-sized particles are medium-sized, clay-sized particles are the smallest (Figure 3-3). Every soil contains some of each particle size, but not every soil contains the same amounts. The percentage of each particle size in a particular soil determines the soil's texture.

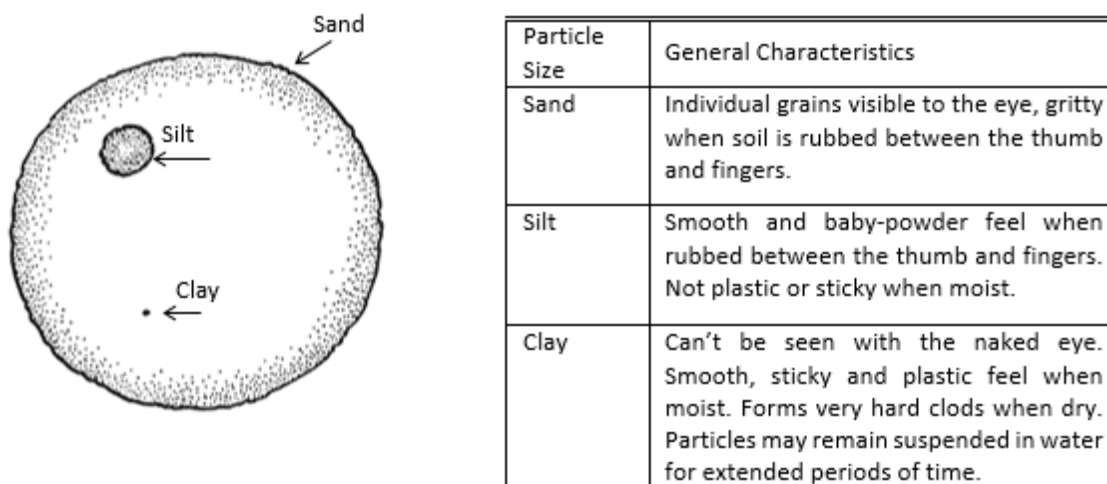

Figure 3-3. The three particle sizes (not to scale) and their general characteristics. If a sand particle is the size of a basketball, a silt particle would be the size of a golf ball, and a clay particle the size of a dot made by chalk.

The four major soil textural classes take their names from the three particle size categories. Sand is made up of mostly sand-sized particles, silt is mostly made up of silt-sized particles, and clay is mostly made up of clay-sized particles. The fourth major textural class is called loam. **Loam** is not another particle size, but is a balanced mix of sand, silt, and clay-sized particles (Figure 3-4).

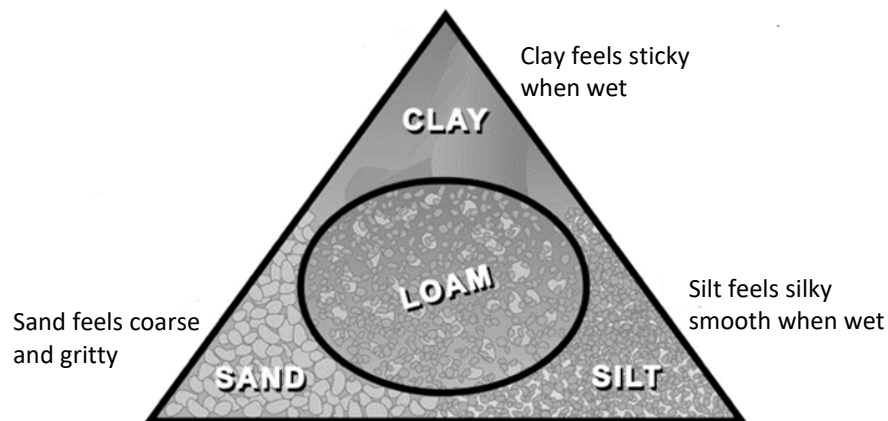

Figure 3-4. The 4 major textural classes: sand, silt, clay, and loam.

There are a total of 12 soil textural classes (Table 3-1) that can be lumped into three general categories: coarsely-textured (sandy soils), medium-textured (loamy soils), and finely-textured (clay soils).

Table 3-1. The 12 soil textural classes.

General Terms	Textural Class
Sandy soils (coarsely-textured)	Sand
	Loamy sand
Loamy soils (medium-textured)	Sandy loam
	Loam
	Silt loam
	Silt
	Clay loam
	Sandy clay loam
	Silty clay loam
Clayey soils (finely-textured)	Sandy clay
	Silty clay
	Clay

Texture influences soil suitability for wastewater irrigation in many ways. Texture is related to the size and shape of soil pores, which affects water movement into and through the soil. Texture



influences the balance between water-filled pores and air-filled pores, creating different soil environments for root growth and microorganism activity.

Coarsely-textured soils have large spaces (**macropores**) between their soil particles. Water and air pass through these macropores rapidly. Consequently, coarsely-textured soils are usually well-aerated and well-drained.

However, water often passes through these soils too quickly for significant treatment to occur. In addition, these soils may not hold enough water and nutrients to support healthy vegetation. A poor vegetative cover results in reduced uptake of water, nutrients, and pollutants and an increased potential for soil erosion.

Clayey soils have smaller spaces (**micropores**) between soil particles. Due to cohesive and adhesive forces, micropores hold water, nutrients, and pollutants more tightly than macropores. Consequently, water tends to move into and through finely-textured soils more slowly.

Loamy or medium-textured soils have a range of pore sizes. Water can flow through the smaller pores while air can move through the larger pores. Medium-textured soils provide favorable environments for root growth, store large amounts of water for plant use, and have good nutrient-supplying power.

Texture is an inherent soil property. Because texture is the relative proportion of sand-, silt-, and clay-sized particles, it can be modified only through the addition of one of these particle sizes. This may be feasible when working in greenhouses or small garden plots but changing soil texture on a large scale is not practical, so soil texture is considered an inherent property.

### ***Soil Structure***

**Soil structure** is the arrangement of individual sand, silt, and clay particles into clusters of particles called soil *aggregates*. Aggregates occur in different shapes and patterns, resulting in different kinds of soil structure. Examples include granular, blocky, platy, prismatic, structureless–single grained, and structureless–massive (Figure 3-5).

Soil structure is important because it modifies some of the undesirable effects of certain textures on water and air movement. Structure creates relatively large pores between the aggregates, which are much larger than those between individual soil particles. Water, air, and plant roots move more readily through the macropores between aggregates than through the micropores inside the aggregates. Good structure means good aeration and a favorable balance between air and water containing pores.

The ideal structure for agriculture and wastewater irrigation is granular structure in the topsoil and blocky structure in the subsoil. Water movement in soils with platy, prismatic, or massive structure is slow and restricted (Table 3-2).

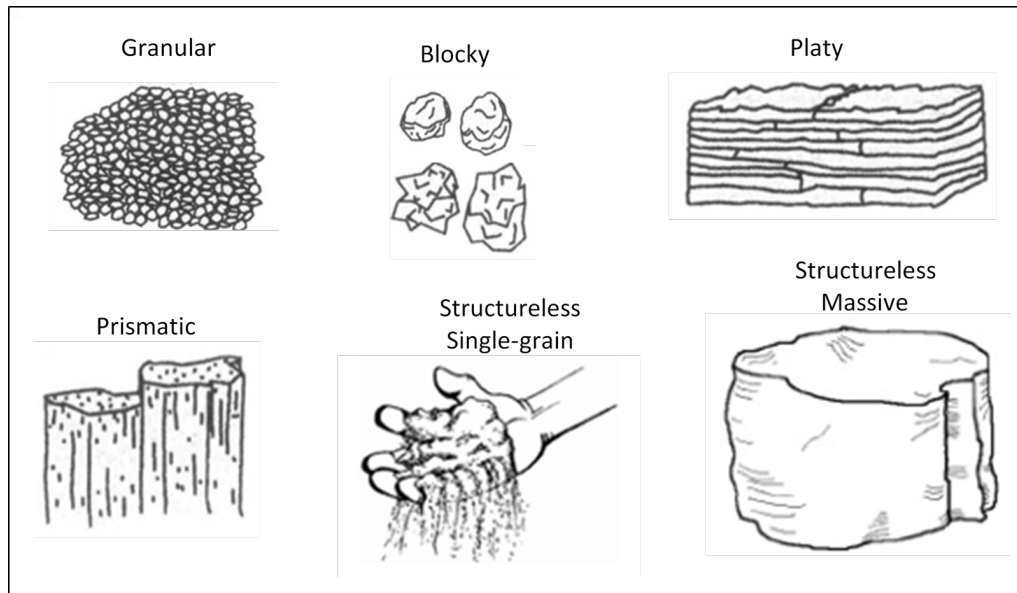

Figure 3-5. Examples of soil structure.

Table 3-2. Descriptions of soil structure types and rate of water movement.

Type	Description	Water Movement
Granular	Small, rounded aggregates, resembling cookie crumbs that separate easily from each other. Usually found at the soil surface in the A horizon where there is more organic matter and biological activity.	Rapid
Blocky	Irregular block-like aggregates that can have angled or rounded sides. Blocky structure is most common in the B horizon where clay content is higher.	Moderate
Platy	Overlapping plates or sheets piled horizontally on one another. Platy structure can be found in the surface or subsoil.	Slow
Prismatic	Vertical columns or pillars separated by miniature, but definite, vertical cracks. It is commonly found in the B-horizon where clay has accumulated.	Slow
Structureless – single grain	There is no structure, only individual soil particles that are not aggregated into any other soil structure. Beach sand is a good example.	Very rapid
Structureless - massive	There is no structure. The soil does not naturally separate into structural units because there are none. This is common in C horizons or in very sticky clay soils.	Very slow

Soil structure is a dynamic soil property. Unlike texture, structure is easily altered by management practices. Maintaining strong, stable aggregates is important in any good soil management strategy. Wastewater is a valuable soil amendment because it adds organic matter which

encourages the formation and maintenance of good soil structure. In addition, application stimulates root growth which tends to bind particles together.

On the other hand, driving heavy equipment on wet soil (especially clayey soil) breaks down soil aggregates. The breakdown of soil structure is called **soil compaction**. Soil particles are pressed closely together and macropores disappear. Compaction can change granular or blocky structure into platy or massive structure (Figure 3-6). **Subsurface compaction** (traffic pans and plow pans) are compacted layers that can develop beneath the topsoil as a result of driving heavy equipment or tilling soil when wet (Figure 3-7).

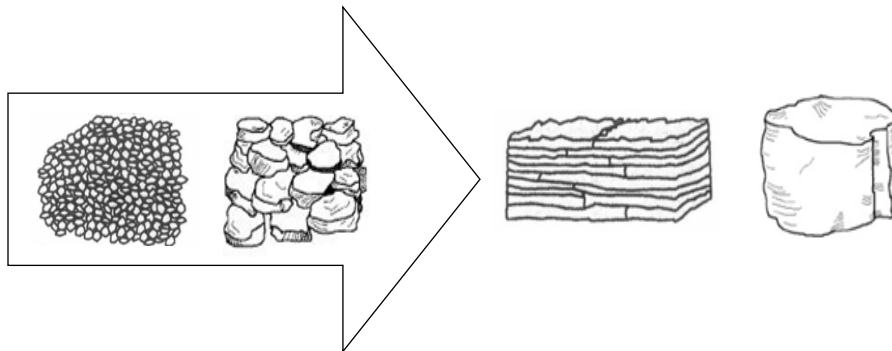

Figure 3-6. Compaction can turn granular or blocky structure into platy or massive structure.

Compaction of topsoil can also occur. **Surface crusting** is a form of compaction that happens when the impact from water falling on or flowing over bare soil breaks down soil aggregates. Individual soil particles become suspended in water, flow together, and then dry into a hard crust.

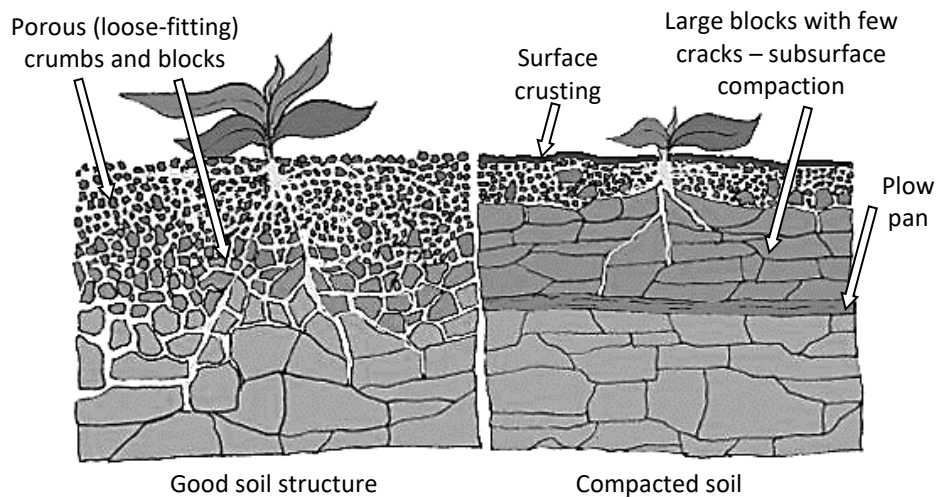

Figure 3-7. Example of good soil structure and compacted soil.

Soil compaction reduces:

- water and air movement into and through the soil
- seedling germination and emergence
- root penetration
- nutrient and water uptake by crops
- treatment capacity of the soil

Soil compaction should be avoided. Limiting operations on wet soils, reducing load weight when possible, and using flotation tire, doubles, or tracks will go a long way toward limiting compaction and maintaining soil productivity. Maintaining a healthy crop and crop rotations that include deep-rooted plants like alfalfa will help protect soil structure.

Tilling can break up compaction in the topsoil, although no-till fields and fields with perennial forages are a problem. Subsoiling, a process of deep tilling with a disk chisel, subsoiler (disk ripper), or ripper, penetrates soil below normal tillage depths (usually 12-18" deep) and breaks up deeper compaction. Low-disturbance subsoiling equipment can break up deep soil while leaving the surface virtually untouched. Subsoiling works well on Coastal Plains soils but is not effective in very clayey or rocky soils.

## ***Infiltration***

***Infiltration*** is the movement of water *into* the soil. ***Infiltration rate*** (expressed in inches per hour) is the maximum rate at which water enters the soil. A moderate to rapid infiltration rate is desirable for plant growth and the environment. Infiltration rate is a function of surface texture and structure, vegetative cover, slope, and soil moisture.

- ***Surface texture and structure.*** We have already discussed the effects of texture and structure on water movement. A surface soil with medium to coarse texture and good structure will have a rapid infiltration rate. Infiltration rates can be near zero for very clayey and compacted surface soil.
- ***Vegetation.*** A healthy vegetative cover or crop protects soil structure and increases infiltration rates. Without the protective benefits of vegetative, water falling on or flowing over the soil destroys surface structure and results in surface crusting.
- ***Slope.*** On flat or gently sloping land, water has more time to soak into the soil surface. On steeper slopes, water moves over the surface more rapidly and the amount of time for infiltration is reduced. Soils tend to be thinner on steep slopes, limiting storage of water. Where bedrock is exposed, little infiltration can occur, except through large cracks which is unacceptable. We will discuss slope in more detail later in this section.
- ***Soil moisture.*** Infiltration rates are higher when the soil is dry than when it is wet. As the soil becomes wet, the infiltration rate decreases. If all soil pores are filled with water the

soil is said to be **saturated**. Water must move downward through the soil profile before more water can enter at the surface. When the surface soil is completely saturated, the infiltration rate will be quite low.

When the surface soil is temporarily saturated and more water is added through rainfall or wastewater irrigation, the water must go somewhere. It either ponds on the soil surface or moves downslope as runoff.

In most cases, the surface soil does not stay saturated for long periods. Water that isn't taken up by plants or lost through evaporation moves downward through the larger pores. This process is called **percolation**.

Table 3-3 shows the influence of texture, slope, vegetation, and surface conditions on infiltration rates. A dry sandy soil on a gentle slope with a good vegetative cover will have a much higher infiltration rate than a wet finely-textured surface soil on a sparsely covered steep slope.

Table 3-3. Influence of texture, slope, vegetation, and surface conditions on infiltration rates.

	Slope		
	0 to 3%	3% to 9%	>9%
	Inches per hour		
Sand	>1.00	>0.70	>0.50
Loamy sand	0.70 to 1.00	0.50 to 1.00	0.40 to 0.70
Sandy loam and fine sandy loam	0.50 to 1.00	0.40 to 0.70	0.30 to 0.50
Loam and silt loam	0.30 to 0.70	0.20 to 0.50	0.15 to 0.30
Sandy clay loam and silty clay Loam	0.20 to 0.40	0.15 to 0.25	0.10 to 0.15
Clay, sandy clay, and silty clay	0.10 to 0.20	0.10 to 0.15	<0.10

**For poor vegetative cover or surface soil conditions, actual rates may be as much as 50% less than shown.**

Source: Sprinkler Irrigation Association Journal

### *Percolation and Permeability*

**Percolation** is the movement of water *through* the soil once it infiltrates into the soil. **Permeability** is how *fast* (inches per hour) water moves through the soil. Permeability is largely determined by soil texture and structure. Sandy soils have very rapid permeability, and clayey soils have very slow permeability. But, as we have discussed, the rate that water moves through the soil also depends on soil structure. Good soil structure enhances permeability by providing stable aggregates that have large pores between them.

Soils that are well suited for wastewater irrigation have moderate or moderately slow permeability. If water moves through the soil too slowly, soil will become waterlogged and saturated. If water moves through the soil too rapidly, nutrients and contaminants can leach to groundwater before they are adequately treated.

## *Soil Depth and Restrictive Horizons*

**Soil depth** is the distance from the soil surface to bedrock or other restrictive horizons. A **restrictive horizon** is a layer in a soil profile that roots, water, and air cannot penetrate. In addition to bedrock, examples of restrictive horizons include:

- bedrock
- natural hardpans (soil cemented by iron, lime, gypsum, silica, etc.)
- densely compacted soil (traffic pan or plow pan)
- seasonal high water table (discussed later in this section)

Soil depth determines how much water can infiltrate and be held by the soil and how much space plant roots can occupy. Deep soils hold more plant nutrients and water than shallow soils and provide more treatment opportunities for contaminants.

Shallow soils limit the volume of soil available for treatment of contaminants and increase the risk of groundwater contamination. Areas where bedrock is close to the soil surface make particularly poor surface irrigation sites. Fractures or cracks in bedrock can act as direct conduits for contamination of groundwater. Shallow soils also limit the types of crops that can be grown and the yield of those crops.

For these reasons, surface irrigation permits do not allow wastewater irrigation where (or when) the vertical separation between bedrock or the seasonal high-water table and the soil surface is less than one foot.

## *Seasonal High Water Table*

A soil's seasonal high-water table (SHWT) is one of the restrictive horizons just mentioned. Before we define and discuss the seasonal high-water table, we need to define and discuss some other terms.

Some of the water that infiltrates into the soil is used by plants or evaporates. The remaining water percolates downward through the **unsaturated zone** (pores are filled with air and water). Eventually, it reaches the **saturated zone**, where all the pores in the soil or bedrock are filled with water. The surface or uppermost level of the saturated zone is called the **water table**. When water percolates through the soil and reaches the water table, it becomes groundwater. **Groundwater** is any water contained in interconnected pores located below the water table.

Water table depths are determined by the restrictive horizons below the soil surface. They may be very deep and cover a large area. A water table that results from such a restrictive horizon is called a **permanent or apparent water table** (Figure 3-8).

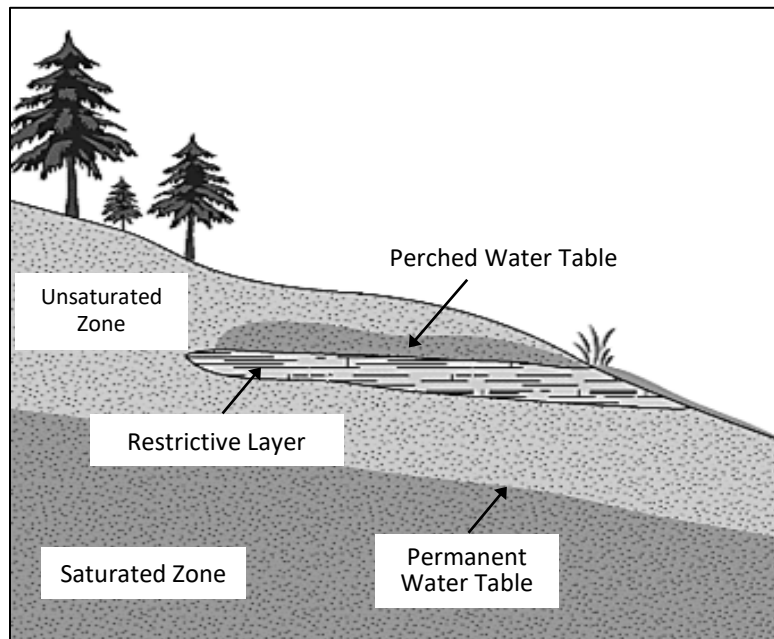

Figure 3-8. Perched and permanent water tables.

A water table may also be caused by a shallow restrictive horizon in the soil that creates saturated conditions above it, while unsaturated conditions exist below it. This type of water table is called a **perched water table**, and usually occurs over a small area. Perched water table depths are quite variable and are usually of shorter duration than a permanent water table.

The depth of the permanent water table varies from place to place, mainly due to changes in landscape position. At the top of slope, soils are usually (but not always) well-drained, with the water table at some depth. Soils at the bottom of a slope, where water accumulates, are often poorly drained, with the water table near or at the soil surface.

The depth of the water table at a particular location also varies over time, moving up and down in response to weather conditions (Figure 3-9). The fluctuation of the water table occurs seasonally, rising in rainy seasons and dropping during dry periods.

The **seasonal high water table (SHWT)** is the highest level to which the soil is saturated during the wettest season of the year. Surface irrigation permits require that there must be at least one foot between the SHWT and the soil surface. Seasonally wet soils may not be suitable for irrigation or permits may restrict irrigation to certain months of the year. These soils are problematic because they:

- impede treatment processes because anaerobic conditions exist
- pose a high risk of groundwater contamination

- limit the plants/crops that can be grown and limit their yields
- are prone to compaction by equipment traffic

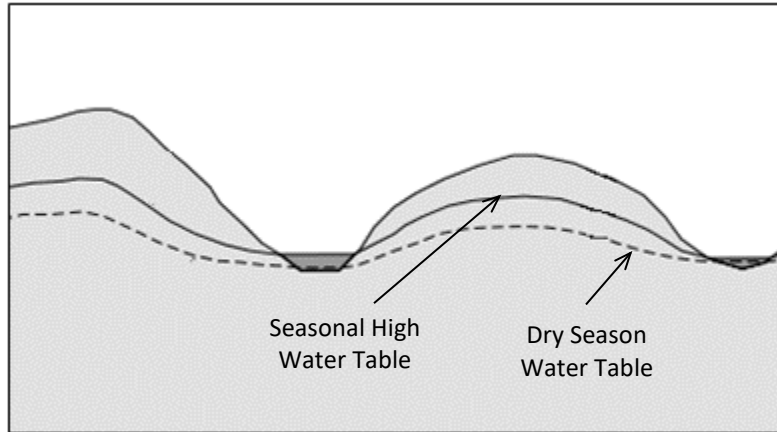

Figure 3-9. The water table changes from location to location and from wet to dry seasons.

## Topography

**Topography** refers to the shape or contour of the land surface. You can think of it as the “lay of the land”. The topography of a site influences the types of soils that are present, the depth of those soils, and the water movement characteristics of the site. The two components of topography are slope and landscape position.

- **Slope.** Slope is the vertical rise or fall over a given horizontal distance. The steeper the slope the less suitable the site. Low infiltration rates on steep slopes encourage runoff and soil erosion. The steeper the slope, the faster the runoff flow and the more soil particles it carries away. Soils on steep slopes are thinner, provide less treatment, and are less productive.

There is less potential for runoff and erosion on gently sloping or level fields. Soils are deeper and more developed, which makes maintaining a cover crop easier and fields are more accessible to equipment.

The shape of a slope is also important. Convex slopes curve outward like the outside of a baseball and shed water. Concave slopes curve inward like the inside surface of a saucer and accumulate water. Linear slopes follow a straight line down the slope (Figure 3-10).

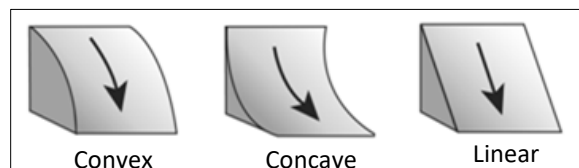



Figure 3-10. Slope shape.

- **Landscape Position.** The shape of a slope depends on its position on the landscape. Figure 3-11 shows the landscape positions that may be present at a surface irrigation site.

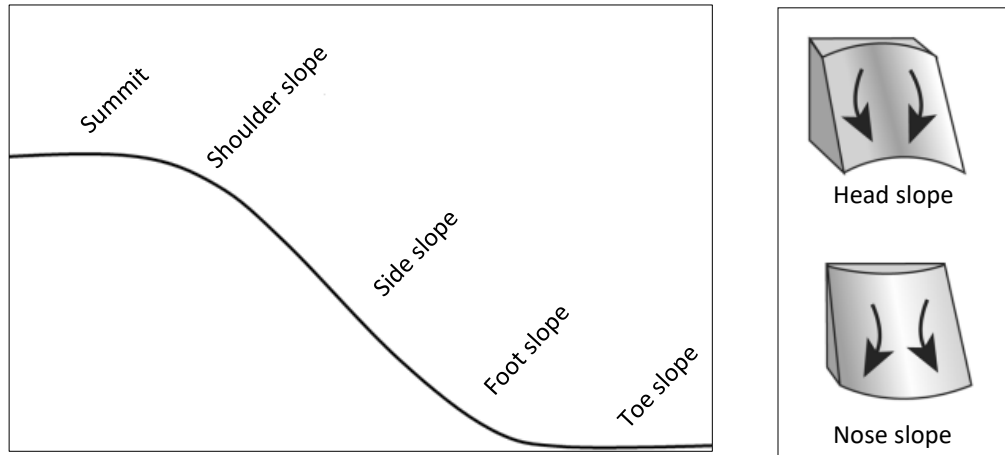

Figure 3-11. 1) Cross-sectional view of the different landscape positions. 2) Nose and head slopes.

- **Summit** – a broad, nearly level or gently sloping convex surface (also called ridgetop or upland). The highest point in each area.
- **Shoulder slope** – the convex upper portion of the slope.
- **Side slope** – the mid-portion of the slope.
- **Foot slope** – the gently sloping, slightly concave slope at the base of the side slope where the slope starts to flatten.
- **Toe slope** – the lowest part of the slope where it almost completely flattens.
- **Nose slope** – the projecting end of a hillside; a convex area that sheds water.
- **Head slope** – the concave surface at the head of a drainage way.

The summit, shoulder slope, and nose slope are the most suitable for surface irrigation. These positions shed water in a divergent manner, so that flow is not concentrated. This results in more infiltration and less runoff.

In foot slope and head slope positions, surface water converges. Since these positions accumulate water, they are often saturated, with the water table at or near the soil surface. Additional water will compound the problems in these areas. These areas may not be suitable for wastewater irrigation or may need reduced loading rates.

On a small scale, microtopography refers to minor variations across a landscape. A localized circumstance such as a rock outcropping or wet depressional area may require setbacks, but often are not large enough to rule out the usefulness of an entire site.

## ***Soil pH***

Soil pH is a measure of soil acidity or alkalinity. Remember, the pH scale runs from 0 to 14. Lower numbers indicate more acid soils and higher numbers indicate more alkaline or basic soils. Nearly all North Carolina soils are naturally acidic, which can reduce crop yields and microorganism activity.

Fortunately, soil pH can be increased relatively easily by adding lime. Liming materials are relatively inexpensive, comparatively mild to handle, and leave no objectionable residues in the soil.

There are two types of liming materials. Those containing only calcium carbonate ( $\text{CaCO}_3$ ), calcium hydroxide [ $\text{Ca}(\text{OH})_2$ ], or calcium oxide ( $\text{CaO}$ ) are called “***calcitic limes***.” The second type of liming material contains significant amounts of magnesium carbonate ( $\text{MgCO}_3$ ) and is called “***dolomitic lime***.” North Carolina law requires that dolomitic lime contain at least 6% magnesium in the carbonate form by weight. If a soil is low in magnesium, dolomitic lime should be used; otherwise calcitic lime can be used.

Managing soil pH is the single most important component of maintaining soil fertility and a healthy crop. We will discuss soil pH in more detail later in this chapter.

## ***Cation Exchange Capacity***

Clay and organic soil particles carry both negative and positive charges. In North Carolina, negative charge greatly exceeds positive charge, resulting in a net negative charge on these soil particles. The negatively charged sites the surfaces of soil particles attract and hold positively charged ions (***cations***) against the downward movement of water through the soil profile.

This process is called ***adsorption*** (not to be confused with *absorption*, which is the process by which ions are taken into plant roots). These adsorbed cations are also called exchangeable cations because they are replaced or exchanged with other cations in the soil solution (Figure 3-12). The total number of cations a soil is capable of holding is the soil’s ***cation-exchange capacity (CEC)***. The higher the CEC of a soil, the larger the supply of plant nutrient cations and the more fertile the soil is.

One might think that if the soil is holding, or binding the nutrients, that they are not available to plants. However, these attractions are weak, allowing an exchange between nutrients in the soil

water and nutrients on the surface of the soil particle. As nutrients are taken up by a plant, more leave the soil surface and enter soil water. Generally, there are many more nutrients attached to the soil than are in soil water.

Soils with more sand and less clay have lower CECs and cannot hold as many cations. Since sandy soils also have large pore spaces, leaching of negatively charged ions (**anions**) is greater than on a soil with more silt and clay.

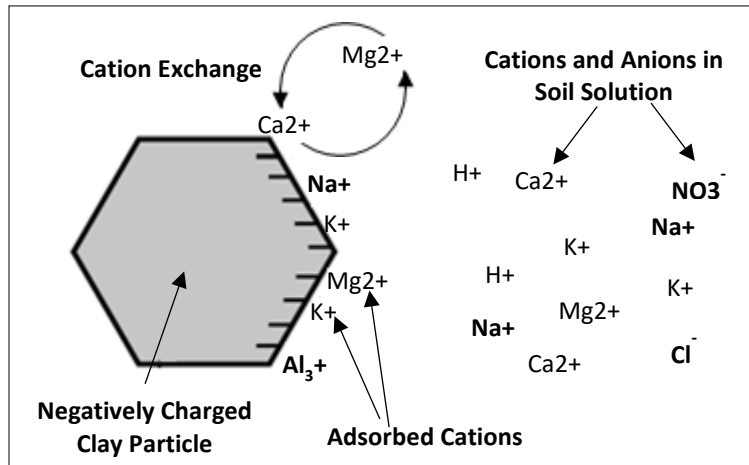

Figure 3-12. Simplified representation of cation exchange capacity.

## *Crops -- The Other Half of the Natural Treatment System*

Crops are a critical part of the natural treatment system. Surface irrigation permits require that a suitable year round vegetative cover be maintained at all times, such that crop health is optimized, allows for even distribution of effluent, and allows inspection of the irrigation system.

The important functions crops or vegetation perform include:

- removing water and nutrients from the soil
- preventing soil erosion and runoff
- maintaining and improving soil structure
- providing habitat for microorganisms

## Removing Water

The movement of water on, in, and above the earth's surface is called the hydrologic cycle. It is the continuous process of water leaving the earth's surface and eventually returning in the form of precipitation (Figure 3-12). Wastewater sprayed onto the soil surface acts in much the same way as natural precipitation and becomes a part of the hydrologic cycle.

We have already discussed that wastewater can infiltrate the soil or runoff to surface waters. It can also evaporate and return to the atmosphere. When the humidity is low, water may evaporate before it even reaches the ground. It also evaporates from soil and leaf surfaces.

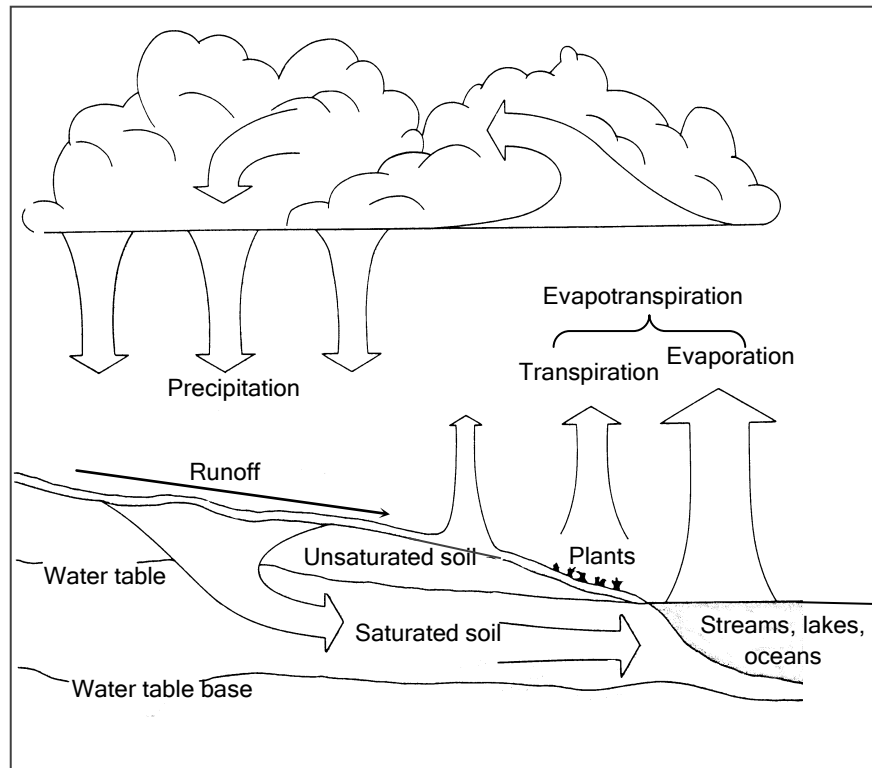

Figure 3-12. The hydrologic cycle.

More importantly for the purposes of surface irrigation, plants take up water through their roots and carry it to their leaves. There it changes to vapor and is released to the atmosphere in a process called **transpiration**. The combined loss of water to the atmosphere by evaporation from soil and leaf surfaces (E) and by transpiration (T) is called **evapotranspiration** (ET).

Evapotranspiration is responsible for most of the water removal from irrigation fields during a crop's growing season. Consequently, maintaining a healthy crop or vegetative cover is an essential component of a properly managed surface irrigation system.

## Nutrients

Plants need at least 16 essential nutrients to grow and complete their life cycle. Three of these nutrients (carbon, hydrogen, and oxygen) are non-mineral nutrients that are supplied by air or water. The other 13 are mineral nutrients that come from the soil or from amendments added to the soil (fertilizers, manure, or wastewater).

Nutrients that plants use in large amounts are called **macronutrients** (Table 3-4). Macronutrients can be broken into two more groups: primary and secondary. The **primary macronutrients** are nitrogen (N), phosphorus (P), and potassium (K). These nutrients usually are lacking from the soil first and are the ones most frequently supplied to plants by fertilizers.

Table 3-4. Essential plant nutrients.

Nutrient	Chemical Symbol	Macro/Micro
Nitrogen	N	Macronutrient (Primary)
Phosphorus	P	Macronutrient (Primary)
Potassium	K	Macronutrient (Primary)
Calcium	Ca	Macronutrient (Secondary)
Magnesium	Mg	Macronutrient (Secondary)
Sulfur	S	Macronutrient (Secondary)
Iron	Fe	Micronutrient
Manganese	Mn	Micronutrient
Boron	B	Micronutrient
Molybdenum	Mo	Micronutrient
Copper	Cu	Micronutrient
Zinc	Zn	Micronutrient
Chlorine	Cl	Micronutrient

The **secondary macronutrients** are calcium (Ca), magnesium (Mg), and sulfur (S). Plants also use large amounts of these nutrients, but they are more abundant in soils and don't need to be replenished as often.

The **micronutrients** are boron, copper, chlorine, iron, manganese, molybdenum, and zinc. Plants require very small amounts of these elements, but their role in plant growth is equally as important as the macronutrients. A deficiency in one or more micronutrients can result in severe reductions in growth, yield, and crop quality.

All essential nutrients must be available, continuously and in balanced proportions, to achieve desired crop growth and yield. If any one of these essential elements is missing, plant productivity will be limited, or the plant may cease to grow entirely.

Although the soil may contain large amounts of nutrients, only a very small percentage of these amounts may exist in chemical forms that are available to plants. Plants can only absorb nutrients when they are in the form of an ion in the soil solution. When they occur in organic form or as part of an insoluble compound, nutrients are not available to plants.

Figure 3-13 shows the relationship between plant growth and the concentration of essential nutrients in the soil solution. There are three soil nutrient levels:

1. **Deficiency:** marked increases in yield occur with increasing amounts, or availability, of the nutrient, i.e., supply of the nutrient is inadequate and is limiting yield. An addition of the nutrient will increase yield.
2. **Sufficiency:** the maximum economic yield has been reached and the nutrient is not limiting crop yield, so increasing the supply or availability of the nutrient has no effect on yield.
3. **Toxicity:** further additions or availability of a nutrient beyond the sufficiency range causes marked decreases in yield and eventually no growth.

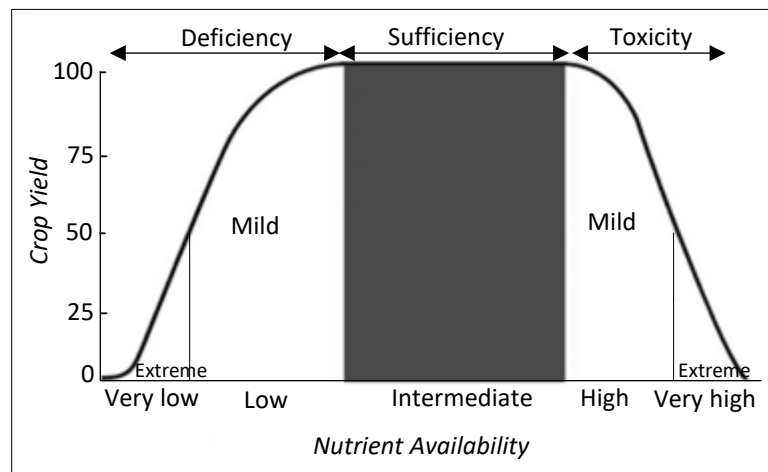

Figure 3-13. Concept of yield response to nutrient availability.

It is impossible to determine which nutrients are in short supply and which ones are adequate for the crop without soil testing. Soil test information is essential to making informed decisions on the nutrient needs of the crop. Plant tissue testing is usually not required by the permit but can be a useful tool for diagnosing problems.

### *Nutrient Availability and Soil pH*

Soil pH affects plant nutrient availability, metal immobilization, soil fertility, and soil microorganism activity.

- **Nutrient availability.** If soil pH becomes too acidic or too alkaline, key nutrients become insoluble and unavailable. Most nutrients are most soluble and therefore most available to plants at a pH of 6.0 to 6.5.

For example, when the pH is too low, primary and secondary macronutrients (nitrogen, phosphorus, potassium, calcium, magnesium, and sulfur) are tied up in the soil and are unavailable to plants (Figure 3-14). When the soil pH is too high, manganese becomes insoluble and deficiencies can result.

Low pH soils (pH <5.5) also *increase* solubility of aluminum (a non-nutrient mineral), manganese, and iron, making them more available to plants. However, aluminum and manganese are both toxic to plants. When a proper pH is maintained, they are insoluble, unavailable, and non-toxic.

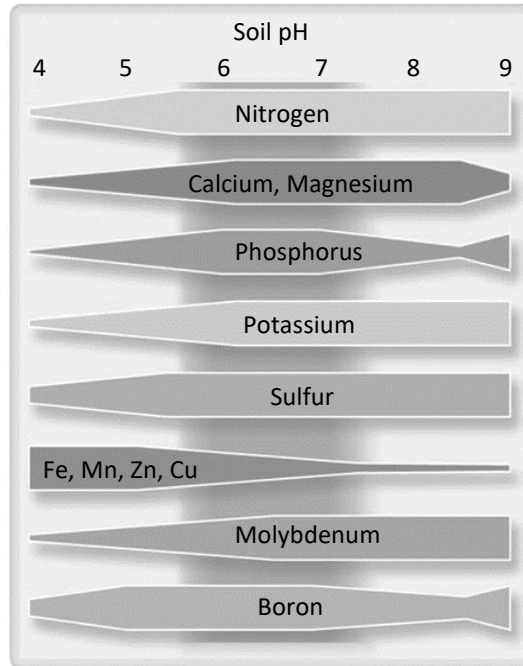

Figure 3-14. Influence of soil pH on nutrient availability.

- ***Metal immobilization.*** Low pH soils *increase* the solubility of most metals. Except for molybdenum, the lower the soil pH, the more soluble metals become and the more available they are for uptake by plants. To avoid high metal availability to plants, the soil pH should be maintained at 6.5 or above. This pH level promotes the formation of insoluble metal compounds that are immobile and unavailable to plants. Proper management of soil pH is extremely important in controlling the movement of metals in the soil.
- ***Soil microorganism activity.*** Low soil pH *decreases* the activity of the beneficial soil microorganisms that decompose organic matter and contaminants. They prefer a pH between 6.0 and 7.0 for best performance. Proper soil pH *increases* microorganism activity, which improves soil structure, drainage, and aeration. This in turn allows for better use of nutrients, increased root development, and drought tolerance.
- ***Soil fertility.*** In addition to influencing the availability of nutrients, soil pH can also influence the amount of nutrients in the soil. As pH increases, the number of negative

charges on clay particles and organic matter increase, thereby increasing CEC. The higher the CEC of a soil, the larger the supply of nutrient cations (Table 3-5).

Table 3-5. Summary of the effect of soil pH on the availability of nutrients, metals, etc.

Strongly Acid pH < 5.5	Slightly Acid to Neutral 6.0 – 7.0	Strongly Alkaline > 8.5
<ul style="list-style-type: none"> <li>• Calcium, magnesium, nitrogen, phosphorus, boron, and molybdenum are unavailable</li> <li>• Heavy metals (except for Molybdenum) become more soluble and available</li> <li>• Aluminum, iron, and manganese become more available and can be toxic to plants</li> <li>• Negative sites on soil particles and adsorbed cations decrease, decreasing overall fertility</li> <li>• Bacterial populations and activity decline</li> </ul>	<ul style="list-style-type: none"> <li>• Essential nutrients are more soluble and available, ideal for plant growth</li> <li>• Biological activity increases</li> <li>• Metals are insoluble and unavailable (pH &gt;6.5)</li> <li>• Negative sites on soil particles and adsorbed cations increase (CEC), increasing fertility</li> <li>• Al, Fe, and Mn are insoluble, unavailable, and non-toxic</li> </ul>	<ul style="list-style-type: none"> <li>• Phosphorus, iron, copper, zinc, boron, and manganese are unavailable</li> <li>• Molybdenum (a metal) becomes more available</li> <li>• Bacterial populations and activity decline</li> <li>• Mineralization slows down or stops</li> </ul>

### *Nutrients in Wastewater*

Domestic wastewater usually contains low concentrations of the major plant nutrients. This means that the amount of wastewater that can be applied annually to a given site is **hydraulically limited**, that is, limited by the amount of water the soil can handle (**the hydraulic loading rate**).

In such cases, it is likely that major plant nutrients such as nitrogen, phosphorus and potassium will have to be added as supplements to get expected crop yields (optimum crop growth). Insufficient nutrients may result in reduced crop yield and nutrient uptake efficiencies, thereby causing possible stress on the receiving crop. The addition of supplemental nutrients should be based on soil test recommendations and realistic crop yield expectations.

For some surface irrigation systems, however, the quantity of wastewater that can be applied is **nutrient limited**. This means that the amount of wastewater that can be applied is limited by the nutrient content of the wastewater rather than by the amount of water the soil can handle. For example, too much nitrogen can result in nitrate accumulation in crops, groundwater contamination, and potential surface water contamination.



Unlike commercial fertilizers that can be blended to match the exact nutrient requirements of a specific crop, wastewater is not a balanced fertilizer. The primary nutrients -- nitrogen, phosphorus, and potassium -- are not present in ratios that match crop needs.

Application rates must be based on a single targeted nutrient. This is called the **“limiting”** or **“priority”** nutrient. Nitrogen is currently the limiting or priority nutrient for surface irrigation systems in North Carolina. This means that wastewater application rates are based on supplying adequate nitrogen for crop needs.

There are several reasons why application rates are based on nitrogen:

1. Nitrogen is required by crops in greater amounts than any other nutrient; consequently, the crop requirements for most other nutrients are usually met when the agronomic nitrogen rate is applied.
2. Nitrogen is the nutrient most likely to be lost to surface and groundwater if applied at greater than agronomic rates.
3. Excess nitrogen can have negative effects on public health, surface and groundwater, and plant growth and crop quality.

If nutrient limited, wastewater must be applied at **agronomic rates**, which means that wastewater is applied at rates that meet but do not exceed the crop’s nitrogen needs. The agronomic rate must be based on the **realistic yield expectation (RYE)**, which is the estimated yield for a specific crop grown on a specific type of soil. When wastewater is applied at agronomic rates for the limiting nutrient, the remaining nutrients will either be over- or under-applied.

Soil test results are the basis for determining the **agronomic rate**, which is the rate that meets the nutrient needs of a crop but does not overload the soil with nutrients or other constituents that may eventually reach surface or groundwater, limit crop growth or yield, or adversely impact soil quality. In North Carolina, the agronomic rate must be based on **realistic yield expectation (RYE)**, which is the estimated yield for a specific plant or crop grown on a specific type of soil.

### ***Nitrogen in Wastewater***

To calculate application rates, you must be familiar with the different forms of nitrogen and their availability to plants. The nitrogen in wastewater exists in both **organic** and **inorganic** forms. Before irrigation, most of the nitrogen in wastewater is bound up with organic material in the form of proteins, amino acids, and other cellular material. Only a small amount is in inorganic form (Figure 3-15).

Plants can only use inorganic forms of nitrogen. Plants cannot use organic nitrogen until microorganisms convert it to inorganic forms during a process called **mineralization**. As microorganisms decompose (**mineralize**) the organic material, nitrogen becomes available for

plants to use. The result is a slow release fertilizer that makes nitrogen available throughout a crop's growing cycle.

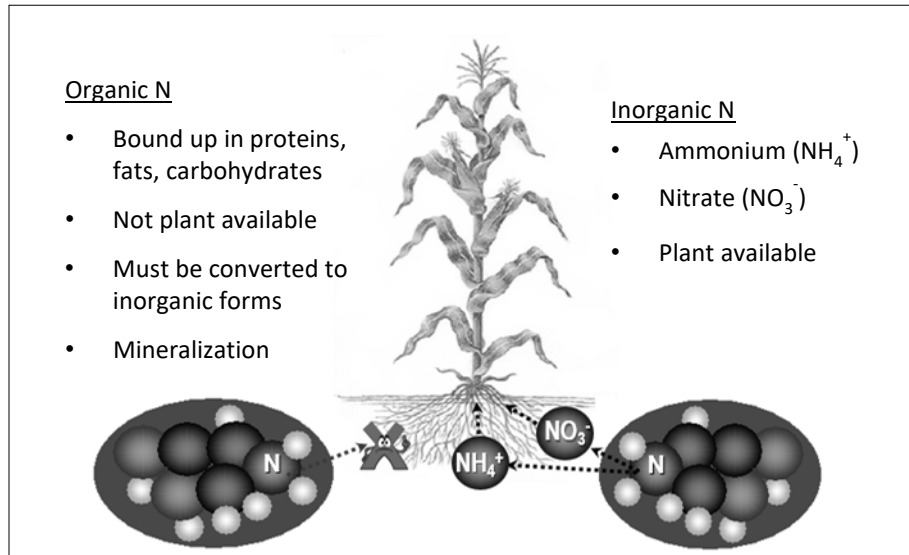

Figure 3-15. Forms of nitrogen in wastewater. At the time of application, 80-90% of N is in organic form. Only 10-20% is in inorganic forms.

During mineralization, microorganisms decompose organic nitrogen and release ammonium ( $\text{NH}_4^+$ ). Under aerobic conditions, ammonium is converted to nitrite ( $\text{NO}_2^-$ ) and then rapidly to nitrate ( $\text{NO}_3^-$ ) (Figure 3-16).

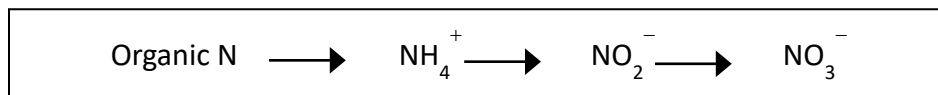

Figure 3-16. Mineralization: the conversion of organic N to inorganic forms of N by soil microorganisms.

Both  $\text{NH}_4^+$  and  $\text{NO}_3^-$  are inorganic forms of nitrogen that are readily available to plants. However, they behave very differently in the soil (Figure 3-17). Ammonium is a cation (has a positive charge) and binds to soil particles that have a net negative charge. It may also volatilize and escape to the atmosphere as ammonium gas ( $\text{NH}_3$ ). Nitrate is an anion (has a negative charge) and is repelled by negatively charged soil particles. Nitrate that is not taken up by plants has a high potential to leach (move downward) to groundwater.

For permits with nutrient limits, you will be required to:

1. Determine the Plant Available Nitrogen (PAN) needed by the crop, based on RYE (using NCSU website or other method listed in your permit)
2. Determine PAN provided by other sources (commercial fertilizers, manure);

3. Calculate the PAN needed from the wastewater (#1 - #2);
4. Calculate the PAN in the wastewater (from lab results); and
5. Calculate the amount of wastewater needed to supply #3. This is the Agronomic Loading Rate.

Calculations will be covered in Chapter 6.

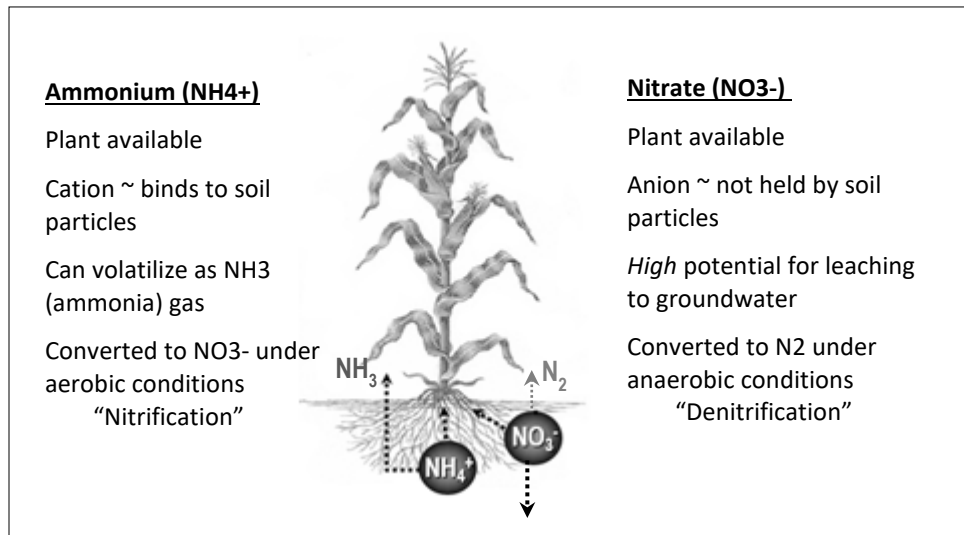

Figure 3-17. Properties of inorganic forms of N.

## *Summary of Soil/Crop Treatment Mechanisms*

We have discussed the two components of the land treatment system -- soil and crops -- and the roles they both play in the beneficial use of wastewater through surface irrigation. This section summarizes the mechanisms by which the soil and crops remove, transform, and recycle contaminants and nutrients. We have already discussed a number of these in earlier sections but bringing them together in one section should help you understand the concepts.

### Physical Treatment

- ***Sedimentation and filtration*** are primary removal mechanisms for large particles in the water entering the soil surface. These include total suspended solids (sediment), nutrients attached to soil particles.

Sedimentation occurs because water slows down, allowing suspended solids to settle out. As water passes through the vegetation and soil particles, some contaminants are filtered or retained and remain close to the soil surface where other treatment processes can occur.

- **Natural die-off** of pathogens occurs because they find conditions at the surface irrigation site a hostile environment. They cannot survive exposure to sunlight or warm, dry conditions. Even in moist soil, aerobic conditions lead to rapid die-off of **pathogens**. The chance for pathogens to move through the soil to groundwater increases only when wastewater is applied to soil that remains saturated and anaerobic for long periods of time.

## Biological Treatment

The land treatment system contains numerous living organisms such as fungi and bacteria that decompose or transform material placed on or in the soil. It is estimated that there may be as many as 8,000 pounds of microorganisms per acre in the first six inches of soil. Microorganisms transform or destroy nutrients and contaminants through the following biological processes:

- **Decomposition** is the breakdown of complex organic molecules into simpler organic and inorganic molecules by soil organisms.
- **Mineralization** is a form of decomposition in which organic substances are converted to inorganic substances by soil microorganisms.
- **Immobilization** is the conversion of inorganic compounds into organic compounds (the reverse of mineralization). Inorganic nutrients are taken up by plants or consumed by microorganisms and are converted into organic tissue. Nitrogen is then bound up in the plants or the bodies of the microorganisms and is no longer available to plants or other microorganisms.
- **Elimination and predation** is when a microorganism kills another microorganism. Some are killed by antibiotics naturally produced by fungi. Others are killed by other organisms and eaten.
- **Denitrification** is the transformation of the nitrate and nitrite forms of **nitrogen** to gaseous nitrogen, which can escape to the atmosphere. This process only occurs under anaerobic conditions. This process is not harmful to human health or the environment.

## Chemical Treatment

The soil/plant system also acts as a chemical filter. Finely-textured soils with a pH around 6.5 provide the most effective chemical treatment. The following chemical processes can alter nutrients and contaminants such as inorganic chemicals, persistent organic compounds, and pathogens.

- **Adsorption** is the process by which negative charges on the surfaces of clay particles and organic matter attract and hold positively charged particles, removing them temporarily from soil solution.
- **Cation exchange** is the adsorption and exchange of cations to negatively charged sites on soil particles and soil organic materials. Cation-exchange capacity (CEC) is the measure of a soil's potential to exchange cations and is related to pH and to clay and organic matter content.
- **Precipitation** is a reaction in which an insoluble solid is formed from two or more soluble ions or compounds. Precipitation reactions in soils reduce the toxicity and mobility of metals and other harmful trace elements that may be present in the soil system.
- **Volatilization** is the chemical transformation of a substance from a liquid or solid to a gas. Ammonia volatilization is the conversion of dissolved ammonia to ammonia gas. Ammonia gas can be lost from the soil and released to the atmosphere.

## Other Mechanisms

We have also discussed several other mechanisms by which nutrients and contaminants are removed or lost from the soil in ways that negatively impact public health and the environment.

- **Runoff** is water from precipitation or from wastewater that flows over the surface of the soil toward a stream, lake, or other surface water body without infiltrating the soil. Runoff can transport nutrients (especially nitrogen and phosphorus), pathogens, and synthetic organic chemicals that may impact plant and animal life in surface waters, as well as humans who use the surface waters for drinking water and recreation.

**Eutrophication** is when a body of water becomes overly enriched with minerals and nutrients carried by runoff which induce excessive growth of plants and algae. This process can result in oxygen depletion of the water body, fish kills, and offensive odors.

- **Erosion** is the transport of a field's topsoil from one place to another, either by runoff or by wind. The potential for soil erosion increases if the soil has no or very little vegetative cover and/or crop residues. Tillage and cropping practices that reduce soil organic matter or result in soil compaction also contribute to soil erodibility. Surface crusting and subsurface compaction decrease infiltration and increase runoff.

Most eroded soil carried in runoff ends up in surface waters, clogging streams, filling lakes, and reducing storage in reservoirs. Sediment transported by runoff also causes turbidity, which is the cloudiness or haziness of water caused by large numbers of individual particles. High turbidity levels can smother aquatic life and shade out desirable

aquatic vegetation. Soil erosion causes on-site problems as well. The removal of topsoil can result in poor crop growth and reduced yields.

- **Leaching** is the downward movement of a dissolved substance through the soil. As water percolates through the soil, it can carry these substances downward to the water table and into groundwater, making it unfit for drinking.

Your goal as an operator is to manage your site(s) to avoid runoff, erosion, and leaching to maintain the treatment capacity of the soil/plant system.

Table 3-6. Summary of possible fates of the constituents in wastewater.

Nutrient or Contaminant	Possible Fates
Nitrogen	<ul style="list-style-type: none"> <li>• Mineralized</li> <li>• Immobilized</li> <li>• Uptake by plants</li> <li>• Adsorbed</li> <li>• Lost as a gas</li> <li>• Volatilization</li> <li>• Denitrification</li> <li>• Carried by runoff</li> <li>• Carried by erosion</li> <li>• Leached</li> </ul>
Phosphorus	<ul style="list-style-type: none"> <li>• Mineralized</li> <li>• Immobilized</li> <li>• Uptake by plants</li> <li>• Adsorbed</li> <li>• Precipitated</li> <li>• Carried by runoff</li> <li>• Carried by erosion</li> </ul>
Metals	<ul style="list-style-type: none"> <li>• Adsorbed</li> <li>• Precipitated</li> <li>• Uptake by plants</li> <li>• Carried by runoff</li> <li>• Carried by erosion</li> <li>• Leached</li> </ul>
Pathogens	<ul style="list-style-type: none"> <li>• Natural die-off due to hostile conditions</li> <li>• Eliminated or consumed</li> <li>• Adsorbed</li> </ul>
Synthetic Organic Chemicals	<ul style="list-style-type: none"> <li>• Eliminated</li> <li>• Uptake by plants</li> <li>• Adsorbed</li> <li>• Volatilized</li> <li>• Broken down by ultraviolet light</li> <li>• Carried by runoff</li> <li>• Carried by erosion</li> <li>• Leached</li> </ul>

## Chapter 4

### Surface Irrigation Equipment

So far, we have discussed the basic characteristics of wastewater as well as the treatment components of a spray irrigation system. In this chapter, we will look at the equipment that is used to pump and distribute wastewater through the system. In most cases, operators will be operating and maintaining equipment and systems that were chosen and designed by someone else. If the equipment was properly chosen and the system properly designed, operating the system will be much easier.

A "good design" does not guarantee that wastewater will be properly applied. Poor operation can ruin the performance of a well-designed system; likewise, a poorly designed system can sometimes provide good performance with proper, intensive operation. Therefore, operators of spray irrigation systems need a basic understanding of pumps and their controls as well as an understanding of distribution networks and their devices.

#### *4.1 Pumps and Controls*

A pump is a mechanical device that imparts energy to liquids in order to move the liquids from one location to another. All pumps operate on the following principals:

- air is exhausted from the working chamber
- atmospheric pressure then forces water or other liquid into the chamber
- the pump mechanism forces the water out of the chamber, creating a partial vacuum
- additional water fills the chamber to repeat this cycle

#### *General Concepts*

Before discussing specific types of pumps, it is important to understand the following general concepts:

- pump head
- horsepower
- pump capacity
- pump performance curves

#### *Head*

Pumps are designed to deliver liquid against a specific pressure. We know that water has a specific weight of 8.34 lbs/gallon. This weight resting on a surface exerts a force on that surface. Force (or

weight) on a specific area is called pressure. Pressure is usually expressed in terms of pounds per square inch (PSI).

Pressure can also be expressed in terms of feet of water. When pressure is measured in feet, it is called head. Pump head is defined as the resistance against which a pump will operate. A water column 100 feet high will exert a pressure of approximately 44 pounds per square inch. Conversely, 1 pound per square inch of pressure is equivalent to 2.31 feet of head.

To convert pressure to head, multiply the pressure in psi by 2.31. To convert head to pressure, divide the head in feet by 2.31.

In most cases, pumps must be installed to provide the pressure necessary to move water from one location or elevation to another in a waste treatment system. Since the function of a pump is to add pressure to the system, the pressure on the discharge side of the pump will always be higher than the pressure on the suction side of the pump.

In pump systems, measurements are taken from the point of reference to the centerline of the pump, a horizontal line drawn through the center of the pump (Figure 4-1). Pump heads include both static head (when the pump is off) and dynamic heads (when the pump is on). Dynamic heads are discussed below.

### *Friction Head*

Friction head is the pressure needed to overcome the resistance to flow within the pump components. All straight pipe, fittings, valves, etc. have a friction factor that must be considered. These friction factors are converted to, and expressed as, equivalent feet of straight pipe, which can then be translated to friction head based on the flow and pipe size. The greater the flow, the higher the friction.

### *Dynamic Suction Head*

Suction head exists when the source of supply is above the centerline of the pump. Dynamic suction head (DSH) is defined as the vertical distance between the water level on the suction side and the centerline of the pump, minus friction head.

### *Dynamic Suction Lift*

Suction lift exists when the source of supply is below the centerline of the pump. Dynamic suction lift (DSL) is the vertical distance between the pump centerline and the water level on the discharge side, plus friction head. It will register as negative pressure on a gage on the suction side of the pump.



### *Dynamic Discharge Head*

Discharge head is the pressure at the discharge from an orifice or sprinkler. When liquid is discharged through an orifice or sprinkler nozzle, pressure head is converted to a velocity and this velocity is the force that gives water its trajectory. Dynamic discharge head (DDH) is defined as the vertical distance between the pump centerline and the water level at the point of free discharge, plus friction head.

### *Total Dynamic Head*

When the source of supply is below the centerline of the pump (Figure 4.1.a), the total dynamic head (TDH) of a pump system is defined the dynamic discharge head plus the dynamic suction lift. When the source of supply is above the centerline of the pump (Figure 4.1.b), the TDH of a pump system is defined as the difference between the dynamic discharge head and the dynamic suction head. Remember that friction head must be considered on both sides of the pump.

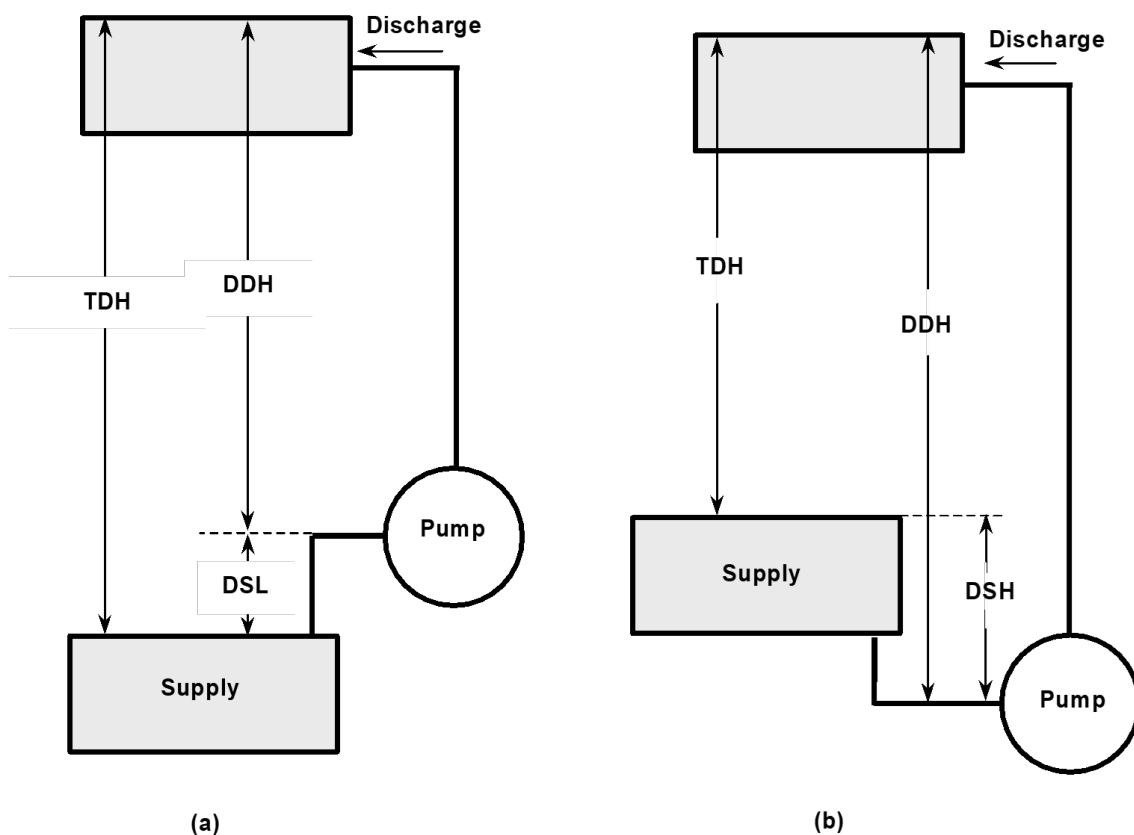

Figure 4-1. (a) Schematic of a system where the source of supply is below the centerline of the pump. (b) Schematic of a system where the source of supply is above the centerline of the pump.

## Horsepower

To purchase the appropriate pump for the job needed, you must determine how much work the pump will be required to do. In this context, work is the energy it takes to lift a weight a certain vertical distance. Work is expressed in units of foot pound. One foot-pound is the amount of work required to lift a one-pound object one foot off the ground.

Power is the rate at which work is being done – in other words, how fast the work is being done. Power is expressed as foot pound per second or foot pound per minute. Large units of power are called horsepower. One horsepower is 550 foot-pounds per second.

Water, brake, and motor horsepower are terms used to indicate where the horsepower is measured (Figure 4-2).

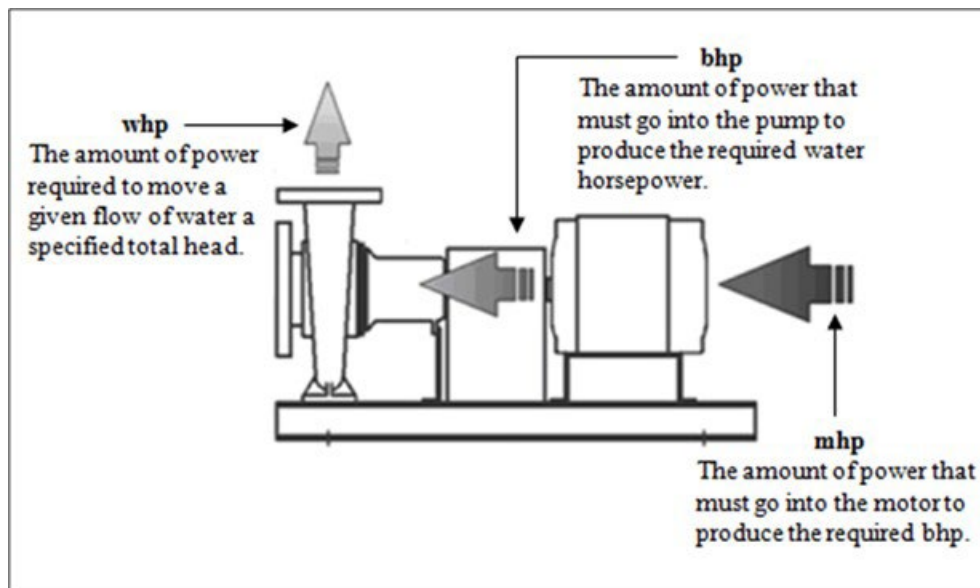

Figure 4-2. Water, brake, and motor horsepower.

The horsepower required to lift a specific flow of water a specific vertical distance is called water horsepower (whp). It is the minimum power required to move water. In other words, it is the power a pump would require if the pump was 100% efficient. Water horsepower is calculated by the following equation:

$$\text{whp} = \frac{\text{flow (gpm)} \times \text{TDH (ft)}}{3960}$$

Pumps, however, are never 100% efficient. Power is lost in the pumping process due to friction and heat, which reduces the pump's efficiency. We must correct for the pump's inefficiency by increasing the amount of horsepower that goes to the pump. Brake horsepower is the amount of power that must go into the pump to produce the required water horsepower. It is calculated by the following equation:

$$\text{bhp} = \frac{\text{water horsepower}}{\text{pump efficiency}}$$

Finally, we need to correct for the inefficiency of the motor that drives the pump. The motor also loses power due to friction and heat. We must correct for the motor's inefficiency by increasing the amount of energy that goes to the motor. The amount of electrical energy that must go into the motor to produce the required bhp is called motor horsepower (mhp). It is calculated by the following equation:

$$\text{mhp} = \frac{\text{brake horsepower}}{\text{motor efficiency}}$$

For example, a pump that is 80% efficient requires 10 bhp to generate 8 whp. If the motor is also only 80% efficient, the motor requires 12.5 horsepower to generate 10 bhp.

The equations for water, brake, and motor horsepower can be combined into one equation that accounts for pump and motor inefficiency:

$$\text{horsepower} = \frac{\text{flow (gpm)} \times \text{TDH (ft)}}{3960 \times \text{pump efficiency (\%)} \times \text{motor efficiency (\%)}}$$

### *Pump Capacity and Pump Delivery Rates*

Each pump is designed to deliver a designated amount of flow against a specific head. This is the design pump capacity or design pump delivery rate (gpm). Actual pump capacity or delivery rates can vary, depending on the efficiency of a pump and the conditions under which it is operated.

The pump capacity and quantity of flow, in turn, determine the time required for each pumping or dosing cycle and the length of time between cycles. The amount of wastewater pumped to a sand filter or spray irrigation field during a pump cycle is called the **dosing volume** (in gallons).

The **pump delivery rate** is the amount of wastewater pumped during a pump cycle divided by the pump run time (in minutes). The pump delivery rate efficiency is the measured pump delivery rate (in gallons per minute) divided by the design pump delivery rate times 100%. These calculations will be discussed in Chapter 6.

### *Pump Performance*

Pumps can deliver a wide range of flows depending on design, speed, and total dynamic head. The best source of information on a particular pump is the manufacturer's pump performance curve, which provides information on discharge, power requirements, and head characteristics.

Pump performance is measured in gallons per minute delivered (pump capacity), height to which water is lifted (head), and efficiency. Each pump is manufactured to operate most efficiently at a designated amount of head and flow. Operating a pump as close to peak efficiency as possible allows it to operate with the least amount of strain possible. Operating a pump well off peak efficiency can result in excessive energy use and shortened pump life.

To better understand the performance and operating characteristics of pumps, operators should become familiar with the pump curve that is supplied by the manufacturer for each pump. A pump curve shows the relationships between pump head, flow, efficiency, and horsepower. Pump curves can be used in case you need to modify your operating conditions from the original irrigation design. A typical pump curve is shown in Figure 4-3.

Pump curves usually show three curves on one sheet. The head-capacity curve shows the discharge in gallons per minute (gpm) which the pump will deliver against various heads when operated at the proper speed. This curve shows that as the head increases the discharge decreases, until there is no further discharge. Conversely, as head decreases, flow increases.

The second curve, also plotted against flow, shows the efficiency at which the pump operates at various points on the head capacity curve. This curve shows that no pump is 100% efficient, due to internal friction losses. The highest efficiency is around 85%. Efficiency can be expected to decrease with age and wear.

The third curve, the brake horsepower curve, shows power consumed plotted against flow. If we know the total head at which the pump is operating, we can use the curve to find the gallons pumped. The power required by the pump as well as the pump efficiency can also be read from the curve for any set of conditions.

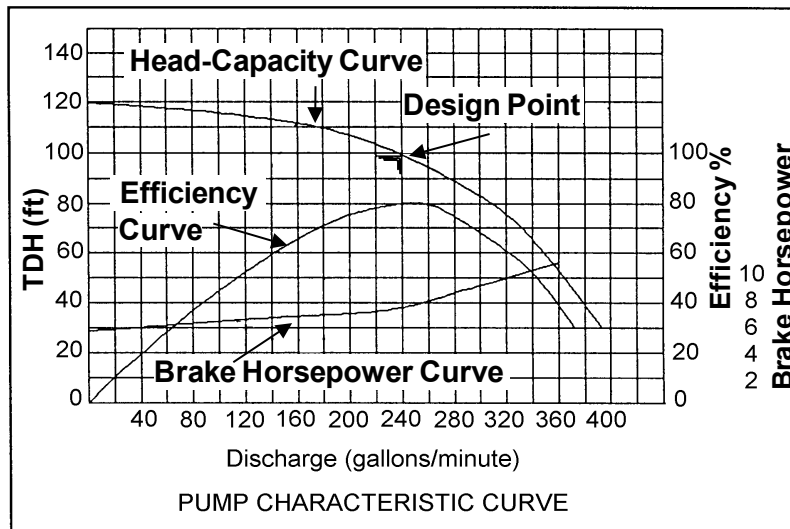

Figure 4-3. Characteristic curve [modified from Practical Hydraulics Handbook, 1991]

This curve shows that it usually takes more horsepower to pump more water: the lower the flow, the lower the horsepower required and the higher the flow, the higher the horsepower required.

As discussed earlier, a pump operates most efficiently at the flow and head it was designed and rated for. This is sometimes called the design point or best efficiency point. This point normally falls in the middle of the pump performance curve. Operation at either extreme of the curve should be avoided.

Operating a pump below the manufacturer's specified minimum head (at the high flow end of the curve) can result in overloading the motor. Operating a pump in the extreme high head region of the curve can result in decreased efficiency, increased noise and vibration, and low flows.

## Types of Pumps

There are a variety of pumps that you may encounter at your waste treatment facility. Centrifugal pumps are volute pumps that can be used for most wastewater pumping activities. Turbine pumps are generally used for applications where the intake is below the liquid levels. Positive displacement pumps are usually associated with waste that contains high levels of solids. Peristaltic pumps are used for wastewater sampling or chemical feed.

Pumping system components include the pump itself, electrical connections to a motor, a shaft to drive the pump, a seal between the water chamber and the motor, an impeller with inlet and outlet ports, and a mounting stand. Rail systems are recommended when using large submersible pumps to access pumps for repair or replacement.

### *Centrifugal Pumps*

A centrifugal pump is one of the simplest of mechanical pumps. It consists of one or more impellers rotating in a casing, or volute (Figure 4-4a). The impeller, shaped to force water outward at right angles to its axis, is mounted on a shaft that is supported by bearings and connected to a drive (Figure 4-4b).

The drives are usually electric, or sometimes engine-driven. The driving source may be either constant speed or variable speed, depending on the specific requirements of a particular installation.

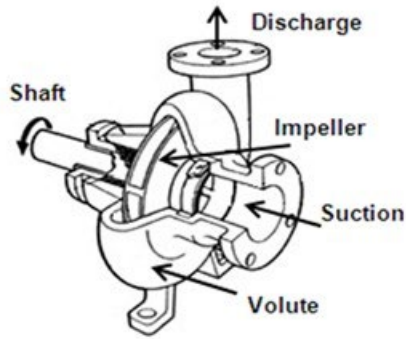

Figure 4-4(a)

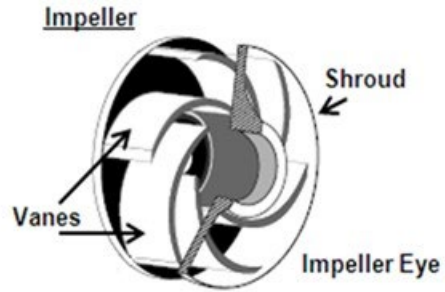

Figure 4.4(b )

A centrifugal pump is a radial flow pump. As wastewater enters the center (eye) of the impeller, it is picked up by the vanes and by the rotation of the impeller and is thrown out by centrifugal force into the discharge. More wastewater moves into the impeller through the eye, as wastewater in the impeller moves outward (Figure 4-5).

Impellers may be of the open, semi-open, or closed type. Open impellers do not have a front or back shroud and are normally used for wastewater applications while closed impellers are normally used for irrigation waters that are relatively clean (Figure 4-6). Semi-open impellers are designed to handle liquid containing moderate amounts of solids.

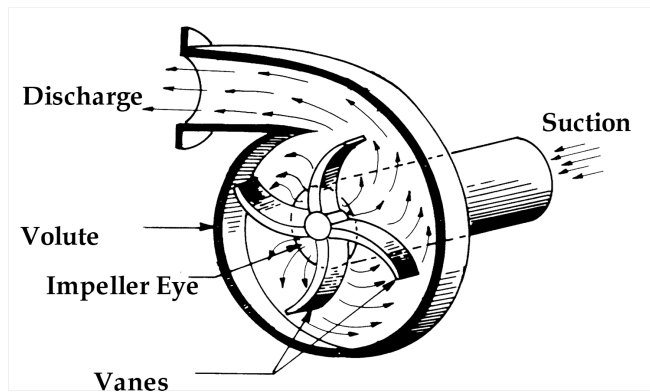

Figure 4-5. Centrifugal pump.

Centrifugal pumps generally have a maximum suction of 34 feet. The practical suction is generally 20 feet or less. These pumps are primed by evacuating air from the pump casing and then forcing water into the casing. With straight centrifugal pumps this is done manually. To accomplish this, a valve must be closed on the discharge side of the pump, either manually or automatically. Suction lines must be air-tight.

Generally, most pump problems arise on the suction side of the pump when lines are not completely air-tight.

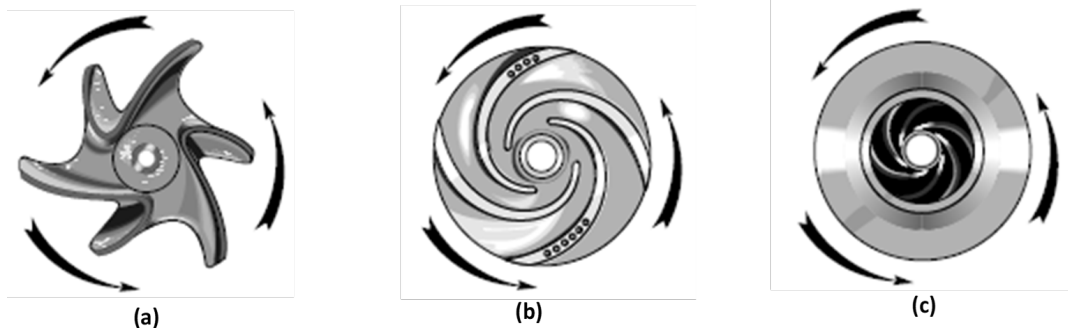

Figure 4-6. Impellers: (a) open; (b) semi-open; (c) closed.

A modification of the centrifugal pump is the self-priming centrifugal pump, which is characterized by a large casing. This type of pump has an end suction, and a top discharge and priming is accomplished by the pump mechanism itself. The maximum head that can be obtained with a self-priming centrifugal pump is generally less than that which can be obtained with a straight centrifugal pump. (Priming a pump will be discussed in more detail later in this section.)

### *Turbine Pumps*

Turbine pumps are basically centrifugal pumps that are stacked on top of each other. These pumps have a bowl design instead of a volute design for impeller housing. Therefore, these pumps can be constructed with small diameters, like those used in water-supply wells (Figure 4-7). Turbine pumps are readily adaptable because additional bowls and impellers can be attached to the turbine shaft.

Pumps with more than one impeller are called multi-stage pumps. Turbine pumps may have up to 25 stages, depending on the type of impellers used. Each stage adds pressure, not volume. They are generally used for deep well irrigation systems or other applications where the intake is below the liquid level and where high discharge pressures are needed.

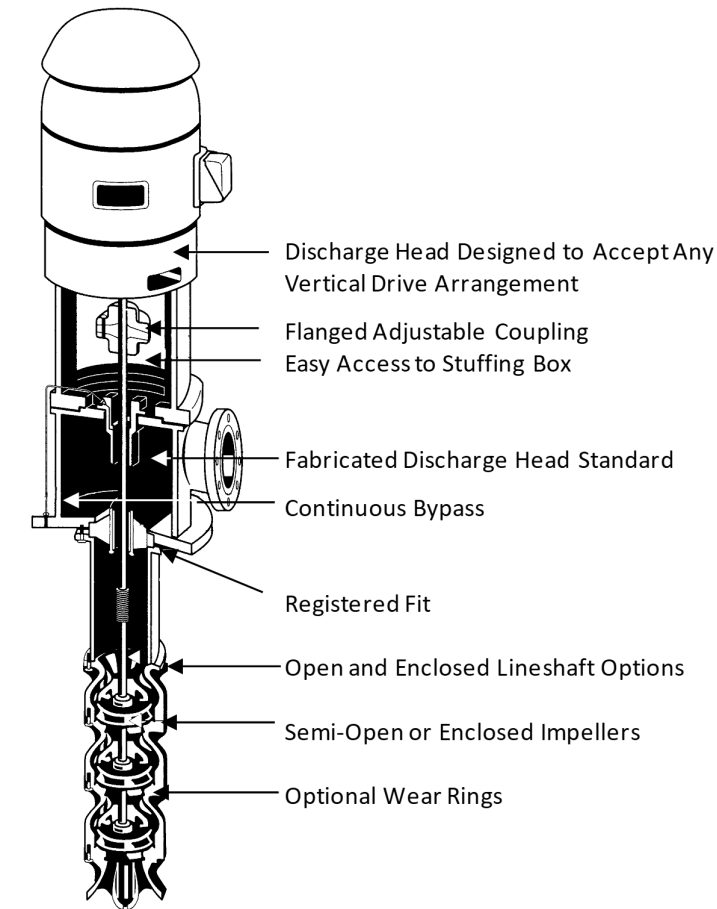

Figure 4-7. Turbine pump.

### *Submersible Pumps*

Another type of centrifugal pump is the submersible pump. Submersible pumps are vertical, heavy-duty centrifugal pumps designed to work while immersed in the water that they are pumping (Figure 4-8). There is no suction piping, and the impeller is at the very bottom of the unit. The watertight motor is also submerged. The surrounding water helps cool the pump and motor, extending their life and efficiency.

To assure proper cooling, the manufacturer normally specifies recommended minimum submergence for continuous operation. If this minimum submergence is not maintained, the motor and pump can overheat. Cavitation, vortexing, and siphoning can also result.

Cavitation, the formation and collapse of vapor bubbles, can cause severe mechanical damage as well as loss of head, reduction in pump efficiency, and noise.

Vortexing, the creation of a vortex that can reach the surface and pull air into the pump, can result in cavitation and reduced performance. Siphoning "assists" fluid flow, resulting in the reduction



of the head against which the pump must operate and possible overloading of the pump.

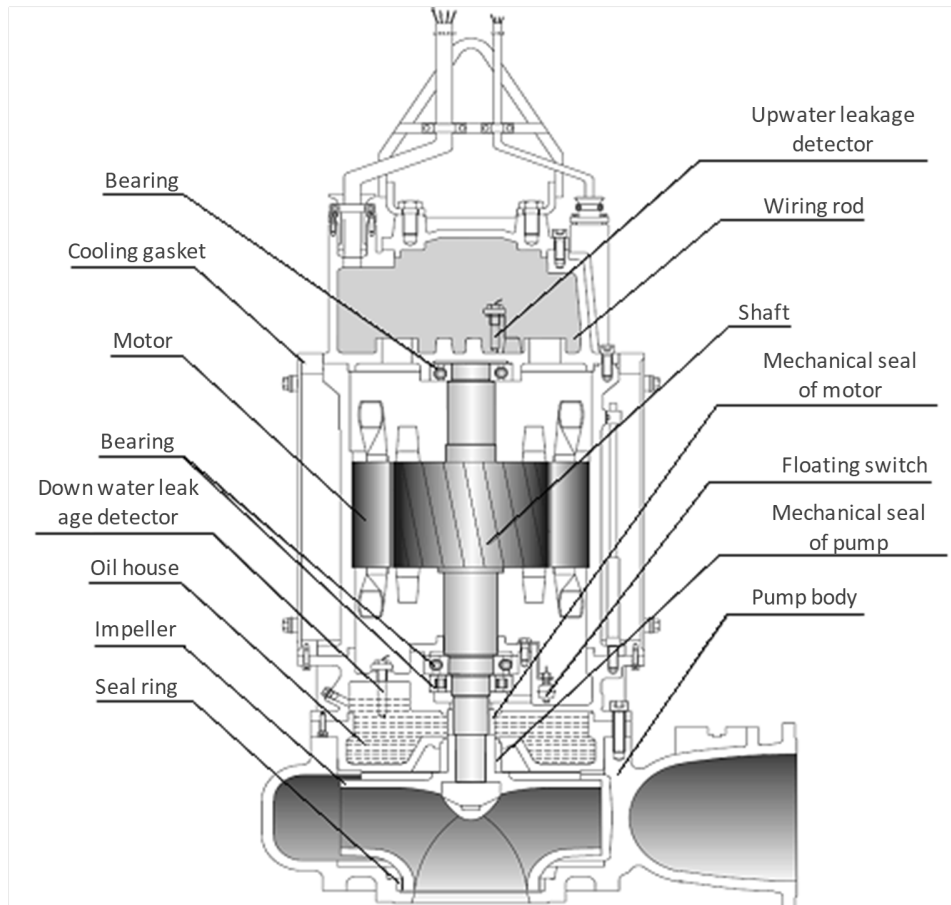

Figure 4-8. Submersible pump.

### *Reciprocating, Piston, or Plunger Pumps*

Positive displacement pumps are pumps that must be operated with an open discharge valve. One such pump is the reciprocating pump. The word “reciprocating” means moving back and forth, so a reciprocating pump (also called a piston or plunger pump) is one that moves wastewater or sludge by a piston or plunger that moves back and forth. The movement of the piston or plunger forces wastewater from the suction side to the discharge side of the pump.

There is a check valve (often simply a ball) on both the suction and the discharge sides of the pump. The check valves keep the liquid moving in the desired direction (Figure 4-9).

The piston or plunger moves up and down or back and forth horizontally in the cylinder. As the piston or plunger moves in one direction, a check valve opens, and wastewater enters the pump and fills the casing. This is referred to as the ‘suction cycle’ of the pump. When the piston or plunger moves in the opposite direction, the first check valve closes, the other check valve opens,

and wastewater is forced out of the exit line. This is the 'discharge cycle' of the pump.

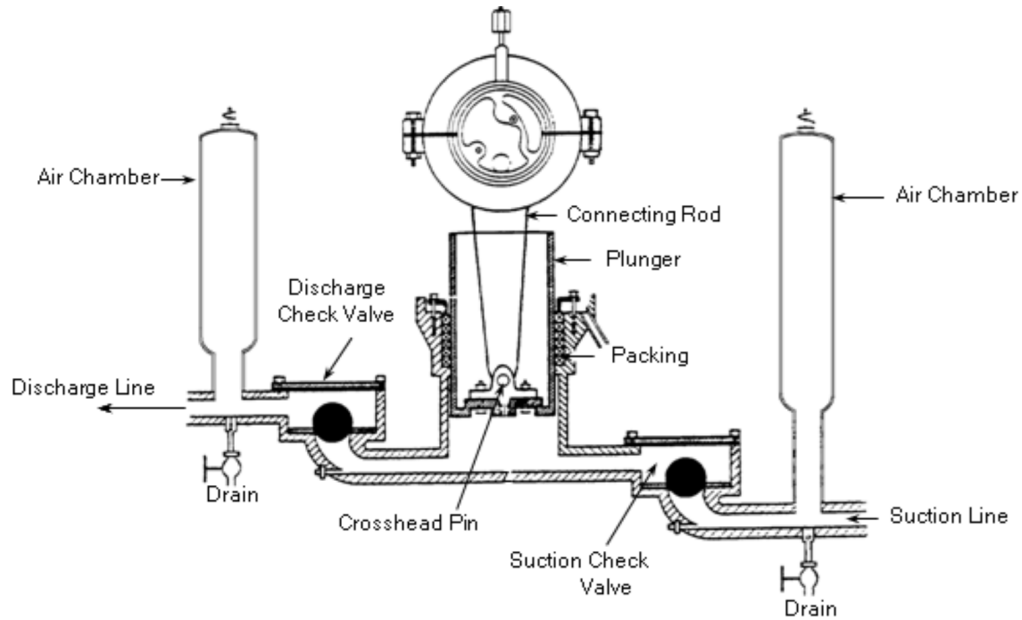

Figure 4-9. Major components of a plunger pump. [From WEF Pumps Operation and Maintenance]

Because the movement of the plunger or piston creates pressure inside the pump, this kind of pump should never be operated against any closed discharge valve.

To prevent a build-up of pressure that could damage the pump or burst pipes, all discharge valves must be open before the pump is started. Because force is exerted during the suction cycle also, the suction valve too should be always left at least partly open.

### *Diaphragm Pumps*

Another type of positive displacement pump is the diaphragm pump, often used for chemical feed. Instead of using a piston or a plunger, a diaphragm (a flexible membrane) is used to force wastewater from the suction to the discharge side of the pump (Figure 4-10). In a diaphragm pump, wastewater does not come in contact with moving metal parts, an advantage over the reciprocating pump. This can be important when pumping abrasive or corrosive liquids.

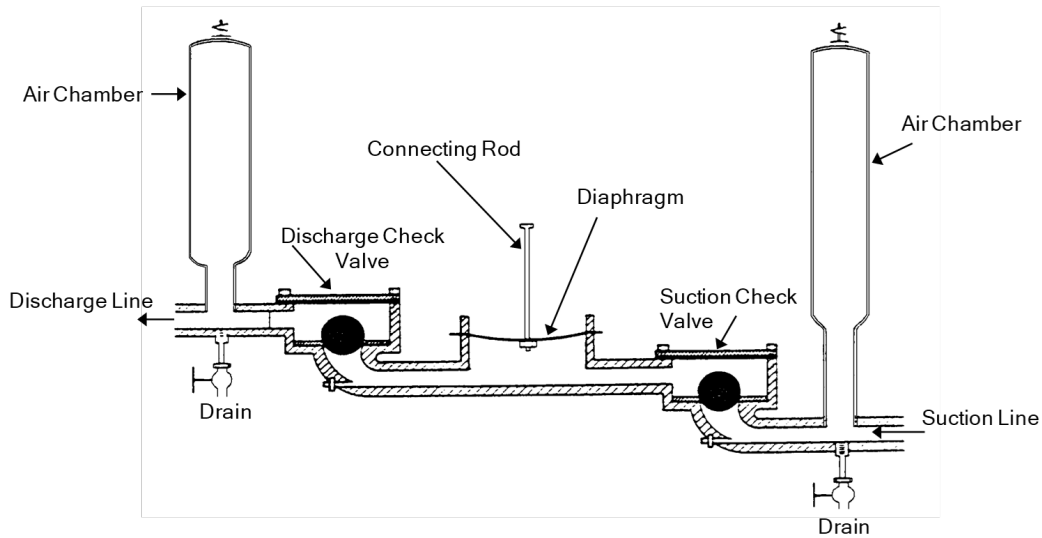

Figure 4-10. Major components of a diaphragm pump. [From WEF Pumps Operation and Maintenance]

### *Progressive Cavity Pumps*

Another type of positive displacement pump, a progressive cavity pump uses a rotor and an elastic stator to force liquid from the suction to the discharge side of the pump. Its operation is like that of a precision incline screw pump. The screw-shaped rotor fits snugly in a non-moving stator or housing (Figure 4-11). The gaps between the rotor threads are called cavities. Wastewater is pumped through an inlet valve where it enters a cavity. As the rotor turns, the waste material is moved along until it leaves the rotor at the discharge end of the pump.

These pumps should never be operated without liquid in the cavities, nor should they be run against a closed discharge valve.

Progressing cavity pumps are used to pump materials with very high solids content. Smaller progressing cavity pumps are normally used to pump chemical slurries. Larger ones are used to pump sludge.

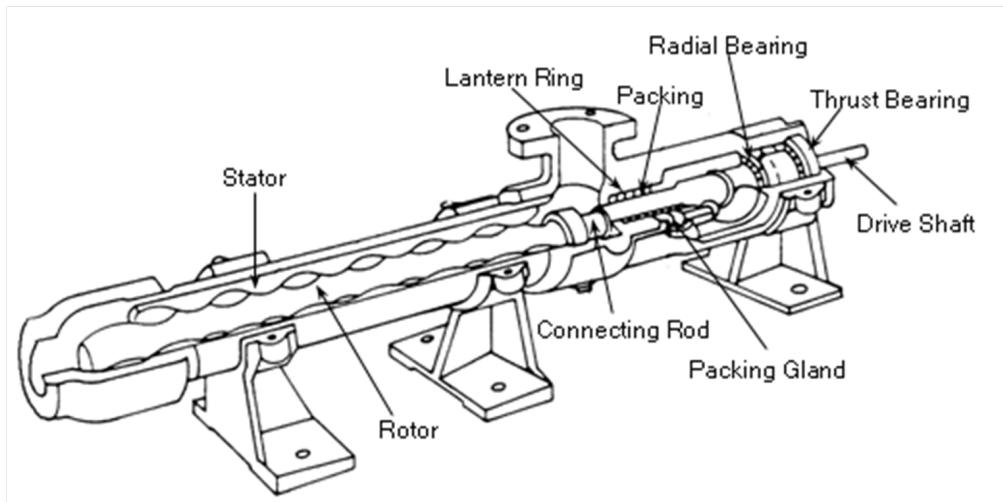

Figure 4-11. A typical progressive cavity pump.

### *Peristaltic Pumps*

Peristaltic pumps, the oldest pumps in existence, are another type of positive displacement pump. Wastewater is moved through flexible tubing by advancing rollers that squeeze the tubing (Figure 4-12). As the tubing recovers to its normal size, more wastewater is drawn into the tubing, which is then trapped by the next roller and finally expelled, from the pump. Nothing but the tube touches the wastewater, thus eliminating any risk of contamination. Pump design prevents backflow and siphoning without valves. Peristaltic pumps are often used for chemical feed or for wastewater sampling.

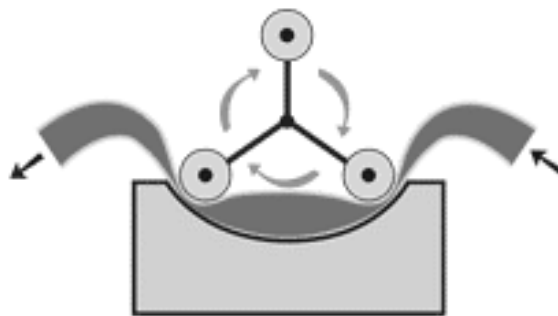

Figure 4-12. Peristaltic pump.

### **Bearings**

There are several types of bearings used in pumps – such as ball bearings, roller bearings, and thrust bearings. Each bearing has a special purpose. The type of bearing used in each pump depends on the manufacturer's design and application.

Bearings are machine parts designed to reduce friction between moving parts or to support moving loads. There are two main kinds of bearings:

- the antifriction type, such as the roller bearing and the ball bearing, operating on the principle of rolling friction; and
- the plain or sliding type, such as the thrust bearing, employing the principle of sliding friction; thrust bearings are used to support the pump shaft.

Pump bearings usually should last for years if serviced properly and used in their proper application. Whenever a bearing failure occurs, the bearing should be examined to determine the cause and, if possible, eliminate the problem. Many bearings are ruined during installation or pump startup.

## Packing

Pump packing reduces or eliminates internal liquid leakage within a pump. This is important because the objective is to pump water, not air, and because air leakage can cause a pump to lose suction. To keep air from being drawn into the pump, stuffing boxes are used.

Each stuffing box consists of casing, rings of packing and a gland at the outside end. Each ring of packing should be placed separately and seated firmly before adding the next. These rings are removable and replaceable when wear enlarges the tiny gap between them and the impeller. In addition to increasing the efficiency of the pump by reducing air leakage, pump packing can prolong the life of the pump and shaft by reducing friction.

The manufacturer's recommendations should be followed in choosing a packing.

## Mechanical Seals

Many pumps use mechanical seals in place of packing. Mechanical seals serve the same purpose as packing: they prevent leakage between the pump casing and shaft. Like packing, they are in the stuffing box where the shaft goes through the volute; however, they should not leak.

Mechanical seals have two faces that mate tightly and prevent water from passing through them. One half of the seal is mounted in the pump or gland with an "O" ring or gasket, thus providing sealing between the housing and seal face. This prevents water from going around the seal face and housing.

The other half of the mechanical seal is installed on the pump shaft. This part also has an "O" ring or gasket between the shaft and seal to prevent water from leaking between the seal part and shaft. There is a spring located behind one of the seal parts, which applies pressure to hold the two faces of the seal together and keeps any water from leaking out. One half of the seal is

stationary, and the other half is revolving with the shaft.

Some of the advantages of mechanical seals are:

- they last from three to four years without one having to touch them, resulting in labor savings
- usually there is no damage to the shaft sleeve when they need replacing
- continual adjusting, cleaning, or repacking is not required

Some of the limitations are

- high initial cost
- a competent mechanic is needed for installation
- when they fail, pump must be shut down
- pump must be dismantled to repair

## Lubrication

Pumps, motors, and drives should be oiled and greased in strict accordance with the recommendations of the manufacturer. The best quality oils and grease obtainable should be used. Over-greasing should be avoided, as too much grease will cause as much damage as lack of lubrication.

It is especially important not to over-lubricate motor bearings as this can lead to bearing seal failures. This has been the cause of an untold number of motor failures. The present trend is toward the use of more sealed bearings that require no additional grease for their lifetime.

Oil should not be put in the housing while the pump shaft is rotating because the rotary action of the ball bearings will pick up and retain a considerable amount of oil. When the unit comes to rest an overflow of oil around the shaft or out of the oil cup will result.

Pump packing should be well lubricated since it increases the efficiency of the pump by reducing air leakage and prolongs the life of the packing and shaft by reducing friction. A trickle of water should be allowed to keep the gland cool. If the packing box leaks excessively, remove the packing, and repack with fresh packing.

Never repack with part new and old packing and when repacking be sure that the water seal ring is in proper position in the stuffing box to receive the seal water. A water seal ring serves a dual purpose in that, as well as lubricating, it keeps gritty material from entering the packing box (thus increases the life of the packing and shaft.)

Mechanical seals are always flushed in some manner to lubricate the seal faces and minimize

wear. This may be the liquid being pumped and is referred to as "source lubrication". If fresh water is used, it is connected from the high-pressure side and back to the stuffing box low-pressure side. In some lift stations, wastewater is used in this matter, but it must be filtered. Still another way of lubricating the seal is to use a spring-loaded grease cup.

Whatever the method, mechanical seals should be inspected frequently. The seal water is adjusted to 5 PSI above maximum discharge pressure to keep the wastewater and grit from entering the seal housing and contaminating the seal faces. If grease cups are used they must be always kept full and inspected to make sure they are operating properly.

When a pump is fitted with a mechanical seal, it must never run dry, or the seal faces will be burned and ruined. Mechanical seals are not supposed to have any leakage from the gland. If a leak develops, the seal may require resurfacing, or it may have to be replaced.

## Priming a Pump

A pump will not operate unless it has been properly primed. A pump is considered primed when the pump casing and the suction piping are completely filled with liquid. A pump that has a positive suction head will seldom lose its prime, whether the pump is on or off, and will likely only need to be primed after it has been opened or replaced.

For pumps with a negative suction head (suction lift), the water tends to run back out of the pump and down the suction line when the pump stops. If the casing is filled with air, the impeller cannot create enough vacuum upon starting to draw water back into the unit, and the air will just circulate around in the pump. In this situation, both the pump and motor will overheat in a short time.

If a positive suction head cannot be provided, the pump must be separately primed (filled with water) each time it is started unless it is equipped with some type of self-priming device, such as a foot valve, a vacuum pump or ejector, or a priming chamber.

A foot valve is a specialized check valve at the end of the suction line. The valve is open when the pump is operating but shuts as the pump stops, holding the water in the pump and suction line after the pump has been initially primed.

Vacuum pumps and ejectors are separate units attached to the main pump casing. They create the vacuum needed to fill the pump before startup. These are often installed where suction lift is great.

A priming chamber is a large chamber at the top of the pump. This chamber is an air separator that ensures that the air in the pump will be removed through the discharge line when the pump is started.

Some self-priming pumps have a wide suction inlet that is higher than the pump. When the pump stops, the discharge valve closes and the water in this suction inlet runs back into the pump, rather than down the suction line. A vent exhausts any air that remains.

## Cavitation

Cavitation is the formation and collapse of a gas pocket or bubble on the blade of an impeller. This condition results from unusually low pressures that can occur when pump inlet pressures drop below the design inlet pressures or when the pump is operated at flow rates considerably higher than design flows. At very low pressure, the water in the pump starts to boil and vapor bubbles form. These bubbles then collapse with great force that can knock metal particles off and pit the impeller. The same action can occur on pressure reducing valves and partially closed gate and butterfly valves.

Cavitation is accompanied by loud noises that sound like someone is pounding on the impeller or valve with a hammer. Damage caused by cavitation can be severe, resulting in replacement of the impeller and/or volute.

## Water Hammer

Also known as hydraulic shock, water hammer is an oscillation in pressure that results from a too rapid acceleration or retardation of flow, such as when a valve is opened or closed very rapidly. When a valve position is changed quickly, the water pressure in a pipe will increase and decrease back and forth very quickly. This rise and fall in pressures can cause serious damage to the system as well as producing a noise like someone hammering on a pipe. Surge tanks installed in the areas where water hammer is a problem can absorb some of the pressure.

Air release (sometimes called air relief) valves can also help minimize water hammer damage. These devices allow the release of air in the distribution network while the system is pressurizing. The valve is open allowing air to escape. When water fills the pipe, it forces a ball into the valve and closes it, preventing escape of effluent. These valves are usually installed at high elevation points in a distribution network, as well as at the end of laterals and trunk lines where air might be forced to a dead end.

## Pump Controls

A variety of controls are used to operate wastewater pumping systems. These controls are used to activate pumps, valves, water level sensing devices, alarms, timers, counters, and meters. Controls are contained in protected enclosures called control panels. Control panels can be simplex (control one pump), duplex (control two pumps), or multiplex (control more than two



pumps).

All control panels should have a ground rod and a hand-off-automatic (HOA) switch that allows the operator to override the control system and manually activate the pump. Panels should have visual and audible alarms and an alarm silence switch.

### *Water Level Sensing and Pump Control*

Accurate sensing of high and low water levels is critical for proper timing of pump operation. Control of pumping systems is achieved by an ON/OFF type of control, which starts and stops pumps according to a level, pressure, or flow measurement. Usually an ON/OFF pump control system responds to level changes in a tank of some type. Water level can be sensed directly with a float or by a pressure change at the tank or pump site. The pump is thus turned off or on as tank level rises above or falls below predetermined level or pressure limits. These controls can either be single-point detection or continuous detection.

To prevent the pump from running after a loss of level signal, electrical circuitry should be designed so the pump will turn OFF on an OPEN signal circuit, and ON only with a CLOSED circuit. Larger pump systems also will often have a low-pressure cutoff switch on the suction side to prevent the pump from running when no water is available, such as with an empty tank or closed suction valve.

Controls may also protect against overheating a pump (as happens when continuing to pump against a closed discharge valve) by high-pressure or low-flow cutoff switch on the discharge piping. Both the high- and low-pressure switches should shut off the pump through a time delay circuit so that short-term pressure surges (dips and spikes) in the pumps' piping can be tolerated. Types of ON/OFF pump controls include:

- float switches
- pressure bulbs and diaphragm switches
- bubble tubes
- electrode switches
- ultrasonic sensors

### **Float Switches**

The simplest and most common type of control unit is a counter-weighted float that triggers a mercury switch. The float is fixed at a desired depth. When the wastewater level is below the float, the float hangs down. As the wastewater level rises, the float is raised. When it reaches a predetermined level, the switch is tripped to start the pump. When the wastewater level falls to the cutoff level, the float switch stops the pump.

## Pressure Tubes and Diaphragm Switches

Pressure-sensing controls entail the small movement of some flexible element subjected to a force. The most common types are the Bourdon tube, bellows, or diaphragm arrangements. As the water level rises and reaches a specific depth, the pressure generated by the water depth pushes the flexible element inward, compressing the volume of air inside. The increased air pressure is registered on a sensor and transmitted to the pump to turn on. As the water level goes down, pressure decreases, the flexible element extends outward again, and the pump switches off.

## Bubbler Tubes

The pressure created by the liquid level is sensed, but not directly as with a liquid pressure element. Air pressure is created in a bubble tube to just match the pressure applied by the liquid above the open end of the tube when it is immersed to a precisely determined depth in a tank or basin. The air pressure in the tube is then measured as proportional to the liquid level above the end of the tube.

Bubbler systems are adjusted so air just begins to bubble slowly out of the submerged end of the sensing tube. They automatically compensate for changes in liquid level by providing a small, constant flow of air through the bubbler tube by means of a constant flow of air regulator.

## Electrode Level Sensing Switches

An alternative to mechanical level-sensing systems is the electrical probe. The probes can be small-diameter stainless steel rods inserted into a tank through a fitting, usually through the top, but at times in the side of a vessel. A small voltage is applied to the probe by the system's power supply, with current flowing only when the probe becomes immersed. When current flow is sensed, a switch turns the pump on. When the wastewater level falls and the probe is no longer immersed, current ceases to flow and the pump is turned off.

## Ultrasonic Level Detecting Switches

This type of level detecting system is based on high frequency sound waves. A mounted transmitter sends sound waves to the wastewater surface. The time it takes for the sound waves to bounce back is measured and converted to a signal that is proportional to the time and to the water level.

## Alternators

Alternators are relay devices designed for alternating the run cycle or duplexing action of two or

more motors automatically. They are used to divert flow automatically or manually to be pumped through two or more pumps in a cycle in accordance with a predetermined sequence. Duplex or multiplex control panels include automatic or manual pump alternators (two pumps) or sequences (more than two pumps).

In a station with multiple pumping units, an automatic alternator or sequencer regularly changes the order of the pumps' start-up to maintain similar operating times for all pumps (to provide even wear). To protect the pump's electric motor from overheating, level controls should be set so that the pump starts as few times as possible.

### **Alarms**

Alarms are visual and audible signals that a variable is out of bounds, or that a condition exists in the system requiring the operator's attention. They can vary from a simple high water level alarm to a multiple system. The most common and necessary is the high water alarm. High water alarms can be activated using the same ON/OFF controls used to sense water level changes. Other alarms that may be necessary include pump failure alarms, power failure alarms, seal failure alarms, and motor head sensor alarms.

### **Timers**

Timers are devices that allow an operator to control pumps or controls in specified ways at predetermined times. Run cycle timers are timers that repeatedly open and close contacts according to preset time cycles.

### **Counters**

Counters provide flow indication for timer panels. They count the number of times the pump has been activated.

### **Relays**

Relays are electric devices designed to interpret input conditions in a prescribed manner and, after specified conditions are met, to respond and cause contact, operation, or similar abrupt changes in associated electrical control circuits. Time delay relays (TDR) are relays with either mechanical or solid state output contacts that perform timing functions upon energization or control signals.

### **Telemetry**

Telemetry is the automatic transmission of data on wastewater system characteristics between

two widely separated locations, typically an isolated, unattended facility and a central, attended facility. The electrical link between a field transmitter and the receiver. Telephone lines are commonly used to serve as the electrical line.

A variety of telemetry systems are available to communicate an alarm condition to a desired remote location. These systems range from simple single signal devices to complex systems. The transmitter portion is usually installed in the control panel and may have its own battery back-up power system.

## Meters

Meters are instruments for measuring some quantity such as the amount or rate of flow of wastewater. It is necessary to know the quantity of wastewater flow so adjustments can be made to pumping rates, chlorination rates, and other processes in the system. Flow rates must be known also for calculating loadings on treatment processes, treatment efficiency and to satisfy the non-discharge permit.

Elapsed time meters are used to record the amount of time each pump runs. This is a good way to monitor the hours per day that a pump runs. One elapsed time meter is used per pump.

Flow measuring devices must be periodically calibrated. Most manufacturers and dealer representatives will offer a service and maintenance agreement with a flow meter for its periodic calibration. Typically, once per year is required. Comparing flow measurement against other methods of flow estimation can also help to calibrate pump discharge rates.

For example, knowing the discharge rate from a sprinkler based on nozzle size and pressure (which gives gallons per minute) and multiplying by the total pump run time can give a good estimate of total flow in a pump cycle. Another standard to check against is pump drawdown in a tank or wet well, or lagoon level drawdown. Both of these methods require the ability to valve off influent flow into the tank or lagoon, or have it precisely measured.

An operator should use all appropriate techniques to help with flow management in a spray irrigation system

## Microprocessors

Microprocessors and computers are now commonly used in many wastewater applications, including individual instruments and entire digital computer-based control systems. Microprocessors can do extremely complex functions at high speeds with low power consumption. The most significant example of the utility of the microprocessor is the personal computer (PC). These microprocessors are relatively inexpensive stand-alone computer systems

that can help an operator enter, store, retrieve, and manipulate enormous amounts of data quickly and easily.

## *4.2. Distribution Networks and Devices*

To ensure the appropriate amount of wastewater is uniformly applied to spray fields, operators must be familiar with correct pressure settings, sprinkler spacings, and time of operation needed. This section discusses distribution system components and general operational procedures for common types of wastewater irrigation systems follows.

From our discussion on pumps, we know that the purpose of a pump is to move our wastewater to the field where it will be distributed over the land by our surface irrigation system. The primary components of a surface irrigation system are:

- pipes
- fittings and valves
- sprinklers and nozzles
- accessories

### **Piping**

Piping used in surface irrigation systems can either be made of metal (iron, stainless steel, copper, aluminum) or plastic (polyvinyl chloride or polyethylene). Several of these are discussed below.

#### *Metal Pipe*

##### **Cast Iron**

Cast iron pipe is some of the oldest piping material in use today. It is now manufactured by a process called spin casting, during which molten iron is injected into a spinning mold. The result is a pipe of consistent diameter and wall thickness. Cast iron pipe can withstand high working pressures. Pressure ratings of 350 psi are common. However, the material cannot withstand sharp shock loads either internally or externally.

##### **Steel**

Steel pipe is made by extruding or welding sections of steel to form a pipe. This pipe falls into two categories, mill pipe and fabricated pipe. Steel pipe is classed as a flexible conduit. That means that it can withstand a 3% deflection of the diameter without damage to the pipe. Steel pipe is commonly manufactured to meet very high pressures (up to 700 psi is not uncommon). However, under a vacuum it will collapse.

Because steel pipe is a flexible conduit, it requires a selection of wall thickness suitable to withstand external loads as well as internal loads. Steel can easily be shaped into various sizes and shapes, which is one of its major advantages. It has a high tensile strength and high ductility. These characteristics give it the ability to withstand high internal and external loads.

The main disadvantage is that it corrodes easily, which results in high maintenance costs. An additional disadvantage is that it will collapse under a vacuum. Epoxy coated steel is more resistant to corrosion and offers longer life spans.

## Aluminum

Aluminum pipe is used in above ground situations as portable pipe. It is often used to pipe water to a traveling irrigation device such as a center pivot tower or traveling gun hose-reel. It is sometimes used in solid set systems as well. It is lightweight, very portable, and easily connected. It does not offer good strength and is easily damaged by machinery or fallen trees. Often, leaks can occur until the distribution system is fully pressurized. Above ground pipe is not suitable where winter operation is necessary – as freezing causes pipe damage as well as poor function of the sprinkler heads attached to the pipe due to ice clogging.

## Ductile Cast Iron Pipe (DIP)

Ductile cast iron pipe is made by injecting magnesium into the cast iron during the molding process. The magnesium alters the shape of the carbon structure of the cast iron. This gives the pipe superior beam strength. It will resist high impacts and is more corrosion resistant than gray cast iron. Ductile iron pipe is classed by wall thickness.

The common thickness class ranges from 50 through 56. The higher the number, the thicker the wall. However, wall thickness also varies with the size of the pipe. The thickness class needed for a particular condition is based on the internal working pressure, the depth of the cover, the pipe size, and the type of bedding condition to be used.

Because of its ability to withstand high stress, extreme beam and crush loads, unusual shock, unstable bedding, and deep fills, it is one of the few materials that can be used in extreme conditions. Its disadvantages are its weight and its susceptibility of corrosion.

## *Plastic Pipe*

### Polyvinyl Chloride (PVC)

PVC pipe is made from unplasticized polyvinyl chloride. This material only gained wide acceptance in the wastewater industry when a thicker walled material was developed, and an

acceptable standard was adopted. The standard that governs most of this thick-walled PVC pipe is called C-900. This distinguishes it from other PVC pipe that has a thinner wall. PVC is manufactured in various sizes and wall thicknesses.

The advantages of PVC pipe are that it is strong, but lightweight. It cuts easily and can be fused together with solvent cement. It is relatively low cost and low maintenance. Disadvantages are that it needs careful installation, cannot withstand high impacts or shocks, is sensitive to sunlight, and cannot be used around petroleum products. Finally, in cold weather it can become brittle, requiring special handling.

### Polyethylene (PE)

Polyethylene pipe is available in low, medium, and high density, with pressure ratings from 50 to 160 psi. It is more flexible and has thicker walls than PVC, is better for rocky soils or soils prone to freezing, is easier to transport, and is tolerant of sunlight and petroleum products. However, it is more expensive than PVC and its fittings are bulkier and more difficult to install.

## Terminology

Before discussing rating systems, we need to define pipe terminology:

- O.D. - outside diameter
- I.D. - inside diameter
- I.P.S. - iron pipe size
- P.I.P. - plastic irrigation pipe size

## Rating Systems for Plastic Pipe

There are two systems for labeling plastic pipe with regards to pressure rating:

1. Schedule pipe
2. SDR or Class pipe

**"Schedule"** refers to the wall thickness of the pipe. The wall thickness, I.D., and O.D. of scheduled pipe are based on steel pipe dimensions. Two common schedules are Schedule 40 and Schedule 80. A higher schedule number means thicker walls and a higher pressure rating. One-inch Schedule 80 pipe has thicker walls and a higher pressure rating than one-inch Schedule 40 pipe.

Within each schedule, each pipe size has a different recommended working pressure. As pipe diameter increases, the pressure rating decreases. Table 4-1 shows the relationship between pipe size, wall thickness, and pressure rating for Schedule 40 PVC pipe.

Table 4-1. Relationship between pipe size, wall thickness, and pressure rating for Schedule 40 PVC pipe.

Pipe Size	Wall Thickness	Pressure Rating (PR)
2"	0.154"	280 psi
6"	0.280"	180 psi
10"	0.365"	140 psi

This material is not normally placed in a trench. It is used as piping in small pump stations and in chlorine stations.

**“SDR” or “Class”** pipe is grouped according to its SDR value. SDR stands for **“Standard Dimension Ratio”** which is the outside diameter of the pipe divided by its wall thickness. The higher the SDR number, the thinner the pipe wall. As the diameter of this pipe increases, the thickness of the pipe increases.

Common SDR values and their associated class or pressure rating are listed in Table 4-2. PVC pipe with an SDR of 21 and a Class of 200 psi with cast iron pipe outside dimensions is the pipe most used in wastewater.

Table 4-2. SDR values and classes.

SDR Value	Class or PR
13.5	315 psi
21	200 psi
26	160 psi
41	100 psi

All pipe with the same SDR value has the same pressure rating regardless of the pipe size. For example, a one-inch and a 24-inch pipe with the same SDR rating have the same pressure rating. Table 4-3 shows the relationship between pipe size, wall thickness, and pressure rating for SDR 21 PVC pipe.

Table 4-3. Relationship between pipe size, wall thickness, and pressure rating for SDR 21 pipe.

Pipe Size	Wall Thickness	Pressure Rating (PR)
2"	0.113"	200 psi
6"	0.316"	200 psi
10"	0.511"	200 psi



## Fittings

A **fitting** is used in pipe systems to connect straight pipe sections, adapt to different sizes or shapes, and for other purposes, such as regulating flow. Examples are elbows that alter the direction of a pipe, tees, and crosses to connect a branch with a main, plugs and caps to close an end, and bushings, diminishers, or reducing sockets to couple two pipes of different dimensions. It is important to remember that Schedule PVC fittings do not have the same rating as the pipe.

Types of fittings include:

- **elbow** - connects two lengths of pipe to allow a change of direction, usually a 90° or 45° angle.
- **tee** - used to combine (or divide) fluid flow.
- **reducing tee** - any tee having two different sizes of opening; it may reduce on the run or branch.
- **adapter** - a fitting that is used to connect pipes of different types or sizes.
- **reducer** - pipe fitting having an opening at one end smaller than that at the other end.
- **coupling** - with a socket at one or both ends that allows two pipes or tubes to be joined, welded (steel), brazed or soldered together.
- **union** - similar to a coupling, allows the convenient future disconnection of pipes for maintenance or fixture replacement. In contrast to a coupling requiring solvent welding, soldering, or rotation (for threaded couplings), a union allows easy connection and disconnection, multiple times if needed. It consists of three parts: a nut, a female end, and a male end.
- **wye** - pipe fitting with three branches positioned in one plane in a pattern of the letter Y.

PVC cement, also called "solvent weld", uses a special primer and glue to physically mate (connect) PVC pipe and fittings. The glue causes the PVC to bond by a chemical reaction that melts the two pipes, allows them to combine, then cools and solidifies into the banded pipe.

## Connections

A connection is a collar or coupling that fits over adjacent ends of pipe to be joined, and which, when drawn tight, holds the pipe together either by friction or by mechanical bond. Connections include:

- **flange** - a connection made by flanges bolted together; the joint is made water-tight by a gasket placed between the two flanges.
- **bell and spigot** - a form of joint used on pipes that have an enlarged diameter or bell at one end, and a spigot at the other that fits into and is laid in the bell. The joint is then made tight by lead, cement, rubber "O-ring, or other jointing compounds or materials.
- **mechanical joint** - any form of flexible joint involving lugs and bolts; uses a bell and spigot arrangement. A rubber gasket is placed around the spigot. The gasket is forced into the bell by a metal ring (called a follower ring) that is held to the bell by a series of bolts.
- **threaded** - a connection made by threading a male end section of pipe or fitting into a female fitting or adapter. With metal threads, pipe compound is typically required for a waterproof seal. Teflon thread tape may be used on metal or PVC pipe threads.

## Pipe Cleanouts

Pipe cleanouts should be used whenever wastewater has a solids content that causes the potential for solids buildup and clogging in piping. They are also advised at sharp turns in piping such as elbows, where water tends to slow down. A pipe cleanout is typically a wye fitting that is installed several feet up-flow from the appropriate area to be cleaned.

The “dead end” of the wye is at the ground surface or above for easy access and is capped off with a threaded plug. This access must be protected from equipment and traffic. It allows the operator to clean the piping with plumbing snakes, augers, or water pressure cleaners.

## Thrust Blocking

Thrust blocking is used in irrigation systems using moderate to high water pressures to protect the distribution system from damage that could be caused by water pressure. Thrust blocking is used at all points at which water flow either changes direction (such as tees and elbows) or comes to a dead end (ends of laterals or field valves). The thrust block, which is typically a mass of concrete, must lie against natural ground to offer the most protection.

Pipe excavation for repair at any of these points is likely to encounter concrete thrust blocks, which must be replaced when replacing pipe or fittings where water changes direction.

## Valves

A valve is a device installed in a pipeline to control the magnitude and direction of the flow. It consists essentially of a shell and a disk or plug fitted to the shell. Valves vary in construction and size depending upon their function. Some are classified according to their method of operation or design, and some are named for the functions they perform. Valves can be operated automatically or manually.

Types of valves encountered in a surface irrigation system include:

- **gate valve** - designed to operate fully open or fully closed (on/off or isolation valve). A disc in the valve is raised and lowered by a threaded stem or sliding stem to open and close the valve.
- **ball valve** – off/on valve. A form of quarter-turn valve that uses a hollow, perforated, and pivoting ball to control flow through it. It is open when the ball's hole is in line with the flow and closed when it is pivoted 90-degrees by the valve handle.
- **globe valve** - water is directed through the valve in a specific direction, then is forced to change direction and go through a large orifice, hit a disk, and again change direction to exit the valve. This induces head loss and makes it a good throttling device. It has a round, ball-like shell and horizontal disk.
- **butterfly valve** – used as an off/on valve and as a throttling valve. Has a disc that turns sideways to open the valve. The disk, as it opens or closes, rotates about a spindle supported by the frame of the valve. The valve is opened at a stem. At full opening, the disk is in a position parallel to the axis of the conduit.
- **check valve** - allows wastewater to flow in only one direction. Check valves either have ball or flapper mechanisms that prevent backflow of effluent. A valve provided with a disk hinged on one edge so that it opens in the direction of normal flow and closes with reversal of flow.
- **air relief valve** - designed to allow the release of air pressure in an irrigation system. Air relief valves are typically installed at the distal ends of long runs of piping, at high elevation points in fields, and at other places where air may be trapped, such as at a field valve or sharp turn in the piping. These valves have a ball or some mechanism

that allows air to escape but shuts tightly when water pressure enters them. Their purpose is to allow air that is in the piping system to escape when water is being pumped into the system and to help eliminate damage to pipes and sprinklers from excessive air pressure.

- **pressure relief valve** - valve that, when actuated by static pressure above a predetermined level, opens in proportion to the excess above this level and reduces the pressure to it.
- **pressure reducing valve** – automatically reduces a higher inlet pressure to a constant lower downstream pressure, regardless of changing flow rate and/or varying inlet pressure. Also called a pressure regulating valve. A pressure sensor in the valve opens and closes an internal valve to keep the pressure at the outlet constant.

Non-adjustable pressure reducing valves have a factory-set outlet pressure. These are usually used for residential systems. Adjustable pressure reducing valves can be set for any desired downstream pressure within the design limits of the valve. Once a valve is set, the reduced pressure will be maintained regardless of changes in supply pressure (as long as the supply pressure is at least as high as the reduced pressure desired) and regardless of the system load, providing the load does not exceed the design capacity of the reducer.

- **solenoid valve** - uses a solenoid (an electric coil) to open and close small openings to divert fluid from one side of a diaphragm to the other. When the pressure on top of the diaphragm is equal to the inlet pressure, the valve will remain closed. When pressure is released from on top of the diaphragm, a pump can then open the device. Solenoids can operate small valves or other electrical switches.

See Appendix D-1 for information on pipe weights and dimensions, pressure ratings, installation procedures, fittings, and connections.

## Sprinklers

Sprinklers, drip emitters, and other devices are used to distribute wastewater to the designated waste application fields. Many people consider the distribution system to be the heart of a spray or drip irrigation system. Of course, if the pumping system is not designed or is not working properly, then the sprinklers cannot make a bad situation good. However, most operators of spray irrigation systems will spend much of their time dealing with sprinkler management, maintenance, and repair. Sprinkler maintenance and operation is a key component of managing a waste application system.

There are many types of distribution devices available. Most have been designed for freshwater irrigation, but some have been adapted for wastewater. Many function well where wastewater is very dilute and has few solids or chemicals.

It is beyond the scope of this manual to discuss all types of equipment available. The operator should be familiar with the basic terms describing irrigation equipment and the factors that affect the operation of that equipment. When purchasing irrigation equipment, always notify the dealer that the equipment will be used in a wastewater setting.

The following are the most common types of sprinklers used in irrigation systems:

- **rotary impact** – a sprinkler whose head rotates around the base due to a swinging, spring-loaded impact arm (Figure 4-13) . The water pressure throws the arm to the side, it returns due to the spring, and intercepts the water stream, causing the sprinkler to rotate several degrees. Has a small bore (nozzle) opening (1/8 to 3/8 inch). Made of metal or plastic.

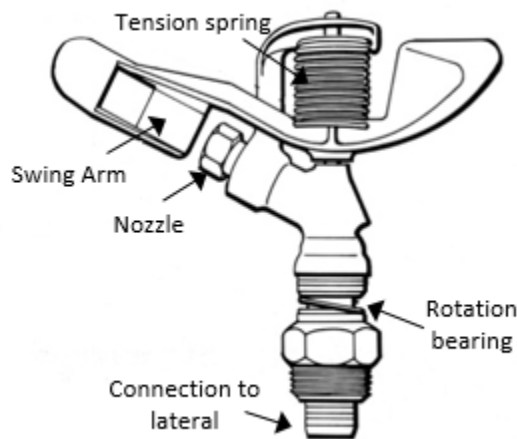

Figure 4-13. Rotary impact sprinkler.

- **big gun** – very large sprinkler that operates at high pressures. Large bore opening – nozzle sizes from 0.5 to 2 inches. Flow rates up to 1000 gpm, but 500 to 600 gpm is more common. Usually mounted onto a permanent riser of two-inch pipe size or larger, a traveling gun cart, or the distal end of a center pivot system. Three types of nozzles: ring nozzles, taper bore nozzles, and taper ring nozzles.



Figure 4-14. Big gun sprinkler.

- **micro spray heads** - devices that distribute effluent in a variety of patterns other than the rotary impact sprinkler head described above. Water is deflected via vanes, grooves, wobbling weights, and other devices that allow for effluent distribution. Usually, these are used with lower pressures (5 to 30 psi), and often are used to reduce wind drift. The length of effluent throw is limited, resulting in close spacing required.
- **drip emitters** - installed in flexible (PVC, polyethylene) tubing (hoses). They allow water that is under pressure inside the tubing to be emitted at low pressures. Usually, this type of piping is installed at the ground surface or slightly under the ground surface to provide water uptake by plant roots. The drip emitter consists of a labyrinth inside the hose that allows for pressure drop as the water is emitted. The orifice size is about 1/16 to 1/8 of an inch and distributes from 0.5 to 2 gpm.
- **nozzle** - the part of the sprinkler where the wastewater discharge occurs. Important factors are nozzle type (plastic, brass, taper bore, ring, etc.) and nozzle size at the opening (in inches).
- **full circle sprinkler** - a sprinkler that turns 360 degrees and wets a total circle. These are

used in the interior and exterior positions of spray fields.

- **partial circle or partial turn sprinkler** - a special sprinkler that allows the operator to direct discharge to a select portion of the field. Devices such as clips, or threaded stops cause the sprinkler to rotate part circle (less than 360 degrees). These are often used to prevent irrigation into buffers, roadways, ditches, or problem areas in the field. Using part turn sprinklers, without changing other parameters such as nozzle size or pressure, results in an increased wastewater application rate.

For example, a  $\frac{1}{4}$  turn sprinkler with the same settings as a full turn sprinkler will apply four times as much water per hour to the area it irrigates. Part turn sprinklers must be operated very carefully to avoid ponding and runoff.

## *Types of Spray Irrigation Systems*

There are two primary types of wastewater irrigation systems: stationary and traveling systems.

### **Stationary Systems**

One of the main advantages of stationary (or fixed) sprinkler systems is that these systems are well suited to irregularly shaped fields. It is difficult to give a standard layout, but there are some common features between systems. There are two types of stationary systems: solid set and big gun systems.

- *Solid Set Irrigation Systems*

Solid set systems are usually permanent installations consisting of buried pipes (usually PVC plastic) with evenly spaced sprinklers mounted on risers. Sprinkler spacing is based on nozzle flow rate and desired application rate. To provide proper overlap, sprinkler spacings are normally 50 – 65% of the sprinkler wetted diameter, or in the range of 80 feet by 80 feet. A typical layout for a permanent irrigation system is shown in Figure 4-15.

The minimum recommended nozzle size for wastewater is  $\frac{1}{4}$  inch. Typical operating pressure at the sprinkler is 50 to 60 psi. Sprinklers can operate full or partial circle. The system should be zoned (any sprinklers operated at one time constitutes one zone) so that all sprinklers are operating on about the same amount of rotation to achieve uniform application.

Most solid set systems use Class 160 PVC plastic pipe for mains, submains, and laterals and either 1-inch galvanized steel or Schedule 40 or 80 PVC risers near the ground surface where an aluminum quick coupling riser valve is installed.

The advantages of solids set irrigation equipment include:

- good for small or irregularly shaped fields
- don't have to move

Disadvantages include:

- high initial costs
- must be protected from animals and equipment
- sprinklers more likely to plug

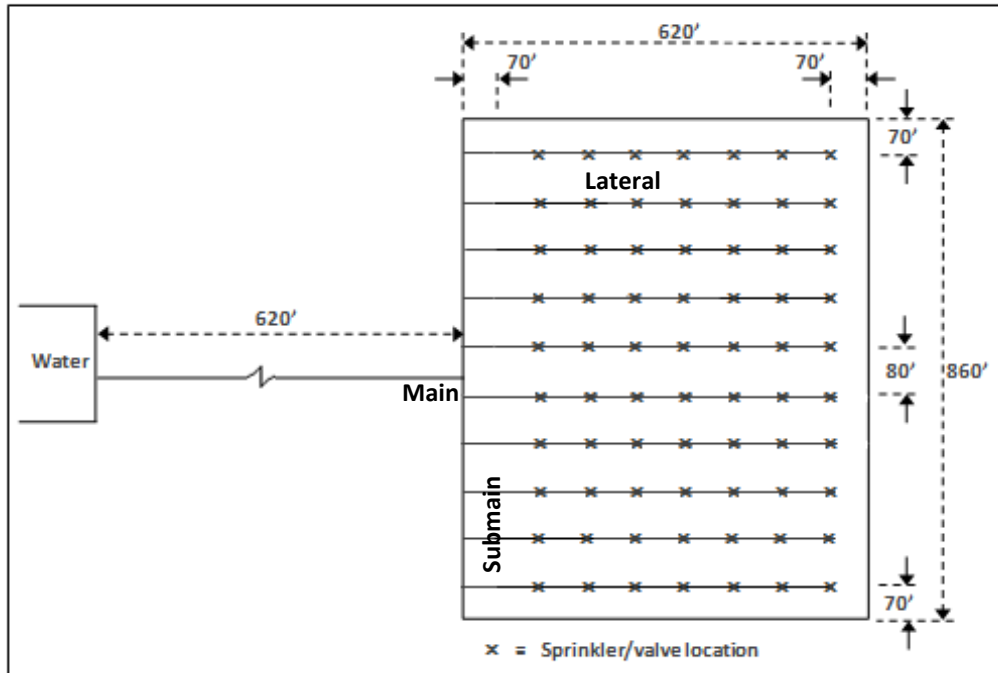

Figure 4-15. Layout of a typical solid set irrigation system.

- ***Stationary Big Gun Systems***

Stationary big gun systems are permanent installations that consist of buried pipes with a single or multiple large-volume sprinklers mounted on one or more risers. A "big gun" sprays a large stream of water high in the air during irrigation, which is very susceptible to wind and evaporation losses. Operating pressure range from 50 – 120 psi. They can be automated and require little labor.

These sprinklers have high application rates; consequently, adjacent guns should not be operated at the same time (referred to as "head to head").



## Mobile Irrigation Equipment

Mobile or traveling sprinkler systems are either cable-tow or hard-hose travelers, center pivot, or linear-move systems.

- *Travelers*

There are two types of traveling gun systems: cable-tow travelers and hard-hose travelers. Traveling gun systems consist of a single big gun mounted on a wheeled cart (called a gun cart) that is pulled across the field by a cable or hose wrapping around a rotating reel.

A cable-tow traveler has a large, flexible hose, one end of which is attached to the gun cart and the other end to a pipe supplying water from the water source. The machine propels itself through the field by winding a multi-strand, high strength steel cable around a drum or pulley mounted on the gun cart. The cable must be attached to an immovable object, like a tractor, at the edge of the field. Power to propel the cable winch is supplied by a water motor, water piston, water turbine or auxiliary engine. The depth of wastewater application is varied by varying the speed of the cable winch.

A hard-hose traveler has a large reel (hose drum) mounted on a two- or four-wheel trailer, and a large semi-rigid polyethylene (PE) hose. The hose reel is parked at the end or in the middle of a travel lane. The hose supplies wastewater to the gun sprinkler and pulls the gun cart along as it is wound onto the hose reel (Figure 4-16).

The hose reel is rotated by a water turbine, water piston, water bellows, or by an internal combustion engine. Regardless of the drive mechanism, the system should be equipped with speed compensation so that the gun cart travels at a uniform speed from the beginning of the pull until the hose is fully wound onto the hose reel. If the solids content of the wastewater exceeds one percent, an engine drive should be used.

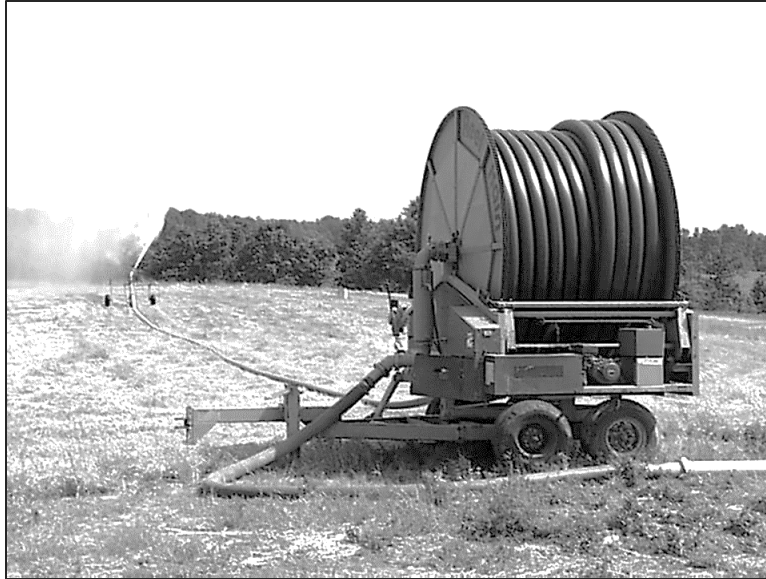

Figure 4-16. Hard-hose traveler showing reel and gun cart.

The distance between adjacent pulls is referred to as the lane spacing. To provide proper overlap, the lane spacing is normally 70 to 80% of the gun wetted diameter. Operating pressures range from 50 to 80 psi. Like stationary sprinklers, traveling guns can operate full or partial circle. A typical layout for a hard-hose traveler irrigation system is shown in Figure 4-17.

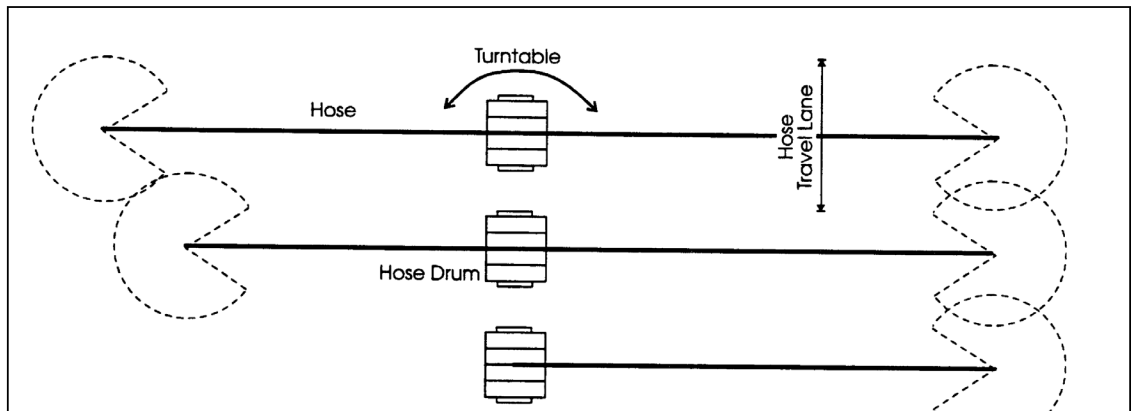

Figure 4-17. Schematic layout of a hard-hose traveler.

Nozzle sizes on big gun travelers range from ½ to 2 inches in diameter. There are three types of nozzles: taper bore, ring, or taper ring. The ring nozzle provides better breakup of the wastewater stream, resulting in smaller droplets with less impact energy (less soil compaction) and providing better application uniformity throughout the wetted radius.

But, for the same operating pressure and flow rate, the taper bore nozzle throws water about five percent further than the ring nozzle, i.e., the wetted diameter of a taper bore nozzle is five percent wider than the wetted diameter of a ring nozzle. This results in about a ten percent larger wetted area such that the precipitation rate of a taper bore nozzle is approximately ten percent less than that of a ring nozzle.

A gun sprinkler with a taper bore nozzle is normally sold with only one size nozzle whereas a ring nozzle is often provided with a set of rings ranging in size from ½ to 2 inches in diameter. This allows the operator flexibility to adjust flow rate and diameter of throw without sacrificing application uniformity.

However, you should be aware that using a smaller ring with a lower flow rate will not normally reduce the precipitation rate. Rather, the precipitation rate remains about the same because while a smaller nozzle results in a lower flow, it also results in a smaller wetted radius or diameter. The net effect is little or no change in the precipitation rate.

Furthermore, on water drive systems, the speed compensation mechanism is affected by flow rate. There is a minimum threshold flow required for proper operation of the speed compensation mechanism. If the flow drops below the threshold, the travel speed becomes disproportionately slower, resulting in excessive application even though a smaller nozzle is being used.

System operators should know the relationships between nozzle size, flow rate, wetted diameter, and travel speed before interchanging different nozzle sizes.

Advantages of traveling irrigation systems include:

- portable
- application rate/depths can be adjusted (speed and nozzle settings)
- large nozzles don't plug easily

Disadvantages include:

- higher initial costs and operating costs
- impractical for small or irregularly shaped fields
- limited use on forested sites (can result in debarking unless diffusers are used)
- high application rates, potential for over-application

- *Center Pivots and Linear Move Systems*

A center pivot is a self-propelled irrigation system that consists of elevated distribution piping anchored at one end to a central pivot structure. Wastewater is supplied at the anchored end and distributed from sprinklers mounted to the piping. The piping rotates

around the pivot structure, riding on wheeled tower structures and creating a large, irrigated circle pattern.

Most center pivots in use today are driven by an electrical motor mounted at the fixed end. The application rate of each sprinkler increases with its distance from the fixed center, so that there is uniform application of wastewater as the pivot moves in a circular motion (Figure 4-18).



Figure 4-18. Center pivot system.

Center pivots use either impact sprinklers, big guns, or spray nozzles. Operating pressures range from 10 to 50 psi. Drop-type spray nozzles offer the advantage of applying wastewater close to the ground at low pressure, which results in little wastewater drift due to wind.

Big gun sprinklers are sometimes located at the outer end of the distribution pipe. These can be turned on and off as the system moves around the field; they allow the system to water an additional 100 to 150 feet in corners and other irregular parts of the field.

Computerized control panels allow the operator to specify speed changes at any place in the field, reverse the pivot, turn on auxiliary pumps at a specified time and many other features (Figure 4-19). The depth of wastewater applied in each application is determined by the speed at which the system moves around the field. This speed is set by the operator and is determined by the desired amount of wastewater to be applied to the field. Since the flow rate to the system remains constant, the more wastewater applied the longer it will take the system to complete a rotation.

Center pivots are available in both fixed-pivot point and towable machines. They are available in size from single tower machines that cover around 10 acres to multi-tower machines that can cover several hundred acres.

Linear-move systems are like center pivot systems, except that neither end of the distribution pipe is anchored. Drives at each end move the distribution pipe and towers across the field at the same speed and in the same direction. Wastewater is supplied through a feeder hose to one end of the distribution pipe.

Linear-move systems are like center pivot systems, except that neither end of the distribution pipe is anchored. Drives at each end move the distribution pipe and towers across the field at the same speed and in the same direction. Wastewater is supplied through a feeder hose to one end of the distribution pipe.



Figure 4-19. Center pivot control panel.

Depending on the type of sprinkler used, operating pressure ranges from 10 to 50 psi. Low-pressure systems reduce drift at the expense of higher application rates and greater potential for runoff.

Advantages of center pivot and linear move systems include:

- good for large areas
- higher uniformity of coverage
- lower labor requirement
- lower operating pressures result in less wind drift

Disadvantages include:

- high initial costs
- smaller nozzles clog more easily
- not suitable for small, irregularly shaped fields

## Operational Issues

By understanding the irrigation system components and their relative location and by using

monitoring devices, the irrigation system operator can effectively operate the system. Troubleshooting problems early can also prevent significant and expensive equipment problems and possible environmental degradation.

An operator should be familiar with all system components that make up a spray irrigation facility. This is most easily done by maintaining a set of approved, as-built plans for the facility.

Design plans do not always reflect what was actually installed in the ground. The plans should provide sufficient detail so the operator can determine where all pipes and their respective sizes and types are; and where all valves and fittings are located. This will allow the operator to perform quick service and repair, and to keep spare parts on hand. If as-built plans are not available, they may be obtained from the design engineer for the facility, or possibly the permitting branch of the Division of Water Resources.

The operator must be familiar with pump discharge rates and flow rates as described earlier in the chapter. Knowledge of operating pressures in the field is crucial to understanding flow rates and system efficiency. Pressure is often measured at the pump, with the assumption that the same pressure exists throughout the distribution system. It is good to know pressure at several locations, but the location that will tell you the most about the flow is the pressure at the discharge point (sprinkler or gun).

Most guns have a fitting where a pressure gauge can be easily mounted. Rotary impact sprinklers can be easily fitted with a pressure gauge by installing a tee in the sprinkler riser. On an irrigation system or zone with multiple sprinklers, several pressure readings across the field give the best picture.

However, at least one reading near mid-field and one near the higher sprinklers give a good average pressure for the system. This is the pressure that dictates the flow rate (gallons per minute) through each sprinkler. Significant elevation changes within one field or zone can result in higher discharge pressure and rate in the lower portions of the field.

Knowledge of pump pressure and field pressure can help an operator determine if pumps are running efficiently. Gathering baseline data can also help determine when pipes are beginning to clog. Blockages, as well as broken or separated pipes, can cause pressure reductions in the distribution system. These problems often result in extremely wet areas that will be obvious to the operator. Wet and soggy areas near valves and fittings may indicate that the pipe has been damaged or improperly installed such that leaks are causing the soil in the area to remain saturated.

Close monitoring of effluent pumping rates by use of flow meters and pump delivery rates will help with operational decisions at the facility. Such things as pump, piping and sprinkler wear can be predicted with accurate flow records. These records can also help the operator determine if

infiltration and inflow from the collection system are contributing to the waste stream. Accurate flow monitoring helps maintain compliance with state record keeping requirements and may indicate when a system expansion is necessary.

If wastewater flows exceed design flow, then a detailed examination of the system should be conducted, and necessary steps should be taken to maintain compliance with the system permit. Pump monitoring records, such as pump run time and number of pump cycles, can be used to monitor pump efficiency and proper working of float switches or relays.

If a pump cycles on and off frequently, motor and starter life can be shortened. This can happen when float switches are improperly set, or if wave action in a pump tank or lagoon causes floats to trip on and off in short cycles. Floats should be adjusted or replaced as necessary to prevent burn out of pump controllers.

In summary, an operator should maintain detailed records of all equipment and operational parameters at the facility. In conjunction with a detailed set of plans, operational and maintenance decisions can be made to provide long equipment life and efficient overall system operation. Operation and maintenance of spray irrigation equipment will be discussed in more detail in Chapter 5.





## Chapter 5

# Proper Wastewater Application

This chapter deals with the operation of the surface irrigation system on a daily basis. As you have learned, the system consists of many components, from the influent pipe to the soil/plant system, and everything in between. An operator must understand the entire system for it to perform properly. This is not to say that the operator must be a specialist in all facets of wastewater system design and soil or crop science. However, an operator needs to understand day-to-day management, and understand what situations call for technical assistance. Technical assistance references are found throughout this chapter and manual, and Appendix B-1 lists available resources.

A main function of a land application system for wastewater is to provide for adequate treatment of a waste product while protecting the quality of the receiver environment. Another function is to provide for beneficial reuse of the water and nutrients to produce a crop. The operator of a land-based wastewater treatment system must ensure that all aspects of the system are properly operated and maintained.

Soil and crops must be protected so that continued use of the receiver site is ensured. Surface and groundwater must be protected to ensure the integrity of these resources. Sites must be protected from poor field operations that destroy soil structure. They must also be protected from over-application of metals, nutrients, salts, and other waste constituents that can adversely affect the soil/plant system.

This chapter discusses three important aspects of proper waste application:

- irrigation scheduling
- soil, plant, wastewater, and groundwater sampling
- operation and maintenance of system components and site management

### *5.1. Irrigation Scheduling*

Proper land application of wastewater involves the use of water management strategies to ensure that wastewater is applied at the proper time and in the correct amounts. This involves achieving a balance between:

- maintaining adequate storage in the lagoon to handle extreme rainfall without overtopping
- applying wastewater at a rate and amount such that no direct surface runoff or deep percolation below the root zone occurs

- optimizing the timing of nutrient application to match crop uptake

It is not economically feasible to design a waste management system that can satisfy all three criteria one hundred percent of the time. Rather, design criteria have been established to achieve a balance between costs and the risk associated with an undesirable discharge. A responsible system operator must understand how wastewater should be managed, have knowledge of the capacity of the system to store and apply wastewater when appropriate, and be able to make prudent management decisions concerning when and how much wastewater to land apply.

For a liquid waste management system using surface irrigation, this decision-making process is called irrigation scheduling. Irrigation scheduling is the process of answering two basic questions:

- When to irrigate?
- How much to irrigate?

Effective scheduling requires knowledge about soil properties, soil-water relationships, the crop, climate, and application equipment. The purpose of this section is to discuss the interaction of these factors and how to incorporate them into an effective irrigation schedule to properly land apply wastewater. Keep in mind that maximum wastewater loadings are established by the facility permit and must never be exceeded. An operator must be familiar with these permitted amounts when planning irrigation events.

## Determining When to Irrigate

There are three basic questions that should be answered when deciding to irrigate treated wastewater:

1. Can the wastewater be applied to an actively growing crop (or will a crop be planted or actively start growing within 30 days?)
2. Is there a nutrient deficit remaining for this crop cycle for the limiting nutrient?
3. Are the land application fields dry enough to be irrigated?

If the answer to all three questions above is yes, then an irrigation event should be scheduled. The answer to Question 1 should be obvious to an operator. Question 2 requires knowledge of the amount of nutrients that should be applied and the amount that has already been applied, if it is a nutrient limiting system. This was addressed in Chapter 3 and will be discussed later in this chapter.

Determining the answer to Question 3, whether the field is “dry” enough to be irrigated, is not always obvious. It was mentioned earlier that soil saturation can be determined by observing free water in an auger hole. However, there are other methods of determining whether a soil is saturated or not. If the soil is not saturated, these methods can also be used to determine how “dry” the soil is:

1. a subjective method that involves “feeling” the soil
2. objective methods using soil-moisture measuring devices
3. an accounting approach (checkbook method) to estimate soil-water

## Basic Soil-Water Relationships

Remember from Chapter 3 that soil consists of soil particles and pore space and that pore space is filled with air, water, or both. When all the pore space is filled with water, the soil is saturated and cannot hold any more water (Figure 5-1). A portion of that water (the water that fills the macropores) will drain below the root zone due to gravity. This water is called **gravitational water**. Within 1 to 3 days, gravitational water will have drained from the soil. Because this happens so quickly, gravitational water is usually not available to plants. It leaves the root zone before plant roots can take it up.

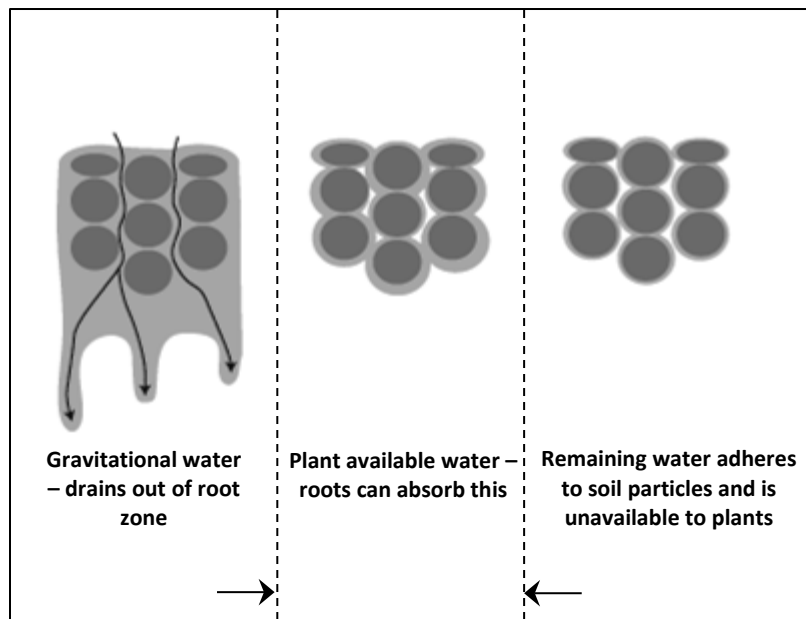

Figure 5-1. Soil particles showing three stages of water retention – saturation, wilting point, and field capacity.

After gravitational water has left the root zone, the macropores are now filled with air. The remaining water in the soil is held in the micropores. The micropores are small enough that the adhesive and cohesive forces holding the water to the pore wall are stronger than the gravitational force trying to drain the soil. Water held in the micropores at this point is called **plant available water** because plant roots can absorb it. The soil is said to be at **field capacity**.

As plants adsorb water from the soil, it becomes drier. At the same time, the soil loses more water due to evaporation from the soil surface. As the soil dries, the amount of plant available water

decreases. The initial response of plants is wilting. At the first onset of wilting (the temporary wilting point) most plants can recover during times of reduced evaporation (i.e., at night).

As the soil continues to dry, plants reach a point where they cannot recover during periods of reduced evaporation. The plants are now in a permanently wilted condition and will die if water is not provided. This point is termed the ***permanent wilting point***. The soil is not completely dry at this point, but the remaining water is held so closely by soil particles that it is not available for use by plants.

Plant available water content is the maximum amount of water a soil can make available to plants. Also called available water-holding capacity, it is defined as the difference between the water content at field capacity (referred to as the upper limit water content) and the water content at the permanent wilting point (referred to as the lower limit water content).

Irrigation should be scheduled to maintain the water content of the soil between these two extremes. If there is no plant available water deficit (i.e., the soil-water content is above the upper limit), gravitational water is present and wastewater irrigation should be delayed under normal operating conditions.

At the start of irrigation, the water content in the soil should be lower (drier) than field capacity (upper limit). The difference between the existing water content and the field capacity water content is the maximum amount that should be irrigated. The drier the soil, the more wastewater that can be safely applied per application, provided this amount does not exceed the required nutrient application rate or violate any permit conditions. Determining the water content of the soil tells you if the soil is dry enough to be irrigated and if so, how much wastewater can be applied.

## Estimating Soil-Water Content

There are three general methods for estimating the amount of water present in the soil:

- checkbook method
- soil moisture measurement devices
- feel method

One of these methods should be used to estimate the amount of water present in the soil at the start of irrigation.

### *Checkbook Method*

The checkbook method is an accounting approach for estimating how much soil-water remains in the effective root zone based on water inputs and outputs. It is much like keeping track of the daily balance on a bank account by monitoring deposits and withdrawals.

Wastewater irrigation is scheduled when the soil-water content in the root zone drops below a threshold level. Some of the simpler checkbook methods keep track of rainfall, evapotranspiration, and irrigation amounts. More sophisticated methods require periodic measurements of the soil-water status and moisture use rates of the crop.

Checkbook methods require detailed daily record keeping, which can become time consuming for the more complex methods. One of the advantages of the checkbook approach is that it can be managed using a computer program. Computer programs have been developed to handle the accounting and provide timely and precise scheduling recommendations. See NC State Extension publication AG-607, *Irrigation Scheduling to Achieve Proper Application of Wastewater*, for further information.

### *Soil Moisture Measurement Devices*

There are many methods or devices for measuring soil water. Many are too expensive or labor intensive for practical use in a wastewater irrigation system. They are used in more often research or in freshwater irrigation of crops to increase yields and profits. Tensiometers and granular matrix sensors offer the best combination of cost-effectiveness and reliability for measurement of soil water for wastewater irrigation in North Carolina.

A **tensiometer** is a sealed, airtight, water-filled tube with a porous tip on one end and a vacuum gauge on the other (Figure 5-2). Tensiometers do not measure how much water is left in the soil. Instead, they measure how tightly water is held to the soil particles and the tension or suction that plant roots must exert to extract water from the soil.

This tension is a direct measure of the availability of water to a plant. A sandy soil will reach a high tension sooner than a clay loam because sandy soils cannot supply as much water to the plant and it is used up more quickly. Tensiometers do not operate in dry soil because the pores in the ceramic tip drain and air is sucked in through them breaking the vacuum seal between the soil and the gauge on top of the tensiometer. Tensiometers are best suited for sandy, sandy loam, and loamy soil textures.

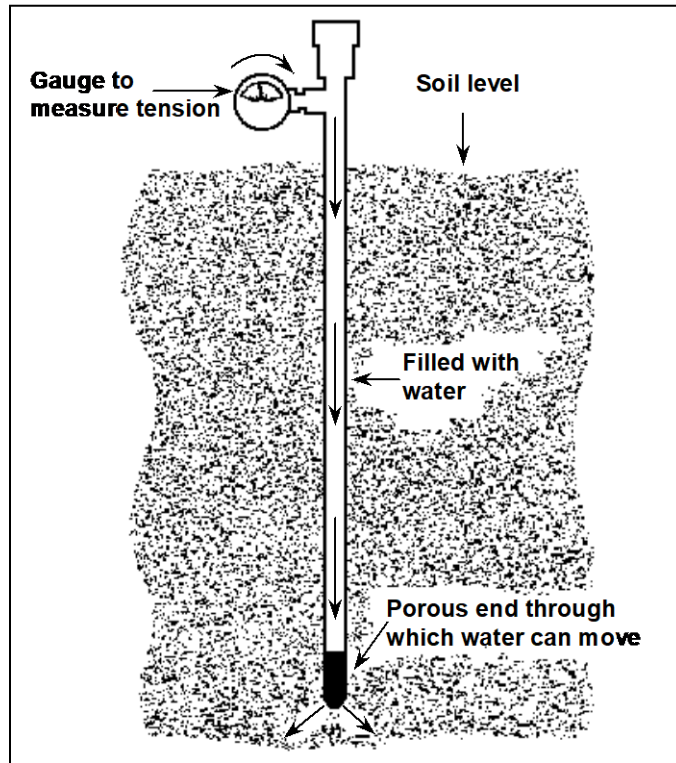

Figure 5-2. Tensiometer method of determining soil-water content.

**Granular matrix sensors** are an indirect method of measuring soil water tension. The sensor consists of two corrosion resistant electrodes embedded in a porous material, surrounded by a synthetic membrane and a protective stainless steel mesh (Figure 5-3).

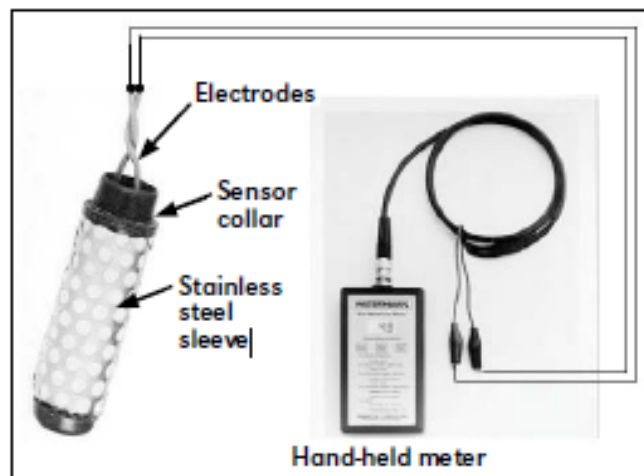

Figure 5-3. Granular matrix sensor and meter.

These sensors work on the principle that water conducts electricity. Movement of water between the soil and the sensor results in changes in electrical resistance between the electrodes in the sensor. Electrical resistance increases as soil water suction increases, or as soil moisture decreases. Electrical resistance decreases as soil water suction decreases, or as soil moisture increases. Compact, easily installed, and low maintenance, granular matrix sensors are relatively inexpensive. They work best in silty and clayey soils.

Both devices will provide more accurate results if you calibrate them for the major soils you are irrigating. For irrigating wastewater, you will get better results if all soil-water measuring devices you use are calibrated for the major soils you are irrigating. Manufacturers provide calibration charts and recommended ranges for traditional “fresh” water irrigation.

Keep in mind that they were developed for general conditions and may not adequate for wastewater irrigation on specific fields and soil conditions. Calibration procedures for soil-water measuring devices are outlined in Extension Publication AG-452-3: Calibrating Soil-Water Measuring Devices (Appendix B-2).

### *Feel Method*

The feel method involves estimating soil-water by feeling the soil. This method is easy to use, and many operators schedule irrigation this way. This method is subjective since the results depend on the experience of the person doing the measurement. Therefore, the value of this method depends on the experience of the operator. Table 5-1 gives some guidelines for estimating soil-water content by the feel method.

The feel method is demonstrated in the following example. Suppose your irrigation field is a sandy loam soil with a 15-inch root zone. You feel the soil and observe that it forms a weak ball which falls apart. Based on the guidelines given in Table 5-1, you can irrigate 0.3 to 0.4 inches of water per foot of root zone depth. For a 15-inch (1.25 feet) root zone depth, the permissible irrigation amount is:

$$0.38 \text{ in } (0.3 \text{ in/ft} \times 1.25 \text{ ft}) \text{ to } 0.5 \text{ in } (0.4 \text{ in/ft} \times 1.25 \text{ ft})$$

## Determining How Much to Irrigate

For systems that are not nutrient limited, the amount of wastewater that can or should be applied during any single irrigation cycle is dictated by how much water the soil can “soak up.” This varies from day to day and is influenced by:

- **rainfall** - when and how much it last rained
- **crop maturity** - water uptake rate of the crop
- **soil type** - texture, structure, depth, and cover
- **effective root depth**
- **evapotranspiration** - which is influenced by temperature, wind, and relative humidity

Table 5-1. "Feel" guidelines for Estimating the Amount of Plant-Available Water to be Replaced with Wastewater Irrigation as a function of soil texture.

<b>Available Water Remaining in the Soil</b>	<b>Sands Loamy Sand</b>	<b>Sandy Loam</b>	<b>Clay, Clay Loam, Sandy Clay Loam</b>	<b>All Other Textures</b>
<b>Maximum Recommended Wastewater Irrigation (per foot of effective root zone depth)</b>				
100% (i.e., field capacity)	When ball is squeezed, no free water appears on soil but wet outline of ball is left in hand			
<b>Wastewater Irrigation</b>	None	None	None	None
75% to 100%	Sticks together only slightly	Forms a ball that breaks easily	Forms a ball; very pliable	Easily ribbons between thumb and forefinger; feels slick
<b>Wastewater Irrigation</b>	0.1 to 0.2 inch	0.2 to 0.3 inch	0.2 to 0.4 inch	0.2 to 0.4 inch
50% to 75%	Appears dry, will not form a ball	Forms weak ball which falls apart	Forms ball; slightly plastic; slightly slick	Forms ball; forms ribbon
<b>Wastewater Irrigation</b>	0.2 to 0.3 inch	0.3 to 0.4 inch	0.3 to 0.5 inch	0.3 to 0.6 inch
25% to 50%	Appears dry, will not form a ball	Appears dry, will not form a ball	Somewhat crumbly but holds under pressure	Forms ball under pressure; somewhat pliable
<b>Wastewater Irrigation</b>	0.3 to 0.5 inch	0.3 to 0.6 inch	0.3 to 0.6 inch	0.3 to 0.7 inch
0 to 25%	Dry, loose, single-grained, flows through fingers	Dry, loose, flows through fingers	Powdery, dry; easily breaks into powdery condition	Hard, cracked; may have loose crumbs on soil surface
<b>Wastewater Irrigation</b>	0.3 to 0.5 inch	0.3 to 0.6 inch	0.3 to 0.7 inch	0.3 to 0.7 inch



Wastewater irrigation should replace the water that has evaporated from the soil or been removed by plants. This is referred to as the plant-available water deficit. Most water taken up by plants is removed in the upper half of the root zone. For the purpose of scheduling irrigation, this zone is referred to as the effective root depth.

Soil conditions in North Carolina limit maximum rooting depths of most crops to 24 to 36 inches so that the effective root depth is typically only 12 to 18 inches. It is within this depth that we estimate or measure the plant available water deficit to be replaced by irrigation. If the irrigation volume applied exceeds the PAW deficit, the excess either runs off or leaches below the root zone and could potentially contaminate groundwater.

Therefore, irrigation should be scheduled and timed so that:

- no surface runoff occurs during irrigation;
- the root zone is not completely saturated at the conclusion of irrigation; and
- leaching of the irrigated water below the root zone is minimized.

Soil texture influences the portion of the soil pore volume that can be occupied by gravitational water or plant-available water; therefore, it is important to know the soil texture to determine how much water can be irrigated. Estimates of plant available water for various soil textural classes are given in published soil survey reports. These estimates range from less than 0.2 inch of PAW per foot of soil for coarse sandy soils to nearly 2 inches of plant available water per foot of soil for silty clay and clay soils (Table 5-1).

Wastewater irrigation objectives and recommendations are different from fresh water recommendations. When irrigating with fresh water, the objective is to keep the soil moist for optimum growing conditions. Depending on the nutrient content of the wastewater, it may not be appropriate to apply all of the water needed by the crop from wastewater during dry periods. The deciding factor is the nutrient content of the wastewater.

If the soil is completely dry, the plant-available water deficit would be the value shown in Table 5-2. In reality, the soil is rarely completely dry so that the amount to be replaced will be less than the values shown. At any given time, the plant-available water deficit could range from none to the maximum values shown in Table 5-2.

Highly concentrated waste, such as from animal operations, may only allow 2 to 5 inches of wastewater be applied during the entire growing season. Less concentrated waste allows for more water additions. Treated municipal wastewater typically contains less than 30 ppm total nitrogen. At this low concentration, wastewater application rates are usually hydraulically limited rather than nutrient limited. As much as 50 or more inches of wastewater may need to be applied to achieve the nutrient requirements of the crop. In this case, freshwater requirements of the crop can be applied from the dilute wastewater.

Table 5-2. Average Estimated Plant-Available Water for Various Soil Textural Classes.

Textural Class	Plant-Available Water inches of water per foot of soil	Maximum Recommended
		Application Depth
Coarse sand and gravel	0.2 to 0.6	0.2
Sand	0.5 to 1.0	0.4
Loamy sand	0.8 to 1.5	0.6
Sandy loam	1.0 to 1.8	0.7
Loams	1.3 to 2.0	0.8
Silt loam	1.3 to 2.2	0.8
Silty clay loam	1.3 to 1.8	0.8
Clay loam	1.1 to 1.9	0.8
Sandy clay loam	1.1 to 1.8	0.8
Silty clay	1.2 to 1.9	0.8
Clay	1.2 to 1.9	0.8

However, even with dilute wastewater, it is generally NOT recommended to apply more than 1 inch of wastewater irrigation during any single irrigation cycle. Even this amount may be too high for some soils. This is because a large amount of the applied wastewater may leach below the root zone of the crop, bypassing the opportunity for nutrients contained in the wastewater to be utilized by the crop. Table 5-2 shows maximum recommended wastewater irrigation amounts as influenced by soil texture.

Another factor affecting irrigation amount is the infiltration rate. Remember from Chapter 3 that the infiltration rate is the rate that the soil can “soak up” the irrigated wastewater. The infiltration rate decreases the longer water is applied. The intake capacity of most clayey or silty soils begins to be exceeded by the time 0.5 to 0.6 inch has been applied. Continuing to irrigate could result in surface ponding and possible runoff of the irrigated wastewater, which is a water quality violation that could result in penalties or fines.

Infiltration rate is also dependent on the crop type and thickness of the stand and slope of the land. Some typical ranges for various soil textures are shown in Table 5-3. Application rates in excess of these values could result in ponding and runoff.

Sandy soils have high infiltration capacity and runoff is not much of a concern. But, sandy soils also have low plant-available water-holding capacity. For example, consider a Lakeland sand that has only 0.5 inch of plant-available water per foot of soil depth. For an effective root depth of 1.5 feet, the maximum plant-available water deficit is only 0.75 inch.

$$1.5 \text{ ft} \times 0.5 \text{ in PAW/ft} = 0.75 \text{ inch PAW}$$

For this example, if the application amount during any single irrigation cycle exceeds 0.75 inch, some of the applied wastewater will leach below the root zone and potentially pollute groundwater.

Table 5-3. Approximate Water Infiltration Rates for Various Soil Texture and Slopes.

	Slope		
	0 to 3%	3% to 9%	9+%
	inches per hour		
Sands	>1.00	>0.70	>0.50
Loamy sands	0.70 to 1.00	0.50 to 1.00	0.40 to 0.70
Sandy loams and fine sandy loams	0.50 to 1.00	0.40 to 0.70	0.30 to 0.50
Loams and silt loams	0.30 to 0.70	0.20 to 0.50	0.15 to 0.30
Sandy clay loams and silty clay loams	0.20 to 0.40	0.15 to 0.25	0.10 to 0.15
Clays, sandy clays, and silty clays	0.10 to 0.20	0.10 to 0.15	<0.10

*Source: Sprinkler Irrigation Association Journal. For poor vegetative cover or surface soil conditions, actual rates may be as much as 50 percent less than shown.*

Taking all of the above factors into account, recommended wastewater irrigation amounts for a single irrigation cycle are in the range of 0.25 to 0.75 inch per foot of effective root zone depth. There may be occasions when the appropriate irrigation amount falls outside this range such as when irrigation must occur during cold periods when potential evapotranspiration is low, when the soil has an unusually deep root zone providing a greater amount of plant available water storage, or to satisfy emergency action guidelines. But, these situations are exceptions and should not occur on a regular or frequent basis.

Regardless of the calculated rate, the system operator should monitor each waste application to verify adequate infiltration of the waste into the soil. An irrigation cycle should be stopped if ponding and runoff start to occur. Rarely will the “practical” irrigation amount as influenced by the various factors discussed in this chapter equal the “permitted” amount.

Permitted amounts typically establish the upper limit under best case scenarios and are established to give the operator the flexibility to irrigate the maximum possible under ideal conditions. In reality, conditions are rarely ideal on a day to day basis. The operator must consider and incorporate site, crop, soil and climatic factors into the daily irrigation strategy.

## Delivering Desired Rates

A key part of the irrigation design is to select the proper combination of system components so that the system precipitation rate does not exceed the infiltration rate of the soil. Knowledge of the system design is important for day-to-day irrigation scheduling. Several terms may be used to express the rate at which water is being applied to a field during irrigation. Terms you should be familiar with include discharge rate, coverage (or wetted) diameter, precipitation rate, and application depth.

**Discharge rate** is the volume of water exiting a sprinkler per unit of time and is normally expressed in terms of gallons per minute (gpm). Also called sprinkler flow rate, the discharge rate of a sprinkler depends on operating pressure and nozzle size. Manufacturers publish discharge rates for their sprinklers and you should always have a copy for the sprinklers on your system.

Along with discharge rate, manufacturers also publish coverage diameter (or wetted diameter). **Coverage diameter** is the maximum diameter wetted by a sprinkler based on nozzle size and operating pressure.

Discharge characteristics for three typical sprinklers used for wastewater irrigation are given in Table 5-4. For example, a Rainbird Model 70 sprinkler operated at 55 PSI with a 9/32-inch diameter nozzle has a discharge rate of 17.2 gpm.

Table 5-4. Discharge Characteristics for Rotary Impact Sprinklers Used with Permanent Stationary Irrigation System

Nozzle Size (inch)	Operating Pressure (PSI)					
	50		55		60	
	Flow GPM	Diameter FT	Flow GPM	Diameter FT	Flow GPM	Diameter FT
<b>Nelson F70APV</b>						
1/4	12.8	128	13.6	131	14.0	134
9/32	16.0	134	16.8	137	17.6	140
<b>Rain Bird 70 CWH</b>						
1/4	12.9	124	13.6	126	14.2	128
9/32	16.3	131	17.2	133	18.0	135
<b>Senniger 7025 RD-1-DFP</b>						
1/4	13.0	127	13.6	131	14.2	138
9/32	16.3	133	17.1	137	17.8	142

Discharge characteristics for typical big guns are shown in Table 5-5. For contrast, notice how much higher discharge rates are for the gun sprinklers than the rotary impact sprinklers.

**Precipitation rate** is the volume of water exiting a sprinkler per unit time. It is normally expressed as inches per hour (in/hr). The precipitation rate of a sprinkler depends upon discharge rate and coverage diameter.

**Total application volume (or depth)** is the depth of water in inches for an irrigation event. It is based on the length of time a system operates at a given precipitation rate on a given field.

When irrigating, it is often preferable to express irrigation amounts as an equivalent depth of water, for example, 1/2 inch. Therefore, it is often necessary to convert between application volume expressed as gallons per acre and application depth expressed as inches.

Table 5-5. General Flow Rates and Coverage Diameter for Big Gun Sprinklers

<b>Taper Bore Nozzle</b>										
<b>Gun Model</b>										
<b>Nozzle Diameter (inch)</b>										
Pressure	0.5		0.75		1.0		1.5		2.00	
PSI	GPM	DIA	GPM	DIA	GPM	DIA	GPM	DIA	GPM	DIA
50	50	205	115	260	205	310	—	—	—	—
60	55	215	126	275	225	325	515	430	912	512
70	60	225	137	290	245	340	555	450	980	528
80	64	235	146	300	260	355	590	470	1047	548
90	68	245	155	310	275	365	625	485	1105	568
100	72	255	164	320	290	375	660	500	1167	592
110	76	265	172	330	305	385	695	515	1220	607
120	—	—	180	340	320	395	725	530	1277	622

<b>Ring Type Nozzle</b>										
<b>Gun Model</b>										
<b>Nozzle Diameter (inch)</b>										
Pressure	0.71		0.86		0.97		1.56		2.00	
PSI	GPM	DIA	GPM	DIA	GPM	DIA	GPM	DIA	GPM	DIA
50	74	220	100	245	130	265	350	370	640	435
60	81	235	110	260	143	280	385	390	695	455
70	88	245	120	270	155	290	415	405	755	475
80	94	255	128	280	165	300	445	420	805	490
90	99	265	135	290	175	310	475	435	855	505
100	105	270	143	300	185	320	500	445	900	520
110	110	275	150	310	195	330	525	455	945	535
120	-	-	157	315	204	335	545	465	985	545

You should remember that one inch of water over an acre, referred to as acre-inch, is equal to 27,152 gallons.

Another helpful conversion is  $1\text{mg/L} = 1\text{ppm} = 0.226\text{ lbs/ac-in.}$

## Stationary Sprinkler Systems

Application volumes are higher near the sprinkler and gradually decrease with distance from the sprinkler. To attain acceptable application uniformity, stationary sprinklers are typically arranged in a square pattern at a spacing of 50 to 65 percent of the wetted diameter. A typical layout for stationary sprinklers is shown in Figure 5-5.

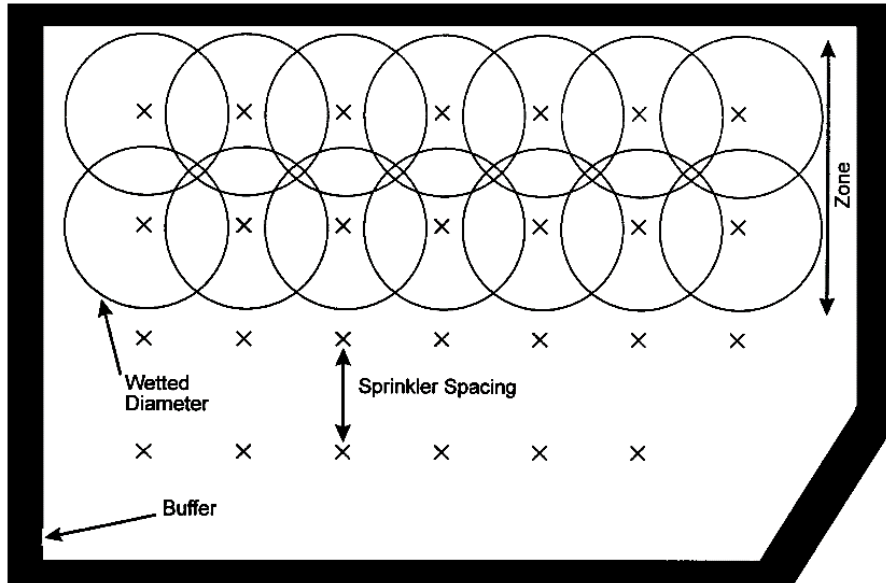

Figure 5-5. Typical layout of a stationary sprinkler system. Sprinkler spacing is typically 50 to 65% of wetted diameter.

### *Precipitation Rate for Stationary Sprinklers*

The precipitation rate calculated by converting the discharge rate (gpm) to a unit depth of water (inch) per unit time (hr) and dividing by the wetted area of the sprinkler. The formula is:

$$\text{Precipitation rate (in/hr)} = \frac{96.3 \times \text{discharge rate (gpm)}}{\text{sprinkler spacing (ft)} \times \text{lateral spacing (ft)}}$$

The precipitation rate of the sprinkler should be less than the infiltration rate of the soil as given in Table 5-2.

### *Application Volume for Stationary Sprinklers*

Once you know the precipitation rate for a stationary sprinkler system, you can calculate the application volume based on the time you operate the system using this formula:

$$\text{Application volume (in)} = \text{precipitation rate (in/hr)} \times \text{time of operation (hr)}$$

### *Time of Operation for Stationary Sprinklers*

Most of the time, however, you will estimate the target application volume based on the soil conditions we discussed earlier. If this is the case, then what you *really* want to know is long you need to operate the system to deliver the desired application volume.

If you rearrange the above equation, time of operation becomes the unknown value which you can then calculate:

$$\text{Time of Operation (hours)} = \frac{\text{target application depth (in)}}{\text{precipitation rate (in/hr)}}$$

### Traveling Gun Systems

As we learned in Chapter 4, the distance between adjacent pulls is referred to as the lane spacing. To provide proper overlap, the lane spacing is normally 70 to 80% of the gun wetted diameter. Operating pressures range from 50 to 80 psi. A typical layout for a hard-hose traveler irrigation system is shown in Figure 5-6.

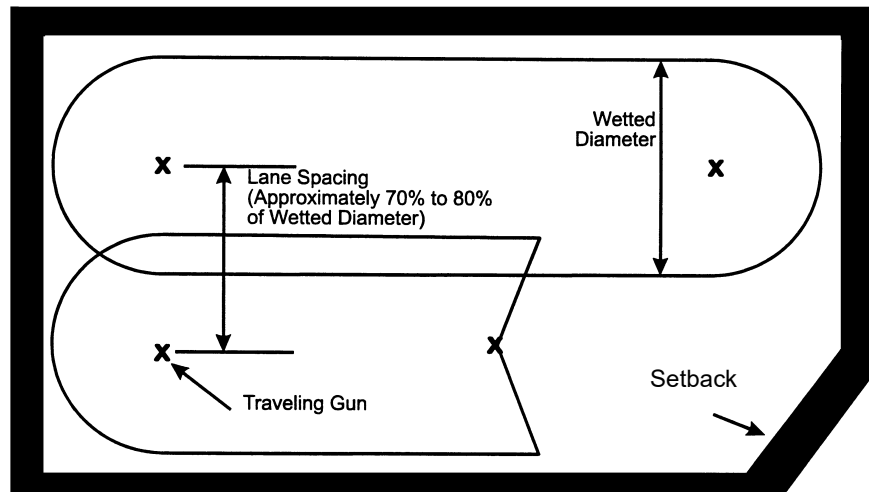

Figure 5-6. Typical layout of a traveling gun system. Lane spacing is typically 70 – 80% of wetted diameter.

### *Precipitation Rates for Traveling Gun Sprinklers*

The precipitation rate in inches per hour for a traveling gun sprinkler is generally not affected by travel speed. This situation occurs because at any given position within the wetted diameter, water is usually being applied for at least an hour or longer. The precipitation rate is affected by

the angle of rotation of the gun sprinkler. In practice, the angle of rotation is typically in the range of 315 to 330 degrees.

The precipitation rate for a traveling gun sprinkler increases rapidly as the angle of rotation decreases. Since the infiltration capacity of many soils is less than 0.5 inch per hour, it is important that the gun sprinkler rotate as much of a full circle as possible so that the precipitation rate does not exceed the infiltration capacity of the soil.

### *Application Depth for a Traveling Gun Sprinkler*

The application depth applied by a traveling gun depends on the sprinkler discharge rate, lane spacing, and travel speed.

The application depth is calculated by the formula:

$$\text{Application depth (in)} = \frac{19.3 \times \text{sprinkler discharge rate (gpm)}}{\text{lane spacing (ft)} \times \text{travel speed (in/min)}}$$

### *Travel Speed for a Traveling Gun Sprinkler*

As with stationary sprinklers, however, you will often estimate the target application depth based on soil conditions. If this is the case, then what you *really* want to know is how fast or slow the gun cart needs to travel to deliver the desired application depth.

If you rearrange the above equation, travel speed becomes the unknown value which you can then calculate using this formula:

$$\text{Travel speed (in/min)} = \frac{19.3 \times \text{sprinkler discharge rate (gpm)}}{\text{lane spacing (ft)} \times \text{application depth (in)}}$$

Traveling gun units often have manufacturing charts showing which combination of settings will result in a certain travel speed. However, you should always verify travel speed by measuring hose retrieval speed on the ground.

## Center Pivot and Linear Move Systems

Center pivot and linear move systems come in a variety of designs and with many operational considerations. The newer models use a controller device that allows the operator to set application rates, and to vary application rates based on field variability or crop types over which



the system is run. Since these systems are able to cover a large area, the sprinkler components are typically designed and installed for each individual situation. Therefore, there is no standard formula to determine the precipitation rate or travel speed for these systems. The manufacturer's literature will explain the settings to achieve desired precipitation rates and volumes. Like any other type of irrigation equipment, it should be field calibrated periodically to verify that field application rates are consistent with manufacturer's design.

## System Calibration

Information presented in manufacturers' charts is based on average operating conditions with relatively new equipment. Discharge rates and application rates change over time as equipment gets older and components wear. In particular, pump wear tends to reduce operating pressure and flow. With continued use, nozzle wear results in an increase in the nozzle opening which will increase the discharge rate while decreasing the wetted diameter.

You should be aware that operating the system differently than assumed in the design will alter the application rate, diameter of coverage, and subsequently the application uniformity. Operating *above* design pressure can result in:

- excessive wear of components;
- smaller droplets and increased drift;
- possibility of applying into setbacks due to increased coverage diameter; and
- decreased application uniformity.

Operating *below* design pressure can result in:

- decreased coverage diameter,
- decreased application uniformity.

There are several methods of calibrating surface irrigation equipment. The NCSU publications listed below were developed for calibrating liquid animal waste irrigation equipment, but can also be used to calibrate these types of equipment when irrigating wastewater.

Publications AG-553-1, AG-553-2, and AG-553-3 describe what are commonly referred to as "catch can" methods. A more recent publication (AG-553-09) describes another method for calibrating stationary and traveling irrigation equipment that involves field verification of (1) operating pressure; (2) wetted diameter; (3) flow rate; and (4) application uniformity.

These calibration publications can be downloaded from NCSU's website (<https://irrigation.wordpress.ncsu.edu/animal-waste-and-wastewater-irrigation/>):

- Calibration and Uniformity Assessment for Stationary and Traveling Irrigation Systems, AG-553-09
- Irrigated Acreage Determination for Stationary Irrigation Systems, AG-553-6

- Irrigated Acreage Determination for Hard Hose Traveler Irrigation Systems, AG- 553-7
- Field Calibration Procedures for Stationary Irrigation Systems, AG-553-1
- Field Calibration Procedures for Hard Hose and Cable Tow Irrigation Systems, AG-553-2
- Field Calibration Procedures for Center Pivot and Linear Move Irrigation Systems, AG-553-3

## Summary of Irrigation Scheduling

In this section, you have been introduced to a number of soil-water terms and irrigation formulas used to help determine how to properly apply wastewater. The use of these terms and formulas requires that you know the following items about your system and land application site:

- Soil types and infiltration rates by field.
- Weekly and annual irrigation depths.
- Soil-water relationships and properties.
- Acreage of each field to receive waste applications.
- Type and specifications of waste application equipment, including:
  - operating pressure;
  - nozzle diameter;
  - flow or delivery rate in gpm per sprinkler;
  - diameter of throw of sprinkler;
  - travel speed settings for traveling equipment; and
  - number of sprinklers.

With the information presented in this section, you can make the calculations that will allow you to properly operate your waste application equipment so that wastewater is applied without surface runoff and agronomic rates are not exceeded.

## 5.2 *Sampling*

Another important facet of proper system operation is sampling. Most surface irrigation system permits require soil, plant tissue, effluent and groundwater analyses. If such monitoring is required, the system permit will specify which parameters to monitor, when to monitor, and when results must be submitted. Although such sampling may not be required by every permit, all surface irrigation system operators should have a basic understanding of the different types of analyses available, proper sampling techniques, and how to interpret sample results.

### Soil Sampling

It is not possible to look at a soil and predict if the soil is too acid or if there are proper amounts of the essential nutrients present. Soils in North Carolina vary in their need for lime and other nutrients, depending on soil characteristics, previous fertilization levels, and nutrient

requirements of the crop. Therefore, periodic soil sampling is recommended, even if the system's permit does not require it.

The goal of soil testing is to find out enough about the soil to provide economically and environmentally sound nutrient and lime recommendations. Soil testing is not a perfect science, but it provides the most reasonable approach for operators to assess soil pH and plant-available nutrients, to determine the need for lime and fertilizers, and to avoid losses and environmental damage from improper lime and fertilization practices.

The NCDA&CS' Agronomic Services Division analyzes soil samples, plant, solution and irrigation water samples, and animal, municipal and industrial wastes. Recommendations made by these services are designed to improve production efficiency and protect natural resources. Thirteen agronomists provide on-site consultations across the state to help farmers and operators solve field problems and implement recommendations.

Sampling instructions, information sheets, and boxes are provided at no charge and can be obtained from county Cooperative Extension Service centers, from Regional Agronomists of the Agronomic Division, and from many businesses selling lime or fertilizer. Samples and completed information sheets should be sent to the Agronomic Division, NCDA & CS, 4300 Reedy Creek Road, Raleigh, NC 27607-6465.

However, it is important to note that your permit may require that you use a private North Carolina certified laboratory to satisfy monitoring requirements rather than the NCDA & CS Agronomic Laboratory.

The following discussion of where, when and how to take and submit soil samples is taken from SoilFacts: Careful Soil Sampling (North Carolina Cooperative Extension Service Publication Number AG-439-30).

### *Where to Take Samples*

Every soil sample you submit for testing should consist of about 15 to 20 cores taken at random locations throughout one field or area. A sample should include cores from no more than about 20 acres even if the soil appears to be uniform over a larger area.

Keep in mind that each sample should represent only one general soil type or condition. If the field you are sampling contains areas that are obviously different in slope, color, drainage, and texture and if those areas can be fertilized separately, submit a separate sample (consisting of 15 to 20 cores) for each area (Figure 5-7).

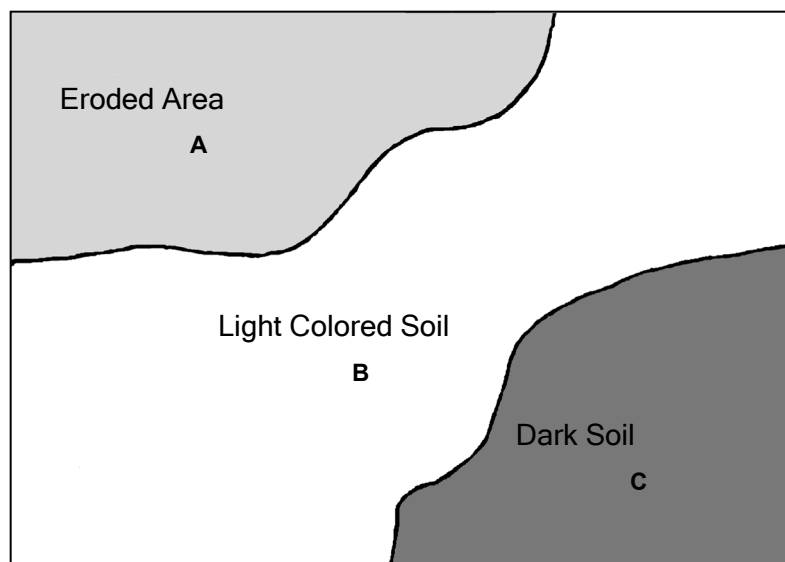

Figure 5-7. Within each field, collect a separate sample from each area that has a different type of soil.

When collecting samples, avoid small areas where the soil conditions are obviously different from those in the rest of the field—for example, wet spots, old manure and urine spots, places where wood piles have been burned, severely eroded areas, old building sites, fence rows, spoil banks, and burn-row areas. Also avoid the fertilizer bands in fields where row crops have been grown. Because samples taken from these locations would not be typical of the soil in the rest of the field, including them could produce misleading results.

Areas within a field where different crops have been grown in the past should be sampled separately, even if you now plan to grow the same crop in the whole field. Areas that have been limed and fertilized differently from the rest of the field should also be sampled separately.

### *Sampling Problem Areas*

In fields or areas where fertility problems appear to be the cause of abnormal crop growth, samples should be collected in a somewhat different way from samples used for routine testing. At the same time you collect topsoil samples, collect subsoil samples at a depth from 8 to 16 inches, but keep the two types of samples separate.

Follow the guidelines for collecting a good, representative sample, taking cores at random locations throughout the problem area even though it may be relatively small. At the same time, collect a representative sample from normal areas of the same field. More detailed information on collecting samples from problem areas is given in form AD2, “Problem Area Soil Sample Information” (see Appendix B-3).

### *When to Take Samples*

Collect samples three to six months before planting time. You will then have the test report in time to plan your liming and fertilization program before the busy planting season. If you submit samples immediately after harvest in the fall, you are likely to receive the results promptly because the laboratory workload is lighter at that time than in the spring. If possible, try to collect your samples at the same time every year.

Do not collect samples when the soil is too wet because it will be difficult to mix the cores. As a rule, if the soil is too wet to plow, it is too wet to sample.

Sample the soil from perennial or sod-crop areas three to four months before establishing the crop or applying lime or fertilizer.

### *How Often to Sample*

If the system permit requires soil sampling, the sampling frequency will be established in the permit and must be strictly followed. Otherwise, if your waste application system is in the coastal plain region, it is best to test the soil every two to three years. The sandy soils in that region do not hold nutrients as long as soils in the other parts of the state and are more apt to become acid through the addition of nitrogen. The nutrient levels in the silt and clay loam soils of the piedmont and mountain regions change less rapidly with lime and fertilizer applications. In these areas, soil testing once every four years is usually sufficient.

A good plan is to sample one-third to one-half of your fields each year if your system is in the coastal plains region and one-fourth of your fields each year if you are in the piedmont or mountain regions.

### *How to Collect a Good Sample*

Collect your samples with stainless steel or chrome-plated sampling tools and plastic buckets to avoid contaminating the samples with traces of chemical elements (micronutrients) from the sampling tools. Avoid brass, bronze, or galvanized tools.

Make sure that the buckets and sampling tools are clean and free of lime and fertilizer residues. Even a small amount of lime or fertilizer transferred from the sampling tools to the soil can seriously contaminate the sample and produce inaccurate results.

For areas in which field crops are grown, collect samples to the same depth that the field is plowed (6 - 8 inches) because this is the zone in which lime and fertilizer have been incorporated (see Figure 5-8).

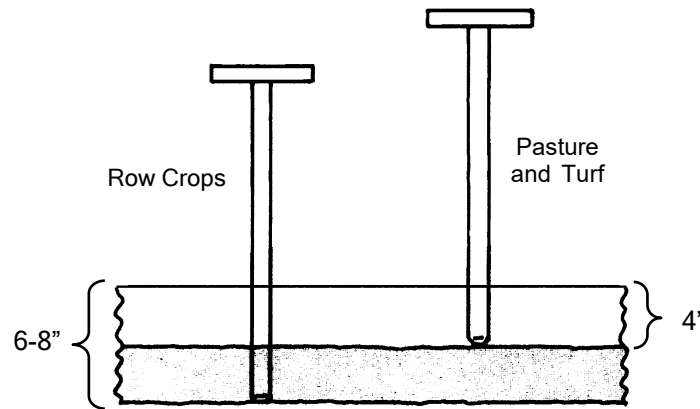

Figure 5-8. Sample to a depth of 6-8 inches in fields plowed for row crops and 4 inches where perennial pasture or turf crops are grown.

For fields where perennial crops such as fescue, alfalfa, and turf are being maintained, samples taken to a depth of 4 inches will best represent the crop's lime and fertilizer needs. Where these perennial crops are to be established however, sample to the regular plow depth. For more detailed instructions on soil sampling basics, see Appendix B-3.

### *Submitting the Sample*

If your soil samples are to be analyzed by the Agronomic Division of the NCDA & CS, each sample must be submitted in a standard soil sample box and accompanied by a completed copy of form AD-1, "Soil Sample Information" (Figure 5-9 and Appendix B-3).

Submit your samples only in the standard boxes provided by NCDA & CS. Samples sent in bags or other containers will not be compatible with the processing system used in the laboratory. Do not put a plastic bag inside the sample box. Seal the shipping box if the soil samples are from a quarantined area.

The 15- to 20-core sample you have collected will most likely be more soil than the box will hold. Before filling the box, pulverize the cores and mix them thoroughly in the bucket. Then fill the sample box about two-thirds full with this mixture.

Form AD-1 (April 2015)

### SOIL SAMPLE INFORMATION — N.C. Soil Only

**ROUTINE/PREDICTIVE SAMPLES**  
 April – Thanksgiving: no fee  
 December – March: \$4 / sample  
 Check online for exact dates.

NCD&CS Agronomic Division Soil Testing Section  
 Mailing Address: 1040 Mail Service Center, Raleigh NC 27699-1040  
 Physical Address (UPS/FedEx): 4300 Reedy Creek Road, Raleigh NC 27607  
 Phone: (919) 733-2655 Website: www.ncagr.gov/agronomi



For laboratory results, go to [www.ncagr.gov/agronomi/pals](http://www.ncagr.gov/agronomi/pals).

SAMPLE INFORMATION	PAYMENT	GROWER INFORMATION <i>(please print legibly)</i>		CONSULTANT/OTHER RECIPIENT			
FARM ID <i>(optional)</i>	FEE TOTAL _____ METHOD OF PAYMENT _____ ESCROW ACCOUNT ONLY _____ <i>(write account name below)</i>	LAST NAME	FIRST NAME	LAST NAME	FIRST NAME		
SAMPLE DATE <i>(optional)</i>		ADDRESS (in N.C. where samples were collected)		ADDRESS			
NC COUNTY <i>(where collected)</i>	<b>Reminders</b> Use NCD&CS sample boxes only. Fill to red line. Bags not accepted. Select crop code(s) from list on back of form.	CITY	STATE	ZIP	CITY	STATE	ZIP
NUMBER OF SAMPLES		NC		E-MAIL ADDRESS		E-MAIL ADDRESS	
		PHONE	PALS # _____ <i>(if known)</i>	PHONE	PALS # _____ <i>(if known)</i>		

By submitting this form to the NCD&CS Agronomic Division, I attest that the accompanying samples were collected in North Carolina.

LAB NUMBER <i>(Leave blank)</i>	SAMPLE IDENTIFICATION	LIME APPLIED WITHIN PAST 12 MONTHS			You must specify a crop CODE to receive a recommendation (see reverse side of form)			
		Tons/Acre	Month	Year	FIRST CROP	CODE	SECOND CROP	CODE
1								
2								
3								
4								
5								
6								
7								
8								
9								
10								

*Thank you for using agronomic services to manage nutrients and safeguard environmental quality. — Steve Troxler, Commissioner of Agriculture*

Figure 5-9. Soil Sample Information Sheet, page one.

Label the box with the code you have assigned to the area sample. Please note that the identification can consist of no more than three numbers, letters, or a combination of the two. Directions for filling out the soil information sheet are printed on the back of the form (Figure 5-10). To get the most value from your soil test, take the time to fill in the blanks completely and be sure to list the crop or crops to be grown. Also check to make sure that the code you put on the form corresponds to the code on the sample box and the site map. Mail the completed form with the sample box, keeping a copy for your future reference. See Appendix B-3 for more detailed information on packing samples for shipment.

### Taking a Soil Sample

*A soil test is only as good as the soil sample!*

Use iron or stainless steel tools. Sample dry soil in areas of 10 acres or fewer. Avoid combining soils of different types and/or treatment histories. Avoid fertilizer bands and corners or end-run areas. For each sample, collect 15–20 cores at the appropriate depth (0–8" for plowed soils; 0–4" for no-till, sod & lawns). Mix cores in a plastic bucket, then fill the sample box.  
**DO NOT PUT SOIL IN PLASTIC BAGS.**

### Filling out the Sample Information Form

LAB NUMBER (Leave blank)	SAMPLE IDENTIFICATION	LIME APPLIED WITHIN PAST 12 MONTHS			FIRST CROP	CODE	SECOND CROP	CODE
		Tons/Acre	Month	Year				
1	J   J   1	1	9	2012	Corn	001	Small Grain	004
2	J   J   S   1	2	9	2012	Clover / Grass, M	050	Clover / Grass, M	050
3	J   J   S   2	0			Bermuda Hay, E	043	Bermuda Hay, M	044

**REQUIRED INFORMATION**  
The lab **MUST** have this information.

**DESIRABLE INFORMATION**  
The lab can make better suggestions if this information is provided.

**SAMPLE & GROWER INFORMATION** — Provide as much information as possible. Print neatly.

**CONSULTANT/OTHER RECIPIENT** — List name & contact information for anyone else who needs to know about the report.

**SAMPLE IDENTIFICATION** — Print an identifier (use numbers and/or letters) for each sample on a separate line. The identifier should help remind you where the sample came from (Example: J1, S1). Make sure the sample identifiers on the boxes and on the information form are the same. Use pencil or waterproof markers.

**FIRST CROP** — List the crop for which you want lime and fertilizer recommendations. Be sure to include the appropriate CODE from the list below (e.g., Bermuda hay or pasture establishment, 043).

A. Use **Lawn** (code 026) for all lawn grasses except Centipede. Use one of the **Fine Turf** codes only for golf and athletic field turf.  
 B. Use **Shrubs** (code 029) for all shrubs, except azalea, camellia, rhododendron and mountain laurel.  
 C. For all home garden vegetables, use code 024.

**LIME APPLIED WITHIN PAST 12 MONTHS** — Provide the amount of lime applied in tons/acre, as well as the year and month of the last application, if made during the past 12 months. (50M = 50 lb/1000 ft<sup>2</sup>, which is equivalent to one ton per acre.)

**SECOND CROP** — List the name of the crop that will follow the one listed as **FIRST CROP**. Include its CODE from the list below. This will enable us to make suggestions for this crop, assuming that the field is treated as suggested the first year. List the second crop even if it will be grown the same year as **FIRST CROP**.

**CROP CODES**

<p><b>Home Lawn &amp; Garden</b></p> <p>020 Azalea/ Camellia 022 Lawn, centipede 023 Flower garden 024 Vegetable garden 025 Mtn. Laurel/ Rhodod. 026 Lawn (not centipede) 028 Rose 029 Shrubs 030 Berries/Fruit/Nuts 031 Tree, shade 032 Blueberries, home 036 Fir/N. Spruce/Hem, E 037 Fir/N. Spruce/Hem, M 038 Pine, white or Va. 039 Bl. Spruce/Red Cedar</p> <p><b>Christmas Trees</b></p> <p>034 Leyland Cypress 035 Line-out/ Seed beds 036 Fir/N. Spruce/Hem, E 037 Fir/N. Spruce/Hem, M 038 Pine, white or Va. 039 Bl. Spruce/Red Cedar</p> <p><b>Forage &amp; Pasture</b></p> <p>040 Alfalfa, E 041 Alfalfa, M 042 Com. Bermuda/Bahia</p>	<p><b>Forage &amp; Pasture (cont.)</b></p> <p>043 Bermuda hay/past., E 044 Bermuda hay/past., M 047 Bluegrass pasture 048 Bluegrass/Wh. Clover 049 Clover/Grass, E 050 Clover/Grass, M 051 Gamagrass 053 Legumes, misc. 054 Fescue/OGrass/Tim, E 055 Fescue/OGrass/Tim, M 056 Prairiegrass 057 Switchgrass 059 Sudan/Sorghum past. 060 Sudan/Sorghum silage</p> <p><b>Roadside Areas</b></p> <p>061 Critical area 062 Grass, roadside, E 063 Grass, roadside, M</p> <p><b>Wildlife Areas / Food Plots</b></p> <p>066 Deer/Turkey 067 Upland Game 068 Waterfowl 069 Fish Pond</p>	<p><b>Commercial Hort Crops ONLY</b></p> <p>[024 = all Home Vegetables]</p> <p>070 Asparagus, E 071 Asparagus, M 072 Beans/Peas 073 Beans, pole 074 Beet 075 Blueberry, E 076 Blueberry, M 077 Brocc/ BSprout/Caulif 079 Cabbage 080 Cantaloupe/Melons 084 Corn, sweet 085 Cucumber 088 Grape, E 089 Grape, M 090 Kale/ Mustard/ Spinach 093 Okra 095 Pea, southern 096 Pepper/Sage 097 Plant bed, vegetable 098 Potato, Irish 099 Sweetpotato 100 Radish 101 Canola/Rape</p>	<p><b>Commercial Hort Crops (cont.)</b></p> <p>102 Black/Raspberry, E 103 Black/Raspberry, M 107 Squash/Pumpkin 108 Strawberry, E 109 Strawberry, M 110 Tomato 111 Tomato, greenhouse 115 Turnip 116 Vegetables, other 118 Strawberry, plastic 119 Hops 175 Grape - vinifera</p> <p><b>Commercial Nursery &amp; Flowers</b></p> <p>120 Dahlia 121 Gladiolus 122 Greenhouse 123 Gypsophila (baby's breath) 124 Flower, bulbs 125 Flower, roots 126 Container nursery 132 Rhod/Ginseng/Natives 136 Tree nursery</p>	<p><b>Orchard, Fruit &amp; Nut</b></p> <p>130 Apple, E 131 Apple, M 138 Peach, E 139 Peach, M 140 Pecan, E 141 Pecan, M</p> <p><b>Forest Trees &amp; Seed</b></p> <p>133 Hardwood, E 134 Hardwood, M 137 Pine nursery 142 Pine, E 143 Pine, M 144 Hardwood, seed 145 Fir/Spruce, seed 146 Pine, seed</p> <p><b>Fine Turf</b></p> <p>150 Fairway/Athl. turf 151 Tee 152 Greens</p> <p><b>Stormwater</b></p> <p>200 Bioretention cell</p>
----------------------------------------------------------------------------------------------------------------------------------------------------------------------------------------------------------------------------------------------------------------------------------------------------------------------------------------------------------------------------------------------------------------------------------------------------------------------------------------------------------------------------------------------------------------------------------------------------------------------------------------------------------------------------------------------------------------------------------------	----------------------------------------------------------------------------------------------------------------------------------------------------------------------------------------------------------------------------------------------------------------------------------------------------------------------------------------------------------------------------------------------------------------------------------------------------------------------------------------------------------------------------------------------------------------------------------------------------------------------------------------------------------	-----------------------------------------------------------------------------------------------------------------------------------------------------------------------------------------------------------------------------------------------------------------------------------------------------------------------------------------------------------------------------------------------------------------------------------------------------------------------------------------------------------------------------------------------------------------------	-----------------------------------------------------------------------------------------------------------------------------------------------------------------------------------------------------------------------------------------------------------------------------------------------------------------------------------------------------------------------------------------------------------------------------------------------------------------------------------------------------------------------------------------------------------------------------------------------	-------------------------------------------------------------------------------------------------------------------------------------------------------------------------------------------------------------------------------------------------------------------------------------------------------------------------------------------------------------------------------------------------------------------------------------------------------------------------------------------------

Figure 5-10. Soil Sample Information Sheet, page two.

## What Does My Soil Test Report Tell Me?

Your soil test report gives you crop specific recommendations for lime rate and nutrient rates. Test results include pH, P-Index, K-Index, Zn-Index, Cu-Index. Agronomist comments are also included on diagnostic and heavy metal reports (Figure 5-11).

The NCD&CS Agronomic Division tries to present soil test results and recommendations in a way that is easy to understand. Reports contain explanatory information, hyperlinks to relevant publications and, often, specific comments from an agronomist. If additional guidance is required, regional agronomists and county Cooperative Extension personnel are available to help clients interpret results and implement recommendations.

## Soil pH and Lime

If the test finds that the soil pH is too low for your soil type and crop, the amount of lime required to achieve the target pH is recommended. These recommendations are based on soil pH, exchangeable acidity (Ac), target pH, and residual lime credit. The residual lime credit is determined by the information you provided about the lime history of the sample.



Lime rates for crops grown on a large scale are expressed in units of tons/acre. based on the information The lowest recommended rates are 0.3 ton/acre. If the lime recommendation is 0, no lime should be applied. The pH determination is also useful for indicating when too much lime has been applied and for evaluating micronutrient availability, particularly manganese.

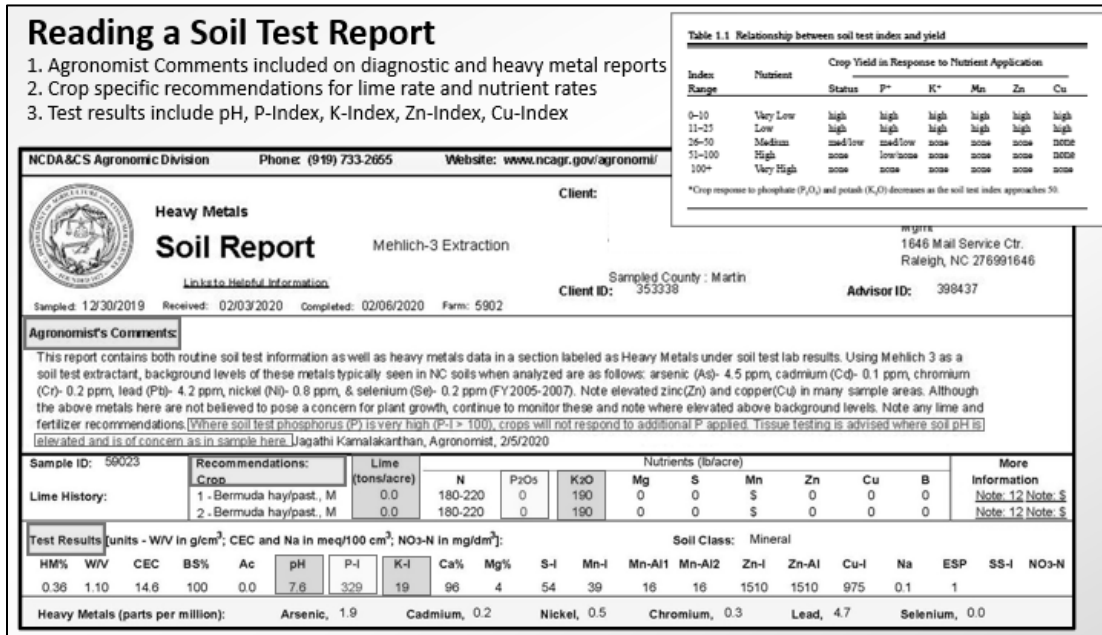

Figure 5-11. Soil Test Report.

**CEC**

Remember from Chapter 3 that the cation exchange capacity (CEC) is an indication of a soil's ability to hold nutrients. In North Carolina, CEC increases with increasing clay content or increasing organic matter content. Soils with a low CEC (1 to 5 meq/100g) have low clay and organic matter contents, and nutrients such as nitrogen, potassium, and magnesium may leach from these soils during periods of excess rainfall. These soils require more frequent application of nutrients at lower rates to ensure adequate availability throughout the growing season. Micronutrients applied to soils with low CEC can become toxic to plants at lower concentrations than on soils with a CEC above 5 milliequivalents per 100 grams.

**Nutrient Index Values**

The soil nutrient concentrations on an NCD & CS soil test are reported as index values. Index values can be used as a means of predicting soil fertility levels or potential heavy metal toxicities. Essentially, the index system was developed to relate soil fertility levels to the likelihood of a crop yield increase resulting from a fertilizer application (Table 5-6).

**Table 5-6. Relationship between soil test index and yield**

Index Range	Nutrient	Crop Yield in Response to Nutrient Application					
		Status	P+	K+	Mn	Zn	Cu
1-10	Very Low	high	high	high	high	high	high
11-25	Low	high	high	high	high	high	high
26-50	Medium	med/low	med/low	none	none	none	none
51-100	High	none	low/none	none	none	none	none
100+	Very High	none	none	none	none	none	none

+ Crop response to phosphate (P<sub>2</sub>O<sub>5</sub>) and potash (K<sub>2</sub>O) decreases as the soil index approaches 50.

In most cases, soil tests do not measure nitrogen because it does not persist long in soil. Recommendations for N (and sometimes for B) are based on research/field studies for the crop being grown, not on soil test results. Phosphorus and potassium values are based on test results and a crop response to nutrient additions is not expected when the index value is above 50. If they are below 50, follow the fertilizer recommendations given.

Micronutrients are required in much lower amounts, so crop responses are not expected when index values are above 25. When soil test index values are less than these critical levels, the soil test report will indicate the amount of nutrient to apply for optimum plant growth in the Recommendations Section of the report. For more information on understanding the index system, see Appendix B-3.

You should pay special attention to micronutrient levels. If \$, pH\$, \$pH, C or Z notations appear on the soil report, refer to NCDA&CS publication: \$ *NOTE: Secondary Nutrients & Micronutrients*. Soil test index values above 100 indicate excessive amounts are present in the soil.

Sodium (Na) is evaluated for all samples. Values less than 0.4 meq/100 cm<sup>3</sup> are inconsequential to plant nutrition. However, on sandy soils, values of 0.4 to 0.5 meq/100 cm<sup>3</sup> or greater may indicate that sodium accounts for 15 to 20% of the CEC as calculated by the exchangeable sodium percentage. Such levels could interfere with plant uptake of calcium, magnesium and potassium and adversely affect soil structure. When Na is excessive, soluble salt levels may be high enough to cause root injury.

## Plant Tissue Sampling and Analysis

Healthy plants contain predictable concentrations of the essential elements. If these elements are present in inadequate amounts then the plant suffers from a nutrient deficiency. In some cases, these nutrients are present in higher concentrations than required and the plant may suffer from a nutrient toxicity. In either case, the plant is not healthy and is not efficiently removing nutrients from the soil. Plant tissue sampling can be used to distinguish between nutrient deficiency, nutrient sufficiency, and nutrient toxicity.

A recent soil test result can be helpful when interpreting a plant analysis. When visual symptoms of a suspected nutrient deficiency are present, take a soil sample at the same time from root zones of plants sampled. In this way, an evaluation of the soil in the affected area can be made along with an evaluation of the plant tissue. Sampling healthy and unhealthy plants, and their respective soil, is very effective in problem solving.

A plant analysis may indicate that a nutrient deficiency or toxicity does not exist. Therefore, a factor other than nutrition may be responsible for poor plant growth or visual symptoms. This information is invaluable in problem solving. In order to use the plant analysis technique effectively, take care when collecting, preparing, and sending plant tissue to the laboratory.

Sampling instructions, information sheets, and shipping envelopes are provided at no charge and can be obtained at county Cooperative Extension Service centers or from Regional Agronomists of the Agronomic Division. Samples, the completed information sheets (Form AD4, Appendix B-3), and a \$5.00 fee should be sent to the Agronomic Division, NCDA & CS, 4300 Reedy Creek Road, Raleigh, NC 27607-6465.

If plant tissue monitoring is required by your system permit, the permit will specify which parameters to monitor, when to monitor, and when results must be submitted. It is important to note that your permit may require that you use a private North Carolina certified laboratory to satisfy monitoring requirements rather than the NCDA & CS Agronomic Laboratory.

The following discussion of where, when and how to take and submit plant tissue samples is taken from Sampling for Plant Analysis (NCDA Agronomic Sampling Folder No. 5).

Plant analysis results can:

- indicate the nutritional status of plants
- identify deficiencies and toxicities
- provide an accounting of nutrient utilization
- provide a mechanism for optimizing yield, quality, and efficiency

Plant analysis evaluates the status of 13 nutrients required for plant growth along with certain potentially toxic elements. Plant analysis assesses nutrient uptake while soil testing predicts nutrient availability. The two tests are complementary as crop management tools, but each has limitations. Plant analysis cannot predict lime requirement. Soil testing is not always a good indicator of nutrients such as nitrogen and sulfur that leach easily. Plant analysis is also a better tool for assessing some micronutrients, such as boron, iron, and molybdenum.

### *Deciding When to Sample*

To monitor plant nutrient status most effectively, sample during the recommended growth stages for your specific crop (Table 5-7). Take samples weekly or biweekly during critical periods, depending on management intensity and crop value. However, to identify a specific plant growth problem, take samples whenever you suspect the problem.

Table 5-7. Best time to sample when monitoring nutritional status.

Alfalfa, clover, peanut, pea, soybean	early bloom
Apple, cherry, grape, peach, pear, pecan, sweetpotato	mid-season
Bean	early growth and bloom
Cotton	from 2 weeks before first bloom through 6 weeks after bloom
Corn, sorghum, sweet corn	lay-by and bloom (tasseling)
Cucumber, squash, tomato	from 2 weeks before first bloom through fruiting
Flowering plants & foliage plants	early growth through bloom
Irish potato	early bloom
Leaf and root crops	early growth
Small grain	full tillering and bloom
Strawberry	spring vegetative growth through fruiting
Tobacco	early growth through bloom for nutritional status; one week prior to harvest for flue-cured harvest readiness
Turfgrass	monthly
Woody ornamentals	current year's growth

Although it is not critical, the best time to collect samples is between mid-morning and mid-afternoon. Nitrate nitrogen varies with time of day and prevailing conditions but generally not enough to alter interpretation. Sampling during damp conditions is acceptable but requires extra

care to prevent tissue from decomposing during shipping. Keep samples free of soil and other contaminants that can alter results.

### *Taking a Representative Sample*

Proper sampling is the key to reliable plant analysis results. A sample can represent the status of one plant or 20 acres of plants. In general, a common-sense approach works well. When problem solving, take samples from both “good” and “bad” areas. Comparison between the groups of samples helps pinpoint the limiting element. Comparative sampling also helps factor out the influence of drought stress, disease, or injury. Take matching soil samples from the root zones of both “good” and “bad” plants for the most complete evaluation.

When monitoring the status of healthy plants, take samples from a uniform area. If the entire field is uniform, one sample can represent a number of acres. If there are variations in soil type, topography, or crop history, take multiple samples so that each unique area is represented by its own sample.

### *Selecting the Best Indicator Sample*

The appropriate part of the plant to sample varies with crop, stage of growth, and purpose of sampling. When sampling seedlings less than 4 inches tall, take whole plants from 1 inch above the soil line. For larger plants, the most recent mature leaf (MRML) is the best indicator samples.

The MRML is the first fully expanded leaf below the growing point (Figure 5-12). It is neither dull from age nor shiny green from immaturity. For some crops, the MRML is a compound leaf. The MRML on soybean and strawberry, for example, is a trifoliate compound leaf: three leaflets comprising one leaf.

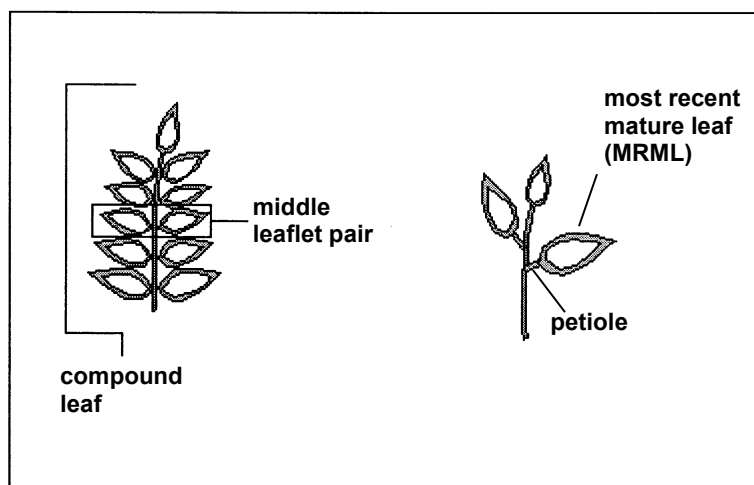

Figure 5-12. Some best indicator samples.

For cotton, grape, and strawberry, petioles provide an additional indication of nitrogen status. When sampling these crops, collect MRMLs and their petioles. Detach leaves from petioles in the field to stop the translocation of nutrients. Put petioles in a separate envelope inside the leaf sample container.

### *Choosing Sample Size*

The actual laboratory analysis requires less than one gram of tissue. However, a good sample contains enough leaves to represent the area sampled. Therefore, the larger the area is, the larger the sample size needs to be.

Sample size also varies with crop. For crops with large leaves, like tobacco, a sample of three or four leaves is adequate. For crops with small leaves, like azalea, a sample of 25 to 30 leaves is more appropriate. For most crops, 8 to 15 leaves is adequate. For crops requiring petiole analysis, collect at least 15 to 20 leaves.

### *Submitting the Sample*

Send the completed plant analysis information sheet (form AD-4) and \$4 processing fee with each sample. Use permanent ink or pencil on sample forms and envelopes. Tissue sample envelopes and information sheets are available from local Cooperative Extension offices, agribusinesses, regional agronomists, or the Agronomic Division laboratory. See Appendix B-3 for a copy of form AD-4, the plant analysis information sheet.

Pay attention to detail when filling out the information sheet (Figures 5-13 and 5-14). Supply the information requested in all shaded areas on the form. Note any conditions—drought, disease, injury, pesticide or foliar nutrient applications—that might be relevant.

When identifying the plants that you sampled, give the exact name using the list inside the information sheet, if possible. Give each sample a unique identifier that will help you remember the plants or area it corresponds to—such as HOUSE1, 15B, GOOD, or BAD. You can use up to six letters and/or numbers. Put the identifier on both the information sheet and the sample envelope.

Diagnostic interpretations require more details than predictive. When sending matching soil, solution, or waste samples, indicate the matching sample ID in the designated areas on the information sheet. Be sure the grower name and address are exactly the same on all matching information sheets. Ship all matching samples in the same container addressed to the Plant Advisory Section.

Form AD-4 (2015)

**SAMPLE TYPE** (Circle ONE)

Predictive (\$5)    Diagnostic (\$5)  
 Research (\$12)    Out of State (\$25)

**PLANT SAMPLE INFORMATION**

**NCDA&CS Agronomic Division Plant/Waste/Solution/Media Section**  
 Mailing Address: 1040 Mail Service Center, Raleigh NC 27699-1040  
 Physical Address (UPS/FedEx/DHS): 4300 Reedy Creek Rd, Raleigh NC 27607  
 Phone: (919) 733-2655    For lab results go to: [www.ncagr.gov/agronomi](http://www.ncagr.gov/agronomi)

OFFICE USE ONLY

REPORT # \_\_\_\_\_

DATE REC'D \_\_\_\_\_

INITIAL \_\_\_\_\_



**SAMPLE INFORMATION**

**PAYMENT**

**GROWER INFORMATION** (please write legibly)

**CONSULTANT / EXTENSION AGENT / OTHER**

FARM ID	FEE TOTAL _____	LAST NAME	FIRST NAME	LAST NAME	FIRST NAME		
SAMPLING DATE	AMT PAID _____	ADDRESS		ADDRESS			
SAMPLED BY <input type="checkbox"/> Grower <input type="checkbox"/> Reg. Agronomist <input type="checkbox"/> Advisor <input type="checkbox"/> Ext. Agent	METHOD OF PAYMENT: <input type="checkbox"/> CASH <input type="checkbox"/> CHECK # _____ <input type="checkbox"/> BILL ME (REPORTS NOT RELEASED UNTIL PAID) <input type="checkbox"/> ESCROW:	CITY	STATE	ZIP	CITY	STATE	ZIP
COUNTY (WHERE COLLECTED)		EMAIL ADDRESS		EMAIL ADDRESS			
NUMBER OF SAMPLES		PHONE (____) _____	PALS # (if known)	PHONE (____) _____	PALS # (if known)		

LAB NUMBER (LEAVE BLANK)	SAMPLE ID	CROP NAME	GROWTH STAGE	WEEK	PLANT PART (M, W, T, E, H, F)	PLANT POSITION (Harvest tobacco only)	PLANT APPEARANCE	CORRESPONDING SAMPLE ID <input type="checkbox"/> Soil <input type="checkbox"/> Waste <input type="checkbox"/> Media <input type="checkbox"/> Nematode <input type="checkbox"/> Solution	SPECIAL TESTS (\$2 EACH)		
								Mo	Cl	NO <sub>3</sub>	

**GROWING CONDITIONS** (CHECK ALL THAT APPLY)

Planting date: \_\_\_\_\_ Date of last soil test: \_\_\_\_\_

Rainfall     Below normal     Normal     Above normal     Drip Irrigation

Temperature     Below normal     Normal     Above normal

Production System     Greenhouse     Field     High Tunnel     Outdoor Container

Nutrient supply     Granular fertilizer     Liquid fertilizer     CRF     Organic

Growth substrate     Soil     Potting Media     Hydroponic solution     Other \_\_\_\_\_

**SAMPLE COMMENTS**

Please provide information to aid in recommendations or diagnosis, such as fertilizer history, disease or insect presence, symptomology, etc.

\_\_\_\_\_

\_\_\_\_\_

\_\_\_\_\_

\_\_\_\_\_

*Thank you for using agronomic services to manage nutrients and safeguard environmental quality. — Steve Troxler, Commissioner of Agriculture*

Figure 5-13. Plant Analysis Information Sheet, page one.

Ship the tissue sample in a paper envelope or cardboard box so it can begin drying during transport. Samples put in plastic bags will rot, and decomposition may alter test results.

### Interpreting the Report

Samples are analyzed within two days of their arrival. The prompt turnaround makes it possible for growers to take any corrective action needed to salvage the current crop. The report is mailed to the grower, but a copy is also immediately posted on the internet at: <http://www.ncagr.gov/agronomi/>.

## INSTRUCTIONS FOR COMPLETING THE PLANT SAMPLE INFORMATION FORM

### TIPS:

- Send leaf tissue samples in PAPER bags. Do NOT use plastic bags.
- Be sure to send enough leaf material. A general rule of thumb is two handfuls of leaves.
- Do not send whole plants with roots. Submit leaves from multiple plants from a representative area.

### SAMPLE TYPE

**Predictive** (routine) analysis checks nutrient content and provides interpretation and general recommendations.

**Diagnostic** (troubleshooting) analysis identifies nutritional problems and provides interpretation and specific recommendations. Diagnostic analysis is most effective if the grower submits both a "good" (healthy) and a "bad" (unhealthy) sample.

**Research** is for samples submitted by private and university research facilities. An approved research agreement is required prior to submission.

**Out of state** is for samples submitted by or for non-North Carolina residents.

**SAMPLE INFORMATION:** FARM ID is an optional identifier associated with each sample. Please also specify the sampling date, who collected the sample, and the county where it was collected.

**SAMPLE ID:** Provide sample identification (no more than six letters). Put the same ID on the sample envelope or paper bag.

**PAYMENT INFORMATION:** Cost per sample is \$5 for N.C. residents, \$25 for out of state samples, and \$12 for in-state research samples. Reports are not released until fees are paid.

Special tests—petiole nitrate nitrogen, molybdenum (Mo) and chloride (Cl)—are an additional \$2. A petiole nitrate nitrogen test is required for cotton and strawberry samples and a molybdenum test is required for *Brassicac*s (cabbage, kale, rapeseed, broccoli, Brussels sprouts, cauliflower, collards, turnips), spinach, alfalfa, and poinsettia. Payments can be made by cash, check, escrow or over the phone with a Visa or Mastercard. Beginning Jan. 2016, payments can be made online on the PALS site.

**GROWTH STAGE:** Identify plant growth stage using one of these letter codes: S = SEEDLING, E = EARLY GROWTH, B = BLOOM, F = FRUITING, M = MATURE

**WEEK:** For strawberry samples, list the number of weeks since the 1st week of bloom. For cotton samples, list the number of weeks the crop has been in early, bloom, or fruit stage. Providing the accurate week is essential for correct nitrogen recommendations. Separate petioles from leaves and submit both parts for strawberry and cotton samples.

**PLANT PART:** For the majority of crops, the **most recent mature leaf (M)** is the proper plant part to sample. For seedlings, sample the **whole plant (W)** cut 1" above the soil line. For grasses and grains prior to head formation, sample the **top three inches (T)**. For corn at tasseling, sample the **ear leaf (E)**. **H = Harvest leaf** (tobacco only). **P = Petiole only** (applies only to vinifera grapes).

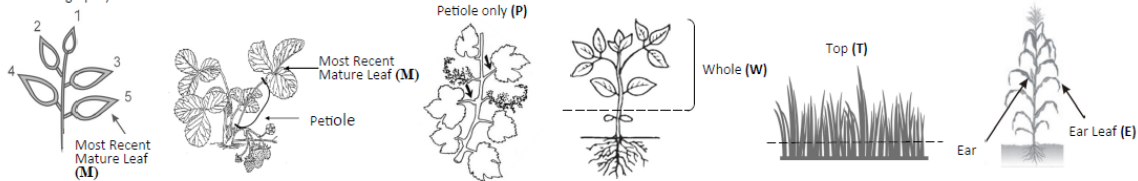

**PLANT POSITION:** This field is only necessary for *harvest stage tobacco* leaves. For these leaf samples, specify whether the leaves were collected from the (U) = Upper, (M) = Middle or (L) = Lower position of the plant.

Figure 5-14. Plant Analysis Information Sheet, page two.

A cover sheet that explains the technical terms and index values accompanies the report. Cover sheets and other information about plant analysis are also available on the internet at: <http://www.ncagr.gov/agronomi/pdf/files/uplant.pdf>.

Consult an agricultural advisor if you need additional information or refer to Appendix B-3.

## Waste and Wastewater Sampling

Waste analysis is the most accurate and efficient way to measure the nutrient or lime value of different waste products. Because the amount of these beneficial components can vary among waste products, laboratory analysis lets an operator know the proper amount of the waste material to apply to meet the specific plant needs for each site. When management decisions are made without waste analysis information, even well-intentioned users can reduce plant growth and yields or endanger the environment.



Waste users who fail to test each waste material are faced with a number of questions they simply cannot answer. Are they supplying plants with adequate nutrients? Are they building up excess nutrients that may ultimately move to streams or groundwater? Are they changing the soil pH to levels that will not support plant production? Are they applying heavy metals at levels that may be toxic to plants and permanently alter soil productivity?

Because environmental damage and losses in plant yield and quality often happen before visible plant symptoms, waste users should always have their wastes analyzed by a competent laboratory and their application rates determined by a knowledgeable agronomist.

A good analytical service should always determine the concentrations of essential plant nutrients, including nitrogen (N), phosphorus (P), potassium (K), calcium (Ca), magnesium (Mg), sulfur (S), iron (Fe), manganese (Mn), zinc (Zn), copper (Cu), and boron (B). Analyses of certain municipal and industrial wastes should also include tests for heavy metals like nickel (Ni), cadmium (Cd), and lead (Pb), as well as elements such as sodium (Na) and chlorine (Cl). The neutralizing value (calcium carbonate equivalent, CCE) of lime-stabilized products or materials suspected of having liming characteristics should also be determined.

The Waste Advisory Section of the NCDA & CS Agronomic Division analyzes wastes, interprets analytical results, and provides management recommendations for citizens of North Carolina. The fee for a standard waste analysis is \$8.00 per sample. Private laboratories also offer some of these services and their fees vary. It is important to note that your permit may require that you use a private North Carolina certified laboratory to satisfy monitoring requirements rather than the NCDA & CS Agronomic Laboratory.

### *Wastewater Sampling Terminology*

A surface irrigation system operator should be familiar with the following wastewater sampling terms:

- **Grab Sample** - A grab sample is a sample collected over a period of time not exceeding 15 minutes. A grab sample is normally associated with water or wastewater sampling. However, soil, sediment, etc., may also be considered grab samples; no particular time limit would apply for the collection of such samples. Grab samples are used to characterize the medium at a particular instant in time and are always associated with instantaneous water or wastewater flow data, where appropriate. Grab sampling is conducted when:
  - the water or wastewater stream is not continuous;
  - the characteristics of the water or waste stream are known to be constant
  - the sample is to be analyzed for parameters whose characteristics are likely to change significantly with time (e.g., dissolved gases, bacteria, etc.)

- the sample is to be collected for analysis of a parameter such as oil and grease where the compositing process could significantly affect the observed concentrations
  - data on maximum/minimum concentrations are desired for a continuous water or wastewater stream
  - when the permit monitoring requirements specify grab collections. The following parameters are always collected by grab samples:
    - pH
    - phenol
    - temperature
    - oil and grease
    - dissolved oxygen
    - bacteria
    - sulfide
    - volatile organics
    - chlorine residual
    - dissolved gases
- **Composite Sample** - Composite samples are used when average concentrations are of interest and are always associated with average flow data (where appropriate). Composite sampling is employed when the water or wastewater stream is continuous or it is necessary to calculate mass/unit time loadings or when analytical capabilities are limited.
    - **Timed composite** - A timed composite sample contains a minimum of eight equal volume discrete samples taken at equal time intervals over the compositing period. A timed composite may be collected continuously. Time composites shall be collected where water or wastewater flows do not vary more than +/- 15 percent of the average daily flow rate. Timed composite samples should be considered where wastewater flows are constant. A timed composite shall be collected continuously or with a constant sample volume and a constant time interval between samples.
    - **Flow proportional composite** - A flow proportional composite contains a minimum of eight discrete samples taken proportional to the flow rate over the compositing period. Flow proportional samples should be collected where water or wastewater flows vary more than +/- 15 percent from the average daily flow rate. Flow proportional composites are used when wastewater flow is highly variable (greater than +/- 15 percent of the average daily flow). A flow proportional composite should be collected with constant sample volume and time between samples proportional to stream flow or with a constant time interval between samples.

- **Split Sample** - A split sample is a sample that has been portioned into two or more containers from a single container. Portioning assumes adequate mixing to assure the "split samples" are, for all practical purposes, identical.
- **Duplicate Sample** - Duplicate samples are samples collected simultaneously from the same source, under identical conditions and into separate containers.
- **Control Sample** - A control sample is collected upstream or upgradient from a source or site to isolate the effects of the source or site on the particular ambient medium being evaluated.
- **Background Sample** - A background sample is collected from an area, water body, or site similar to the one being studied but located in an area known or thought to be free from pollutants of concern.
- **Sample Aliquot** - A sample aliquot is a portion of a sample that is representative of the entire sample.

### *Sampling Procedures*

Proper sampling is the key to reliable waste analysis. Although laboratory procedures are extremely accurate, they have little value if the samples fail to represent the waste product. The importance of careful sampling becomes clear when one recognizes that laboratory determinations are made on a portion of the sample submitted that is as little as 0.02 pound (1 gram) for solid materials or less than a tablespoon (10 milliliters) for liquid materials.

Waste samples submitted to a laboratory should represent the average composition of the material that will be applied to the field. Reliable samples typically consist of material collected from a number of locations. The wide variety of field conditions always requires judgement regarding the methodology and procedures for collection of wastewater samples. Important considerations for obtaining a representative wastewater sample include the following items:

- If possible, the sample should be collected where the wastewater is well-mixed. Therefore the sample should be collected near the center of the flow channel, at a depth of approximately half the total depth, where the turbulence is at a maximum and the possibility of solids settling is minimized. Skimming the water surface or dragging the bottom should be avoided.
- In sampling from a mixing zone, cross-sectional sampling should be considered. Dye may be used as an aid in determining the most representative sampling points.

- If manual compositing is employed, the individual sample bottles must be thoroughly mixed before pouring the individual aliquots into the composite container.

Where applicable, wastewater samples should be collected at the location specified in the permit:

- **Influent** - Influent wastewaters are preferably sampled at points of highly turbulent flow in order to insure adequate mixing.
- **Effluent** - Effluent samples should be collected at the site specified in the permit, or if no site is specified, at the most representative site downstream from all discharges into the receiving waters.
- **Pond and lagoon sampling** - Generally, composite samples should be employed for the collection of wastewater samples from ponds and lagoons. Even if the ponds and lagoons have a long retention time, composite sampling is necessary because of the tendency of ponds and lagoons to short circuit. However, if dye studies or past experience indicate a homogenous discharge, a grab sample may be taken as representative of the waste stream. But in all cases, sampling should be consistent with all permit requirements.

For more detailed information about sampling wastewater, see Appendix B-4.

## Lagoon Sampling

Ideally, some liquid wastes should be sampled after they are thoroughly mixed. Because this is sometimes impractical, samples can also be taken in accordance with the suggestions that follow.

Premixing the surface liquid in the lagoon is not needed, provided it is the only component that is being pumped. Operators with two-stage systems should draw samples from the lagoon they intend to pump.

Samples should be collected using a plastic container similar to the one shown in Figure 5-15. One pint of material should be taken from at least eight sites around the lagoon and then mixed in a plastic container. Waste should be collected at least 6 feet from the edge of the lagoon at a depth of about a foot. Shallower samples from anaerobic lagoons may be less representative than deep samples because oxygen transfer near the surface sometimes alters the chemistry of the solution. Floating debris and scum should be avoided.

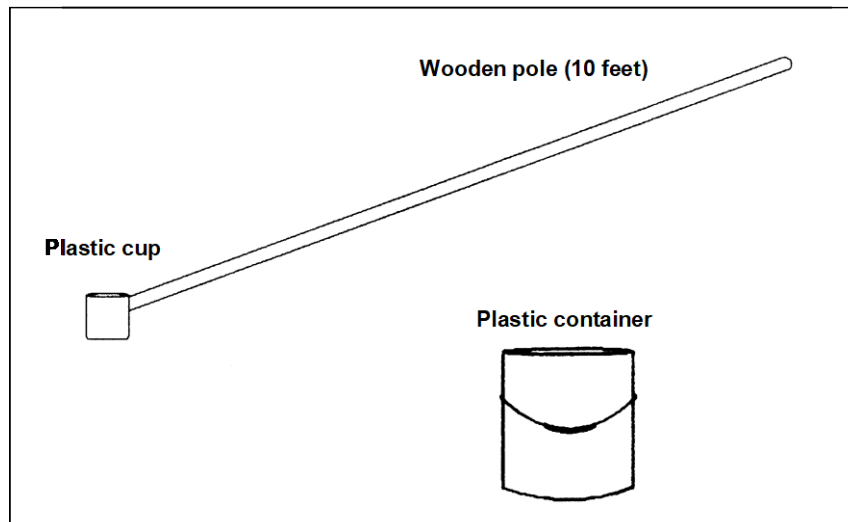

Figure 5-15. Liquid waste sampling device

One quart of mixed material should be sent to the laboratory. Galvanized containers should never be used for collection, mixing, or storage due to the risk of contamination from metals like zinc in the container.

### *Submitting Liquid Waste Samples*

Liquid waste samples submitted for analysis should meet the following requirements:

- Place sample in a sealed plastic container with about a one-quart volume. Glass is not suitable because it is breakable and may contain contaminants.
- Leave 1 inch of air space in the plastic container to allow for expansion caused by the release of gas from the waste material.
- Refrigerate samples that cannot be shipped on the day they are collected; this will minimize chemical reactions and pressure buildup from gases.

## Groundwater Sampling

Groundwater monitoring is sometimes required by the system permit to ensure that deterioration of groundwater quality does not occur. One of the most critical parts of groundwater monitoring is the sample collection process. The best lab in the state cannot produce accurate results from a sample that was contaminated before the lab received it. It would take a lot of time to cover all of the different types of monitoring systems and wells.

This discussion will concentrate on the most common monitoring systems for land application of waste. However, no matter what type of well is being sampled, the procedures and important concepts covered should be followed consistently throughout the monitoring process.

Groundwater is sampled from specially designed wells that are carefully located. The wells must be sampled immediately after construction and before waste disposal begins. This determines background levels of constituents that are to be monitored. The system permit gives the frequency for all sampling after the first event, based on facility and site conditions.

Before beginning compliance monitoring, you should do the following:

- determine the sampling schedule and parameters to be monitored as specified in your permit;
- select a laboratory with NC DWR certification that can meet your permit requirements; and
- provide the lab with a copy of the monitoring requirements in your permit.

An updated list of certified laboratories is available from the DWR, Division of Water Resources Chemistry Laboratory, 4405 Reedy Creek Road, Raleigh NC 27607, (919)733-3908.

### *Equipment and Supplies*

Prior planning and careful preparation of field equipment before sampling will ensure good results from the laboratory. The following is a list of supplies and equipment to be used when sampling groundwater:

- disposable gloves;
- documentation (forms, log books and tags, etc.);
- well lock keys;
- water level monitoring device and supplies (batteries, chalk and paste as needed);
- properly calibrated pH, temperature, and conductivity meters with calibration standards;
- decontaminated sampling pump with proper tubing and power supply;
- bailers with line;
- sample containers;
- filtering apparatus;
- cooler with cold packs or ice;
- cleaning buckets and containers;
- plastic garbage bags;
- small sealable plastic bags;
- plastic sheeting;
- paper towels and hand soap;
- cleaning brushes;
- phosphate-free laboratory soap;
- deionized organic-free water and hand sprayers; and
- high purity laboratory grade hexane, acetone, or isopropanol (all available from laboratory supply companies).

Customized kits for sample collection may be supplied by your laboratory. These kits include all the items needed for collection and shipment of samples. Follow laboratory instructions and read container labels. Be careful not to discard preservatives that may have already been added to some containers.

If you are not using a kit, use only new containers or sanitized reusable containers supplied by a lab of the appropriate types for the required parameters. Select and prepare them according to your laboratory's instructions. Label sample containers before sample collection and record the type and amount of preservative required on each sample tag.

Ensure that all sampling equipment such as bailers, containers and tubing has been selected and thoroughly cleaned based on the parameters to be monitored. Disposable bailers of the appropriate composition may be used. Use Teflon, stainless steel, or glass when sampling for organics such as solvents and petroleum product contamination. Do not use PVC or other plastics. Use polyethylene, Teflon or glass when sampling for trace metals.

### *Minimizing Contamination Risks*

Minimize contamination risks while collecting samples by doing the following:

- ensure that all sampling equipment (bailers, tubing, containers, etc.) has been thoroughly cleaned and selected based on compatibility with parameters to be monitored;
- use Teflon, stainless steel or glass when sampling for organics; do not use PVC or other plastics;
- use Teflon or glass when sampling for trace metals;
- use new sample containers when sampling for compliance monitoring; do not reuse containers;
- keep containers closed before filling and do not touch the inside of containers or caps;
- wear a new pair of disposable gloves or decontaminated reusable gloves for each sampling site;
- place new plastic sheeting on the ground near each well to hold the sampling equipment; do not step on the sheeting.
- place small samples which require cooling, such as volatile organics, in sealable plastic bags immediately after collection and before submerging in ice;
- do not smoke while collecting or handling samples since volatile residues in the smoke can cause sample contamination;
- do not leave your vehicle running near the sample collection area, to prevent contamination from engine exhaust fumes,;

- when using a pump, set up the generator about 15 feet away and downwind from the well; perform all generator maintenance and fueling off-site and away from samples; and
- avoid unnecessary handling of samples;
- if dedicated monitoring systems (those permanently installed in wells) are not used, clean equipment to be reused thoroughly before sampling each well to minimize the risk of cross contamination; bailers left in wells are **not** dedicated systems;
- take enough pre-cleaned equipment to the field to sample each well so that cleaning between wells is unnecessary; if field cleaning is necessary, an equipment blank may be used to make sure that no contamination results.

Blanks should be used to check for contamination. Blanks consist of organic-free deionized water which must be obtained from laboratories. Types of blanks include:

- a trip blank (a sealed container of organic-free deionized water that must be taken to the field and sent back to the lab unopened with the samples); include at least one trip blank per cooler for volatiles to check for sample contamination during transportation;
- a field blank consists of organic-free deionized water taken to the field and handled in the same manner as the samples to check for contamination from handling, from added preservatives, or from air-borne contaminants at the site which are not from the waste being disposed of at the treatment facility; and
- an equipment blank (organic-free deionized water which is passed through the cleaned sampling equipment with added preservatives) may be used to detect any contamination from equipment used for more than one well.

### *Measure Static Water and Calculate Well Volume*

From a permanent reference at the top of the well casing, lower a clean weighted steel tape or electric sounder into the well. Record the wet level mark on the tape and subtract it from the reference point to obtain the depth of water. Use the same reference point each time a water level measurement is made at the well.

Subtract the depth to water level measurement from the known total depth of the well to obtain the height of the water column. Calculate one well volume in gallons by multiplying the inside area of the well (measured in square feet) times the height of the water column (measured in feet) times 7.48 gallons per cubic foot. Or you may use Table 5-8 for a quick conversion of well volume in gallons:



Table 5-8. Well Diameter Conversion Table

Well Casing Diameter	Gallons per foot of Water Column Height
2 inches	0.163
4 inches	0.652
6 inches	1.5
8 inches	2.6

### *Purge the Well*

Before collecting any groundwater samples, you must adequately remove stagnant water from the wells. In order to purge a sufficient amount of water from a well, you must first calculate the well volume. Based on the calculated well volume, pump or bail at least one, but no more than three, well volumes from the well. Over pumping can cause the unintentional movement of contaminants toward the well. In low-yielding wells, one purge to dryness is adequate. Following well recovery, samples may be collected using a positive displacement bladder pump or bailer. Dispose of purged water appropriately according to state and federal regulations.

### **Purging with a Pump**

Low rate pumping is the preferred method for purging because bailing may increase turbidity by stirring up sediment in the well. When purging with a pump, slowly lower the pump to just below the top of the standing water column. Continue lowering it as the water level drops and the stagnant water is removed, until you remove a minimum of one, but not more than three, well volumes.

Dedicated monitoring systems are permanently installed pumping systems, and do not require placement or removal of equipment into or out of wells to purge or obtain samples. No cleaning is required because parts in contact with the water are sealed away from the atmosphere and handling.

### **Purging with a Bailer**

Using low flow pumps for purging generally produces high quality representative samples. However, if a pump is not available or cannot be used, use a bottom emptying bailer to purge and collect samples. Bailer lines of braided nylon or cotton cord must not be reused, even if clean, in order to avoid the probability of cross-contamination.

Lines must consist of Teflon-coated wire, single strand stainless steel wire, or other monofilament line. Do not leave bailers in wells. Contamination can occur when they are handled outside the

wells and placed back inside. Contamination can also occur as a result of deterioration of bailer lines.

Lower the bailer slowly to just below the water level and retract slowly to reduce aeration and turbidity. Collect the purged water in a graduated bucket to measure a minimum of one well volume.

### *Collecting Samples*

After wells are purged, collect samples using a positive displacement bladder pump or bottom emptying bailer. Do not use peristaltic or vacuum pumps to collect samples for volatiles. These pumps remove volatile contaminants from the groundwater.

Sample containers obtained from commercial labs or laboratory suppliers may already contain the appropriate preservatives. Check with your laboratory and follow their instructions. If preservatives are required for volatiles, make sure that they are added to vials prior to filling.

### **Sampling with a Pump**

When pumps of any type are used for sampling volatiles, the flow rate must be adjusted low enough (that is, less than 100 mL/minute) to fill a volatiles vial without aerating the sample.

Collect the sample directly into the appropriate containers in the following order:

- volatiles
- total organics halides
- total organics carbon
- other organics
- metals
- inorganics
- coliforms

### **Sampling with a Portable Pump**

When sampling with a portable pump, lower the pump slowly to the desired depth in the well. Have sample containers ready before turning on the pump. Adjust the flow rate to less than 100mL per minute to reduce agitation and minimize the loss of volatiles. Discard the first volume of water. Place volatiles vials and those samples that require storage at 6°C (39.2°F) in sealable plastic bags and store in an ice chest immediately after collection. Collect the remaining samples in order. Decontaminate the pump before moving to the next well.

### Sampling with a Bailer

To collect a sample, lower the bailer slowly into the well, avoiding agitation, and allow it to fill. Retract the bailer slowly and discharge the sample carefully into the container until the correct volume has been collected. Add preservative if required, cap the container, and mix according to laboratory instructions. Take precautions to minimize turbidity and sediment in samples. Use purging and sampling techniques previously described to minimize turbidity and agitation of sediment in wells.

In low-yielding wells and those containing high levels of suspended solids, slowly lower a bailer to the lowest standing water level and allow the water to flow into it. Carefully lift the bailer out of the well without allowing it to scrape or bang against the well casing.

### *Minimum Cleaning Techniques*

Portable sampling systems are used more frequently than dedicated systems because of lower costs. However, they require the use of much of the same equipment from well to well, increasing the possibility of cross contamination unless strict cleaning procedures are followed. Cleaning procedures must be selected based on the equipment composition and the parameters to be monitored. The following is a summary of minimum cleaning techniques for bailers and is applicable for other equipment of the same composition.

For stainless steel bailers and equipment, use:

- phosphate-free soap and hot tap water wash
- hot tap water rinse
- deionized water rinse
- isopropyl alcohol rinse
- deionized water rinse
- air dry

Wrap the bailer with aluminum foil or other material to prevent contamination before use. Consider target contaminants when selecting a wrap material.

To clean Teflon or glass bailers and equipment use:

- phosphate-free soap and hot tap water wash
- hot tap water rinse
- ten percent nitric acid rinse
- deionized water rinse
- isopropyl alcohol rinse

- deionized water rinse
- air dry

Wrap to prevent contamination before use. Again, consider the target contaminants when selecting wrapping material.

### *Special Handling Procedures*

Use extra care in selecting and cleaning all equipment, including pumps, bailers, sample containers, etc. associated with samples collected for trace metal analysis.

Use stainless steel or Teflon bailers to collect volatiles, if using a pump for sample collection that has a flow rate which cannot be adjusted to less than 100 mL per minute. Collect duplicate samples for volatile organics in special 40 mL septum vials, with Teflon lined disks in the caps to prevent contamination.

Fill the vials to capacity, with no headspace, to prevent volatilization. Carefully pour the sample down the inside of the vials to minimize aeration and agitation until the containers are overflowing. Ensure that no air bubbles are trapped in the vials by applying the caps so that some overflow is lost. If bubbles are noted when the vials are inverted and tapped, set those aside to be discarded. Repeat the collection procedure using new vials. Include a trip blank of organics-free water which must be obtained from your laboratory with each cooler containing samples collected for volatile organics.

Collect coliform samples directly into sterilized glass or sterilized plastic bottles that have been kept closed until ready to be filled. The sterilized containers often contain a preservative. Do not rinse prior to filling. Hold the bottles near the base until filled. Recap the bottles immediately using care not to contaminate the bottles or lids. Store as required.

### *Filtering Samples*

Do not filter samples for:

- volatile or semi-volatile organics
- metals
- coliforms

All groundwater samples for metals analysis required by DWR must be collected unfiltered, then field-acidified with five mL of concentrated nitric acid per liter of sample or ten mL of commercially prepared one-to-one diluted nitric acid per liter of sample. Metal samples must be submitted to the lab within 24 hours of collection.

If there is a special request for the collection of a filtered sample for any analysis use the appropriate type of filtering apparatus and filters.

In low yielding wells and those containing high levels of suspended solids, lowering a bailer to below the static water level and allowing the well to recover into the bailer should produce a cleaner sample. Use purging and sampling techniques previously described to minimize agitation of sediment in affected wells and reduce the need for filtering. A pump used for purging and sampling will produce better samples from such wells.

### *General Procedures for Packing Samples*

The following general procedures apply for packing samples prior to shipment by courier or by personal transport to the laboratory:

1. line a clean cooler with a large heavy duty plastic bag and add bags of ice;
2. place the properly tagged samples in individual sealable plastic bags and seal the bags with Chain-of-Custody tape to ensure sample integrity;
3. place bagged samples in the cooler, arranging bags of ice between samples to help prevent breakage, and add sufficient ice to maintain the temperature of at 6°C (39.2°F) while the samples are in transit;
4. enclose the appropriate forms in a sealable plastic bag, place with samples in the chest, and seal the large bag with chain of custody tape;
5. minimize transport time and ensure that samples will reach the laboratory without being exposed to temperature variations and without exceeding holding times.

Detailed information on sample containers, preservation, holding times, and sampling procedures is located in Appendix B-4.

Once the laboratory has completed the sample analysis, a report containing the analytical results will be sent to the person requesting the analysis. The information should be used to complete the groundwater monitoring compliance report form designated as form GW-59 or to satisfy other reporting requirements. Carefully fill out monitoring forms, making sure that all information is included and the data transferred from laboratory reports are recorded in the correct concentration units.

Include complete identification information, such as permit number and facility or permit name on all correspondence and additional laboratory reports. Be sure to submit the forms and lab reports on time. Groundwater monitoring and reporting requirements are covered in more detail in Chapter 8.

Remember, you are the critical link in the groundwater sampling process. It is vitally important that the procedures demonstrated be followed carefully to avoid costly resampling and to ensure that any groundwater contamination is quickly detected and remediated. This is so important, in fact, that failure to carry out any or all of these activities or comply with the terms and conditions of the permit is a violation of North Carolina General Statute 143.215.1 and may subject the permittee to enforcement action and/or a civil penalty assessment.

If your facility uses a contractor for groundwater sampling, you should still be familiar with the sampling frequencies and parameters, and general requirements of the sampling protocol. If you have any questions regarding your monitoring requirements, contact DWR personnel in the appropriate regional office for your area.

### *5.3 Operation and Maintenance and Site Management*

The main function of a surface irrigation system is the beneficial reuse of a waste product while protecting the quality of the receiver environment. Operators must ensure that all aspects of the operation are addressed. Reconnaissance of the site by the operator is vitally important, not only in site selection, but also to inspect the site for evidence of run-off and to collect samples and inspect crops.

Soil and crops must be properly managed to ensure successful surface irrigation. One way to minimize adverse environmental impacts to the surface irrigation system is to maintain a healthy soil/crop system for final treatment. Ground and surface water must be protected to ensure the integrity of these resources.

Sites must be protected from poor field operations that can result in destruction of soil structure. They must be protected from over-application of metals, nutrients, salts and other waste constituents that may adversely affect the soil/crop system. Adequate monitoring must be established in order to track the volume of applied wastewater and nutrients, as well as protect against the application of potential toxins, particularly synthetic organic compounds and leachable metals.

The operation and maintenance of preapplication treatment components was covered in Chapter 2. This section focuses on the operation, maintenance and management of the soil/crop system and surface irrigation equipment. Areas addressed include:

- soil management
- crop selection and management
- management of wastewater application
- system component management
- emergency action plans

## Managing the Soil

A properly designed surface irrigation system should make maximum use of each soil/crop system on the site. Even when a site has been carefully selected and investigated, soil-related problems can arise. Existing soil limitations must be addressed either by limiting loading rates (hydraulic, salts, etc.) or totally eliminating certain areas due to unsuitable soils or inadequate buffers.

Waste application should be governed not only by weather conditions and soil moisture, but also by the condition of the soil/crop system at the site. If the soil/crop system changes, application rates must change accordingly. Examples of changes that might occur in the soil/crop system include:

- wastewater mounding
- compaction
- surface crusting, buildup of thatch

Not all soil-related problems can be remedied by adjustments in operations. Some situations must be remedied by expansion of the surface irrigation site. This would involve a permit modification and detailed soil information on the proposed area of expansion.

### *Wastewater Mounding*

Even if wastewater soaks into the soil surface as desired, its downward movement may be impeded by a restrictive layer (a layer in the soil that reduces permeability). If so, additional irrigation events can cause the subsurface saturated zone to rise in the soil, resulting in wastewater mounding. A one-foot vertical separation between the seasonal high water table and the ground surface must be maintained at all times. Surface irrigation is prohibited when the vertical separation is less than one foot.

An operator can readily check the level of a perched water table in fields or areas of concern. When wastewater mounding or expected high water levels in soils, you can use an auger or post-hole digger to open a hole in the soil to the depth of your interest. Usually, a hole 18 inches deep will be sufficient to indicate whether there is saturation to the soil surface. Sufficient time should be allowed for the soil water to move into the hole, generally an hour or so. If the water level is within 12 inches of the soil surface you are in a situation where water additions (rainfall or irrigation) may result in rapid lateral subsurface flow, ponding, anaerobic conditions for the crop roots, and potential for runoff or discharge of wastewater.

A more permanent monitoring device can be established by inserting a piece of perforated plastic pipe with a removable cap into the soil. This monitoring device should be marked so it is not damaged by mowing equipment, or set at grade level and marked with flagging or orange paint.

Such simple devices can easily assist the operator in making irrigation decisions that protect the soil/crop system from saturation.

### *Surface Crusting and Thatch Buildup*

Another form of compaction that was discussed in Chapter 3 is surface crusting. In areas where crusting has occurred, it is important to restore aeration to the plant root zone and to provide favorable conditions for crops as well as for soil microorganisms involved in the treatment of the wastewater. Surface crusting can be easily reversed by mechanical tillage to break up the soil surface.

Consequently, additional traffic increases the potential for compaction of subsurface layers. Therefore, the crust should be broken with as light of equipment as possible and the area must be reseeded. Any efforts to re-establish cover crops on areas of crusted soils or thatch buildup should be performed at the most ideal time for planting the crop that is to be used. Crusting can be minimized by maintaining a healthy cover crop and by the removal of mowed or diseased vegetation.

Another form of surface crusting that is often overlooked is the accumulation of thatch, or unharvested grass clippings. It is common in situations where a cover grass is mowed without removal of the mowed grass. Excessive thatch buildup can result in reduced infiltrative capacity of the soil. Thatch remaining on the soil surface acts as a barrier to added water. It can also serve to block the transfer of air (oxygen) to plant roots, causing further stress to the cover crop.

In extreme conditions, anaerobic activity or algae growth can occur on the thatch buildup. An organic or slime layer may form a clogging mat and further decrease water infiltration. If a large enough portion of the site is affected, the result is increased load on the remainder of the site. For all these reasons, thatch buildup should be monitored, and removed promptly if a problem is noted.

It is easier to prevent thatch buildup than to try to remove it. Prevention can be accomplished by frequent mowing, removal of mowed vegetation, and operating the site so that wet conditions at the soil surface are not chronic. Thatch can be removed with special rakes or soil aeration tools. In extreme cases, disking of the field or completely replanting may be necessary. Since these activities result in significant damage or removal of the cover crop, there will be some start-up time required with a new crop during which irrigation volumes must be reduced due to the potential of increased runoff and soil erosion.



### *Compaction*

As discussed in Chapter 3, heavy traffic (especially on wet soils) can cause soil compaction, thereby destroying soil pores and reducing aeration and the effective permeability of the soil profile. Both surface and subsurface drainage and aeration are essential to maintain an aerobic soil environment suitable for wastewater treatment. The maintenance of a stable soil structure is an important means of maintaining good drainage and aeration. Therefore, traffic over a spray field should be limited only to equipment or vehicles that are absolutely necessary for maintenance.

Once soil is compacted, tillage of the soil may be necessary. One of the principal objectives of tillage operations is to maintain or enhance the water infiltration capacity of the soil surface and as well as the air exchange within the entire soil profile. It may be necessary to chisel very deeply (1.5 to 2.0 feet) to loosen the subsoil.

Impermeable pans formed by vehicular traffic (plow pans) or by cementation of fine particles (hard pans) can be broken up by subsoiling equipment that leaves the surface undisturbed and protected by vegetation or stubble. To be effective, however, the subsoiling equipment must completely break through the pan layers. This is difficult if the pan layers are more than one foot thick. Local soil conservation district personnel should be consulted regarding tillage practices appropriate for specific crops, soils, and terrain.

### **Excess Wastewater Constituents**

Wastewater characteristics must be analyzed prior to site evaluation and periodically during operation of a surface irrigation system. Metals such as copper, zinc, manganese or other wastewater components such as salts, pH, oils and grease, organic and inorganic chemicals may prove to be limiting, depending on the plants used at the receiver site. Likewise, if plant species at the receiver sites are changed, wastewater characteristics must be assessed to determine if selected plants are appropriate.

Significant levels of these wastewater constituents may indicate the need for pretreatment of the wastewater prior to final disposal to a receiver site. It is beyond the scope of this manual to discuss all possible limitations that may be encountered with an industrial waste. Operation of systems permitted with these limitations should focus on consistent waste analyses and operation of the treatment units prior to final disposal to the receiver sites. A summary of the potential consequences of these constituents follows.

## *Excess Nutrients*

By monitoring soil test index values for various nutrients, you can take steps to avoid the buildup of nutrients to undesirable levels. In general, wastewater should be applied as a priority in fields where there is evidence of the greatest need for nutrients. The upper limits indicated below should be used as guidelines. Priority for wastewater application should be given to fields that meet the following criteria:

- soil test Zn-I (NCDA & CS) less than 700
- soil test Cu-I (NCDA & CS) less than 700
- soil test P-I (NCDA & CS) less than 150

With so many factors involved, there is no certainty that crops or surface waters will be affected by levels even higher than these guidelines. On the other hand, sensitive crops such as peanuts and some vegetables may be affected at much lower values than shown here. Peanuts are sensitive to zinc at a 500 index if pH decreases below 6.0. Although a surface irrigation system operator may not wish to grow sensitive crops today, at some time in the future those crops may be profitable. Since reclamation of high nutrient soils may be a lengthy process, operators should take precautions to preserve the productivity of their soil resources.

If wastewater must be applied to fields that exceed the above criteria, these options should be considered:

- If the soil test Zn-I is greater than 700, meet with a North Carolina Department of Agriculture and Consumer Services Regional Agronomist or Cooperative Extension Service Technical Specialist to select a crop that is tolerant of high zinc soils.
- If the soil test Cu-I is greater than 700, meet with a North Carolina Department of Agriculture and Consumer Services Regional Agronomist or Cooperative Extension Service Technical Specialist to select a crop that is tolerant of high copper soils.
- If the soil test P-I is greater than 150, then potential for erosion and distance to surface water becomes important. Where soil movement from the field into nearby waters is likely, apply no more phosphorous to the site than the crop will remove to avoid further accumulation of phosphorus.

## *Excess Metals*

As discussed in Chapter 3, excessive application of heavy metals to soils can result in:

- metal uptake by crops;
- metal leaching if soil pH is lower than recommended levels or if high application rates occur;
- yield reduction or crop death caused by high levels of metals in the soil;
- yield reduction in turn may result in reduced nutrient uptake, increased runoff, erosion

- and potential surface and ground water contamination; and
- food chain accumulation of metals that adversely affect animals and humans.

Cadmium, lead, copper, zinc, chromium, and nickel are the metallic ions of most concern to public health officials. Guidelines for permissible levels of heavy metals have been developed by the Division of Water Resources in conjunction with the EPA. Table 5-11 shows maximum regulatory allowable metals loadings for land application of residuals. These loadings are also suggested as a guideline for wastewater application systems.

Table 5-11. Maximum allowable metal loadings for land application of residuals.

Pollutant	Cumulative Pollutant Loading Rate (lb/acre)
Arsenic	36
Cadmium	34
Chromium	2677
Copper	1388
Lead	267
Mercury	15
Nickel	374
Selenium	89
Zinc	2498

Remember that a soil's ability to assimilate heavy metals and other toxic substances is directly related to the cation exchange capacity (CEC), clay content, pH, and organic matter content of the soil. The higher the CEC the more metals a soil can bind, thus reducing the potential for off-site movement. When applying wastewater and sludge to land, special attention must be paid to pH of the soil of the site. If the soil is allowed to become acidic (pH < 6.5), the solubility of heavy metals increases, resulting in excessive accumulation of certain metals in the vegetation.

Metals accumulation rates in soils can be monitored by doing the following:

- analyzing wastewater to determine the concentration of metals
- analyzing soil pH; if soil pH is less than 6.0, lime should be added to adjust the pH
- analyzing soils for metals
- recording total metal loadings over the life of the site

The easiest way to monitor metal buildup is by reviewing the results of the annual soil test. You should follow trends from year to year with metal accumulations. If crop health problems are noted (Figure 5-18), a plant tissue analysis can determine if the problem is metal related. An operator should be able to calculate metal application rates from the annual wastewater application rate and the metal analyses of the wastewater. These calculations will be covered in

## Chapter 6.



Figure 5-18. Heavy metal toxicity in the sandy portion of a field.

### *Excess Salts*

The application of wastewater containing soluble salts, such as chlorides, sulfates, potassium, calcium, manganese, and especially sodium, can be detrimental to not only the crops being grown on the wastewater receiver site, but to the soils as well. A buildup of sodium in the soil can reduce the permeability of the soil by causing dispersion of the clay minerals.

Reduced permeability often results in poor internal soil drainage and aeration, which can cause stress to the cover crops as well as ponding and waterlogged soils that do not provide adequate wastewater renovation. It may be possible (but difficult) to renovate soils with high sodium concentrations. However, the much preferred method of operation is to minimize the risk of possible sodium overload.

Salts in soil can:

- adversely affect soil structure
- upset soil-water balance and interfere with plant root growth and the plant's ability to use water and nutrients
- leach to groundwater
- affect or reduce seed germination

The detrimental effects on plants result not only from the high salt contents, but also from the level of sodium in the soil, especially in relation to levels of calcium and magnesium. In order to understand the management options to restore or prevent damage to the soil, you must first understand the difference between saline and sodic soils.

Saline soils contain concentrations of neutral soluble salts sufficient to interfere with the growth of most plants. When large amounts of dissolved salts are brought into contact with a plant cell, water will pass by osmosis from the cell into the more concentrated salt solution. The cell then collapses, ultimately leading to cell death and eventually plant death.

Sodic soils, dominated by active sodium, exert a detrimental effect on plants in four ways:

1. caustic influence of the high pH induced by the formation of sodium carbonate and bicarbonate;
2. toxicity of the bicarbonate and other anions;
3. the adverse effects of the active sodium ions on plant metabolism and nutrition and the low micronutrient availability due to high pH; and
4. oxygen deficiency due to breakdown of soil structure in sodium dominated soils.

Tolerance of higher plants to saline and sodic soils depends on a number of interrelated factors, including the physiological constitution of the plant, its stage of growth, and its rooting habits. It is interesting to note that old alfalfa is more tolerant of salt-affected soils than young alfalfa, and that deep-rooted legumes show a greater resistance to such soils than the shallow-rooted ones.

In terms of the soil, the nature of the various salts, their proportionate amounts, their total concentration, and their distribution in the soil profile must be considered. The structure of the soil and its drainage and aeration are important as well.

Prevention of the problem is very important. Once sodium and salt damage occurs to the soil, it is a slow and tedious procedure to restore the soil to its original condition. To prevent such damage, an operator must know the sodium concentration in the irrigated wastewater. As discussed in Chapters 1 and 3, a ratio of the sodium concentration to the concentrations of calcium and magnesium in the wastewater is called the sodium adsorption ratio (SAR) and is a good indicator of potential soil problems.

Sodium adsorption ratios in wastewater range from very low (less than 1) to several hundred. Facilities that are especially prone to having SAR problems are the food processing industry, industries that use sodium hydroxide as a wash or disinfectant, or other operations using a form of sodium. A SAR of 10 is generally considered an upper level for safe operation. There are, however, many variables that go along with the SAR that will determine if problems will be expressed in the soil.

A SAR of 5 in a wastewater should be a "red flag" to an operator. At this level, there should be some attention to the sodium issue to ensure that future problems can be minimized. If the SAR exceeds 5, an operator should determine if excess sodium in the waste stream can be reduced. Soil samples should also be analyzed and handled as a problem sample to help determine if the soil sodium activity level is approaching a problem level. Individuals with technical expertise should be contacted if the operator is not experienced with these issues.

While SAR evaluates the sodium status of wastewater, exchangeable sodium percentage (ESP) is an evaluation that can be used to determine possible excess sodium concentration in the soil itself. The ESP is the percentage of the soil's cation exchange capacity (CEC) that is occupied by the sodium cations. This determination can be made from a typical soil fertility evaluation.

An ESP level of 15 percent or higher is typically used to denote a level of concern where salt damage may occur both to the crop and to the soil structure. Levels from 10 to 15 percent should cause the operator some concern, and should justify the need to take remedial action (described above) before long range problems occur. The ESP ratio evaluation should be used in conjunction with calculating the SAR of the wastewater to ensure that salt buildup does not limit or restrict the long-range use of the site.

Three kinds of general management practices have been used to maintain or improve the productivity of saline and sodic soils:

- flushing of the salts
- conversion of some of the salts to harmless forms
- designated tolerance

In the first two methods, an attempt is made to eliminate some of the salts or render them less toxic. In the third, the salts concentrations are not manipulated; rather, crops tolerant of high salt concentrations are grown.

- **Flushing (Salt Removal)** - The most common methods used to free the soil of excess salts are installation of drainage systems and leaching or flushing. A combination of the two, flooding after field drainage ditches have been installed, is the most thorough and satisfactory. The salts that dissolve are leached from the soil profile and drained away. However, the irrigation water used must not be high in soluble salts, especially sodium.
- **Conversion** - The use of gypsum on sodic soils is commonly recommended for the purpose of exchanging  $\text{Ca}^{2+}$  for  $\text{Na}^+$  on the clay surface and removing bicarbonates from the soil solution. Several tons of gypsum per acre are usually necessary. The soil must be kept moist to hasten the reaction, and the gypsum should be thoroughly mixed into the surface by cultivation, not simply plowed under. The treatment must be supplemented later by a thorough leaching of the soil with low-salt irrigation water to leach out some of the sodium sulfate.
- **Tolerance** - The use of salt-resistant crops is another important management tool. Although, salt-tolerant crops are not considered "traditional" recipients of wastewater, many of the crops are high in value and could have the added advantage of income for a wastewater facility. For example, cotton, sorghum, barley, rye, sweet clover, and alfalfa

are particularly tolerant. A crop such as alfalfa, once it is growing vigorously, may maintain itself in spite of the salt concentrations that may develop later. The root action of tolerant plants is exceptionally helpful in improving the condition of sodic soils. Aggregation is improved, and root channels are left through which water and oxygen can penetrate the soil. Table 5-12 lists forage grasses and legumes that are salt-tolerant.

<b>Good salt tolerance, 12 to 6 millimhos/cm</b>	
Alkali sacaton	Rescuegrass
Barley	Rhodesgrass
Bermudagrass	Saltgrass
Birdsfoot trefoil	Tall fescue
Canada wildrye	Tall wheatgrass
Nuttall alkaligrass	Western wheatgrass
<b>Moderate salt tolerance, 6 to 3 millimhos/cm</b>	
Alfalfa	Perennial ryegrass
Beardless wildrye	Reed canarygrass
Big trefoil	Rye
Blue grama	Smooth bromegrass
Dallisgrass	Sour clover
Hardinggrass	Strawberry clover
Hubam clover	Sudangrass
Meadow fescue	Tall meadow oatgrass
Milkvetch, cicer	Wheat
Mountain bromegrass	White sweetclover
Oats	Yellow sweetclover
Orchardgrass	
<b>Poor salt tolerance, 3 to 2 millimhos/cm</b>	
Common white clover	Red clover
Meadow foxtail	Ladino clover
Alsike clover	Burnet
<p><sup>1/</sup> Source: Bernstein, L. 1958. Salt tolerance of grasses and forage legumes. USDA Agricultural Information Bulletin 194.</p> <p><sup>2/</sup> Within each category, the species are ranked in order of decreasing salt tolerance. The low in a higher category may be only marginally better than the high in the next lower category.</p>	

Table 5-12. Salt tolerance of forage grasses and legumes.  
(From National Range and Pasture Handbook).

### *Excess Oil and Grease*

Oils and grease are organic compounds, and in concentrations typically seen in domestic wastewater they pose no problem to the soil organisms that ultimately break down the organic compounds. However, significant inputs of oil and grease can cause problems in a surface irrigation system, both with equipment operation and the soil/plant environment. If oils and grease are allowed to build up in the soil, the result is the clogging of soil pores to the extent that infiltration of water and air into the soil are reduced. This results in stress to the cover crop as well as increased potential for wastewater ponding and runoff. If oil and grease in the effluent

exceeds 50 mg/L, then a process for oil/grease separation should be used as a method of preapplication treatment (see Chapter 2).

### *Synthetic Organic Chemicals*

If an irrigation system is properly operated with no runoff conditions or chronic saturation, most chemicals will be bound to soil particles, volatilized, physically or chemically degraded, and decomposed by soil microbes. Therefore, such chemicals will not present a major problem. However, some facilities may be pre-disposed to certain chemicals in the wastewater resulting from industrial processes. Many of these constituents do not necessarily cause problems to the site, but the breakdown period can be very long (many years), and therefore the operator should be aware of the occurrence of such chemicals and track the buildup or depletion of these chemicals over the years.

If an operator has these chemicals in the waste stream, or suspects that such chemicals might exist in the soils due to past site management, there are tests that can be run to help determine levels of these constituents. Various laboratories may be able to analyze the soil for these chemicals. The standard TCLP test of 40 parameters will note some but not all of the possible chemicals that could reach the land application site. There are also simple assay kits available from several manufacturers that can be used as field tests for these chemicals. These kits are usually specific to the type or family of chemicals that you are targeting.

There are many possible chemicals that could possibly be found in the waste stream at a surface irrigation facility, and it is beyond the scope of this manual to discuss all possible situations. However, an often-discussed persistent organic chemical is poly-chlorinated biphenyl, or PCB. Sites where wastewater contains PCBs must be carefully managed to prevent runoff into surface waters and to prevent grazing animals from ingesting ponded wastewater or wastewater contaminated vegetation. If wastewater analyses indicate PCB concentrations of 10 to 50 mg/kg, wastewater must be incorporated into the soil, not just spray irrigated. If PCB concentrations are greater than 50 mg/kg, wastewater cannot be land applied.

As with other pollutants that find their way to the soil and cropping system, maintenance of good soil fertility, soil pH, and a healthy crop stand are the best defenses to ensure that organic and inorganic chemicals are treated or stored in the soil such that surface water or groundwater quality is not jeopardized. A trained agronomist should be consulted to ensure that the chemical component in question does not pose a problem to the health of the cover crop or the animals or end consumers of that crop. The operator is encouraged to seek out additional information with the aid of the technical resources found in Appendix B-1.



## Selecting Crops

Important factors in the selection of crops for surface irrigation systems include:

- crop management requirements
- nutrient requirements
- time and length of the growing season, use of seasonal overseeds
- end use of the crop
- water tolerance of the crop
- soil type
- local climate conditions

### *Crop Management Requirements*

Crops should be selected with a good understanding of their maintenance requirements. The simpler the maintenance scheme for a crop, the more easily it can be managed.

- **Row Crops.** A row crop is a crop that can be planted in rows wide enough to allow tilling or cultivating by agricultural machinery early in the season. Row crops are annuals, which means they live for just one season and must be planted every year. Examples are corn, cotton, soybeans, and small grains (wheat, barley, and oats).

Row crops are typically not used in wastewater irrigation. Such crops require high maintenance, may have restrictions on end use, and result in long periods of time when the soil is without cover vegetation.

- **Forage Crops.** Forage is the edible parts of plants, other than separated grain, that can provide feed for grazing animals or that can be harvested for feeding later as hay. A variety of forage crops can be grown in North Carolina, ranging from cool-season to warm-season grasses and legumes. Cool season grasses grow actively in the spring and fall, and slowly during the winter. They may go dormant in the summer. Warm season grasses grow actively from mid-April through October 1, and are dormant through the winter. Some forage crops are annuals (live for one season) and some are perennials (live for multiple seasons).

The primary forage crops in North Carolina are tall fescue and coastal bermudagrass. Forages such as annual ryegrass, many species of clover, and others are also grown across the state. Although small grains and soybeans are considered row crops when grown for their grain or seeds, they can also be used as forage for grazing or hay production.

Forage crops grown for hay require mowing, drying, raking, and baling, which must be done during dry periods with no irrigation.

- **Trees.** Using trees as receiver crops at surface irrigation systems is another option for beneficially reusing wastewater while producing marketable products such as timber, fiber, and Christmas trees. Trees are perennials and can remain in place for years. They have extensive root systems and use large quantities of water.

Hardwood plantations have advantages over both natural forests and other plant crops for wastewater treatment. Species can be matched to specific sites to ensure rapid growth. The growth response of hardwoods to irrigation and nutrients in wastewater is high and hardwoods rapidly concentrate nutrients in juvenile tissues. Under short rotations, trees can be whole-tree harvested, removing the nutrients from the site in a non-food chain product. Under medium to longer rotations, high value solid-wood products such as lumber or veneer can be grown.

More information about using trees as receiver crops is contained in Appendix B-5.

### *Time and Length of the Growing Season*

When selecting crops, consider when and how often wastewater must be applied. For a typical municipal system, year-round applications are usually necessary, depending on available storage. For industrial, resort, or recreational facilities, wastewater may be generated seasonally or sporadically.

At systems where wastewater needs to be applied throughout the year, a mixture of crop types offers the greatest flexibility in system management. For a system that serves a campground where the majority of use occurs in the spring and summer, a cool season grass is probably not a good choice.

Year-round application is often possible by using seasonal overseeds. Overseeding is the practice of planting another crop or grass on top of the existing crop. For example, a warm season crop like bermudagrass grown in the summer can be followed by a cool season grass like rye in the winter to help with nutrient uptake and waste treatment.

Some forage species are not tolerant of this arrangement, and an overseeded species may seriously damage the main crop. Examples of grasses, forages, or grains that should be avoided as an overseeding include gamagrass, switchgrass, or bluestems.

When using a winter overseed, you must be careful to protect the warm-season grass. Controlled grazing or harvesting may be necessary to keep the winter overseed from becoming overly

aggressive over the warm-season grass. Attempting to harvest a winter small grain or annual ryegrass in the seed head stage can result in shade damage to a warm-season grass.

### *Nutrient Requirements*

Receiver crops vary in their ability to use nutrients. Crops such as coastal Bermudagrass have very high nitrogen requirements, while crops such as mature forest have much lower nutrient requirements.

The nutrient requirements of a crop impact system operation, both in terms of expense and time. If crops can be economically grown for harvest such as in a commercial farming setting, then the time and cost expended fertilizing crops can be justified. However, if the crop is simply used as a waste receiving point, then a crop with minimal requirements should be satisfactory.

Some crops are more tolerant of nutrient imbalances than others, but all crops will need some attention to maintain the health of the plants and assure proper system operation. In selecting crops, consult an agricultural manual that shows crop nutrient needs and timing during the growing season.

### *End Use of the Crop*

To keep a cropping system viable, it must be harvested at regular intervals. If there is no end use for the crop, less attention may be given to the crop's needs, possibly resulting in poor system management. Having a use for the crop should be a goal of the system owner and operator.

Examples of uses for hay bales include use as a mulch to give away to local residents or for use on municipal property or as feed to livestock. Another use could be to make compost that can be used by the public. Crops with higher cash value can simply be sold as is. Wood products have infrequent harvest intervals, but there should be a planned market for those products if selected for use at the site.

Prior to wastewater application on the following types of crops, additional treatment and disinfection of wastewater and careful timing of wastewater applications may be required:

- **Food chain crops** - any crop for human consumption, or feed for animals whose products are consumed by humans. These include corn, soybeans, small grains, forage crops or tobacco.
- **Direct consumption crops** - crops that are not processed prior to consumption. These include vegetables or fruit that are sold fresh (i.e., sweet corn, green beans, carrots, melons, radishes)
- **Pasture/forage crops** - crops grown for grazing or harvesting into hay.

## *Water Tolerance of the Crop*

A crop that cannot tolerate the extra water it will receive from wastewater irrigation should not be used. Most surface irrigation systems are designed to take the amount of water that can be feasibly handled by the soils. To save on initial costs, the site is often pushed to the maximum hydraulic loading. Crops receive more water than they need, and may have to endure wet soil conditions for extended periods of time.

Some crops cannot tolerate wet soil for very long, while other crops and grasses may even thrive in such conditions. Examples of crops, grasses, and trees that are water-tolerant include reed canarygrass, ryegrass, common Bermudagrass, tall fescue, sweetgum, sycamore, and bald cypress. Examples of crops that are very susceptible to soil wetness problems include alfalfa, coastal Bermuda, and corn.

## *Soil Type*

The crop selected must be adapted to the soil types on the site. On a large site, it is likely that several soil types exist; therefore, it may be necessary to use several crop types. Soils with heavy clay will stay wet longer after irrigation and rainfall events, and the crops must be able to handle these conditions. Sandy soils do not hold water and nutrients, therefore a drought-tolerant crop will survive better, and split applications of fertilizer are needed. Table 5-9 shows the performance of hybrid and common Bermudagrass on two different soil types.

Table 5-9. Performance of Hybrid and Common Bermudagrass on Two Soil Types  
(From Bermudagrass Management in North Carolina).

	Lee County <sup>1</sup> Lakeland Sand	Wake County <sup>2</sup> Cecil Clay Loam		
		1st yr <sup>3</sup>	5th yr	5-yr avg
Tons/Acre				
Coastal	6.0	—	—	—
Common	2.3	—	—	—
Tifton 44	—	2.6	7.2	6.1
Tifton 78	—	2.8	6.1	4.7
Pasto Rico (common)	—	3.3	6.5	5.5

<sup>1</sup> 100 lb N, 50 lb P<sub>2</sub>O<sub>5</sub>, and 100 lb K<sub>2</sub>O applied per acre in April and on July 1. Source: D. S. Chamblee, North Carolina State University.

<sup>2</sup> 75 lb N, 50 lb P<sub>2</sub>O<sub>5</sub>, and 100 lb K<sub>2</sub>O applied per acre in April, July, and August. Source: Forage Variety Test Report, North Carolina State University.

<sup>3</sup> Year of establishment.

### *Local Climatic Conditions*

The crop must also be adapted to the local area. Sometimes, crops are selected for their nutrient removal ability or ability to stand wet conditions, but they may not tolerate the soils or climate. All factors must be considered to select a crop that can be adapted to the site and wastewater applications, and can be managed efficiently.

### **Managing Crops**

Soil and crops must be properly managed to ensure successful surface irrigation. One way to minimize adverse environmental impacts to the surface irrigation system is to maintain a healthy soil/crop system for final treatment.

Establishing and maintaining the crops that have been selected is one of the highest priorities of a surface irrigation system operator. You should examine the health of your crop(s) regularly and take immediate action should you find a problem. Once plants begin to show stress, the problem is often well established and may require significant time and effort to correct. As with other management issues, prevention of problems is almost always easier than repairing problems.

Factors to consider when managing crops include:

- planting
- applying supplemental nutrients
- maintaining soil pH
- controlling erosion
- controlling pests
- removing the crop

### *Planting*

Crops should be planted at the best possible time. Time of planting is important because the survival rate of developing seedlings is related to the time at which stress occurs from drought, freezing, or competition for light and nutrients. Such stress can result in survival and production loss. Years of field research and experience under North Carolina's varied growing conditions have made it possible for researchers to recommend planting dates that will most likely minimize risk and lead to success. Seeding rates and planting depth are also important. See Appendix B-6 for recommendations on planting forage crops.

### *Applying Supplemental Nutrients*

Although many of the nutrients required by crops can be supplied through the application of wastewater, wastewater will rarely supply all necessary nutrients. Nutrient application rates and timing of applications must be appropriate for the selected cover crop. Rarely are nutrients the limiting factor in most wastewater irrigation systems, either domestic or industrial. However, in systems where wastewater is concentrated, nutrients may limit the application rates. Wastewater application systems that are nutrient limited must time application events to appropriate stages in plant growth.

Corn, for example, is typically planted from late March through April and is harvested in September and October. If wastewater is applied from November to March, another crop must be planted (overseeded) to use the nutrients applied during these months. Wastewater applications must be applied a minimum of 30 days prior to grazing or harvest.

Operators must understand the agricultural operations and time their wastewater application events to allow for these windows during which no wastewater can be applied to a receiver site. Sampling to assist in nutrient management decisions is recommended even if not required by the system permit. Table 5-10 describes rates and timing of nitrogen applications for optimum uptake by various cover crops.

### *Maintaining Soil pH*

The single most important component of maintaining soil fertility and a healthy crop is the soil pH. Proper soil pH gives the best range of nutrient availability for the crops, reduces toxicity from aluminum or salts in the soil, and reduces leaching of wastewater constituents (refer back to Figure 3-11). Soil pH can be managed with periodic soil sampling and by following the recommendations given in a soil test report.

Since liming materials are relatively immobile in the soil, surface applications affect only the top two or three inches and are an inefficient means of amending the soil. Thorough incorporation in the rooting zone increases the rate of reaction and treats a larger volume of the soil, maximizing the benefits of lime.

However, this is not feasible in a permanent sod or wooded site, and increases the potential for erosion and runoff. If any spray fields are to be refurbished or planted to a new crop, this is the ideal time to adjust soil pH to the proper depth for good mixing potential. Otherwise, surface liming is the best option for a permanent crop at a surface irrigation site.

Table 5-10. Nitrogen Rates and Timing of Effluent Application to Minimize Soil Leaching Losses and Luxury Consumption by Forage Plants. (From Managing Pasture and Hay Fields).

Forage type	Typical Annual Yield Range (tons/A)	Pounds of PAN N per Ton of Yield	Timing of Applications
<b>Bermudagrass</b>			
All pasture	4-5	30-40	At green-up in mid April, thereafter at 3 to 5 week intervals until Sept. 15
All hay or silage	5-8	40-50	At green-up in mid April, thereafter at 4 to 5 week intervals until Sept. 15
Pasture + overseeded	5-6	30-40	For bermudagrass same as above. For rye, Oct. and Feb. with rye in Sept. or Oct.
<b>Fescue</b>			
All pasture	2-4	30-40	1/3 Feb. 15-28; 1/3 April 1-15; 1/3 Sept. 1-15.
All hay or silage	3-5	40-50	1/3 Feb 15-28; 1/3 after first cut; 1/3 in Sept.

Fall liming has many advantages. Lime has more time to react with the soil before the period of most rapid growth begins in the spring. Lime may also react more rapidly due to lower pH in the fall. In addition, soils are generally drier and more accessible in the fall than in the spring.

### *Controlling Erosion*

Crops must be managed to reduce soil erosion and nutrient losses. Perennial grass sods are particularly effective in this regard. When a field has a thick perennial cover, there is far less runoff, therefore less chance for fertilizers to be washed away. In addition, most perennial grasses form dense root systems, which effectively serve as filters to remove contaminants before they can seep into the ground water.

Even if a given field is used for row crop production, forages may be used in conjunction to reduce erosion. Grassed waterways, grassed terraces, strip cropping, and long term rotations using forages are good examples. Erosion control is discussed further in the section below on Best Management Practices (BMPs).

### *Controlling Pests*

Inspect crops periodically for pests. A discussion of all possible pests on all crops that may be grown on wastewater application sites is beyond the scope of this manual. There are good resource guides and technical experts with the Department of Agriculture and the Cooperative Extension Service that can assist with pest problems.

Restricted use pesticides must be used in accordance with label directions and only licensed applicators can apply certain restricted use products. Anyone responsible for purchasing and applying restricted pesticides must be licensed by the North Carolina Department of Agriculture and Consumer Services.

Pesticides in groundwater can result from problems that occur when pesticides are mixed or loaded, such as spills or back-siphoning. These are "point sources," or small areas of high concentrations of pesticides that can contaminate large areas of groundwater over time. Point source contamination can be located and cleaned up. Good construction and maintenance of the pesticide mixing and loading area can prevent most of these problems.

Pesticides can also make their way into groundwater from fields where they are applied. Pesticides can leach through the soil as water or wastewater percolates downward. The likelihood of a pesticide leaching depends largely on its solubility (its ability to dissolve in water). If a pesticide is highly soluble, it is more likely to reach the groundwater. On the other hand, many pesticides, even some that are soluble, are likely to stick to soil particles by adsorption. Thus, if the probability of adsorption is high, less of the pesticides will leach.

Proper management of pesticides should be practiced in order to protect our water supplies. When applying pesticides:

- read container labels thoroughly;
- use the lowest effective rate listed on the label for any one application; the thought that "if a little will do a little good, a lot will do a lot of good" is a fallacy;
- correctly identify pests so that you use the proper pesticide and do not wastefully apply inappropriate materials;
- sweep granules of pesticide that may fall on impervious areas such as sidewalks and driveways into a vegetated area;
- calibrate spreaders and sprayers so that you know how much pesticide you are applying to an area; and
- learn about alternative pest control measures, such as beneficial insects, crop rotation, residue destruction, varietal resistance, proper planting dates, and companion cropping systems that may be good alternatives for your pest management problem.

For more information about pesticides application, contact your local Cooperative Extension Service Center, regional agronomist with the North Carolina Department of Agriculture and Consumer Services, or consult the North Carolina Agricultural Chemicals Manual, which is published annually.

### *Removing the Crop*



Many of the nutrients and other waste constituents supplied to the crops through the application of wastewater end up being incorporated into plant tissue. Consequently, it is important that the crop and its nutrients be removed through harvest. The soil can store some nutrients and metals, but its capacity is limited.

Removal of the crop and its stored nutrients is essential. Otherwise, nutrients are returned to the soil as crop residues decompose. For example, forage crops are often mowed and baled, and simply left in the field to rot. The nutrients are not removed and are returned to the soil. Failure to remove the crop can lead to excessive nutrient levels on the site, potential plant toxicity, and surface water or groundwater contamination.

### *Troubleshooting*

Diagnosing the needs of plants is comparable in many ways to diagnosing human ills. The medical doctor observes the patient, obtains all the information possible with his questions, and then makes the appropriate tests, all of which are helpful in diagnosing the case. Similarly, the wastewater operator observes the plants, obtains information on past management, and may make tests on the soil or the plant. The success of the diagnosis depends on the understanding of the fundamentals of plant and soil science and on a correct interpretation of the test results.

Diagnostic measurements of the ailing plant or soil are often classed as troubleshooting. Plant and soil samples can and are being used for this purpose, but a more important application is in preventive measures. By the time a plant is showing stress, it may be too late. Consider the analogy of closing the barn door after the horse has left. In order to be proactive in the crop management, you need to know stress symptoms of plants.

Many of the methods for evaluating soil fertility are based on observations of or measurements on growing plants. These methods have considerable merit because the plants act as integrators of all growth factors (aeration, fertility, moisture, pH) and are the products in which the operator is interested. An abnormal appearance of the growing plant may be caused by a deficiency of one or more nutrient elements. If a plant is lacking in a particular element, characteristic symptoms may appear. This visual method of evaluating soil fertility is unique in that it requires no expensive or elaborate equipment and can be used as a supplement to other diagnostic techniques.

Examples of stress symptoms are:

- complete crop failure at seedling stage
- severe stunting of plants
- specific leaf symptoms such as changes in coloration appearing at varying times during the season
- delayed or abnormal maturity
- obvious yield differences, with or without leaf symptoms

- poor quality of crops
- poor germination, resulting in reduced stand coverage

It is often difficult to distinguish among the cause of the symptoms in the field. Disease or insect damage frequently resembles certain micronutrient deficiencies. For example, leaf hopper damage is often confused with boron deficiency in alfalfa. If symptoms are observed early and are correctly diagnosed, there is a chance you can correct them during the growing season. Crop health may suffer during the first year, but if the trouble is properly diagnosed, the symptoms may be fully corrected the following year.



Figure 5-15. Poor crop stand in a fescue pasture. The lighter areas indicate stunted or dying vegetation.

If a cover crop is not present, or is in poor health, the operator should start the troubleshooting process. The following steps should be included when attempting to establish a cover crop or repair an existing cover crop:

- obtain a representative soil sample;
- if crop is present but in poor shape, obtain a plant tissue analysis;
- check the area to see if prolonged saturation or soil compaction is a problem;
- select a crop or combination of crops suitable for the soil and site conditions, and one that can be managed in a wastewater application environment;
- apply recommended nutrients and/or pH adjustments from the soil test results;
- prepare to plant or seed the crop following all recommendations from the supply store, or contact local experts with the Cooperative Extension Service (CES) or North Carolina Department of Agriculture and Consumer Services (NCDA & CS&CS); and

- implement Best Management Practices (BMPs) recommended by a trained agronomist, soil scientist, or conservationist.

See Appendix B-1 for a list of state and federal agencies that may be able to provide technical assistance for surface irrigation systems. Each agency is listed with a summary of its primary responsibilities, and the local or area offices that the agency maintains throughout the state. You are encouraged to use the expertise of the staff of these agencies as you manage your waste application site.

## Managing Wastewater Application

Although proper location of surface irrigation sites is important, it is no assurance that surface and groundwater contamination problems will be eliminated. Waste application activities must be planned and managed to prevent adverse impact on the groundwater, surface water, and public health. Adverse environmental impacts of surface irrigation can be minimized by proper management of:

- irrigation application rates (quantity of wastewater applied)
- wastewater constituents (quality of wastewater applied)
- irrigation system performance
- emergency action plans

Adverse effects are minimized by maintaining setbacks, controlling the quantity and quality of wastewater applied, and maintaining a healthy crop/soil system for final adsorption and treatment of the wastewater. During the site selection and identification process and throughout the wastewater application operation, setback distances between surface water bodies and receiver sites must be clearly identified and maintained.

### *Irrigation Rates*

Surface irrigation permits require that you take adequate measures to prevent effluent ponding in or running off of surface irrigation fields. Ponding, runoff, and prolonged saturation can be avoided by ensuring the hydraulic loading is maintained within the levels acceptable by the soil system. For systems that are not nutrient limited, application events can occur as necessary to provide the nitrogen or phosphorous requirements, but should not exceed the hydraulic capacities of receiver sites. In addition, irrigation is not permitted during wet weather conditions or when the ground is frozen.

The permits that are issued in North Carolina for wastewater irrigation typically require the suspension of land application activities during inclement weather or until 24 hours following a rainfall event of 1/2 inch or greater during a 24 hour period.

### *Uniform Distribution*

Uniform distribution of wastewater effluent at the irrigation site is necessary to ensure that the entire receiver site is used to renovate the wastewater, and to minimize overloading of any particular area. However, as we will discuss below, there may be design features in the irrigation equipment that are intended not to apply effluent evenly across a field. These design features may be required due to changes in soil conditions, slopes, or nearby drainageways.

Even when a site has been designed to receive uniform application across an entire field, adjustments may be required. The operator knows from experience that he/she cannot operate the system on that field or area at a uniform application rate without runoff or ponding of wastewater. Ultimately, it is the operator's responsibility to operate the system within the requirements of the permit, which includes no ponding or runoff. Any design modifications must be agreed upon by the system operator, the system designer, and the Division of Water Resources.

### *Hydraulic Overload*

One goal of proper waste application is to apply wastewater at a rate that will result in neither runoff nor saturated conditions. This means that the wastewater will slowly soak into the soil and be useful to the crop as both a water and nutrient source. Ponding, runoff, surfacing or prolonged periods of saturation are undesirable.

Over-application of wastewater often results in periodic wetness, runoff, or ponding of effluent. The fact that a given site is permitted for 50 inches of wastewater application per year, or for 0.5 inches per irrigation event, is no guarantee that these application rates can be maintained every year or at all times during the year.

An area that is continually overloaded hydraulically will soon be obvious to the operator. The crop in that area may be taller or greener than in surrounding areas. If the situation is very bad, the local area may exhibit signs of crop stress or death due to chronic saturation. Another problem with chronic saturation is that it will eventually break down the soil structure, making the area even less permeable than it originally was. Crop harvest or maintenance procedures may have to be delayed or ignored if wet spots in the field are a problem.

Areas that are prone to wetness, or hydraulic overload, include the heads of drainageways, soils with less permeable layers, compacted soil areas, areas with poor cover crops, and areas at the base of slopes.

Low areas that naturally receive more runoff must be loaded differently than areas on smooth upland positions. Effluent must be distributed to avoid localized ponding or overloading of a specific area. For example, if 30% of the spray nozzles are not working, the remaining portion of the field must treat an increased volume of effluent. This localized hydraulic overloading may result in either wastewater runoff (Figure 5-17) or insufficient treatment of wastewater in the soil/crop system.

Operational items that can help minimize the potential for hydraulic overload include:

- changing nozzles in wet areas to nozzles that deliver less wastewater per unit time;
- valving or capping individual risers so that they can be turned off to limit wastewater application or to reduce bleed-off;
- valving individual lateral or manifold lines to accomplish wastewater application reduction;
- using directional sprinklers to avoid slowly permeable areas or landscape positions;
- using subsoiling equipment to revive the soil permeability; and
- enhancing soil infiltration rate with good crop management and conservation practices.



Figure 5-17. Runoff from a surface irrigation site.

In most irrigation systems, a condition known as "bleed-off" is experienced when an operator ends an irrigation cycle. The water remaining in the distribution system will typically run to the lowest lateral and spray nozzle, and effluent will trickle out of this nozzle, sometimes for many minutes before the distribution lines are clear. This condition can result in local overloading of effluent, and the possibility of ponding or runoff. An operator can account for bleed-off in one of two ways:

- the irrigation cycle can be stopped early enough to anticipate the bleed-off and still have the soil in the bleed-off area absorb the effluent; or
- the operator can install hardware to stop or spread out the bleed-off condition to minimize any localized overload.

### *Winter Operation*

Most surface irrigation systems in North Carolina operate throughout the winter months. Some facilities, such as summer camps or resorts, operate on a seasonal basis and may generate little to no wastewater during the winter and so may not need to operate their surface irrigation equipment during this time. If a system is to shut down completely during the winter, necessary precautions for freezing must be taken. Appendix B-7 addresses the winterization of irrigation equipment.

Systems that operate through the winter also need to be aware of the effects of cold weather on surface irrigation operation. Foremost, surface irrigation onto frozen ground is prohibited. Frozen soil is much more of a problem in an open field than in a wooded site. A dense stand of grass also helps reduce the extent of frozen ground. During cold weather operation, the operator should walk the fields prior to any irrigation events and verify that the entire field has thawed and can accept wastewater. Cold temperatures also result in slower drying times, and therefore reduced application depths, as discussed in the irrigation scheduling section, must be considered. This may necessitate more frequent irrigation cycles of briefer duration when using a solid set or drip system, and different settings on mobile units such as traveling guns or center pivots.

If water is allowed to remain in the irrigation lines on very cold nights, problems with freezing and equipment damage can result. The vulnerable areas are the risers, exposed valve boxes, above-ground piping, and suction or discharge piping from the pump (if not protected in a pump house or underground pump vault). On mobile systems, gun carts and center pivot towers are very vulnerable to freeze damage. Most irrigation risers are equipped with underground drain or weep holes that allow the water in the riser to soak into the soil after the pump has been turned off and the pressure in the line decreases. The operator must be sure that any above-grade valves are opened so that water is not trapped in the equipment.

Other units such as traveling gun carts and center pivots have caps or plugs that must be removed to allow drainage of the above-ground piping. Where above-ground piping is used, this pipe should be separated in several places, especially low areas, and allowing water to drain from the pipe. Traveling gun hose reels should be moved under shelter if possible. Some units recommend purging some of the water with forced air; others do not require special freeze protection for the hose. All, however, require drainage of all fittings, turbines, and feed lines to protect the components and the warranty. Usually, cold spells in North Carolina are of short duration. The

operator simply needs to be aware of weather forecast in order to implement the above recommendations when necessary.

## Management of System Components

The operator of a wastewater irrigation system must be familiar with the physical components that make up the system, how they work, and a schedule of maintenance and troubleshooting to ensure proper operation of the system. This section focuses on the following system components:

- surface irrigation equipment
- drainage systems
- soil and site components
- operation and maintenance manuals
- records

### *Surface Irrigation Equipment*

An irrigation system is an expensive investment. Regular maintenance procedures will help keep your system operating properly for many years. Following these procedures also reduces the risk of equipment failures that may lead to lost production time or crop loss. These procedures are particularly critical in wastewater application systems, where equipment failures could result in a discharge of liquid wastes and damage to the environment.

The original operation and maintenance manual for a piece of irrigation equipment is your primary source of information regarding its required maintenance procedures. If the manual cannot be located, ask your local dealer or equipment manufacturer for a replacement. Appendix B-7 contains an excellent publication that outlines the maintenance procedures for various types of surface irrigation equipment:

- annual maintenance procedures for sprinklers;
- lubrication and fluids schedule for hard-hose travelers;
- seasonal maintenance checklist for center-pivots and linear-move systems;
- weekly, quarterly, and annual maintenance for pumps;
- inspection and maintenance schedule for electric motors that power irrigation pumps;
- inspection and maintenance schedule for diesel motors that power irrigation pumps; and
- winterization and storage procedures for hard-hose travelers, center-pivot and linear-move system, pumps, and engines that power pumps.

Very wet spots in a field or along the piping to a field can indicate a leak or break in the distribution network. Valve junction boxes are a common place to find leaks in the system. Leaks can be caused by freezing water in the lines or spray risers, damage from equipment, or failure of the part. Usually, a leak in the distribution system is easy to spot, as there will be a chronic wet area regardless of the amount of spraying. Not only could this lead to a violation due to wastewater

ponding and runoff, but it also affects the performance of the rest of the system where flow has been reduced.

Rotating spray heads can be another place for equipment damage or malfunction. A spray head that is stuck in one position can easily result in a large amount of effluent being applied to a small area, soon resulting in runoff of wastewater. Spray heads should be monitored frequently for proper operation. Something as simple as a piece of trash can cause a small diameter spray head to clog or remain stuck in one position. Spray heads should be cleaned and maintained regularly. Where rust or corrosion prevents proper operation, replacement may be the best option.

### *Flow Meters*

There are two important tools can assist an operator with irrigation scheduling. The first is a rain gauge (or set of gauges). The other is a well-calibrated flowmeter. The flowmeter shows the operator the volume of water that is being applied to the irrigation fields. Often flow is measured by multiplying the pump capacity (gallons per minute) times the pump run time (minutes). The flaw in this technique is that it assumes that the pump is operating at full or "rated" capacity. This rarely is the case, due to such issues as pump wear, design of the system, friction losses that increase with pipe and nozzle wear or clogging, etc. A flowmeter gives a much more accurate reading of applied wastewater, assuming that the flowmeter is properly and frequently calibrated. This information tells the operator how much applied wastewater is being combined with the measured rainfall and will help with irrigation scheduling and overall operation. Using a flow meter is also crucial in helping to determine the amount of nutrients, salts, or other wastewater constituents that are being applied.

Another place where the use of a flowmeter is recommended is on the influent side of the wastewater treatment system. Monitoring this flow shows if the system is being operated in compliance with permit limits, and whether there are additional inputs of wastewater coming to the system. Additional inputs can include illegal attachments to the collection system or infiltration and inflow. If flow measurements are higher in response to rainfall, then there are leaks into the collection system that should be repaired. Such leaks can usually be located with a smoke test.

Removal of surface water inputs is often quickly remedied. Leaks in underground piping due to old or broken collection lines can be very difficult and expensive to repair. Monitoring these items helps the operator be aware of the overall system operation, and gives the operator information that should be used for irrigation scheduling. Knowledge of additional flows is also important to minimize the potential hydraulic overloads to the spray fields that could cause ponding, runoff, or crop stress.



Flowmeters must be regularly calibrated to the manufacturer's specifications. Using a flowmeter that has not been calibrated can create more problems than not having a flowmeter at all. Flowmeters should be installed where the risk of corrosion from such devices as chlorinators or other chemical injection systems is minimized. Usually, the dealer who sells the flowmeters has a specialist who can perform the calibration.

### *Plans and Specs*

As an operator, you should have a set of system plans and specifications that specify the equipment at the facility. These documents may specify the flow rate or application rate of the irrigation equipment with which you are working. However, those specifications are only valid as long as the pump is run at a certain speed, the equipment is new, the valves are all in the appropriate position, and there are no changes made to the system (such as adjusting valves or replacing spray heads). Information presented in manufacturer's charts is based on average operating conditions with relatively new equipment.

All system components should have specification sheets showing details of the units as well as operation and maintenance requirements. These are usually included in the O&M plan or attached as a supplement. If this information is not present, the operator should contact the manufacturers directly. Equipment will usually have a specification plate mounted somewhere that shows the company name, location, and model or serial number of the component. The manufacturer can be called for information on servicing the units. If the manufacturer is no longer in business, a local repair service may be able to provide service or information. If no information is available, you should service units similar to other units with like components.

### *Equipment Wear*

Discharge rates and application rates change over time as equipment gets older and components wear. In particular, pump wear tends to reduce operating pressure and flow. Nozzle wear results in an increase in the nozzle opening, which will increase the discharge rate while decreasing the wetted diameter. Extreme nozzle wear can result in pressure decreases substantial enough to affect sprinkler rotation. To ensure proper placement and rate of wastewater delivery, proper calibration of equipment is necessary. Improper calibration and equipment maintenance will result in over or under application of wastewater and uneven nutrient distribution. Equipment calibration was discussed earlier in this chapter.

When replacing equipment, be sure that the replacement unit is satisfactory for the job. Replacement equipment must have the same rating, require the same power requirements, etc. so that it can be interchanged without affecting the overall functioning of the system.

All mechanical components will have some type of servicing requirements. Failure to perform regular maintenance results in equipment that does not last as long, and the possibility of premature failure during operation. Equipment failure at the wrong time could lead to a significant spill or leak of wastewater, causing a permit violation and possible threat to the surrounding environment.

### *Drainage Systems*

The operator of a land-based wastewater treatment system needs to know if a drainage system exists either in the area being irrigated or the areas surrounding the irrigation site. Drainage can be a subsurface tile drainage system, surface ditching, or a combination of both. The operation of the wastewater system may be dependent on proper functioning of the drainage system. If such a drainage system exists, there should be references to it either in the permit or the design plans and specifications, and possibly both. Often a drainage system is used to shed surface water away from a wastewater receiver site.

Drainage systems need periodic attention to ensure proper operation. The most important component is the management of the drainage outlet. The operator should be aware of all drainage outlets. These should be well marked and maintained and kept free of vegetation that could obstruct the outflow of water from the drainage system. Piped drainage outlets should be protected by an animal guard to prevent stoppage from animals that may move into the outlet pipe. Proper erosion control is also needed at the outlet to stabilize the drainage water and ensure that erosion does not damage the outlet area.

Another maintenance responsibility is simply to ensure that the drainage system is performing its function. After a soaking rainfall, inspect the outlets to ensure that the system is working. Clogging could occur at any length of the pipe. Drainage pipes can become clogged with sediment or broken by heavy equipment. If the drainage system is not moving water as expected, the operator should walk the system to look for places where clogs may have occurred. These may appear as wet spots along the drainage lines. Subsurface drainage systems can fail when the pipe is crushed or if holes or breaks occur. Also, if the system does not have the proper grade for water flow, as can happen with uneven settling, there can be problems with the drainage system working as designed. Uneven ground surface along the drain lines can also be an indication of a break in a subsurface piping network.

Terraces and surface water diversions are designed to shed surface water. In addition, some may have a gravel or "French" drain incorporated into them in order to help with subsurface water removal (Figure 5-19). These surface water diversions must be properly vegetated to minimize erosion caused by the moving water. Erosion can readily change the slope or grade of the structure and affect its operation.

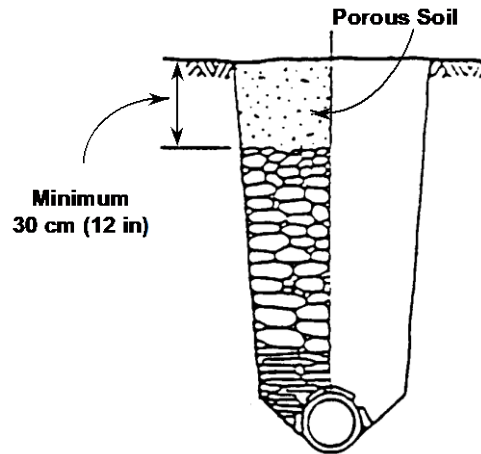

Figure 5-19. Cross section of a french drain.

On the other hand, if a surface water terrace or diversion becomes filled with sediment and loses its depth, runoff water designed to be trapped in the diversion may eventually overtop the structure. The original design criteria for all such structures should be maintained on the site, and the structure should be periodically monitored to ensure that it is at or near design specifications. If necessary, remove sediment or repair eroded areas to keep the structure at design criteria.

## Emergency Action Plans

Using resource lists in Appendix B-1, you should develop an emergency action plan for your waste management system. This plan must be implemented in the event that wastes from your operation are leaking, overflowing, or running off the site. You should NOT wait until wastes reach surface waters or leave your property to consider that you have a problem. You should make every effort to ensure that this does not happen. This plan should be available to all employees at the facility, since accidents, leaks, and breaks can happen at any time.

Your plan should follow this format:

1. stop the release of wastes;
2. assess the extent of the spill and note any obvious damages;
3. contact the appropriate agencies; and
4. implement procedures to rectify the damage.

The emergency action plan must include provisions for emergency spraying or transfer of waste from all waste storage structures in the system. This may include emergency pumping (to prevent

overtopping of a storage structure) during periods when the soil or crop conditions are not conducive to normal application. **DWR must be contacted for guidance to irrigate waste in such instances.** You should consider which fields are best able to handle the waste without further environmental damage. Application rates, methods, and minimum buffer distances must all be addressed.

The emergency action plan should be available and understood by all employees at the facility. The main points of the plan (order of action) along with the relevant phone numbers should be posted by all telephones at the site. A copy should also be available in remote locations or vehicles if the land application sites are not close by the facility office. It is the responsibility of the owner or manager of the facility to ensure that all employees understand what circumstances constitute an imminent danger to the environment or to the health and safety of workers and neighbors. Employees should be able to respond to such emergencies and notify the appropriate agencies of conditions at the facility.

## Best Management Practices

A best management practice (BMP) can be any practice that reduces the movement of waste products (including odors) away from the receiving site, and into ground or surface water or to other properties. Best management practices are structural or operational practices that help you operate a waste management system with the least chance of negative impacts on the environment. Crops as well as crop residues, cultural practices and structures are used alone or in combination to hold the soil in place and allow water to move into it rather than to run off the surface.

Best management practices relating to nutrient management are those practices that optimize nutrient uptake by plants and minimize nutrient impact on the environment. These are very site specific and a BMP in one place may not offer the same benefits in another location. Therefore, specific BMPs may or may not be mandated in regulatory documents. A trained agronomist or soil scientist is the best resource to assess whether a particular BMP is appropriate for your situation if it is not already included as a condition of the system permit.

BMP'S at a surface irrigation site may include:

- **Performing Soil Tests.** Nutrients should be applied to soils only as necessary. To know the soil's nutrient-supplying capacity, you must have it analyzed by a soil test laboratory. Soil samples should be sent to a laboratory that uses testing procedures developed specifically for your soil conditions.
- **Follow Soil Test Recommendations.** A soil test report indicates the amount of nutrients that the soil can supply and recommends the amount, if any, needed from other sources.

The test also recommends appropriate amendments (such as lime or sulfur) to adjust soil pH to the proper range for plant growth. All of the recommendations should be followed because a deficiency of one nutrient or an undesirable soil pH will limit crop response to the other nutrients.

In North Carolina, a reliable soil test for nitrogen has not been developed, but a range of nitrogen rates are given on the soil test report for non-legume crops. Within the range given, the actual amount of nitrogen added should be based on crop yield goals and adjusted for specific soil, weather, and crop circumstances. Your county Cooperative Extension Service agent or other professional agronomist can help you determine the proper application.

- **Set Realistic Yield Goals.** All fertilizer recommendations assume a certain yield goal for the crop to be grown. Some laboratories ask for your goal, whereas others use an average number. The yield history of a field is the best guide to realistic expectations. Also, county soil surveys include crop yield estimates by soil series. Factors such as the soil's moisture supplying capacity should be considered.

Do not over apply nutrients in the quest for unrealistic yields. Applying excessive amounts of nutrients is a waste of money and can contribute to water pollution. Over applying nitrogen is especially risky since it can easily be lost from the soil.

- **Apply Supplemental Nitrogen and Phosphorus Correctly.** Nitrogen and phosphorus are less likely to be lost by erosion or runoff if they are banded directly into the soil or applied to the soil surface and promptly mixed into the soil by disking, plowing, or rotary tilling. Subsurface banding also makes it possible for nutrients to be placed directly where the crop can make the best use of them.

Surface application of nitrogen and phosphorus without incorporation is the least desirable method of applying fertilizer, but it is often used for pastures, lawns, turf, and other perennial crops. Because phosphorus is relatively immobile, phosphorus should be incorporated into the soil before perennial crops are established. Where surface application is unavoidable, minimize the use of phosphorus. Aeration equipment can be used to improve soil infiltration and nutrient movement into the soil. The application method (surface applied or banded) has little effect on losses of nitrogen by leaching.

- **Time Nitrogen Applications Appropriately.** The timing of application is more important with nitrogen than with any other nutrient because nitrogen is applied in large amounts to many crops and is very mobile. Phosphorus, on the other hand, is very stable once it is mixed into the soil and can be applied when most convenient. Timing of nutrient application to coincide with plant growth requirements increases uptake efficiency and reduces exposure of applied nutrients to surface runoff and subsurface leaching.

Optimum time of application depends on type of crop, climate, soil conditions, and chemical formulation of the fertilizer. Fall application of nitrogen can result in surface and subsurface losses of nitrogen, especially on sandy soils.

- **Control Erosion.** All nutrients can be lost when soil is eroded, but phosphorus is especially vulnerable. The primary way to prevent phosphorus loss is to control erosion. With few exceptions, if no sediments leave the land, little phosphorus leaves. Many erosion-control BMPs can be used in various cropping systems across North Carolina. A conservation farm plan providing for erosion control should be developed with assistance from the Natural Resources Conservation Service, USDA, and your county Cooperative Extension Service agent. Some specific practices are:
  - **Maintain vegetation on ditch banks and in drainage channels.** Try not to disturb vegetation in drainage channels such as ditches and sod waterways. If necessary, construct ditches larger than needed so the bottoms can be left vegetated to trap sediment and other possible pollutants. Seed ditch banks and prevent ditch bank erosion by proper sloping and by diversion of field runoff water.
  - **Slope field roads toward the field; seed roads with a permanent grass cover.** Water erosion and dust from traffic on field roads contribute significantly to soil loss and potential pollution. Do not plow field roads when preparing land. Shape roads for good drainage, and seed them with a perennial grass where possible. Direct field road runoff toward the field or into a sodded waterway and away from any bordering ditch or canal.
  - **Shape and seed field edges to filter runoff as much as possible.** Do not plow up to the edge of the field, especially along ditches or canals. Leave a buffer strip along drainage ways, and establish a perennial sod. Shape and seed hoe drain outlets to filter runoff.
  - **Use windbreaks and conservation tillage to control wind erosion.** Wind erosion can be minimized by leaving the soil surface rough, maintaining crop residue on the soil surface, bedding to trap wind-blown sediments, keeping the soil wet, or maintaining a cover crop.
  - **Maintain a soil cover.** Where feasible, use no-till methods, which may be the only way highly erodible land can be cropped without excessive soil loss. On soils that are subject to erosion or leaching, use a winter cover crop to reduce erosion and to take up nutrients, thereby reducing leaching. A cover crop used in this way is called a "trap crop" since it "traps" and recycles nutrients for use by later crops.

- **Manage Water Flow.** Water management is closely related to erosion control, and some practices overlap. In this section we are referring to water from rainfall, ***not wastewater irrigation***. In general, erosion is minimized when water flow is slowed or stopped. Some specific practices are :
  - **Slow water flow.** Use contour tillage, diversions, terraces, sediment ponds, and other methods to slow and trap rainfall runoff. The carrying capacity of running water is directly proportional to the flow rate. When water is still, sediments can settle out. Production practices such as installing water-control structures, such as flashboard risers, on field ditches in poorly drained soils benefit water quality significantly by reducing downstream sediments, phosphorus, and nitrogen. Sediments and associated phosphorus settle out of the drainage water, and nitrogen can be denitrified or used by stream vegetation. It is estimated that water-control structures have been installed on about 200,000 acres of land in eastern North Carolina during the last few years, and that nitrogen runoff has been reduced by over one million pounds per year.
  - **Preserve buffer strips.** Leave buffer areas between fields and environmentally sensitive areas (see Figure 5-16). The amount of buffer needed varies with the cropping activity and the nature of the adjacent area. In some cases, buffers are mandated by law.
- **Use appropriate crops.** Deep rooted crops, including alfalfa and to a lesser extent soybeans, will scavenge nitrates that leach past the usual soil rooting zone. Used in crop rotation following shallow rooted or heavily fertilized row crops, deep-rooted crops will recover excess nitrate from the soil and reduce the amount of nitrate available for leaching to groundwater.



Figure 5-16. Riparian buffer zones lining stream banks.

No single set of BMPs applies in all situations but when properly carried out, BMPs can improve water quality. Many studies document water quality improvement in streams adjacent to where BMPs have been used in surrounding agricultural areas. If BMPs are not performing their functions as designed, you should contact a trained agronomist, soil scientist, or conservationist for advice on appropriate remedies.



## Chapter 6

### Math

#### *6.1 Introduction*

A number of calculations are used in the operation of a waste treatment system. Some, such as the surface area and volume of the various treatment process tanks and equipment, need to be made only once and recorded for future reference. It may be necessary to perform others, such as run time or travel speed each day. In either case, you should be familiar with the calculations and understand specific formulas.

It is important that the appropriate units be written with each number used in all waste treatment calculations. This allows the units to be multiplied and divided as though they were numbers and allows the correct units to be included in the results. Carrying units properly through a calculation also serves as a check on the calculation as well as indicating units that need converting. In the following examples, note that all numbers have units with them: square feet, inches, gallons, etc. In several cases, factors have been supplied to simplify calculations. These factors have no units but supply the proper unit conversions.

Inaccurate measurements and calculations can result in erroneous reports and costly operational decisions. Accurate measurements and calculations are important tools an operator can use to properly control and manage waste treatment processes.

#### *6.2 Types of Calculations*

A spray irrigation system operator must be familiar with a variety of calculations. In addition to calculations relevant to water flow and waste treatment management, there are calculations relevant to the management of soils, crops, fertilizers, salt and nutrient loadings, and spray irrigation equipment.

Calculations needed for wastewater treatment include:

- fractions, decimals and percentages
- measurements (length, area, volume)
- detention time and storage
- concentration of wastewater constituents (pounds formula)
- flow and hydraulic loading rates
- horsepower
- pump delivery rate

$$\text{PPM} = \frac{1 \text{ part}}{1,000,000 \text{ parts}} = \frac{1 \text{ inch}}{1,000,000 \text{ inches}} = \frac{1 \text{ inch}}{15.78 \text{ miles}}$$

Calculations needed for soil and crop management include:

- hydraulic soils loading rates
- plant available nitrogen calculations
- salt application from wastewater constituents

Calculations needed for management of irrigation equipment include:

- application rate for stationary sprinkler systems
- application run time for stationary sprinkler systems
- application rates for traveling sprinkler systems
- application depths for traveling sprinkler systems
- travel speed for traveling gun sprinkler systems

## Mathematical Relationships and Conversions

Fractions, decimals, and percentages are related to each other and may be mathematically manipulated to convert from one to another.

The following conversion chart is a good reference to refresh your understanding of basic relationships and is expanded to include concentrations, parts per million (PPM) (mg/L), and parts per billion (PPB) (µg/L).

Fraction	Decimal	Percent	PPM*	PPB*
1/1	1.0	100	1,000,000	1,000,000,000
1/10	0.1	10	100,000	100,000,000
1/100	0.01	1	10,000	10,000,000
1/1,000	0.001	0.1	1,000	1,000,000
1/10,000	0.0001	0.01	100	100,000
1/100,000	0.00001	0.001	10	10,000
1/1,100,000	0.000001	0.0001	1	1,000

\* For Water Only

$$\text{PPB} = \frac{1 \text{ part}}{1,000,000,000 \text{ parts}} = \frac{1 \text{ inch}}{1,000,000,000 \text{ inches}} = \frac{1 \text{ inch}}{15,780 \text{ miles}}$$

The above chart shows the relationships of numbers in multiples of ten. However, the same relationships occur for all fractions but without the simplicity of base ten. The following sequence may be used to develop the fraction, decimal, percent, etc. relationships. Let's try the fraction one-fourth ( $\frac{1}{4}$ )

**Step 1:** Divide the fraction to obtain the decimal equivalent:

$$\frac{1}{4} = 0.25$$

**Step 2:** Multiply the decimal by 100 to obtain the percent:

$$0.25 \times 100 = 25\%$$

What about problem fractions with repeating decimals? Lets try  $\frac{1}{3}$ :

**Step 1:** Divide the fraction to obtain the decimal equivalent and round:

$$\frac{1}{3} = 0.333333... \rightarrow \text{round to } 0.333$$

**Step 2:** Multiply the decimal by 100 to obtain the percent:

$$0.333 \times 100 = 33.3\%$$

# Wastewater Calculations

## Length

Length is one dimensional linear measurement of the distance between points. Length is expressed in units such as inches, feet, miles (English system) or millimeters, centimeters, meters, kilometers (metric system).

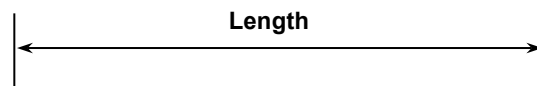

## Area

Area is a two dimensional measurement that is expressed in units that are the square of linear units, for example, square feet or square meters. An area may be uniform or irregular and can occur in a variety of shapes. The most common types of areas are square, rectangular, circular and triangular.

### Square and Rectangle

$$A = L \times W$$

A = area  
L = length  
W = width

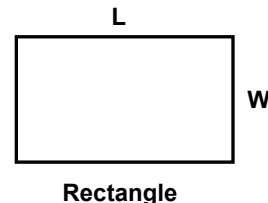
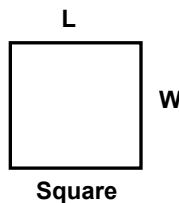

### Circle

$$A = \pi \times r \times r = \pi r^2$$

A = area  
 $\pi = 3.14$   
r = radius (1/2 diameter)  
D = diameter

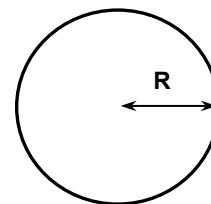
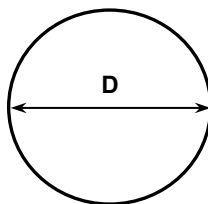

**Example 1: (Area)**

- A sand filter is 100 ft long by 50 ft wide. What is the surface area of the sandfilter?

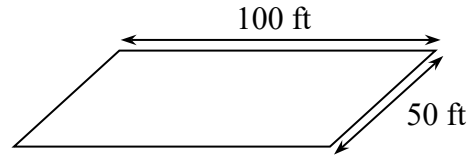

$$\text{Area (ft}^2\text{)} = \text{length} \times \text{width}$$

$$= 100 \text{ ft} \times 50 \text{ ft}$$

$$= \boxed{5,000 \text{ ft}^2}$$

**Example 2: (Area)**

- The diameter of the wetted area of a stationary sprinkler head is 133 feet. What is the surface area of the wetted area in square feet?

$$r = D \div 2 = 133 \text{ ft} \div 2 = 66.5 \text{ ft}$$

$$\text{Area (ft}^2\text{)} = \pi r^2$$

$$= 3.14 \times (66.5 \text{ ft} \times 66.5 \text{ ft})$$

$$= 3.14 \times 4,422.3 \text{ ft}^2$$

$$= \boxed{13,885.9 \text{ ft}^2}$$

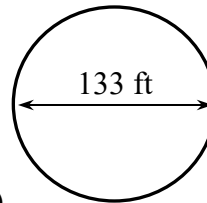

**Example 3: (Area)**

- A spray irrigation field has the dimensions shown in the diagram. What is the total acreage of the field?

1. Begin by dividing the area into two squares or rectangles.

2. Find the area of both areas

$$\text{Area (ft}^2\text{)} = \text{length} \times \text{width}$$

$$\begin{aligned} \text{Area A (ft}^2\text{)} &= 1000 \text{ ft} \times 500 \text{ ft} \\ &= 500,000 \text{ ft}^2 \end{aligned}$$

$$\begin{aligned} \text{Area B (ft}^2\text{)} &= 500 \text{ ft} \times 600 \text{ ft} \\ &= 300,000 \text{ ft}^2 \end{aligned}$$

3. Add Area A and Area B

$$\begin{aligned} \text{Area (ft}^2\text{)} &= 500,000 \text{ ft}^2 + 300,000 \text{ ft}^2 \\ &= 800,000 \text{ ft}^2 \end{aligned}$$

4. Convert square feet to acres

$$\text{Area (ac)} = 800,000 \text{ ft}^2 \div 43,560 \text{ ft}^2/\text{acre}$$

$$= \boxed{18.4 \text{ acres}}$$

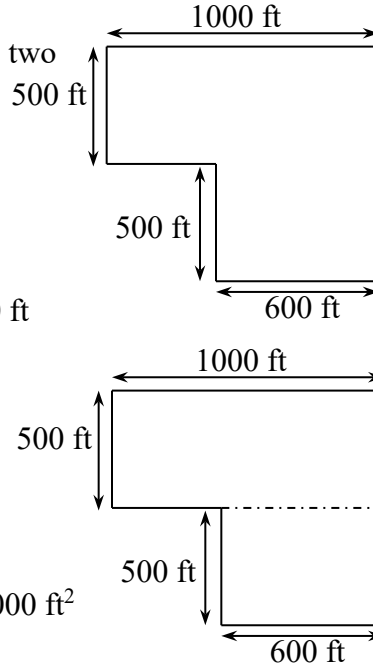

**Volume**

Volume is the amount of space that an object or substance occupies. Volume is a three dimensional measurement and is expressed in units that are the cubes of linear units, such as cubic inches and cubic centimeters, or in units of dry and liquid measure, such as bushels, gallons, and liters.

**Note:** In practical applications, most volumes will be calculated in cubic feet (ft<sup>3</sup>) and then converted to gallons by the conversion factor of 7.48 to obtain volume in gallons.

**Rectangular Tank or Box**

$$V = A \times H$$

or

$$V = L \times W \times H$$

V = volume

A = area (length x width)

H = height (or depth (D))

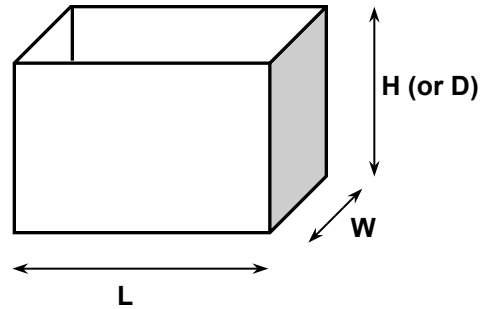
**Cylindrical Tank**

$$V = A \times H$$

or

$$V = \pi r^2 \times H$$

A = area

 $\pi = 3.14$ 

r = radius (1/2 diameter)

H = height (or depth (D))

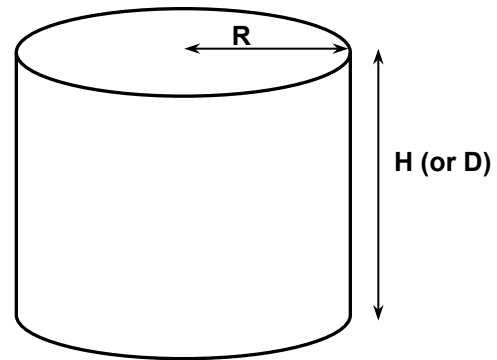
**Example 1: (Tank Volume)**

□ The dimensions of a tank are given below. Calculate the volume of the tank in cubic feet.

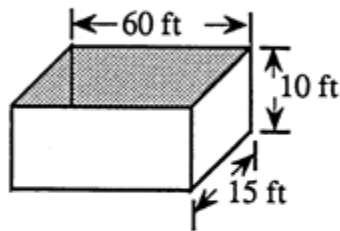

$$\text{Volume (ft}^3\text{)} = \text{length (ft)} \times \text{width (ft)} \times \text{depth (ft)}$$

$$\text{Volume (ft}^3\text{)} = 60 \text{ ft} \times 15 \text{ ft} \times 10 \text{ ft} = \boxed{9,000 \text{ ft}^3}$$

**Example 2: (Tank Volume)\***

□ The diameter of a tank is 60 ft. When the water depth is 25 ft, what is the volume of water in the tank, in gallons?

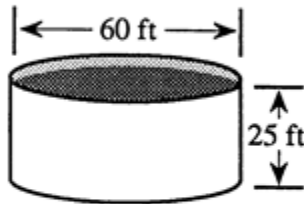

$$\text{Volume (gal)} = \text{volume (ft}^3) \times 7.48 \text{ gal/ft}^3$$

1.  $\text{Volume (ft}^3) = (3.14) (30 \text{ ft})^2 \times 25 \text{ ft} = 70,650 \text{ ft}^3$

2.  $70,650 \text{ ft}^3 \times 7.48 \text{ gal/ft}^3 = \boxed{528,462 \text{ gal}}$

**Example 3: (Tank Volume)\***

□ A tank is 12 ft wide and 20 ft long. If the depth of water is 11 ft, what is the volume of water in the tank?

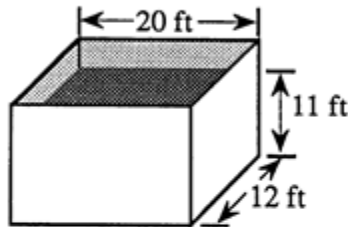

$$\text{Volume (gal)} = \text{volume (ft}^3) \times 7.48 \text{ gal/ft}^3$$

1.  $\text{Volume (ft}^3) = 20 \text{ ft} \times 12 \text{ ft} \times 11 \text{ ft} = 2,640 \text{ ft}^3$

2.  $2,640 \text{ ft}^3 \times 7.48 \text{ gal/ft}^3 = \boxed{19,747 \text{ gal}}$



## Detention Time and Storage

Detention time is the average time it takes for a particle to travel through a tank, lagoon or other treatment or storage structure. Put another way, detention time indicates the amount of time a given flow of water is retained by a treatment or storage structure. Detention time is calculated as the tank or structure volume divided by the flow rate and is expressed in units of time, such as minutes, hours, days, etc. Detention time can also be thought of as storage time or as fill time.

$$\text{D.T.} = \frac{\text{Volume}}{\text{Flow}}$$

D.T. = detention time  
 Volume = volume of structure  
 (in gallons or ft<sup>3</sup>)  
 Flow = flow (volume/unit time)

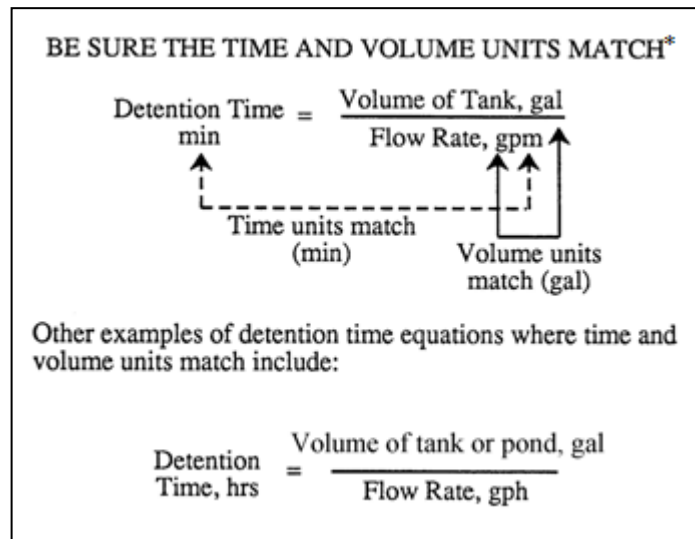
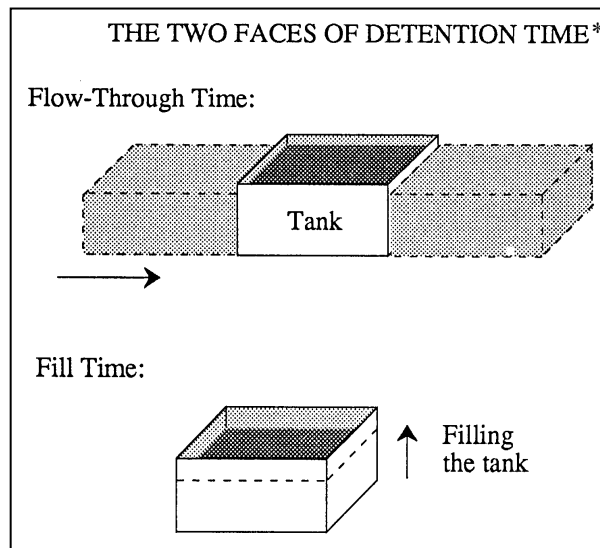

**Example 1: (Detention Time)**

□ A tank is 15 feet long, 10 feet wide, and 10 feet deep. The flow through the tank is 11,000 gpd. Calculate the detention time in hours.

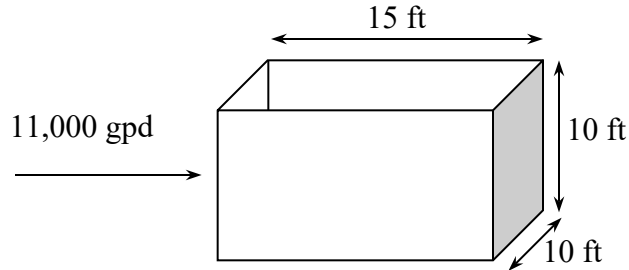

1. Volume (feet) =  $15\text{ ft} \times 10\text{ ft} \times 10\text{ ft} = 1,500\text{ ft}^3$
2. Volume (gallons) =  $1,500\text{ ft}^3 \times 7.48\text{ gal/ft}^3 = 11,220\text{ gal}$
3. Flow (gal/hr) =  $11,000\text{ gpd} \div 24\text{ hours/day} = 458.3\text{ gal/hr}$
4. Detention Time (hours) =  $\frac{\text{Volume}}{\text{Flow}} = \frac{11,220\text{ gal}}{458.3\text{ gal/hr}} = \boxed{24.5\text{ hours}}$

**Example 2: (Detention Time)**

□ A tank is 30 feet in diameter and 10 feet deep. The flow through the tank is 250 gal/hr. What is the detention time in days?

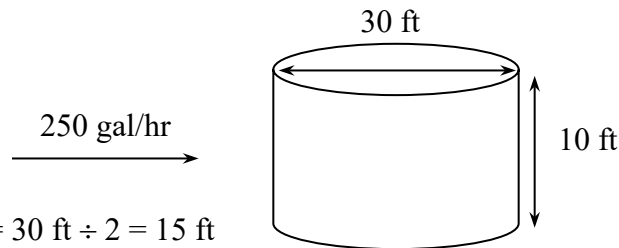

$$r = D \div 2 = 30\text{ ft} \div 2 = 15\text{ ft}$$

1. Volume (ft<sup>3</sup>) =  $3.14 \times (15\text{ ft})^2 \times 10\text{ ft} = 7,065\text{ ft}^3$
2. Volume (gal) =  $7,065\text{ ft}^3 \times 7.48\text{ gal/ft}^3 = 52,846.2\text{ gal}$
3. Flow (gal/day) =  $250\text{ gal/hr} \times 24\text{ hr/day} = 6,000\text{ gal/day}$
4. Detention Time (days) =  $\frac{\text{Volume}}{\text{Flow}} = \frac{52,846.2\text{ gal}}{6000\text{ gal/day}} = \boxed{8.8\text{ days}}$

**Example 3: (Detention Time)**

- A stabilization lagoon is operated at a depth of 8 feet. The average width of the lagoon is 800 ft and the average length is 1,500 ft. If the flow to the pond is 1,500,000 gpd, what is the detention time in days?

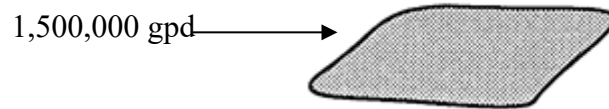

1. Volume (ft<sup>3</sup>) = 8 ft x 800 ft x 1,500 ft = 9,600,000 ft<sup>3</sup>
2. 9,600,000 ft<sup>3</sup> x 7.48 gal/ft<sup>3</sup> = 71,808,000 gal
3. Detention Time (days) =  $\frac{\text{Volume}}{\text{Flow}} = \frac{71,808,000 \text{ gal}}{1,500,000 \text{ gal/day}} = 48 \text{ days}$

**Example 4: (Detention Time or Fill Time)**

- A tank 4 ft square is to be filled to the 3 ft level. If the flow to the tank is 3 gpm, how long will it take to fill the tank (in hours)?

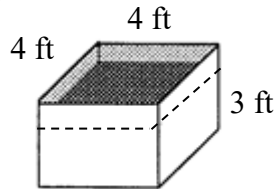

1. Volume (ft<sup>3</sup>) = 4 ft x 4 ft x 3 ft = 48 ft<sup>3</sup>
2. 48 ft<sup>3</sup> x 7.48 gal/ft<sup>3</sup> = 359 gal
3. Flow (gal/hr) = 3 gal/min x 60 min/hr = 180 gph
4. Fill time (hours) =  $\frac{\text{Volume (gal)}}{\text{Flow (gpm)}} = 2 \text{ hrs}$

## Concentration

Concentration is the measurement of the strength of a known constituent or substance (solid, liquid, or gas) dissolved in another substance. Concentration is usually expressed as a percent, as pounds per gallon, as milligrams per liter (mg/L or PPM), or as micrograms per liter ( $\mu\text{g/L}$  or ppb). All of these units are interchangeable if proper conversion factors are used (see conversion list in Needs-To-Know). One of the most frequently used calculations in wastewater mathematics is the conversion of milligrams per liter (mg/L) concentration to pounds (lbs) dosage or loading.

The following two formulas are useful in determining loading rates from concentration or in determining concentration from loading rates:

### 1. To convert mg/L to lbs:

$$\text{lbs/day} = \text{concentration (mg/L)} \times \text{Flow (million gallons per day)} \times 8.34 \text{ lb/gal}$$

*or*

$$\text{lbs/day} = \text{mg/L} \times \text{MGD} \times 8.34 \text{ lb/gal}$$

*or*

$$\text{lbs/year} = \text{mg/L} \times \text{MGD} \times 8.34 \text{ lb/gal} \times 365 \text{ days/year}$$

### 2. To convert lbs to mg/L:

$$\text{Concentration (mg/L)} = \frac{\text{lbs}}{\text{flow (million gallons per day)} \times 8.34 \text{ lb/gal}}$$

*or*

$$\text{mg/L} = \frac{\text{lbs}}{\text{MGD} \times 8.34 \text{ lb/gal}}$$

**MILLIGRAMS PER LITER IS A MEASURE OF CONCENTRATION \***

Assume each liter below is divided into 1 million parts. Then:

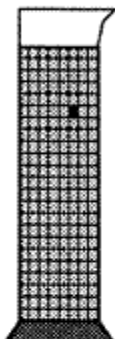
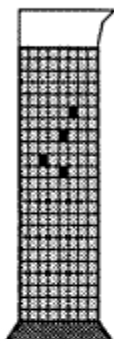
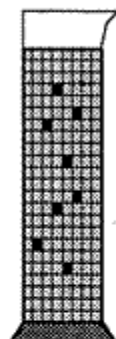
 <p style="text-align: center;">(A)</p> <p style="text-align: center;">= 1 mg/L solids or 1 ppm solids</p> <p style="text-align: center;">1 liter = 1,000,000 mg</p>	 <p style="text-align: center;">(B)</p> <p style="text-align: center;">= 4 mg/L solids or 4 ppm solids</p> <p style="text-align: center;">1 liter = 1,000,000 mg</p>	 <p style="text-align: center;">(C)</p> <p style="text-align: center;">= 8 mg/L solids or 8 ppm solids</p> <p style="text-align: center;">1 liter = 1,000,000 mg</p>
---------------------------------------------------------------------------------------------------------------------------------------------------------------------------------------------------------------------------------------------------------------------------	---------------------------------------------------------------------------------------------------------------------------------------------------------------------------------------------------------------------------------------------------------------------------	----------------------------------------------------------------------------------------------------------------------------------------------------------------------------------------------------------------------------------------------------------------------------

Assuming the liter in these three examples has been divided into 1 million parts (each part representing 1 milligram, mg), the **concentration of solids** in each liter could be expressed as:

- The number of mg solids per liter (mg/L) or
- The number of mg solids per 1,000,000 mg (ppm).

The concentration of solids shown in diagram A is 1 milligram per liter (1 mg/L). The solids concentration shown in diagrams B and C are 4 mg/L and 8 mg/L, respectively.

**Example 1: (Chemical Dosage)**

□ Determine the chlorinator setting (lbs/day) needed to treat a flow of 3 MGD with a chlorine dose of 4 mg/L.

$$\text{lbs/day} = \text{mg/L} \times \text{MGD} \times 8.34 \text{ lb/gal}$$

$$\text{lbs/day} = 4 \text{ mg/L} \times 3 \text{ MGD} \times 8.34 \text{ lbs/gal} = \boxed{100 \text{ lbs/day}}$$

**Example 2: (Chlorine Dose, Demand, Residual)**

□ What should the chlorinator setting be (lbs/day) to treat a flow of 3.7 MGD if the chlorine demand is 9 mg/L and a chlorine residual of 2 mg/L is desired?

$$\boxed{\text{Chlorine Dose}} = \boxed{\text{Chlorine Demand}} + \boxed{\text{Chlorine Residual}}$$

1. Calculate chlorine dosage in mg/L:  $9 \text{ mg/L} + 2 \text{ mg/L} = 11 \text{ mg/L}$
2. Calculate chlorine dosage (feed rate) in lbs/day:

$$11 \text{ mg/L Cl}_2 \times 3.7 \text{ MGD} \times 8.34 \text{ lbs/gal} = \boxed{339 \text{ lbs/day Cl}_2}$$

**Example 3: (Concentration)**

□ The effluent at a spray irrigation facility averages 16 mg/L of potassium (K). If the average daily hydraulic load to the spray fields is 0.7 MGD, how many pounds of K are being applied per year?

1.  $\text{lbs/day} = 16 \text{ mg/L} \times 0.7 \text{ MGD} \times 8.34 \text{ lbs/day} = 93.4 \text{ lbs/day}$
2.  $\text{lbs/year} = 93.4 \text{ lbs/day} \times 365 \text{ days/year} = \boxed{34,094 \text{ lbs/year K}}$

**Example 4: (BOD Loading)**

□ The flow to a waste treatment pond is 155 gpm. If the BOD concentration of the water is 270 mg/L, how many pounds of BOD are applied to the pond daily?

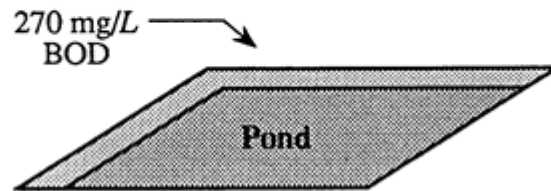

1. Convert gpm to MGD:

$$155 \text{ gal/min} \times 60 \text{ min/hour} \times 24 \text{ hr/day} = 223,200 \text{ gpd}$$

$$223,200 \text{ gpd} \div 1,000,000 = 0.223 \text{ MGD}$$

2.  $270 \text{ mg/L} \times 0.223 \text{ MGD} \times 8.34 \text{ lbs/gal} = 502 \text{ lbs/day BOD}$

**Example 5: (BOD Loading)**

□ The daily flow to a pond is 310,000 gpd. If the BOD concentration of the wastewater is 410 mg/L, how many pounds of BOD are applied to the pond daily?

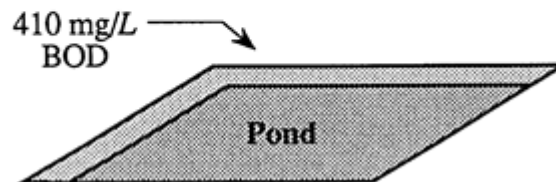

1. Convert gpd to MGD:

$$310,000 \text{ gpd} \div 1,000,000 = 0.31 \text{ MGD}$$

2.  $410 \text{ mg/L} \times 0.31 \text{ MGD} \times 8.34 \text{ lbs/gal} = 1,060 \text{ lbs/day BOD}$

**ORGANIC LOADING RATE IS  
BOD LOADING PER ACRE OF POND**

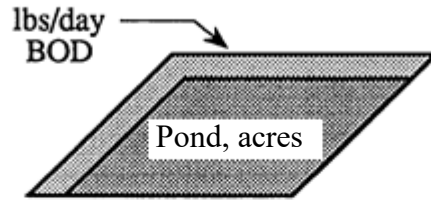

**Simplified Equation:**

$$\text{Organic Loading Rate} = \frac{\text{BOD, lbs/day}}{\text{Area, acres}}$$

**Expanded Equation:**

$$\text{Organic Loading Rate} = \frac{\text{mg/L BOD} \times \text{MGD Flow} \times 8.34 \text{ lbs/gal}}{\text{Area, acres}}$$

**Example 6: (Organic Loading Rate)**

□ A 5.5-acre pond receives a flow of 170,000 gpd. If the influent flow has a BOD content of 160 mg/L, what is the organic loading rate on the pond in lbs BOD/day/ac?

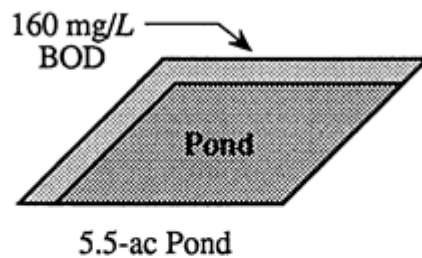

$$\text{Organic Loading Rate} = \frac{160 \text{ mg/L BOD} \times 0.17 \text{ MGD} \times 8.34 \text{ lbs/gal}}{5.5 \text{ ac}}$$

$$= 41 \text{ lbs BOD/day/ac}$$



## Flow Rates

Flow rates are unit volumes per unit time, such as gallons per minute (GPM), million gallons per day (MGD), etc. Flow rates can be measured in several ways. Various flow metering devices may be used to measure wastewater flows at a specific moment (instantaneous flow) or over a specified time period (total flow).

### Calculating Average Flow Rates

- ☐ The following flows were recorded for the week:

Monday	8.6 MGD
Tuesday	7.6 MGD
Wednesday	7.2 MGD
Thursday	7.8 MGD
Friday	8.4 MGD
Saturday	8.6 MGD
Sunday	7.5 MGD

$$\begin{aligned}\text{Average Daily Flow} &= \frac{\text{Total of all Sample Flows}}{\text{Number of days}} \\ &= \frac{55.7 \text{ MGD}}{7 \text{ days}} \\ &= \boxed{8.0 \text{ MGD}}\end{aligned}$$

## Horsepower

Horsepower is a unit of power equivalent to 0.746 kilowatts. In order to select a pump with sufficient pumping power, you must know both the desired flow rate and the feet of head against which the pump must pump. Horsepower is calculated by the following formula:

$$\text{H.P.} = \frac{\text{Flow (gpm)} \times \text{TDH (ft)}}{3960 \times \text{Pump Eff.} \times \text{Motor Eff.}}$$

TDH = total dynamic head (ft)

GPM = gallons per minute

3960 = conversion factor

Pump Eff. = pump efficiency expressed as a decimal

Motor Eff. = motor efficiency expressed as a decimal

### Example 1: (Horsepower)

- What horsepower is required to pump 50,000 gph if the TDH is 28.3 ft and the pump and motor efficiencies are 90%?

1. Convert flow from gph to gpm:

$$\begin{aligned}\text{Flow gpm} &= 50,000 \text{ gph} \div 60 \text{ min/hr} \\ &= 833.3 \text{ gpm}\end{aligned}$$

2. Compute horsepower using the formula:

$$\begin{aligned}\text{HP} &= \frac{\text{Flow (gpm)} \times \text{TDH}}{3960 \times \text{Pump Eff.} \times \text{Motor Eff.}} \\ &= \frac{833.3 \text{ gpm} \times 28.3 \text{ ft}}{3960 \times .90 \times .90} \\ &= \frac{23,582.4}{3,207.6} \\ &= \boxed{7.4 \text{ HP}}\end{aligned}$$

## Pump Delivery Rate

### Example 1: (Pump Delivery Rate)

A dosing tank is 15 ft long and 12 feet wide. The influent valve to the tank is closed. If a pump lowers the water level 1.25 ft during a 5 minute pumping test, what is the pump delivery rate in gpm?

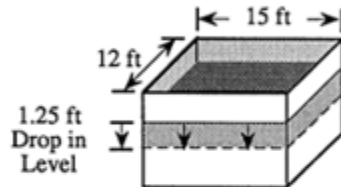

1. Determine the volume of water pumped in gallons.

$$\text{Volume (ft}^3\text{)} = 15 \text{ ft} \times 12 \text{ ft} \times 1.25 \text{ ft} = 225 \text{ ft}^3$$

$$\text{Volume (gal)} = 225 \text{ ft}^3 \times 7.48 \text{ gal/ft}^3 = 1,683 \text{ gal}$$

2. Determine pump delivery rate using this formula:

$$\text{Pump Delivery Rate} = \frac{\text{Volume pumped (gal)}}{\text{Time of pumping}}$$

$$\text{Pump Delivery Rate} = \frac{1,683 \text{ gal}}{5 \text{ min}} = \boxed{336.6 \text{ gpm}}$$

### Example 2: (Pump Delivery Rate)

A pump is rated at 300 gpm. A pump test is conducted for 5 minutes. What is the actual pump delivery rate if the tank is 10 ft long and 8 ft wide and the water level in the tank rises 1.33 ft during the test?

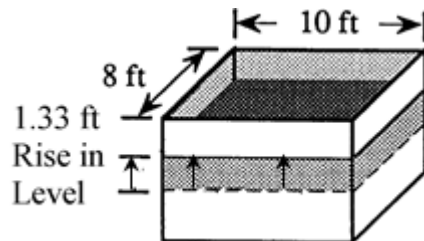

1. Determine the volume of water pumped in gallons.

$$\text{Volume (ft}^3\text{)} = 10 \text{ ft} \times 8 \text{ ft} \times 1.33 \text{ ft} = 106.4 \text{ ft}^3$$

$$\text{Volume (gal)} = 106.4 \text{ ft}^3 \times 7.48 \text{ gal/ft}^3 = 795.9 \text{ gal}$$

2. Determine pump delivery rate:

$$\text{Pump Delivery Rate} = \frac{795.9 \text{ gal}}{5 \text{ min}} = \boxed{159.2 \text{ gpm}}$$

## Hydraulic Loading Rates

Hydraulic loading rate is the amount of wastewater applied to an area for a specified time. The most common expression of hydraulic loading rate is gallons per day per square feet (gpd/ft<sup>2</sup>). Recirculated flows are included as part of the gpd flow to the system.

$$\text{Hydraulic Loading Rate} = \frac{\text{Flow (gpd)}}{\text{Area (ft}^2\text{)}}$$

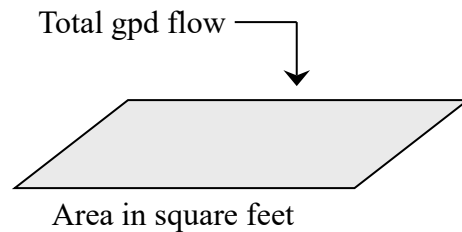

### Example 1: (Hydraulic Loading)

□ If 20,000 gpd are pumped to a sand filter that is 100 ft by 50 ft, what is the hydraulic loading rate on the filter?

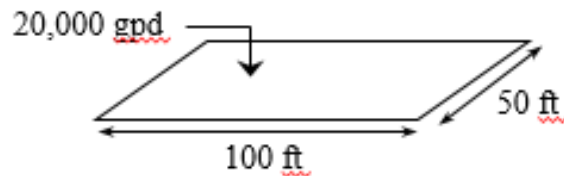

$$\begin{aligned}\text{Hydraulic Loading Rate} &= \frac{\text{Flow (gpd)}}{\text{Area (ft}^2\text{)}} \\ \text{(gpd/ft}^2\text{)} &= \frac{20,000 \text{ gpd}}{100 \text{ ft} \times 50 \text{ ft}} = \frac{20,000 \text{ gpd}}{5,000 \text{ ft}^2} \\ &= \boxed{4 \text{ gpd/ft}^2}\end{aligned}$$

**Example 2: (Hydraulic Loading)**

A sandfilter is 50 feet long by 15 feet wide. The loading rate under normal conditions is 0.5 gpd/ft<sup>2</sup>. How many gallons should be applied to achieve the appropriate loading rate?

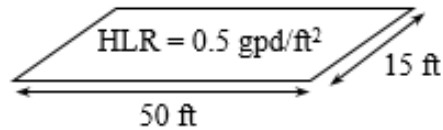

$$\text{Hydraulic Loading Rate (gpd/ft}^2\text{)} = \frac{\text{Flow (gpd)}}{\text{Area (ft}^2\text{)}}$$

Rearrange equation to solve for flow:

$$\begin{aligned} \text{Flow (gpd)} &= \text{Hydraulic Loading Rate (gpd/ft}^2\text{)} \times \text{Area (ft}^2\text{)} \\ &= 0.5 \text{ gpd/ft}^2 \times 50 \text{ ft} \times 15 \text{ ft} \\ &= \boxed{375 \text{ gpd}} \end{aligned}$$

**Example 3: (Hydraulic Loading)**

□ A pond receives a flow of 1,980,000 gpd. If the surface area of the pond is 700,000 sq ft, what is the hydraulic loading in in./day?

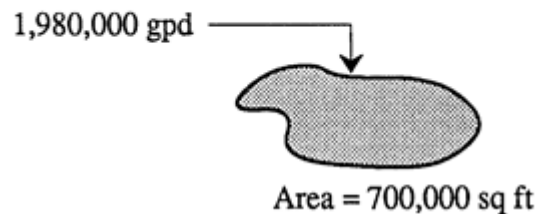

- Hydraulic Loading Rate (gpd/ft<sup>2</sup>) =  $\frac{1,980,000 \text{ gpd}}{700,000 \text{ ft}^2} = 2.83 \text{ gpd/ft}^2$
- Convert gpd/ft<sup>2</sup> to ft/day  
 $2.83 \text{ gpd/ft}^2 \div 7.48 \text{ gal/ft}^3 = 0.4 \text{ ft/day}$
- Convert ft/day to in./day  
 $0.4 \text{ ft/day} \times 12 \text{ in/ft} = \boxed{5 \text{ in/day}}$

# Soil and Crop Calculations

## Hydraulic Soils Loading Rates

Hydraulic Soils Loading Rate is measured in inches of wastewater applied to an area of soil in a day. To calculate the hydraulic soils loading rate, you must use the following conversion factor: one inch of water per acre (1 ac-in) = 27,152 gallons.

$$\text{Hydraulic Soils Loading Rate (in/day)} = \frac{\text{Flow (gal/day)}}{27,152 \text{ gal/acre-in} \times \text{Area (acres)}}$$

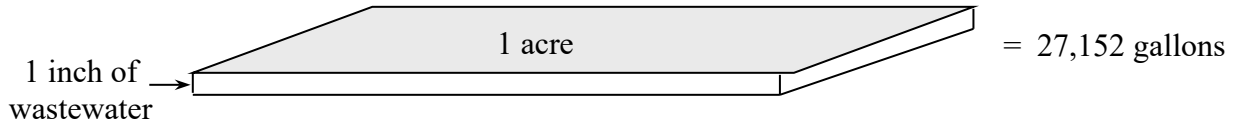

Hourly Hydraulic Soils Loading Rate is inches of wastewater applied to an area of soil in an hour. To calculate Hourly Hydraulic Soils Loading Rate, use the Hydraulic Soils Loading Rate formula and convert from inches per day to inches per hour as follows:

$$\text{Hourly Hydraulic Soils Loading Rate (in/hr)} = \frac{\text{Flow (gal/day)}}{27,152 \text{ gal/acre-in} \times \text{Area (acres)}} \times \frac{1 \text{ day}}{24 \text{ hours}}$$

**Example 1: (Hydraulic Soils Loading Rate)**

- What is the hydraulic soils loading rate for a spray irrigation system that pumps 50,000 gallons in one day equally over a 4.28 acre site?

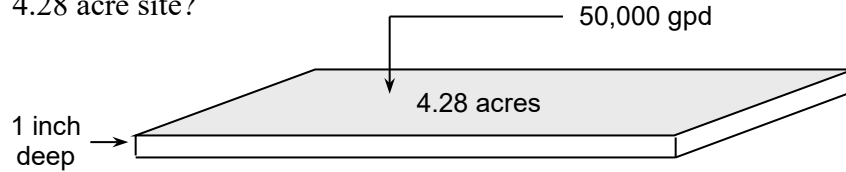

$$\begin{aligned}
 \text{Hydraulic Soils Loading Rate (in/day)} &= \frac{\text{Flow}}{27,152 \text{ gal/acre-in} \times \text{Area}} \\
 &= \frac{50,000 \text{ gpd}}{27,152 \text{ gal/acre-in} \times 4.28 \text{ acres}} \\
 &= \frac{50,000 \text{ gpd}}{116,210.6 \text{ gal/in}} \\
 &= \boxed{0.43 \text{ in/day}}
 \end{aligned}$$

**Example 2: (Hydraulic Soils Loading Rate)**

- What is the hydraulic soils loading rate for a spray irrigation system that pumps 175,000 gallons in one day equally over a 10.5 acre site?

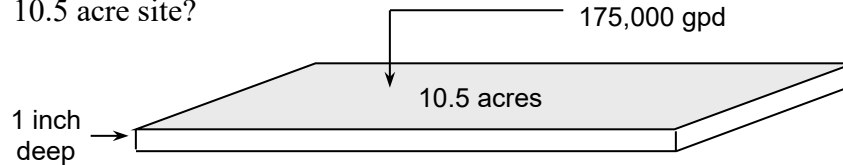

$$\begin{aligned}
 \text{Hydraulic Soils Loading Rate (in/day)} &= \frac{\text{Flow}}{27,152 \text{ gal/acre-in} \times \text{Area}} \\
 &= \frac{175,000 \text{ gpd}}{27,152 \text{ gal/acre-in} \times 10.5 \text{ acres}} \\
 &= \frac{175,000 \text{ gpd}}{285,096 \text{ gal/in}} \\
 &= \boxed{0.61 \text{ in/day}}
 \end{aligned}$$

**Example 3: (Hydraulic Soils Loading Rate)**

- How many acres would be needed to achieve a hydraulic soils loading rate of 0.35 in/day if the flow is 150,000 gpd?

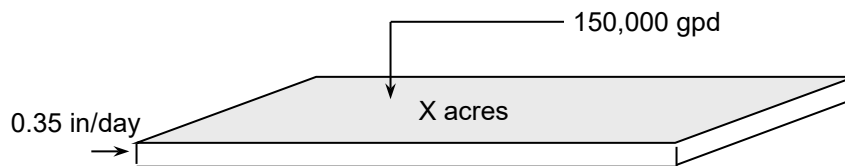

$$\text{Hydraulic Soils Loading Rate (in/day)} = \frac{\text{Flow}}{27,152 \text{ gal/acre-in} \times \text{Area}}$$

$$0.35 \text{ in/day} = \frac{150,000 \text{ gpd}}{27,152 \text{ gal/acre-in} \times X \text{ acres}}$$

Rearrange the equation to solve for X:

$$\begin{aligned} \text{Acres} &= \frac{150,000 \text{ gpd}}{27,152 \text{ gal/acre-in} \times 0.35 \text{ in/day}} \\ &= \frac{150,000 \text{ gpd}}{9,503.2 \text{ gpd/acre}} \\ &= \boxed{15.8 \text{ acres}} \end{aligned}$$

**Example 4: (Hydraulic Soils Loading Rate)**

- If a spray irrigation field is 15.5 acres and receives 0.50 in/day of wastewater, what is the flow in gal/day?

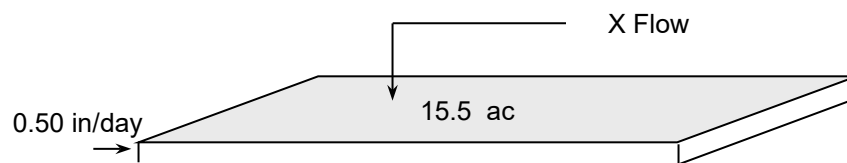

$$\text{Hydraulic Soils Loading Rate (in/day)} = \frac{\text{Flow}}{27,152 \text{ gal/acre-in} \times \text{Area}}$$

$$0.50 \text{ in/day} = \frac{X \text{ gal/day}}{27,152 \text{ gal/acre-in} \times 15.5 \text{ acres}}$$

Rearrange the equation to solve for X:

$$\begin{aligned} X \text{ gal/day} &= 0.50 \text{ in/day} \times 27,152 \text{ gal/acre-in} \times 15.5 \text{ acres} \\ &= \boxed{210,428 \text{ gal/day}} \end{aligned}$$



## Plant Available Nitrogen

Some spray irrigation systems handle wastewater with high nitrogen concentrations. These systems need to base wastewater application rates on supplying crop nitrogen needs rather than on the amount of water the soil can handle. Permits for nitrogen limited systems have PAN monitoring requirements. Plant available nitrogen is calculated as follows:

$$\text{PAN} = [\text{MR} \times (\text{TKN} - \text{NH}_4)] + (0.5 \times \text{NH}_4) + \text{NO}_3 + \text{NO}_2$$

PAN = Plant Available Nitrogen

MR = Mineralization Rate

- 0.4 for primary treatment
- 0.3 for aerated lagoons and sand filters
- 0.2 for aerobic treatment/activated sludge systems

VR = Volatilization Rate: 0.5 for surface application/irrigation

TKN = Total Kjeldhal Nitrogen

NH<sub>4</sub> = Ammonium Nitrogen Concentration

NO<sub>3</sub> = Nitrate Nitrogen Concentration

NO<sub>2</sub> = Nitrite Nitrogen Concentration

Note: You usually see the different forms of nitrogen reported or expressed in this manner:

NH<sub>3</sub>-N  
NH<sub>4</sub>-N  
NO<sub>3</sub>-N  
NO<sub>2</sub>-N

The “-N” ending does not mean “minus N” in this case. It just means nitrogen in the form of ammonia, ammonium, nitrate, or nitrite, etc.

Some labs report nitrate and nitrite as a combined value, which may be expressed as: NO<sub>3</sub> + NO<sub>2</sub>, NO<sub>3</sub>-N + NO<sub>2</sub>-N, etc.

**Example 1: (PAN)**

- Calculate the PAN of wastewater that has the following concentrations:

TKN: 48 mg/L

NH<sub>4</sub>: 14 mg/L

NO<sub>3</sub> + NO<sub>2</sub>: 2 mg/L

Assume a mineralization rate of 0.20.

$$\text{PAN} = [\text{MR} \times (\text{TKN} - \text{NH}_4)] + (0.5 \times \text{NH}_4) + \text{NO}_3 + \text{NO}_2$$

$$\text{PAN} = [0.20 (48 - 14)] + (0.5 \times 14) + 2$$

$$\text{PAN} = (0.20 \times 34) + 7 + 2$$

$$\text{PAN} = 6.8 + 7 + 2 = \boxed{15.8 \text{ mg/L PAN}}$$

**Example 2: (PAN)**

- You are applying 15.0 in/acre/yr to your spray fields. Your wastewater contains the following concentrations:

TKN: 56 mg/L

Ammonium: 18 mg/L

Nitrate: 10.5 mg/L

Nitrite: 0.5 mg/L

Assume a mineralization rate of 0.40. How many lbs of PAN are you applying per year to each acre?

1. Calculate PAN in mg/L

$$\text{PAN} = [\text{MR} \times (\text{TKN} - \text{NH}_4)] + (0.5 \times \text{NH}_4) + \text{NO}_3 + \text{NO}_2$$

$$= [0.40 (56 - 18)] + (0.5 \times 18) + 10.5 + 0.5$$

$$= (0.40 \times 38) + 9 + 11$$

$$= 15.2 + 9 + 11 = 35.2 \text{ mg/L PAN}$$

2. Convert mg/L to lbs using the formula:

$$\text{lbs} = \text{concentration (mg/L)} \times \text{Flow (million gallons per year)} \times 8.34 \text{ lb/gal}$$

3. To do this we first need to convert our hydraulic soils loading rate (HSLR (in/year)) to flow (MGY).

$$\text{Flow} = 15 \text{ in/yr} \times 27,152 \text{ gal/acre-in} \times 1 \text{ acre} = 407,280 \text{ gal/acre} = 0.407 \text{ MGY}$$

4. We can now solve for lbs PAN per year on each acre:

$$\text{lbs PAN/yr} = 35.2 \text{ mg/L} \times 0.407 \text{ MGY} \times 8.34 \text{ lb/gal} = \boxed{119.5 \text{ lbs/yr PAN}}$$

**Example 3: (PAN)**

- You are applying 26.0 in/acre/yr to your spray fields. Your wastewater contains the following concentrations:

TKN: 26 mg/L

Ammonium: 10 mg/L

Nitrate: 5.5 mg/L

Nitrite: 0.3 mg/L

Assume a mineralization rate of 0.20. How many lbs of PAN are you applying per year to each acre?

1. Calculate PAN in mg/L

$$\begin{aligned} \text{PAN} &= [\text{MR} \times (\text{TKN} - \text{NH}_4)] + (0.5 \times \text{NH}_4) + \text{NO}_3 + \text{NO}_2 \\ &= [0.20 (26 - 10)] + (0.5 \times 10) + 5.5 + 0.3 \\ &= (0.20 \times 16) + 5 + 5.8 \\ &= 3.2 + 10.8 = 14.0 \text{ mg/L PAN} \end{aligned}$$

2. Convert mg/L to lbs using the formula:

$$\text{lbs} = \text{concentration (mg/L)} \times \text{Flow (million gallons per year)} \times 8.34 \text{ lb/gal}$$

3. To do this we first need to convert our hydraulic soils loading rate (HSLR (in/year)) to flow (in million gallons per year).

$$\text{Flow} = 26.0 \text{ in/acre} \times 27,152 \text{ gal/acre-in} \times 1 \text{ acre} = 705.952 \text{ gal/acre} = 0.706 \text{ MGY/acre}$$

4. We can now solve for lbs PAN per year on each acre:

$$\text{lbs PAN/acre/year} = 14.0 \text{ mg/L} \times 0.706 \text{ MGY/acre} \times 8.34 \text{ lb/gal} = \boxed{82.4 \text{ lbs PAN/acre}}$$

## Sodium Adsorption Ratio

The ratio of the sodium concentration to the concentrations of calcium and magnesium in the wastewater is called the *sodium adsorption ratio* (SAR). Calculations for SAR utilize the liquid concentrations (in mg/L) of sodium, calcium, and magnesium in the wastewater. The formula for Sodium Adsorption Ratio is as follows, with all concentrations expressed in milliequivalents (meq):

$$\text{SAR} = \frac{\text{Na}}{\sqrt{0.5 \times (\text{Ca} + \text{Mg})}}$$

Where sodium, calcium, and magnesium are in milliequivalents/liter (meq/L)

$$\text{meq} = \frac{\text{concentration}}{\text{equivalent weight}}$$

### Example 1: (SAR)

- What is the SAR for a wastewater that has the following ion concentrations:

Sodium ( $\text{Na}^+$ ) = 84 mg/L

Calcium ( $\text{Ca}^{2+}$ ) = 23 mg/L

Magnesium ( $\text{Mg}^{2+}$ ) = 14 mg/L

The equivalent weights of sodium, calcium, and magnesium are, respectively, 23, 20, and 12.

First, convert concentrations to milliequivalents (meq):

$$\text{Na}^+ = \frac{84 \text{ mg/L}}{23} = 3.7$$

$$\text{Ca}^{2+} = \frac{23 \text{ mg/L}}{20} = 1.2$$

$$\text{Mg}^{2+} = \frac{14 \text{ mg/L}}{12} = 1.2$$

$$\text{SAR} = \frac{\text{Na}}{\sqrt{0.5 \times (\text{Ca} + \text{Mg})}}$$

$$\text{SAR} = \frac{3.7}{\sqrt{0.5 \times (1.2 + 1.2)}} = \frac{3.7}{\sqrt{0.5 \times 2.4}}$$

$$= \frac{3.7}{\sqrt{1.2}} = \frac{3.7}{1.1} = \boxed{3.4}$$

**Example 2: (SAR)**

- What is the SAR for a wastewater that has the following concentrations:

$$\text{Sodium (Na}^+) = 400 \text{ mg/L}$$

$$\text{Calcium (Ca}^{2+}) = 40 \text{ mg/L}$$

$$\text{Magnesium (Mg}^{2+}) = 27 \text{ mg/L}$$

The equivalent weights of sodium, calcium, and magnesium are, respectively, 23, 20, and 12.

First, convert concentrations to milliequivalents (meq):

$$\text{Na}^+ = \frac{400 \text{ mg/L}}{23} = 17.4$$

$$\text{Ca}^{2+} = \frac{40 \text{ mg/L}}{20} = 2.0$$

$$\text{Mg}^{2+} = \frac{27 \text{ mg/L}}{12} = 2.3$$

$$\text{SAR} = \frac{\text{Na}}{\sqrt{0.5 \times (\text{Ca} + \text{Mg})}}$$

$$\text{SAR} = \frac{17.4}{\sqrt{0.5 \times (2.0 + 2.3)}} = \frac{17.4}{\sqrt{0.5 \times 4.3}}$$

$$= \frac{17.4}{\sqrt{2.2}} = \frac{17.4}{1.5} = \boxed{11.6}$$

## Exchangeable Sodium Percentage

Exchangeable sodium percentage (ESP) is an evaluation that can be used to determine possible excess sodium concentration in the soil itself. The ESP is the amount of adsorbed sodium on the soil exchange complex expressed in percent of the cation exchange capacity (CEC) in milliequivalents per 100 cm<sup>3</sup> of soil. This determination can be made from a typical soil fertility evaluation and calculated as follows:

$$\text{ESP} = \frac{\text{Na}}{\text{CEC}} \times 100$$

Where Na and CEC are in milliequivalents (meq) per 100 cm<sup>3</sup> of soil.

### Example 1: (ESP)

- The CEC of a soil is 5.4 meq/100 cm<sup>3</sup> and the Na is 0.7 meq/100 cm<sup>3</sup>.

What is the exchangeable sodium percentage?

$$\begin{aligned}\text{ESP} &= \frac{\text{Na}}{\text{CEC}} \times 100 \\ &= \frac{0.7}{5.4} \times 100 \\ &= 13.0\%\end{aligned}$$

## Precipitation Rate for Stationary Sprinklers

### Example 1:

- A stationary sprinkler has a discharge rate of 17.6 gpm and a wetted diameter of 140 ft. If the sprinkler spacing is set at 60% of the wetted diameter and lateral spacing is 84 ft, what is the precipitation rate in in/hr?

1. First, determine the design sprinkler spacing:

$$\text{Sprinkler spacing} = 140 \text{ ft} \times 0.6 = 84 \text{ ft}$$

2. Next, determine the precipitation rate using the following formula:

$$\text{Precipitation rate (in/hr)} = \frac{96.3 \times \text{discharge rate (gpm)}}{\text{sprinkler spacing (ft)} \times \text{lateral spacing (ft)}}$$

$$= \frac{96.3 \times 17.6 \text{ gpm}}{84 \text{ ft} \times 84 \text{ ft}} = \frac{1694.88}{7056} = \boxed{0.24 \text{ in/hr}}$$

### Example 2:

- A stationary sprinkler has a discharge rate of 13.0 gpm and a wetted diameter of 127 ft. If the sprinkler spacing is set at 70 ft and the lateral spacing is set at 80 ft, what is the precipitation rate in in/hr?

$$\text{Precipitation rate (in/hr)} = \frac{96.3 \times \text{discharge rate (gpm)}}{\text{sprinkler spacing (ft)} \times \text{lateral spacing (ft)}}$$

$$= \frac{96.3 \times 13.0 \text{ gpm}}{70 \text{ ft} \times 80 \text{ ft}} = \frac{1251.9}{5600} = \boxed{0.22 \text{ in/hr}}$$

## Time of Operation (or Application Run Time) for Stationary Sprinklers

### Example 1:

- If a stationary sprinkler has a precipitation rate of 0.26 in/hr and your target application depth is 0.25 inches, what is the run time for the sprinkler?

$$\begin{aligned}\text{Time of Operation (hours)} &= \frac{\text{target application depth (in)}}{\text{precipitation rate (in/hr)}} \\ &= \frac{0.25 \text{ in}}{0.26 \text{ in/hr}} \\ &= \boxed{1 \text{ hr}}\end{aligned}$$

### Example 2:

- If a stationary sprinkler has a precipitation rate of 0.22 in/hr and your target application depth is 0.75 inches, what is the run time for the sprinkler?

$$\begin{aligned}\text{Time of Operation (hours)} &= \frac{\text{target application depth (in)}}{\text{precipitation rate (in/hr)}} \\ &= \frac{0.75 \text{ in}}{0.22 \text{ in/hr}} \\ &= 3.4 \text{ hr}\end{aligned}$$

To convert .4 hour to minutes:  $0.4 \text{ hr} \times 60 \text{ min/hr} = 24 \text{ min}$

$\boxed{3 \text{ hr } 24 \text{ min}}$



## Application Depth for a Traveling Gun Sprinkler

### Example 1:

- The discharge rate for a traveling gun is 120 gpm and the wetted diameter is 270 ft. If the lane spacing is 75% of the wetted diameter and the travel speed is 2 feet per minute, what is the application depth in inches?

1. First, determine the lane spacing:

$$0.75 \times 270 \text{ ft} = 202.5 \text{ ft}$$

2. Next, convert travel speed from feet per minute, to inches per minute:

$$2 \text{ ft/min} \times 12 \text{ in/ft} = 24 \text{ in/min}$$

3. Now, determine the application depth using the following formula:

$$\text{Application depth (in)} = \frac{19.3 \times \text{sprinkler discharge rate (gpm)}}{\text{lane spacing (ft)} \times \text{travel speed (in/min)}}$$

$$= \frac{19.3 \times 120 \text{ gpm}}{202.5 \text{ ft} \times 24 \text{ in/min}} = \frac{2316}{4860} = \boxed{0.48 \text{ in}}$$

### Example 2:

- The discharge rate for a traveling gun is 90 gpm and the wetted diameter is 225 ft. If the lane spacing is 80% of the wetted diameter and the travel speed is 4 feet per minute, what is the application depth in inches?

1. First, determine the lane spacing:

$$.80 \times 225 \text{ ft} = 180 \text{ ft}$$

2. Next, convert travel speed from feet per minute, to inches per minute:

$$4 \text{ ft/min} \times 12 \text{ in/ft} = 48 \text{ in/min}$$

3. Now, determine the application depth using the following formula:

$$\text{Application depth (in)} = \frac{19.3 \times \text{sprinkler discharge rate (gpm)}}{\text{lane spacing (ft)} \times \text{travel speed (in/min)}}$$

$$= \frac{19.3 \times 90 \text{ gpm}}{180 \text{ ft} \times 48 \text{ in/min}} = \frac{1737}{8640} = \boxed{0.20 \text{ in}}$$

## Travel Speed for a Traveling Gun Sprinkler

### Example 1:

- A traveling gun has a discharge rate is 155 gpm and a wetted diameter of 290 ft. If the lane spacing is 75% of the wetted diameter, what travel speed is necessary to apply 0.4 inches of wastewater?

1. First, determine the lane spacing:

$$0.75 \times 290 \text{ ft} = 217.5 \text{ ft}$$

2. Next, determine the travel speed using the following formula:

$$\text{Travel speed (in/min)} = \frac{19.3 \times \text{sprinkler discharge rate (gpm)}}{\text{lane spacing (ft)} \times \text{application depth (in)}}$$

$$= \frac{19.3 \times 155 \text{ gpm}}{217.5 \text{ ft} \times 0.4 \text{ in}} = \frac{2991.5}{87} = \boxed{34.4 \text{ in/min}}$$

### Example 2:

- A traveling gun has a discharge rate is 260 gpm and a wetted diameter of 355 ft. If the lane spacing is 75% of the wetted diameter, what travel speed is necessary to apply 0.5 inches of wastewater?

1. First, determine the lane spacing:

$$0.75 \times 355 \text{ ft} = 266.3 \text{ ft}$$

2. Next, determine the travel speed using the following formula:

$$\text{Travel speed (in/min)} = \frac{19.3 \times \text{sprinkler discharge rate (gpm)}}{\text{lane spacing (ft)} \times \text{application depth (in)}}$$

$$= \frac{19.3 \times 260 \text{ gpm}}{266.3 \text{ ft} \times 0.5 \text{ in}} = \frac{5018}{133.15} = \boxed{37.7 \text{ in/min}}$$

## Chapter 7

# Health and Safety

Accidents and injuries don't just happen – they are caused. Behind every accident is a chain of events that leads up to an unsafe act; unsafe conditions or a combination of both. Safety in the workplace should be everyone's concern. Communication between supervisors and employees generates ideas and safety awareness that leads to accident prevention. Safety programs, safety manuals and safety meetings are essential in providing the lines of communication that lead to a safe, accident-free workplace.

### Regulatory Overview

A variety of federal and state laws and regulations exist to protect workers in both the private and public sectors. At the federal level, the regulatory agency that oversees worker safety is the U.S. Occupational Safety and Health Administration (OSHA). In North Carolina, the Division of Occupational Safety and Health (OSH) has adopted federal OSHA standards, making them more restrictive in some cases. Areas covered by NC OSH:

- General Industry (29 CFR 1910)
- Construction (29 CFR 1926)
- Maritime Operations (29 CFR 1915, 1918)
- Agricultural Operations (29 CFR 1928)

### *Employer Responsibilities*

The following items are the responsibility of the employer or owner:

- Provide a workplace that is free from recognized hazards that are causing or likely to cause serious injury or death.
- Furnish and require use of safety devices and safeguards, safe work practices and procedures, operation and processes that are adequate to ensure employees are safe while performing their jobs.
- Comply with all NC OSH standards.

### *Site Supervisor Responsibilities*

The following items are the responsibility of the site supervisor:

- Establish and supervise a Health and Safety Program that is designed to improve the safety and health skills and competency of all employees.
- Conduct preliminary investigations to determine the cause of any accident that results in injury. The results of this investigation should be documented for reference.
- Establish and maintain a system for maintaining records of occupational injuries and illnesses.
- Provide new employees with a safety orientation on the special hazards and precautions of any new job.
- Conduct job briefings with employees before starting any job to acquaint employees with any unfamiliar procedures.
- Issue any needed safety equipment and manuals.
- Conduct periodic group safety meetings.

### *Employee Responsibilities*

The following items are the responsibility of the employee:

- Comply with OSHA standards and rules that are applicable to his or her own actions and conduct.
- Keep informed of current safe work practices and procedures.
- Be responsible for his or her own safety.
- Request instruction from the site supervisor if there is a question as to the safe performance of work assigned.
- Use appropriate safety devices and wear suitable clothing and appropriate personal protective equipment (PPE).
- Report to the site supervisor any unsafe conditions, practices, or procedures.

### **Health and Safety Program**

As mentioned above, it is the site supervisor's responsibility to develop a Health and Safety Program. This program should include:

- procedures for reporting incidents, injuries, and unsafe conditions or practices
- instructions on identification and safe use of hazardous gases, chemicals and materials and emergency procedures following exposure
- use and care of personal protective equipment

### *Incident Reporting*

As part of the Health and Safety Program, all facilities should develop a formal incident reporting and investigation program. All incidents, including injuries, accidents and near misses should be reported to the site supervisor immediately. These incidents should be investigated as soon as possible to determine their root cause.

The information gained from an investigation should then be used to change work practices and to eliminate hazardous activities. Injuries requiring treatment other than first aid treatment must be reported on OSHA 200 form (Log and Summary of Injuries and Illnesses).

### *Hazard Communication Standard*

The Hazard Communication Standard, mandated by OSHA, is another important component of any Health and Safety Plan. The goal of the Hazard Communication Standard is to reduce injuries and illnesses resulting from improper use, storage, etc., of chemicals in the workplace. Employers must inform or instruct employees about the following regarding chemicals that are used in the workplace

- safety and health standards for the safe use of those chemicals
- known health hazards of the chemicals used in the workplace
- methods of hazard control
- proper labeling of containers
- maintaining current material safety data sheets (MSDS) on all chemicals
- chemical inventory
- procedures to use in normal use or a foreseeable emergency
- training in recognizing, evaluating, and controlling hazards

### *Chemical Hygiene Plan*

Another standard that goes together with the Hazard Communication Standard is the Laboratory Standard, or more exactly, the Occupational Exposure to Hazardous Chemicals in Laboratories Standard. Facilities that have a laboratory that performs analytical tests may need to develop a chemical hygiene plan.

A chemical hygiene plan includes the following:

- how laboratory personnel handle and work with hazardous laboratory chemicals
- how employee exposure to these chemicals will be minimized
- what personal protective equipment will be used in the laboratory
- specifications for working with particularly hazardous substances, such as cancer causing

chemicals, and certain other requirements

The requirements of the laboratory standard can be found in the OSHA regulation 29 CFR 1910.1450, including the appendices. This plan must be a written plan and must be evaluated on a regular basis for effectiveness.

### *Personal Protective Equipment*

Another important component of a Health and Safety Program is a written program covering the appropriate selection, use, and maintenance of personal protective equipment (PPE). The proper selection and use of personal protective equipment is one of the most effective methods for preventing occupational injuries and illnesses.

Types of personal protective equipment include:

- head protection
- eye and face protection
- hearing protection
- foot and leg protection
- body protection
- respiratory protection

### **Head Protection**

Any head injury has the potential to be serious. Any injury that results in brain damage can cause memory loss, affect the ability to reason, and cause changes in personality and emotions. Any of these changes can result in disability and interfere with the ability to earn a living. Fortunately, there is a wide variety of protective equipment suitable for the activities normally associated with wastewater treatment facilities.

Bump caps are lightweight plastic caps designed to protect the head from bumps and scrapes encountered in tasks such as building and machinery maintenance. However, a bump cap will not provide protection from impact, such as a dropped tool or other heavy object. Bump caps are also recommended for tasks where cleanliness and sanitation are high priorities, such as in food processing plants or when handling pesticides. A bump cap or hard hat can be decontaminated with soap and water; but a baseball cap or cowboy hat cannot be completely decontaminated of chemicals.

Safety helmets (commonly referred to as 'hard hats') are primarily intended to protect the head from falling objects, although they can also provide protection from flying objects. A hard hat consists of a sturdy shell, usually made of plastic, and a suspension that holds the shell at least 1¼ inches from the head. When an object strikes the hat, the force is distributed through the

suspension to a large area of the head and neck, preventing puncture wounds and concussion injuries in most cases.

Hard hats are recommended for all construction and timber harvesting activities and any other tasks involving the risk of bumps or falling objects. While a hard hat may not be able to protect a person from a severe, direct blow, it can deflect many glancing blows that might otherwise result in serious injury or death.

Accessories that can be mounted on a hard hat include welding helmets, face shields, hearing protectors and communications devices. These are useful because several personal protective items needed for a particular task can be kept together. For example, a hard hat with a face screen and hearing protectors is ideal for chain saw operation.

Although hard hats are heavier than baseball caps, they are cooler than baseball caps because there is an air space between the head and shell. This coolness is welcomed in summer, but a liner is often needed in winter to maintain comfort.

Accidents, abuse, or improper care can damage any type of protective headgear. Remember these points.

- Always replace any protective headgear that has received a hard blow, because it may have sustained damage that is not visible.
- Never wash any protective headgear with anything stronger than mild detergent and water. Solvents can weaken or destroy the plastics used for protective headgear.

*NOTE: Use safety helmets that comply with the American National Standards Institute (ANSI) Z89.1 criteria. Never use a metal hard hat when working around electrical systems.*

## Eye and Face Protection

Our eyes are one of the most vulnerable parts of our bodies. Chemical burns, flying particles, cuts, heat, light, and blows to the head or face can cause eye injuries. Eye and face protective devices include face shields, safety glasses, and goggles.

Safety glasses are available in a wide variety of styles and can be equipped with or without side shields. Lenses can be made of plastic or heat treated or chemically treated glass. Metal frames should not be worn in an electrical hazard area.

Goggles can be worn over regular prescription eyewear. The frames are made of molded synthetic rubber, natural rubber, or vinyl. Lenses are made of plastic, acetate, or glass. Goggles with ventilation should be used where fogging is a problem. In areas where dust, smoke, aerosols, chemical splashes, or fumes can irritate eyes, goggle without ventilation should be used.

Face shields provide additional protection for eyes and should only be worn over primary eye protection. They also provide protection for the nose, mouth, and throat. Face shields are generally made of plastic but are available in reflecting metal screen where radiant heat is a problem. Face shields can be attached directly to a hard hat.

## Hearing Protection

Noise is a fact of life; however, noise above a certain level can be harmful and cause permanent hearing damage. Noise can come from a variety of sources, such as gasoline or diesel engines, gas or electric blowers, mechanical equipment, spreaders, and other types of machinery.

Each employer is required to determine if noise above what is called the “action level” exists in the workplace. If so, actions must be taken to reduce the noise level and protect the employees. The employer is required to develop a “hearing conservation program” which is designed to effectively limit employee exposure to harmful levels of noise. OSHA regulation 1910.95 stipulates what a minimum level hearing conservation program must contain and provides guidance for employers to develop their own effective program.

In essence, the hearing conservation program states that employees must wear proper ear protecting devices whenever they are working in a noise hazard area. Hearing protection devices include earplugs, earmuffs, and semi-aural or canal caps.

## Hand and Arm Protection

In this section we will discuss barrier creams and gloves. However, one of the best methods of protecting the hands (and preventing dermatitis elsewhere) is to thoroughly wash the hands with soap and water and dry them with single-use towels when finishing a task, before eating and after using the restroom.

Barrier creams protect the hands by forming a protective film on the skin that reduces contact with irritating or harmful chemicals. The barrier cream is applied like a hand lotion and can be washed off with soap and water.

There are at least four types of barrier creams available: one for oils and solvents; one for caustics, coolants, and fertilizers; another for epoxies; and one for water-based hazards. A barrier cream will not provide protection from cuts and scrapes, nor will it protect your hands from strong chemicals or from prolonged exposure to milder chemicals.

However, barrier creams are an excellent choice for certain maintenance tasks because they permit normal use of hand tools and they do minimize exposure to chemicals such as used engine oil.

Gloves are available in a wide variety of styles and materials, each having its advantages and disadvantages. Since there is no single type of glove that is suitable for all tasks, it is important to



understand a few basics of selecting gloves.

When determining the types of gloves to use you may want to ask yourself the following questions:

- Do you need protection from cuts and scrapes, protection from heat or protection from chemicals?
- Are the hazards low, moderate, or high?
- Do you need to wear them all day, or intermittently?
- Do you need good manual dexterity for handling controls, tools, or small objects?

Glove selection becomes complicated when a situation involves several hazards or types of tasks. Pesticide labels are required to give specific recommendations for personal protective equipment, including gloves. You must use the PPE stated on the pesticide label to comply with federal and state regulations.

For products other than pesticides, check the label for PPE recommendations or refer to a chemical resistance chart (featured in safety product catalogs) and select a material that provides good to excellent resistance from the chemicals you will be exposed to. Never use leather or fabric gloves when handling toxic chemicals since the chemicals readily penetrate these materials, and they can never be fully decontaminated.

Gloves are made from many materials. You may need three to four types of gloves to meet your needs. Choices will depend on your specific needs for protection from chemical and physical hazards.

Fabric (jersey, cotton flannel, knit, etc.) gloves are inexpensive and suitable for many tasks where protection is needed from minor cuts and scrapes. Cloth gloves are also ideal for tasks where protection is needed from friction or when a glove might aid in gripping objects. Gloves with dimples or rubberized fabric on the palms and fingers are excellent when using hand tools and other similar tasks.

Some fabrics are also used for high temperature applications, such as welding gloves. These may be more flexible than leather welding gloves but can result in serious burns if they are wet when a hot object is picked up unless they have a moisture barrier. A significant advantage of cloth gloves is that they breathe well, minimizing perspiration buildup.

Leather is possibly the best all-around choice for protection from cuts, scrapes, friction, and other physical hazards. It is tough, flexible, inexpensive, and breathes well. Leather can be sewn into a wide variety of gloves and may be used in conjunction with other materials for specialized purposes.

For example, Kevlar® (the material used in body armor for police officers) is used in gloves for chain saw operators to provide extra protection from cuts should the left hand encounter the moving chain. Another example is the insulating materials sewn inside gloves used by welders to protect them from burns.

Rubber gloves are needed for protection from the wide variety of chemicals that may be used at a surface irrigation site. However, there are several 'rubber' materials used for gloves today, and it is important that the correct material be used. Using the wrong material can allow chemicals to penetrate through the gloves or cause the gloves to deteriorate.

Always refer to the manufacturer's chemical resistance chart and glove selection guidelines when selecting rubber gloves. Cut-resistant materials such as Kevlar®, steel reinforced fabrics, and chain link mesh are used in gloves designed for tasks where cuts are a major risk, such as handling glass and other sharp objects. Although these materials can be cut, they offer superior protection while permitting the user to grasp tools and other objects. Cut-resistant gloves often feature slip-resistant materials or textures on the fingers and palm to minimize the risk of sharp objects slipping through the hands, thus reducing the risks of a cut.

Whatever type of gloves you chose, remember these points:

- Gloves should be thick enough to provide adequate chemical resistance and prevent punctures or tears, yet thin enough to provide a good grip and manual dexterity. Examination gloves (like doctors use) are not adequate for protection from most chemicals, especially pesticides.
- Unlined gloves are normally recommended when using chemicals since they can be easily washed and decontaminated. Flock-lined gloves are more comfortable, however, and often cost less than unlined gloves. Any lined gloves should be disposed of if contaminated inside by chemicals.
- Gloves should be thick enough to provide adequate chemical resistance and prevent punctures or tears, yet thin enough to provide a good grip and manual dexterity. Examination gloves (like doctors use) are not adequate for protection from most chemicals, especially pesticides.
- The color of the gloves will affect comfort, especially outdoors. Black gloves will absorb heat from the sunlight, making them uncomfortable, so select a lighter color for outdoor work.
- Cut, length and thickness affect the comfort and performance of any glove. Some gloves may be so heavily constructed that they will last forever - because they are too stiff or otherwise uncomfortable to be used on a routine basis.
- Gloves that are too heavy or uncomfortable, or which do not fit well, can significantly reduce a worker's productivity by making it difficult to handle tools and other objects.

Those gloves can also be dangerous in certain situations. Other gloves may be very comfortable, but not durable enough to provide satisfactory performance and economy.

- The ideal glove fits well, provides the needed protection, permits good productivity and is economical. If there are several workers, it is likely that several styles or sizes of gloves will be needed. Try several styles of gloves to determine which provides the best comfort, grip and dexterity needed for the intended tasks.

### **Foot and Leg Protection**

Injuries to the feet are uncomfortable at best, and they can seriously interfere with the ability to accomplish work activities. Although most foot injuries are not serious, they do result in pain and lost production. Injuries resulting from dropped objects, punctures and strains or sprains due to slips and falls are probably the most common. Most of these can be prevented through a combination of safe work practices and use of proper footwear.

While you may not always need to wear high-top steel-toe boots with steel shank and lug soles, you probably should wear them some of the time. Sneakers and smooth soled shoes are not good because they do not provide protection from commonly encountered hazards.

Perhaps the most important aspect of good footwear is a non-slip sole. Good traction is needed to prevent slips and falls while walking on various surfaces, and especially when climbing ladders and stairs. Smooth leather soles common on western boots and dress shoes may be too slippery on many surfaces. Soles with lugs or texture may provide better traction, especially when made of the soft, yet long wearing materials found in quality boots. A steel shank can provide improved puncture resistance as well as improved support in activities that place concentrated loads on the feet, such as prolonged work on ladders or repeatedly pressing machinery brake pedals.

Steel toe safety shoes are intended to protect the toes from injuries caused by dropped objects. While steel toecaps are very effective in preventing injuries to the toes, they will not protect the rest of the foot. Like any shoes or boots, safety shoes will not be comfortable unless they fit properly.

Most reputable safety shoe dealers can fit all sizes and widths from AAAA to EEE. If they fit properly, the steel toe cap will only be noticed if it prevents an injury, when you are squatting or otherwise have your toes bent far back, or if you kick something and push your toes against the toe cap.

Safety shoes are available in a wide variety of styles, including dress shoes, western boots as well as leather and rubber work boot styles. Some special purpose boots are available which incorporate instep guards to prevent injuries behind the toes, Kevlar® pads to prevent cuts from chain saws, and with caulks (screw-in spikes) to prevent slips when working on logs or ice.

Rubber boots are recommended for tasks involving prolonged contact with water or whenever there is a risk of exposure to hazardous chemicals, such as pesticides. Just as when selecting rubber gloves, make sure the material is suitable for the exposure. To prevent water and chemicals entering the top of the boot, place the coveralls outside the boot to shed water onto the ground.

A consideration that is often overlooked when using rubber boots is perspiration removal. Because rubber boots do not breathe, perspiration cannot readily escape, so the socks and feet will eventually be soaked with perspiration. Keeping the feet dry is essential for good health, so proper measures must be taken. Socks of polypropylene and cotton blends can help wick the moisture away, and moisture absorbent liners are available as well. Remove the boots and allow the feet to 'breathe' and dry occasionally.

To help prevent foot health problems always wash and dry the feet at the end of each day, allow footwear to dry and air out between uses, and begin each day with clean, dry socks.

## Body Protection

The skin is your body's largest organ and performs a number of vital functions: keeping moisture in; sweating to cool your body; and keeping harmful agents from entering the body. Because the skin is exposed to so many hazards, it is important to protect it. While the skin can adequately protect the body from many hazards (such as most bacteria), it can easily be penetrated or damaged by many chemicals.

Another alarming fact is the increased incidence of skin cancers resulting from sun exposure. People who spend long hours in the sun are at increased risk of developing skin cancer unless they take protective measures.

Friction, scrapes, and cuts are also common sources of skin injuries and irritation. Properly selected clothing can prevent or minimize the chances of many skin disorders. 'Normal' clothing can prevent many types of skin problems. For example, a light colored long-sleeve shirt can protect the arms and upper body from sunburn and reduce the risks of skin cancers, and the long-sleeve shirt may be cooler than a short-sleeve shirt when working in the sun because it will reflect the sunlight. Other clothing that helps prevent sunburn and skin cancer includes a wide-brimmed hat to protect the ears, face and neck and long pants to protect legs.

Coveralls should be made of a tightly woven fabric such as cotton or polyester or of a non-woven fabric. They should fit loosely. Unless there is a layer of air between the coverall and the skin, any chemical that gets through the coverall will be in direct contact with the skin. Each layer of clothing worn under the coverall adds not only a layer of material, but also a protective layer of air. Well-designed coveralls have tightly constructed seams and snug, overlapping closures that

do not gap or become easily unfastened.

Rubber or chemical-resistant aprons are needed when handling liquids for prolonged periods of time, or when handling concentrated chemicals. Wear an apron even if other protective clothing is also being worn. Keeping the skin clean and dry is always important, but the groin area is especially sensitive. Chemicals can penetrate the skin of the groin area more than 11 times more readily than through the forearm. A splash of a concentrated chemical here could result in a high dose of toxins entering the body very quickly.

Choose an apron that extends from the neck to at least the knees. Some aprons have attached sleeves, which can also protect the arms. Be aware that an apron can be a safety hazard in some situations. It can get in the way or get caught in machinery. In these situations, consider wearing a chemical-resistant suit instead.

Chain saw safety chaps or pants minimize the risk of cutting the legs when operating a chain saw. The chaps will not prevent all cuts but have been proven effective in reducing the severity of leg injuries from chain saw cuts.

Made from Kevlar® or other ballistic materials, the chaps prevent many cuts by covering the cutters with fibers to reduce their cutting efficiency, giving the operator a small amount of additional time to regain control of the saw. Some people use chain saw chaps when loading square bales of hay to reduce the number of scratches and scrapes on their legs from carrying and boosting the bales upward with their knees. The chaps also help protect the legs from thorns when walking through brushy areas.

## Respiratory Protection

**IMPORTANT:** Use only respirators approved by NIOSH or MSHA for the hazards present in the workplace.

Operators are exposed to irritating and potentially harmful airborne contaminants while working at a surface irrigation facility. Examples of air contaminants include particles of pollen, bacteria, mold spores, wastewater aerosols, hazardous chemicals, engine exhausts and welding fumes. The respiratory system is one of the easiest ways contaminants can enter our bodies.

One problem with occupational illnesses is that the worker may not associate the illness with job-related exposures. Symptoms of respiratory illness may be mistaken for the flu, common cold or simple exhaustion.

Another problem is that people may perform a particular task for years without experiencing adverse health effects, but suddenly experience a severe reaction to even slight exposures to

contaminants. The body can become 'sensitized' and no longer tolerate even small exposures to a substance. Additionally, some exposures can lead to permanent lung injury and disability.

Selecting and using a respirator involves more than simply purchasing one and putting it on. Using the wrong respirator, or using a respirator improperly, can result in serious illness or death. The respirator must be selected for the specific contaminant(s) in your workplace, and it must fit properly. In addition, the respirator must be properly cleaned, inspected, and stored after each use to prolong its life and help ensure protection for later uses.

The best way to select a respirator is to consult an industrial hygienist or other similarly qualified professional. If respirators are needed, these professionals can assist with selection, fit testing and training you and your employees to use the respirator properly. Additionally, a written respiratory protection program must be developed that specifies how these tasks will be accomplished.

There are two basic types of respirators: air-purifying respirators and air-supplying respirators.

- Air-purifying respirators remove contaminants from the air by filtering dust, mists, and particles or by removing gases and vapors. These respirators will not protect an operator from fumigants, from high concentrations of vapor, or when the oxygen supply is low. Air-purifying respirators pass air through the air purifying material in two ways. Negative-pressure respirators depend on the wearer's lungpower to draw air through the purifying material. Powered air-purifying respirators (PAPR's) assist the wearer by forcing air through mechanically. PAPR's purify contaminated air as it passes through the filter; they do not supply oxygen. There are several styles of air-purifying respirators:
  - Cup-style respirators filter out dust, mists, powders, and particles. They are usually shaped filters that cover the nose and mouth.
  - Cartridge respirators are half-mask or full-face respirators that have chemical cartridges containing air-purifying materials. Many chemical cartridge respirators can be fitted with particulate pre-filters. By using the proper cartridges and pre-filters, it is possible to use chemical cartridge respirators in a variety of situations. Chemical cartridges are color-coded so you can determine immediately whether the correct respirator is in use. The cartridge needed depends on the contaminants present since different filter materials must be used for the various chemical hazards.
  - Canister respirators (gas masks) are full-face respirators with attached canisters containing air-purifying materials. Canisters usually contain more air-purifying materials than cartridge respirators. The face-piece is designed to be cleaned and reused. Canisters can be replaced.

- Air-supplying respirators supply clean, uncontaminated air from an independent source. These are the only respirators that provide oxygen and can be used in oxygen deficient atmospheres or atmospheres that are immediately dangerous to life or health. There are two types: the supplied-air respirator and the self-contained breathing apparatus (SCBA). A supplied-air respirator provides breathing quality air from an approved air pump located in a safe atmosphere or from a remote tank of breathing air. An SCBA supplies clean air from cylinders that are carried with the operator, usually on the back. Air-supplied respirators must be inspected and tested regularly and should only be used by specially trained individuals. Use by untrained persons could lead to serious injury or death.

### *Health and Safety Hazards*

As an operator of a surface irrigation facility, you will be exposed to numerous common hazards:

- physical injuries
- infections and infectious diseases
- oxygen deficiency
- toxic or suffocating gases or vapors
- chemical contamination
- explosive gas mixtures
- fire
- electrical shock
- noise-induced hearing loss
- dust, fumes, and mists
- heat exhaustion and heat stroke

### *Health and Safety Measures*

There are numerous safety practices, training, and equipment that an operator can use to minimize the risk of the hazards listed above. These include:

- process safety management and risk management programs
- confined space safety
- general site safety
- lockout/tagout policies
- electrical safety
- mechanical safety
- vehicle safety
- lagoon safety
- fire prevention and protection
- excavation and shoring safety
- medical safety

## *OSHA Process Safety Management & EPA Risk Management Programs*

These two programs regulate how certain highly hazardous chemicals are to be used, stored, or manufactured. The goal of both programs is to prevent accidental releases of the substances that can cause serious harm to the public and the environment. If you store or have on site at any one time more than a “threshold quantity” (TQ) of the chemicals listed below, then a process safety program and/or a risk management program may be needed. EPA and OSHA have slightly different listings and slightly different threshold quantities and exemption from one program does not necessarily mean exemption from the other.

Generally, if a wastewater treatment facility uses the chemicals in the amounts listed in Table 7-1, the facility will need to develop a program. Specific information on the OSHA program can be found in 29 CFR 1910.119 and specific information on the EPA program can be found in 40 CFR 68.

<b>Chemical</b>	<b>EPA TQ</b>	<b>OSHA TQ</b>
Chlorine	2,500	1,500
Anhydrous Ammonia	10,000	10,000
Aqueous Ammonia	>20% 20,000	> 44% 15,000
Anhydrous Sulfur Dioxide	5,000	1,000 (liquid)
Methane	10,000	10,000
Propane	10,000	10,000

Table 7-1. Threshold quantities for chemicals requiring a process safety program or risk management program (all quantities are in pounds).

## *Confined Space Safety*

Many different areas in wastewater treatment facilities are considered confined spaces. There are two types of confined spaces. The first, a confined space, is defined as a space that has limited means of access (entry) and egress (exit), has an adequate size and configuration for employee entry and is not designed for continuous worker occupancy. The second type, a permit-required confined space, requires a permit for entry.

A permit-required confined space is a confined space that may have a potentially hazardous atmosphere, may have an engulfment hazard, may have an entrapment hazard, or it may contain any other recognized hazard.

If a facility has permit-required confined spaces, a written confined space entry program must be



developed and implemented to be in compliance with OSHA regulations. Enclosed facilities that are used to handle wastewater or wastewater solids, such as the tanks and/or tanker trucks, would fall under the permit-required confined space regulations. **Do not enter a permit-required confined space without proper training, equipment, and support personnel.** (The confined space regulations can be found in the Code of Federal Register 29 CFR 1910.147.)

The atmosphere of a confined space may be extremely hazardous because of the lack of natural ventilation. This can result in the following dangerous situations:

- oxygen-deficient atmospheres
- flammable atmospheres
- toxic atmospheres

An oxygen-deficient atmosphere has less than 19.5% available oxygen (Figure 7-1). Any atmosphere with less than 19.5% oxygen should not be entered without an approved self-contained breathing apparatus (SCBA). Oxygen-deficient atmospheres may be found in sewers, manholes, septic tanks, and pump tanks.

When working in a confined space that does not require a permit, a number of safety actions must be taken:

- Use a ladder, hoist or other device when accessing these work areas.
- Verify that the confined space is clean and well ventilated. Test the atmosphere of the space, from the top of the workspace to the bottom, for flammable/toxic gases and oxygen deficiencies PRIOR to entering the workspace and repeat testing during the work period.
- Use lifelines and always assign a standby person to remain on the outside of the confined space. It is the standby person's responsibility to be in constant contact (visually and/or verbally) with the workers inside the confined space as long as anyone is in the space.
- Wear ear protection, as needed. Noise within a confined space can be amplified because of the design and acoustic properties of the space.
- Be mindful of the possibility of falling objects when working in confined spaces.
- SCBA should be used in confined spaces where there is insufficient oxygen.

## General Site Safety

A surface irrigation application site should be restricted to authorized personnel. This is necessary to prevent mishaps involving the public and to help ensure that the site and all equipment are protected from vandalism and theft. Maintaining the surface irrigation application site promotes a safe, well-kept working environment. Site maintenance includes the following:

- Keep walks, aisles and access ways clear of tools and materials. It is also important to maintain clear access to electrical panels, control valves and fire extinguishers.
- Clean up puddles of oil, sludge, wastewater, or fuel promptly and thoroughly. Use absorbent material if necessary.
- Dispose of dirty and oily rags, used absorbent materials, trash and other waste materials in approved containers. The waste should be removed from the site and disposed of properly.
- Provide scrap containers or scrap collection area where needed.
- Keep the sanitary facilities clean.
- Keep supply areas organized and free of hazards.
- Provide adequate illumination and ventilation.

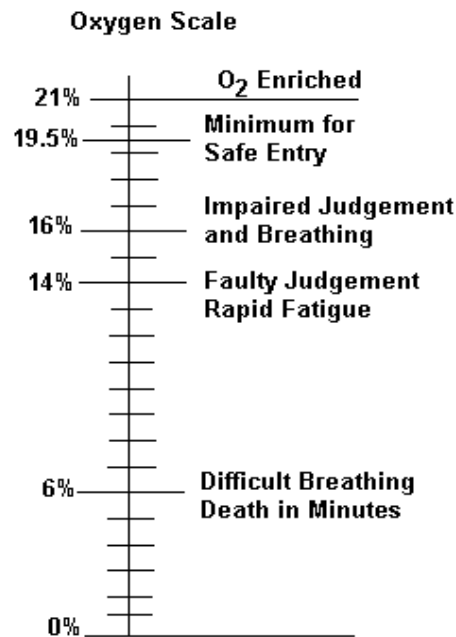

Figure 7-1. Oxygen scale (from Confined Spaces, 1988).

### *Lockout/Tagout Policy*

A lockout is a padlock placed on a power source to block the release of hazardous energy that could set a machine in motion or otherwise endanger an employee working on the machine. Locks are usually used with a lockout device that holds an energy control point, such as a switch lever or valve handle in the “off” position and prevents machines or equipment from being operated while the machine is being worked on.

A tagout is a written warning that tells other workers not to operate a switch or valve that could release hazardous energy or set a machine in motion. Lockout is preferred because it is a more secure method of controlling and isolating hazardous energy sources. Although lockout/tagout policies most commonly refer to electrical energy, the following types should also be covered:

- mechanical
- hydraulic
- pneumatic
- stored
- chemical
- thermal

A written lockout/tagout program should be developed that specifies how individual machines or equipment will be taken out of and returned to service. Once the program has been developed, all employees who use or perform maintenance on any of the affected equipment must be properly trained.

### *Electrical Safety*

Treat all electricity and electric power equipment with caution. Ordinary 120 V electricity can be fatal. Most wastewater treatment systems operate from 120 V to 4000 V or more. In case of electrocution, turn off power to the electrical source or use an insulated implement, such as a piece of wood to separate the person from the source. Do not attempt to pull a victim away from the electrical source with your bare hands.

The following is a list of general electrical safety practices (from Operation of Municipal Wastewater Treatment Plants, WEF):

- Allow only qualified and authorized personnel to work on electrical equipment and wiring or to perform electrical maintenance.
- Provide and use lockout devices and tags at all locations.
- Always assume electrical equipment and lines to be energized unless they are positively proven to be de-energized and properly grounded. If it is not grounded, it is not dead.

- Prohibit use of metal ladders or metal tape measures around electrical equipment.
- Ensure that two people always work as a team on energized equipment.
- Use approved rubber gloves on voltages more than 300 V.
- Do not open an energized electrical control panel.
- Before work is done on a line or bus that operates at 440 V or higher, be sure it is de-energized, locked out, and grounded in an approved manner.
- Do not test a circuit with any part of the body.
- Prevent grounding by avoiding body contact with water, pipes, drains, or metal objects while working on electrical equipment or wiring.
- Do not bypass or render inoperative any electrical safety devices.
- When working in close quarters, cover all energized circuits with approved insulating blankets.
- Use only tools that have insulated handles.
- Never use metal-cased flashlights.
- Do not wear jewelry when working with or near electric circuitry.
- Ground or double-insulate all electrical tools.
- Use rubber mats at control centers and electrical panels.
- Always keep electric motors, switches, and control boxes clean.

### *Mechanical Safety*

Always make sure that sprinklers, guns, hydrants, valves, and plugs are not pressurized when servicing or repairing surface irrigation equipment. Pressure can cause parts to blow off equipment, resulting in injuries. When servicing, always turn pumps off and de-pressurize lines by opening drain valves or opening discharge points to relieve water pressure. If you must clean a nozzle, operate an isolation valve, and clean the nozzle when not under pressure. Always use the proper tools when working in valve boxes. These areas can be pinch points and are favorite havens of spiders and snakes, so be alert!

Equipment such as traveling guns and center pivots (tractors) have many pinch points and moving parts. Always keep equipment guards in place, always tie back long hair, and do not wear loose clothing when operating this type of equipment. Be familiar with operational parameters from manufacturers' literature. Have a qualified electrician install and service all electrical systems for this type of equipment.

Operating traveling guns (or hard-hose travelers) on steep and complex terrain can present safety

concerns. Slopes up to 15 percent (and possibly slightly higher) can be effectively managed with traveling guns. However, the guns should be traversed across the slopes in an “up and down” fashion as opposed to pulling the gun sideways across the slope. If the gun is pulled sideways across the slope, the potential for a flipped gun cart is much greater.

Should a gun cart flip, the system continues to apply wastewater from whatever position the sprinkler gun is in, creating a safety hazard. Gun carts typically have an adjustment that allows the wheel or track width to be increased. The widest footprint possible should be used on sloping terrain. Side slopes above eight percent should be avoided if a sideways pull must be used. Travel lanes for gun carts should be inspected for steeply sloping areas, gullies, tree roots, rocks, or any other disturbances in a field. These all have the potential to cause the gun cart to come off track or flip over. These situations must be corrected, or another travel lane selected, to use the field safely.

### *Machine Guarding*

Any machine part, function, or process, which may cause injury, must be safeguarded. Safeguards are needed in the following locations:

- at the point of operation, where the machine contacts the material and performs operations such as cutting, punching, grinding, boring, forming or assembling
- near power transmission components such as pulleys, belts, connecting rods, cams, chains, sprockets, cranks, and gears
- at other parts of the machine that move (rotation, reciprocating movement, transverse movement) while the machine is working

Operate machinery only if you have been trained and authorized to use it. Don't wear jewelry on the job. While gloves are recommended for many tasks, don't wear them in situations where they could get caught and draw you into a machine. Don't try to adjust or reposition material while a machine is running. Wear the appropriate PPE equipment. Always operate machinery with the safeguards in place. Report missing or damaged safeguards to the site supervisor.

### *Pressure/Vacuum Equipment*

The proper venting of storage tanks is imperative. Pressure relief valves must be kept in good working condition. In addition, venting procedures should be used when operating equipment.

- Vent tank (so there is no pressure or vacuum) by opening hatches or manholes.
- Do not go on top of a tank when it is under pressure, as the pressure relief valve can operate at any time.
- When opening a pressurized tank's manhole cover after the pressure has been relieved,

always open the clamping devices next to the hinge first. Open the clamp with the safety catch last.

- Relieve the pressure in the hose before disconnecting it to avoid possible injury from unrestrained action of the hose or spill of wastewater.
- Do not restrict or block off safety valves or blow-down lines.
- The accumulation of gases within a confined space offers the potential for the vessel to explode or relieve the pressure at a weak point. ALWAYS stay to the side of all covers when opening. NEVER stand with your head or body over the cover when opening.

### *Hydraulic Systems*

- Do not open pressurized lines. Hydraulic fluid can cause severe burns, eye injury, or skin irritation.
- Search for leaks in the line using a piece of cardboard or wood, not your hands.
- If anyone is injured by hydraulic fluid: first, administer first aid; then contact a physician.
- Stay clear of leaky hydraulic lines.

### *Vehicle Safety*

Only employees with a current, valid N.C. driver's license can drive vehicles. In the case of specialized vehicles, only trained operators should operate the vehicles. The driver of the vehicle should inspect the vehicle prior to operating it and follow these guidelines while operating it:

- All vehicles should be always operated within the legal speed limit or at slower speeds where conditions warrant.
- Vehicles should not be used to transport unauthorized personnel.
- The driver should be familiar with the capacity and required clearances for safe use of the vehicle.
- Vehicle windshields and windows should be kept clear of obstructions.
- Objects or persons being transported should be located so that they do not obstruct the driver's view.
- Always know the proper operating procedures for each piece of equipment used.

### *Heavy Equipment Vehicles*

Make sure everyone is clear of the vehicle before starting. Slight steering movement can occur as the engine starts, causing machine movement. Stay clear of the engine when it is running. Work on the engine only when it is off. Do not move the steering wheel until everyone is clear of the vehicle.

### *Heavy Over-The-Road Vehicle Operation*

Carefully inspect trucks or trailers before moving to ensure that material and equipment are properly loaded and secure. Loads on trucks and trailers should not exceed rated capacities. Securely couple trailers to the towing vehicle when towing. Secure all trailers with safety chains or cables, except those attached to a tractor by a "fifth wheel."

### *Heavy Off-The-Road Vehicle Operation*

Drive at a safe, legal speed to ensure safety and complete control of the vehicle, especially over rough terrain. Unless the vehicle is designed for more than one person, no one other than the operator should be on the vehicle. Always observe the speed limits of local landowners. Yield the right-of-way to local trucks and local road maintenance machinery. Use chock blocks by the tractor and trailer when the driver leaves the vehicle.

### *Lagoon Safety*

Never go out on the lagoon to sample or for other purposes by yourself. Another worker should always be standing by in case of emergency. Always wear an approved life jacket when you are working from a boat on the surface of the lagoon. Never stand up in a boat while performing work. If it is necessary to drive a vehicle on a dam, make sure the roadway is maintained and is in good driving condition. Do not allow potholes or ruts to develop. Be extremely cautious when driving on dams during wet weather. If you must walk on the inside side slope, you should be harnessed and attached to prevent sliding into the lagoon.

### *Fire Prevention and Protection*

It is important to be fire-conscious in the outdoor environment. Employees should be knowledgeable of the fire conditions at the site and operate accordingly. Poor site maintenance, worn or defective electrical systems, and welding and cutting may contribute to dangerous situations.

The following precautions should be observed:

- do not smoke near equipment or fuel trailers
- no open flame should be allowed near wastewater storage tanks
- do not allow wastepaper, rags, and other combustible materials to accumulate
- do not tamper with or remove fire-fighting equipment from designated locations for purposes other than fire-fighting or rescue operations
- access to fire equipment should not be hindered
- if fire extinguishers are used they should be promptly recharged
- inspect fire extinguishers monthly to be sure they are in good operating condition

### *Excavation and Shoring Safety*

Working at a surface irrigation facility, you or your co-workers may have to excavate sewer lines periodically. You should be familiar with the fundamentals of excavating and the proper, safe methods of shoring a ditch.

The first step is to have the soil compressive strength measured by a competent person on site. Shoring/bracing is required when the depth of an excavation or trench is greater than five feet. Material taken from the excavation or trench must be stored more than two feet from the edge of the excavation. No heavy equipment or vibration should be allowed beside of the excavation. The excavation or trench needs to be checked periodically for change in conditions, especially after rainy or wet weather.



## *Medical Safety*

### First Aid Training

There should be always present or available a person (or persons) with first aid training. If the surface irrigation site is more than fifteen minutes away (including transport time) from a clinic, hospital, or physician, OSHA requires a designated person qualified in first aid and CPR training to always be present.

The training should include but not be limited to:

- bleeding control and bandaging
- artificial respiration, including mouth-to-mouth resuscitation
- poisons
- shock, loss of consciousness, stroke
- burns
- heat stress, heat stroke
- frostbite, hypothermia
- strains, sprains, hernias
- fractures and dislocations
- bites and stings
- transportation of the injured
- specific health hazards likely to be encountered by co-workers

There should be adequate first aid kits and supplies on site and readily available. A list of all employees with first aid qualifications should be posted, along with a list of emergency telephone numbers.

### Blood-borne Pathogen Awareness

All workers at a surface irrigation facility should be aware of the potential for contracting a blood-borne disease, such as hepatitis A or tetanus. Human Immunodeficiency Virus (HIV) is also considered a blood-borne pathogen and precautions should be taken when in direct contact with wastewater or sewage. One study has shown that HIV can survive in wastewater for up to twelve hours.

OSHA requires an employer to provide specific training and personnel protective equipment for your job if a blood-borne pathogen exposure is expected by job classification. Components of such a program are:

- safe work practices
- use and care of PPE
- housekeeping
- employee training
- incident reporting
- employee medical monitoring

## Eyewash Stations

Suitable facilities for quick drenching or flushing of the eyes and body should be provided in areas where the eyes or body of any person may be exposed to injurious chemicals and materials. Eyewash equipment can either be portable or permanently installed. Both styles of dispensers allow a gentle trickle of water to flow across the eye. If someone's eyes have been exposed to a chemical, such as chlorine gas, the eyes should be flushed for at least 15 minutes to dilute and remove as much of the chemical as possible. Medical professionals should be consulted for any eye injury.

## Immunization

Each facility may want to consult a physician or the local health department to determine the need for immunizations for the employees working at the site. Adult tetanus and diphtheria should be given routinely every 10 years, or at shorter intervals when injury occurs.

## Personal Hygiene

Because wastewater contains pathogens, good personal hygiene is very important. Good hygiene is one important way to reduce your exposure to these pathogenic organisms.

- Keeping your hands away from your nose, mouth, eyes, and ears to avoid ingestion of wastewater.
- Wearing protective clothing (such as non-permeable gloves) when handling any equipment covered with wastewater.
- Taking special care (e.g., protective, waterproof dressing) to keep any area of broken skin covered to avoid possible infection. If a worker suffers an injury that results in an open wound or laceration, they should be given a tetanus booster.
- Washing hands thoroughly with soap before smoking, eating, drinking, or after work.
- Changing and washing work clothing daily.
- Washing any areas that encounter wastewater thoroughly with water and soap. Sponging any cuts with an antiseptic solution and covering with a clean, dry gauze dressing and waterproof adhesive.

## Safe Lifting and Carrying Techniques

Everyone should observe the following guidelines to avoid possible injury when lifting and carrying objects:

- test the load first and do not move more than is comfortable
- set your feet far enough apart to provide good balance and stability (approximately the width of your shoulders)
- get help for large, bulky, or heavy items
- get as close to the load as practical and bend the legs about 90 degrees at the knees
- straighten your legs to lift the object, and at the same time, bring your back to a vertical position - the objective is to use your legs to lift rather than your back
- never carry a load that blocks forward vision
- to lower the object, repeat the stance and position for lifting, bend the legs to 90 degrees and lower the object
- when lifting an object with another person, be sure that both individuals lift at the same time and put the load down together

## Public Health and Safety

In addition to striving to protect the health and safety of employees, coworkers, and themselves, surface irrigation system owners and operators also have a responsibility to protect the health and safety of the public. The public is often unaware of the dangers associated with a surface irrigation facility. A surface irrigation facility and application site should be restricted to authorized personnel to prevent exposure of the public to physical injuries and to possible contamination from pathogens and vectors (animals or organisms capable of transporting infectious agents).

By properly operating and maintaining the system (thereby reducing the risk of spills, overflows, and runoff), an operator reduces the risk of contaminating ditches, waterways, and adjoining properties. This, in turn, protects the public from contact with contaminated surface waters or groundwater.

If spills or discharges do occur, rapid mobilization of a well-thought out and well-practiced emergency response plan (Chapter 5) can minimize the health and safety threat to the public.



## Chapter 8

### North Carolina Regulations

This chapter discusses the North Carolina statutes and regulations that govern the surface irrigation of wastewater. There are several sets of regulations that you must be familiar with.

The first set of regulations discussed below (15A NCAC 2T) contains surface irrigation permitting and operational requirements. The 2T rules were enacted on September 1, 2006 and replaced 15A NCAC 2H .0200.

The second set of regulations (15A NCAC 2L) applies to groundwater classification and standards. These regulations will be important if the surface irrigation system you operate is required to have groundwater monitoring wells.

The third set of regulations (15A NCAC 8G) contains specific requirements for certified surface irrigation system operators, as well as other certified water pollution control system operators.

#### *8.1 Permit Regulations and Requirements: 15A NCAC 2T*

According to North Carolina General Statute 143-215.1(a)(2), any system that collects, treats, or disposes of waste cannot be constructed or operated without a permit. This statute gives the North Carolina Environmental Management Commission (EMC) the authority to issue permits for the surface irrigation of reclaimed water and wastewater.

The EMC delegates its permitting authority to the North Carolina Department of Environmental Quality (DEQ). The DEQ Division of Water Resources (DWR) reviews applications and issues surface irrigation system permits.

#### Surface Irrigation System Permits

Surface irrigation systems are permitted as “non-discharge systems”. They are not allowed to discharge wastewater to surface waters of the State. Any intentional or unintentional diversion of untreated wastewater from a surface irrigation system or bypassing of a surface irrigation system is considered a discharge and is prohibited.

Wastewater irrigation systems are regulated under 15A NCAC 2T (Appendix C-1). These regulations apply only to systems that involve application of wastewater to the land surface. Subsurface wastewater disposal systems are covered under separate regulations and are administered by the Department of Environmental Health and local health departments.

Systems permitted for surface irrigation of wastewater include:

- single-family residence systems
- municipal wastewater systems
- commercial and industrial wastewater systems

Reclaimed water permits are regulated under 15A NCAC 2U.

A detailed review of the process involved in applying for and receiving a surface irrigation permit is beyond the scope of this manual. Many of you may never be involved in this process. However, the following discussion will give you an overview of the process in the event that you are involved in obtaining a permit for a new facility, an expanding facility, or a permit renewal for an existing facility.

The Division of Water Resources' Non-Discharge Permitting Unit reviews permit applications and issues permits for a variety of non-discharge systems, including surface irrigation systems. Applications must be made on state supplied application forms. An application for a surface irrigation system permit is in Appendix C-2.

Although every effort is made to process applications as quickly as possible, applicants should be prepared for a wait of sixty to ninety days from the date the Non-Discharge Permitting Unit receives a complete application package until the permit is acted upon. Therefore, it is extremely important that all applications be submitted as far in advance of the planned construction start-date as possible to ensure that the permit is issued by that time.

### *Permit Applications for New Systems*

A complete permit application package for a new domestic, commercial, or industrial surface irrigation system includes:

- a completed application form (signed by the applicant and signed and sealed by a professional engineer).
- a check for the annual fee.
- an operational agreement.
- a signed and sealed N.C. licensed soil scientist's report.
- a hydrogeologist's report.
- a signed agronomist's report.
- final engineering plans, specifications, and calculations for the entire collection, treatment, and disposal system.
- a description of the treatment system.
- a complete chemical analysis of the effluent or expected concentrations in the effluent.

A complete permit application package for a new reclaimed water/reuse system includes all the

above except the agronomist's report. The original application package and four copies must be submitted to the Non-Discharge Permitting Unit. Incomplete application packages will be returned to the applicant.

Surface irrigation permits are generally issued for 5 years. If DWR has concerns with either the application site or the effluent that will be applied, the permit may be issued for a shorter time period.

### *Permit Renewals*

When requesting permit renewal, only a completed application form is required. To allow time for processing, the application must be submitted to Non-Discharge Permitting Unit at least 180 days prior to the expiration date of the permit. Otherwise, the permit may expire before DWR issues the permit renewal.

### *Permit Modifications*

A permit modification includes any change to an existing system as described in the surface irrigation permit. The specific definition of a permit modification can also be found in NCGS 143-215.1(a). Examples of permit modifications include:

- an increase in flow.
- the addition of surface irrigation fields.
- increases in pipe, pump sizing, or sprinkler head design.
- the addition of treatment components to the system.

All system modifications must be approved prior to the initiation of the modification. If you have any questions about what is considered a modification, check with the Land Application Unit before any action is taken.

### *Permit Fees*

All surface irrigation permits have annual permit fees. For new systems, the annual permit fee is due at the time the permit application is submitted. Failure to include the annual fee with a new permit application will result in the return of the application to the applicant without processing. There is no additional fee for permit renewals that involve no modifications or for minor permit modifications (such as name changes).

A major permit modification is subject to a fee in addition to the annual permit fee. Examples of major permit modifications are the addition of new irrigation fields or new sources of waste.

### *Permit Rescissions*

When a permitted surface irrigation system is no longer needed or can no longer be operated, the permittee must request that DWR rescind or nullify the permit. The permittee cannot simply shut the system down and walk away from it. To get a permit rescinded, the permittee must submit a written rescission request to DWR.

Before rescinding a permit, DWR must be satisfied that the system is not and will not become a threat to the environment or public health. A permitted system remains the permittee's responsibility until DWR issues a written permit rescission.

### *Permit Revocations*

The Division of Water Resources can revoke, or take away, a permit if the annual permit fee is not paid. Permit revocation means that the system no longer has a permit and cannot be operated. A permit can also be revoked for improper operation of the system.

## The Issued Permit

A surface irrigation permit is a comprehensive document that addresses the compliance needs and operational requirements of the system. It is also a legal and binding agreement and is enforceable by law. Therefore, it is extremely important for the permittee to maintain a copy of the permit and to be familiar with and fully understand the conditions of the permit. An example of a surface irrigation system permit is in Appendix C-3.

It is the permittee's responsibility to ensure that the system is properly operated, properly maintained and is in compliance with permit conditions. Ultimately, it is the permittee who is responsible for any violation of a permit condition, regardless of who is actually operating the system. The consequences for violating a permit condition will be discussed later in this section.

If someone other than the permittee is designated to actually operate the system (as is often the case), it is extremely important that the operator also be familiar with and understands the conditions of the permit. Specific operator responsibilities will be discussed in detail at the end of this chapter.

## Permit Conditions

Permit conditions vary from permit to permit, but all surface irrigation permits contain requirements concerning the following:

- I. Schedules
- II. Performance Standards
- III. Operation and Maintenance Requirements
- IV. Monitoring and Reporting Requirements



- V. Inspections
- VI. General Conditions
- VII. Attachment A (sources)
- VIII. Attachment B (sites)
- IX. Attachment C (monitoring wells)

### *Schedules*

- Include any one-time compliance events.
  - Submission of updated site plan.
  - Submission on landowner agreement form.
- Read entire permit for continuous monitoring and reporting requirements.

### *Performance Standards*

How wastewater must be applied:

- no discharge allowed
- protection of surface waters & groundwater
- operation as a non-discharge system
- establishment of effluent limits (Attachment A)
- establishment of application rates (Attachment B)
- establishment of setbacks
- establishment of compliance and review boundary

Depending on specific concerns at a surface irrigation system, additional conditions are sometimes added to protect the environment or public health. Examples of additional requirements include:

- effluent monitoring (for reuse systems located on public access areas, such as golf courses)
- site limitations
- groundwater monitoring

### **Setbacks**

Setback means the minimum separation in linear feet, measured on a horizontal plane, required between a treatment works, disposal system, or utilization system and physical features such as building, roads, property lines, or water bodies. In general, surface irrigation permits require the setback distances outlined below (Tables 8-1 and 8-2). However, you should always consult the system permit for specific requirements.

<b>Physical Feature</b>	<b>Minimum Setback (feet)</b>
Habitable residence or place of public assembly under separate ownership or not to be maintained as part of the project site	100
Private or public water supply source	100
Surface waters (streams – intermittent and perennial, perennial waterbodies, and wetlands)	50
Wells with exception to monitoring wells	100
Property lines	50

Table 8-1. Setback requirements for treatment and storage units (2T).

<b>Physical Feature</b>	<b>Wastewater (feet)</b>	
	<b>Spray</b>	<b>Drip</b>
Habitable residence or place of public assembly under separate ownership or not to be maintained as part of the project site	400	100
Habitable residence or places of public assembly owned by the permittee to be maintained as part of the project site	200	15
Private or public water supply source	100	100
Surface waters (streams – intermittent and perennial, perennial waterbodies, and wetlands)	100	100
Groundwater lowering ditches (where the bottom of the ditch intersects the SHWT)	100	100
Surface water diversions (ephemeral streams, waterways, ditches)	25	25
Wells with exception to monitoring wells	100	100
Property lines	150	50
Subsurface groundwater lowering system	15	15
Top of slope of embankments or cuts of two feet or more in vertical height	10	10
Any water line from a disposal system	100	100
Swimming pools	100	100
Public right of way	50	50
Nitrification fields	20	20
Building foundations or basements	15	15

Table 8-2. Setbacks for wastewater application areas (2T).

Achieving the reclaimed water effluent standards allows the system to use the setbacks located in 15A NCAC 02U for property lines and the compliance boundary shall be at the irrigation area boundary.

Setback waivers must be written, notarized, signed by all parties involved and recorded with the County Register of Deeds. Waivers involving the compliance boundary shall be in accordance with 15A NCAC 02L .0107.

### *Operation and Maintenance Requirements*

This section of the permit requires that an Operation and Maintenance Plan be developed and maintained. Each operation and maintenance plan is specific to the facility for which it was written. The maintenance and management of the soils and crops should be specifically addressed in the manual since the overall function of the system relies on these components. All crop management issues should be addressed in this manual, along with timing recommendations for the relevant maintenance procedures.

At a minimum, the plan must include:

- a description of the operation of the system in detail to show what operations are necessary for the system to function and by whom the functions are to be conducted
- a description of anticipated maintenance of the system
- provisions for safety measures including restriction of access to the site and equipment
- spill control provisions that include response to upsets and bypasses, including control, containment, and remediation, and contact information for personnel, emergency responders, and regulatory agencies.

Other permit conditions found in a typical surface irrigation permit include:

- the facility shall be effectively maintained and operated as a non-discharge system to prevent the discharge of any wastewater resulting from the operation of the facility
- upon classification by the WPCSOCC, certified operators must be designated
- a suitable year round vegetative cover must be maintained at all times
- adequate measures must be taken to prevent effluent ponding and runoff
- no irrigation shall be performed during inclement weather or when the ground is in a condition that will cause runoff
- all irrigation equipment must be calibrated at least once per permit cycle
- no automobiles or machinery shall be allowed on the irrigation area except while installation occurs or while normal maintenance is being performed
- public access to the irrigation sites and treatment facilities is prohibited

- any residuals generated must be disposed of or used as required
- diversion or bypassing of untreated or partially treated wastewater from treatment facilities is prohibited
- freeboard in the lagoon(s) shall not be less than two feet (in most cases) at any time
- liquid level gauges in lagoon(s) are required
- the application rate shall not exceed the permitted rate
- a protective vegetative cover must be established and maintained on all earthen embankments, berms, surface water diversions, etc. Earthen embankments must be kept mowed or otherwise controlled and accessible

### *Monitoring and Reporting Requirements*

Monitoring and reporting requirements are spelled out in every permit. Monitoring, reporting, and penalties are discussed in more detail later in this chapter.

### *Inspections*

The permittee or designee must conduct regular inspections of the surface irrigation system to prevent malfunctions and deterioration, operational errors, and discharges. A log of these inspections must be maintained at the site for a period of 5 years from the date of the inspection.

At a minimum, the log must include:

- date and time of inspection
- visual observations of the irrigation storage structure(s) and surface irrigation site
- record of preventative maintenance
- date of calibration of flow measurement device
- other information as specified in the permit

Permitted systems are also subject to inspection by DWR. Any DWR representative can, upon presentation of credentials, inspect any surface irrigation system at any reasonable time for the purpose of determining compliance with the system permit. Division representatives may inspect or copy any records that must be maintained under the terms and conditions of the permit and may obtain samples of groundwater, surface water or leachate.

DWR regional office staff usually conducts compliance inspections prior to the initial start-up of the system, the initial operation of groundwater monitoring wells, or the renewal of the permit. Inspections also occur periodically in between. Systems that are not in compliance with permit conditions are subject to more frequent inspections.

### *General Requirements*

Surface irrigation permits are usually issued for a period of up to five years. Requests for permit renewal are due to the Division of Water Resources no later than 180 days prior to the expiration date of the permit.

Requirements of this section of the permit include:

- the permittee must comply with all statutes, rules, and ordinances
- the permit is not transferable
- the permittee must retain a set of approved plans and specs
- the permit must maintain the permit until the facility is properly closed or otherwise permitted
- the permittee must pay annual fees

### *Permit Rescissions*

When a permitted surface irrigation system is no longer needed or can no longer be operated, the permittee must request that DWR **rescind** or nullify the permit. The permittee cannot simply shut the system down and walk away from it.

To get a permit rescinded, the permittee must submit a written rescission request to DWR. Before rescinding a permit, DWR must be satisfied that the system is not and will not become a threat to the environment or public health. A permitted system remains the permittee's responsibility until DWR issues a written permit rescission.

### *Attachment A*

Attachment A establishes:

- approved sources
- effluent standards
- monitoring frequencies

### *Attachment B*

Attachment B establishes:

- approved application sites
- field number, owner, acreage, location
- allowable application rates

### *Attachment C*

This attachment establishes groundwater monitoring requirements, if any.

## *8.2 Monitoring and Reporting Requirements*

Surface irrigation permits contain monitoring and reporting requirements deemed necessary by DWR. All surface irrigation systems with a design capacity of 1,000 gallons per day or more require some type of monitoring and reporting. Smaller systems (with a design flow of less than 1,000 gallons per day) may or may not be subject to these requirements, depending on the specific permit. The permit also establishes the monitoring and reporting schedule that must be followed.

Monitoring may include:

- wastewater irrigation data
- wastewater or effluent sampling
- groundwater monitoring
- surface water monitoring sampling

### Types of Monitoring and Reporting

#### *Wastewater Irrigation Data*

Irrigation and infiltration must be reported on one of the following forms:

- ***Non-Discharge Application Report for Irrigation and Non-Conjunctive Utilization Systems (NDAR-1)*** - This form is for reporting the irrigation data.
- ***Non-Discharge Application Report for Infiltration Systems (NDAR-2)***. This form is for reporting infiltration (via basins or rotaries) data. This form is for low-rate and high-rate infiltration systems.

NDARs must be submitted to DWR within 30 days after month end. If no irrigation/infiltration takes place during the month, the report must still be submitted, indicating that no irrigation occurred.

If irrigation did occur, the following data must be recorded on the NDAR:

- weather conditions (temperature, precipitation)
- lagoon freeboard levels
- date of irrigation
- volume of wastewater irrigated
- field irrigated
- length of time irrigated
- continuous weekly, monthly, and year-to-date hydraulic loadings (in/ac) for each field; and
- maintenance of cover crops (i.e., type, when seeded, harvested, and mowed).

Each irrigation field in the permit must be referenced on an NDAR. There is space on the form to record data from two separate irrigation fields. If the surface irrigation system has more than two irrigation fields, an additional NDAR form (or forms) must be attached and submitted each month. The number of fields, field names, and associated acreage must remain constant from month to month, unless a permit modification is issued.

### *Wastewater or Effluent Monitoring Data*

Influent flow-monitoring data and wastewater monitoring results must be reported monthly using the **Non-Discharge Wastewater Monitoring Report Form (NDMR)**. This form is for reporting data from the Point Prior to Irrigation (PPI). The PPI is commonly the influent or effluent.

The following flow-monitoring requirements have been implemented in all new, modified, or renewed permits issued after June 1, 2000:

- systems permitted for 1,000 gallons per day or more, but less than 10,000 gallons per day, are allowed to monitor influent flow either by a flow-measuring device or by potable water usage.
- systems permitted for 10,000 gallons per day, or more are required to install an influent flow-monitoring device (if one is not already in place) and calibrate the device on an annual basis.

Like the NDAR, the NDMR must be submitted to DWR within 30 days after month end. If no wastewater monitoring takes place during the month, the completed NDMR report form must still be submitted with Operator in Responsible Charge visitation and daily flow information.

### *Nutrient Loading and Other Data*

Some permits are required to submit a monthly **Non-Discharge Mass Loading Report (NDMLR)**. This form is for reporting BOD, PAN, and TDS on fields.

### *Soil and Plant Tissue*

Surface irrigation permits require periodic monitoring of soil, and sometimes plant tissue. Sampling protocol and laboratory reports were discussed in Chapter 5. As with wastewater monitoring, the permit specifies when to sample, which parameters to have analyzed, and when to submit the results.

Some permits require a soil scientist or agronomist to review the test results and prepare a report to submit to DWR with the test results.

## *Groundwater Monitoring*

Some surface irrigation permits require periodic monitoring groundwater. The results are reported using the Groundwater Quality Monitoring Form for Permitted Facilities (Form GW-59) and the Compliance Report Form (Form GW-59a). Copies of these forms are in Appendix C-4.

Completed forms must be submitted to the address above. These forms can be downloaded from DWR's website (<http://portal.ncDEQ.org/web/wq/aps/gwpro/reporting-forms>).

Groundwater regulations and reporting requirements are discussed in further detail later in this chapter.

## *Surface Water*

Infrequently, surface irrigation permits may require surface water monitoring. For example, the permit may require surface water bodies near a particular field to be sampled. If required, the permit will specify when, where, and what to sample, and when to submit results.

## Submitting Monitoring Results

Completed forms (the original and two copies) must be submitted within 30 days of the end of the month to:

Division of Water Resources  
ATTN: Information Processing Unit  
1617 Mail Service Center  
Raleigh, N.C. 27699-1617  
Phone: 919-733-3221

Following the instructions below will minimize the chance of your reports being returned:

- The state-supplied forms are the only forms that are approved and accepted. Reports submitted on unapproved adaptations will be returned without being processed.
- The current version of the state-supplied forms must be used. Reports submitted on outdated forms will be returned without being processed.
- Report forms must be filled out correctly and completely or they will be returned without being processed.
- All required forms must be completed and submitted. If all forms are not submitted, those submitted will be returned without being processed.

Copies of the forms are included in Appendix C-4. Forms can be downloaded from DWR's website:(<http://deq.nc.gov/about/divisions/water-resources/water-resources->



permits/wastewater-branch/non-discharge-permitting-unit/reporting-forms) or obtained from your DWR regional office or from the Non-Discharge Permitting Unit.

## Non-compliance Notification

Non-compliance with permit conditions must be reported to DWR. The permittee must report to the appropriate DWR regional office as soon as possible, but in no case more than 24 hours or on the next working day, following the occurrence or first knowledge of the occurrence of the following:

- any occurrence that results in the treatment of significant amounts of wastes that are abnormal in quantity or characteristic, such as the known passage of a slug of hazardous substance through the facility, or any other unusual circumstances; or
- any process unit failure, due to known or unknown reasons, that renders the facility incapable of adequate wastewater treatment, such as mechanical or electrical failures of pumps, sprinkler heads, emitters etc.; or
- any failure of the system resulting in a by-pass directly to receiving waters without treatment of all or any portion of influent to such station or facility; or
- self-monitoring information indicates that the facility has gone out of compliance with its permit limitations.

A written report must be filed with the appropriate DWR Regional Office within 5 days following first knowledge of the occurrence. This report must outline the actions taken or actions proposed to ensure that the problem does not recur.

All permit conditions are important in the operation of a surface irrigation system. Ignorance of and failure to adhere to permit conditions will most likely result in non-compliance and the possible assessment of penalties against the permittee.

## Permit Violations and Enforcement Action

All permit conditions are important in the operation of a surface irrigation system. Ignorance of permit conditions and failure to adhere to them will most likely result in non-compliance and the possible assessment of penalties against the permittee.

As discussed at the beginning of this chapter, the Environmental Management Commission (EMC) has the authority to require and issue permits for surface irrigation systems. The EMC also has the authority to ensure that all permitted surface irrigation systems are properly operated and maintained in accordance with their permit conditions.

The enforcement powers of the EMC are outlined in General Statute 143-215.6, which authorizes the EMC to initiate enforcement actions. It also describes the types of actions and establishes the protocols upon which enforcement procedures and policies are based. As with permit issuance, the EMC delegates its enforcement authority to the Director of the Division of Water Resources.

### *Notice of Deficiency*

A Notice of Deficiency (NOD) may be issued for violations of minor duration and gravity, resulting in little or no harm to the environment or public health.

### *Notice of Violation*

A Notice of Violation (NOV) is a letter sent to the permittee giving notice of non-compliance with environmental law(s). The letter is designed to notify the permittee of the specific violation and associated regulation. In addition, the NOV describes the requirements that the permittee must take to correct the violation or must take because of the violation. Generally, the NOV indicates that the permittee must complete the corrective actions and notify the regulatory agency within a certain period.

Examples of possible violations are:

- violation of water quality standards or limits
- failure to secure a permit
- failure to act in accordance with the requirements of the permit
- failure to file, submit or make available any documents or data required
- refusing to allow a designated representative of the state to inspect the system

### *Enforcement Actions*

A NOV may be followed by an enforcement action. There are three types of enforcement actions that can be used to prompt or maintain compliance with environmental regulations:

1. civil penalties
2. injunctive relief
3. criminal penalties

The action most commonly taken is the assessment of civil penalties. **Civil penalties** are fines assessed against a permittee for violation(s) of environmental regulations. The assessment of a penalty is based on the specifics of each civil penalty case. The law requires consideration of specific assessment factors by the assessor for each case. General Statute 143-215.6A allows the assessment of civil penalties of up to \$25,000 per day per violation. Each day that a violation occurs may be considered as a separate violation.

***Injunctive relief*** is a court order to discontinue or prevent an existing or potential violation. This court order is often used if a permittee demonstrates consistent non-compliance with regulations or if an imminent danger exists to health or the environment.

General Statute 143-215.6B allows for the assessment of ***criminal penalties***, imprisonment, or both. A criminal penalty, or investigation leading to criminal prosecution, may be used if a violator willfully, knowingly, or negligently fails to comply with environmental laws.

### ***8.3 Groundwater Regulations & Requirements: 15A NCAC 2L***

In 1984, North Carolina implemented the "Classification and Water Quality Standards Applicable to the Groundwater's of North Carolina". This regulation, also known as 15A NCAC 2L, recognizes that unpolluted groundwater is suitable or potentially suitable for use as drinking water.

Fresh (non-brackish) groundwater is assigned the highest and best classification, Class GA. Brackish groundwater is considered potentially usable as drinking water and is classified as Class GSA. Polluted groundwater is generally unusable as drinking water and is classified as Class RS or restricted.

Most of the numerical and narrative standards are health-based, although the standards do recognize properties such as taste and odor, which are non-health related but define suitability. Table 8-3 lists some of the contaminants that can be introduced into the environment by surface irrigation systems.

<b>Contaminant</b>	<b>Maximum Groundwater Concentration</b>	<b>Fate If Properly Treated</b>	<b>Results if not treated</b>
Pathogens (bacteria, viruses, etc.)	1/100 ml	Filtered by soil and / or die off prior to reaching groundwater.	Sand and fractures likely speed contaminants in unpredictable directions and distances. Various human sicknesses as minor as diarrhea or as serious as infectious Hepatitis and Typhoid Fever.
Solids	NA	Reduced to acceptable levels by septic tank and soil treatment.	Most organisms and other contaminants are contained in solids.
Nitrate	10 ppm	Taken up by plants, escapes to atmosphere in gaseous form, diluted by groundwater to non-hazardous levels.	Possible leaching to groundwater: Blue Baby Syndrome (methemoglobinemia) Cardiac malfunction
Phosphorus	NA	Bound by the soil.	Algae blooms in rivers, lakes and other surface waters.

Heavy Metals			
Cadmium	0.005 mg/l	Bound by the soil.	Possible leaching to groundwater. Kidney damage and pulmonary emphysema.
Zinc	5.0 mg/l		
Nickel	0.15 mg/l		
Copper	1.0 mg/l		

Table 8-3. Contaminants that can be introduced into the environment by surface irrigation systems.

To determine if groundwater is being contaminated, some permits require groundwater monitoring. Monitoring activities include installation of monitoring wells, sample collection and analysis of groundwater, and reporting analytical data to DWR.

It is in best interest of the permittee that monitoring wells be properly located and constructed and that monitoring data be reported accurately and timely. To determine if a surface irrigation system has groundwater monitoring requirements, you should consult the permit and associated plans.

If monitoring wells are required, a qualified hydrogeologist must prepare a report describing the depth of the groundwater and must collect samples to establish background levels for the parameters of interest. As with other types of monitoring, the system's permit will specify what parameters to monitor, when to monitor, and when results must be submitted. Information concerning proper groundwater monitoring and sampling techniques is contained in Chapter 5 and Appendix B-4.

## Well Location

To achieve their intended purpose, monitoring wells must be located along the path of groundwater flowing underneath the disposal system. There must be at least one well hydraulically upgradient and at least one well hydraulically downgradient of the disposal system, as shown in Figure 8-1.

Analysis of groundwater sampled from the upgradient well establishes the quality of groundwater unimpacted by the disposal operation (i.e., background quality), while groundwater samples from the downgradient well establish (by comparison with upgradient samples) the impact of disposal operations on groundwater quality.

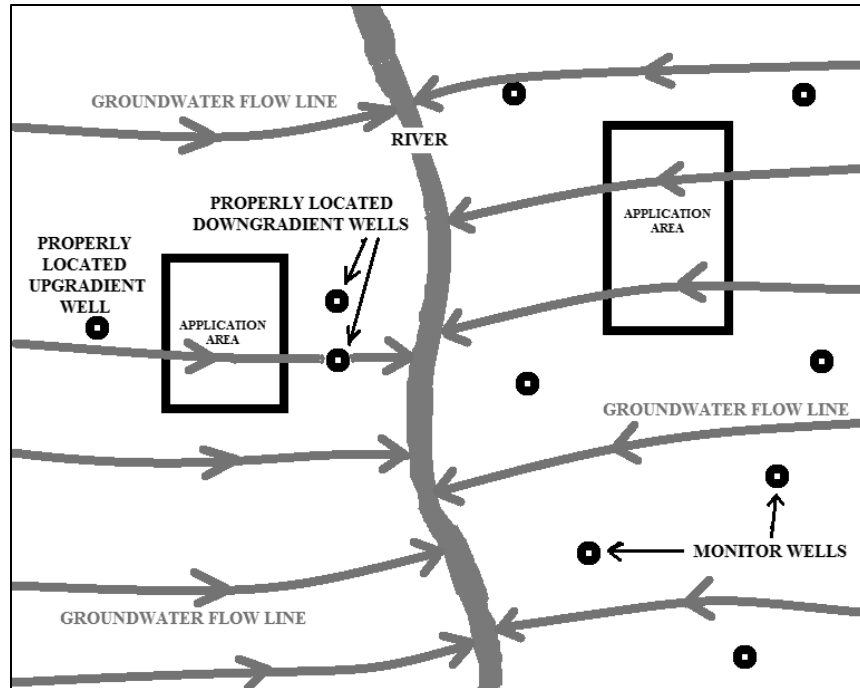

Figure 8-1. Proper well placement.

Monitoring wells must be located at the Review Boundary (Figure 8-2). The Review Boundary is the boundary around the disposal system, midway between the waste disposal boundary and the Compliance Boundary. Monitoring at the Review Boundary serves as a warning of the possible spread of contamination to the Compliance Boundary.

Exceedance of Groundwater Quality Standards at the Review Boundary requires the permittee to implement a plan that will prevent a violation of standards at the Compliance Boundary. This plan must include installation of monitoring wells at the Compliance Boundary.

The Compliance Boundary is a boundary around the disposal system at and beyond which groundwater quality standards may not be exceeded. It is established at either 250 feet from the waste disposal area or 50 feet within the property boundary, whichever is closest to the waste disposal area. Exceedance of Groundwater Quality Standards at or beyond the Compliance Boundary is subject to immediate remediation action in addition to the penalty provisions applicable under General Statute 143-25.6A(a)(1).

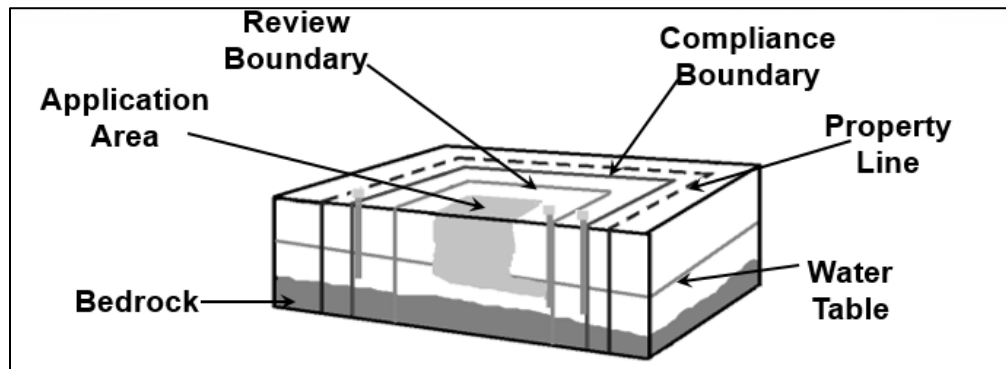
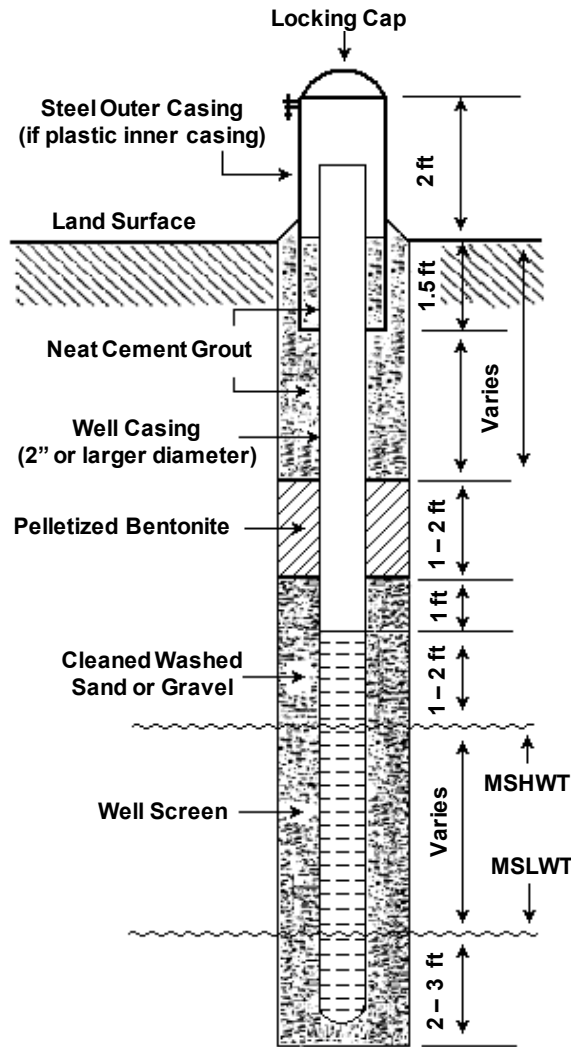

Figure 8-2. Compliance and review boundaries where North Carolina Groundwater Standards apply.

## Well Construction

Along with proper location, proper well construction is critical to a valid and acceptable monitoring network. The construction requirements are specified in 15A NCAC 2C.0108(c)(1)(A-K). Some of the most important requirements include:

- The well casing and screen must be made of materials compatible with the constituents of the waste being monitored. Poly-vinyl chloride (PVC) is generally a good choice because of its ease of handling and low cost. However, the pieces of casing and screen must be joined using threaded couplings. **Glues of any sort cannot be used** since volatile/semi-volatile elements in glues will leach into the groundwater.
- The well casing must be grouted from the land surface to a depth no more than three feet above the top of the well screen. Because of shrinkage when dry, bentonite grouts may not be used except as a plug to keep cement grout away from the well screen (Figure 8-3).
- The length and positioning of the well screen below land surface must be such that the static water table is never above or below the uppermost and lowermost screen openings, respectively, at any time of the year (Figure 8-4). Screen settings that do not meet this criteria result in either “dry” wells (i.e., the water table is below the screen, precluding collection of a sample) or a situation where the layer of dissolved contaminants in the groundwater may be above the zone where the sample is collected (i.e., the water table is above the uppermost screen openings).
- A permanent, easily visible label or tag must be attached to each well denoting that the well is for monitoring and thus water from the well should not be used for drinking. There should also be a permanent label containing details about the construction of the well (date installed, installer, depth, etc.).
- The well must have a watertight lockable cap to prevent unauthorized access.



1. Borehole to be at least 4 inches larger than outside diameter of casing.
2. Casing and screen to be centered in borehole.
3. Top of well screen should extend from approx. 1 – 2 feet above MSHWT down to 2 – 3 feet below MSLWT.
4. Casing and screen material to be compatible with type of contaminant being monitored.
5. Well head to be labeled with visible warning saying: "Well for monitoring and not considered safe for drinking".
6. Well to be afforded reasonable protection against damage after construction.

Note:

**MSHWT = Mean Seasonal High Water Table**

**MSLWT = Mean Seasonal Low Water Table**

Figure 8-3. Construction details for groundwater monitoring well.

## Baseline Well Characteristics

Since the purpose of installing monitoring wells is to determine the condition of groundwater based on the analyses of groundwater samples, it is essential that good quality samples be obtained. Prior to accepting a newly installed monitoring well, permittees should verify that the well has been properly developed. Suspended particles and sediment in groundwater samples due to improper well development interfere with some chemical analyses and can lead to compliance problems and additional financial outlays.

All wells should be sampled initially after construction and prior to waste disposal activities to establish a valid background concentration for constituents requiring routine monitoring. Thereafter monitoring frequency will be determined by the schedule specified in the non-discharge permit.

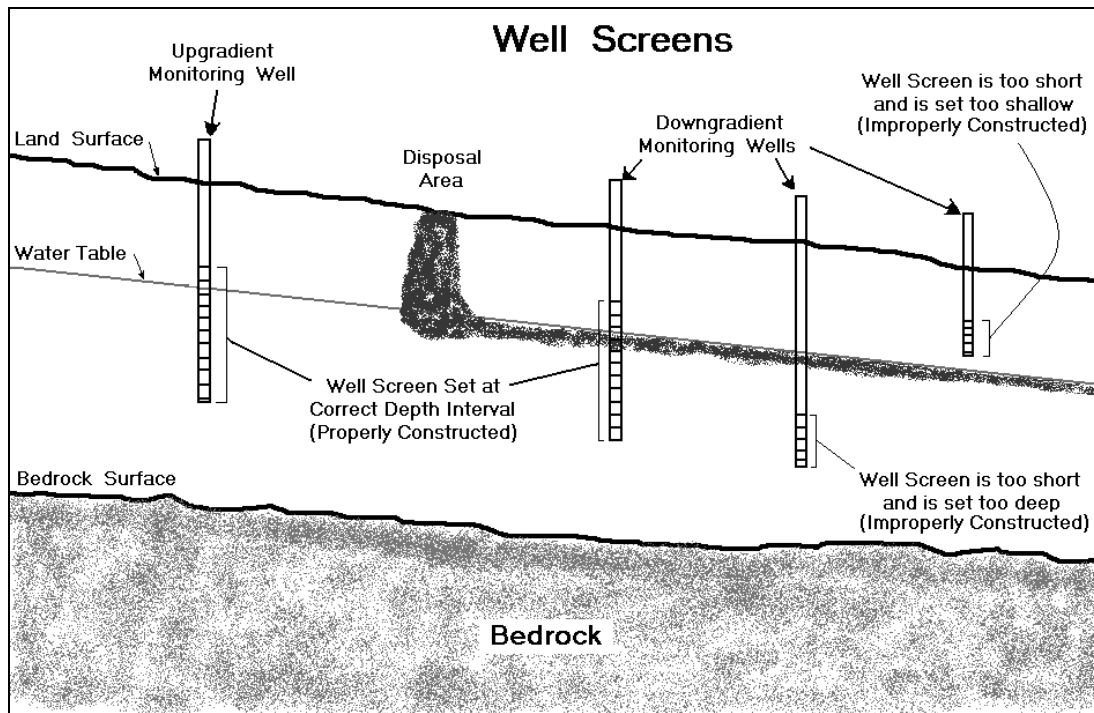

Figure 8-4. Proper and improper placement of screens in monitoring wells.

## Well Maintenance

Monitoring wells require regular maintenance, which includes making sure that:

- caps are rust-free and always locked
- the outer casing is upright and undamaged
- a clear, unobstructed path exists leading to each well

While the primary function of groundwater monitoring is to ensure compliance with the groundwater rules, it can also serve other important functions. For example, interpretation of the water level information may reveal that the system is being hydraulically overloaded. Therefore, more land may be needed to accommodate the design capacity of the system or monitoring may indicate that the ability of the crop cover to uptake nutrients is more limited than anticipated.

## Reporting Requirements

As mentioned earlier, groundwater monitoring data must be reported using the Groundwater Quality Monitoring Form for Permitted Facilities (Form GW-59) and the Compliance Report Form (Form GW-59a). Copies of these forms are in Appendix C-4.

This form must be printed or photocopied on yellow paper. A separate GW-59 form must be completed for each monitoring well according to the schedule set out in the system permit. Unless the permit specifies another address, the GW-59 should be submitted to the address



printed on the form. A copy of a GW-59 is shown in Figure 8-5. Include the complete and correct Non-Discharge permit number from the permit in effect at the time of sampling. Also identify the type of permitted system being monitored by checking the appropriate category.

Be consistent in reporting well location and identification numbers and designate each well as upgradient or downgradient in relation to the waste disposal site. Identify wells using the identification numbers designated in the current Non-Discharge permit.

To minimize confusion, make sure that wells covered under the same permit do not have the same identification numbers.

The field measurements and analyses required provide information about the conditions under which samples were taken. This information is also used to establish that a representative sample was taken and to detect signs of sample deterioration or contamination when compared with the laboratory analyses.

To ensure that sample holding times have not been exceeded, sample collection and analyses dates must be recorded. The name and certification number of the North Carolina certified laboratory that collected and/or analyzed samples must be recorded in the designated area.

The Laboratory Information section lists the groundwater parameters commonly monitored at permitted facilities. Since the bulk of analytical compliance information is recorded in this section, the following areas require special attention:

- Permittees must refer to individual permits to ensure that all required parameters applicable to their operation are being monitored.
- Analytical data must be properly recorded in the correct spaces and in the correct units. If uncertain of the concentration units of constituents included in a laboratory report, consult with the laboratory before filling out form GW-59. Constituents reported as “not detected” or “below detection limit” should indicate the detection limit used. For example, “Not Detected” or “Below Detection Limit” at a detection limit of .001mg/L should be recorded on the form as “<.001mg/L” or “less than .001mg/L”.
- Parameters listed on the form should not be crossed out and unlisted parameters inserted. If a required parameter is not listed, record it in the space marked “other”.
- When organic analyses, such as Volatile Organic Compounds (VOC’s), are required the laboratory reports must be attached to the GW-59 and “Yes” must be checked to indicate that the forms are attached.
- Based on detection of contaminants in the initial samples, follow-up analyses may be required. In such cases, the follow-up analyses must be performed immediately after initial detection and all results must be submitted simultaneously.

SUBMIT FORM ON YELLOW PAPER ONLY

<b>GROUNDWATER QUALITY MONITORING: COMPLIANCE REPORT FORM</b>		<b>Mail original and 1 copy to:</b>	DEPARTMENT OF ENVIRONMENT & NATURAL RESOURCES DIVISION OF WATER QUALITY INFORMATION PROCESSING UNIT 1617 MAIL SERVICE CENTER, RALEIGH, NC 27699-1617 Phone: (919) 733-3221
<b>FACILITY INFORMATION</b> <i>Please Print Clearly or Type</i>		<b>PERMIT INFORMATION</b>	
Facility Name: _____		PERMIT Number: _____ Expiration Date: _____	
Permit Name (if different): _____		Non-Discharge _____ UIC _____	
Facility Address: _____		NPDES _____ Other _____	
_____ _____ _____ County _____		<b>TYPE OF PERMITTED OPERATION BEING MONITORED</b>	
Contact Person: _____ Telephone#: _____		<input type="checkbox"/> Lagoon <input type="checkbox"/> Remediation: Infiltration Gallery	
Well Location/Site Name: _____ No. of wells to be sampled: _____		<input type="checkbox"/> Spray Field <input type="checkbox"/> Remediation: _____	
		<input type="checkbox"/> Rotary Distributor <input type="checkbox"/> Land Application of Sludge	
		<input type="checkbox"/> Water Source Heat Pump <input type="checkbox"/> Other: _____	
<b>SAMPLING INFORMATION</b>		<b>FIELD ANALYSES:</b>	
WELL ID NUMBER (from Permit): _____ Date sample collected: _____		pH _____ units Temp. _____ °C	
Well Depth: _____ ft. Well Diameter: _____ in.		Spec. Cond. _____ µMhos	
Depth to Water Level: _____ ft. below measuring point		Odor _____	
Measuring Point is _____ ft. above land surface		Appearance _____	
Volume of water pumped/bailed before sampling: _____ gallons			
Samples for metals were collected unfiltered: <input type="checkbox"/> YES <input type="checkbox"/> NO and field acidified: <input type="checkbox"/> YES <input type="checkbox"/> NO			
<b>LABORATORY INFORMATION</b>		<b>if WELL WAS DRY at time of sampling, check here:</b> <input type="checkbox"/>	
Date sample analyzed: _____ Laboratory Name: _____ Certification No. _____			
<b>PARAMETERS</b> NOTE: Values should reflect dissolved and colloidal concentrations.			
COD _____ mg/l		Nitrite (NO <sub>2</sub> ) as N _____ mg/l	
Coliform: MF Fecal _____ /100ml		Nitrate (NO <sub>3</sub> ) as N _____ mg/l	
Coliform: MF Total _____ /100ml <small>(note: Use MPN method for highly turbid samples)</small>		Phosphorus: Total as P _____ mg/l	
Dissolved Solids: Total _____ mg/l		Orthophosphate _____ mg/l	
pH (when analyzed) _____ units		Al - Aluminum _____ mg/l	
TOC _____ mg/l		Ba - Barium _____ mg/l	
Chloride _____ mg/l		Ca - Calcium _____ mg/l	
Arsenic _____ mg/l		Cd - Cadmium _____ mg/l	
Grease and Oils _____ mg/l		Chromium: Total _____ mg/l	
Phenol _____ mg/l		Cu - Copper _____ mg/l	
Sulfate _____ mg/l		Fe - Iron _____ mg/l	
Specific Conductance _____ µMhos		Hg - Mercury _____ mg/l	
Total Ammonia _____ mg/l <small>(Ammonia Nitrogen, NH<sub>3</sub> as N, Ammonia Nitrogen, Total)</small>		K - Potassium _____ mg/l	
TKN as N _____ mg/l		Mg - Magnesium _____ mg/l	
		Mn - Manganese _____ mg/l	
		Ni - Nickel _____ mg/l	
		Pb - Lead _____ mg/l	
		Zn - Zinc _____ mg/l	
		Other (Specify Compounds and Concentration Units): _____ _____ _____	
		<b>ORGANICS:</b> (by GC, GC/MS, HPLC) (Specify test and method #, ATTACH LAB REPORT.)	
		Report Attached? <input type="checkbox"/> Yes (1) <input type="checkbox"/> No (0)	
		VOC _____, method # _____	
		_____ , method # _____	
		_____ , method # _____	
		_____ , method # _____	
For Remediation Systems Only (Attach Lab Reports): Influent Total VOCs: _____ mg/L Effluent Total VOCs: _____ mg/L VOC Removal% _____			
I certify that, to the best of my knowledge and belief, the information submitted in this report is true, accurate, and complete, and that the laboratory analytical data was produced using approved methods of analysis by a DWQ-certified laboratory. I am aware that there are significant penalties for submitting false information, including the possibility of fines and imprisonment for knowing violations.			
Permittee (or Authorized Agent) Name and Title - Please print or type _____		Signature of Permittee (or Authorized Agent) _____	
GW-59 Rev. 1/2007		(Date) _____	

Figure 8-3. Groundwater Quality Monitoring: Compliance Report Form (Form GW-59).

The permittee's or authorized agent's (ORC's) name, signature and date must be provided. Remember to include complete identification (facility name, county, permit number, etc.) on all forms and correspondence. Submit in accordance with the sampling schedule established in the permit. Completed forms must be submitted to:

Division of Water Resources  
 ATTN: Information Processing Unit  
 1617 Mail Service Center  
 Raleigh, N.C. 27699-1617  
 Phone: 919-733-3221

## *8.4 Operator Regulations and Requirements: 15A NCAC 8G*

In North Carolina, all systems that use surface irrigation for the reuse or disposal of wastewater are subject to classification as surface irrigation systems. All classified surface irrigation systems must be operated by certified surface irrigation system operators. The rules that govern the actions of certified operators, 15A NCAC 8G, are in Appendix C-5.

The operator must understand the permittee's legal responsibilities and keep the permittee informed concerning the daily operation of the system. If any problems occur with operations, equipment, etc., the operator must notify the permittee so decisions can be made, and problems can be corrected.

### Water Pollution Control System Operators Certification Commission

The regulating body responsible for the classification of surface irrigation systems is the Water Pollution Control System Operators Certification Commission. The Certification Commission is also responsible for the classification of other water pollution control systems, such as biological water pollution control systems, collection systems, physical/chemical systems, land application of residuals systems, subsurface systems, and animal waste management systems.

In addition to the classification of systems, the Certification Commission is also responsible for the certification of water pollution control system operators and, if warranted, for taking disciplinary actions against certified operators.

The Certification Commission has 11 members. Two members represent the animal agriculture industry and are appointed by the Commissioner of Agriculture. The remaining 9 members are appointed by the Secretary of Environmental Quality and represent other areas of the water pollution control system industry.

The Commission is in the Department of Environmental Quality and is assisted by Division of Water Resources Staff.

### Classification of Surface Irrigation Systems

Systems that use surface irrigation for the reuse or disposal of wastewater are subject to classification by the Certification Commission as surface irrigation systems. Classified systems are required to have one Operator in Responsible Charge (ORC) and one or more back-up operators who hold active surface irrigation system operator certifications.

Those systems that contain only preliminary treatment processes such as septic tanks, media filters, oil/water separators, lagoons, storage basins, physical screening, or sedimentation

processes are classified as surface irrigation systems only. A surface irrigation system that has, as a part of its treatment process, treatment components other than those specified above is subject to dual classification as either a grade 2, 3, or 4 biological water pollution control system **and** as a surface irrigation system.

Once a system is classified as a surface irrigation system, it is the responsibility of the permittee to designate an Operator in Responsible Charge. One or more back-up(s) must also be designated. To be designated, the ORC and back-up(s) must hold currently valid surface irrigation system operator certificates.

If a system is classified as both a surface irrigation system and a biological water pollution control system, the permittee must designate an ORC who holds a biological water pollution control system certificate (of the same grade as the classification of the system) as well as a surface irrigation system operator certificate. The designated back-up must hold a biological water pollution control system operators certificate no more than one grade lower than the classification of the system as well as a surface irrigation system operator certificate.

The owner must submit a completed designation form:

- 60 calendar days prior to wastewater being introduced into a new system or
- within 120 calendar days following:
  - receiving notification of a change in the classification of the system requiring the designation of a new Operator in Responsible Charge (ORC) and Back-up Operator in Responsible Charge (Back-up ORC) of the proper type; or
  - a vacancy in the position of Operator in Responsible Charge (ORC) or Back-up Operator in Responsible Charge (Back-up ORC); or
- within seven calendar days of vacancies in both ORC and Back-up ORC positions, replacing or designating at least one of the responsibilities.

An ORC designation form is included in Appendix C-5.

## Certification of Surface Irrigation System Operators

To become certified as a surface irrigation system operator, you must complete an approved training program, meet the examination eligibility requirements for the certification examination and pass the examination. Applications for examinations must be postmarked 30 days prior to the desired examination date. Examinations will be given only to those applicants that have been approved by the staff of the Certification Commission. A passing examination score is 70% or higher.

To take the examination for certification as a surface irrigation system operator, you must meet

all the following eligibility requirements:

- have a high school diploma or a general educational development equivalent (GED)
- be at least 18 years of age
- have a general knowledge of typical wastewater characteristics and treatment processes
- be able to:
  - read and understand the statutes and rules that govern surface irrigation systems
  - perform mathematical calculations required to operate these systems
  - complete and maintain logs and regulatory reporting forms required to document the proper operation of these systems
  - describe general maintenance requirements for the equipment employed in the operation of these systems
- have successfully completed an approved surface irrigation system operator training school

In addition, you must have one of the following:

- one year of actual experience in surface irrigation operation; or
- a two or four year college degree with a minimum of six courses in the basic sciences; or
- a valid grade 2 or higher Biological Wastewater operator certification.

If you fail to achieve a passing score on the certification examination after three consecutive attempts, you must satisfactorily complete another approved surface irrigation system operator training school before you will be approved to sit for the examination again.

### *Responsibilities of Certified Operators*

Once you are certified, you must fulfill certain responsibilities to maintain your certification (regardless of whether or not you are designated as an ORC or backup):

- notify the Certification Commission in writing within 30 days of a change of address
- pay an annual renewal fee
- complete six contact hours of approved continuing education training annually
- comply with all terms and conditions of your certification and with all statutes and rules regarding the operation of water pollution control systems

### *Responsibilities of Operators in Responsible Charge*

If you are designated as the ORC of a surface irrigation system, you must:

- possess a currently valid surface irrigation system operator certificate
- visit the system as often as necessary to ensure the proper operation of the system, but in no case less than weekly (with the exception of domestic wastewater systems with a treatment capacity of 1,500 gallons per day or less, in which case visitation will be twice per year with a six-month interval between visits)

- operate and maintain the system efficiently and attempt to ensure compliance with the permit and all applicable local, state, and federal requirements
- certify, by signature, the validity of all monitoring and reporting information performed on the system as required by the permit, and provide the owner a copy
- document the operation, maintenance, and all visitation of the system in a daily log that must be maintained at the system
- notify the owner of the system within 24 hours and in writing within five days of first knowledge, of any:
  - overflows from the system or any treatment process unit
  - bypasses of the system or any treatment process unit
  - violations of any limits or conditions of the permit
- notify the owner, in writing, of the need for any system repairs and modifications that may be necessary to ensure the compliance of the system
- be available:
  - for consultations with the system owner and regulatory officials
  - to handle emergency situations
  - to provide access to the facility by regulatory agencies
- upon vacating an ORC position, notify the Commission and the appropriate DWR regional office of the vacancy, in writing within 14 calendar days.

As ORC, you must have a detailed working knowledge of the surface irrigation permit to ensure the facility is not in violation of any permit conditions or state regulations. A copy of the surface irrigation permit, and a copy of the approved blueprint plans should be kept on site. Also, phone numbers of DWR contacts and the design engineer for the system should be handy if a question should arise.

### *Responsibilities of Backup Operators*

A designated back-up may act as a surrogate for the ORC for a period not to exceed 40 percent of the system visitation required per calendar year. If the ORC is absent due to a vacancy in the ORC position or due to personal or familial illness, the back-up may act as surrogate for the ORC for up to 120 consecutive days.

When acting as the ORC, a designated back-up ORC must fulfill all the requirements of the ORC listed above.

### *Responsibilities of Contract Operators*

Any operator or operations firm that enters into a contractual agreement with the owner of a surface irrigation system to operate the system must notify the owner within 5 calendar days of:

- any change in the designation of the ORC or back-up ORC(s); or
- becoming aware of any situation, which may interfere with the proper operation of the system and necessitate corrective action by the owner.

### **Disciplinary Actions Against Certified Operators**

The enforcement actions described above are actions that DWR can take against the permit holder. It is the permittee's responsibility to ensure that the system is properly operated, properly maintained, and is in compliance with permit conditions. Ultimately, it is the permittee who is responsible for any violation of a permit condition, regardless of who is actually operating the system.

However, this doesn't mean that certified operators aren't accountable for their actions. When it appears that operator misconduct or negligence have contributed to noncompliance, an inspector can request that the operator attend an informal "show cause" meeting at the DWR regional office. During this fact-finding meeting, the inspector presents the operator with the observed or perceived problems. The operator then has an opportunity to answer or explain the allegations.

If the regional office staff is satisfied with the outcome of the meeting, there may be no further action. However, if staff remain concerned about the operator's conduct, they may refer the matter to the WPCSOCC with a recommendation for disciplinary action.

- ❑ **Disciplinary Action by the WPCSOCC.** The WPCSOCC can take disciplinary action against a certified operator based on one or more of the following grounds:
- Failure to use reasonable care or judgment in the performance of duties.
  - Failure to apply their knowledge or ability in the performance of duties.
  - Incompetence or the inability to perform duties.
  - Practicing fraud or deception.

When presented with a case of alleged operator negligence, incompetence, or deceit, a disciplinary committee is convened. The committee is made up of several WPCSOCC members and a certified operator who holds the same type of certificate as the operator involved in the case. After hearing from both the regional office staff and the operator, the committee must determine if disciplinary action is warranted. It can take one of three actions:

- Issue a letter of reprimand to the operator.
- Suspend the operator's certificate(s).
- Permanently revoke the operator's certificate(s).

If a certification is revoked, an operator must wait two years after revocation before petitioning the Commission for any new certification. The WPCSOCC will only consider certification if there is substantial evidence that the conditions leading to the revocation have been corrected.

If the WPCSOCC determines the operator is eligible for a new certification, the operator will be required to take and pass another examination for certification. All examination eligibility requirements must be met. Operational experience accrued prior to the revocation of any previously held certification(s) cannot be used to meet examination eligibility requirements.

Taking disciplinary action against a certified operator is an unpleasant task. Members of the WPCSOCC consider each case seriously, thoroughly, and fairly. They know what it takes to get certified and understand that an operator's livelihood often depends on staying certified. It is their sincere hope that all certified operators view their certificates with a sense of pride and professional ethics. However, their primary duty is to prevent harm to human health and the environment.

- ☐ ***Criminal Penalties.*** DWR can refer certified operators as well as permittees to the SBI and FBI if they are suspected of environmental crimes. Remember, environmental crimes are willful and knowing violations. They are deliberate acts that are not the product of an accident or mistake. Like permittees, operators can be prosecuted by the state or federal government and be fined and/or sentenced to probation or prison.

## Permit Holder Responsibilities Versus Operator Responsibilities

Where do the responsibilities of a permit holder and a certified operator begin and end? The bottom line is:

- The owner must provide the resources necessary for the operator to do his or her job and must allow the operator to do that job as required by 15A NCAC 8G (Operator Rules).
- The operator must make reasonable efforts to secure the resources needed to properly operate and maintain the system and must attempt ensure compliance with the owner's permit.

As an operator, you can't force a permit holder to spend money on maintenance or repairs. You can't force a permit holder to hire enough staff to properly operate and maintain the system. But,



as it says above, you must make reasonable efforts to get what you need to do your job and comply with the permit and regulations as best you can under the circumstances.

This is one of several reasons why documentation and good record keeping are essential. Your logbook is your friend. Accurate, detailed, and timely entries can demonstrate to an inspector that you are doing your best to maintain a high level of operations. Keep copies of emails, memos, or other communication with the owner. Written communication is necessary to show that you have reported to the owner any actions needed to prevent or eliminate a violation as well as any conditions that may cause or are causing a violation.

## Consider the Risks

You may find yourself being pressured by an employer or Permittee not to keep such thorough records, to falsify them, or in some other way to jeopardize your certificate(s). Even with no outside pressure, you may find yourself tempted to take questionable shortcuts or unethical actions to save yourself from a difficult situation. But remember, the penalties for misconduct or environmental crimes can be harsh.

### Consider the Risks

Being expected to perform actions that are illegal or unethical is usually a no-win situation. If we refuse, we get fired and possibly "black-listed" as "troublemakers" or "not team players." If we go along and do what we are told to do, we risk not only the bad conscience of doing harm but the very real consequences of getting blamed if the illegal acts are discovered. That usually results in loss of career or employment, and in some cases personal legal liability.

The WPCSOCC wants you to be a proud front-line environmental professional, playing a key role in protecting and preserving the public health and environment of North Carolina. By managing residuals responsibly and conscientiously, you will advance the practice of beneficial reuse and contribute to its economic sustainability and to your continued livelihood.

## Other Regulations

In addition to state and federal regulations, there may be local regulations that apply to surface irrigation systems. Generally, local regulations deal with the zoning or location of surface irrigation systems rather than the actual operation of these facilities. It is beyond the scope of

this manual to review local regulations and the legal issues pertinent to them.

Owners and operators of surface irrigation systems should research the pertinent local regulations to make sure they are in compliance with these, if any. Information on such regulations should be available from the county planning and zoning office, the county manager's office, or the local county health department.

Permittees of surface irrigation systems are also subject to third-party lawsuits. A third-party lawsuit is a lawsuit brought by a person who is not responsible for enforcing a regulation. An example could be a lawsuit brought by a neighbor, as opposed to a lawsuit brought by a local, state, or federal government agency.

Third-party lawsuits are becoming more and more commonplace as subdivisions move into more rural settings. The best way to avoid such lawsuits is to keep accurate, detailed records and properly operate and maintain your surface irrigation system at all times.



